

INA310x –4 V to 110 V, 1.3 MHz, Ultra-Precise Current Sense Amplifier With Open-Drain Comparator and Reference

1 Features

- Wide common-mode voltage:
 - Operational voltage: –4 V to +110 V
 - Survival voltage: –20 V to +120 V
- High signal bandwidth: 1.3 MHz
- Slew rate: 2.5 V/μs
- Excellent CMRR: 160 dB
- Accuracy
 - Gain error (maximum)
 - Version A: 0.15%, 10 ppm/°C drift
 - Version B: 0.5%, 20 ppm/°C drift
 - Offset voltage (maximum)
 - Version A: ±20 μV, ±0.25 μV/°C drift
 - Version B: ±150 μV, ±1 μV/°C drift
- On-board open-drain comparator
- Internal comparator voltage reference: 0.6 V
- Propagation delay time: 1 μs
- Latching capability on comparator
- Available gains:
 - INA310A1, INA310B1 : 20 V/V
 - INA310A2, INA310B2 : 50 V/V
 - INA310A3, INA310B3 : 100 V/V
 - INA310A4, INA310B4 : 200 V/V
 - INA310A5, INA310B5 : 500 V/V
- Package options: VSSOP-8

2 Applications

- [48 V DC/DC converter](#)
- [48 V battery management systems \(BMS\)](#)
- [Test and measurement](#)
- [Macro remote radio unit \(RRU\)](#)
- [48 V rack server](#)
- [48 V merchant network & server power supply \(PSU\)](#)
- [Solenoids and actuators](#)

3 Description

The INA310x is an ultra-precise current sense amplifier that can measure voltage drops across shunt resistors over a wide common-mode range from –4 V to 110 V, independent of supply voltage with an integrated comparator. The high precision current measurement accuracy is achieved through a combination of low offset voltage (20 μV, maximum), small gain error (0.15%, maximum) and a high DC CMRR (160 dB, typical). The INA310x has a high signal bandwidth of 1.3 MHz designed for high voltage DC current measurements and high-speed applications like fast overcurrent protection.

The INA310x incorporates an open-drain comparator and internal reference that provides a 0.6 V threshold. An external resistive divider sets the current trip point. The comparator includes a latching capability that can be made transparent by grounding (or leaving open) the $\overline{\text{RESET}}$ pin.

The INA310x operates from a single 2.7 V to 20 V supply and draws 1.6 mA of supply current. The INA310x is available in five gain options: 20 V/V, 50 V/V, 100 V/V, 200 V/V, and 500 V/V. These gain options address a wide dynamic range of current-sensing applications.

The INA310x is specified over an operating temperature range of –40°C to +125°C and is offered in a space-saving 8-pin VSSOP package.

Package Information⁽¹⁾

PART NUMBER	PACKAGE	BODY SIZE (NOM)
INA310A	VSSOP (8)	3.00 mm × 3.00 mm
INA310B		

- (1) For all available packages, see the package option addendum at the end of the data sheet.

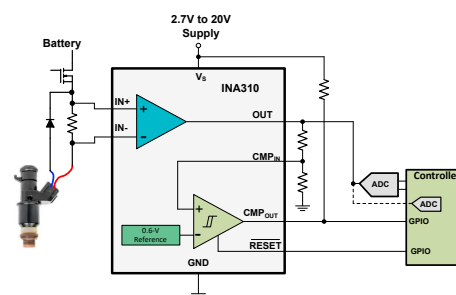

Typical Application



Table of Contents

1 Features	1	7.3 Feature Description.....	14
2 Applications	1	7.4 Device Functional Modes.....	17
3 Description	1	8 Application and Implementation	20
4 Revision History	2	8.1 Application Information.....	20
5 Pin Configuration and Functions	3	8.2 Typical Application.....	21
6 Specifications	4	8.3 Power Supply Recommendations.....	24
6.1 Absolute Maximum Ratings.....	4	8.4 Layout.....	25
6.2 ESD Ratings.....	4	9 Device and Documentation Support	26
6.3 Recommended Operating Conditions.....	4	9.1 Receiving Notification of Documentation Updates....	26
6.4 Thermal Information.....	4	9.2 Support Resources.....	26
6.5 Electrical Characteristics.....	5	9.3 Trademarks.....	26
6.6 Typical Characteristics.....	7	9.4 Electrostatic Discharge Caution.....	26
7 Detailed Description	14	9.5 Glossary.....	26
7.1 Overview.....	14	10 Mechanical, Packaging, and Orderable Information	26
7.2 Functional Block Diagram.....	14		

4 Revision History

DATE	REVISION	NOTES
March 2023	*	Initial release

5 Pin Configuration and Functions

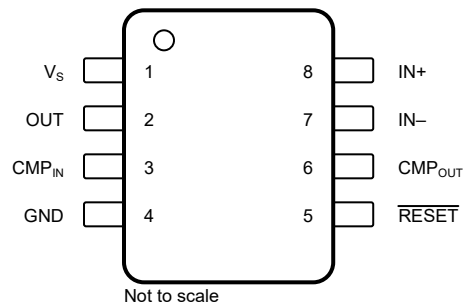

Figure 5-1. INA310x: DGK Package 8-Pin VSSOP Top View

Table 5-1. Pin Functions

PIN		TYPE	DESCRIPTION
NAME	NO		
V _S	1	Power	Power supply, 2.7 V to 20 V
OUT	2	Output	Output voltage
CMP _{IN}	3	Input	Comparator input
GND	4	Ground	Ground
$\overline{\text{RESET}}$	5	Input	Comparator reset pin, active low (Low: Transparent Mode, High: Latch Mode)
CMP _{OUT}	6	Output	Comparator output (latch high when $\overline{\text{RESET}}$ = High)
IN ₋	7	Input	Shunt resistor negative sense input. For high-side applications, connect to load side of sense resistor. For low-side applications, connect to ground side of sense resistor.
IN ₊	8	Input	Shunt resistor positive sense input. For high-side applications, connect to bus-voltage side of sense resistor. For low-side applications, connect to load side of sense resistor.

6 Specifications

6.1 Absolute Maximum Ratings

over operating free-air temperature range (unless otherwise noted)⁽¹⁾

		MIN	MAX	UNIT	
V _S	Supply voltage	-0.3	22	V	
V _{IN+} , V _{IN-}	Analog inputs	Differential (V _{IN+}) – (V _{IN-}) ⁽²⁾	-12	12	V
		V _{IN+} , V _{IN-} , with respect to GND ⁽²⁾	-20	120	
V _{OUT}	Analog output	GND – 0.3	(V _S) + 0.3	V	
	Comparator reset pin	GND – 0.3	(V _S) + 0.3	V	
	Comparator analog input	GND – 0.3	MIN of 5.5 or V _S	V	
	Comparator Output	GND – 0.3	22	V	
	Input current into any pin		5	mA	
T _A	Operating temperature	-55	150	°C	
T _J	Junction temperature	-65	150	°C	
T _{stg}	Storage temperature	-65	150	°C	

- (1) Operation outside the Absolute Maximum Ratings may cause permanent device damage. Absolute Maximum Ratings do not imply functional operation of the device at these or any other conditions beyond those listed under Recommended Operating Conditions. If used outside the Recommended Operating Conditions but within the Absolute Maximum Ratings, the device may not be fully functional, and this may affect device reliability, functionality, performance, and shorten the device lifetime.
- (2) V_{IN+} and V_{IN-} are the voltages at the IN+ and IN- pins, respectively.

6.2 ESD Ratings

			VALUE	UNIT
V _(ESD)	Electrostatic discharge	Human body model (HBM), per ANSI/ESDA/ JEDEC JS-001, all pins ⁽¹⁾	±2000	V
		Charged device model (CDM), per ANSI/ESDA/JEDEC JS-002, all pins ⁽²⁾	±1000	

- (1) JEDEC document JEP155 states that 500-V HBM allows safe manufacturing with a standard ESD control process.
- (2) JEDEC document JEP157 states that 250-V CDM allows safe manufacturing with a standard ESD control process.

6.3 Recommended Operating Conditions

over operating free-air temperature range (unless otherwise noted)

		MIN	NOM	MAX	UNIT
V _{CM}	Common-mode input range	-4	48	110	V
V _S	Operating supply voltage	2.7	5	20	V
V _{SENSE}	Differential sense input range	0		V _S / G	V
T _A	Operating free-air temperature	-40		125	°C

6.4 Thermal Information

THERMAL METRIC ⁽¹⁾		INA310x	UNIT
		DGK (VSSOP)	
		8 PINS	
R _{θJA}	Junction-to-ambient thermal resistance	172.2	°C/W
R _{θJC(top)}	Junction-to-case (top) thermal resistance	63.5	°C/W
R _{θJB}	Junction-to-board thermal resistance	93.8	°C/W
Ψ _{JT}	Junction-to-top characterization parameter	9.8	°C/W
Ψ _{JB}	Junction-to-board characterization parameter	92.2	°C/W

- (1) For more information about traditional and new thermal metrics, see the [Semiconductor and IC Package Thermal Metrics](#) application report.

6.5 Electrical Characteristics

at $T_A = 25^\circ\text{C}$, $V_{\text{SENSE}} = V_{\text{IN}+} - V_{\text{IN}-} = 0.5\text{ V} / \text{Gain}$, $V_S = 5.0\text{ V}$, $V_{\text{CM}} = V_{\text{IN}-} = 48\text{ V}$, and $R_{\text{PULLUP}} = 5.1\text{ k}\Omega$ connected from CMP_{out} to V_S , (unless otherwise noted)

PARAMETER		CONDITIONS	MIN	TYP	MAX	UNIT
INPUT						
V_{CM}	Common-mode input range	$T_A = -40^\circ\text{C}$ to $+125^\circ\text{C}$	-4		110	V
CMRR	Common-mode rejection ratio	INA310Ax, $V_{\text{IN}+} = -4\text{ V}$ to 110 V , $T_A = -40^\circ\text{C}$ to $+125^\circ\text{C}$	140	160		dB
		INA310Ax, $f = 50\text{ kHz}$		85		
		INA310Bx, $V_{\text{IN}+} = -4\text{ V}$ to 110 V , $T_A = -40^\circ\text{C}$ to $+125^\circ\text{C}$	120	140		
		INA310Bx, $f = 50\text{ kHz}$		65		
V_{OS}	Offset voltage, RTI ⁽¹⁾	INA310A1		± 30	± 150	μV
		INA310B1		± 100	± 500	
		INA310A2		± 15	± 80	
		INA310B2		± 55	± 300	
		INA310A3		± 10	± 50	
		INA310B3		± 30	± 250	
		INA310A4		± 5	± 30	
		INA310B4		± 30	± 200	
		INA310A5		± 2	± 20	
dV_{OS}/dT	Offset drift, RTI	$T_A = -40^\circ\text{C}$ to $+125^\circ\text{C}$, INA310A1, INA310A2, INA310A3		± 0.05	± 0.5	$\mu\text{V}/^\circ\text{C}$
		$T_A = -40^\circ\text{C}$ to $+125^\circ\text{C}$, INA310A4, INA310A5		± 0.025	± 0.25	
		$T_A = -40^\circ\text{C}$ to $+125^\circ\text{C}$, INA310Bx		± 0.1	± 1	
PSRR	Power-supply rejection ratio, RTI	INA310A1, $2.7\text{ V} \leq V_S \leq 20\text{ V}$, $T_A = -40^\circ\text{C}$ to $+125^\circ\text{C}$		± 1	± 8	$\mu\text{V}/\text{V}$
		INA310A2, INA310A3, $2.7\text{ V} \leq V_S \leq 20\text{ V}$, $T_A = -40^\circ\text{C}$ to $+125^\circ\text{C}$		± 0.3	± 3	
		INA310A4, INA310A5, $2.7\text{ V} \leq V_S \leq 20\text{ V}$, $T_A = -40^\circ\text{C}$ to $+125^\circ\text{C}$		± 0.1	± 1	
		INA310Bx $2.7\text{ V} \leq V_S \leq 20\text{ V}$, $T_A = -40^\circ\text{C}$ to $+125^\circ\text{C}$		± 1.5	± 10	
I_B	Input bias current	I_{B+} , I_{B-} , $V_{\text{SENSE}} = 0\text{ mV}$	10	20	30	μA
OUTPUT						
G	Gain	INA310A1, INA310B1		20		V/V
		INA310A2, INA310B2		50		
		INA310A3, INA310B3		100		
		INA310A4, INA310B4		200		
		INA310A5, INA310B5		500		
G_{ERR}	Gain error	INA310Ax, $\text{GND} + 50\text{ mV} \leq V_{\text{OUT}} \leq V_S - 200\text{ mV}$		$\pm 0.02\%$	$\pm 0.15\%$	$\text{ppm}/^\circ\text{C}$
		INA310Bx, $\text{GND} + 50\text{ mV} \leq V_{\text{OUT}} \leq V_S - 200\text{ mV}$		$\pm 0.07\%$	$\pm 0.5\%$	
		INA310Ax, $T_A = -40^\circ\text{C}$ to $+125^\circ\text{C}$		1	10	
		INA310Bx, $T_A = -40^\circ\text{C}$ to $+125^\circ\text{C}$		2	20	
NL_{ERR}	Nonlinearity error	$\text{GND} + 50\text{ mV} \leq V_{\text{OUT}} \leq V_S - 200\text{ mV}$		± 0.01		%
	Maximum capacitive load	No sustained oscillation, no isolation resistor		500		pF
VOLTAGE OUTPUT						
V_{SP}	Swing to V_S (Power-supply rail)	$R_{\text{LOAD}} = 10\text{ k}\Omega$ to GND, $T_A = -40^\circ\text{C}$ to $+125^\circ\text{C}$		$(V_S) - 70$	$(V_S) - 150$	mV
V_{SN}	Swing to GND	$R_{\text{LOAD}} = 10\text{ k}\Omega$ to GND, $T_A = -40^\circ\text{C}$ to $+125^\circ\text{C}$, $V_{\text{SENSE}} = 0\text{ mV}$		$(V_{\text{GND}}) + 5$	$(V_{\text{GND}}) + 20$	mV

at $T_A = 25^\circ\text{C}$, $V_{\text{SENSE}} = V_{\text{IN}+} - V_{\text{IN}-} = 0.5\text{ V}$ / Gain, $V_S = 5.0\text{ V}$, $V_{\text{CM}} = V_{\text{IN}-} = 48\text{ V}$, and $R_{\text{PULLUP}} = 5.1\text{ k}\Omega$ connected from CMP_{out} to V_S , (unless otherwise noted)

PARAMETER		CONDITIONS	MIN	TYP	MAX	UNIT
FREQUENCY RESPONSE						
BW	Bandwidth	INA310A1, INA310B1, $C_{\text{LOAD}} = 5\text{ pF}$, $V_{\text{SENSE}} = 200\text{mV}$		1300		kHz
		INA310A2, INA310B2, $C_{\text{LOAD}} = 5\text{ pF}$, $V_{\text{SENSE}} = 80\text{mV}$		1300		
		INA310A3, INA310B3, $C_{\text{LOAD}} = 5\text{ pF}$, $V_{\text{SENSE}} = 40\text{mV}$		1000		
		INA310A4, INA310B4, $C_{\text{LOAD}} = 5\text{ pF}$, $V_{\text{SENSE}} = 20\text{mV}$		900		
		INA310A5, INA310B5, $C_{\text{LOAD}} = 5\text{ pF}$, $V_{\text{SENSE}} = 8\text{mV}$		900		
SR	Slew rate	Rising edge		2.5		V/ μs
t_s	Settling time	$V_{\text{OUT}} = 4\text{ V} \pm 0.1\text{ V}$ step, Output settles to 0.5%		10		μs
		$V_{\text{OUT}} = 4\text{ V} \pm 0.1\text{ V}$ step, Output settles to 1%		5		μs
		$V_{\text{OUT}} = 4\text{ V} \pm 0.1\text{ V}$ step, Output settles to 5%		1		μs
NOISE						
V_{en}	Voltage noise density			50		nV/ $\sqrt{\text{Hz}}$
COMPARATOR						
$V_{\text{THRESHOLD}}$	Alert threshold	$T_A = 25^\circ\text{C}$	585	600	615	mV
		$T_A = -40^\circ\text{C}$ to $+125^\circ\text{C}$	580		620	mV
	Hysteresis	$T_A = 25^\circ\text{C}$		8		mV
t_p	Small-signal propagation delay	Comparator input overdrive = 20 mV		1		μs
	Slew-rate-limited propagation delay	V_{OUT} step = 0.5 V to 4.5 V, $V_{\text{LIMIT}}^{(3)} = 4\text{ V}$		1.6		μs
I_{BCMPIN}	Input bias current, CMP_{in} PIN	$T_A = 25^\circ\text{C}$, $V_{\text{CMPIN}} = 0.4\text{ V}$ to 1.2 V	-20	1	20	nA
		$T_A = -40^\circ\text{C}$ to $+125^\circ\text{C}$, $V_{\text{CMPIN}} = 0.4\text{ V}$ to 1.2 V			250	nA
I_{LKG}	High-level leakage current	$V_{\text{CMPout}} = V_S$			1	μA
V_{OL}	Low-level output voltage	$I_{\text{OL}} = 2.35\text{ mA}$			300	mV
		$T_A = -40^\circ\text{C}$ to $+125^\circ\text{C}$, $I_{\text{OL}} = 2.35\text{ mA}$			350	mV
V_{IH}	RESET High-level input voltage threshold (2)	$T_A = -40^\circ\text{C}$ to $+125^\circ\text{C}$	1.2			V
V_{IL}	RESET Low-level input voltage threshold (2)	$T_A = -40^\circ\text{C}$ to $+125^\circ\text{C}$			0.4	V
	Minimum RESET pulse width	$T_A = -40^\circ\text{C}$ to $+125^\circ\text{C}$		100	200	ns
	RESET propagation delay			250		ns
POWER SUPPLY						
V_S	Supply voltage range	$T_A = -40^\circ\text{C}$ to $+125^\circ\text{C}$	2.7		20	V
I_Q	Quiescent current			1.6	2	mA
		$T_A = -40^\circ\text{C}$ to $+125^\circ\text{C}$			2.25	mA

- (1) RTI = referred-to-input.
- (2) The RESET input has an internal 2 M Ω (typical) pull-down. Leaving RESET open results in a LOW state, with transparent comparator operation.
- (3) V_{LIMIT} is V_{OUT} at the overcurrent threshold set by external resistors.

6.6 Typical Characteristics

at $T_A = 25^\circ\text{C}$, $V_S = 5\text{ V}$, $V_{\text{SENSE}} = V_{\text{IN}+} - V_{\text{IN}-} = 0.5\text{ V} / \text{Gain}$, $V_{\text{CM}} = V_{\text{IN}-} = 48\text{ V}$, and $R_{\text{PULLUP}} = 5.1\text{ k}\Omega$ (unless otherwise noted).

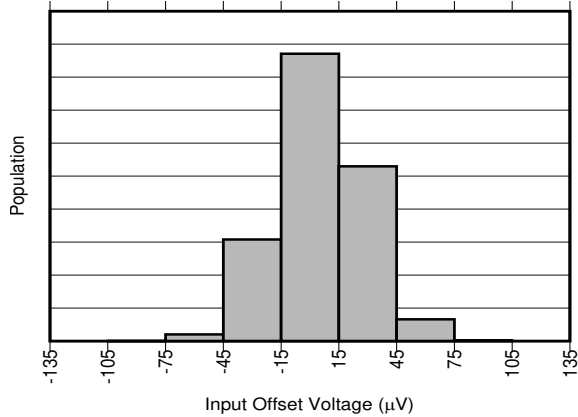

Figure 6-1. INA310A1 Input Offset Production Distribution

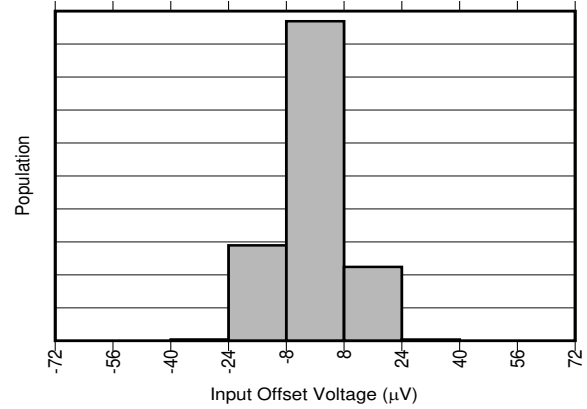

Figure 6-2. INA310A2 Input Offset Production Distribution

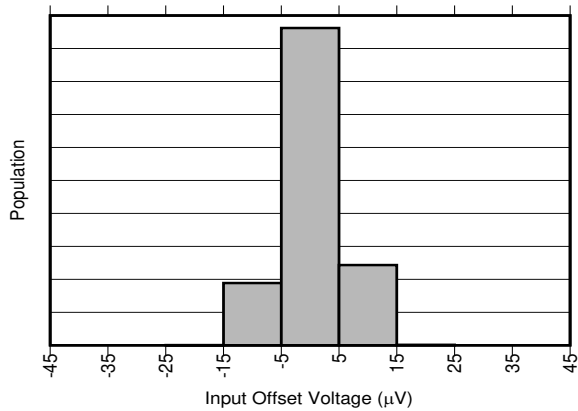

Figure 6-3. INA310A3 Input Offset Production Distribution

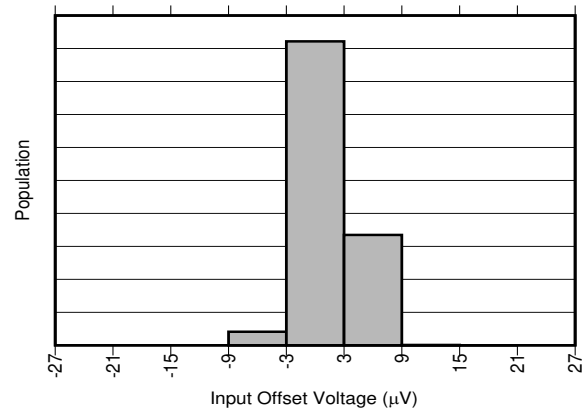

Figure 6-4. INA310A4 Input Offset Production Distribution

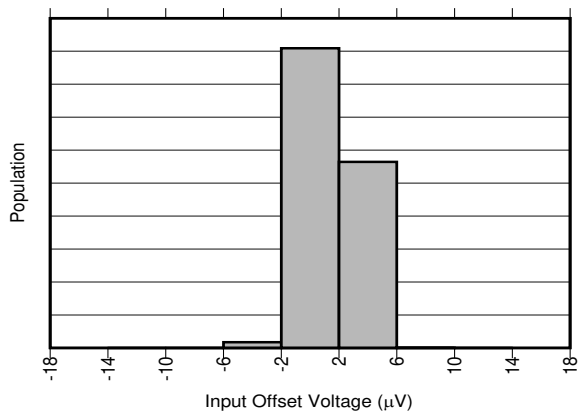

Figure 6-5. INA310A5 Input Offset Production Distribution

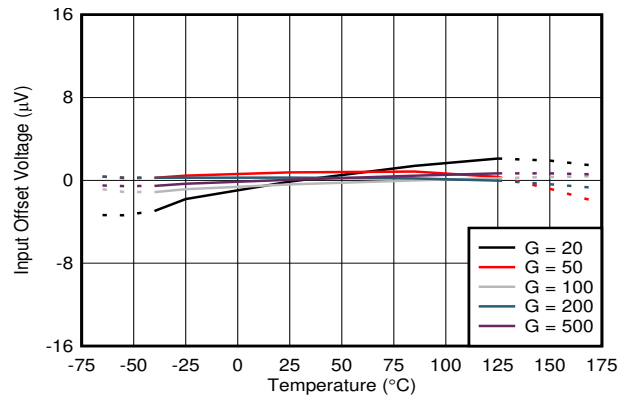

Figure 6-6. Input Offset Voltage vs Temperature

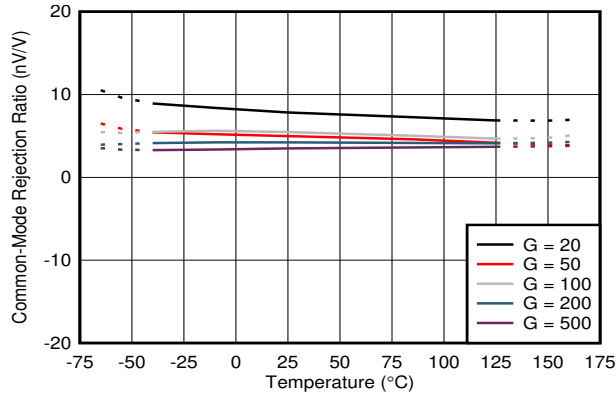

Figure 6-7. Common-Mode Rejection Ratio vs Temperature

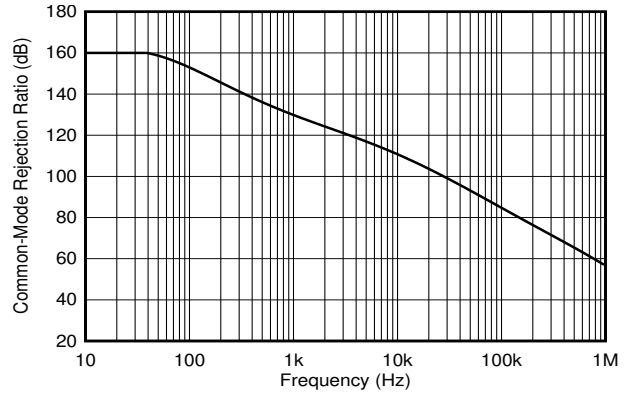

Figure 6-8. Common-Mode Rejection Ratio vs Frequency

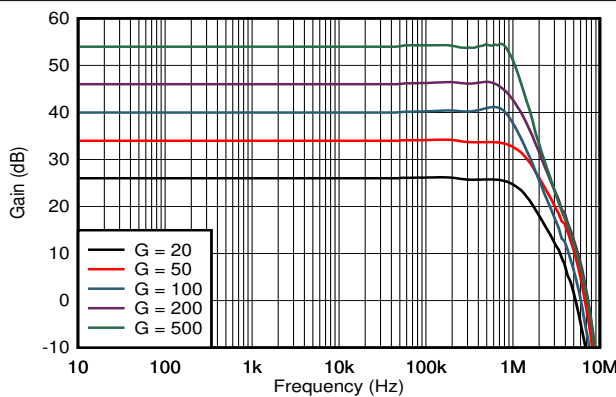

Figure 6-9. Gain vs Frequency

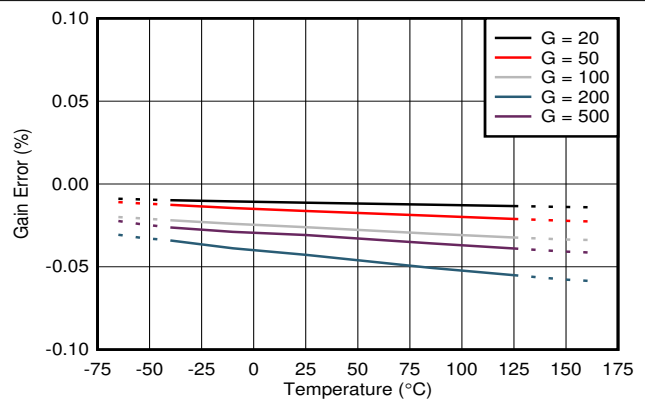

Figure 6-10. INA310A Gain Error vs Temperature

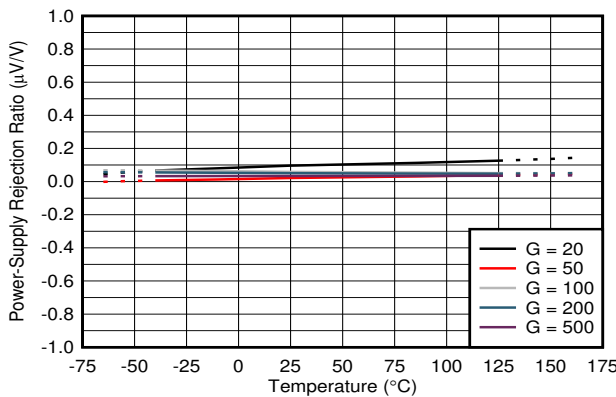

Figure 6-11. Power-Supply Rejection Ratio vs Temperature

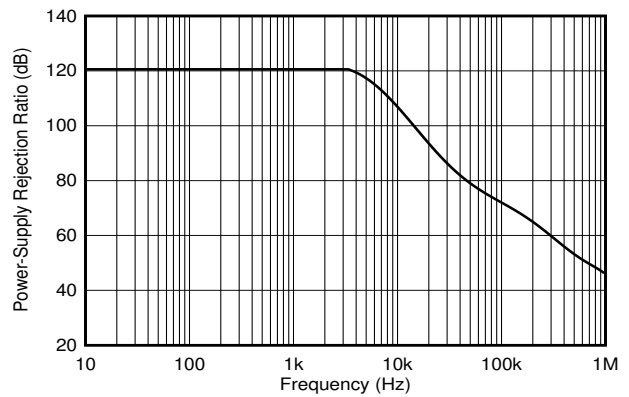

Figure 6-12. Power-Supply Rejection Ratio vs Frequency

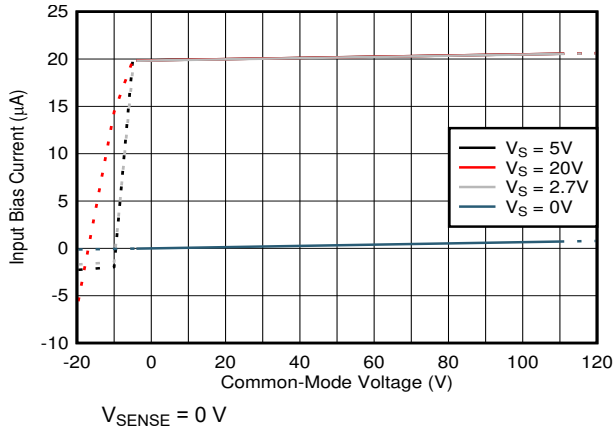

Figure 6-13. Input Bias Current vs Common-Mode Voltage

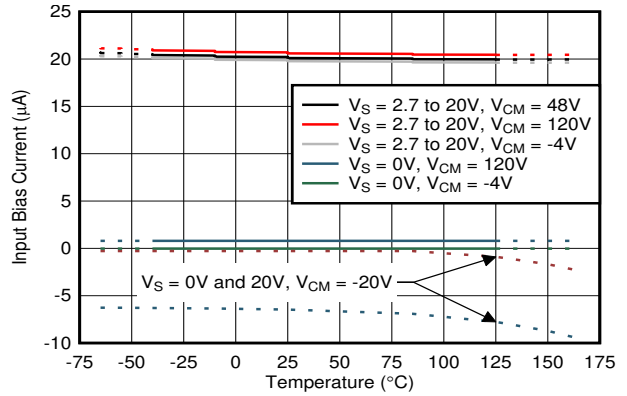

Figure 6-14. Input Bias Current vs Temperature

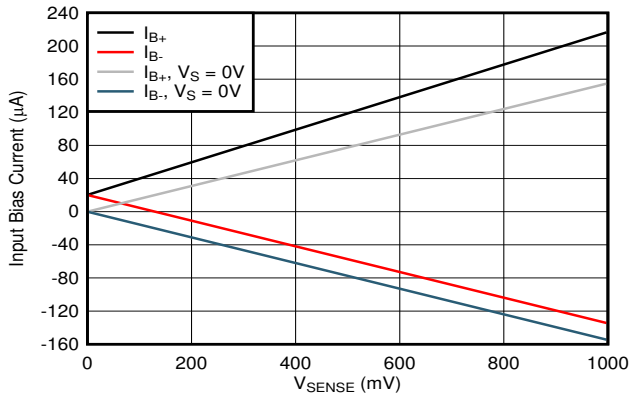

Figure 6-15. INA310x1 Input Bias Current vs V_{SENSE}

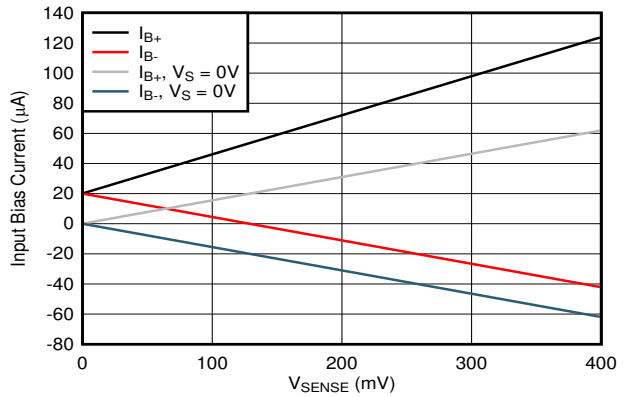

Figure 6-16. INA310x2, INA310x3 Input Bias Current vs V_{SENSE}

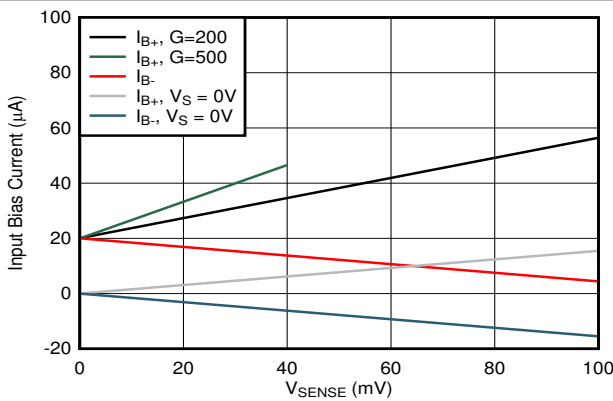

Figure 6-17. INA310x4, INA310x5 Input Bias Current vs V_{SENSE}

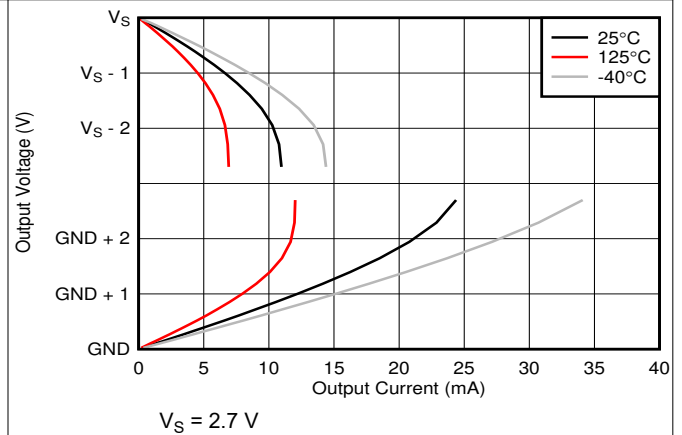

Figure 6-18. Output Voltage vs Output Current

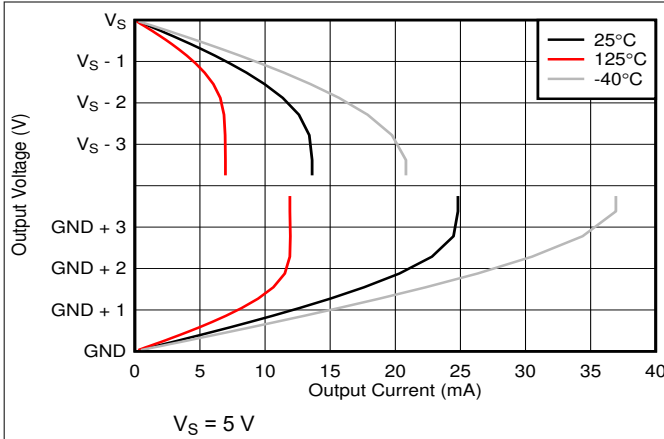

Figure 6-19. Output Voltage vs Output Current

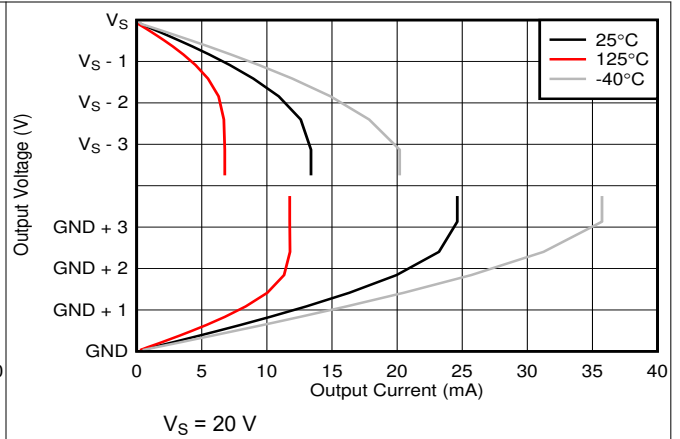

Figure 6-20. Output Voltage vs Output Current

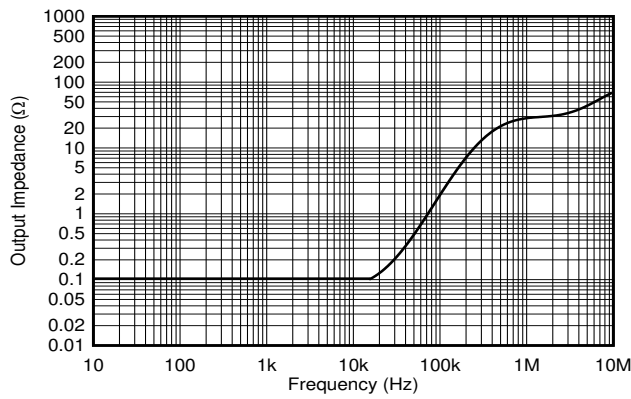

Figure 6-21. Output Impedance vs Frequency

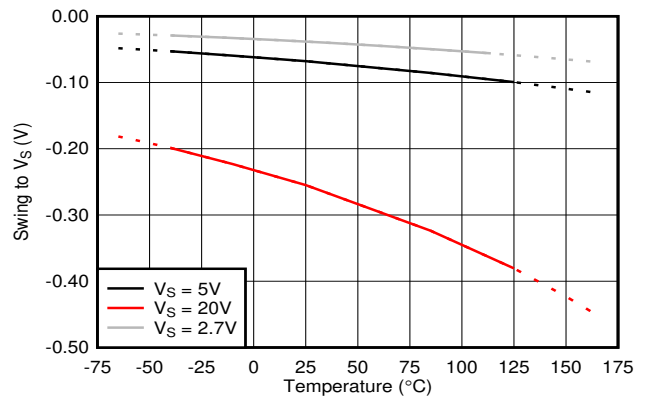

Figure 6-22. Swing to Supply vs Temperature

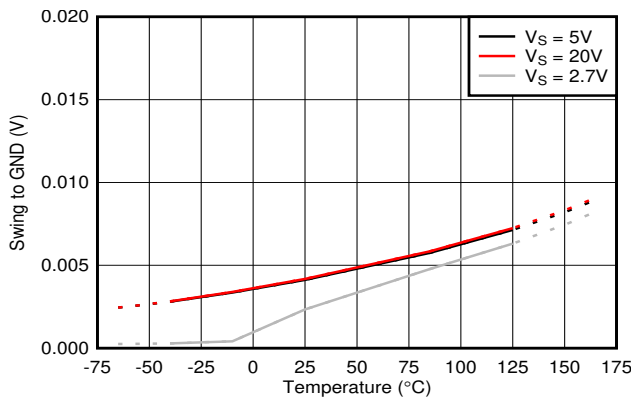

Figure 6-23. Swing to GND vs Temperature

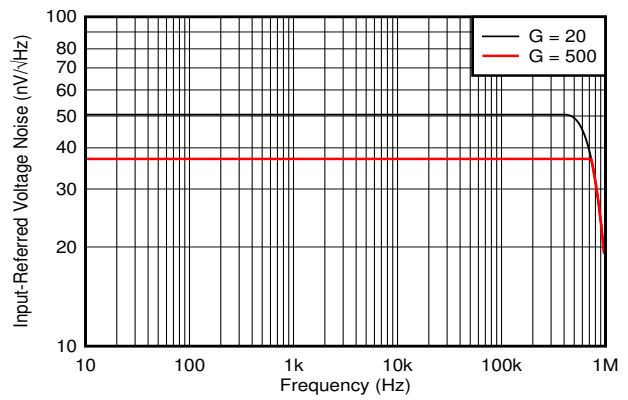

Figure 6-24. Input Referred Noise vs Frequency

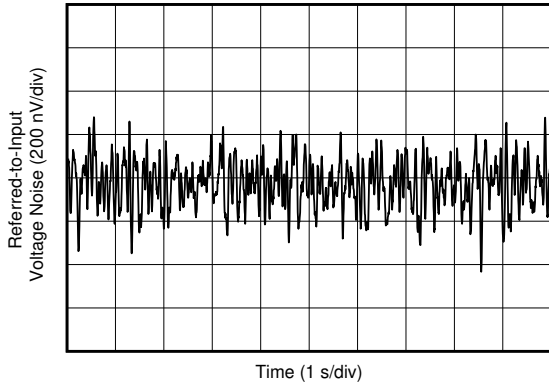

Figure 6-25. Input Referred Noise

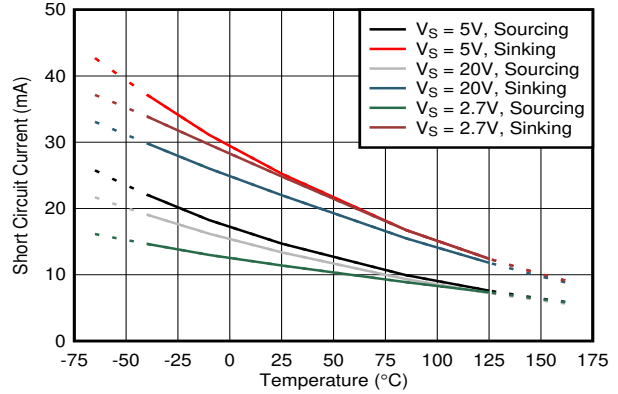

Figure 6-26. Short-Circuit Current vs Temperature

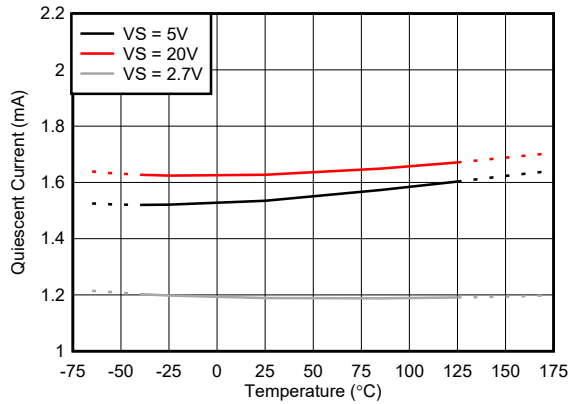

Figure 6-27. Quiescent Current vs Temperature

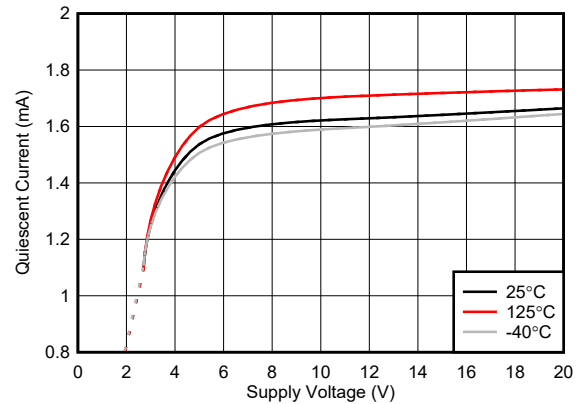

Figure 6-28. Quiescent Current vs Supply Voltage

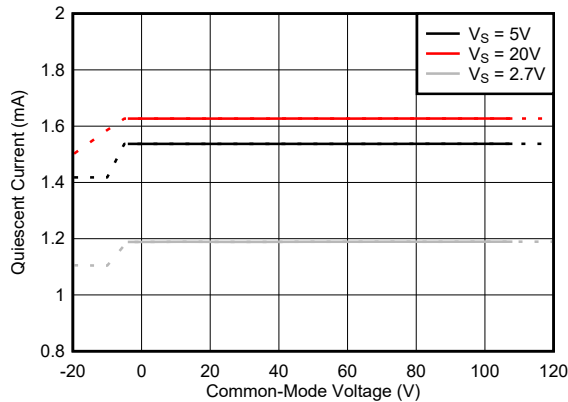

Figure 6-29. Quiescent Current vs Common-Mode Voltage

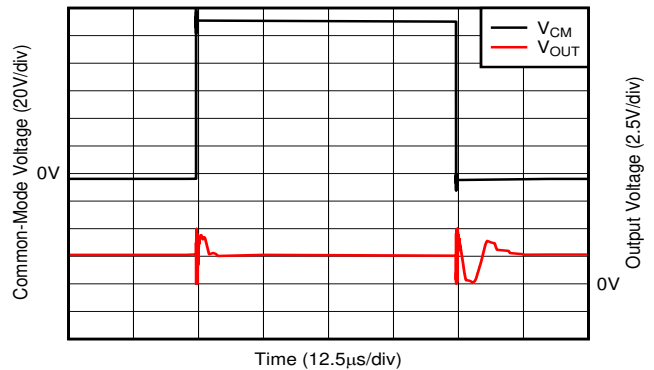

Figure 6-30. Common-Mode Voltage Fast Transient Pulse

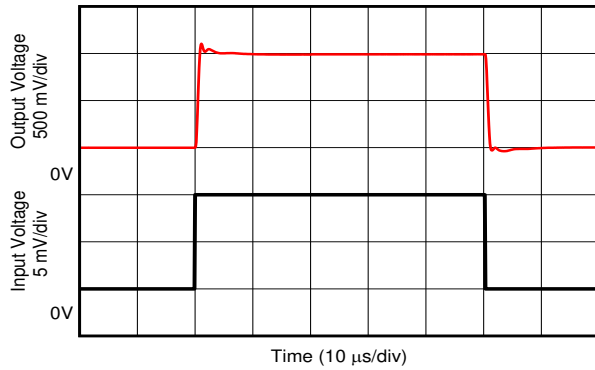

Figure 6-31. INA310x3 Step Response

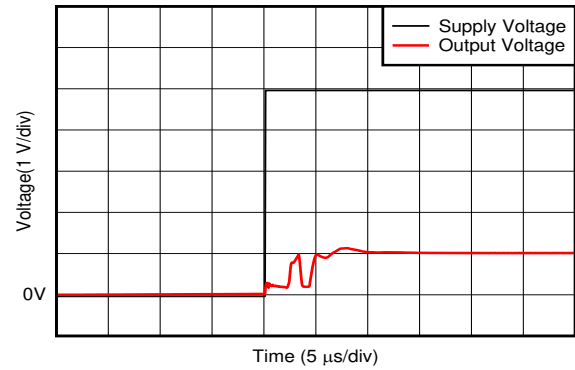

Figure 6-32. Start-Up Response

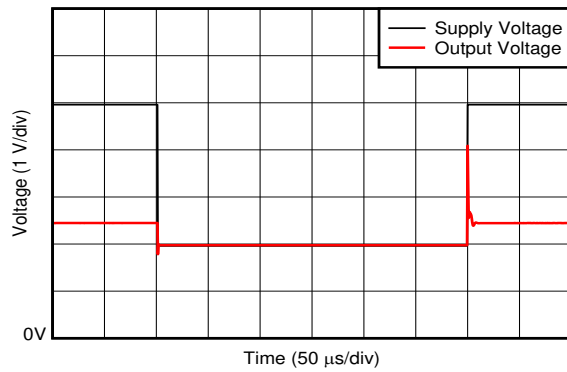

Figure 6-33. Supply Transient Response

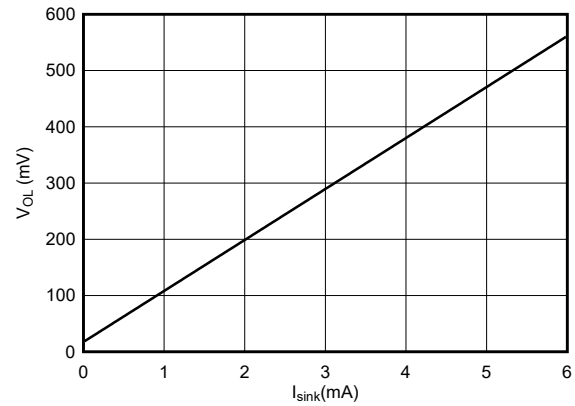

Figure 6-34. Comparator V_{OL} vs I_{SINK}

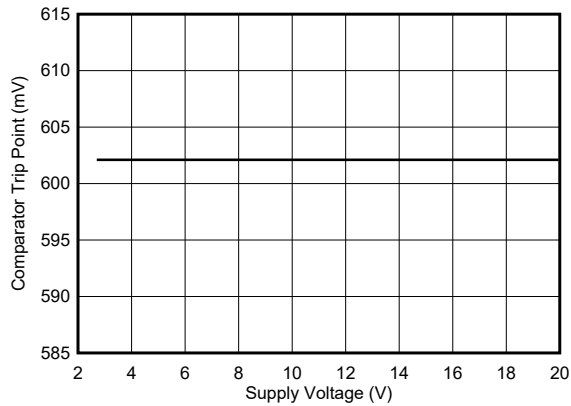

Figure 6-35. Comparator Trip Point vs Supply Voltage

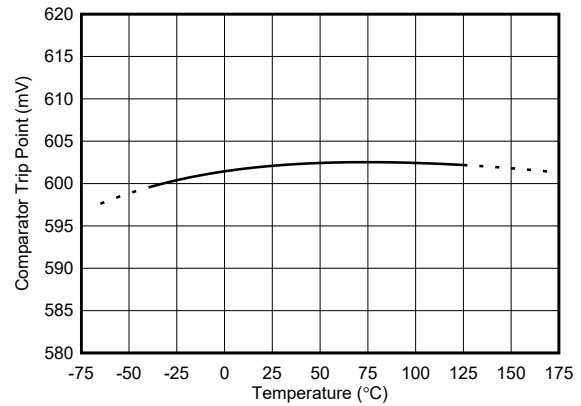

Figure 6-36. Comparator Trip Point vs Temperature

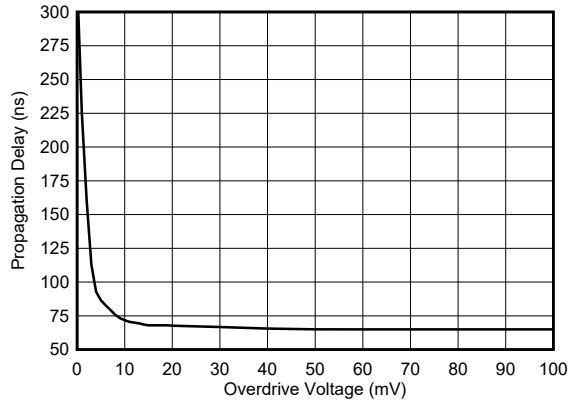

Figure 6-37. Comparator Propagation Delay vs Overdrive Voltage

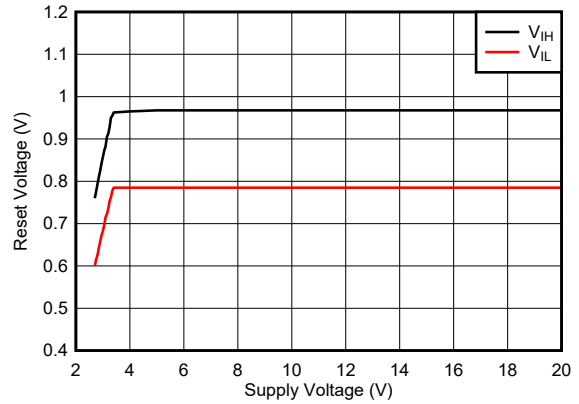

Figure 6-38. Comparator Reset Voltage vs Supply Voltage

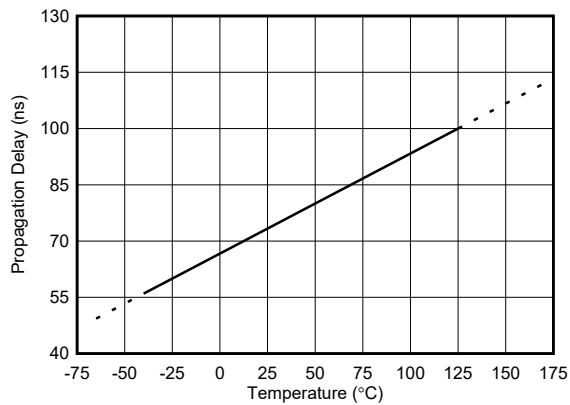

Figure 6-39. Comparator Propagation Delay vs Temperature

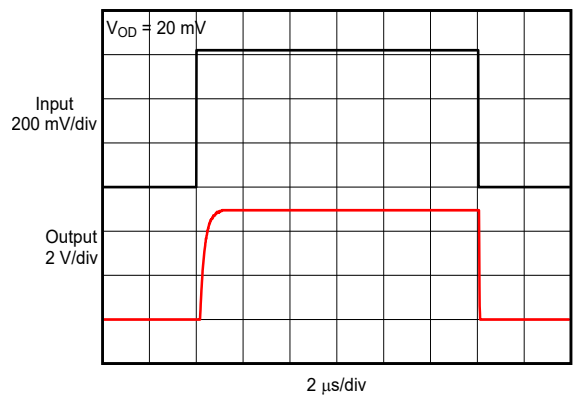

Figure 6-40. Comparator Propagation Delay

7 Detailed Description

7.1 Overview

The INA310x is a high or low-side high-speed current-sense amplifier that offers a wide common-mode range, precision zero-drift topology, excellent common-mode rejection ratio (CMRR) and fast slew rate. Different gain versions are available to optimize the output dynamic range based on the application. The INA310x is designed using an architecture that enables low input bias current of 20 μA with a specified common-mode voltage range from -4 V to 110 V with signal bandwidths up to 1.3 MHz. The INA310x incorporates an open-drain comparator and internal reference providing a 0.6-V threshold. An external resistor divider sets the current trip point. The comparator includes a latching capability, that can be made transparent by grounding (or leaving open) the $\overline{\text{RESET}}$ pin (see the [RESET Function](#) section).

7.2 Functional Block Diagram

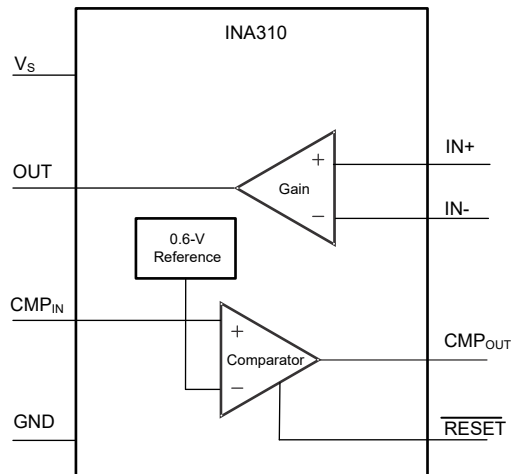

7.3 Feature Description

7.3.1 Amplifier Input Common-Mode Signal

The INA310x supports large input common-mode voltages from -4 V to $+110\text{ V}$. The internal topology of the INA310x enables the common-mode range to not be restricted by the power-supply voltage (V_S). Due to this feature, the INA310x can be used for both low-side and high-side current-sensing applications that extend beyond the supply range of 2.7 V to 20 V .

7.3.2 Input-Signal Bandwidth

The INA310x is available with several gain options, including 20 V/V, 50 V/V, 100 V/V, 200 V/V, and 500 V/V. The unique multistage design enables the amplifier to achieve high bandwidth at all gains. This high bandwidth provides the throughput and fast response that is required for the rapid detection and processing of overcurrent events.

7.3.3 Low Input Bias Current

The INA310x inputs draw a $20\text{-}\mu\text{A}$ input bias current per pin at a common-mode voltage as high as 110 V , which enables precision current sensing on applications that require lower current leakage. Unlike many high voltage current sense amplifiers whose input bias currents are proportional to the common-mode voltage, the input bias current of the INA310x remains flat over the entire common-mode voltage range.

7.3.4 Low V_{SENSE} Operation

The INA310x features high performance operation across the entire valid V_{SENSE} range. The zero-drift input architecture of the INA310x provides the low offset voltage and low offset drift needed to measure low V_{SENSE} levels accurately across the wide operating temperature of -40°C to $+125^\circ\text{C}$. Low V_{SENSE} operation is particularly beneficial when using low ohmic shunts for high current measurements, as power losses across

the shunt are significantly reduced. V_{SENSE} low level is only limited by the output swing to GND (V_{SN}). The minimum V_{SENSE} is limited to V_{SN} divided by Gain.

7.3.5 Wide Fixed Gain Output

The INA310x maximum gain error is 0.15% at room temperature, with a maximum drift of 10 ppm/°C over the full temperature range of -40°C to $+125^{\circ}\text{C}$. The INA310x is available in multiple gain options of 20 V/V, 50 V/V, 100 V/V, 200 V/V, and 500 V/V, which the system designer should select based on their desired signal-to-noise ratio and other system requirements, such as the dynamic current range and full-scale output voltage target.

The INA310x closed-loop gain is set by a precision, low-drift internal resistor network. The ratio of these resistors are excellently matched, while the absolute values may vary significantly. TI does not recommend adding additional resistance around the INA310x to change the effective gain because of this variation.

7.3.6 Wide Supply Range

The INA310x operates with a wide supply range from 2.7 V to 20 V. While the input voltage range of the INA310x is independent of the supply voltage, the output voltage is bound by the supply voltage applied to the device. The output voltage can range from as low as 20 mV to as high as 200 mV below the supply voltage.

7.3.7 Integrated Comparator

The INA310x incorporates an open-drain comparator with an internal reference providing a 0.6-V threshold. The comparator input (CMP_{IN}) can take voltage from 0 V up to 5.5 V or equal to power-supply voltage (if it is lower than 5.5 V). The comparator has a built-in hysteresis of 8 mV (typical). Figure 7-1 shows the hysteresis, which is the difference between the rising-edge threshold and the falling-edge threshold. The hysteresis makes stable switching at the comparator output by providing noise immunity at comparator input.

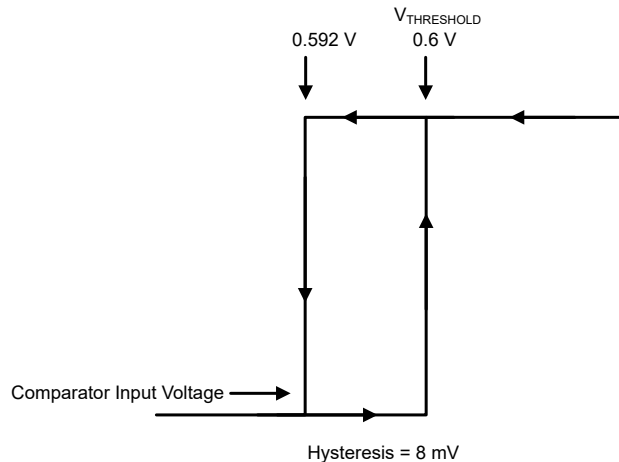

Figure 7-1. The Comparator Threshold and Hysteresis

The open-drain output of the comparator can be tied to voltage range of 0 to 20 V (independent of power supply) through a pullup resistor. When the voltage at the comparator input (CMP_{IN}) exceeds 0.6 V, the output of the comparator goes high. When the voltage at the comparator input falls below falling-threshold ($0.6\text{ V} - \text{Hysteresis}$), the output of the comparator is pulled low by an internal open-drain transistor.

7.3.8 RESET Function

The $\overline{\text{RESET}}$ function allows the comparator to work in transparent mode or latching mode. Figure 7-2 shows the two modes of the RESET function. When the $\overline{\text{RESET}}$ pin is left open or connected to GND the comparator functions in a transparent mode. In transparent mode comparator output (CMP_{OUT}) responds as a normal comparator. When the $\overline{\text{RESET}}$ pin is connected to the supply voltage, the pin operates in latching mode. In the latching mode when the comparator is triggered by the comparator input going higher than 0.6 V, the output of the comparator stays high irrespective of comparator input after. To release the comparator from the latching mode, the $\overline{\text{RESET}}$ pin must be pulled to GND or released to open. The $\overline{\text{RESET}}$ pin can take a voltage range from 0 V to the power-supply voltage.

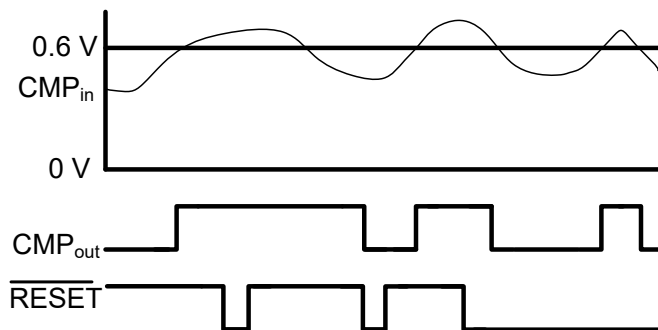

Figure 7-2. The Comparator $\overline{\text{RESET}}$ Function

7.3.9 Short Propagation Delay

The combination of a high-speed current sense amplifier and a fast comparator provides a short total propagation delay of 1 μs . The sense voltage (across the shunt resistor) propagates through the output where the output is divided down with the resistor divider to the comparator input and then to the comparator output. An external resistor divider at V_{OUT} sets overcurrent threshold. The total propagation delay is time taken from when the sense voltage (across the shunt resistor) exceeds the overcurrent threshold to when the comparator output drives high. The short propagation delay makes the INA310x well suited for overcurrent protection in systems sensitive to overcurrent events.

7.3.10 Comparator Input Bias Current

The INA310x comparator input has a built-in circuit to protect the input devices in case of large input differential voltage. This circuit results in the input bias current (I_{BCMPIN}) curve against input voltage (V_{CMPIN}) as shown in Figure 7-3. The I_{BCMPIN} reduces with V_{CMPIN} from 0 V to 0.4 V, I_{BCMPIN} is under 20 nA at 25°C for V_{CMPIN} range from 0.4 V to 1.2 V, and I_{BCMPIN} increases with V_{CMPIN} from 1.8 V to 5.5 V. The nature of I_{BCMPIN} does not contribute to the inaccuracy of the comparator alert threshold voltage ($V_{\text{THRESHOLD}}$) significantly because the I_{BCMPIN} goes below 20 nA when the input voltage is close to the threshold voltage (0.6 V). Avoid using a high-value resistor for the divider network for better $V_{\text{THRESHOLD}}$ accuracy. The sum of the two resistors in the divider network as shown in [Overcurrent Threshold Connection](#) is recommended to keep lower than 100 k Ω .

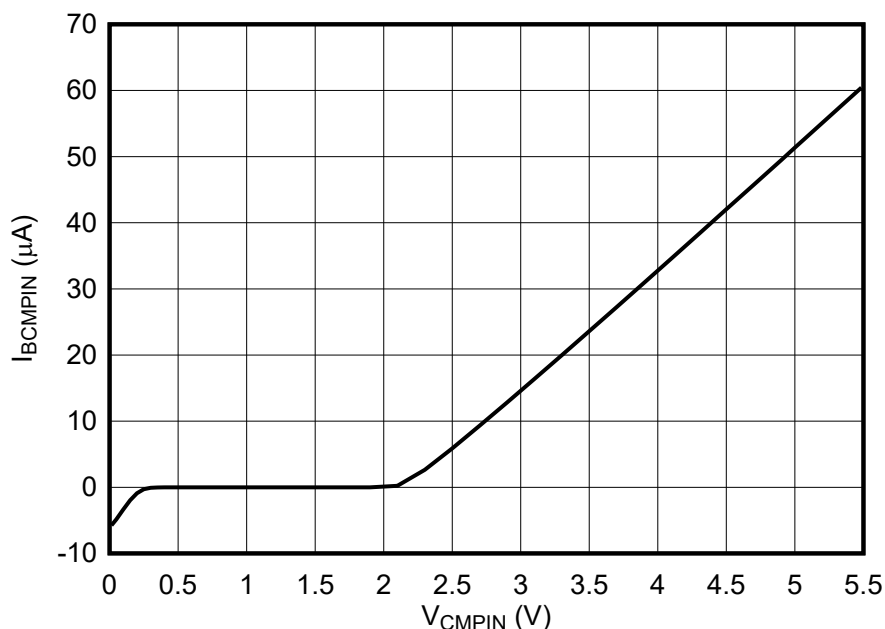

Figure 7-3. Comparator I_{BCMPIN} vs V_{CMPIN}

7.4 Device Functional Modes

7.4.1 Basic Connections

Figure 7-4 shows a basic circuit connection for INA310x. The INA310x is configurable to allow for unidirectional high-side or low-side, current-sensing operation. The input pins (IN+ and IN-) must be connected as closely as possible with Kelvin connections to the shunt resistor to minimize any resistance in series with the shunt resistance. The [Layout](#) section provides the layout guidelines and a layout example.

Power-supply bypass capacitors are required for stability. Applications with noisy or high-impedance power supplies may require additional decoupling capacitors to reject power-supply noise. Connect bypass capacitors close to the device V_S pin. The recommended value of a bypass capacitor is 0.01 μF

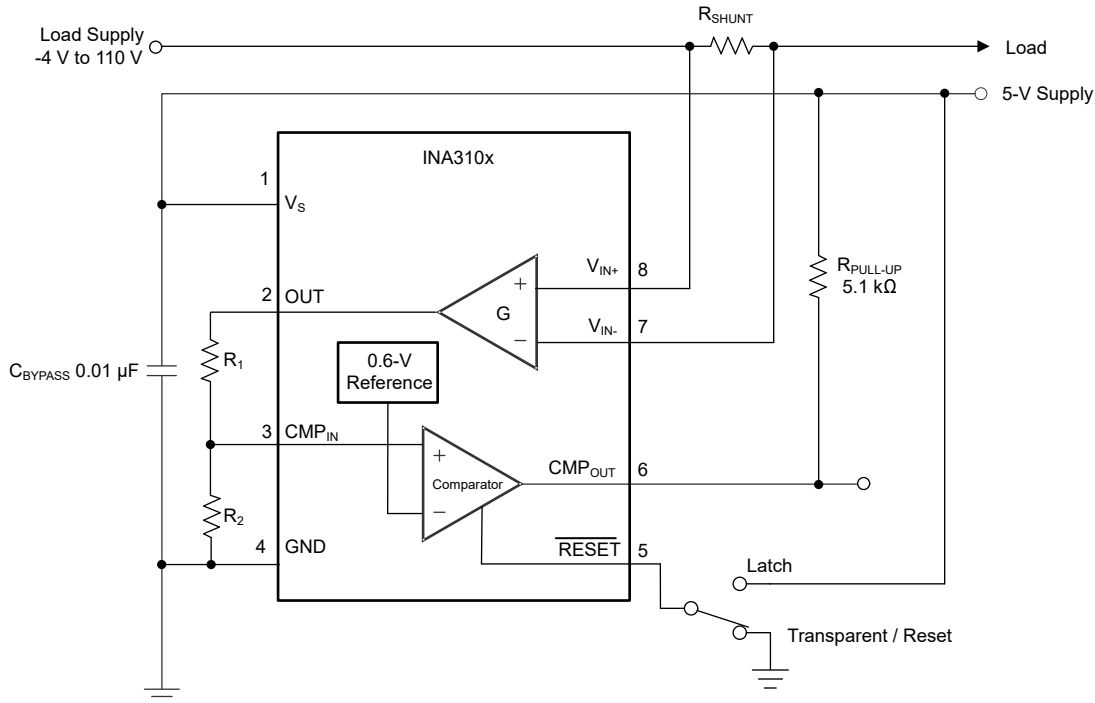

Figure 7-4. INA310 Basic Connections

7.4.1.1 Overcurrent Threshold Connection

The INA310x comparator in Figure 7-4 is configured to provide overcurrent alert signal when the current through R_{SHUNT} exceeds the overcurrent threshold. OUT voltage times R₂ divided by R₁ and R₂ compared to the internal reference voltage (0.6 V) sets the overcurrent threshold. Equation 1 shows the relation of the overcurrent threshold with gain, R_{SHUNT}, R₁ and R₂.

$$I_{Sense_Alert_Threshold} = \frac{0.6 \times (R_1 + R_2)}{R_2 \times G \times R_{shunt}} \quad (1)$$

R₁ and R₂ load OUT, therefore TI recommends to set the sum of these resistors higher than 10k. This helps keep the high swing range at the OUT and lower total supply current. The high value of these resistors will contribute to inaccuracy in comparator alert threshold voltage (V_{THRESHOLD}) as mentioned in [Comparator Input Bias Current](#). The [Design Requirements](#) section shows an example of resistors values to set the overcurrent threshold.

7.4.2 High-Side Switch Overcurrent Shutdown

The INA310x measures differential voltage developed by current flowing through a current-shunt resistor. [Figure 7-5](#) shows the circuit with INA310x used for turning off the high-side switch in case of overcurrent. When the current exceeds overcurrent threshold, the comparator output (CMP_{OUT}) signal goes high. This signal from the comparator drives through the Q1 transistor to the gate of the high-side switch, causing the switch to shut down. The Q1 transistor helps isolate CMP_{OUT} from the high voltage of the Supply. There are three location options to have shunt resistor to measure unidirectional current. Option 1 and Option 2 are high-side current sensing, and Option 3 is low-side current sensing. Though both are high-side current sensing, Option 1 accounts for the current flowing through the Q1 transistor, and Option 2 does not. The advantages of high-side current sensing are that high-side sensing options do not contribute to ground disturbances and that high-side sensing can detect load shorts. In high-side current sensing, input common-mode is close to the power supply so a current-sensing amplifier with high CMRR and high common-mode is required for high-accuracy measurement. The low-side current sensing does not require a high-voltage, current-sensing amplifier as common mode remains very close to the ground. The disadvantages of low-side current sensing are that low-side sensing options contribute to ground disturbances and that low-side current sensing cannot detect load shorts.

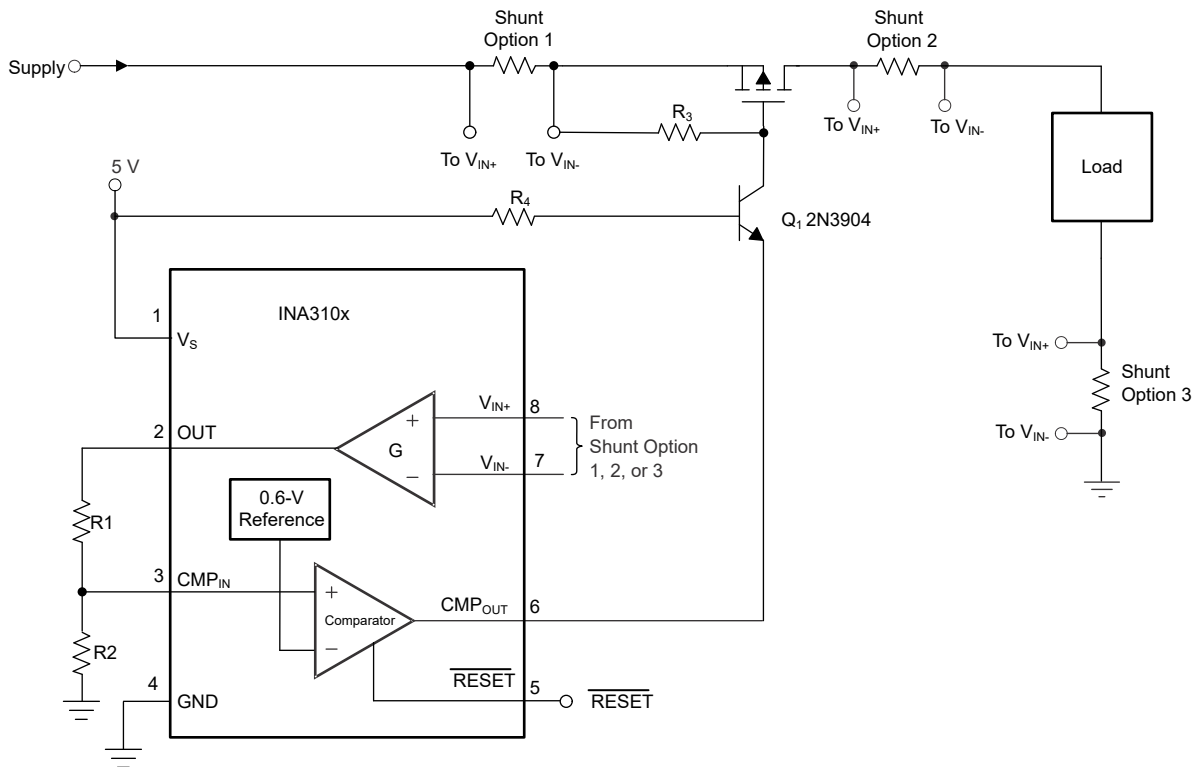

Figure 7-5. High-Side Switch for Overcurrent Shutdown

7.4.3 Bidirectional Overcurrent Comparator

The INA310x can operate only in unidirectional mode, but [Figure 7-6](#) shows that two INA310xs can be configured to provide a bidirectional overcurrent alert signal. The polarity of the differential voltage measured across the shunt resistor is in reverse for one current sense amplifier. Two INA310x function to cover the opposite current directions, and therefore provide bidirectional overcurrent monitor function.

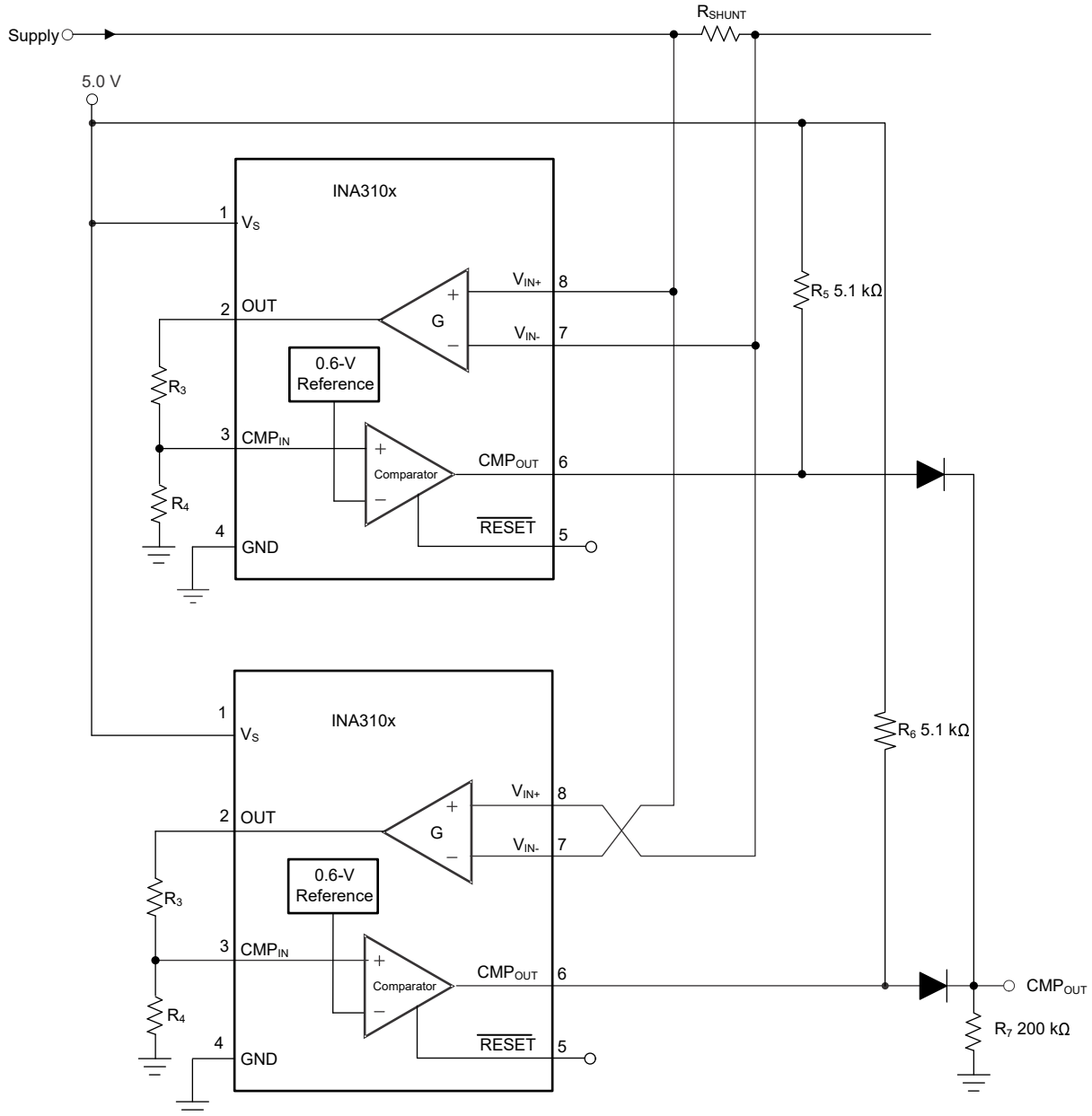

Figure 7-6. Ground Referenced Output

8 Application and Implementation

Note

Information in the following applications sections is not part of the TI component specification, and TI does not warrant its accuracy or completeness. TI's customers are responsible for determining suitability of components for their purposes, as well as validating and testing their design implementation to confirm system functionality.

8.1 Application Information

The INA310x amplifies the voltage developed across a current-sensing resistor as current flows through the resistor to the load. The wide input common-mode voltage range and high common-mode rejection of the INA310x make the device usable over a wide range of voltage rails while still maintaining accurate current measurement.

8.1.1 R_{SENSE} and Device Gain Selection

To maximize the accuracy of a current sense amplifier, TI recommends to choose the largest current sense resistor value possible in an application. A larger value sense resistor maximizes the differential input signal for a given amount of current flow and reduces the error contribution of the offset voltage. However, there are practical limits as to how large the current-sense resistor value can be in a given application because of the physical dimensions of the resistor, package construction and maximum power dissipation. Equation 2 gives the maximum value for the current-sense resistor for a given power dissipation budget:

$$R_{\text{SENSE}} < \frac{PD_{\text{MAX}}}{I_{\text{MAX}}^2} \quad (2)$$

where:

- PD_{MAX} is the maximum allowable power dissipation in R_{SENSE}.
- I_{MAX} is the maximum current that will flow through R_{SENSE}.

An additional limitation on the size of the current sense resistor and device gain is due to the power-supply voltage, V_S, and device swing-to-rail limitations. To make sure that the current-sense signal is properly passed to the output, both positive and negative output swing limitations must be examined. Equation 3 provides the maximum values of R_{SENSE} and GAIN to keep the device from exceeding the positive swing limitation.

$$I_{\text{MAX}} \times R_{\text{SENSE}} \times \text{GAIN} < V_{\text{SP}} \quad (3)$$

where:

- I_{MAX} is the maximum current that will flow through R_{SENSE}.
- GAIN is the gain of the current-sense amplifier.
- V_{SP} is the positive output swing as specified in the data sheet.

To avoid positive output swing limitations when selecting the value of R_{SENSE}, there is always a trade-off between the value of the sense resistor and the gain of the device under consideration. If the sense resistor selected for the maximum power dissipation is too large, then it is possible to select a lower-gain device to avoid positive swing limitations.

The negative swing limitation places a limit on how small the sense resistor value can be for a given application. Equation 4 provides the limit on the minimum value of the sense resistor.

$$I_{\text{MIN}} \times R_{\text{SENSE}} \times \text{GAIN} > V_{\text{SN}} \quad (4)$$

where:

- I_{MIN} is the minimum current that will flow through R_{SENSE}.

- GAIN is the gain of the current-sense amplifier.
- V_{SN} is the negative output swing of the device.

Table 8-1 shows an example of the different results obtained from using five different gain versions of the INA310x. From the table data, the highest gain device allows a smaller current-shunt resistor and decreased power dissipation in the element.

Table 8-1. R_{SENSE} Selection and Power Dissipation⁽¹⁾

PARAMETER		EQUATION	RESULTS AT $V_S = 5\text{ V}$				
			A1, B1 DEVICES	A2, B2 DEVICES	A3, B3 DEVICES	A4, B4 DEVICES	A5, B5 DEVICES
G	Gain		20 V/V	50 V/V	100 V/V	200 V/V	500 V/V
V_{DIFF}	Ideal differential input voltage	$V_{DIFF} = V_{OUT} / G$	250 mV	100 mV	50 mV	25 mV	10mV
R_{SENSE}	Current sense resistor value	$R_{SENSE} = V_{DIFF} / I_{MAX}$	25 m Ω	10 m Ω	5 m Ω	2.5 m Ω	1 m Ω
P_{SENSE}	Current-sense resistor power dissipation	$R_{SENSE} \times I_{MAX}^2$	2.5 W	1 W	0.5 W	0.25 W	0.1 W

(1) Design example with 10-A full-scale current with maximum output voltage set to 5 V.

8.2 Typical Application

The INA310x is a unidirectional, current-sense amplifier capable of measuring currents through a resistive shunt with shunt common-mode voltages from -4 V to $+110\text{ V}$.

8.2.1 Current Sensing in a Solenoid Application

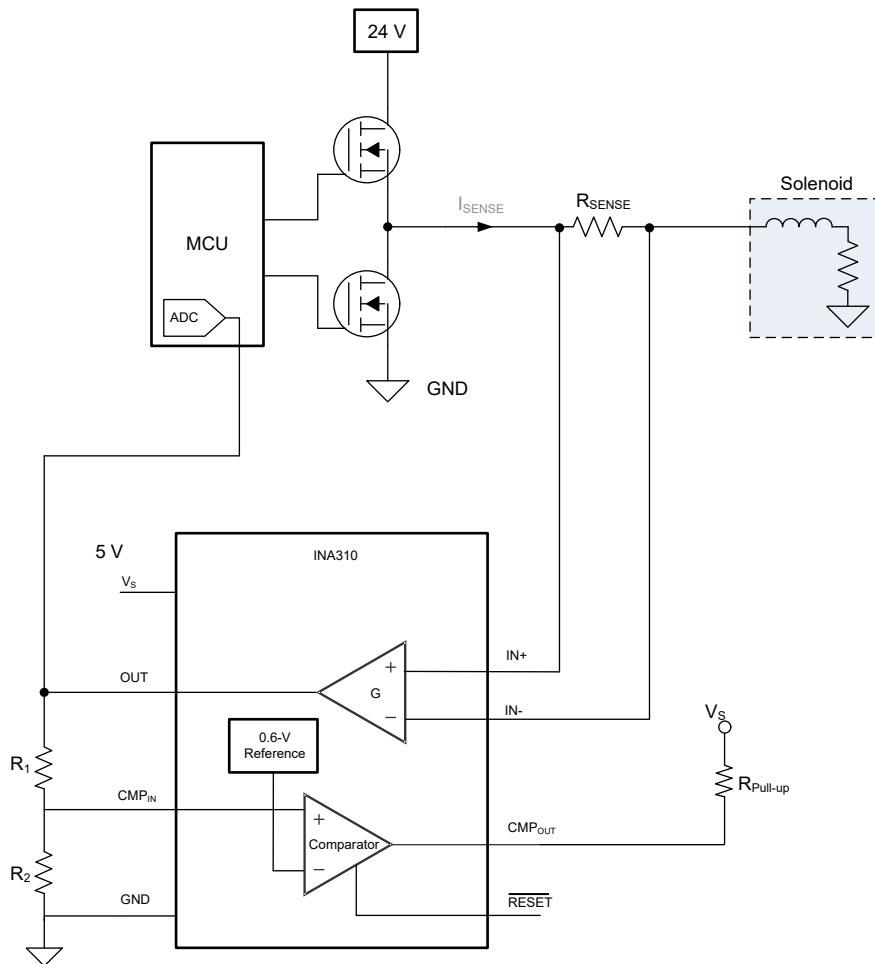

Figure 8-1. Current Sensing in a Solenoid Application

8.2.1.1 Design Requirements

In this example application, the common-mode voltage ranges from 0 V to 24 V. The maximum sense current is 1.5 A, an alert must be indicated if the current exceeds 1.9 A, and a 5 V supply is available for the INA310x. Following the design guidelines from [R_{SENSE} and Device Gain Selection](#), a R_{SENSE} of 50 mΩ and a gain of 50 V/V are selected to provide good output dynamic range. [Table 8-2](#) lists the design setup for this application.

Table 8-2. Design Parameters

DESIGN PARAMETERS	EXAMPLE VALUE
Power supply voltage	5 V
Common mode voltage range	0 V to 24 V
Maximum sense current	1.5 A
R _{SENSE} resistor	50 mΩ
Gain option	50 V/V
Over-current Threshold	1.9 A
R ₁	69.15 kΩ
R ₂	10 kΩ

8.2.1.2 Detailed Design Procedure

The INA310x is designed to measure current in a typical solenoid application. The INA310x measures current across the 50-mΩ shunt that is placed at the output of the half-bridge. The INA310x measures the differential voltage across the shunt resistor, and the signal is internally amplified with a gain of 50 V/V. The output of the INA310x is connected to the analog-to-digital converter (ADC) of an MCU to digitize the current measurements.

R₂ is fixed as 10 kΩ to avoid loading of OUT as recommended in [Overcurrent Threshold Connection](#). R₁ is calculated as 69.15 kΩ using [Equation 1](#).

$$1.9 \text{ A} = \frac{0.6 \text{ V} \times (R_1 + 10 \text{ k}\Omega)}{10 \text{ k}\Omega \times 50 \times 50 \text{ m}\Omega}$$

R₁ (69.15 kΩ) and R₂ (10 kΩ) divides down the output which is an input to the comparator. This sets the overcurrent alert threshold of 1.9 A.

Solenoid loads are highly inductive and are often prone to failure. Solenoids are often used for position control, precise fluid control, and fluid regulation. Measuring real-time current on the solenoid continuously can indicate premature failure of the solenoid, which can lead to a faulty control loop in the system. Measuring high-side current also indicates if there are any ground faults on the solenoid or the FETs that can be damaged in an application. The INA310x, with high bandwidth and slew rate, can be used to detect fast overcurrent conditions to prevent the solenoid damage from short-to-ground faults.

8.2.1.2.1 Overload Recovery With Negative V_{SENSE}

The INA310x is a unidirectional current sense amplifier that is meant to operate with a positive differential input voltage (V_{SENSE}). If negative V_{SENSE} is applied, the device is placed in an overload or saturated condition and requires time to recover after V_{SENSE} returns positive. The required overload recovery time increases with more negative V_{SENSE}.

indicated if the current exceeds 1.2 A, and a 5 V supply is available for the INA310x. Following the design guidelines from *R_{SENSE} and Device Gain Selection*, a R_{SHUNT} of 100 mΩ and a gain of 20 V/V are selected to provide a good output dynamic range. Table 8-3 lists the design setup for this application.

Table 8-3. Design Parameters

DESIGN PARAMETERS	EXAMPLE VALUE
Power supply voltage	5 V
Common mode voltage range	5 V
Maximum sense current	1 A
R _{SENSE} resistor	100 mΩ
Gain option	20 V/V
Over-current Threshold	1.2 A
R ₁	10.2 kΩ
R ₂	3.4 kΩ

8.2.2.2 Detailed Design Procedure

Figure 8-3 shows the basic connections to the INA310x. The inputs terminals (IN+ and IN–) must be connected to the current sense resistor as close as possible to minimize any resistance in series with the shunt resistor. The INA310x measures current across the 100-mΩ shunt that is placed in series with load. The INA310x measures the differential voltage across the shunt resistor, and the signal is internally amplified with a gain of 20 V/V.

R₁ is fixed as 10.2 kΩ to avoid loading of OUT as recommended in *Overcurrent Threshold Connection*. R₂ is calculated as 3.4 kΩ using Equation 1. R₁ (10.2 kΩ) and R₂ (3.4 kΩ) divides down the output which is an input to the comparator. This sets the overcurrent alert threshold of 1.2 A.

8.2.2.3 Application Curve

Figure 8-4 shows the output response the current sense amplifier and the comparator in event of overcurrent.

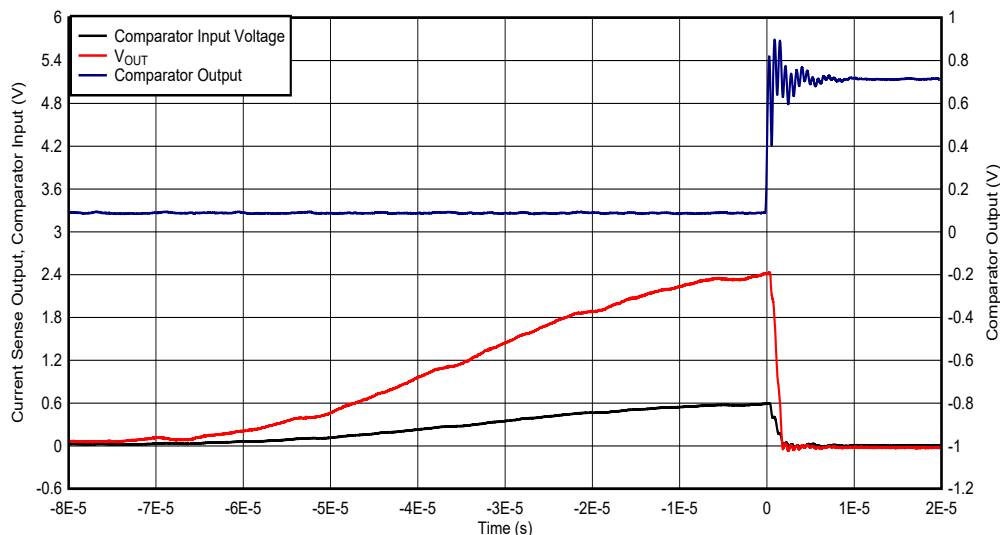

Figure 8-4. Low-Side Switch Overcurrent Shutdown Response

8.3 Power Supply Recommendations

The INA310x makes accurate measurements beyond the connected power-supply voltage (V_S) because the inputs (IN+ and IN–) can operate anywhere between –4 V and 110 V independent of V_S . For example, with the V_S power supply equal to 5 V, the common-mode voltage of the measured shunt can be as high as 110 V.

8.3.1 Power Supply Decoupling

Place the power-supply bypass capacitor as close to the power-supply and ground pins as possible. TI recommends a bypass capacitor value of 0.1 μF . Additional decoupling capacitance can be added to compensate for noisy or high-impedance power supplies.

8.4 Layout

8.4.1 Layout Guidelines

Attention to good layout practices is always recommended.

- Connect the input pins to the sensing resistor using a Kelvin or 4-wire connection. This connection technique makes sure that only the current-sensing resistor impedance is detected between the input pins. Poor routing of the current-sensing resistor commonly results in additional resistance present between the input pins. Given the very low ohmic value of the current resistor, any additional high-current carrying impedance can cause significant measurement errors.
- Place the power-supply bypass capacitor as close to the device power-supply and ground pins as possible. The recommended value of this bypass capacitor is 0.1 μF . Additional decoupling capacitance can be added to compensate for noisy or high-impedance power supplies.

8.4.2 Layout Example

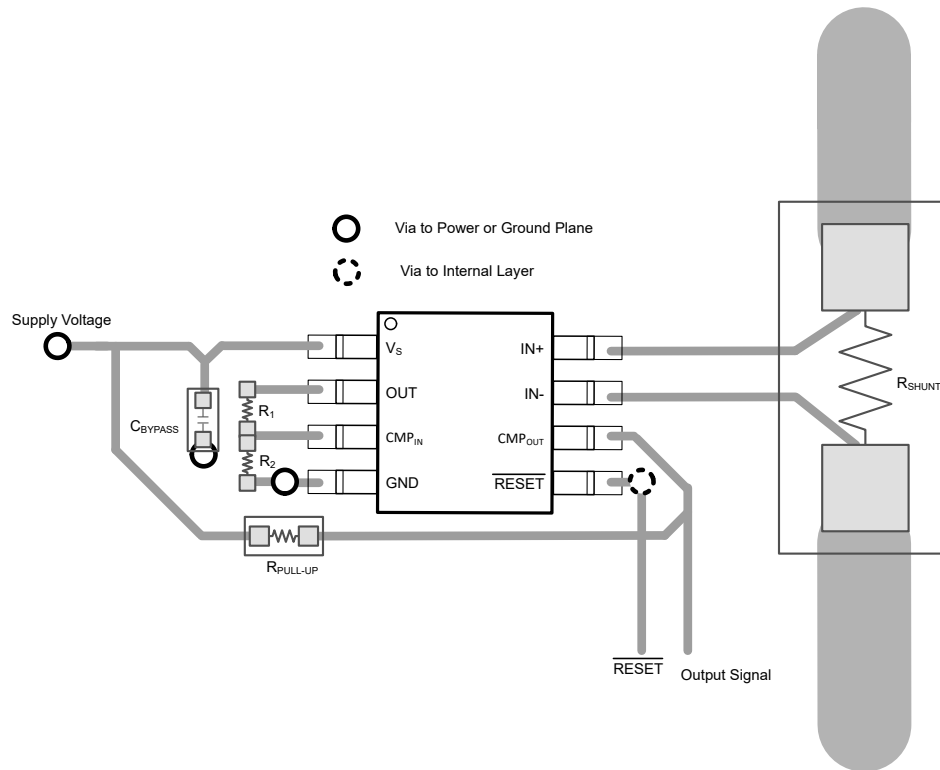

Figure 8-5. INA310xx Recommended Layout

9 Device and Documentation Support

9.1 Receiving Notification of Documentation Updates

To receive notification of documentation updates, navigate to the device product folder on ti.com. In the upper right corner, click on *Alert me* to register and receive a weekly digest of any product information that has changed. For change details, review the revision history included in any revised document.

9.2 Support Resources

TI E2E™ support forums are an engineer's go-to source for fast, verified answers and design help — straight from the experts. Search existing answers or ask your own question to get the quick design help you need.

Linked content is provided "AS IS" by the respective contributors. They do not constitute TI specifications and do not necessarily reflect TI's views; see TI's [Terms of Use](#).

9.3 Trademarks

TI E2E™ is a trademark of Texas Instruments.

All trademarks are the property of their respective owners.

9.4 Electrostatic Discharge Caution



This integrated circuit can be damaged by ESD. Texas Instruments recommends that all integrated circuits be handled with appropriate precautions. Failure to observe proper handling and installation procedures can cause damage.

ESD damage can range from subtle performance degradation to complete device failure. Precision integrated circuits may be more susceptible to damage because very small parametric changes could cause the device not to meet its published specifications.

9.5 Glossary

[TI Glossary](#) This glossary lists and explains terms, acronyms, and definitions.

10 Mechanical, Packaging, and Orderable Information

The following pages include mechanical, packaging, and orderable information. This information is the most current data available for the designated devices. This data is subject to change without notice and revision of this document. For browser-based versions of this data sheet, refer to the left-hand navigation.

PACKAGING INFORMATION

Orderable Device	Status (1)	Package Type	Package Drawing	Pins	Package Qty	Eco Plan (2)	Lead finish/ Ball material (6)	MSL Peak Temp (3)	Op Temp (°C)	Device Marking (4/5)	Samples
INA310A1IDGKR	ACTIVE	VSSOP	DGK	8	2500	RoHS & Green	NIPDAU	Level-2-260C-1 YEAR	-40 to 125	2OZB	Samples
INA310A2IDGKR	ACTIVE	VSSOP	DGK	8	2500	RoHS & Green	NIPDAU	Level-2-260C-1 YEAR	-40 to 125	2P1B	Samples
INA310A3IDGKR	ACTIVE	VSSOP	DGK	8	2500	RoHS & Green	NIPDAU	Level-2-260C-1 YEAR	-40 to 125	2P2B	Samples
INA310A4IDGKR	ACTIVE	VSSOP	DGK	8	2500	RoHS & Green	NIPDAU	Level-2-260C-1 YEAR	-40 to 125	2P3B	Samples
INA310A5IDGKR	ACTIVE	VSSOP	DGK	8	2500	RoHS & Green	NIPDAU	Level-2-260C-1 YEAR	-40 to 125	2P4B	Samples
INA310B1IDGKR	ACTIVE	VSSOP	DGK	8	2500	RoHS & Green	NIPDAU	Level-2-260C-1 YEAR	-40 to 125	2P5B	Samples
INA310B2IDGKR	ACTIVE	VSSOP	DGK	8	2500	RoHS & Green	NIPDAU	Level-2-260C-1 YEAR	-40 to 125	2P6B	Samples
INA310B3IDGKR	ACTIVE	VSSOP	DGK	8	2500	RoHS & Green	NIPDAU	Level-2-260C-1 YEAR	-40 to 125	2P7B	Samples
INA310B4IDGKR	ACTIVE	VSSOP	DGK	8	2500	RoHS & Green	NIPDAU	Level-2-260C-1 YEAR	-40 to 125	2P8B	Samples
INA310B5IDGKR	ACTIVE	VSSOP	DGK	8	2500	RoHS & Green	NIPDAU	Level-2-260C-1 YEAR	-40 to 125	2P9B	Samples

(1) The marketing status values are defined as follows:

ACTIVE: Product device recommended for new designs.

LIFEBUY: TI has announced that the device will be discontinued, and a lifetime-buy period is in effect.

NRND: Not recommended for new designs. Device is in production to support existing customers, but TI does not recommend using this part in a new design.

PREVIEW: Device has been announced but is not in production. Samples may or may not be available.

OBSOLETE: TI has discontinued the production of the device.

(2) **RoHS:** TI defines "RoHS" to mean semiconductor products that are compliant with the current EU RoHS requirements for all 10 RoHS substances, including the requirement that RoHS substance do not exceed 0.1% by weight in homogeneous materials. Where designed to be soldered at high temperatures, "RoHS" products are suitable for use in specified lead-free processes. TI may reference these types of products as "Pb-Free".

RoHS Exempt: TI defines "RoHS Exempt" to mean products that contain lead but are compliant with EU RoHS pursuant to a specific EU RoHS exemption.

Green: TI defines "Green" to mean the content of Chlorine (Cl) and Bromine (Br) based flame retardants meet JS709B low halogen requirements of <=1000ppm threshold. Antimony trioxide based flame retardants must also meet the <=1000ppm threshold requirement.

(3) MSL, Peak Temp. - The Moisture Sensitivity Level rating according to the JEDEC industry standard classifications, and peak solder temperature.

(4) There may be additional marking, which relates to the logo, the lot trace code information, or the environmental category on the device.

⁽⁵⁾ Multiple Device Markings will be inside parentheses. Only one Device Marking contained in parentheses and separated by a "~" will appear on a device. If a line is indented then it is a continuation of the previous line and the two combined represent the entire Device Marking for that device.

⁽⁶⁾ Lead finish/Ball material - Orderable Devices may have multiple material finish options. Finish options are separated by a vertical ruled line. Lead finish/Ball material values may wrap to two lines if the finish value exceeds the maximum column width.

Important Information and Disclaimer:The information provided on this page represents TI's knowledge and belief as of the date that it is provided. TI bases its knowledge and belief on information provided by third parties, and makes no representation or warranty as to the accuracy of such information. Efforts are underway to better integrate information from third parties. TI has taken and continues to take reasonable steps to provide representative and accurate information but may not have conducted destructive testing or chemical analysis on incoming materials and chemicals. TI and TI suppliers consider certain information to be proprietary, and thus CAS numbers and other limited information may not be available for release.

In no event shall TI's liability arising out of such information exceed the total purchase price of the TI part(s) at issue in this document sold by TI to Customer on an annual basis.

TAPE AND REEL INFORMATION

QUADRANT ASSIGNMENTS FOR PIN 1 ORIENTATION IN TAPE

*All dimensions are nominal

Device	Package Type	Package Drawing	Pins	SPQ	Reel Diameter (mm)	Reel Width W1 (mm)	A0 (mm)	B0 (mm)	K0 (mm)	P1 (mm)	W (mm)	Pin1 Quadrant
INA310A1IDGKR	VSSOP	DGK	8	2500	330.0	12.4	5.3	3.4	1.4	8.0	12.0	Q1
INA310A2IDGKR	VSSOP	DGK	8	2500	330.0	12.4	5.3	3.4	1.4	8.0	12.0	Q1
INA310A3IDGKR	VSSOP	DGK	8	2500	330.0	12.4	5.3	3.4	1.4	8.0	12.0	Q1
INA310A4IDGKR	VSSOP	DGK	8	2500	330.0	12.4	5.3	3.4	1.4	8.0	12.0	Q1
INA310A5IDGKR	VSSOP	DGK	8	2500	330.0	12.4	5.3	3.4	1.4	8.0	12.0	Q1
INA310B1IDGKR	VSSOP	DGK	8	2500	330.0	12.4	5.3	3.4	1.4	8.0	12.0	Q1
INA310B2IDGKR	VSSOP	DGK	8	2500	330.0	12.4	5.3	3.4	1.4	8.0	12.0	Q1
INA310B3IDGKR	VSSOP	DGK	8	2500	330.0	12.4	5.3	3.4	1.4	8.0	12.0	Q1
INA310B4IDGKR	VSSOP	DGK	8	2500	330.0	12.4	5.3	3.4	1.4	8.0	12.0	Q1
INA310B5IDGKR	VSSOP	DGK	8	2500	330.0	12.4	5.3	3.4	1.4	8.0	12.0	Q1

TAPE AND REEL BOX DIMENSIONS



*All dimensions are nominal

Device	Package Type	Package Drawing	Pins	SPQ	Length (mm)	Width (mm)	Height (mm)
INA310A1IDGKR	VSSOP	DGK	8	2500	356.0	356.0	35.0
INA310A2IDGKR	VSSOP	DGK	8	2500	356.0	356.0	35.0
INA310A3IDGKR	VSSOP	DGK	8	2500	356.0	356.0	35.0
INA310A4IDGKR	VSSOP	DGK	8	2500	356.0	356.0	35.0
INA310A5IDGKR	VSSOP	DGK	8	2500	356.0	356.0	35.0
INA310B1IDGKR	VSSOP	DGK	8	2500	356.0	356.0	35.0
INA310B2IDGKR	VSSOP	DGK	8	2500	356.0	356.0	35.0
INA310B3IDGKR	VSSOP	DGK	8	2500	356.0	356.0	35.0
INA310B4IDGKR	VSSOP	DGK	8	2500	356.0	356.0	35.0
INA310B5IDGKR	VSSOP	DGK	8	2500	356.0	356.0	35.0

DGK0008A



PACKAGE OUTLINE

VSSOP - 1.1 mm max height

SMALL OUTLINE PACKAGE



4214862/A 04/2023

NOTES:

PowerPAD is a trademark of Texas Instruments.

1. All linear dimensions are in millimeters. Any dimensions in parenthesis are for reference only. Dimensioning and tolerancing per ASME Y14.5M.
2. This drawing is subject to change without notice.
3. This dimension does not include mold flash, protrusions, or gate burrs. Mold flash, protrusions, or gate burrs shall not exceed 0.15 mm per side.
4. This dimension does not include interlead flash. Interlead flash shall not exceed 0.25 mm per side.
5. Reference JEDEC registration MO-187.

EXAMPLE BOARD LAYOUT

DGK0008A

™ VSSOP - 1.1 mm max height

SMALL OUTLINE PACKAGE



LAND PATTERN EXAMPLE
EXPOSED METAL SHOWN
SCALE: 15X



SOLDER MASK DETAILS

4214862/A 04/2023

NOTES: (continued)

6. Publication IPC-7351 may have alternate designs.
7. Solder mask tolerances between and around signal pads can vary based on board fabrication site.
8. Vias are optional depending on application, refer to device data sheet. If any vias are implemented, refer to their locations shown on this view. It is recommended that vias under paste be filled, plugged or tented.
9. Size of metal pad may vary due to creepage requirement.

EXAMPLE STENCIL DESIGN

DGK0008A

TM VSSOP - 1.1 mm max height

SMALL OUTLINE PACKAGE



SOLDER PASTE EXAMPLE
SCALE: 15X

4214862/A 04/2023

NOTES: (continued)

11. Laser cutting apertures with trapezoidal walls and rounded corners may offer better paste release. IPC-7525 may have alternate design recommendations.
12. Board assembly site may have different recommendations for stencil design.

IMPORTANT NOTICE AND DISCLAIMER

TI PROVIDES TECHNICAL AND RELIABILITY DATA (INCLUDING DATA SHEETS), DESIGN RESOURCES (INCLUDING REFERENCE DESIGNS), APPLICATION OR OTHER DESIGN ADVICE, WEB TOOLS, SAFETY INFORMATION, AND OTHER RESOURCES "AS IS" AND WITH ALL FAULTS, AND DISCLAIMS ALL WARRANTIES, EXPRESS AND IMPLIED, INCLUDING WITHOUT LIMITATION ANY IMPLIED WARRANTIES OF MERCHANTABILITY, FITNESS FOR A PARTICULAR PURPOSE OR NON-INFRINGEMENT OF THIRD PARTY INTELLECTUAL PROPERTY RIGHTS.

These resources are intended for skilled developers designing with TI products. You are solely responsible for (1) selecting the appropriate TI products for your application, (2) designing, validating and testing your application, and (3) ensuring your application meets applicable standards, and any other safety, security, regulatory or other requirements.

These resources are subject to change without notice. TI grants you permission to use these resources only for development of an application that uses the TI products described in the resource. Other reproduction and display of these resources is prohibited. No license is granted to any other TI intellectual property right or to any third party intellectual property right. TI disclaims responsibility for, and you will fully indemnify TI and its representatives against, any claims, damages, costs, losses, and liabilities arising out of your use of these resources.

TI's products are provided subject to [TI's Terms of Sale](#) or other applicable terms available either on [ti.com](https://www.ti.com) or provided in conjunction with such TI products. TI's provision of these resources does not expand or otherwise alter TI's applicable warranties or warranty disclaimers for TI products.

TI objects to and rejects any additional or different terms you may have proposed.

Mailing Address: Texas Instruments, Post Office Box 655303, Dallas, Texas 75265
Copyright © 2024, Texas Instruments Incorporated