

# ISOM811x 3.75kV<sub>RMS</sub>, Single-Channel Opto-Emulator With Analog Transistor Output

## 1 Features

- Footprint compatible, pin-to-pin upgrade to industry-standard phototransistor optocouplers
- 1-channel LED-emulator input
- Current transfer ratio (CTR) at  $I_F = 5\text{mA}$ ,  $V_{CE} = 5\text{V}$ :
  - ISOM8110, ISOM8115: 100% to 155%
  - ISOM8111, ISOM8116: 150% to 230%
  - ISOM8112, ISOM8117: 255% to 380%
  - ISOM8113, ISOM8118: 375% to 560%
- High collector-emitter voltage:  $V_{CE}(\text{max}) = 80\text{V}$
- Robust SiO<sub>2</sub> isolation barrier
  - Isolation rating: 3750V<sub>RMS</sub>
  - Working voltage: 500V<sub>RMS</sub>, 707V<sub>PK</sub>
  - Surge capability: up to 10kV
- Temperature range: -55°C to 125°C
- Response time: 3μs (typical) at  $V_{CE} = 10\text{V}$ ,  $I_C = 2\text{mA}$ ,  $R_L = 100\Omega$
- Safety-related certifications planned:
  - UL 1577 recognition, 3750V<sub>RMS</sub> isolation
  - DIN EN IEC 60747-17 (VDE 0884-17) conformity per VDE
  - IEC 62368-1, IEC 61010-1 certifications
  - CQC GB 4943.1 certification

## 2 Applications

- [Switching power supply](#)
- [Programmable Logic Controller \(PLC\)](#)
- [Factory automation & control](#)
- [Data acquisition](#)
- [Motor drive I/O and position feedback](#)

## 3 Description

The ISOM811x devices are single-channel optocoupler-emulators with LED-emulator input and transistor output. The devices are footprint compatible and pin-to-pin upgrades for many traditional optocouplers, allowing enhancement to existing systems with no PCB redesign.

ISOM811x opto-emulators offer significant reliability and performance advantages compared to optocouplers, including high bandwidth, low turn-off delay, low power consumption, wider temperature ranges, flat CTR, and tight process controls resulting in small part-to-part skew. Since there is no aging effect or temperature variation to compensate for, the emulated LED input stage consumes less power than optocouplers.

ISOM811x devices are offered in small SOIC-4 packages with 2.54mm and 1.27mm pin pitches, supporting a 3.75kV<sub>RMS</sub> isolation rating and DC (ISOM811[0-3]) and bidirectional DC (ISOM811[5-8]) input options. The high performance and reliability of ISOM811x enables these devices to be used in power supply feedback design, motor drives, I/O modules in industrial controllers, factory automation applications, and more.

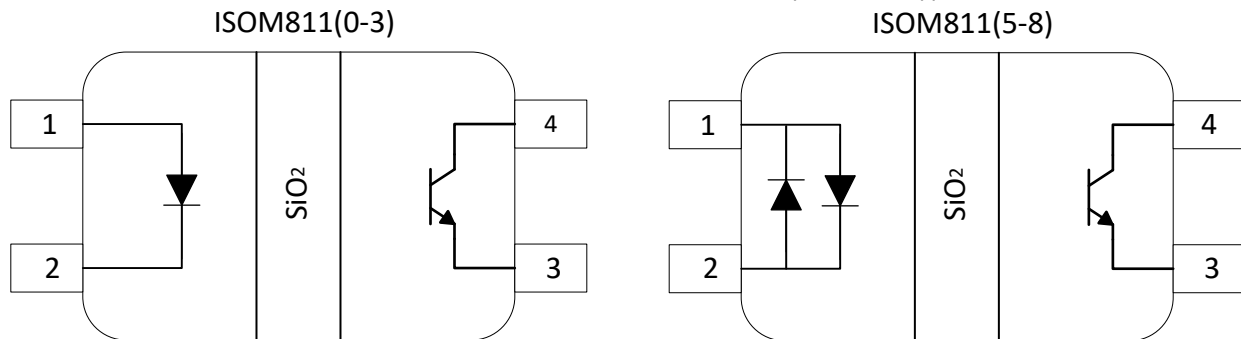
### Package Information

PART NUMBER	PACKAGE <sup>(1)</sup>	PACKAGE SIZE <sup>(3)</sup>	BODY SIZE (NOM)
ISOM811x	SO-4 (DFG)	7.0mm × 3.5mm	4.8mm × 3.5mm
	SO-4 (DFH) <sup>(2)</sup>	7.0mm × 2.7mm	4.8mm × 2.7mm

(1) For more information, see [Section 12](#).

(2) Preview only.

(3) The package size (length × width) is a nominal value and includes pins, where applicable.



Simplified Schematic



## Table of Contents

<b>1 Features</b> .....	1	8.2 Functional Block Diagram.....	17
<b>2 Applications</b> .....	1	8.3 Feature Description.....	18
<b>3 Description</b> .....	1	8.4 Device Functional Modes.....	18
<b>4 Device Comparison</b> .....	3	<b>9 Application and Implementation</b> .....	19
<b>5 Pin Configuration and Functions</b> .....	3	9.1 Application Information.....	19
<b>6 Specifications</b> .....	4	9.2 Power Supply Recommendations.....	23
6.1 Absolute Maximum Ratings.....	4	9.3 Layout.....	23
6.2 ESD Ratings.....	4	<b>10 Device and Documentation Support</b> .....	24
6.3 Thermal Information.....	4	10.1 Documentation Support.....	24
6.4 Insulation Specifications.....	5	10.2 Receiving Notification of Documentation Updates..	24
6.5 Safety-Related Certifications.....	6	10.3 Support Resources.....	24
6.6 Safety Limiting Values.....	6	10.4 Trademarks.....	24
6.7 Electrical Characteristics.....	7	10.5 Electrostatic Discharge Caution.....	24
6.8 Switching Characteristics.....	9	10.6 Glossary.....	24
6.9 Typical Characteristics.....	11	<b>11 Revision History</b> .....	24
<b>7 Parameter Measurement Information</b> .....	16	<b>12 Mechanical, Packaging, and Orderable Information</b> .....	24
<b>8 Detailed Description</b> .....	17		
8.1 Overview.....	17		

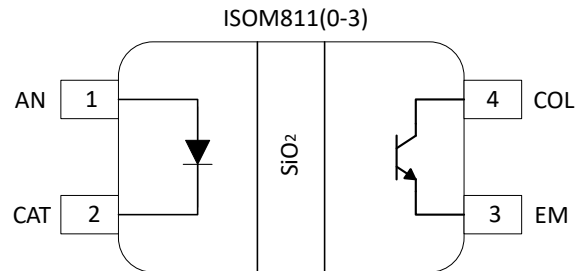
## 4 Device Comparison

**Table 4-1. Device Selection**

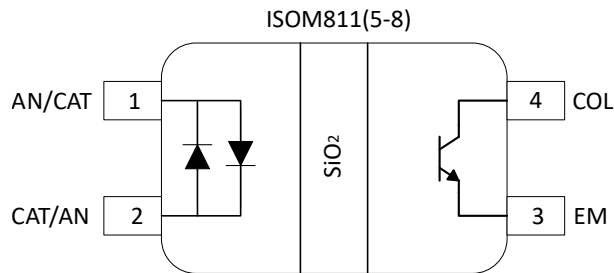
PART NUMBER	CTR	PACKAGE <sup>(1)</sup>	PIN PITCH
ISOM8110, ISOM8115	100% to 155%	4-pin SOIC (DFG), 4-pin SOIC (DFH)	2.54mm, 1.27mm
ISOM8111, ISOM8116	150% to 230%		
ISOM8112, ISOM8117	255% to 380%		
ISOM8113, ISOM8118	375% to 560%		

(1) DFH package is preview only.

## 5 Pin Configuration and Functions



**Figure 5-1. ISOM811[0-3] 4-Pin SOIC (Top View)**



**Figure 5-2. ISOM811[5-8] 4-Pin SOIC (Top View)**

**Table 5-1. Pin Functions**

PIN		TYPE <sup>(1)</sup>	DESCRIPTION
NO.	NAME		
1	AN	I	Anode connection of input LED emulator
2	CAT	I	Cathode connection of input LED emulator
3	EM	O	Emitter for transistor
4	COL	O	Collector for transistor

(1) I = Input, O = Output

## 6 Specifications

### 6.1 Absolute Maximum Ratings

See <sup>(1)</sup> <sup>(2)</sup>

		MIN	MAX	UNIT
$I_{F(max)}$	Maximum Input forward current		50	mA
$V_{CEO}$	Collector-emitter voltage		80	V
$V_{ECO}$	Emitter-collector voltage		7	V
$I_{FP}$	Input pulse forward current (1 $\mu$ s width)		1	A
$V_R$	Input reverse voltage at $I_R = 10\mu A$ <sup>(3)</sup>		7	V
$P_I$	Input power dissipation		140	mW
$I_C$	Collector current		50	mA
$P_C$	Collector power dissipation		150	mW
$P_T$	Total power dissipation		290	mW
$T_A$	Ambient temperature	-55	125	°C
$T_J$	Operating junction temperature		150	°C

- (1) Operation outside the Absolute Maximum Ratings may cause permanent device damage. Absolute Maximum Ratings do not imply functional operation of the device at these or any other conditions beyond those listed under the operational sections of this document. If used outside the listed operational conditions but within the Absolute Maximum Ratings, the device may not be fully functional, and this may affect device reliability, functionality, performance, and shorten the device lifetime.
- (2) All specifications are at  $T_A = 25^\circ C$  unless otherwise noted
- (3) Only applies to ISOM8110, ISOM8112, and ISOM8113

### 6.2 ESD Ratings

			VALUE	UNIT
$V_{(ESD)}$	Electrostatic discharge	Human body model (HBM), per ANSI/ESDA/JEDEC JS-001, all pins <sup>(1)</sup>	$\pm 2000$	V
		Charged device model (CDM), per JEDEC specification JESD22-C101, all pins <sup>(2)</sup>	$\pm 1000$	

- (1) JEDEC document JEP155 states that 500-V HBM allows safe manufacturing with a standard ESD control process.
- (2) JEDEC document JEP157 states that 250-V CDM allows safe manufacturing with a standard ESD control process.

### 6.3 Thermal Information

THERMAL METRIC <sup>(1)</sup>		ISOM811x		UNIT
		DFG (SOIC)	DFH (SOIC)	
		4 PINS	4 PINS	
$R_{\theta JA}$	Junction-to-ambient thermal resistance	283.9	288.8	°C/W
$R_{\theta JC(top)}$	Junction-to-case (top) thermal resistance	173.1	173.6	°C/W
$R_{\theta JB}$	Junction-to-board thermal resistance	201.4	192.9	°C/W
$\Psi_{JT}$	Junction-to-top characterization parameter	125.1	121.5	°C/W
$\Psi_{JB}$	Junction-to-board characterization parameter	198.0	190.0	°C/W

- (1) For more information about traditional and new thermal metrics, see [Semiconductor and IC Package Thermal Metrics](#) application note.

## 6.4 Insulation Specifications

PARAMETER		TEST CONDITIONS	VALUE	UNIT
			4-DFG, 4-DFH	
<b>IEC 60664-1</b>				
CLR	External clearance <sup>(1)</sup>	Side 1 to side 2 distance through air	> 5	mm
CPG	External creepage <sup>(1)</sup>	Side 1 to side 2 distance across package surface	> 5	mm
DTI	Distance through the insulation	Minimum internal gap (internal clearance)	>17	μm
CTI	Comparative tracking index	IEC 60112; UL 746A	>400	V
	Material Group	According to IEC 60664-1	II	
	Overvoltage category per IEC 60664-1	Rated mains voltage ≤ 150 V <sub>RMS</sub>	I-IV	
		Rated mains voltage ≤ 300 V <sub>RMS</sub>	I-IV	
		Rated mains voltage ≤ 600 V <sub>RMS</sub>	I-III	
<b>DIN VDE V 0884-11:2017 <sup>(6)</sup></b>				
V <sub>IORM</sub>	Maximum repetitive peak isolation voltage	AC voltage (bipolar)	707	V <sub>PK</sub>
V <sub>IOWM</sub>	Maximum isolation working voltage	AC voltage (sine wave); time-dependent dielectric breakdown (Tddb) test	500	V <sub>RMS</sub>
		DC voltage	707	V <sub>DC</sub>
V <sub>IOTM</sub>	Maximum transient isolation voltage	V <sub>TEST</sub> = V <sub>IOTM</sub> , t = 60s (qualification); V <sub>TEST</sub> = 1.2 × V <sub>IOTM</sub> , t = 1s (100% production)	5303	V <sub>PK</sub>
V <sub>IMP</sub>	Maximum impulse voltage <sup>(2)</sup>	Tested in air, 1.2/50μs waveform per IEC 62368-1	7200	V <sub>PK</sub>
V <sub>IOSM</sub>	Maximum surge isolation voltage <sup>(3)</sup>	V <sub>IOSM</sub> ≥ 1.3 × V <sub>IMP</sub> ; tested in oil (qualification test), 1.2/50μs waveform per IEC 62368-1	10000	V <sub>PK</sub>
q <sub>pd</sub>	Apparent charge <sup>(4)</sup>	Method a: After I/O safety test subgroup 2/3, V <sub>ini</sub> = V <sub>IOTM</sub> , t <sub>ini</sub> = 60s; V <sub>pd(m)</sub> = 1.2 × V <sub>IORM</sub> , t <sub>m</sub> = 10s	≤ 5	pC
		Method a: After environmental tests subgroup 1, V <sub>ini</sub> = V <sub>IOTM</sub> , t <sub>ini</sub> = 60s; V <sub>pd(m)</sub> = 1.6 × V <sub>IORM</sub> , t <sub>m</sub> = 10s	≤ 5	
		Method b: At routine test (100% production) and preconditioning (type test), V <sub>ini</sub> = 1.2 × V <sub>IOTM</sub> , t <sub>ini</sub> = 1s; V <sub>pd(m)</sub> = 1.875 × V <sub>IORM</sub> , t <sub>m</sub> = 1s	≤ 5	
C <sub>IO</sub>	Barrier capacitance, input to output <sup>(5)</sup>	V <sub>IO</sub> = 0.4 × sin (2 πft), f = 1MHz	1	pF
R <sub>IO</sub>	Insulation resistance, input to output <sup>(5)</sup>	V <sub>IO</sub> = 500V, T <sub>A</sub> = 25°C	> 10 <sup>12</sup>	Ω
		V <sub>IO</sub> = 500V, 100°C ≤ T <sub>A</sub> ≤ 125°C	> 10 <sup>11</sup>	
		V <sub>IO</sub> = 500V at T <sub>S</sub> = 150°C	> 10 <sup>9</sup>	
	Pollution degree		2	
	Climatic category		40/125/21	
<b>UL 1577</b>				
V <sub>ISO</sub>	Withstand isolation voltage	V <sub>TEST</sub> = V <sub>ISO</sub> , t = 60s (qualification); V <sub>TEST</sub> = 1.2 × V <sub>ISO</sub> , t = 1s (100% production)	3750	V <sub>RMS</sub>

- (1) Creepage and clearance requirements should be applied according to the specific equipment isolation standards of an application. Care should be taken to maintain the creepage and clearance distance of a board design to ensure that the mounting pads of the isolator on the printed-circuit board do not reduce this distance. Creepage and clearance on a printed-circuit board become equal in certain cases. Techniques such as inserting grooves, ribs, or both on a printed circuit board are used to help increase these specifications.
- (2) Testing is carried out in air to determine the surge immunity of the package.
- (3) Testing is carried out in oil to determine the intrinsic surge immunity of the isolation barrier.
- (4) Apparent charge is electrical discharge caused by a partial discharge (pd).
- (5) All pins on each side of the barrier tied together creating a two-pin device.

- (6) This coupler is suitable for *safe electrical insulation only* within the safety ratings. Compliance with the safety ratings shall be ensured by means of suitable protective circuits.

## 6.5 Safety-Related Certifications

VDE	CSA	UL	CQC	TUV
Plan to certify according to DIN EN IEC 60747-17 (VDE 0884-17)	Plan to certify according to IEC 61010-1, IEC 62368-1 and IEC 60601-1	Plan to certify according to UL 1577 Component Recognition Program	Plan to certify according to GB4943.1-2011	Plan to certify according to EN 61010-1:2010/A1:2019 and EN 62368-1:2014
Certificate planned	Certificate planned	Certificate planned	Certificate planned	Certificate planned

## 6.6 Safety Limiting Values

Safety limiting<sup>(1)</sup> intends to minimize potential damage to the isolation barrier upon failure of input or output circuitry.

PARAMETER		TEST CONDITIONS	MIN	TYP	MAX	UNIT
<b>SO-4 PACKAGE (DFG)</b>						
I <sub>S</sub>	Safety limiting input current	R <sub>θJA</sub> = 283.9°C/W, V <sub>F</sub> = 1.4V, T <sub>J</sub> = 150°C, T <sub>A</sub> = 25°C			300	mA
		R <sub>θJA</sub> = 283.9°C/W, V <sub>CEO</sub> = 40V, T <sub>J</sub> = 150°C, T <sub>A</sub> = 25°C			10.5	mA
		R <sub>θJA</sub> = 283.9°C/W, V <sub>CEO</sub> = 24V, T <sub>J</sub> = 150°C, T <sub>A</sub> = 25°C			17.5	mA
		R <sub>θJA</sub> = 283.9°C/W, V <sub>CEO</sub> = 15V, T <sub>J</sub> = 150°C, T <sub>A</sub> = 25°C			28	mA
P <sub>S</sub>	Safety limiting total power	R <sub>θJA</sub> = 283.9°C/W, T <sub>J</sub> = 150°C, T <sub>A</sub> = 25°C			420	mW
T <sub>S</sub>	Maximum safety temperature				150	°C

- (1) The I<sub>S</sub> and P<sub>S</sub> parameters represent the safety current and safety power respectively. The maximum limits of I<sub>S</sub> and P<sub>S</sub> must not be exceeded. These limits vary with the ambient temperature, T<sub>A</sub>.  
 The junction-to-air thermal resistance, R<sub>θJA</sub>, in the table is that of a device installed on a high-K test board for leaded surface-mount packages. Use these equations to calculate the value for each parameter:  
 $T_J = T_A + R_{\theta JA} \times P$ , where P is the power dissipated in the device.  
 $T_{J(max)} = T_S = T_A + R_{\theta JA} \times P_S$ , where T<sub>J(max)</sub> is the maximum allowed junction temperature.  
 $P_S = I_S \times V_I$ , where V<sub>I</sub> is the maximum input voltage.

## 6.7 Electrical Characteristics

All specifications are at  $T_A = 25^\circ\text{C}$  unless otherwise noted

PARAMETER		TEST CONDITIONS	GPN	MIN	TYP	MAX	UNIT
<b>INPUT</b>							
$V_F$	Input forward voltage	$I_F = 5\text{mA}$	ISOM8110, ISOM8111, ISOM8112, ISOM8113		1.2	1.4	V
$V_F$	Input forward voltage	$I_F = \pm 5\text{mA}$	ISOM8115, ISOM8116, ISOM8117, ISOM8118		1.2	1.5	V
$I_{FT}$	Input forward threshold current		ISOM811x			0.5	mA
$I_R$	Input reverse current	$V_R = 5\text{V}$	ISOM8110, ISOM8111, ISOM8112, ISOM8113			10	$\mu\text{A}$
$C_{IN}$	Input capacitance	At 1MHz, $V_F = 0\text{V}$	ISOM8110, ISOM8111, ISOM8112, ISOM8113		19		pF
$C_{IN}$	Input capacitance	At 1MHz, $V_F = 0\text{V}$	ISOM8115, ISOM8116, ISOM8117, ISOM8118		6		pF
<b>OUTPUT</b>							
$C_{CE}$	Collector-emitter capacitance	1MHz, $V_F = 0\text{V}$	ISOM811x-		10		pF
$V_{CE(SAT)}$	Collector-emitter saturation voltage	$I_F = 20\text{mA}$ , $I_C = 1\text{mA}$	ISOM811x			0.3	V
$I_{C\_DARK}$	Collector dark current	$V_{CE} = 20\text{V}$ , $I_F = 0\text{mA}$	ISOM811x			100	nA
$I_{EC}$	Reverse current	$V_{EC} = 7\text{V}$ , $I_F = 0\text{mA}$	ISOM811x			100	$\mu\text{A}$
$I_{C\_OFF}$	OFF_state collector current	$V_F = 0.7\text{V}$ , $V_{CE} = 48\text{V}$	ISOM811x			10	$\mu\text{A}$
<b>CTR<sup>(1)</sup></b>							
CTR	Current Transfer Ratio	$I_F = 0.5\text{mA}$ , $V_{CE} = 5\text{V}$	ISOM8110	55	130	195	%
			ISOM8115	55	130	195	%
			ISOM8111	80	180	290	%
			ISOM8116	80	180	290	%
			ISOM8112	135	300	480	%
			ISOM8117	135	300	480	%
			ISOM8113	195	440	710	%
CTR	Current Transfer Ratio	$I_F = 2\text{mA}$ , $V_{CE} = 5\text{V}$	ISOM8110	70	120	170	%
			ISOM8115	70	120	170	%
			ISOM8111	110	180	260	%
			ISOM8116	110	180	260	%
			ISOM8112	185	300	430	%
			ISOM8117	185	300	430	%
			ISOM8113	265	440	635	%
ISOM8118	265	440	635	%			

All specifications are at  $T_A = 25^\circ\text{C}$  unless otherwise noted

PARAMETER		TEST CONDITIONS	GPN	MIN	TYP	MAX	UNIT
CTR	Current Transfer Ratio	$I_F = 5\text{mA}, V_{CE} = 5\text{V}$	ISOM8110	100	120	155	%
			ISOM8115	100	120	155	%
			ISOM8111	150	180	230	%
			ISOM8116	150	180	230	%
			ISOM8112	255	300	380	%
			ISOM8117	255	300	380	%
			ISOM8113	375	440	560	%
			ISOM8118	375	440	560	%

(1)  $\text{CTR} (\%) = (I_C / I_F) \times 100\%$



## 6.8 Switching Characteristics

All specifications are at  $T_A = 25^\circ\text{C}$  unless otherwise noted

PARAMETER		TEST CONDITIONS	GPN	MIN	TYP	MAX	UNIT
<b>AC</b>							
$t_r$	Rise time, see <a href="#">Figure 7-2</a> and <a href="#">Figure 7-3</a>	$V_{CC} = 10\text{V}$ , $I_C = 2\text{mA}$ , $R_L = 100\Omega$ , $C_L = 50\text{pF}$	ISOM8110		3.2		$\mu\text{s}$
			ISOM8113		2.5		$\mu\text{s}$
$t_f$	Fall time, see <a href="#">Figure 7-2</a> and <a href="#">Figure 7-3</a>	$V_{CC} = 10\text{V}$ , $I_C = 2\text{mA}$ , $R_L = 100\Omega$ , $C_L = 50\text{pF}$	ISOM8110		4.0		$\mu\text{s}$
			ISOM8113		7.5		$\mu\text{s}$
$T_{ON}$	Turn on time, see <a href="#">Figure 7-2</a> and <a href="#">Figure 7-3</a>	$V_{CC} = 10\text{V}$ , $I_C = 2\text{mA}$ , $R_L = 100\Omega$ , $C_L = 50\text{pF}$	ISOM8110, ISOM8115		5.7		$\mu\text{s}$
			ISOM8111, ISOM8116		4.5		$\mu\text{s}$
			ISOM8112, ISOM8117		6.2		$\mu\text{s}$
			ISOM8113, ISOM8118		16.7		$\mu\text{s}$
		$V_{CC} = 5\text{V}$ , $R_L = 4.7\text{k}\Omega$ , $I_F = 1.6\text{mA}$ , $C_L = 50\text{pF}$	ISOM8110, ISOM8115		3.5		$\mu\text{s}$
			ISOM8111, ISOM8116		2.7		$\mu\text{s}$
			ISOM8112, ISOM8117		2.1		$\mu\text{s}$
			ISOM8113, ISOM8118		1.8		$\mu\text{s}$
		$V_{CC} = 5\text{V}$ , $R_L = 1.9\text{k}\Omega$ , $I_F = 16\text{mA}$ , $C_L = 50\text{pF}$	ISOM8110, ISOM8115		0.62		$\mu\text{s}$
			ISOM8111, ISOM8116		0.56		$\mu\text{s}$
			ISOM8112, ISOM8117		0.48		$\mu\text{s}$
			ISOM8113, ISOM8118		0.44		$\mu\text{s}$

All specifications are at  $T_A = 25^\circ\text{C}$  unless otherwise noted

PARAMETER		TEST CONDITIONS	GPN	MIN	TYP	MAX	UNIT
$T_{\text{OFF}}$	Turn off time, see <a href="#">Figure 7-2</a> and <a href="#">Figure 7-3</a>	$V_{\text{CC}} = 10\text{V}$ , $I_{\text{C}} = 2\text{mA}$ , $R_{\text{L}} = 100\Omega$ , $C_{\text{L}} = 50\text{pF}$	ISOM8110, ISOM8115		3.6		$\mu\text{s}$
			ISOM8111, ISOM8116		3.7		$\mu\text{s}$
			ISOM8112, ISOM8117		3.1		$\mu\text{s}$
			ISOM8113, ISOM8118		2.7		$\mu\text{s}$
		$V_{\text{CC}} = 5\text{V}$ , $R_{\text{L}} = 4.7\text{k}\Omega$ , $I_{\text{F}} = 1.6\text{mA}$ , $C_{\text{L}} = 50\text{pF}$	ISOM8110, ISOM8115		8		$\mu\text{s}$
			ISOM8111, ISOM8116		9		$\mu\text{s}$
			ISOM8112, ISOM8117		11.5		$\mu\text{s}$
			ISOM8113, ISOM8118		13.5		$\mu\text{s}$
		$V_{\text{CC}} = 5\text{V}$ , $R_{\text{L}} = 1.9\text{k}\Omega$ , $I_{\text{F}} = 16\text{mA}$ , $C_{\text{L}} = 50\text{pF}$	ISOM8110, ISOM8115		10		$\mu\text{s}$
			ISOM8111, ISOM8116		11		$\mu\text{s}$
			ISOM8112, ISOM8117		12.3		$\mu\text{s}$
			ISOM8113, ISOM8118		14.5		$\mu\text{s}$
$t_{\text{s}}$	Storage time; time required for the output waveform to change from 0% (100%) to 10% (90%) when input is turned on and back off, see <a href="#">Figure 7-3</a>	$V_{\text{CC}} = 5\text{V}$ , $I_{\text{F}} = 1.6\text{mA}$ , $R_{\text{L}} = 4.7\text{k}\Omega$	ISOM811x			21	$\mu\text{s}$
BW	Bandwidth, see <a href="#">Figure 7-4</a> and <a href="#">Figure 7-5</a>	$V_{\text{IN\_DC}} = 5\text{V}$ , $V_{\text{IN\_AC}} = 1\text{Vpk}$ , $R_{\text{IN}} = 2\text{k}\Omega$ , $V_{\text{CC}} = 5\text{V}$ , $R_{\text{LOAD}} = 100\Omega$ , $C_{\text{L}} = 50\text{pF}$ , measured at $V_{\text{CE}} -3\text{dB}$ sinewave	ISOM811x		680		kHz

## 6.9 Typical Characteristics

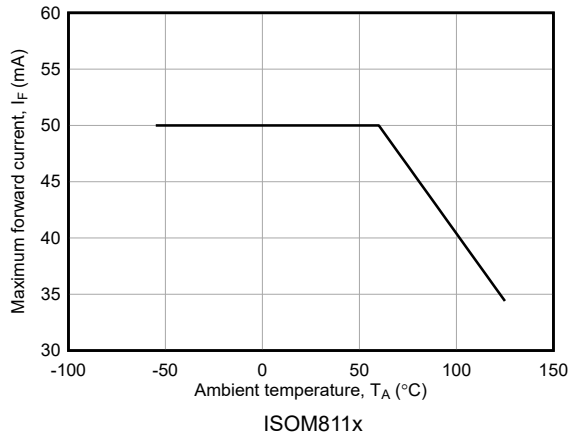


Figure 6-1. Maximum Forward Current vs Ambient Temperature

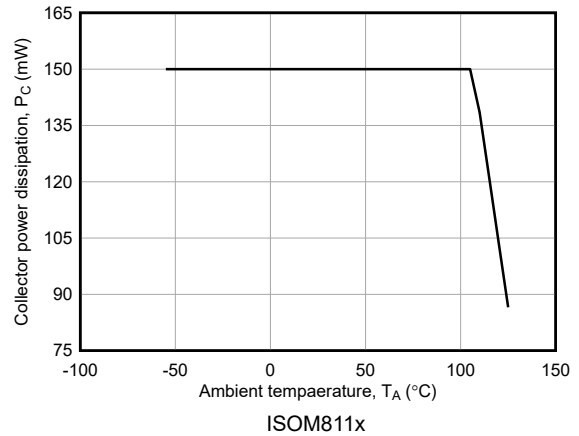


Figure 6-2. Maximum Collector Power Dissipation vs Ambient Temperature

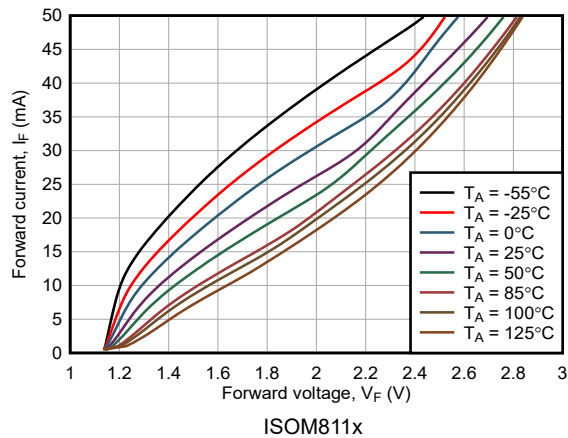


Figure 6-3. Forward Voltage vs Forward Current

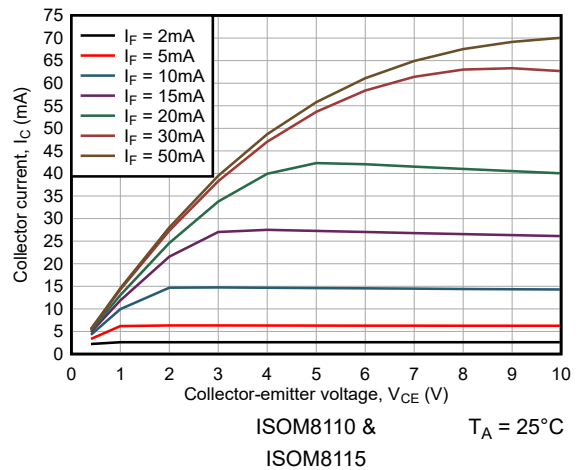


Figure 6-4. Collector Current vs Collector-Emitter Voltage

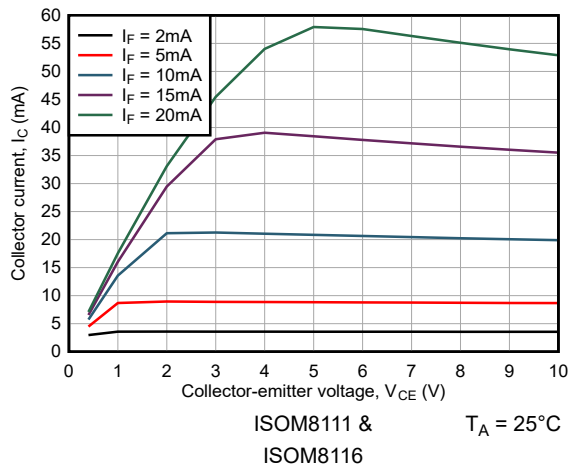


Figure 6-5. Collector Current vs Collector-Emitter Voltage

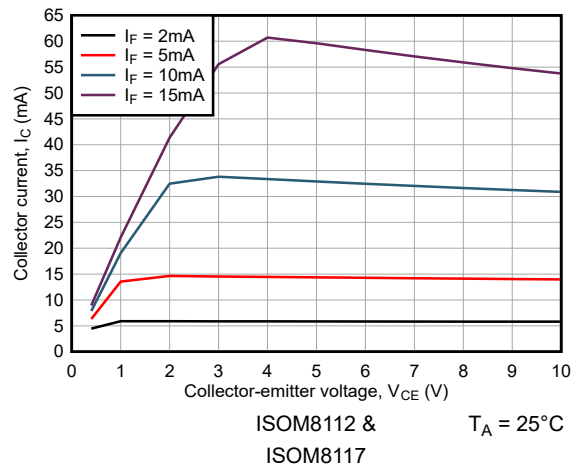
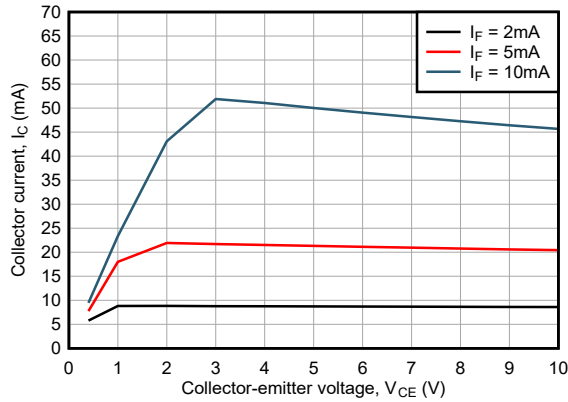
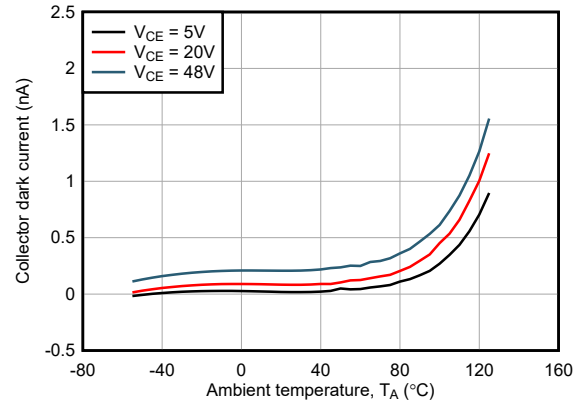


Figure 6-6. Collector Current vs Collector-Emitter Voltage



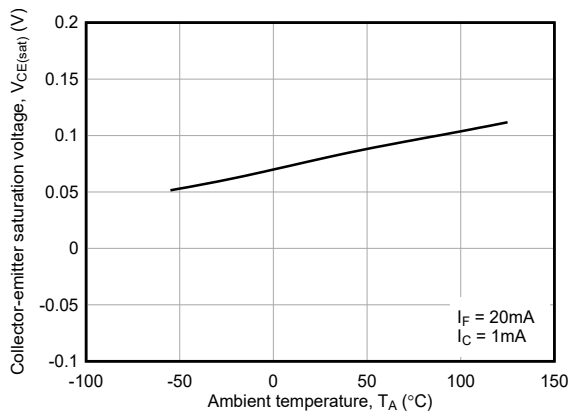
ISOM8113 & ISOM8118  $T_A = 25^\circ\text{C}$

**Figure 6-7. Collector Current vs Collector-Emitter Voltage**



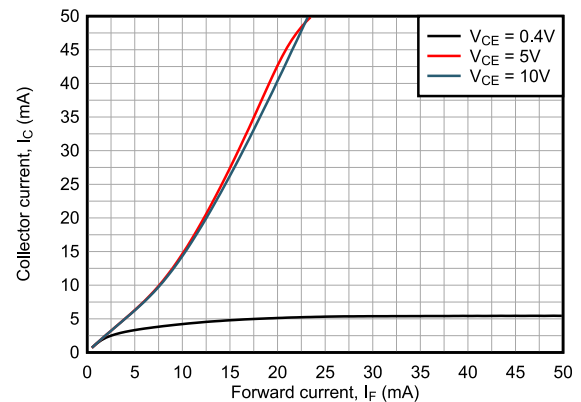
ISOM811x

**Figure 6-8. Collector Dark Current vs Ambient Temperature**



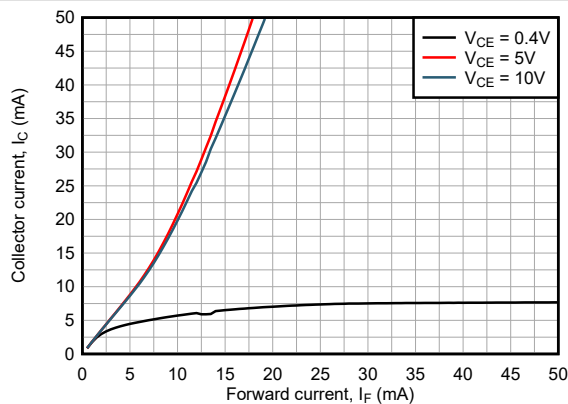
ISOM811x

**Figure 6-9. Collector-Emitter Saturation Voltage vs Ambient Temperature**



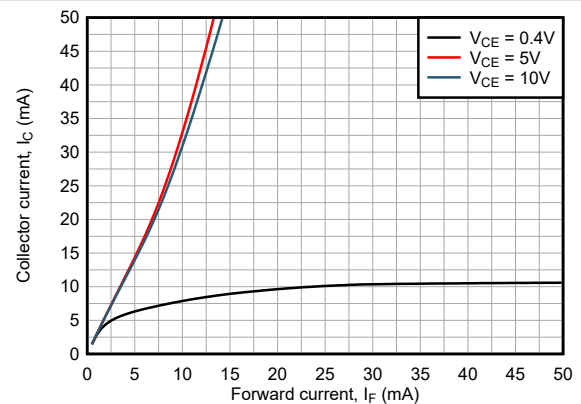
ISOM8110 & ISOM8115  $T_A = 25^\circ\text{C}$

**Figure 6-10. Collector Current vs Forward Current**



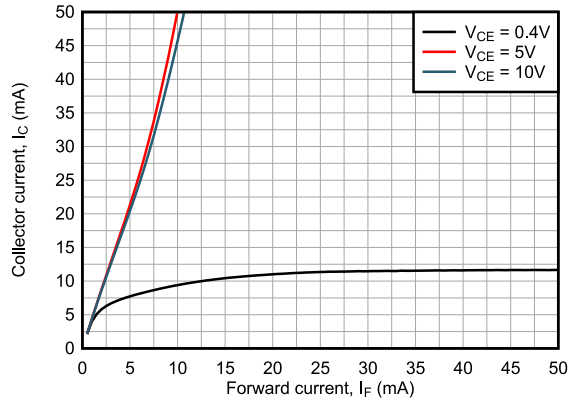
ISOM8111 & ISOM8116  $T_A = 25^\circ\text{C}$

**Figure 6-11. Collector Current vs Forward Current**



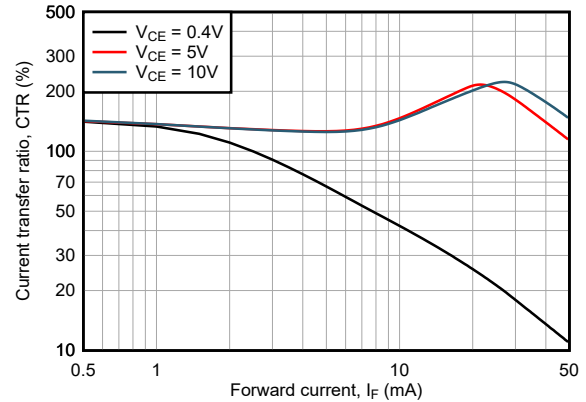
ISOM8112 & ISOM8117  $T_A = 25^\circ\text{C}$

**Figure 6-12. Collector Current vs Forward Current**



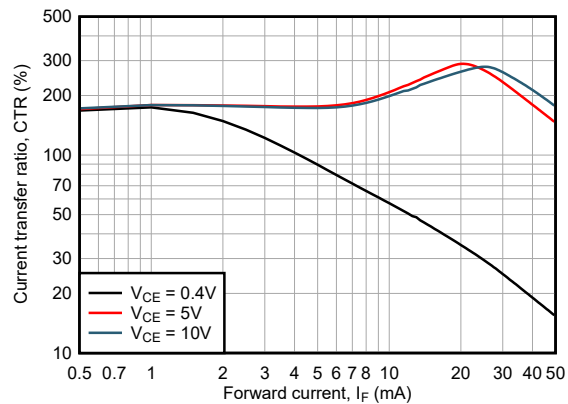
ISOM8113 & ISOM8118  $T_A = 25^\circ\text{C}$

**Figure 6-13. Collector Current vs Forward Current**



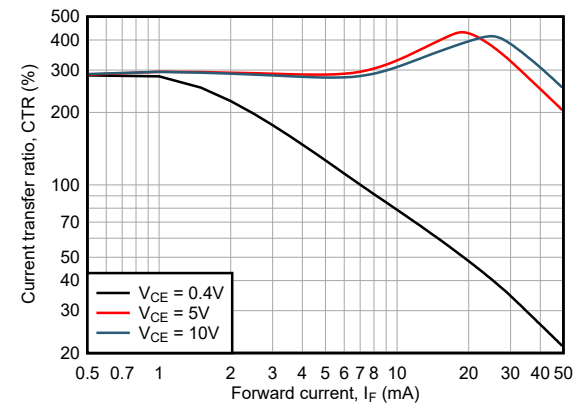
ISOM8110 & ISOM8115  $T_A = 25^\circ\text{C}$

**Figure 6-14. Current Transfer Ratio vs Forward Current**



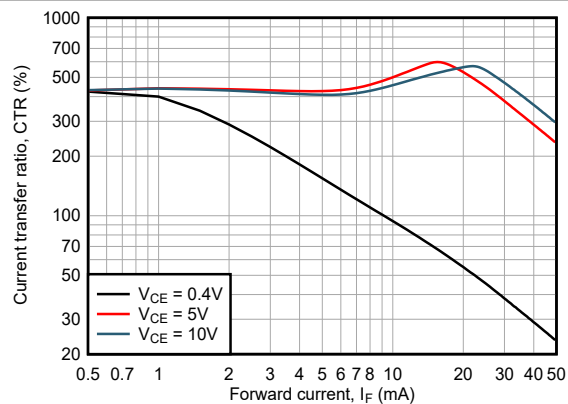
ISOM8111 & ISOM8116  $T_A = 25^\circ\text{C}$

**Figure 6-15. Current Transfer Ratio vs Forward Current**



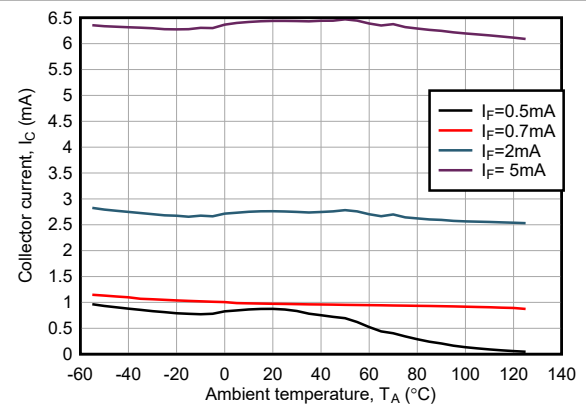
ISOM8112 & ISOM8117  $T_A = 25^\circ\text{C}$

**Figure 6-16. Current Transfer Ratio vs Forward Current**



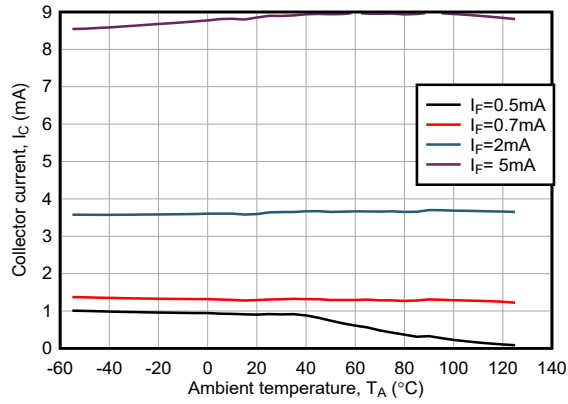
ISOM8113 & ISOM8118  $T_A = 25^\circ\text{C}$

**Figure 6-17. Current Transfer Ratio vs Forward Current**



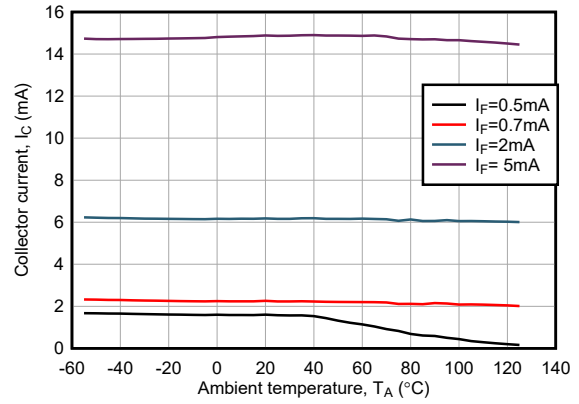
ISOM8110 & ISOM8115  $V_{CE} = 5\text{V}$

**Figure 6-18. Collector Current vs Ambient Temperature**



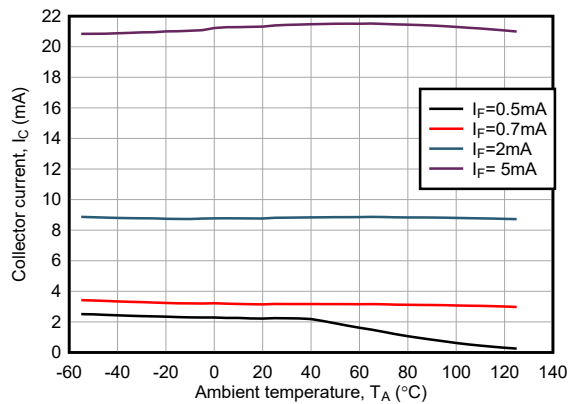
ISOM8111 & ISOM8116  $V_{CE} = 5V$

**Figure 6-19. Collector Current vs Ambient Temperature**



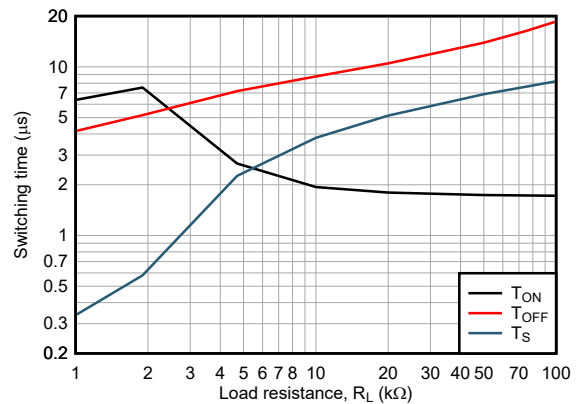
ISOM8112 & ISOM8117  $V_{CE} = 5V$

**Figure 6-20. Collector Current vs Ambient Temperature**



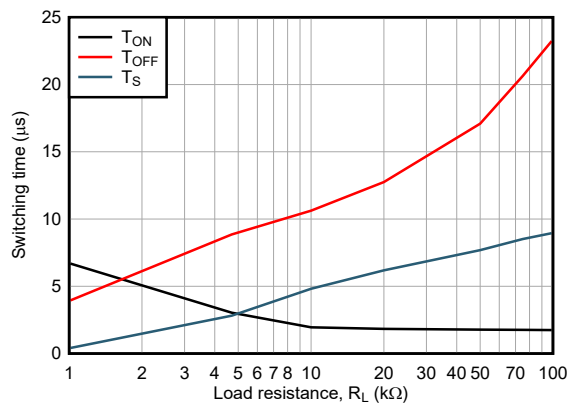
ISOM8113 & ISOM8118  $V_{CE} = 5V$

**Figure 6-21. Collector Current vs Ambient Temperature**



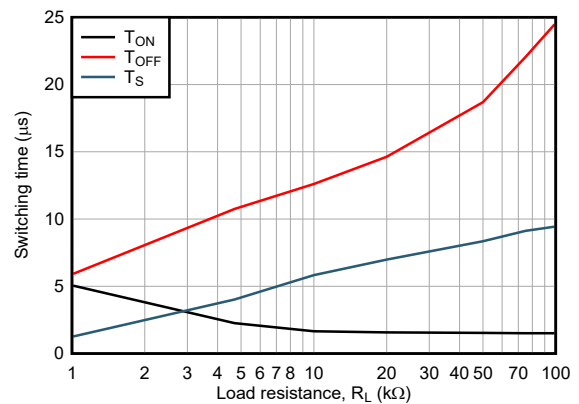
$I_F = 1.6mA$  ISOM8110 & ISOM8115  $V_{CC} = 5V$

**Figure 6-22. Switching Time vs Load Resistance**



$I_F = 1.6mA$  ISOM8111 & ISOM8116  $V_{CC} = 5V$

**Figure 6-23. Switching Time vs Load Resistance**



$I_F = 1.6mA$  ISOM8112 & ISOM8117  $V_{CC} = 5V$

**Figure 6-24. Switching Time vs Load Resistance**

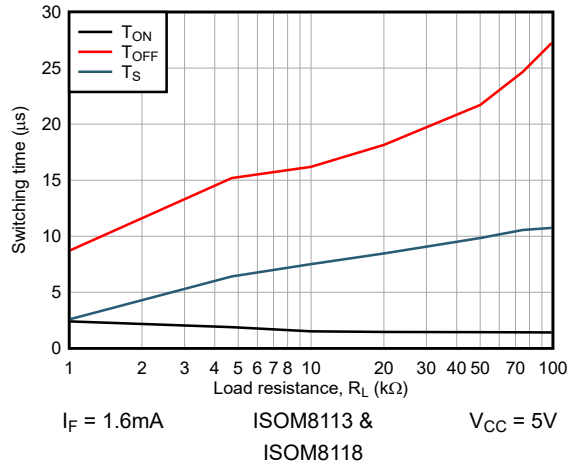


Figure 6-25. Switching Time vs Load Resistance

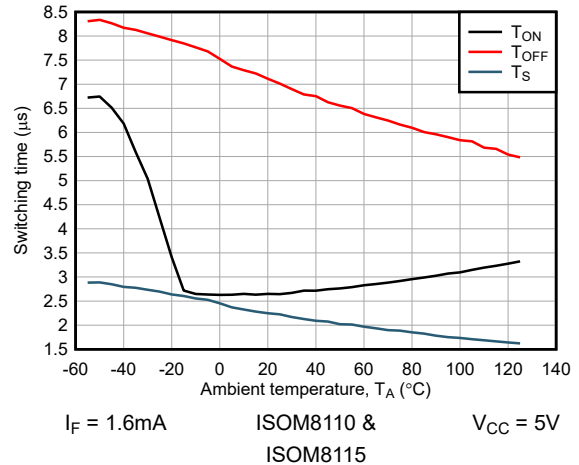


Figure 6-26. Switching Time vs Ambient Temperature

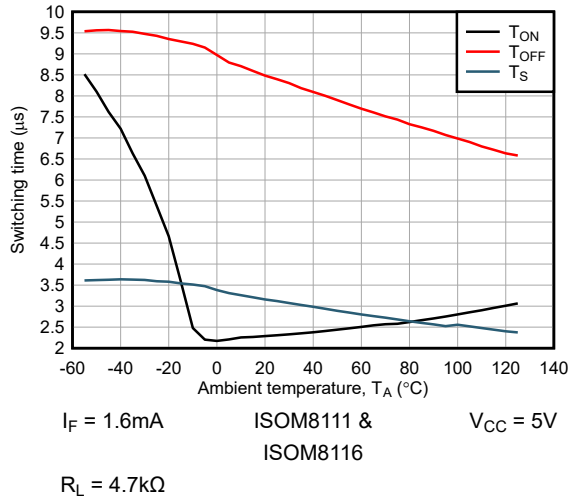


Figure 6-27. Switching Time vs Ambient Temperature

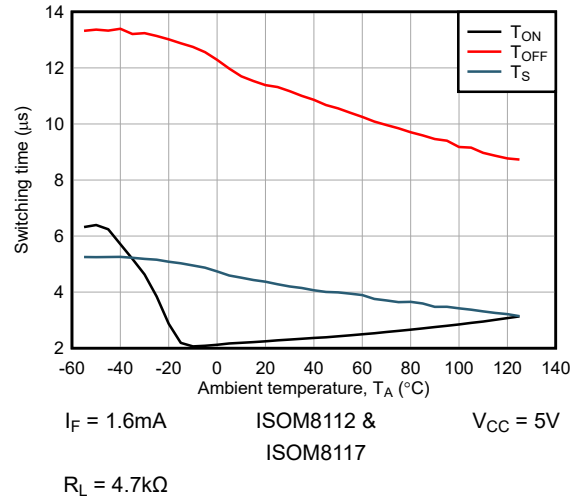


Figure 6-28. Switching Time vs Ambient Temperature

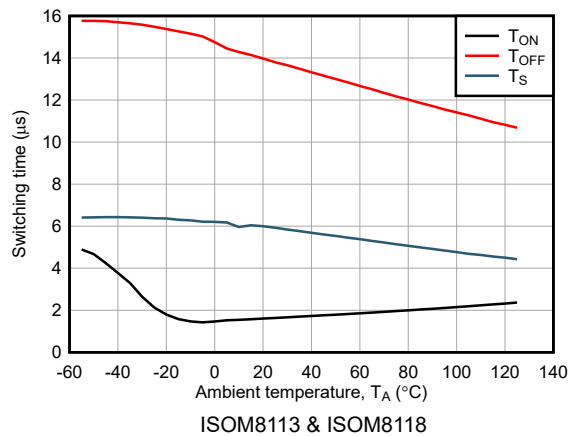


Figure 6-29. Switching Time vs Ambient Temperature

## 7 Parameter Measurement Information

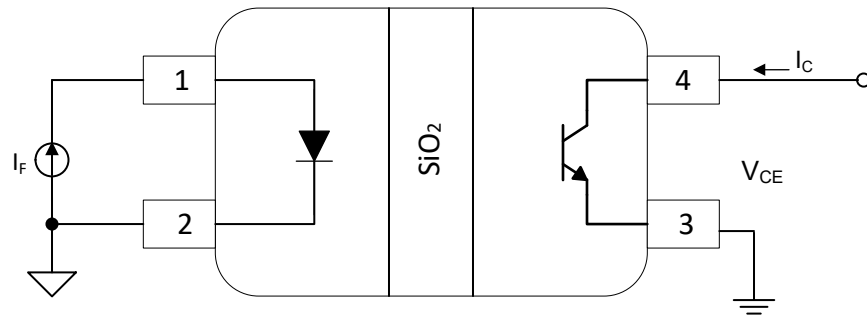


Figure 7-1. ISOM811x Test Circuit for CTR

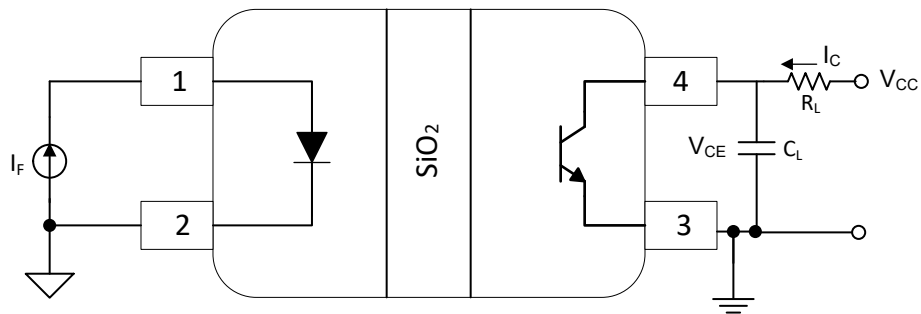


Figure 7-2. ISOM811x Test Circuit for Switching Timing

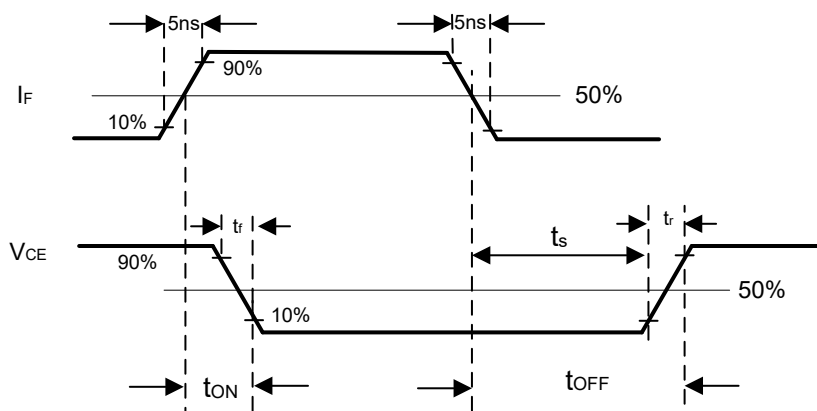


Figure 7-3. ISOM811x Switching Timing Waveforms

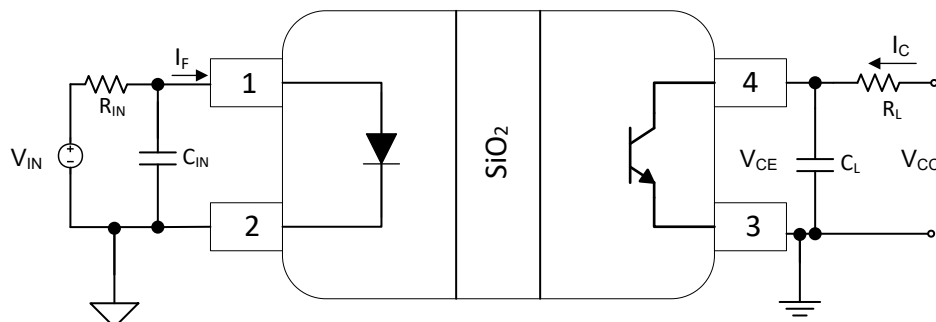


Figure 7-4. ISOM811[0-3] Test Circuit for Bandwidth



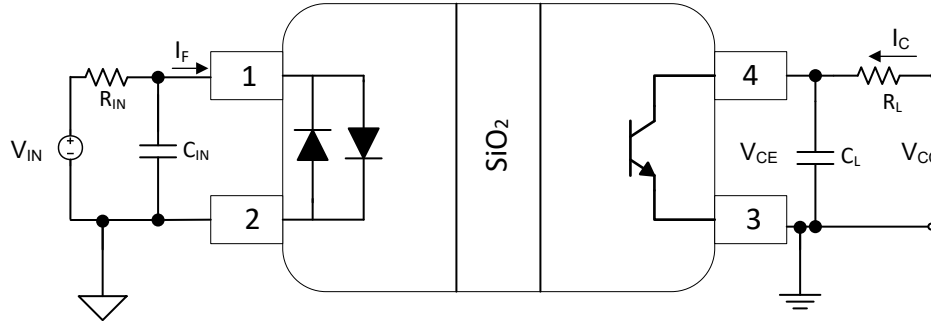


Figure 7-5. ISOM811[5-8] Test Circuit for Bandwidth

## 8 Detailed Description

### 8.1 Overview

The ISOM811x opto-emulators are single-channel, pin-to-pin upgrades for many traditional optocouplers. While standard optocouplers use an LED as the input stage, ISOM811x uses an emulated LED as the input stage. The input and output stages are isolated by TI's proprietary silicon dioxide-based ( $\text{SiO}_2$ ) isolation barrier. This isolation technology makes ISOM811x resistant to the wear-out effects found in optocouplers that degrade performance with increasing temperature, forward current, and device age. Ordering options include four different ranges of current transfer ratio (CTR) and input options supporting uni-polar and bi-polar DC flow.

The ISOM811x family of devices isolate DC and bidirectional DC signals and offer performance, reliability, and flexibility advantages not available with traditional optocouplers.

The functional block diagram of ISOM811x devices are shown in Section 8.2. The input signal is transmitted across the isolation barrier using an on-off keying (OOK) modulation scheme. The transmitter sends a high-frequency carrier across the barrier that contains information on how much current is flowing through the input pins. The receiver demodulates the signal after advanced signal conditioning and produces the signal through the output stage. These devices also incorporate advanced circuit techniques to maximize bandwidth and minimize radiated emissions. Figure 8-3 shows conceptual details of how the OOK scheme works.

### 8.2 Functional Block Diagram

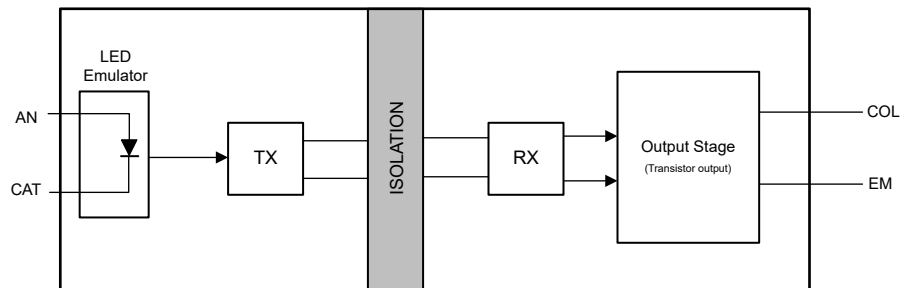


Figure 8-1. Conceptual Block Diagram of an Opto-emulator ISOM811[0-3]

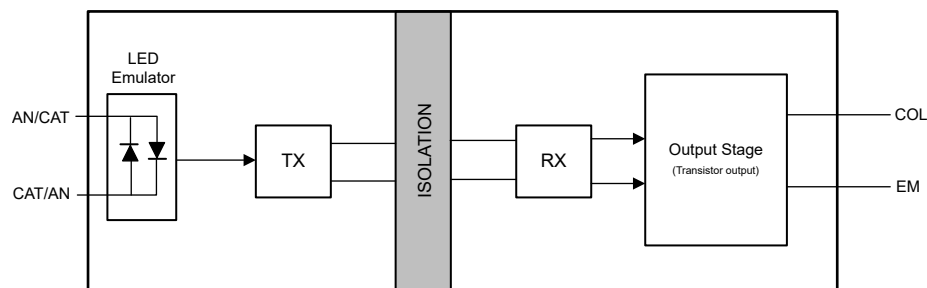
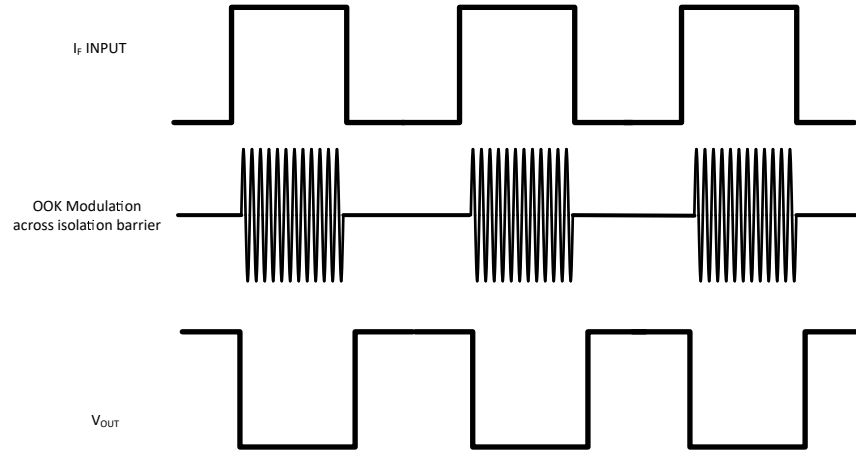


Figure 8-2. Conceptual Block Diagram of an Opto-emulator ISOM811[5-8]



**Figure 8-3. On-off Keying (OOK) Based Modulation Scheme**

### 8.3 Feature Description

The ISOM811x devices isolate DC and bidirectional DC signals. ISOM811x has an open-collector output with multiple CTR options. All devices support an isolation withstand voltage of 3750V<sub>RMS</sub> between side 1 and side 2.

### 8.4 Device Functional Modes

Table 8-1 lists the functional modes for the ISOM811x devices.

**Table 8-1. Function Table**

CTR <sup>1</sup>	PART NUMBER	Input type
100% to 155%	ISOM8110	DC
	ISOM8115	Bidirectional DC
150% to 230%	ISOM8111	DC
	ISOM8116	Bidirectional DC
255% to 380%	ISOM8112	DC
	ISOM8117	Bidirectional DC
375% to 560%	ISOM8113	DC
	ISOM8118	Bidirectional DC

1.  $I_F = 5\text{mA}$ ,  $T_A = 25^\circ\text{C}$ ,  $V_{CE} = 5\text{V}$ .

## 9 Application and Implementation

---

### Note

Information in the following applications sections is not part of the TI component specification, and TI does not warrant its accuracy or completeness. TI's customers are responsible for determining suitability of components for their purposes, as well as validating and testing their design implementation to confirm system functionality.

---

### 9.1 Application Information

The ISOM811x devices are single-channel opto-emulators with LED-emulator input and transistor output. The devices use on-off keying modulation to transmit data across the isolation barrier. The input stage is isolated from the driver stage by TI's proprietary silicon dioxide-based ( $\text{SiO}_2$ ) isolation barrier which provides robust isolation. With wider temperature ratings than traditional optocouplers, ISOM811x opto-emulators can provide reliable signal isolation in harsh environments.

The ISOM811x devices are capable of sinking current when subjected to an external load being connected to the device. Like typical transistor output optocouplers, the output current depends on the input current level ( $I_F$ ) and the current transfer ratio (CTR). With multiple CTR options (100% - 560%), low input current, high bandwidth, low turn-off delay, low power consumption, and wider temperature range, ISOM811x devices are designed for use in a variety of industries such as factory automation, building automation, e-mobility, automotive, avionics, medical, and power delivery.

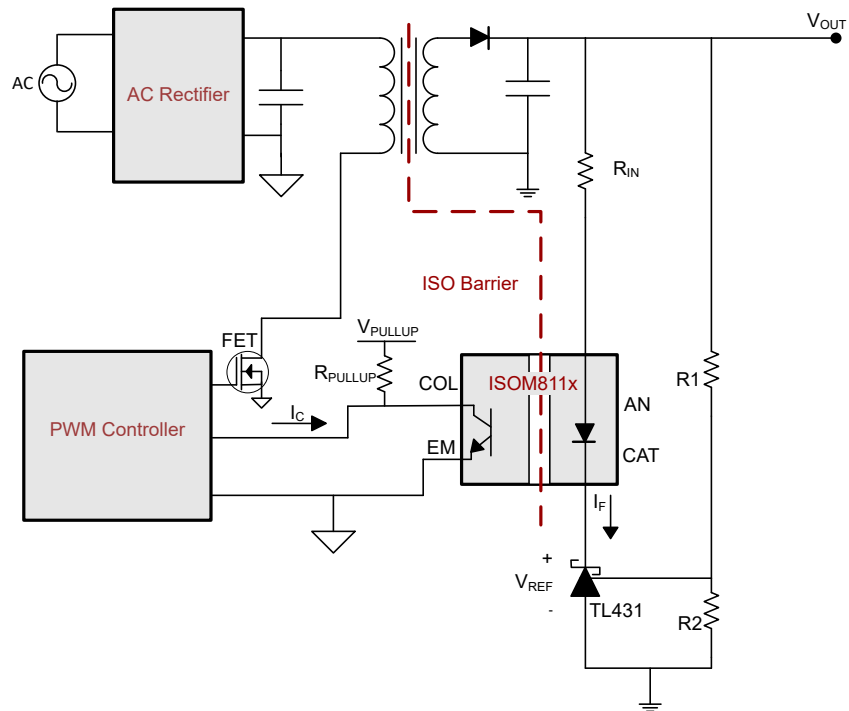
#### 9.1.1 Typical Application

ISOM811x opto-emulators are commonly used in the feedback control loops of isolated power supplies. These devices are used to solve the problem of feeding back current while isolating the primary and secondary domains to regulate the output voltage.

In power supplies, the output voltage is isolated from main input voltage using a transformer (for example: flyback converter). For analog power supply units, the controller IC is usually on the primary side of the transformer. For closed loop control, measuring the output voltage on the secondary side and feeding the voltage back to the controller on the primary is necessary. The most common method of achieving this design is using an opto-emulator such as ISOM811x, error amplifier (commonly TL431), and a voltage comparator to form a feedback loop across the isolation barrier

**Figure 9-1** illustrates a typical isolated power supply. In this implementation, the output voltage is sensed by an error amplifier using the resistor divider (R1 and R2). Depending on the voltage level that the error amplifier senses, the TL431 can drive the current of the ISOM811x higher or lower which is then compared to a voltage reference. The information is passed across the isolation barrier through ISOM811x to the primary side, where the PWM control circuit modulates the power stage to regulate the output voltage. The TL431 and ISOM811x play an important role for stable feedback and control loop.

The ISOM811x devices enable improvements in transient response, reliability, and stability as compared to commonly used optocoupler as the CTR is stable over wide temperature range providing a small, low-cost, highly reliable, and easy-to-design implementation.



**Figure 9-1. Typical Isolated Power Supply Application Using ISOM811x**

### 9.1.1.1 Design Requirements

To design with ISOM811x devices, use the parameters listed in [Table 9-1](#).

**Table 9-1. Design Parameters**

PARAMETER	VALUE
Input forward current range, $I_F$	0.7mA (min), 20mA (max)
Current transfer ratio at $I_F = 5\text{mA}$ , CTR	100% to 155%
Collector current tolerance, $I_C$	50mA (max)
Collector-emitter voltage (saturation), $V_{CE(SAT)}$	0.3V (max)
Input forward voltage, $V_F$	1.2V (typ)

### 9.1.1.2 Detailed Design Procedure

This section presents the design procedure for using the ISOM811x opto-emulators. External components must be selected to operate ISOM811x within the *Recommended Operating Conditions*. The following recommendations on component selection focus on the design of a typical feedback control loop for an isolated flyback converter.

When using an optocoupler in a feedback control loop for an isolated power supply, many variables can affect how to properly use the optocoupler, including the output voltage of the power supply and the type of controller the feedback signal is being sent to. For this example, assume that the output voltage of this power supply,  $V_{OUT}$ , is 5V, and the PWM controller being used has an integrated error amplifier with a COMP pin that acts as the output of this amplifier.

#### 9.1.1.2.1 Sizing $R_{PULLUP}$

The transistor output of ISOM811x operates in active, saturation, reverse, and cut-off regions, just like a regular transistor. To verify that the output does not get damaged when the output is saturated, the minimum value of  $R_{PULLUP}$  can be calculated for a given pull-up voltage,  $V_{PULLUP}$ , in [Equation 1](#):

$$R_{PULLUP} > \frac{V_{PULLUP} - V_{CE(SAT)}}{I_{C(MAX)}} \quad (1)$$

For the example of a feedback loop application, we can calculate the minimum required value for  $R_{PULLUP}$  for a given  $V_{PULLUP}$  of 10V, the maximum output voltage of the error amplifier ( $V_{COMP(MAX)}$ ) of 2.5V, and the maximum output current of the error amplifier is internally clamped at 1.6mA. The equation to calculate  $R_{PULLUP}$  is shown in Equation 2:

$$R_{PULLUP} > \frac{V_{PULLUP} - V_{COMP(MAX)}}{I_{COMP(CLAMP)}} = \frac{10V - 2.5V}{1.6mA} = 4.66k\Omega \quad (2)$$

#### 9.1.1.2.2 Sizing $R_{IN}$

The input side of ISOM811x is current-driven. To limit the amount of current flowing into the AN pin, placing a series resistor,  $R_{IN}$ , in series with the input as shown in Figure 9-1 is recommended.

Depending on how the ISOM811x device is being used, the value of  $R_{IN}$  can vary quite a bit. However, at a high level, to make sure the input does not get damaged, the minimum value of  $R_{IN}$  can be calculated for a given input voltage,  $V_{IN}$ , in Equation 3:

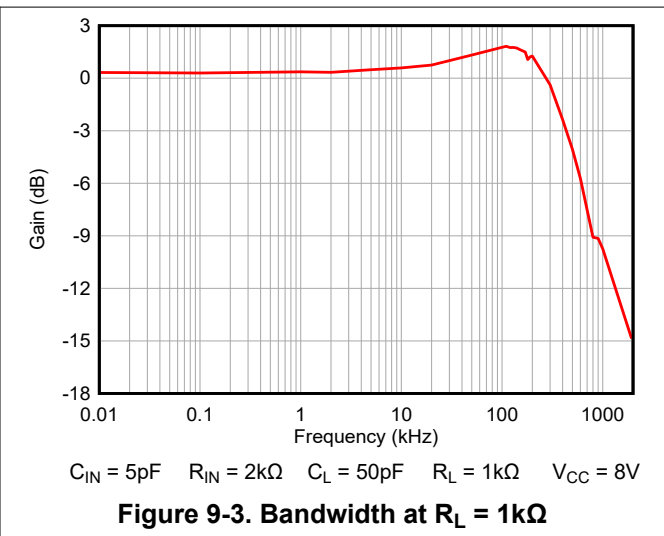
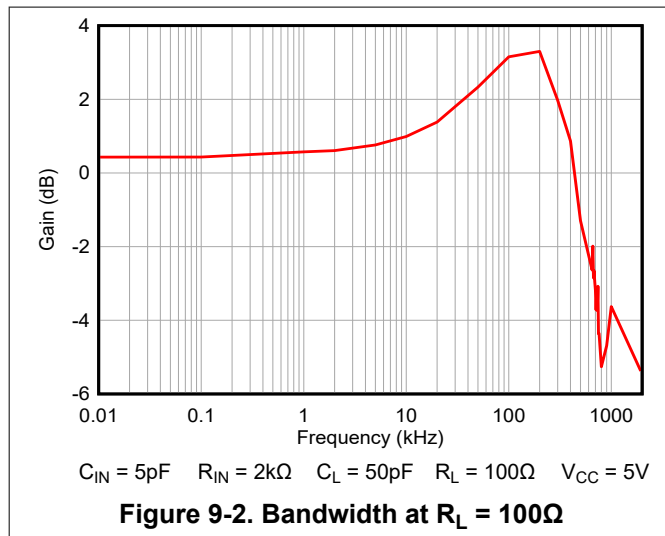
$$R_{IN} > \frac{V_{IN} - V_F}{I_{C(MAX)}} \quad (3)$$

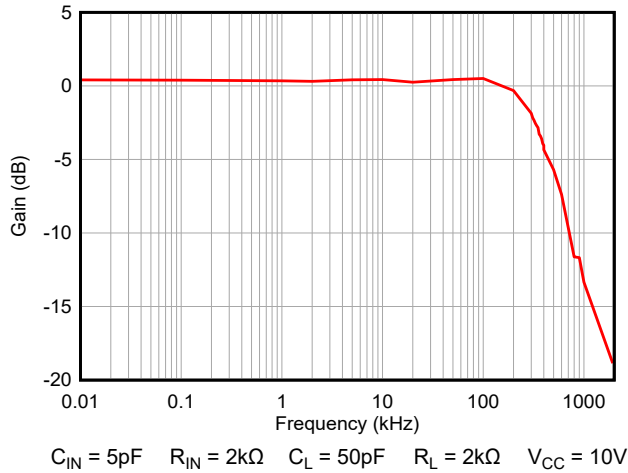
However, in the use case of a feedback loop,  $R_{IN}$  directly affects the mid-band gain of the loop. Assuming that the TL431 has been configured to give a reference voltage,  $V_{REF}$ , of 2.5V and  $R_{PULLUP}$  is 5k $\Omega$ , Equation 4 is used to calculate the maximum value of  $R_{IN}$  verifying that the  $V_{COMP}$  voltage on the primary side can be pulled to the saturation voltage of the ISOM811x,  $V_{CE(SAT)}$ .

$$R_{IN} < \frac{(V_{OUT} - V_{REF} - V_F) \times R_{PULLUP} \times CTR_{MIN}}{V_{PULLUP} - V_{CE(SAT)}} = \frac{(5V - 2.5V - 1.2V) \times 5k\Omega \times 100\%}{10V - 0.3V} = 670\Omega \quad (4)$$

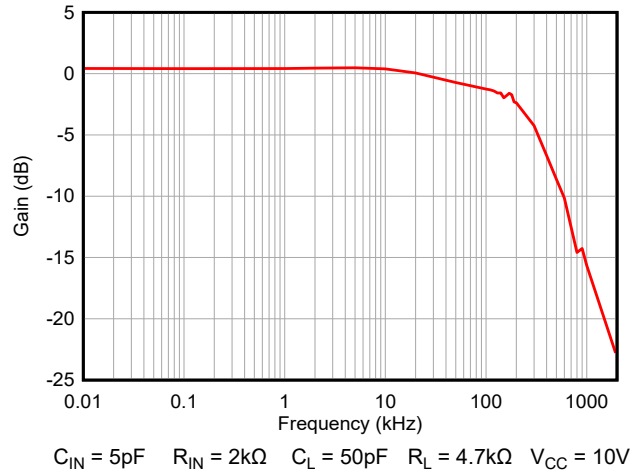
#### 9.1.1.3 Application Curves

The following curves show ISOM8110 bandwidth performance over different loading conditions where  $V_{IN} = 5V_{DC} + 2V_{PK}$ . See Figure 7-4 for setup details.

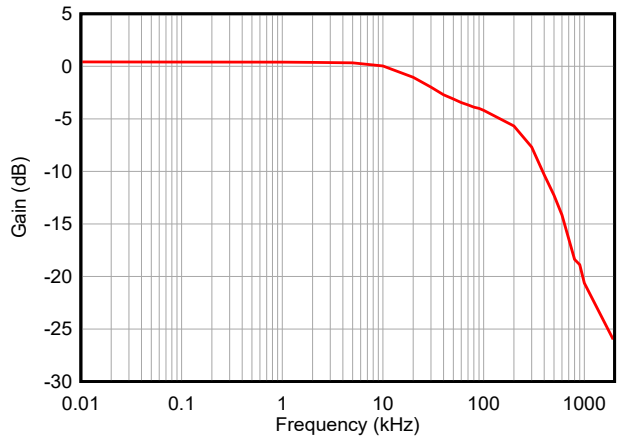




**Figure 9-4. Bandwidth at  $R_L = 2\text{k}\Omega$**



**Figure 9-5. Bandwidth at  $R_L = 4.7\text{k}\Omega$**



$C_{IN} = 5\text{pF}$        $R_{IN} = 2\text{k}\Omega$        $C_L = 50\text{pF}$        $R_L = 10\text{k}\Omega$        $V_{CC} = 45\text{V}$

**Figure 9-6. Bandwidth at  $R_L = 10\text{k}\Omega$**

## 9.2 Power Supply Recommendations

ISOM811x does not require a dedicated power supply to operate since there is no supply pin. Take care to not violate recommended I/O specifications for proper device functionality.

## 9.3 Layout

### 9.3.1 Layout Guidelines

- The device connections to ground must be tied to the PCB ground plane using a direct connection or two vias to help minimize inductance.
- The connections of capacitors and other components to the PCB ground plane must use a direct connection or two vias for minimum inductance.

### 9.3.2 Layout Example

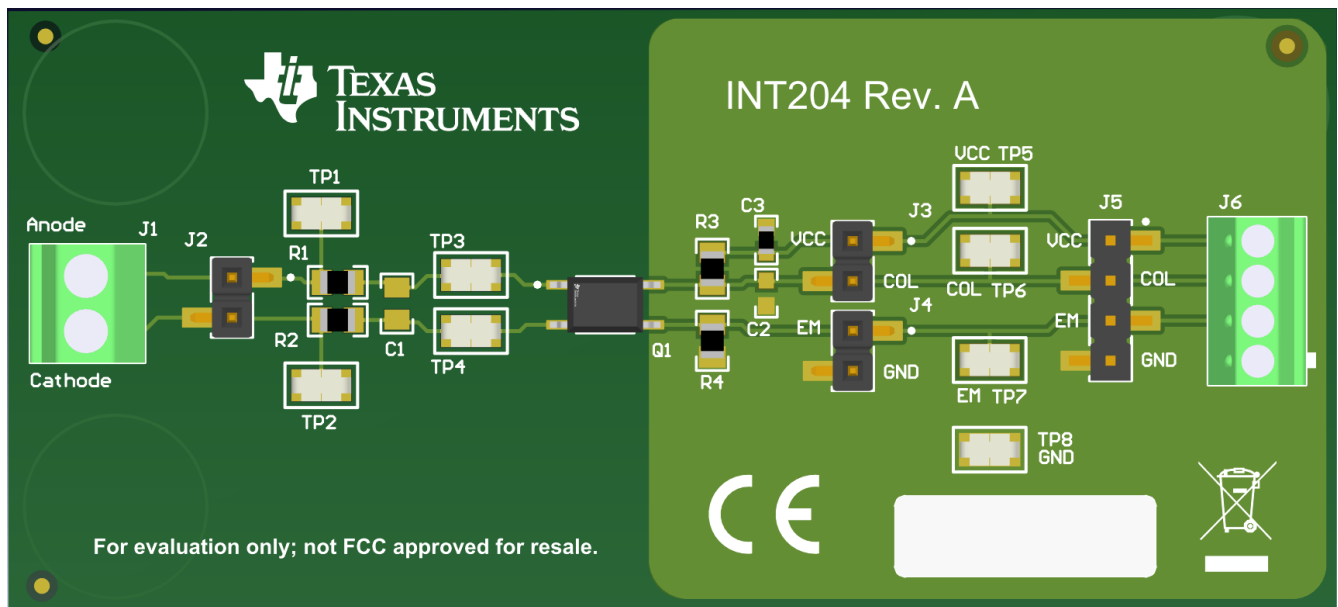


Figure 9-7. Layout Example of ISOM811x With a Single Layer Board

## 10 Device and Documentation Support

### 10.1 Documentation Support

#### 10.1.1 Related Documentation

For related documentation see the following:

- Texas Instruments, [Isolation Glossary](#), application note
- Texas Instruments, [Introduction to Opto-Emulators](#), application note
- Texas Instruments, [ISOM8110 Single-Channel Opto-Emulator with Analog Transistor Output Evaluation Module](#), EVM user's guide

### 10.2 Receiving Notification of Documentation Updates

To receive notification of documentation updates, navigate to the device product folder on [ti.com](#). Click on [Notifications](#) to register and receive a weekly digest of any product information that has changed. For change details, review the revision history included in any revised document.

### 10.3 Support Resources

[TI E2E™ support forums](#) are an engineer's go-to source for fast, verified answers and design help — straight from the experts. Search existing answers or ask your own question to get the quick design help you need.

Linked content is provided "AS IS" by the respective contributors. They do not constitute TI specifications and do not necessarily reflect TI's views; see TI's [Terms of Use](#).

### 10.4 Trademarks

TI E2E™ is a trademark of Texas Instruments.  
All trademarks are the property of their respective owners.

### 10.5 Electrostatic Discharge Caution



This integrated circuit can be damaged by ESD. Texas Instruments recommends that all integrated circuits be handled with appropriate precautions. Failure to observe proper handling and installation procedures can cause damage.

ESD damage can range from subtle performance degradation to complete device failure. Precision integrated circuits may be more susceptible to damage because very small parametric changes could cause the device not to meet its published specifications.

### 10.6 Glossary

[TI Glossary](#) This glossary lists and explains terms, acronyms, and definitions.

## 11 Revision History

NOTE: Page numbers for previous revisions may differ from page numbers in the current version.

Changes from Revision A (December 2023) to Revision B (August 2024)	Page
• Updated the number formatting for figures, tables, and cross-references throughout the document .....	1
• Added <i>Device and Documentation Support</i> section .....	24

## 12 Mechanical, Packaging, and Orderable Information

The following pages include mechanical packaging and orderable information. This information is the most current data available for the designated devices. This data is subject to change without notice and revision of this document. For browser-based versions of this data sheet, refer to the left-hand navigation.

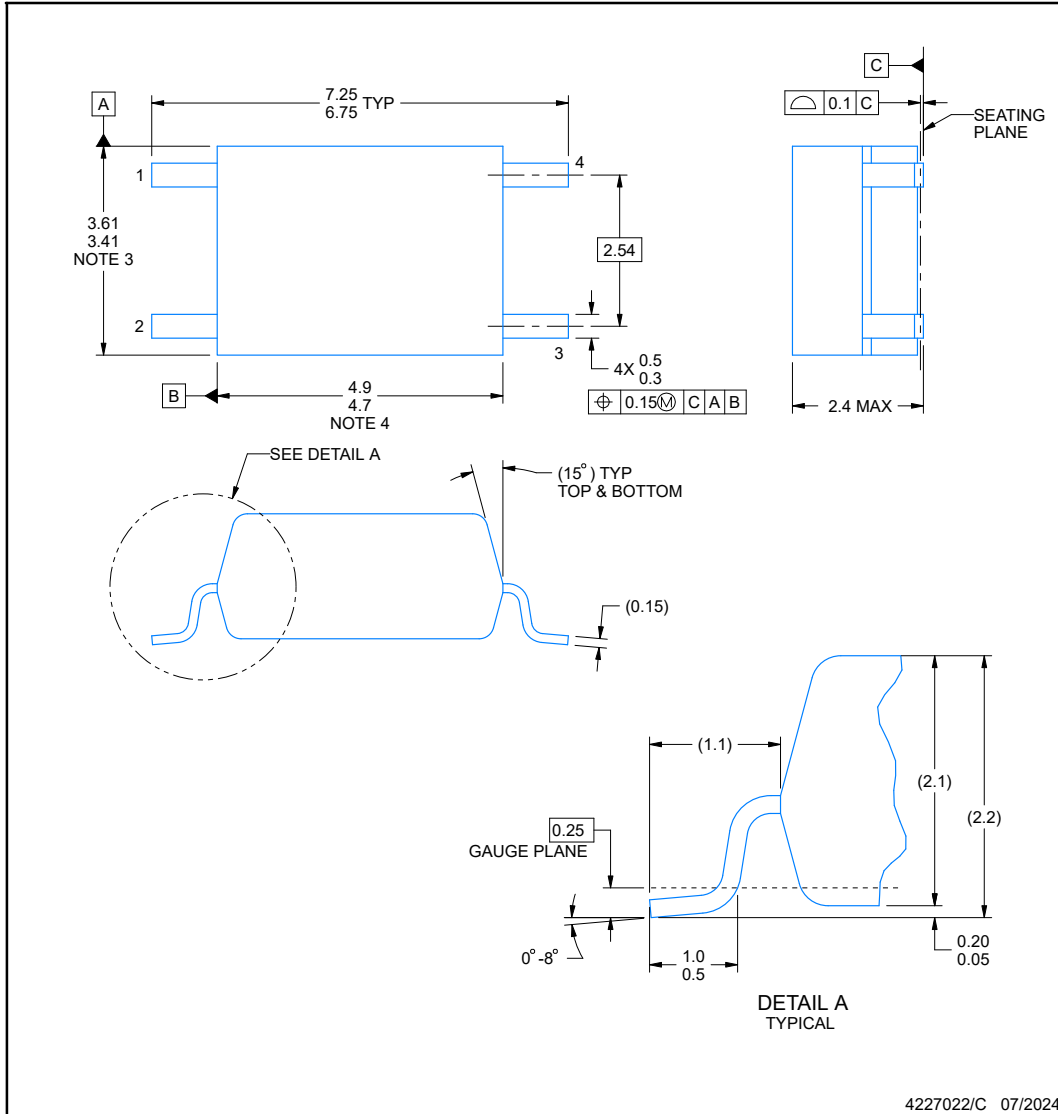




**DFG0004A**

**PACKAGE OUTLINE**  
**SOIC - 2.4 mm max height**

SMALL OUTLINE INTEGRATED CIRCUIT



NOTES:

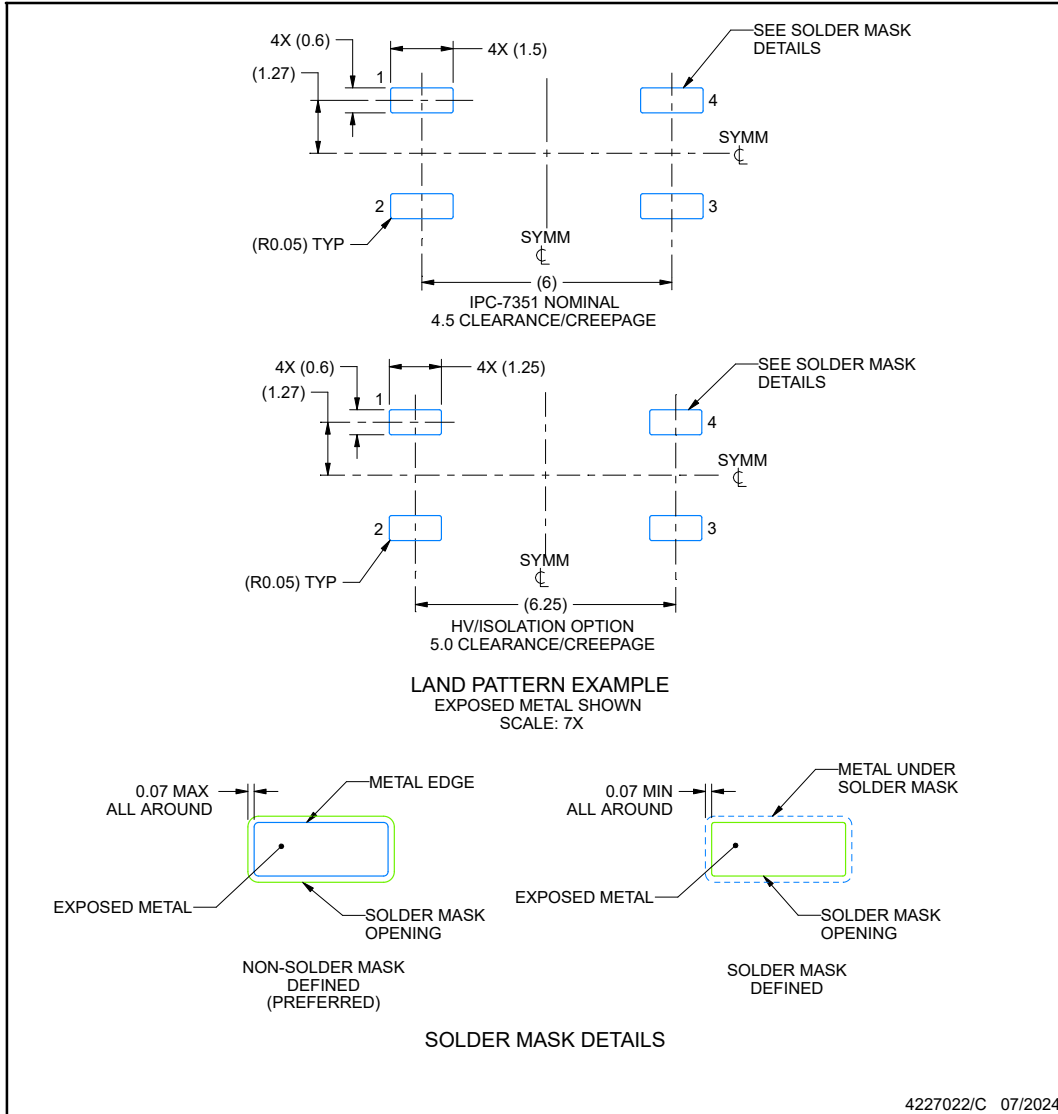
1. All linear dimensions are in millimeters. Any dimensions in parenthesis are for reference only. Dimensioning and tolerancing per ASME Y14.5M.
2. This drawing is subject to change without notice.
3. This dimension does not include mold flash, protrusions, or gate burrs. Mold flash, protrusions, or gate burrs shall not exceed 0.15 mm per side.
4. This dimension does not include interlead flash.

**EXAMPLE BOARD LAYOUT**

**DFG0004A**

**SOIC - 2.4 mm max height**

SMALL OUTLINE INTEGRATED CIRCUIT



NOTES: (continued)

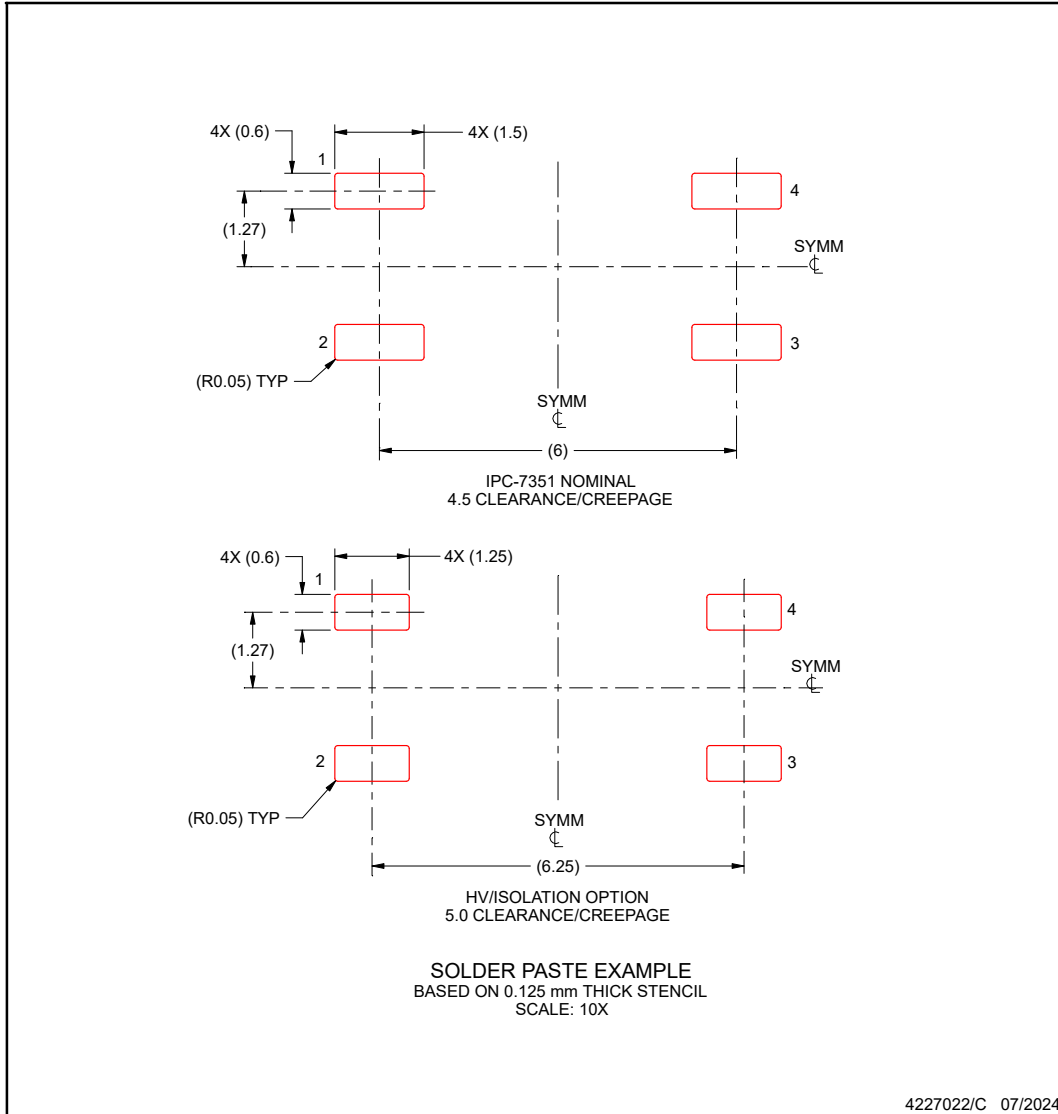
- 5. Publication IPC-7351 may have alternate designs.
- 6. Solder mask tolerances between and around signal pads can vary based on board fabrication site.

**EXAMPLE STENCIL DESIGN**

**DFG0004A**

**SOIC - 2.4 mm max height**

SMALL OUTLINE INTEGRATED CIRCUIT



NOTES: (continued)

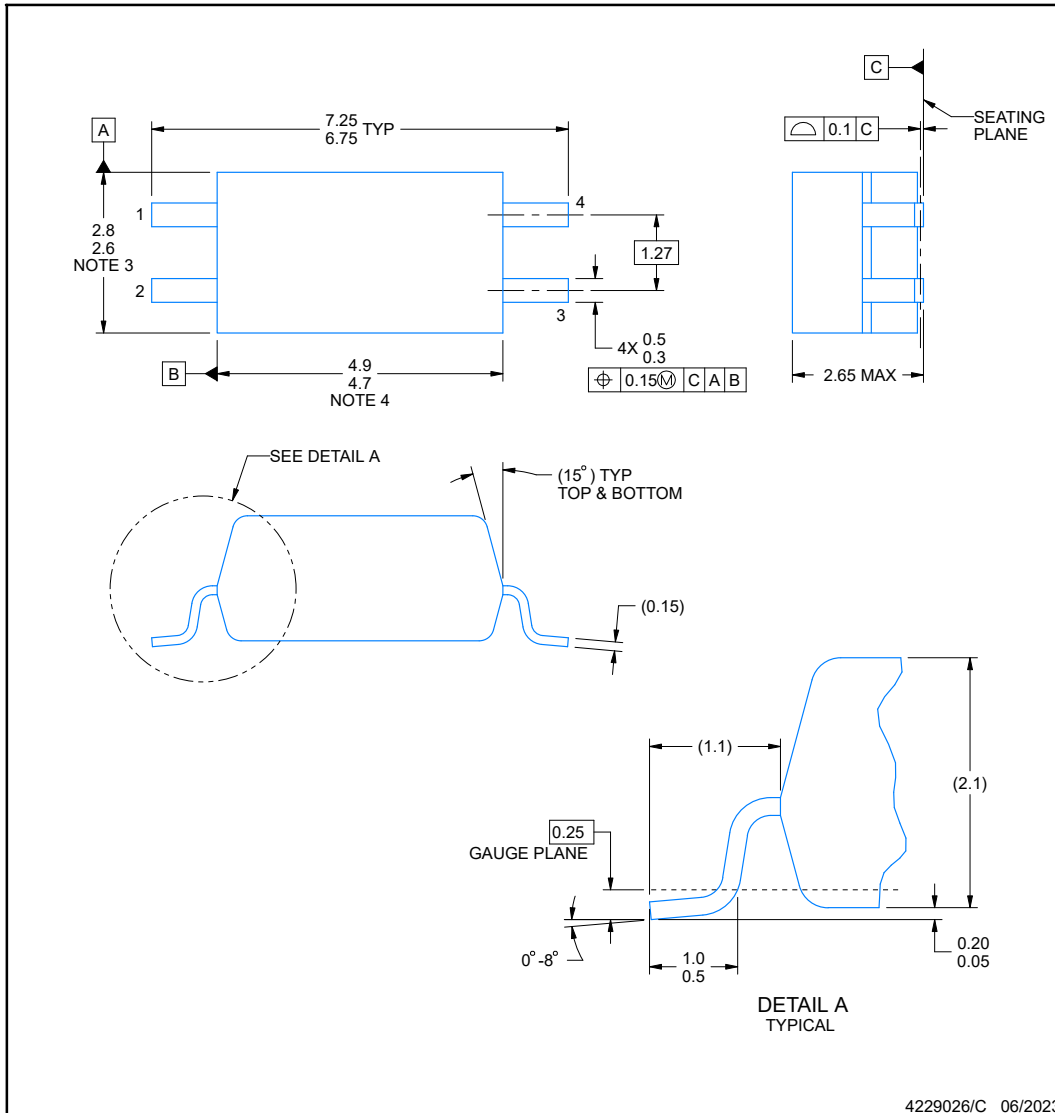
- 7. Laser cutting apertures with trapezoidal walls and rounded corners may offer better paste release. IPC-7525 may have alternate design recommendations.
- 8. Board assembly site may have different recommendations for stencil design.

**PACKAGE OUTLINE**

**DFH0004A-C01**

**SOIC - 2.65 mm max height**

SMALL OUTLINE INTEGRATED CIRCUIT



NOTES:

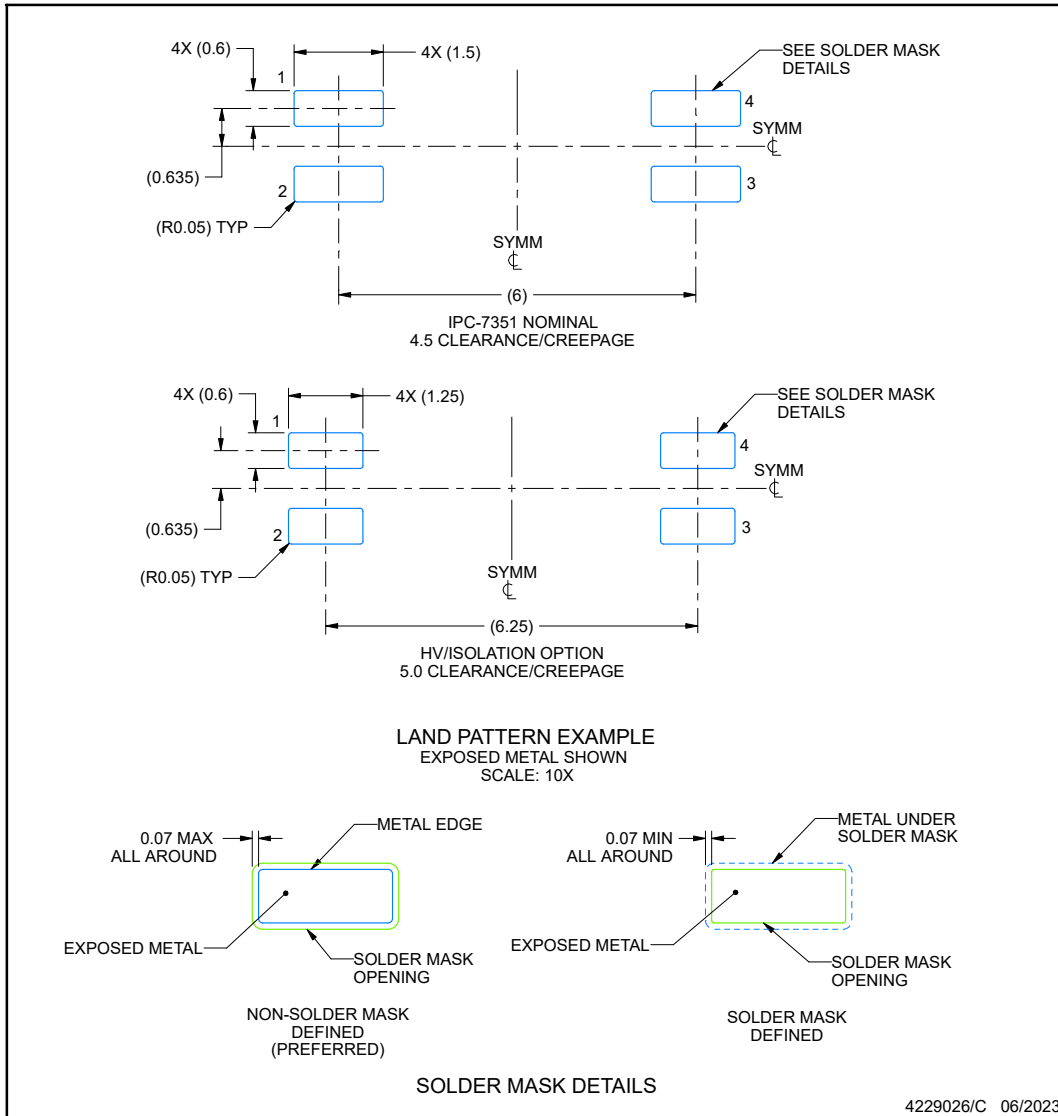
1. All linear dimensions are in millimeters. Any dimensions in parenthesis are for reference only. Dimensioning and tolerancing per ASME Y14.5M.
2. This drawing is subject to change without notice.
3. This dimension does not include mold flash, protrusions, or gate burrs. Mold flash, protrusions, or gate burrs shall not exceed 0.15 mm per side.
4. This dimension does not include interlead flash.

**EXAMPLE BOARD LAYOUT**

**DFH0004A-C01**

**SOIC - 2.65 mm max height**

SMALL OUTLINE INTEGRATED CIRCUIT



NOTES: (continued)

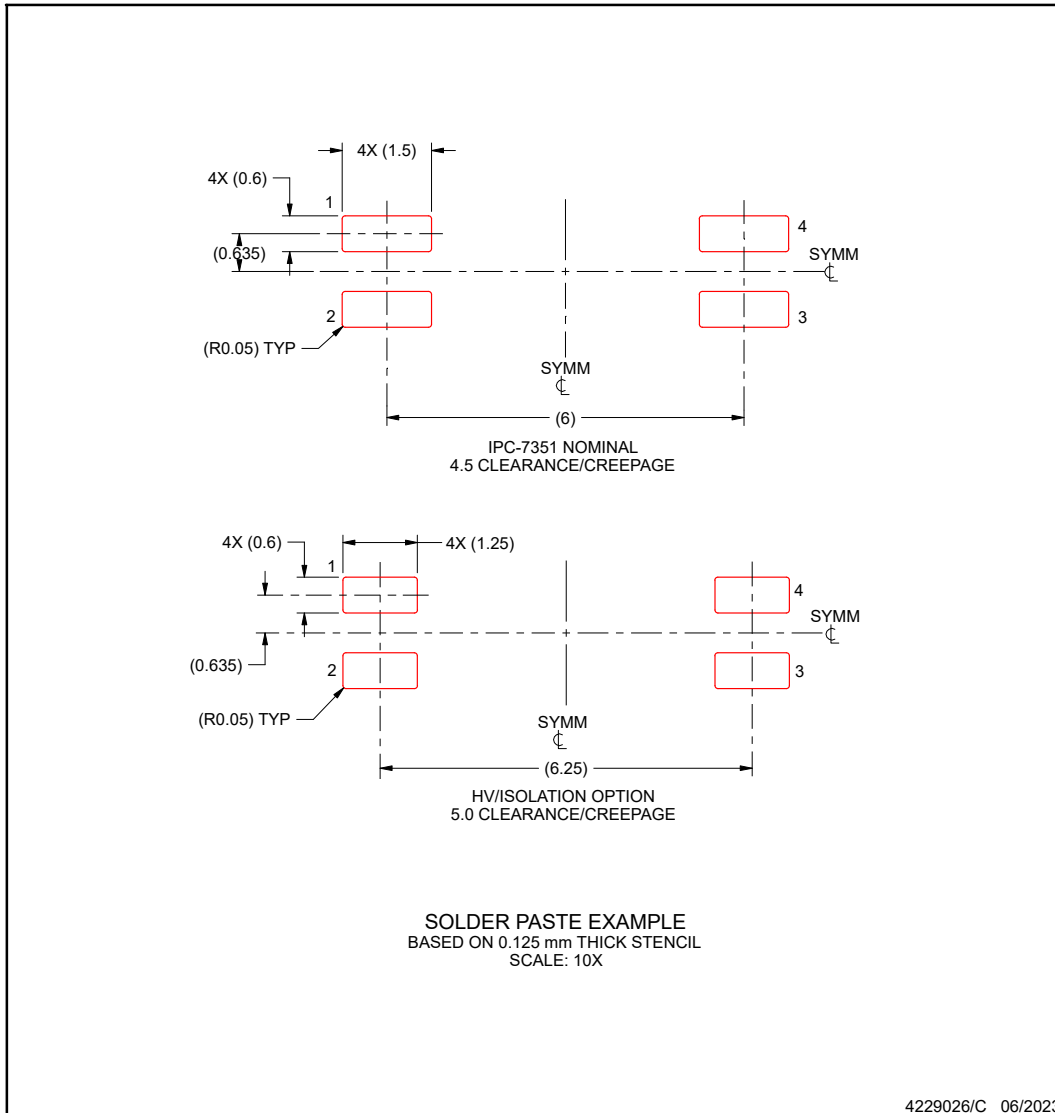
- 5. Publication IPC-7351 may have alternate designs.
- 6. Solder mask tolerances between and around signal pads can vary based on board fabrication site.

## EXAMPLE STENCIL DESIGN

**DFH0004A-C01**

**SOIC - 2.65 mm max height**

SMALL OUTLINE INTEGRATED CIRCUIT



NOTES: (continued)

7. Laser cutting apertures with trapezoidal walls and rounded corners may offer better paste release. IPC-7525 may have alternate design recommendations.
8. Board assembly site may have different recommendations for stencil design.

**PACKAGING INFORMATION**

Orderable Device	Status (1)	Package Type	Package Drawing	Pins	Package Qty	Eco Plan (2)	Lead finish/ Ball material (6)	MSL Peak Temp (3)	Op Temp (°C)	Device Marking (4/5)	Samples
ISOM8110DFGR	ACTIVE	SOIC	DFG	4	2000	RoHS & Green	NIPDAU	Level-2-260C-1 YEAR	-55 to 125	8110	Samples
ISOM8111DFGR	ACTIVE	SOIC	DFG	4	2000	RoHS & Green	NIPDAU	Level-2-260C-1 YEAR	-55 to 125	8111	Samples
ISOM8112DFGR	ACTIVE	SOIC	DFG	4	3000	RoHS & Green	NIPDAU	Level-2-260C-1 YEAR	-55 to 125	8112	Samples
ISOM8113DFGR	ACTIVE	SOIC	DFG	4	2000	RoHS & Green	NIPDAU	Level-2-260C-1 YEAR	-55 to 125	8113	Samples
ISOM8115DFGR	ACTIVE	SOIC	DFG	4	2000	RoHS & Green	NIPDAU	Level-2-260C-1 YEAR	-55 to 125	8115	Samples
ISOM8116DFGR	ACTIVE	SOIC	DFG	4	2000	RoHS & Green	NIPDAU	Level-2-260C-1 YEAR	-55 to 125	8116	Samples
ISOM8117DFGR	ACTIVE	SOIC	DFG	4	2000	RoHS & Green	NIPDAU	Level-2-260C-1 YEAR	-55 to 125	8117	Samples
ISOM8118DFGR	ACTIVE	SOIC	DFG	4	2000	RoHS & Green	NIPDAU	Level-2-260C-1 YEAR	-55 to 125	8118	Samples

(1) The marketing status values are defined as follows:

**ACTIVE:** Product device recommended for new designs.

**LIFEBUY:** TI has announced that the device will be discontinued, and a lifetime-buy period is in effect.

**NRND:** Not recommended for new designs. Device is in production to support existing customers, but TI does not recommend using this part in a new design.

**PREVIEW:** Device has been announced but is not in production. Samples may or may not be available.

**OBSELETE:** TI has discontinued the production of the device.

(2) **RoHS:** TI defines "RoHS" to mean semiconductor products that are compliant with the current EU RoHS requirements for all 10 RoHS substances, including the requirement that RoHS substance do not exceed 0.1% by weight in homogeneous materials. Where designed to be soldered at high temperatures, "RoHS" products are suitable for use in specified lead-free processes. TI may reference these types of products as "Pb-Free".

**RoHS Exempt:** TI defines "RoHS Exempt" to mean products that contain lead but are compliant with EU RoHS pursuant to a specific EU RoHS exemption.

**Green:** TI defines "Green" to mean the content of Chlorine (Cl) and Bromine (Br) based flame retardants meet JS709B low halogen requirements of <=1000ppm threshold. Antimony trioxide based flame retardants must also meet the <=1000ppm threshold requirement.

(3) MSL, Peak Temp. - The Moisture Sensitivity Level rating according to the JEDEC industry standard classifications, and peak solder temperature.

(4) There may be additional marking, which relates to the logo, the lot trace code information, or the environmental category on the device.

(5) Multiple Device Markings will be inside parentheses. Only one Device Marking contained in parentheses and separated by a "~" will appear on a device. If a line is indented then it is a continuation of the previous line and the two combined represent the entire Device Marking for that device.

<sup>(6)</sup> Lead finish/Ball material - Orderable Devices may have multiple material finish options. Finish options are separated by a vertical ruled line. Lead finish/Ball material values may wrap to two lines if the finish value exceeds the maximum column width.

**Important Information and Disclaimer:**The information provided on this page represents TI's knowledge and belief as of the date that it is provided. TI bases its knowledge and belief on information provided by third parties, and makes no representation or warranty as to the accuracy of such information. Efforts are underway to better integrate information from third parties. TI has taken and continues to take reasonable steps to provide representative and accurate information but may not have conducted destructive testing or chemical analysis on incoming materials and chemicals. TI and TI suppliers consider certain information to be proprietary, and thus CAS numbers and other limited information may not be available for release.

In no event shall TI's liability arising out of such information exceed the total purchase price of the TI part(s) at issue in this document sold by TI to Customer on an annual basis.

**OTHER QUALIFIED VERSIONS OF ISOM8110, ISOM8111, ISOM8112, ISOM8113, ISOM8115, ISOM8116, ISOM8117, ISOM8118 :**

- Automotive : [ISOM8110-Q1](#), [ISOM8111-Q1](#), [ISOM8112-Q1](#), [ISOM8113-Q1](#), [ISOM8115-Q1](#), [ISOM8116-Q1](#), [ISOM8117-Q1](#), [ISOM8118-Q1](#)

NOTE: Qualified Version Definitions:

- Automotive - Q100 devices qualified for high-reliability automotive applications targeting zero defects



**TAPE AND REEL INFORMATION**

**QUADRANT ASSIGNMENTS FOR PIN 1 ORIENTATION IN TAPE**


\*All dimensions are nominal

Device	Package Type	Package Drawing	Pins	SPQ	Reel Diameter (mm)	Reel Width W1 (mm)	A0 (mm)	B0 (mm)	K0 (mm)	P1 (mm)	W (mm)	Pin1 Quadrant
ISOM8110DFGR	SOIC	DFG	4	2000	330.0	12.4	8.0	3.8	2.7	12.0	12.0	Q1

**TAPE AND REEL BOX DIMENSIONS**


\*All dimensions are nominal

Device	Package Type	Package Drawing	Pins	SPQ	Length (mm)	Width (mm)	Height (mm)
ISOM8110DFGR	SOIC	DFG	4	2000	356.0	356.0	35.0

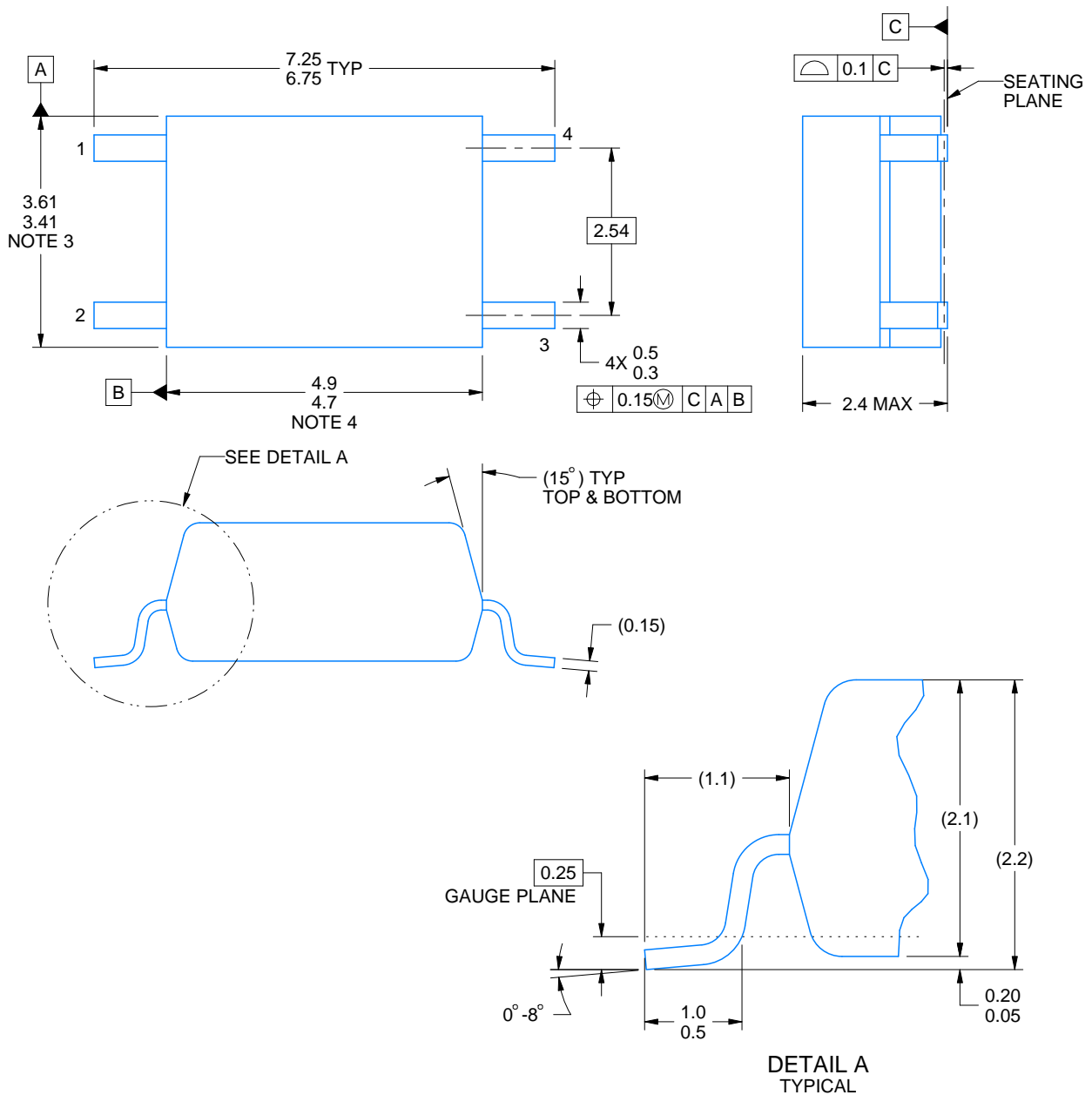
# DFG0004A



## PACKAGE OUTLINE

SOIC - 2.4 mm max height

SMALL OUTLINE INTEGRATED CIRCUIT



4227022/C 07/2024

### NOTES:

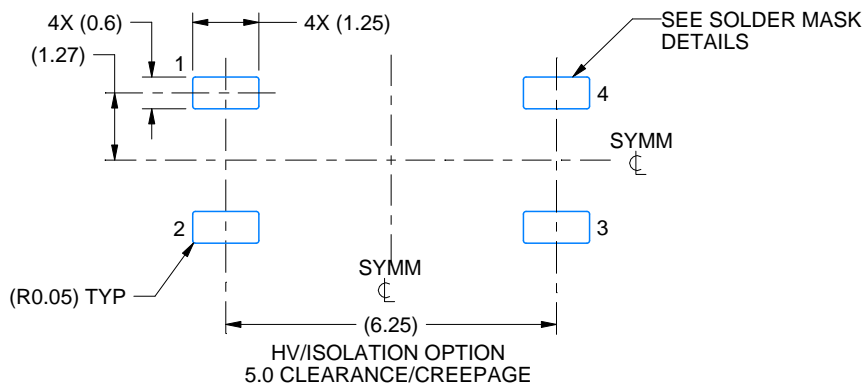
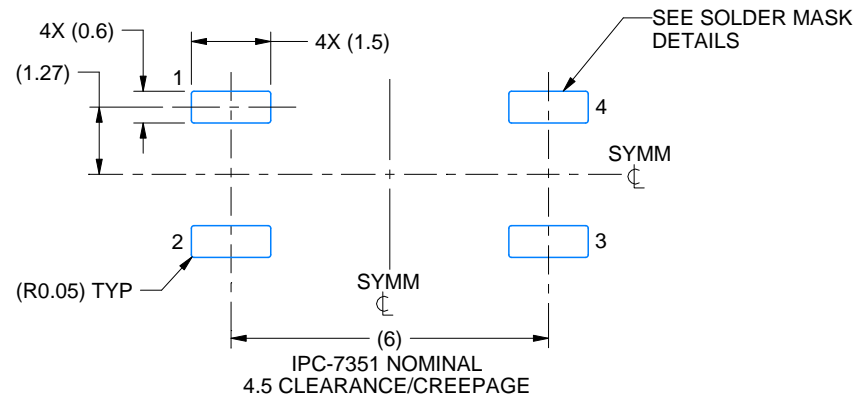
1. All linear dimensions are in millimeters. Any dimensions in parenthesis are for reference only. Dimensioning and tolerancing per ASME Y14.5M.
2. This drawing is subject to change without notice.
3. This dimension does not include mold flash, protrusions, or gate burrs. Mold flash, protrusions, or gate burrs shall not exceed 0,15 mm per side.
4. This dimension does not include interlead flash.

# EXAMPLE BOARD LAYOUT

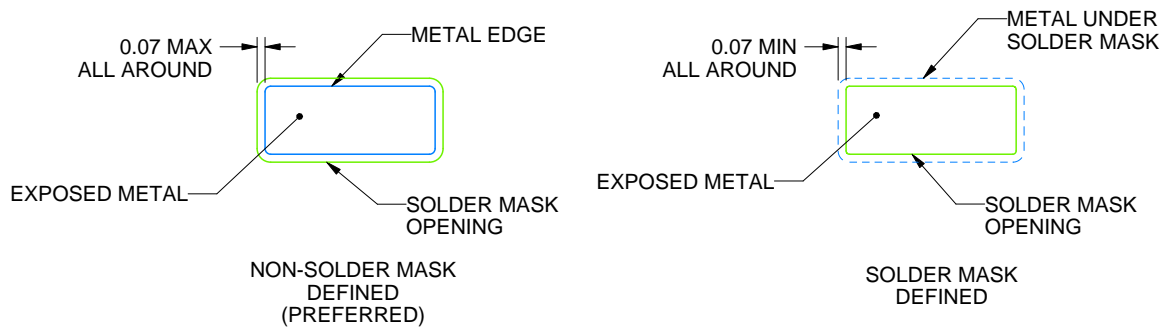
DFG0004A

SOIC - 2.4 mm max height

SMALL OUTLINE INTEGRATED CIRCUIT



LAND PATTERN EXAMPLE  
EXPOSED METAL SHOWN  
SCALE: 7X



SOLDER MASK DETAILS

4227022/C 07/2024

NOTES: (continued)

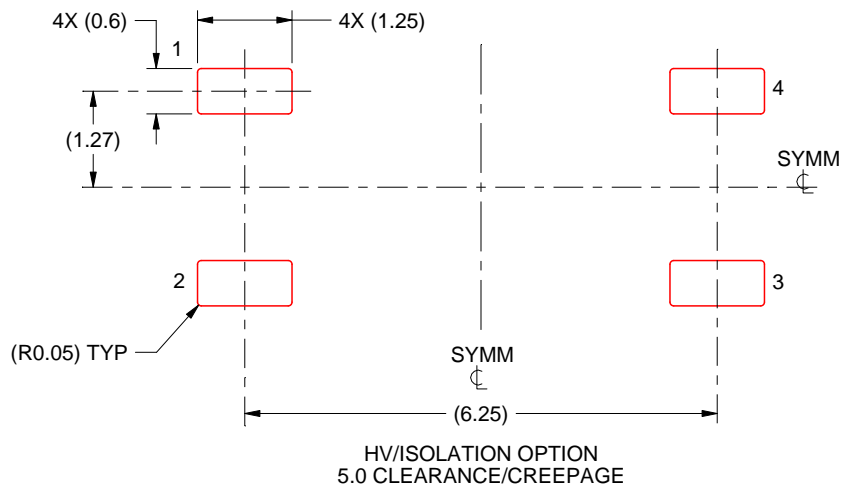
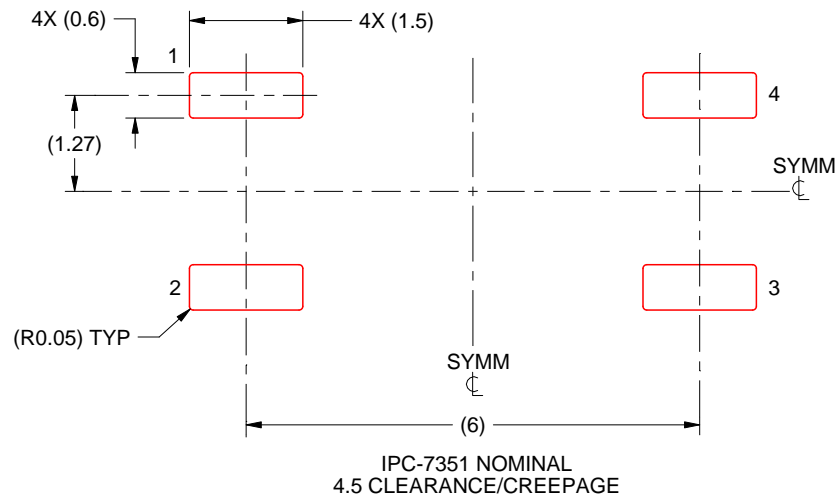
- 5. Publication IPC-7351 may have alternate designs.
- 6. Solder mask tolerances between and around signal pads can vary based on board fabrication site.

# EXAMPLE STENCIL DESIGN

DFG0004A

SOIC - 2.4 mm max height

SMALL OUTLINE INTEGRATED CIRCUIT



SOLDER PASTE EXAMPLE  
BASED ON 0.125 mm THICK STENCIL  
SCALE: 10X

4227022/C 07/2024

NOTES: (continued)

7. Laser cutting apertures with trapezoidal walls and rounded corners may offer better paste release. IPC-7525 may have alternate design recommendations.
8. Board assembly site may have different recommendations for stencil design.

## IMPORTANT NOTICE AND DISCLAIMER

TI PROVIDES TECHNICAL AND RELIABILITY DATA (INCLUDING DATA SHEETS), DESIGN RESOURCES (INCLUDING REFERENCE DESIGNS), APPLICATION OR OTHER DESIGN ADVICE, WEB TOOLS, SAFETY INFORMATION, AND OTHER RESOURCES "AS IS" AND WITH ALL FAULTS, AND DISCLAIMS ALL WARRANTIES, EXPRESS AND IMPLIED, INCLUDING WITHOUT LIMITATION ANY IMPLIED WARRANTIES OF MERCHANTABILITY, FITNESS FOR A PARTICULAR PURPOSE OR NON-INFRINGEMENT OF THIRD PARTY INTELLECTUAL PROPERTY RIGHTS.

These resources are intended for skilled developers designing with TI products. You are solely responsible for (1) selecting the appropriate TI products for your application, (2) designing, validating and testing your application, and (3) ensuring your application meets applicable standards, and any other safety, security, regulatory or other requirements.

These resources are subject to change without notice. TI grants you permission to use these resources only for development of an application that uses the TI products described in the resource. Other reproduction and display of these resources is prohibited. No license is granted to any other TI intellectual property right or to any third party intellectual property right. TI disclaims responsibility for, and you will fully indemnify TI and its representatives against, any claims, damages, costs, losses, and liabilities arising out of your use of these resources.

TI's products are provided subject to [TI's Terms of Sale](#) or other applicable terms available either on [ti.com](https://www.ti.com) or provided in conjunction with such TI products. TI's provision of these resources does not expand or otherwise alter TI's applicable warranties or warranty disclaimers for TI products.

TI objects to and rejects any additional or different terms you may have proposed.

Mailing Address: Texas Instruments, Post Office Box 655303, Dallas, Texas 75265  
Copyright © 2024, Texas Instruments Incorporated