

LM94021/LM94021Q Multi-Gain Analog Temperature Sensor

Check for Samples: [LM94021](#)

FEATURES

- **LM94021Q is AEC-Q100 Grade 0 Qualified and is Manufactured on an Automotive Grade Flow**
- **Low 1.5V Operation**
- **Four Selectable Gains**
- **Very Accurate Over Wide Temperature Range of -50°C to $+150^{\circ}\text{C}$**
- **Low Quiescent Current**
- **Output is Short-Circuit Protected**
- **Extremely Small SC70 Package**
- **Footprint Compatible with the Industry-Standard LM20 Temperature Sensor**
- **UL Recognized Component **

APPLICATIONS

- **Cell Phones**
- **Wireless Transceivers**
- **Battery Management**
- **Automotive**
- **Disk Drives**
- **Games**
- **Appliances**

DESCRIPTION

The LM94021 is a precision analog output CMOS integrated-circuit temperature sensor that operates at a supply voltage as low as 1.5V. While operating over the wide temperature range of -50°C to $+150^{\circ}\text{C}$, the LM94021 delivers an output voltage that is inversely proportional to measured temperature. The LM94021's low supply current makes it ideal for battery-powered systems as well as general temperature sensing applications.

Two logic inputs, Gain Select 1 (GS1) and Gain Select 0 (GS0), select the gain of the temperature-to-voltage output transfer function. Four slopes are selectable: $-5.5\text{ mV}/^{\circ}\text{C}$, $-8.2\text{ mV}/^{\circ}\text{C}$, $-10.9\text{ mV}/^{\circ}\text{C}$, and $-13.6\text{ mV}/^{\circ}\text{C}$. In the lowest gain configuration (GS1 and GS0 both tied low), the LM94021 can operate with a 1.5V supply while measuring temperature over the full -50°C to $+150^{\circ}\text{C}$ operating range. Tying both inputs high causes the transfer function to have the largest gain of $-13.6\text{ mV}/^{\circ}\text{C}$ for maximum temperature sensitivity. The gain-select inputs can be tied directly to V_{DD} or Ground without any pull-up or pull-down resistors, reducing component count and board area. These inputs can also be driven by logic signals allowing the system to optimize the gain during operation or system diagnostics.

Table 1. KEY SPECIFICATIONS

Supply Voltage	1.5V to 5.5V	
Supply Current	9 μA (typ)	
Temperature Accuracy	20°C to 40°C -50°C to 70°C -50°C to 90°C -50°C to 150°C	$\pm 1.5^{\circ}\text{C}$ $\pm 1.8^{\circ}\text{C}$ $\pm 2.1^{\circ}\text{C}$ $\pm 2.7^{\circ}\text{C}$
Operating Temperature	-50°C to 150°C	



Please be aware that an important notice concerning availability, standard warranty, and use in critical applications of Texas Instruments semiconductor products and disclaimers thereto appears at the end of this data sheet.

All trademarks are the property of their respective owners.



These devices have limited built-in ESD protection. The leads should be shorted together or the device placed in conductive foam during storage or handling to prevent electrostatic damage to the MOS gates.

CONNECTION DIAGRAM

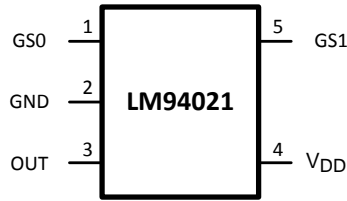
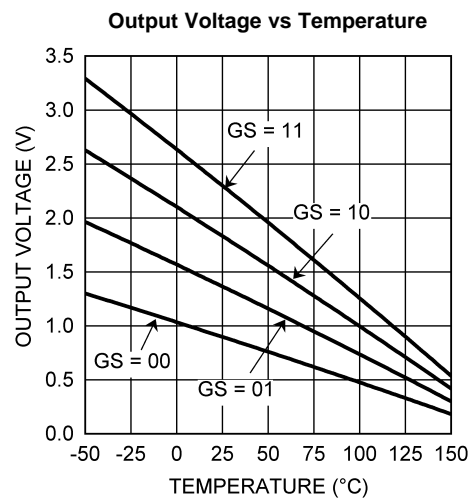

Figure 1. 5-Pin SC70 - Top View

TYPICAL TRANSFER CHARACTERISTIC



TYPICAL APPLICATION

Full-Range Celsius Temperature Sensor (-50°C to +150°C) operating from a Single Battery Cell

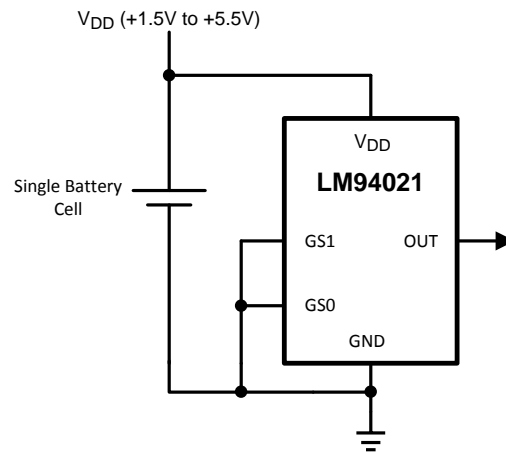

PIN DESCRIPTIONS

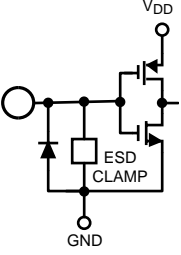
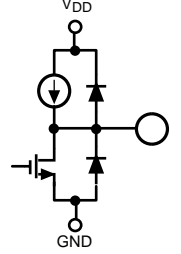
LABEL	PIN NUMBER	TYPE	EQUIVALENT CIRCUIT	FUNCTION
GS1	5	Logic Input		Gain Select 1 - One of two inputs for selecting the slope of the output response
GS0	1	Logic Input		Gain Select 0 - One of two inputs for selecting the slope of the output response
OUT	3	Analog Output		Outputs a voltage which is inversely proportional to temperature
V _{DD}	4	Power		Positive Supply Voltage
GND	2	Ground		Power Supply Ground

ABSOLUTE MAXIMUM RATINGS ⁽¹⁾

	VALUES	
Supply Voltage	-0.3V to +6.0V	
Voltage at Output Pin	-0.3V to (V _{DD} + 0.5V)	
Output Current	±7 mA	
Voltage at GS0 and GS1 Input Pins	-0.3V to +6.0V	
Input Current at any pin ⁽²⁾	5 mA	
Storage Temperature	-65°C to +150°C	
Maximum Junction Temperature (T _{JMAX})	+150°C	
ESD Susceptibility ⁽³⁾	Human Body Model	2500V
	Machine Model	250V
Soldering process must comply with Reflow Temperature Profile specifications. Refer to http://www.ti.com/packaging . ⁽⁴⁾		

- (1) *Absolute Maximum Ratings* indicate limits beyond which damage to the device may occur. *Operating Ratings* indicate conditions for which the device is functional, but do not ensure specific performance limits. For ensured specifications and test conditions, see the *Electrical Characteristics*. The ensured specifications apply only for the test conditions listed. Some performance characteristics may degrade when the device is not operated under the listed test conditions.
- (2) When the input voltage (V_I) at any pin exceeds power supplies (V_I < GND or V_I > V*), the current at that pin should be limited to 5 mA.
- (3) The human body model is a 100 pF capacitor discharged through a 1.5 kΩ resistor into each pin. The machine model is a 200 pF capacitor discharged directly into each pin.
- (4) Reflow temperature profiles are different for lead-free and non-lead-free packages.

OPERATING RATINGS ⁽¹⁾

Specified Temperature Range	$T_{MIN} \leq T_A \leq T_{MAX}$
LM94021	$-50^{\circ}\text{C} \leq T_A \leq +150^{\circ}\text{C}$
Supply Voltage Range (V_{DD})	+1.5 V to +5.5 V
Thermal Resistance (θ_{JA}) ⁽²⁾⁽³⁾ 5-Pin SC70	415°C/W

- (1) *Absolute Maximum Ratings* indicate limits beyond which damage to the device may occur. *Operating Ratings* indicate conditions for which the device is functional, but do not ensure specific performance limits. For ensured specifications and test conditions, see the *Electrical Characteristics*. The ensured specifications apply only for the test conditions listed. Some performance characteristics may degrade when the device is not operated under the listed test conditions.
- (2) The junction to ambient thermal resistance (θ_{JA}) is specified without a heat sink in still air.
- (3) Changes in output due to self heating can be computed by multiplying the internal dissipation by the thermal resistance.

ACCURACY CHARACTERISTICS

These limits do not include DC load regulation. These stated accuracy limits are with reference to the values in the LM94021 Transfer Table.

PARAMETER	CONDITIONS		LIMITS ⁽¹⁾	UNITS (LIMIT)
Temperature Error ⁽²⁾	GS1 = 0 GS0 = 0	$T_A = +20^{\circ}\text{C}$ to $+40^{\circ}\text{C}$; $V_{DD} = 1.5\text{V}$ to 5.5V	± 1.5	$^{\circ}\text{C}$ (max)
		$T_A = +0^{\circ}\text{C}$ to $+70^{\circ}\text{C}$; $V_{DD} = 1.5\text{V}$ to 5.5V	± 1.8	$^{\circ}\text{C}$ (max)
		$T_A = +0^{\circ}\text{C}$ to $+90^{\circ}\text{C}$; $V_{DD} = 1.5\text{V}$ to 5.5V	± 2.1	$^{\circ}\text{C}$ (max)
		$T_A = +0^{\circ}\text{C}$ to $+120^{\circ}\text{C}$; $V_{DD} = 1.5\text{V}$ to 5.5V	± 2.4	$^{\circ}\text{C}$ (max)
		$T_A = +0^{\circ}\text{C}$ to $+150^{\circ}\text{C}$; $V_{DD} = 1.5\text{V}$ to 5.5V	± 2.7	$^{\circ}\text{C}$ (max)
		$T_A = -50^{\circ}\text{C}$ to $+0^{\circ}\text{C}$; $V_{DD} = 1.6\text{V}$ to 5.5V	± 1.8	$^{\circ}\text{C}$ (max)
	GS1 = 0 GS0 = 1	$T_A = +20^{\circ}\text{C}$ to $+40^{\circ}\text{C}$; $V_{DD} = 1.8\text{V}$ to 5.5V	± 1.5	$^{\circ}\text{C}$ (max)
		$T_A = +0^{\circ}\text{C}$ to $+70^{\circ}\text{C}$; $V_{DD} = 1.9\text{V}$ to 5.5V	± 1.8	$^{\circ}\text{C}$ (max)
		$T_A = +0^{\circ}\text{C}$ to $+90^{\circ}\text{C}$; $V_{DD} = 1.9\text{V}$ to 5.5V	± 2.1	$^{\circ}\text{C}$ (max)
		$T_A = +0^{\circ}\text{C}$ to $+120^{\circ}\text{C}$; $V_{DD} = 1.9\text{V}$ to 5.5V	± 2.4	$^{\circ}\text{C}$ (max)
		$T_A = +0^{\circ}\text{C}$ to $+150^{\circ}\text{C}$; $V_{DD} = 1.9\text{V}$ to 5.5V	± 2.7	$^{\circ}\text{C}$ (max)
		$T_A = -50^{\circ}\text{C}$ to $+0^{\circ}\text{C}$; $V_{DD} = 2.3\text{V}$ to 5.5V	± 1.8	$^{\circ}\text{C}$ (max)
	GS1 = 1 GS0 = 0	$T_A = +20^{\circ}\text{C}$ to $+40^{\circ}\text{C}$; $V_{DD} = 2.2\text{V}$ to 5.5V	± 1.5	$^{\circ}\text{C}$ (max)
		$T_A = +0^{\circ}\text{C}$ to $+70^{\circ}\text{C}$; $V_{DD} = 2.4\text{V}$ to 5.5V	± 1.8	$^{\circ}\text{C}$ (max)
		$T_A = +0^{\circ}\text{C}$ to $+90^{\circ}\text{C}$; $V_{DD} = 2.4\text{V}$ to 5.5V	± 2.1	$^{\circ}\text{C}$ (max)
		$T_A = +0^{\circ}\text{C}$ to $+120^{\circ}\text{C}$; $V_{DD} = 2.4\text{V}$ to 5.5V	± 2.4	$^{\circ}\text{C}$ (max)
		$T_A = +0^{\circ}\text{C}$ to $+150^{\circ}\text{C}$; $V_{DD} = 2.4\text{V}$ to 5.5V	± 2.7	$^{\circ}\text{C}$ (max)
		$T_A = -50^{\circ}\text{C}$ to $+0^{\circ}\text{C}$; $V_{DD} = 3.0\text{V}$ to 5.5V	± 1.8	$^{\circ}\text{C}$ (max)
	GS1 = 1 GS0 = 1	$T_A = +20^{\circ}\text{C}$ to $+40^{\circ}\text{C}$; $V_{DD} = 2.7\text{V}$ to 5.5V	± 1.5	$^{\circ}\text{C}$ (max)
		$T_A = +0^{\circ}\text{C}$ to $+70^{\circ}\text{C}$; $V_{DD} = 3.0\text{V}$ to 5.5V	± 1.8	$^{\circ}\text{C}$ (max)
		$T_A = +0^{\circ}\text{C}$ to $+90^{\circ}\text{C}$; $V_{DD} = 3.0\text{V}$ to 5.5V	± 2.1	$^{\circ}\text{C}$ (max)
		$T_A = +0^{\circ}\text{C}$ to $+120^{\circ}\text{C}$; $V_{DD} = 3.0\text{V}$ to 5.5V	± 2.4	$^{\circ}\text{C}$ (max)
		$T_A = 0^{\circ}\text{C}$ to $+150^{\circ}\text{C}$; $V_{DD} = 3.0\text{V}$ to 5.5V	± 2.7	$^{\circ}\text{C}$ (max)
		$T_A = -50^{\circ}\text{C}$ to $+0^{\circ}\text{C}$; $V_{DD} = 3.6\text{V}$ to 5.5V	± 1.8	$^{\circ}\text{C}$ (max)

- (1) Limits are ensured to TI's AOQL (Average Outgoing Quality Level).
- (2) Accuracy is defined as the error between the measured and reference output voltages, tabulated in the Transfer Table at the specified conditions of supply gain setting, voltage, and temperature (expressed in $^{\circ}\text{C}$). Accuracy limits include line regulation within the specified conditions. Accuracy limits do not include load regulation; they assume no DC load.

ELECTRICAL CHARACTERISTICS

Unless otherwise noted, these specifications apply for $+V_{DD} = +1.5V$ to $+5.5V$. **Boldface limits apply for $T_A = T_J = T_{MIN}$ to T_{MAX}** ; all other limits $T_A = T_J = 25^\circ C$.

PARAMETER		CONDITIONS	TYPICAL ⁽¹⁾	LIMITS ⁽²⁾	UNITS (LIMIT)
	Sensor Gain	GS1 = 0, GS0 = 0	-5.5		mV/°C
		GS1 = 0, GS1 = 1	-8.2		mV/°C
		GS1 = 1, GS0 = 0	-10.9		mV/°C
		GS1 = 1, GS0 = 1	-13.6		mV/°C
	Load Regulation ⁽³⁾	Source $\leq 2.0 \mu A$ ⁽⁴⁾ Sink $\leq 100 \mu A$ Sink = $50 \mu A$	0.4	-1 1.6	mV (max) mV (max) mV
	Line Regulation ⁽⁵⁾	$(V_{DD} - V_{OUT}) \geq 200 mV$	200		$\mu V/V$
I_S	Supply Current	$T_A = +30^\circ C$ to $+150^\circ C$ $T_A = -50^\circ C$ to $+150^\circ C$	9	12 13	μA (max) μA (max)
C_L	Output Load Capacitance		1100		pF (max)
	Power-on Time ⁽⁶⁾	$C_L = 0 pF$ $C_L = 1100 pF$	0.7 0.8	1.6 2.4	ms (max) ms (max)
V_{IH}	GS1 and GS0 Input Logic "1" Threshold Voltage			$V_{DD} - 0.5V$	V (min)
V_{IL}	GS1 and GS0 Input Logic "0" Threshold Voltage			0.5	V (max)
I_{IH}	Logic "1" Input Current ⁽⁷⁾		0.001	1	μA (max)
I_{IL}	Logic "0" Input Current ⁽⁷⁾		0.001	1	μA (max)

(1) Typicals are at $T_J = T_A = 25^\circ C$ and represent most likely parametric norm.

(2) Limits are ensured to TI's AOQL (Average Outgoing Quality Level).

(3) Source currents are flowing out of the LM94021. Sink currents are flowing into the LM94021.

(4) Assumes $(V_{DD} - V_{OUT}) \geq 200 mV$.

(5) Line regulation is calculated by subtracting the output voltage at the highest supply voltage from the output voltage at the lowest supply voltage. The typical line regulation specification does not include the output voltage shift discussed in Section 5.0.

(6) Specified by design.

(7) The input current is leakage only and is highest at high temperature. It is typically only $0.001 \mu A$. The $1 \mu A$ limit is solely based on a testing limitation and does not reflect the actual performance of the part.

TYPICAL PERFORMANCE CHARACTERISTICS

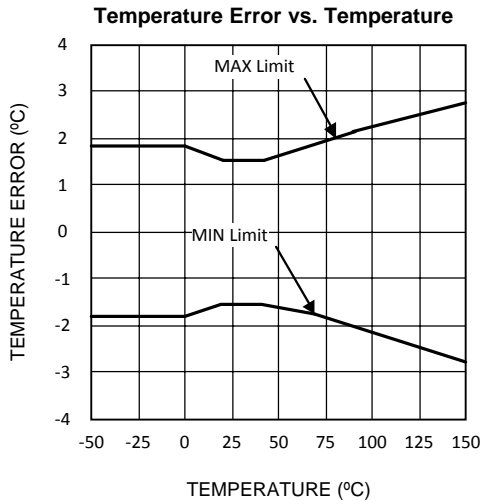

Figure 2.

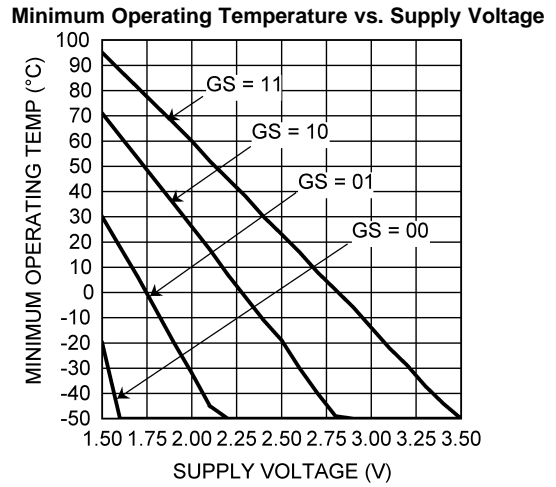

Figure 3.

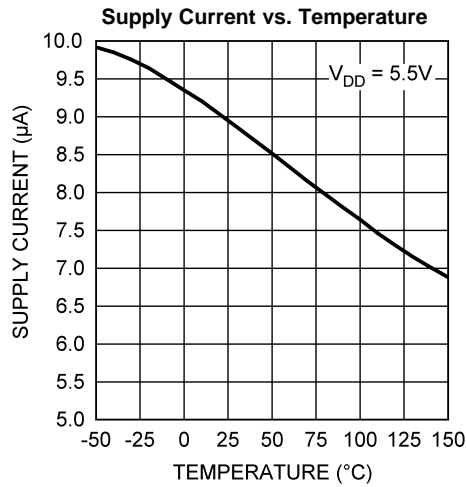

Figure 4.

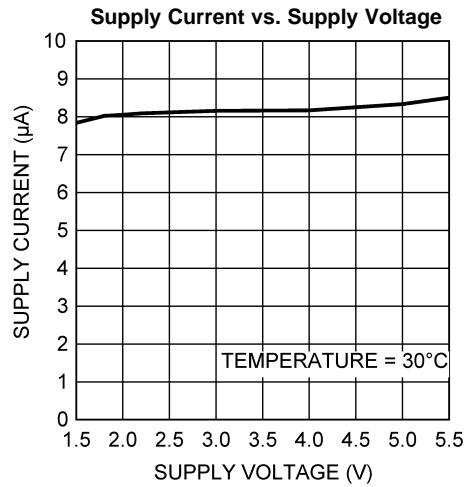

Figure 5.

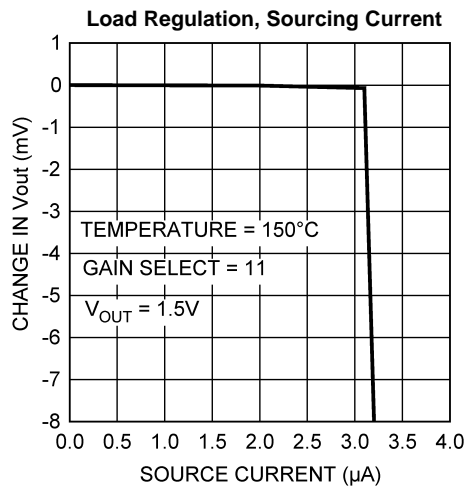

Figure 6.

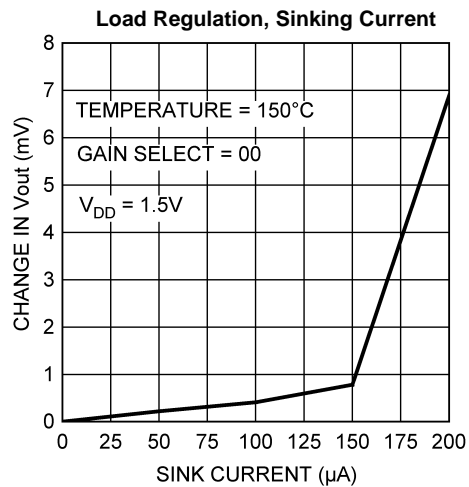

Figure 7.

TYPICAL PERFORMANCE CHARACTERISTICS (continued)

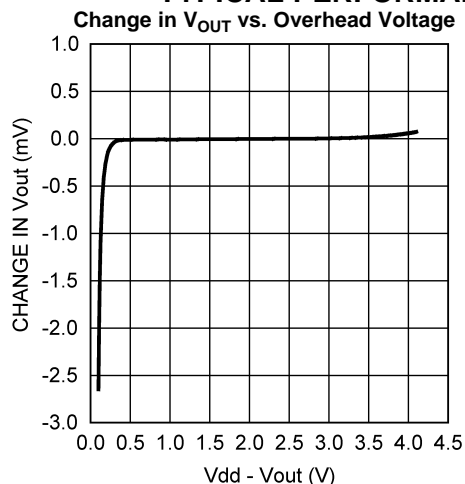

Figure 8.

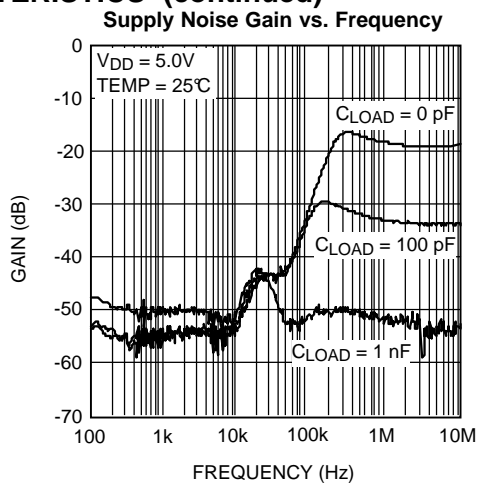

Figure 9.

Line Regulation: Output Voltage vs. Supply Voltage
Gain Select = 00

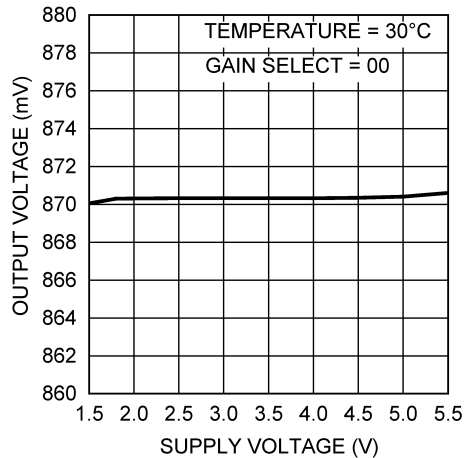

Figure 10.

Line Regulation: Output Voltage vs. Supply Voltage
Gain Select = 01

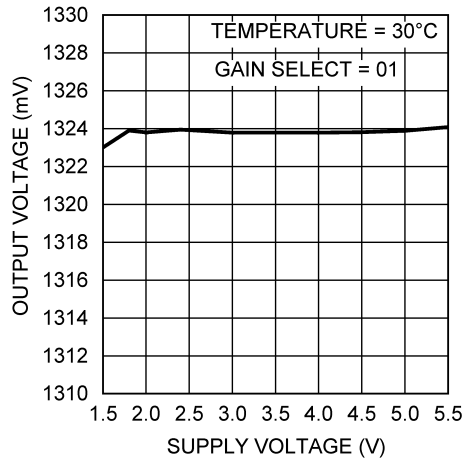

Figure 11.

Line Regulation: Output Voltage vs. Supply Voltage
Gain Select = 10

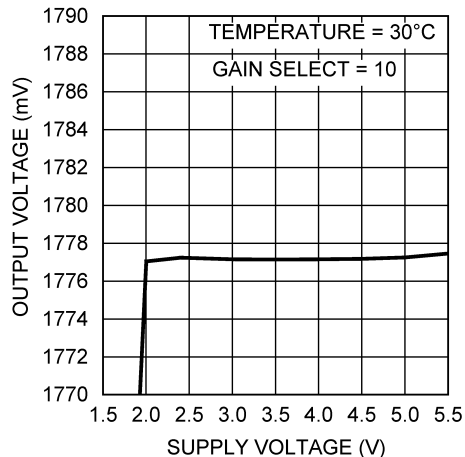

Figure 12.

Line Regulation: Output Voltage vs. Supply Voltage
Gain Select = 11

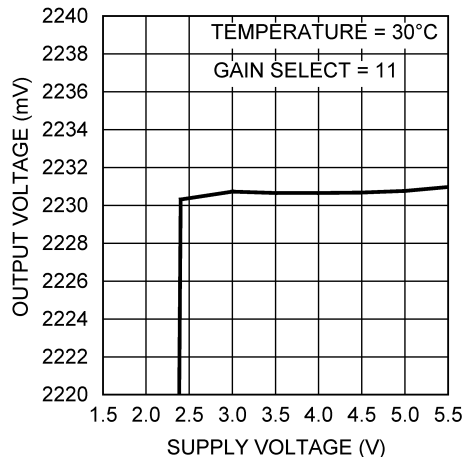

Figure 13.

APPLICATION INFORMATION

LM94021 TRANSFER FUNCTION

The LM94021 has four selectable gains, each of which can be selected by the GS1 and GS0 input pins. The output voltage for each gain, across the complete operating temperature range is shown in Table 2, below. This table is the reference from which the LM94021 accuracy specifications (listed in the [ELECTRICAL CHARACTERISTICS](#) section) are determined. This table can be used, for example, in a host processor look-up table. A file containing this data is available for download at http://www.ti.com/lscs/ti/analog/temperature_sensor.page.

Table 2. LM94021 Transfer Table

TEMPERATURE (°C)	GS = 00 (mV)	GS = 01 (mV)	GS = 10 (mV)	GS = 11 (mV)
-50	1299	1955	2616	3277
-49	1294	1949	2607	3266
-48	1289	1942	2598	3254
-47	1284	1935	2589	3243
-46	1278	1928	2580	3232
-45	1273	1921	2571	3221
-44	1268	1915	2562	3210
-43	1263	1908	2553	3199
-42	1257	1900	2543	3186
-41	1252	1892	2533	3173
-40	1247	1885	2522	3160
-39	1242	1877	2512	3147
-38	1236	1869	2501	3134
-37	1231	1861	2491	3121
-36	1226	1853	2481	3108
-35	1221	1845	2470	3095
-34	1215	1838	2460	3082
-33	1210	1830	2449	3069
-32	1205	1822	2439	3056
-31	1200	1814	2429	3043
-30	1194	1806	2418	3030
-29	1189	1798	2408	3017
-28	1184	1790	2397	3004
-27	1178	1783	2387	2991
-26	1173	1775	2376	2978
-25	1168	1767	2366	2965
-24	1162	1759	2355	2952
-23	1157	1751	2345	2938
-22	1152	1743	2334	2925
-21	1146	1735	2324	2912
-20	1141	1727	2313	2899
-19	1136	1719	2302	2886
-18	1130	1711	2292	2873
-17	1125	1703	2281	2859
-16	1120	1695	2271	2846
-15	1114	1687	2260	2833
-14	1109	1679	2250	2820
-13	1104	1671	2239	2807

Table 2. LM94021 Transfer Table (continued)

TEMPERATURE (°C)	GS = 00 (mV)	GS = 01 (mV)	GS = 10 (mV)	GS = 11 (mV)
-12	1098	1663	2228	2793
-11	1093	1656	2218	2780
-10	1088	1648	2207	2767
-9	1082	1639	2197	2754
-8	1077	1631	2186	2740
-7	1072	1623	2175	2727
-6	1066	1615	2164	2714
-5	1061	1607	2154	2700
-4	1055	1599	2143	2687
-3	1050	1591	2132	2674
-2	1044	1583	2122	2660
-1	1039	1575	2111	2647
0	1034	1567	2100	2633
1	1028	1559	2089	2620
2	1023	1551	2079	2607
3	1017	1543	2068	2593
4	1012	1535	2057	2580
5	1007	1527	2047	2567
6	1001	1519	2036	2553
7	996	1511	2025	2540
8	990	1502	2014	2527
9	985	1494	2004	2513
10	980	1486	1993	2500
11	974	1478	1982	2486
12	969	1470	1971	2473
13	963	1462	1961	2459
14	958	1454	1950	2446
15	952	1446	1939	2433
16	947	1438	1928	2419
17	941	1430	1918	2406
18	936	1421	1907	2392
19	931	1413	1896	2379
20	925	1405	1885	2365
21	920	1397	1874	2352
22	914	1389	1864	2338
23	909	1381	1853	2325
24	903	1373	1842	2311
25	898	1365	1831	2298
26	892	1356	1820	2285
27	887	1348	1810	2271
28	882	1340	1799	2258
29	876	1332	1788	2244
30	871	1324	1777	2231
31	865	1316	1766	2217
32	860	1308	1756	2204
33	854	1299	1745	2190
34	849	1291	1734	2176

Table 2. LM94021 Transfer Table (continued)

TEMPERATURE (°C)	GS = 00 (mV)	GS = 01 (mV)	GS = 10 (mV)	GS = 11 (mV)
35	843	1283	1723	2163
36	838	1275	1712	2149
37	832	1267	1701	2136
38	827	1258	1690	2122
39	821	1250	1679	2108
40	816	1242	1668	2095
41	810	1234	1657	2081
42	804	1225	1646	2067
43	799	1217	1635	2054
44	793	1209	1624	2040
45	788	1201	1613	2026
46	782	1192	1602	2012
47	777	1184	1591	1999
48	771	1176	1580	1985
49	766	1167	1569	1971
50	760	1159	1558	1958
51	754	1151	1547	1944
52	749	1143	1536	1930
53	743	1134	1525	1916
54	738	1126	1514	1902
55	732	1118	1503	1888
56	726	1109	1492	1875
57	721	1101	1481	1861
58	715	1093	1470	1847
59	710	1084	1459	1833
60	704	1076	1448	1819
61	698	1067	1436	1805
62	693	1059	1425	1791
63	687	1051	1414	1777
64	681	1042	1403	1763
65	676	1034	1391	1749
66	670	1025	1380	1735
67	664	1017	1369	1721
68	659	1008	1358	1707
69	653	1000	1346	1693
70	647	991	1335	1679
71	642	983	1324	1665
72	636	974	1313	1651
73	630	966	1301	1637
74	625	957	1290	1623
75	619	949	1279	1609
76	613	941	1268	1595
77	608	932	1257	1581
78	602	924	1245	1567
79	596	915	1234	1553
80	591	907	1223	1539
81	585	898	1212	1525

Table 2. LM94021 Transfer Table (continued)

TEMPERATURE (°C)	GS = 00 (mV)	GS = 01 (mV)	GS = 10 (mV)	GS = 11 (mV)
82	579	890	1201	1511
83	574	881	1189	1497
84	568	873	1178	1483
85	562	865	1167	1469
86	557	856	1155	1455
87	551	848	1144	1441
88	545	839	1133	1427
89	539	831	1122	1413
90	534	822	1110	1399
91	528	814	1099	1385
92	522	805	1088	1371
93	517	797	1076	1356
94	511	788	1065	1342
95	505	779	1054	1328
96	499	771	1042	1314
97	494	762	1031	1300
98	488	754	1020	1286
99	482	745	1008	1272
100	476	737	997	1257
101	471	728	986	1243
102	465	720	974	1229
103	459	711	963	1215
104	453	702	951	1201
105	448	694	940	1186
106	442	685	929	1172
107	436	677	917	1158
108	430	668	906	1144
109	425	660	895	1130
110	419	651	883	1115
111	413	642	872	1101
112	407	634	860	1087
113	401	625	849	1073
114	396	617	837	1058
115	390	608	826	1044
116	384	599	814	1030
117	378	591	803	1015
118	372	582	791	1001
119	367	573	780	987
120	361	565	769	973
121	355	556	757	958
122	349	547	745	944
123	343	539	734	929
124	337	530	722	915
125	332	521	711	901
126	326	513	699	886
127	320	504	688	872
128	314	495	676	858

Table 2. LM94021 Transfer Table (continued)

TEMPERATURE (°C)	GS = 00 (mV)	GS = 01 (mV)	GS = 10 (mV)	GS = 11 (mV)
129	308	487	665	843
130	302	478	653	829
131	296	469	642	814
132	291	460	630	800
133	285	452	618	786
134	279	443	607	771
135	273	434	595	757
136	267	425	584	742
137	261	416	572	728
138	255	408	560	713
139	249	399	549	699
140	243	390	537	684
141	237	381	525	670
142	231	372	514	655
143	225	363	502	640
144	219	354	490	626
145	213	346	479	611
146	207	337	467	597
147	201	328	455	582
148	195	319	443	568
149	189	310	432	553
150	183	301	420	538

Although the LM94021 is very linear, its response does have a slight umbrella's parabolic shape. This shape is very accurately reflected in the LM94021 Transfer Table. The Transfer Table can be calculated by using the parabolic equation.

$$\begin{aligned}
 J2, G00 : V_{TEMP} (mV) &= 870.6mV - 5.506 \frac{mV}{^{\circ}C} (T - 30^{\circ}C) - 0.00176 \frac{mV}{^{\circ}C^2} (T - 30^{\circ}C)^2 \\
 J3, G01 : V_{TEMP} (mV) &= 1324.0mV - 8.194 \frac{mV}{^{\circ}C} (T - 30^{\circ}C) - 0.00262 \frac{mV}{^{\circ}C^2} (T - 30^{\circ}C)^2 \\
 J4, G10 : V_{TEMP} (mV) &= 1777.3mV - 10.888 \frac{mV}{^{\circ}C} (T - 30^{\circ}C) - 0.00347 \frac{mV}{^{\circ}C^2} (T - 30^{\circ}C)^2 \\
 J5, G11 : V_{TEMP} (mV) &= 2230.8mV - 13.582 \frac{mV}{^{\circ}C} (T - 30^{\circ}C) - 0.00433 \frac{mV}{^{\circ}C^2} (T - 30^{\circ}C)^2
 \end{aligned} \tag{1}$$

For a linear approximation, a line can easily be calculated over the desired temperature range from the Table using the two-point equation:

$$V - V_1 = \left(\frac{V_2 - V_1}{T_2 - T_1} \right) \times (T - T_1) \tag{2}$$

Where V is in mV, T is in °C, T₁ and V₁ are the coordinates of the lowest temperature, T₂ and V₂ are the coordinates of the highest temperature.

For example, if we want to determine the equation of a line with the Gain Setting at GS1 = 0 and GS0 = 0, over a temperature range of 20°C to 50°C, we would proceed as follows:

$$V - 925 \text{ mV} = \left(\frac{760 \text{ mV} - 925 \text{ mV}}{50^{\circ}C - 20^{\circ}C} \right) \times (T - 20^{\circ}C) \tag{3}$$

$$V - 925 \text{ mV} = (-5.50 \text{ mV} / ^{\circ}C) \times (T - 20^{\circ}C) \tag{4}$$

$$V = (-5.50 \text{ mV} / ^{\circ}C) \times T + 1035 \text{ mV} \tag{5}$$

Using this method of linear approximation, the transfer function can be approximated for one or more temperature ranges of interest.

MOUNTING AND THERMAL CONDUCTIVITY

The LM94021 can be applied easily in the same way as other integrated-circuit temperature sensors. It can be glued or cemented to a surface.

To ensure good thermal conductivity, the backside of the LM94021 die is directly attached to the GND pin (Pin 2). The temperatures of the lands and traces to the other leads of the LM94021 will also affect the temperature reading.

Alternatively, the LM94021 can be mounted inside a sealed-end metal tube, and can then be dipped into a bath or screwed into a threaded hole in a tank. As with any IC, the LM94021 and accompanying wiring and circuits must be kept insulated and dry, to avoid leakage and corrosion. This is especially true if the circuit may operate at cold temperatures where condensation can occur. If moisture creates a short circuit from the output to ground or V_{DD} , the output from the LM94021 will not be correct. Printed-circuit coatings are often used to ensure that moisture cannot corrode the leads or circuit traces.

The thermal resistance junction to ambient (θ_{JA}) is the parameter used to calculate the rise of a device junction temperature due to its power dissipation. The equation used to calculate the rise in the LM94021's die temperature is

$$T_J = T_A + \theta_{JA} [(V_{DD}I_Q) + (V_{DD} - V_O) I_L] \quad (6)$$

where T_A is the ambient temperature, I_Q is the quiescent current, I_L is the load current on the output, and V_O is the output voltage. For example, in an application where $T_A = 30^\circ\text{C}$, $V_{DD} = 5\text{ V}$, $I_{DD} = 9\ \mu\text{A}$, Gain Select = 11, $V_{OUT} = 2.231\text{ mV}$, and $I_L = 2\ \mu\text{A}$, the junction temperature would be 30.021°C , showing a self-heating error of only 0.021°C . Since the LM94021's junction temperature is the actual temperature being measured, care should be taken to minimize the load current that the LM94021 is required to drive. [Table 3](#) shows the thermal resistance of the LM94021.

Table 3. LM94021 Thermal Resistance

DEVICE NUMBER	PACKAGE NUMBER	THERMAL RESISTANCE (θ_{JA})
LM94021BIMG	DCK0005A	415°C/W

NOISE CONSIDERATIONS

The LM94021 has excellent noise rejection (the ratio of the AC signal on V_{OUT} to the AC signal on V_{DD}). During bench tests, sine wave rejection of -54 dB or better was observed over 200 Hz to 10 kHz; Also, -28 dB or better was observed from 10 kHz to 1 MHz. A load capacitor on the output can help filter noise; for example, a 1 nF load capacitor resulted in -51 dB or better from 200 Hz to 1 MHz.

There is no specific requirement for the use of a bypass capacitor close to the LM94021 because it does not draw transient currents. For operation in very noisy environments, some bypass capacitance may be required. The capacitance does not need to be in close proximity to the LM94021. The LM94021 has been bench tested successfully with a bypass capacitor as far as 6 inches away. In fact, it can be powered by a properly-bypassed logic gate.

CAPACITIVE LOADS

The LM94021 handles capacitive loading well. In an extremely noisy environment, or when driving a switched sampling input on an ADC, it may be necessary to add some filtering to minimize noise coupling. Without any precautions, the LM94021 can drive a capacitive load less than or equal to 1100 pF as shown in [Figure 14](#). For capacitive loads greater than 1100 pF, a series resistor may be required on the output, as shown in [Figure 15](#).

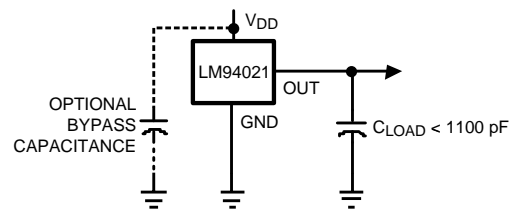

Figure 14. LM94021 No Decoupling Required for Capacitive Loads Less than 1100 pF

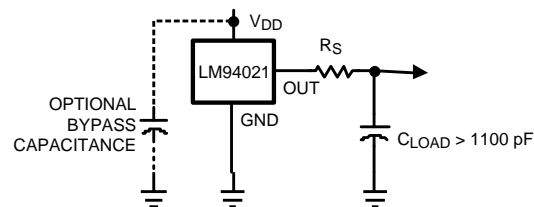

Figure 15. LM94021 with Series Resistor for Capacitive Loading greater than 1100 pF

OUTPUT VOLTAGE SHIFT

The LM94021 is very linear over temperature and supply voltage range. Due to the intrinsic behavior of an NMOS/PMOS rail-to-rail buffer, a slight shift in the output can occur when the supply voltage is ramped over the operating range of the device. The location of the shift is determined by the relative levels of V_{DD} and V_{OUT} . The shift typically occurs when $V_{DD} - V_{OUT} = 1.0V$.

This slight shift (a few millivolts) takes place over a wide change (approximately 200 mV) in V_{DD} or V_{OUT} . Since the shift takes place over a wide temperature change of 5°C to 20°C, V_{OUT} is always monotonic. The accuracy specifications in the [ELECTRICAL CHARACTERISTICS](#) table already include this possible shift.

SELECTABLE GAIN FOR OPTIMIZATION AND IN SITU TESTING

The Gain Select digital inputs can be tied to the rails or can be driven from digital outputs such as microcontroller GPIO pins. In low-supply voltage applications, the ability to reduce the gain to $-5.5 \text{ mV}/^\circ\text{C}$ allows the LM94021 to operate over the full -50°C to 150°C range. When a larger supply voltage is present, the gain can be increased as high as $-13.6 \text{ mV}/^\circ\text{C}$. The larger gain is optimal for reducing the effects of noise (for example, noise coupling on the output line or quantization noise induced by an analog-to-digital converter which may be sampling the LM94021 output).

Another application advantage of the digitally selectable gain is the ability to perform dynamic testing of the LM94021 while it is running in a system. By toggling the logic levels of the gain select pins and monitoring the resultant change in the output voltage level, the host system can verify the functionality of the LM94021.

APPLICATION CIRCUITS

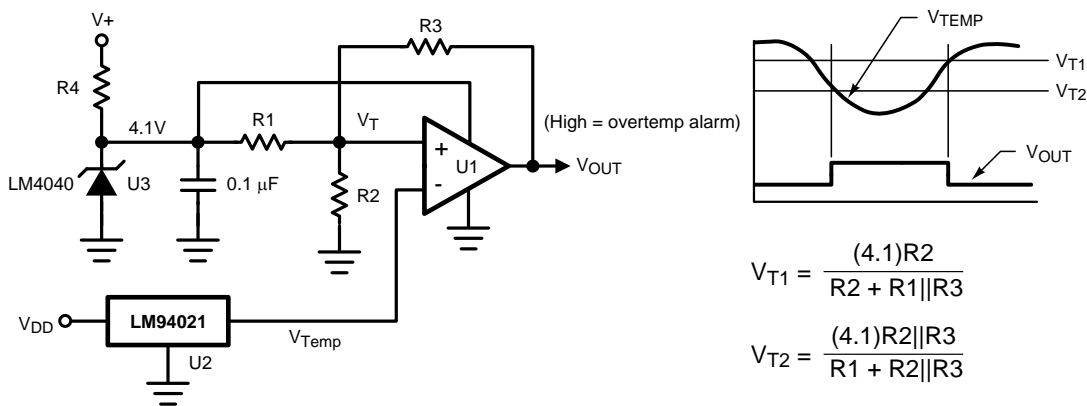

Figure 16. Celsius Thermostat

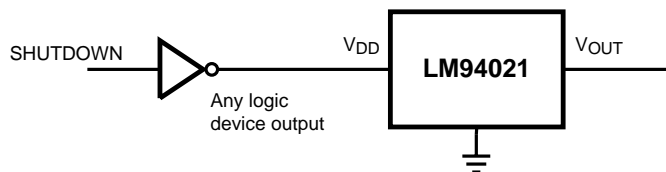
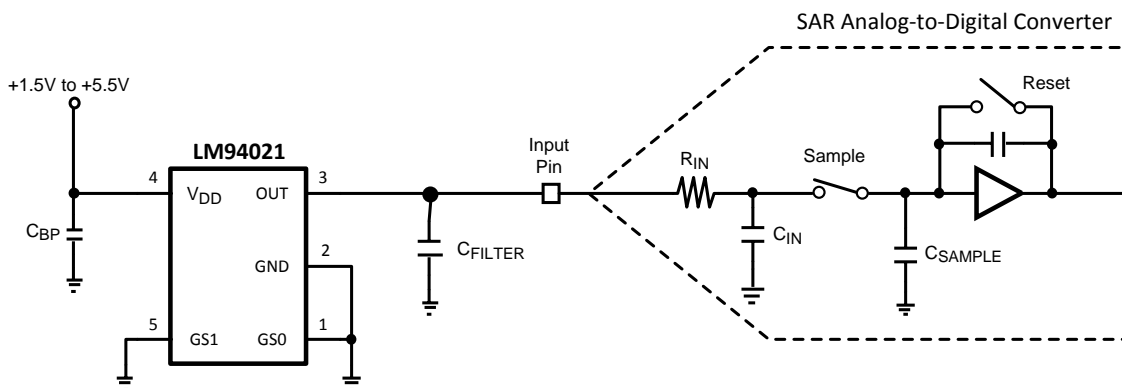

Figure 17. Conserving Power Dissipation with Shutdown



Most CMOS ADCs found in microcontrollers and ASICs have a sampled data comparator input structure. When the ADC charges the sampling cap, it requires instantaneous charge from the output of the analog source such as the LM94021 temperature sensor and many op amps. This requirement is easily accommodated by the addition of a capacitor (C_{FILTER}). The size of C_{FILTER} depends on the size of the sampling capacitor and the sampling frequency. Since not all ADCs have identical input stages, the charge requirements will vary. This general ADC application is shown as an example only.

Figure 18. Suggested Connection to a Sampling Analog-to-Digital Converter Input Stage

REVISION HISTORY

Changes from Revision C (February 2013) to Revision D	Page
• Changed layout of National Data Sheet to TI format	15

PACKAGING INFORMATION

Orderable part number	Status (1)	Material type (2)	Package Pins	Package qty Carrier	RoHS (3)	Lead finish/ Ball material (4)	MSL rating/ Peak reflow (5)	Op temp (°C)	Part marking (6)
LM94021BIMGX/NOPB	Active	Production	SC70 (DCK) 5	3000 LARGE T&R	Yes	SN	Level-1-260C-UNLIM	-50 to 150	21B
LM94021BIMGX/NOPB.A	Active	Production	SC70 (DCK) 5	3000 LARGE T&R	Yes	SN	Level-1-260C-UNLIM	-50 to 150	21B
LM94021QBIMGX/NOPB	Active	Production	SC70 (DCK) 5	3000 LARGE T&R	Yes	SN	Level-1-260C-UNLIM	-50 to 150	21Q
LM94021QBIMGX/NOPB.A	Active	Production	SC70 (DCK) 5	3000 LARGE T&R	Yes	SN	Level-1-260C-UNLIM	-50 to 150	21Q

(1) **Status:** For more details on status, see our [product life cycle](#).

(2) **Material type:** When designated, preproduction parts are prototypes/experimental devices, and are not yet approved or released for full production. Testing and final process, including without limitation quality assurance, reliability performance testing, and/or process qualification, may not yet be complete, and this item is subject to further changes or possible discontinuation. If available for ordering, purchases will be subject to an additional waiver at checkout, and are intended for early internal evaluation purposes only. These items are sold without warranties of any kind.

(3) **RoHS values:** Yes, No, RoHS Exempt. See the [TI RoHS Statement](#) for additional information and value definition.

(4) **Lead finish/Ball material:** Parts may have multiple material finish options. Finish options are separated by a vertical ruled line. Lead finish/Ball material values may wrap to two lines if the finish value exceeds the maximum column width.

(5) **MSL rating/Peak reflow:** The moisture sensitivity level ratings and peak solder (reflow) temperatures. In the event that a part has multiple moisture sensitivity ratings, only the lowest level per JEDEC standards is shown. Refer to the shipping label for the actual reflow temperature that will be used to mount the part to the printed circuit board.

(6) **Part marking:** There may be an additional marking, which relates to the logo, the lot trace code information, or the environmental category of the part.

Multiple part markings will be inside parentheses. Only one part marking contained in parentheses and separated by a "~" will appear on a part. If a line is indented then it is a continuation of the previous line and the two combined represent the entire part marking for that device.

Important Information and Disclaimer: The information provided on this page represents TI's knowledge and belief as of the date that it is provided. TI bases its knowledge and belief on information provided by third parties, and makes no representation or warranty as to the accuracy of such information. Efforts are underway to better integrate information from third parties. TI has taken and continues to take reasonable steps to provide representative and accurate information but may not have conducted destructive testing or chemical analysis on incoming materials and chemicals. TI and TI suppliers consider certain information to be proprietary, and thus CAS numbers and other limited information may not be available for release.

In no event shall TI's liability arising out of such information exceed the total purchase price of the TI part(s) at issue in this document sold by TI to Customer on an annual basis.

OTHER QUALIFIED VERSIONS OF LM94021, LM94021-Q1 :

- Catalog : [LM94021](#)
- Automotive : [LM94021-Q1](#)

NOTE: Qualified Version Definitions:

- Catalog - TI's standard catalog product
- Automotive - Q100 devices qualified for high-reliability automotive applications targeting zero defects

TAPE AND REEL INFORMATION

QUADRANT ASSIGNMENTS FOR PIN 1 ORIENTATION IN TAPE

*All dimensions are nominal

Device	Package Type	Package Drawing	Pins	SPQ	Reel Diameter (mm)	Reel Width W1 (mm)	A0 (mm)	B0 (mm)	K0 (mm)	P1 (mm)	W (mm)	Pin1 Quadrant
LM94021BIMGX/NOPB	SC70	DCK	5	3000	178.0	8.4	2.25	2.45	1.2	4.0	8.0	Q3
LM94021QBIMGX/NOPB	SC70	DCK	5	3000	178.0	8.4	2.25	2.45	1.2	4.0	8.0	Q3

TAPE AND REEL BOX DIMENSIONS

*All dimensions are nominal

Device	Package Type	Package Drawing	Pins	SPQ	Length (mm)	Width (mm)	Height (mm)
LM94021BIMGX/NOPB	SC70	DCK	5	3000	208.0	191.0	35.0
LM94021QBIMGX/NOPB	SC70	DCK	5	3000	208.0	191.0	35.0

DCK0005A



PACKAGE OUTLINE

SOT - 1.1 max height

SMALL OUTLINE TRANSISTOR

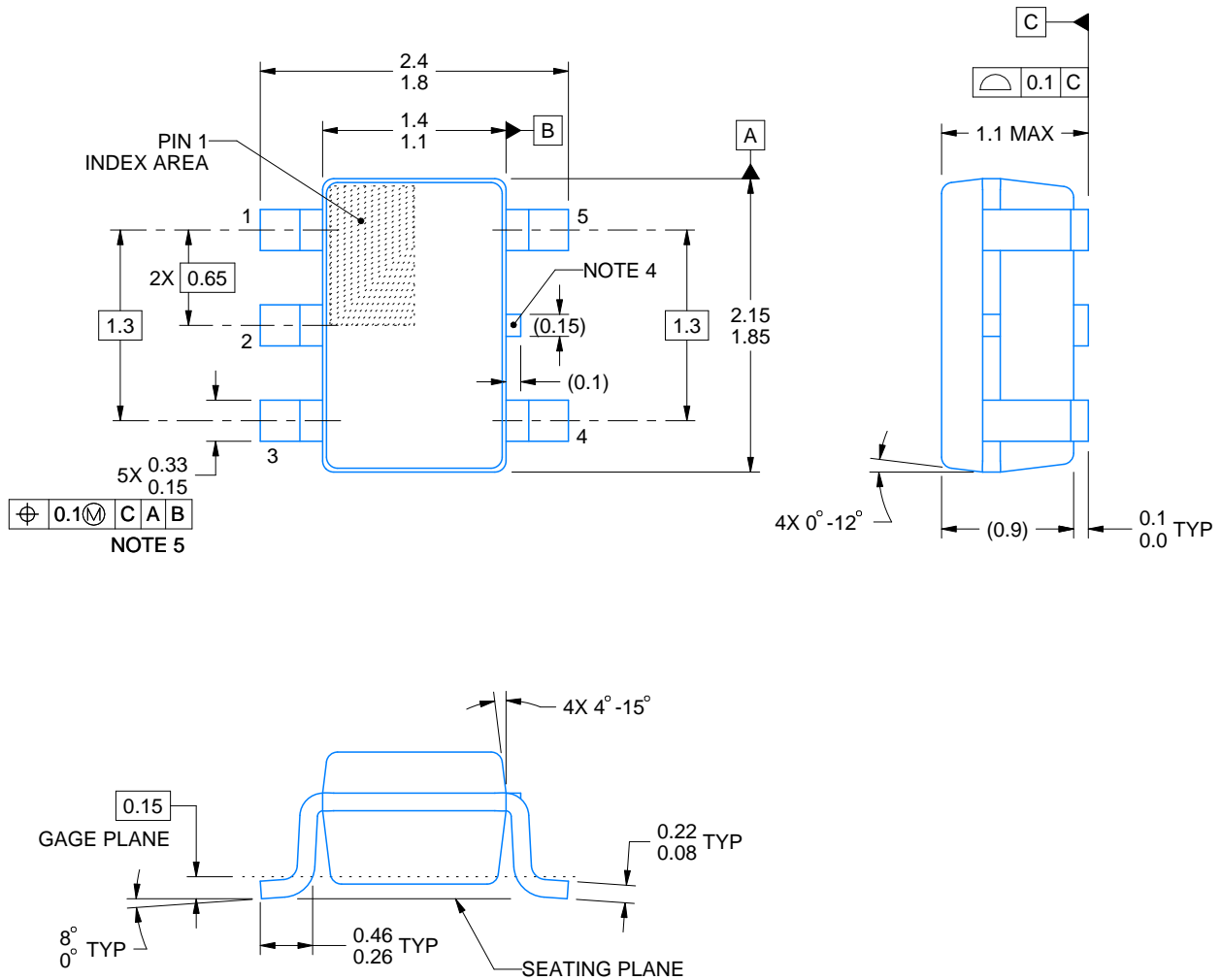

4214834/G 11/2024

NOTES:

1. All linear dimensions are in millimeters. Any dimensions in parenthesis are for reference only. Dimensioning and tolerancing per ASME Y14.5M.
2. This drawing is subject to change without notice.
3. Reference JEDEC MO-203.
4. Support pin may differ or may not be present.
5. Lead width does not comply with JEDEC.
6. Body dimensions do not include mold flash, protrusions, or gate burrs. Mold flash, protrusions, or gate burrs shall not exceed 0.25mm per side



LAND PATTERN EXAMPLE
EXPOSED METAL SHOWN
SCALE:18X

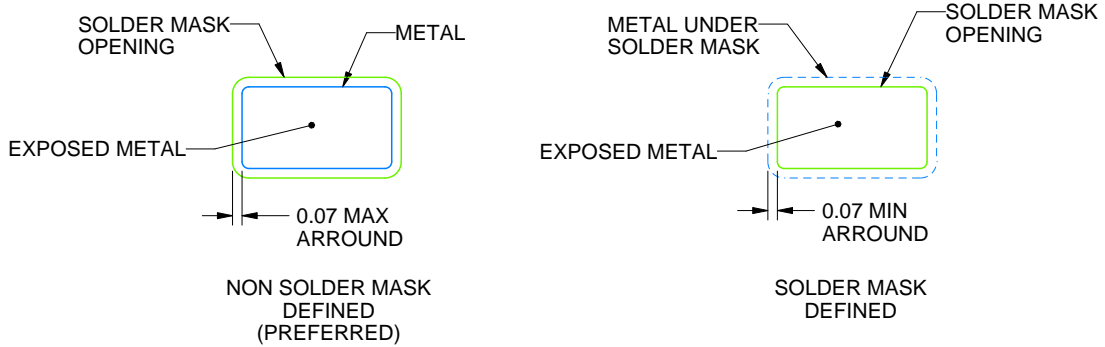

SOLDER MASK DETAILS

4214834/G 11/2024

NOTES: (continued)

- 7. Publication IPC-7351 may have alternate designs.
- 8. Solder mask tolerances between and around signal pads can vary based on board fabrication site.

EXAMPLE STENCIL DESIGN

DCK0005A

SOT - 1.1 max height

SMALL OUTLINE TRANSISTOR



SOLDER PASTE EXAMPLE
BASED ON 0.125 THICK STENCIL
SCALE:18X

4214834/G 11/2024

NOTES: (continued)

9. Laser cutting apertures with trapezoidal walls and rounded corners may offer better paste release. IPC-7525 may have alternate design recommendations.
10. Board assembly site may have different recommendations for stencil design.

IMPORTANT NOTICE AND DISCLAIMER

TI PROVIDES TECHNICAL AND RELIABILITY DATA (INCLUDING DATASHEETS), DESIGN RESOURCES (INCLUDING REFERENCE DESIGNS), APPLICATION OR OTHER DESIGN ADVICE, WEB TOOLS, SAFETY INFORMATION, AND OTHER RESOURCES "AS IS" AND WITH ALL FAULTS, AND DISCLAIMS ALL WARRANTIES, EXPRESS AND IMPLIED, INCLUDING WITHOUT LIMITATION ANY IMPLIED WARRANTIES OF MERCHANTABILITY, FITNESS FOR A PARTICULAR PURPOSE OR NON-INFRINGEMENT OF THIRD PARTY INTELLECTUAL PROPERTY RIGHTS.

These resources are intended for skilled developers designing with TI products. You are solely responsible for (1) selecting the appropriate TI products for your application, (2) designing, validating and testing your application, and (3) ensuring your application meets applicable standards, and any other safety, security, regulatory or other requirements.

These resources are subject to change without notice. TI grants you permission to use these resources only for development of an application that uses the TI products described in the resource. Other reproduction and display of these resources is prohibited. No license is granted to any other TI intellectual property right or to any third party intellectual property right. TI disclaims responsibility for, and you fully indemnify TI and its representatives against any claims, damages, costs, losses, and liabilities arising out of your use of these resources.

TI's products are provided subject to [TI's Terms of Sale](#), [TI's General Quality Guidelines](#), or other applicable terms available either on [ti.com](#) or provided in conjunction with such TI products. TI's provision of these resources does not expand or otherwise alter TI's applicable warranties or warranty disclaimers for TI products. Unless TI explicitly designates a product as custom or customer-specified, TI products are standard, catalog, general purpose devices.

TI objects to and rejects any additional or different terms you may propose.

Copyright © 2026, Texas Instruments Incorporated

Last updated 10/2025