

# LMK1C110x-Q1 1.8V, 2.5V, and 3.3V Low Noise LVCMOS Clock Buffer Family

## 1 Features

- High-performance 1:2, 1:4, 1:6 and 1:8 LVCMOS clock buffer
- Very low output skew:
  - LMK1C1102-Q1 and LMK1C1104-Q1
    - < 50ps
  - LMK1C1106-Q1 and LMK1C1108-Q1
    - < 55ps
- Extremely low additive jitter:
  - LMK1C1102-Q1 and LMK1C1104-Q1
    - 7.5fs typical at  $V_{DD} = 3.3V$
    - 10fs typical at  $V_{DD} = 2.5V$
    - 19.2fs typical at  $V_{DD} = 1.8V$
  - LMK1C1106-Q1 and LMK1C1108-Q1
    - 12fs typical at  $V_{DD} = 3.3V$
    - 15fs typical at  $V_{DD} = 2.5V$
    - 28fs typical at  $V_{DD} = 1.8V$
- Very low propagation delay < 3ns
- Synchronous output enable
- Supply voltage: 3.3V, 2.5V, or 1.8V
  - 3.3V tolerant input at all supply voltages
  - Fail-safe inputs
- $f_{max} = 250MHz$  for 3.3V  
 $f_{max} = 200MHz$  for 2.5V and 1.8V
- Automotive Grade 1 (–40°C to 125°C)
- AEC-Q100 qualified
- Available in:
  - 14 and 16-Pin TSSOP Package
  - 8-Pin WSON Package

## 2 Applications

- **Automotive**
  - ADAS
  - Infotainment & Cluster
  - Radar

## 3 Description

The LMK1C110x-Q1 is a modular, high-performance, low-skew, general-purpose clock buffer family from Texas Instruments. The entire family is designed with a modular approach in mind. Five different fan-out variations, 1:2, 1:4, 1:6 and 1:8 are available.

All family members share the same high performing characteristics such as low additive jitter, low skew, and wide operating temperature range.

The LMK1C110x-Q1 supports a synchronous output enable control (1G) which switches the outputs into a low state when 1G is low. These devices have a fail-safe input that prevents oscillation at the outputs in the absence of an input signal and allows for input signals before VDD is supplied.

The LMK1C110x-Q1 family are available in an Automotive Grade 1 (–40°C to 125°C) and AEC-Q100 qualified.

### Package Information

PART NUMBER	PACKAGE <sup>(1)</sup>	PACKAGE SIZE <sup>(2)</sup>
LMK1C1106-Q1	PW (TSSOP, 14)	5.00mm × 4.40mm
LMK1C1108-Q1	PW (TSSOP, 16)	
LMK1C1102-Q1	DQF (WSON, 8)	2.00mm × 2.00mm
LMK1C1104-Q1		

(1) For more information, see [Section 12](#).

(2) The package size (length × width) is a nominal value and includes pins, where applicable.

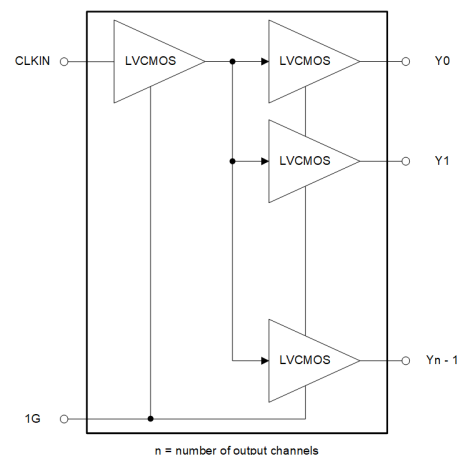

**Functional Block Diagram**



## Table of Contents

<b>1 Features</b> .....	<b>1</b>	8.4 Device Functional Modes.....	<b>13</b>
<b>2 Applications</b> .....	<b>1</b>	<b>9 Application and Implementation</b> .....	<b>14</b>
<b>3 Description</b> .....	<b>1</b>	9.1 Application Information.....	14
<b>4 Device Comparison</b> .....	<b>2</b>	9.2 Typical Application.....	14
<b>5 Pin Configuration and Functions</b> .....	<b>3</b>	9.3 Power Supply Recommendations.....	15
<b>6 Specifications</b> .....	<b>5</b>	9.4 Layout.....	16
6.1 Absolute Maximum Ratings.....	5	<b>10 Device and Documentation Support</b> .....	<b>17</b>
6.2 ESD Ratings.....	5	10.1 Documentation Support.....	17
6.3 Recommended Operating Conditions.....	5	10.2 Receiving Notification of Documentation Updates..	17
6.4 Thermal Information.....	5	10.3 Support Resources.....	17
6.5 Electrical Characteristics.....	6	10.4 Trademarks.....	17
6.6 Timing Requirements.....	7	10.5 Electrostatic Discharge Caution.....	17
6.7 Typical Characteristics.....	8	10.6 Glossary.....	17
<b>7 Parameter Measurement Information</b> .....	<b>10</b>	<b>11 Revision History</b> .....	<b>17</b>
<b>8 Detailed Description</b> .....	<b>12</b>	<b>12 Mechanical, Packaging, and Orderable Information</b> .....	<b>17</b>
8.1 Overview.....	12	PACKAGING INFORMATION.....	18
8.2 Functional Block Diagram.....	12	12.1 Tape and Reel Information.....	19
8.3 Feature Description.....	13		

## 4 Device Comparison

**Table 4-1. Device Comparison**

DEVICE	Input	Output	Output Enable Option (1G)	PACKAGE
<a href="#">LMK1C1102</a>	1	2	Synchronous	WSO8 (8), 2.00mm × 2.00mm
<a href="#">LMK1C1104</a>	1	4	Synchronous	WSO8 (8), 2.00mm × 2.00mm
<a href="#">LMK1C1102</a>	1	2	Synchronous	TSSOP (8), 3.00mm × 4.40mm
<a href="#">LMK1C1103</a>	1	3	Synchronous	TSSOP (8), 3.00mm × 4.40mm
<a href="#">LMK1C1104</a>	1	4	Synchronous	TSSOP (8), 3.00mm × 4.40mm
<a href="#">LMK1C1106</a>	1	6	Synchronous	TSSOP (14), 5.00mm × 4.40mm
<a href="#">LMK1C1108</a>	1	8	Synchronous	TSSOP (16), 5.00mm × 4.40mm
<a href="#">LMK1C1102-Q1 <sup>(1)</sup></a>	1	2	Synchronous	WSO8 (8), 2.00mm × 2.00mm
<a href="#">LMK1C1104-Q1 <sup>(1)</sup></a>	1	4	Synchronous	WSO8 (8), 2.00mm × 2.00mm
<a href="#">LMK1C1106-Q1</a>	1	6	Synchronous	TSSOP (14), 5.00mm × 4.40mm
<a href="#">LMK1C1108-Q1</a>	1	8	Synchronous	TSSOP (16), 5.00mm × 4.40mm

(1) Preview Only. Contact TI for more information on the device.

## 5 Pin Configuration and Functions

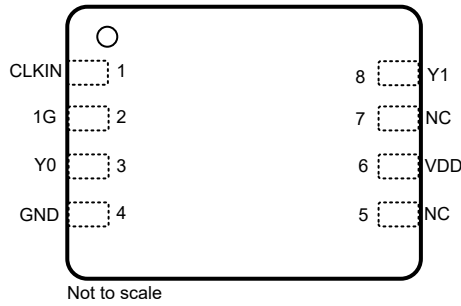

1. The DQF (WSO) package is equivalent to the DFN package of other vendors.

**Figure 5-1. LMK1C1102-Q1, 8-Pin DQF WSON Package (Top View)**

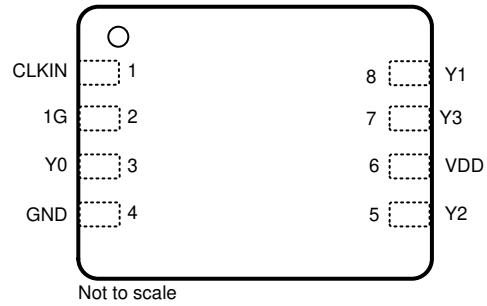

1. The DQF (WSO) package is equivalent to the DFN package of other vendors.

**Figure 5-2. LMK1C1104-Q1, 8-Pin DQF WSON Package (Top View)**

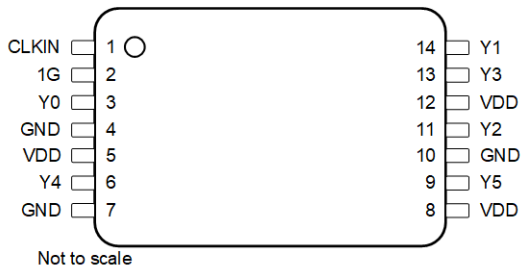

**Figure 5-3. LMK1C1106-Q1, 14-Pin PW TSSOP Package (Top View)**

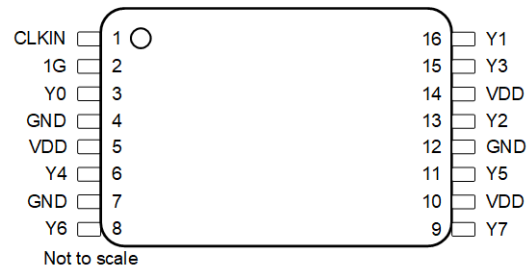

**Figure 5-4. LMK1C1108-Q1, 16-Pin PW TSSOP Package (Top View)**

Table 5-1. Pin Functions

PIN				TYPE	DESCRIPTION
LMK1C 1102-Q1	LMK1C 1104-Q1	LMK1C 1106-Q1	LMK1C 1108-Q1		
<b>LVC MOS CLOCK INPUT</b>					
1	1	1	1	Input	Single-ended clock input with internal 300-kΩ (typical) pulldown resistor to GND. Typically connected to a single-ended clock input.
<b>CLOCK OUTPUT ENABLE</b>					
2	2	2	2	Input	Global Output Enable with internal 300-kΩ (typical) pulldown resistor to GND. Typically connected to VDD with external pullup resistor. HIGH: outputs enabled LOW: outputs disabled
<b>LVC MOS CLOCK OUTPUT</b>					
3	3	3	3	Output	LVC MOS output. Typically connected to a receiver. Unused outputs can be left floating.
8	8	14	16		
—	5	11	13		
—	7	13	15		
—	—	6	6		
—	—	9	11		
—	—	—	8		
—	—	—	9		
<b>SUPPLY VOLTAGE</b>					
6	6	5	5	Power	Power supply terminal. Typically connected to a 3.3-V, 2.5-V, or 1.8-V supply. The VDD pin is typically connected to an external 0.1-μF capacitor near the pin.
		8	10		
		12	14		
<b>GROUND</b>					
4	4	4	4	GND	Power supply ground.
		7	7		
		10	12		

ADVANCE INFORMATION

## 6 Specifications

### 6.1 Absolute Maximum Ratings

over operating free-air temperature range (unless otherwise noted)<sup>(1)</sup>

		MIN	MAX	UNIT
V <sub>DD</sub>	Supply voltage	-0.5	3.6	V
V <sub>CLKIN</sub>	Input voltage (CLKIN)			
V <sub>IN</sub>	Input voltage (1G)			
V <sub>Yn</sub>	Output pins (Yn)	-0.5	V <sub>DD</sub> + 0.3	
I <sub>IN</sub>	Input current	-20	20	mA
I <sub>O</sub>	Continuous output current	-50	50	mA
T <sub>stg</sub>	Storage temperature	-65	150	°C

- (1) Operation outside the *Absolute Maximum Ratings* may cause permanent device damage. *Absolute Maximum Ratings* do not imply functional operation of the device at these or any other conditions beyond those listed under *Recommended Operating Conditions*. If used outside the *Recommended Operating Conditions* but within the *Absolute Maximum Ratings*, the device may not be fully functional, and this may affect device reliability, functionality, performance, and shorten the device lifetime.

### 6.2 ESD Ratings

			VALUE	UNIT
V <sub>(ESD)</sub>	Electrostatic discharge	Human-body model (HBM), per AEC Q100-002 <sup>(1)</sup>	±9000	V
V <sub>(ESD)</sub>	Electrostatic discharge	Charged-device model (CDM), per AEC Q100-0111	±1500	V

- (1) AEC Q100-002 indicates that HBM stressing shall be in accordance with the ANSI/ESDA/JEDEC JS-001 specification.

### 6.3 Recommended Operating Conditions

over operating free-air temperature range (unless otherwise noted)

			MIN	NOM	MAX	UNIT
V <sub>DD</sub>	Core supply voltage	3.3-V supply	3.135	3.3	3.465	V
		2.5-V supply	2.375	2.5	2.625	
		1.8-V supply	1.71	1.8	1.89	
T <sub>A</sub>	Operating free-air temperature		-40		125	°C
T <sub>J</sub>	Operating junction temperature		-40		150	°C

### 6.4 Thermal Information

THERMAL METRIC <sup>(1)</sup>		LMK1C1102-Q1, LMK1C1104-Q1	LMK1C1106-Q1	LMK1C1108-Q1	UNIT
		DQF(WSON)	PW (TSSOP)	PW(TSSOP)	
		8 PINS	14 PINS	16 PINS	
R <sub>qJA</sub>	Junction-to-ambient thermal resistance	163	114.4	123.4	°C/W
R <sub>qJC(top)</sub>	Junction-to-case (top) thermal resistance	105.7	45.2	53.1	°C/W
R <sub>qJB</sub>	Junction-to-board thermal resistance	84.2	60.6	66.4	°C/W
Y <sub>JT</sub>	Junction-to-top characterization parameter	16.7	5.9	8.9	°C/W
Y <sub>JB</sub>	Junction-to-board characterization parameter	83.9	60	65.8	°C/W

- (1) For more information about traditional and new thermal metrics, see the [Semiconductor and IC Package Thermal Metrics](#) application note.

## 6.5 Electrical Characteristics

V<sub>DD</sub> = 3.3V ± 5%, –40°C ≤ TA ≤ 125°C. Typical values are at V<sub>DD</sub> = 3.3V, 25°C (unless otherwise noted)

PARAMETER		TEST CONDITIONS	MIN	TYP	MAX	UNIT
<b>CURRENT CONSUMPTION</b>						
I <sub>DD</sub>	Core supply current, static	All-outputs disabled, f <sub>IN</sub> = 0V		25	45	μA
I <sub>DD</sub>	Core supply current	All-outputs disabled, f <sub>IN</sub> = 100MHz, V <sub>DD</sub> = 1.8V		2	6	mA
I <sub>DD</sub>	Core supply current	All-outputs disabled, f <sub>IN</sub> = 100MHz, V <sub>DD</sub> = 2.5V		6.5	10	mA
I <sub>DD</sub>	Core supply current	All-outputs disabled, f <sub>IN</sub> = 100MHz, V <sub>DD</sub> = 3.3V		15	21	mA
I <sub>DD</sub>	Output current	Per output, f <sub>IN</sub> = 100MHz, C <sub>L</sub> = 5pF, V <sub>DD</sub> = 1.8V		3.2	3.5	
		Per output, f <sub>IN</sub> = 100MHz, C <sub>L</sub> = 5pF, V <sub>DD</sub> = 2.5V		4.6	5.5	
		Per output, f <sub>IN</sub> = 100MHz, C <sub>L</sub> = 5pF, V <sub>DD</sub> = 3.3V		6	7	
<b>CLOCK INPUT</b>						
f <sub>IN_SE</sub>	Input frequency	V <sub>DD</sub> = 3.3V	DC		250	MHz
		V <sub>DD</sub> = 2.5V and 1.8V	DC		200	
V <sub>IH</sub>	Input high voltage		0.7x V <sub>DD</sub>			V
V <sub>IL</sub>	Input low voltage				0.3x V <sub>DD</sub>	
dV <sub>IN</sub> /dt	Input slew rate	20% - 80% of input swing	0.1			V/ns
I <sub>IN_LEAK</sub>	Input leakage current		–50		50	μA
C <sub>IN_SE</sub>	Input capacitance	at 25°C		7		pF
<b>CLOCK OUTPUT FOR ALL V<sub>DD</sub> LEVELS</b>						
f <sub>OUT</sub>	Output frequency	V <sub>DD</sub> = 3.3V			250	MHz
		V <sub>DD</sub> = 2.5V and 1.8V			200	
ODC	Output duty cycle	With 50% duty cycle input	45		55	%
t <sub>1G_ON</sub>	Output enable time	See (1)			5	cycles
t <sub>1G_OFF</sub>	Output disable time	See (2)			5	cycles
<b>CLOCK OUTPUT FOR V<sub>DD</sub> = 3.3V ± 5%</b>						
V <sub>OH</sub>	Output high voltage	I <sub>OH</sub> = 1mA	2.8			V
V <sub>OL</sub>	Output low voltage	I <sub>OL</sub> = 1mA			0.2	
t <sub>RISE-FALL</sub>	Output rise and fall time	20/80%, C <sub>L</sub> = 5pF, f <sub>IN</sub> = 156.25MHz		0.3	0.7	ns
t <sub>OUTPUT-SKEW</sub>	Output-output skew	LMK1C1102-Q1, LMK1C1104-Q1. See (3)		25	50	ps
t <sub>OUTPUT-SKEW</sub>	Output-output skew	LMK1C1106-Q1, LMK1C1108-Q1. See (3)		25	50	ps
t <sub>PART-SKEW</sub>	Part-to-part skew	LMK1C1102-Q1, LMK1C1104-Q1			250	ps
t <sub>PART-SKEW</sub>	Part-to-part skew	LMK1C1106-Q1, LMK1C1108-Q1			280	ps
t <sub>PROP-DELAY</sub>	Propagation delay	LMK1C1102-Q1, LMK1C1104-Q1. See (4)		1.5	2	ns
t <sub>PROP-DELAY</sub>	Propagation delay	LMK1C1106-Q1, LMK1C1108-Q1. See (4)		1.5	2.2	ns
t <sub>JITTER-ADD</sub>	Additive Jitter	f <sub>IN</sub> = 156.25MHz, Input slew rate = 1.6V/ns, Integration range = 12kHz - 20MHz		12	20	fs, RMS
R <sub>OUT</sub>	Output impedance			50		Ω
<b>CLOCK OUTPUT FOR V<sub>DD</sub> = 2.5V ± 5%</b>						
V <sub>OH</sub>	Output high voltage	I <sub>OH</sub> = 1mA	0.8x V <sub>DD</sub>			V
V <sub>OL</sub>	Output low voltage	I <sub>OL</sub> = 1mA			0.2x V <sub>DD</sub>	
t <sub>RISE-FALL</sub>	Output rise and fall time	20/80%, C <sub>L</sub> = 5pF, f <sub>IN</sub> = 156.25MHz		0.33	0.8	ns

VDD = 3.3V ± 5%, –40°C ≤ TA ≤ 125°C. Typical values are at VDD = 3.3V, 25°C (unless otherwise noted)

PARAMETER		TEST CONDITIONS	MIN	TYP	MAX	UNIT
t <sub>OUTPUT-SKEW</sub>	Output-output skew	LMK1C1102-Q1, LMK1C1104-Q1. See (3)			50	ps
t <sub>OUTPUT-SKEW</sub>	Output-output skew	LMK1C1106-Q1, LMK1C1108-Q1. See (3)			55	ps
t <sub>PART-SKEW</sub>	Part-to-part skew	LMK1C1102-Q1, LMK1C1104-Q1			400	ps
t <sub>PART-SKEW</sub>	Part-to-part skew	LMK1C1106-Q1, LMK1C1108-Q1			450	ps
t <sub>PROP-DELAY</sub>	Propagation delay	LMK1C1102-Q1, LMK1C1104-Q1. See (4)		1.5	2.5	ns
t <sub>PROP-DELAY</sub>	Propagation delay	LMK1C1106-Q1, LMK1C1108-Q1. See (4)		1.5	2.5	
t <sub>JITTER-ADD</sub>	Additive Jitter	f <sub>IN</sub> = 156.25MHz, Input slew rate = 1.2V/ns, Integration range = 12kHz - 20MHz		15	27	fs, RMS
R <sub>OUT</sub>	Output impedance			55		Ω
<b>CLOCK OUTPUT FOR V<sub>DD</sub> = 1.8V ± 5%</b>						
V <sub>OH</sub>	Output high voltage	I <sub>OH</sub> = 1mA	0.8x V <sub>DD</sub>			V
V <sub>OL</sub>	Output low voltage	I <sub>OL</sub> = 1mA			0.2x V <sub>DD</sub>	
t <sub>RISE-FALL</sub>	Output rise and fall time	20/80%, C <sub>L</sub> = 5pF, f <sub>IN</sub> = 156.25MHz		0.38	1	ns
t <sub>OUTPUT-SKEW</sub>	Output-output skew	LMK1C1102-Q1, LMK1C1104-Q1. See (3)			50	ps
t <sub>OUTPUT-SKEW</sub>	Output-output skew	LMK1C1106-Q1, LMK1C1108-Q1. See (3)			55	ps
t <sub>PART-SKEW</sub>	Part-to-part skew	LMK1C1102-Q1, LMK1C1104-Q1			900	ps
t <sub>PART-SKEW</sub>	Part-to-part skew	LMK1C1106-Q1, LMK1C1108-Q1			930	ps
t <sub>PROP-DELAY</sub>	Propagation delay	LMK1C1102-Q1, LMK1C1104-Q1. See (4)		1.5	3	ns
t <sub>PROP-DELAY</sub>	Propagation delay	LMK1C1106-Q1, LMK1C1108-Q1. See (4)		1.5	3	ns
t <sub>JITTER-ADD</sub>	Additive Jitter	f <sub>IN</sub> = 156.25MHz, Input slew rate = 1.2V/ns, Integration range = 12kHz - 20MHz		28	60	fs, RMS
R <sub>OUT</sub>	Output impedance			64		Ω
<b>GENERAL PURPOSE INPUT (1G)</b>						
V <sub>IH</sub>	High-level input voltage		0.75x V <sub>DD</sub>			V
V <sub>IL</sub>	Low-level input voltage	LMK1C1102-Q1, LMK1C1104-Q1			0.38x V <sub>DD</sub>	V
V <sub>IL</sub>	Low-level input voltage	LMK1C1106-Q1, LMK1C1108-Q1			0.25x V <sub>DD</sub>	V
I <sub>IH</sub>	Input high-level current	V <sub>IH</sub> = V <sub>DD_REF</sub>	–50		50	μA
I <sub>IL</sub>	Input low-level current	V <sub>IL</sub> = GND	–50		50	

- (1) Measured from 1G rising edge crossing V<sub>IH</sub> to first rising edge of Y<sub>n</sub>.
- (2) Measured from 1G falling edge crossing V<sub>IL</sub> to last falling edge of Y<sub>n</sub>.
- (3) Measured from rising edge of any Y<sub>n</sub> output to any other Y<sub>m</sub> output.
- (4) Measured from rising edge of CLKIN to any Y<sub>n</sub> output.

## 6.6 Timing Requirements

VDD = 3.3 V ± 5 %, –40°C ≤ TA ≤ 125°C

		MIN	NOM	MAX	UNIT
<b>POWER SUPPLY</b>					
V/t <sub>RAMP</sub>	V <sub>DD</sub> ramp rate	0.1		50	V/ms

## 6.7 Typical Characteristics

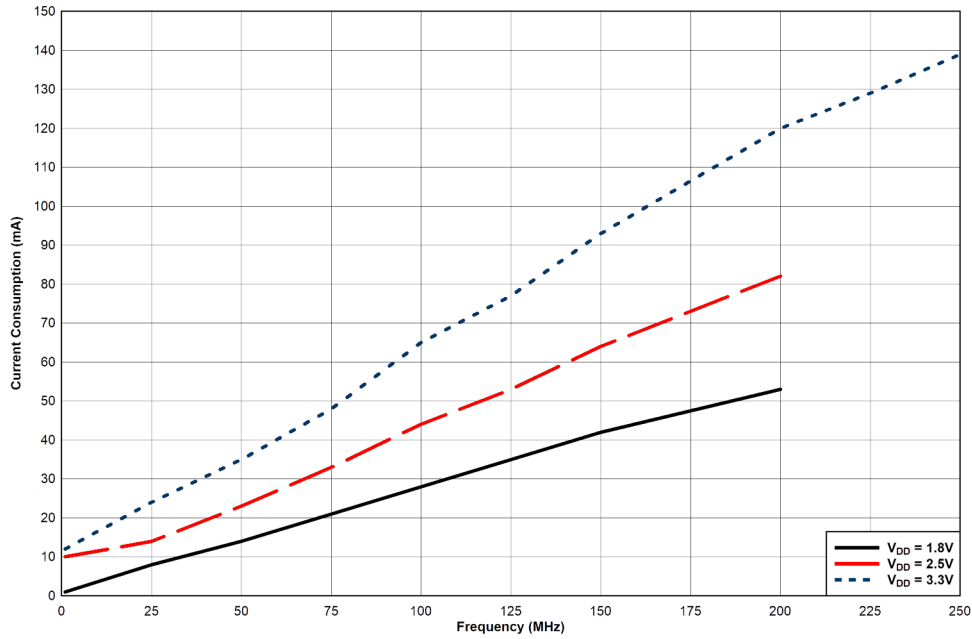

1. All outputs enabled.

### LMK1C1106-Q1 and LMK1C1108-Q1 Device Power Consumption vs. Clock Frequency (Load 5 pF)

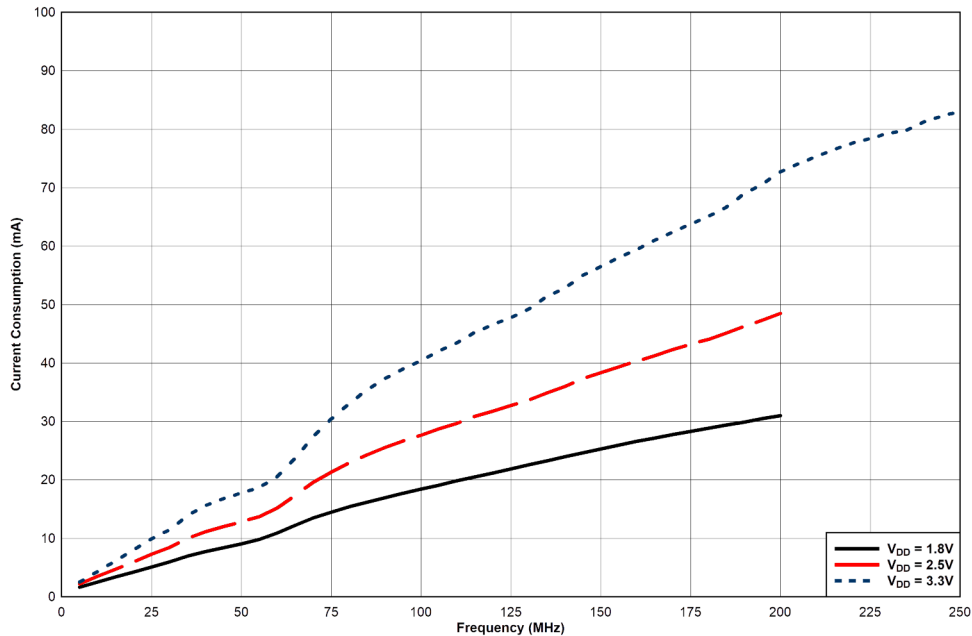

1. All outputs enabled.

**Figure 6-1. LMK1C1102-Q1 and LMK1C1104-Q1 Device Power Consumption vs. Clock Frequency (Load 5 pF)**

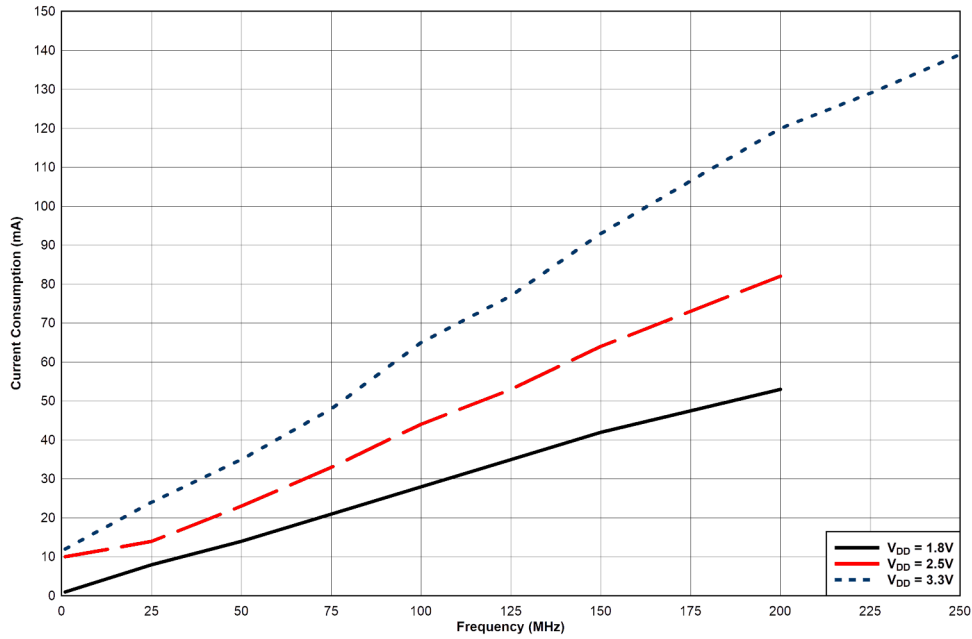

1. All outputs enabled.

**LMK1C1106-Q1 and LMK1C1108-Q1 Device Power Consumption vs. Clock Frequency (Load 5 pF)**

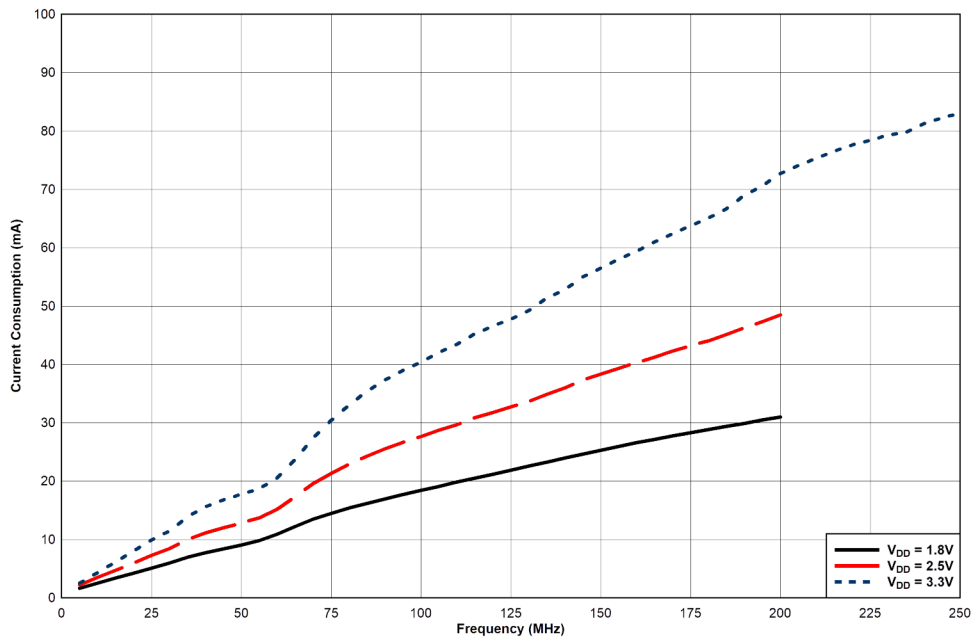

1. All outputs enabled.

**Figure 6-2. LMK1C1102-Q1 and LMK1C1104-Q1 Device Power Consumption vs. Clock Frequency (Load 5 pF)**

ADVANCE INFORMATION

## 7 Parameter Measurement Information

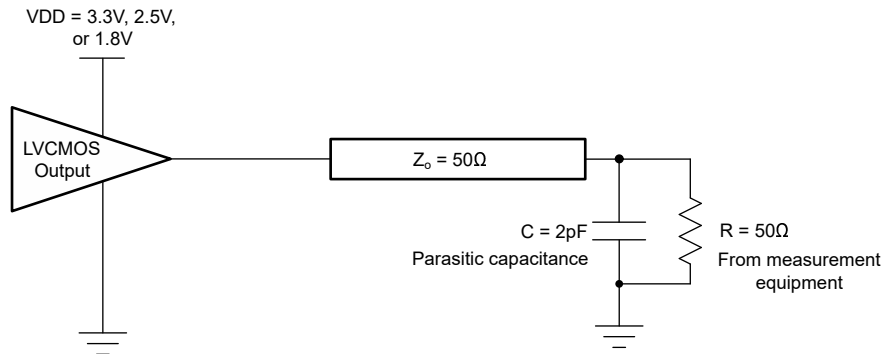

**Figure 7-1. Test Load Circuit**

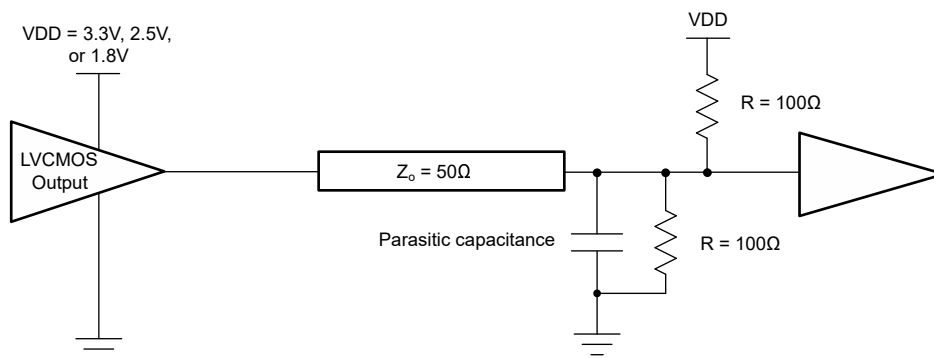

**Figure 7-2. Application Load With 50-Ω Termination**

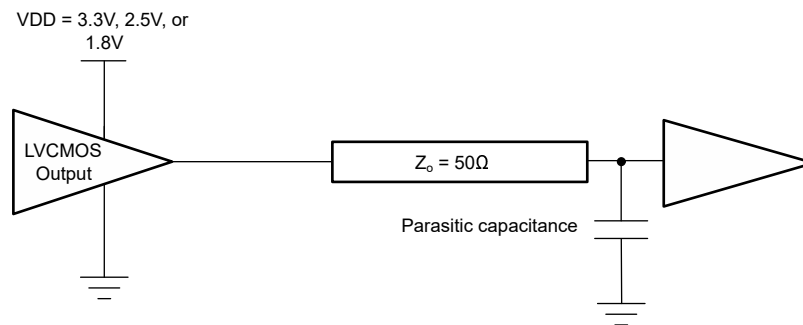

**Figure 7-3. Application Load With Termination**

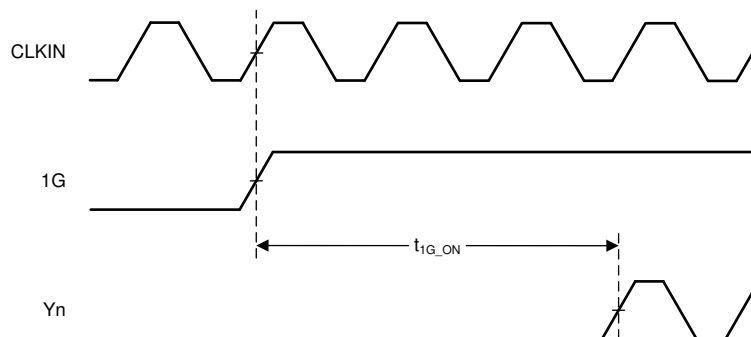

**Figure 7-4.  $t_{1G\_ON}$  Output Enable Time**

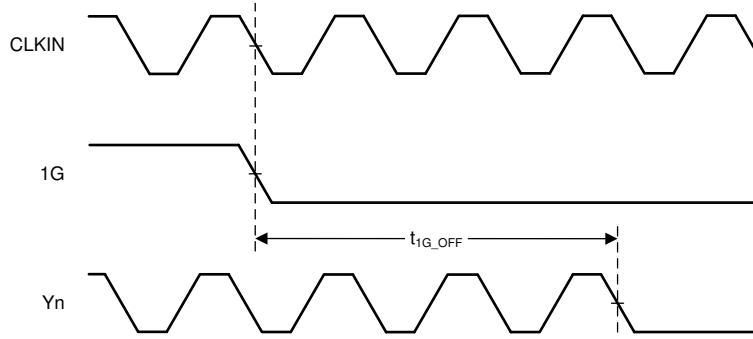

**Figure 7-5.  $t_{1G\_OFF}$  Output Disable Time**

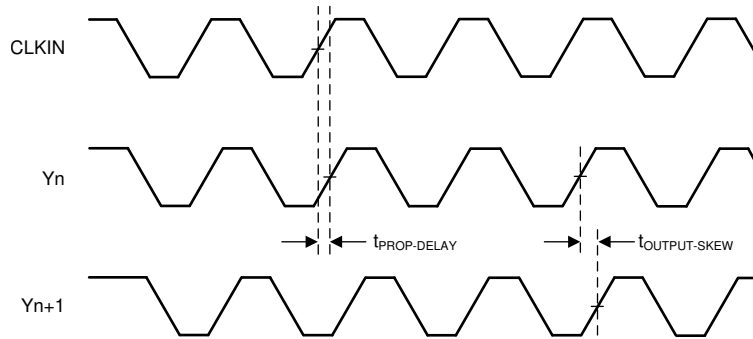

**Figure 7-6. Propagation Delay  $t_{PROP-DELAY}$  and Output Skew  $t_{OUTPUT-SKEW}$**

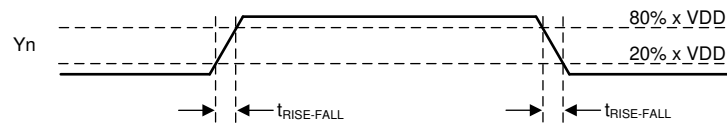

**Figure 7-7. Rise and Fall Time  $t_{RISE-FALL}$**

## 8 Detailed Description

### 8.1 Overview

The LMK1C110x-Q1 family of devices is part of a low-jitter and low-skew LVCMOS fan-out buffer solution. Matching the characteristic impedance of the LMK1C110x-Q1 output driver with the characteristic impedance of the transmission driver is important for the best signal integrity.

### 8.2 Functional Block Diagram

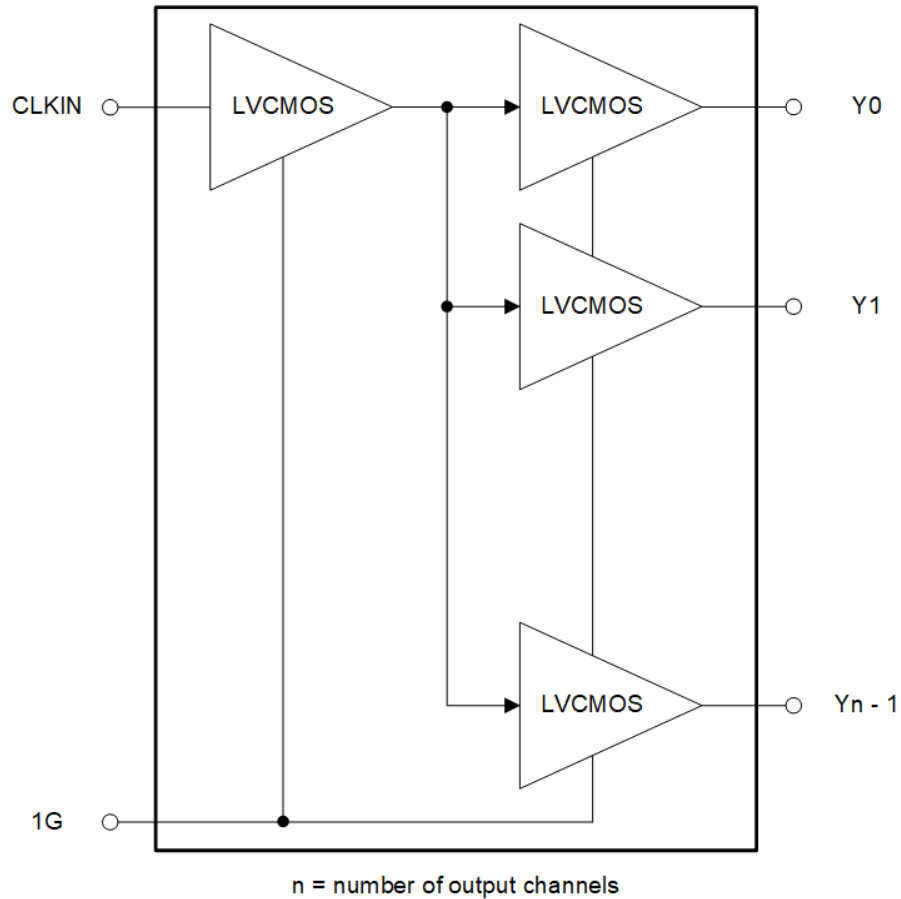

ADVANCE INFORMATION

## 8.3 Feature Description

The outputs of the LMK1C110x-Q1 can be disabled by driving the synchronous output enable pin (1G) low. Unused output can be left floating to reduce overall system component cost. Supply and ground pins must be connected to V<sub>DD</sub> and GND, respectively.

### 8.3.1 Fail-Safe Inputs

The LMK1C110x-Q1 family of devices is designed to support fail-safe input operation. This feature allows the user to drive the device inputs before V<sub>DD</sub> is applied without damaging the device. Refer to *Absolute Maximum Ratings* for more information on the maximum input supported by the device. The device also incorporates an input hysteresis that prevents random oscillation in absence of an input signal, allowing the input pins to be left open.

### 8.3.2 Synchronous Output Enable

Synchronous output enable makes sure that all the output clocks are synchronized before the output is enabled. For high speed clock inputs, adding delays for glitches due to asynchronous output enable is difficult. Synchronous output enable provides glitchless output enable by synchronizing the outputs with clock input. See [Section 4](#) for available output enable options from TI.

## 8.4 Device Functional Modes

The LMK1C110x-Q1 operates from 1.8V, 2.5V, or 3.3V supplies. [Table 8-1](#) shows the output logics of the LMK1C110x-Q1. Synchronous output enable pin requires a clock edge for the outputs to follow the "L" and "H" logic of the input.

**Table 8-1. Output Logic Table**

INPUTS		OUTPUTS
CLKIN	1G	Yn
X	L	L
L	H	L
H	H	H

## 9 Application and Implementation

### Note

Information in the following applications sections is not part of the TI component specification, and TI does not warrant its accuracy or completeness. TI's customers are responsible for determining suitability of components for their purposes, as well as validating and testing their design implementation to confirm system functionality.

### 9.1 Application Information

The LMK1C110x-Q1 family is a low additive jitter LVCMOS buffer design that can operate up to 250MHz at  $V_{DD} = 3.3V$  and 200MHz at  $V_{DD} = 2.5V, 1.8V$ . Low output skew as well as the ability for synchronous output enable is featured to simultaneously enable or disable buffered clock outputs as necessary in the application.

### 9.2 Typical Application

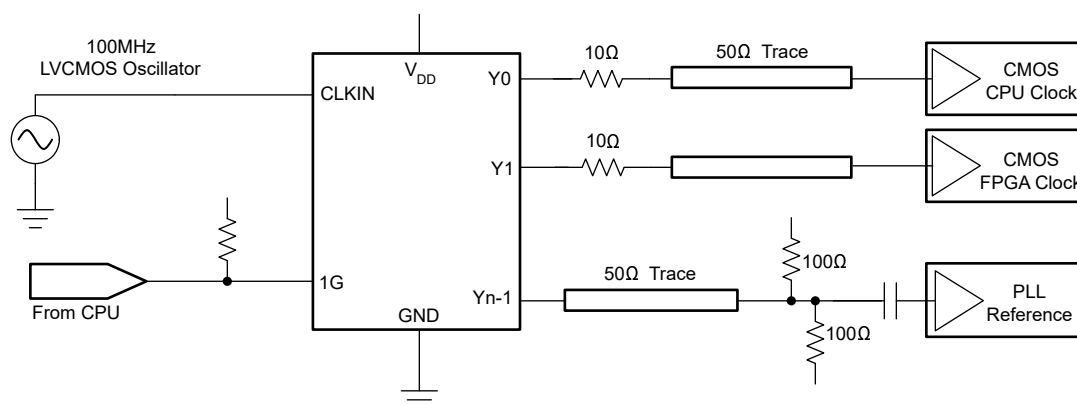

**Figure 9-1. System Configuration Example**

#### 9.2.1 Design Requirements

The LMK1C110x-Q1 shown in [Figure 9-1](#) is configured to fan out a 100-MHz signal from a local LVCMOS oscillator. The CPU is configured to control the output state through 1G.

The configuration example is driving three LVCMOS receivers in a backplane application with the following properties:

- The CPU clock can accept a full swing DC-coupled LVCMOS signal. A series resistor  $R_S$  is placed near the LMK1C110x-Q1 to closely match the characteristic impedance of the trace to minimize reflections.
- The FPGA clock is similarly DC-coupled with an appropriate series resistor placed near the LMK1C110x-Q1.
- The PLL in this example can accept a lower amplitude signal, so a Thevenin's equivalent termination (pull up to VDD and pull down to GND) is used. The PLL receiver features internal biasing, so AC coupling can be used when common-mode voltage is mismatched.

#### 9.2.2 Detailed Design Procedure

Unused outputs can be left floating. See [Power Supply Recommendations](#) for recommended filtering techniques.

#### 9.2.3 Application Curves

The low additive jitter of the LMK1C110x-Q1 is shown in [Figure 9-2](#).

[Figure 9-3](#) shows the low-noise 156.25-MHz reference source with 25.6fs RMS jitter driving the LMK1C110x-Q1, resulting in 26.7fs RMS jitter when integrated from 12kHz to 20MHz at 3.3V supply. The resultant additive jitter measured is a low 7.6fs RMS for this configuration.

Figure 9-4 shows the low-noise 156.25-MHz reference source with 25.6fs RMS jitter driving the LMK1C110x-Q1, resulting in 27.5fs RMS jitter when integrated from 12kHz to 20MHz at 2.5V supply. The resultant additive jitter measured is a low 10fs RMS for this configuration.

Figure 9-5 shows the low-noise 156.25-MHz reference source with 25.6fs RMS jitter driving the LMK1C110x-Q1, resulting in 32fs RMS jitter when integrated from 12kHz to 20MHz at 1.8V supply. The resultant additive jitter measured is a low 19.2fs RMS for this configuration.

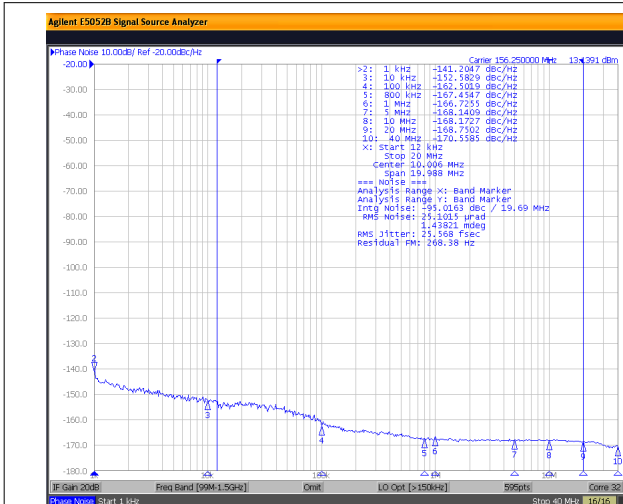

**Figure 9-2. LMK1C110x-Q1 Reference Phase Noise 25.6fs (12kHz to 20MHz)**

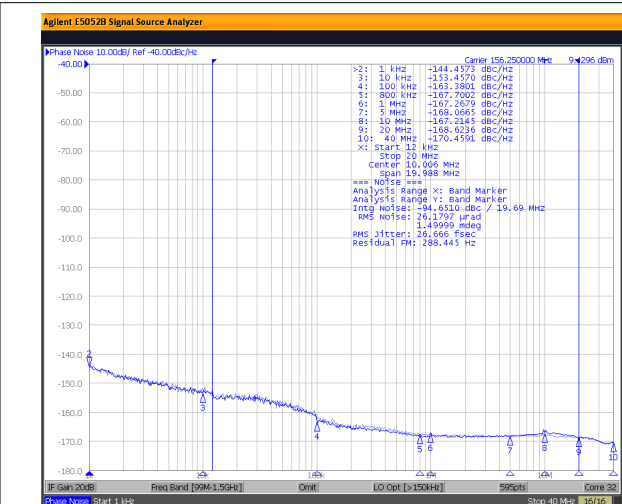

**Figure 9-3. LMK1C110x-Q1 3.3V Output Phase Noise 26.7fs (12kHz to 20MHz)**

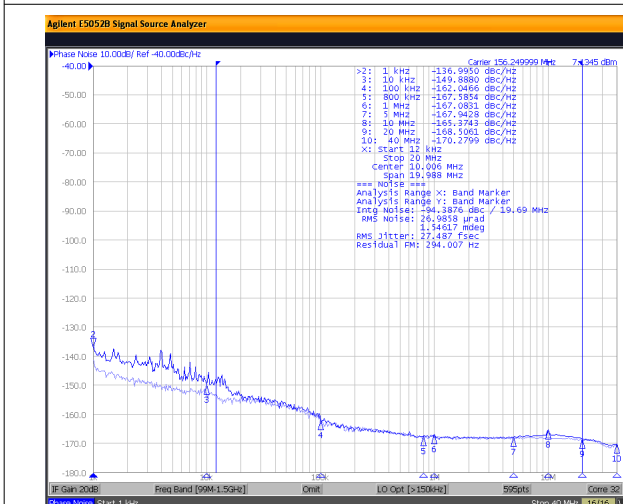

**Figure 9-4. LMK1C110x-Q1 2.5V Output Phase Noise 27.5fs (12kHz to 20MHz)**

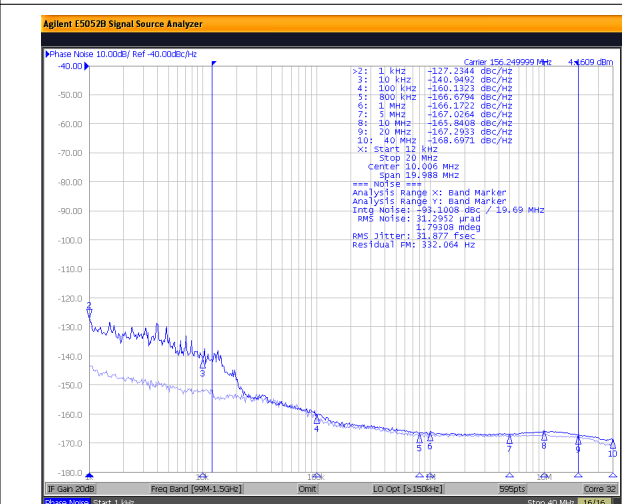

**Figure 9-5. LMK1C110x-Q1 1.8V Output Phase Noise 32fs (12kHz to 20MHz)**

### 9.3 Power Supply Recommendations

High-performance clock buffers can be sensitive to noise on the power supply, which can dramatically increase the additive jitter of the buffer. Thus, managing any excessive noise from the system power supply is essential, especially for applications where the jitter and phase noise performance is critical.

Filter capacitors are used to eliminate the low-frequency noise from the power supply, where the bypass capacitors provide the very low impedance path for high-frequency noise and guard the power supply system against induced fluctuations. These bypass capacitors also provide instantaneous current surges as required by the device and must have low equivalent series resistance (ESR). To properly bypass the supply, the decoupling

capacitors must be placed very close to the power-supply terminals, be connected directly to the ground plane, and laid out with short loops to minimize inductance. TI recommends adding as many high-frequency (for example, 0.1µF) bypass capacitors, as there are supply terminals in the package. TI recommends, but does not require, inserting a ferrite bead between the board power supply and the chip power supply that isolates the high-frequency switching noises generated by the clock buffer; these beads prevent the switching noise from leaking into the board supply. Select an appropriate ferrite bead with very low DC resistance to provide adequate isolation between the board supply and the chip supply, as well as to maintain a voltage at the supply terminals that is greater than the minimum voltage required for proper operation.

Figure 9-6 shows this recommended power supply decoupling method.

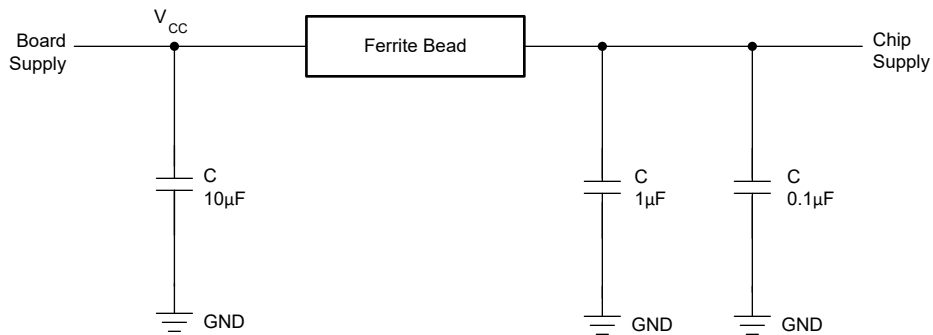

**Figure 9-6. Power Supply Decoupling**

## 9.4 Layout

### 9.4.1 Layout Guidelines

Figure 9-7 shows a conceptual layout detailing recommended placement of power supply bypass capacitors. For component side mounting, use 0402 body size capacitors to facilitate signal routing. Keep the connections between the bypass capacitors and the power supply on the device as short as possible. Ground the other side of the capacitor using a low-impedance connection to the ground plane.

### 9.4.2 Layout Example

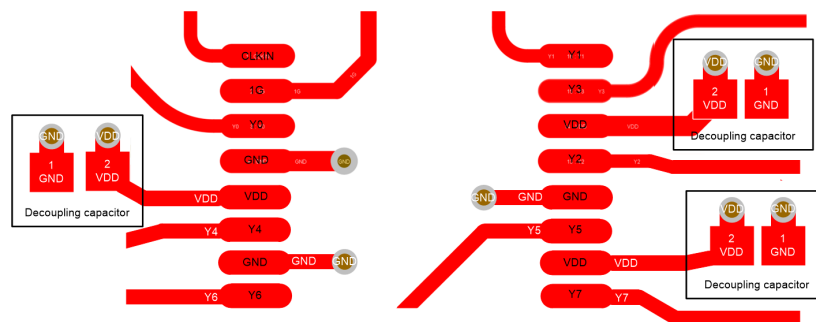

**Figure 9-7. Layout Example for 14-Pin and 16-Pin PW Device**



**Figure 9-8. Layout Example for 8-Pin PW Device**

## 10 Device and Documentation Support

### 10.1 Documentation Support

#### 10.1.1 Related Documentation

For related documentation, see the following:

- Texas Instruments, [LMK1C1108EVM](#), EVM user's guide

### 10.2 Receiving Notification of Documentation Updates

To receive notification of documentation updates, navigate to the device product folder on [ti.com](#). Click on *Notifications* to register and receive a weekly digest of any product information that has changed. For change details, review the revision history included in any revised document.

### 10.3 Support Resources

[TI E2E™ support forums](#) are an engineer's go-to source for fast, verified answers and design help — straight from the experts. Search existing answers or ask your own question to get the quick design help you need.

Linked content is provided "AS IS" by the respective contributors. They do not constitute TI specifications and do not necessarily reflect TI's views; see TI's [Terms of Use](#).

### 10.4 Trademarks

TI E2E™ is a trademark of Texas Instruments.  
All trademarks are the property of their respective owners.

### 10.5 Electrostatic Discharge Caution



This integrated circuit can be damaged by ESD. Texas Instruments recommends that all integrated circuits be handled with appropriate precautions. Failure to observe proper handling and installation procedures can cause damage.

ESD damage can range from subtle performance degradation to complete device failure. Precision integrated circuits may be more susceptible to damage because very small parametric changes could cause the device not to meet its published specifications.

### 10.6 Glossary

[TI Glossary](#) This glossary lists and explains terms, acronyms, and definitions.

## 11 Revision History

NOTE: Page numbers for previous revisions may differ from page numbers in the current version.

DATE	REVISION	NOTES
March 2026	*	Initial Release

## 12 Mechanical, Packaging, and Orderable Information

The following pages include mechanical, packaging, and orderable information. This information is the most current data available for the designated devices. This data is subject to change without notice and revision of this document. For browser-based versions of this data sheet, refer to the left-hand navigation.

**PACKAGING INFORMATION**

Orderable Device	Status <sup>(1)</sup>	Package Type	Package Drawing	Pins	Package Qty	Eco Plan <sup>(2)</sup>	Lead finish/ Ball material <sup>(6)</sup>	MSL Peak Temp <sup>(3)</sup>	Op Temp (°C)	Device Marking <sup>(4) (5)</sup>
PLMK1C1102Q DQFRQ1	ACTIVE	WSON	DQF	8	250	RoHS & Green	NIPDAU	Level-1-260C-UNLIM	-40 to 125	PL2Q
PLMK1C1104Q DQFRQ1	ACTIVE	WSON	DQF	8	250	RoHS & Green	NIPDAU	Level-1-260C-UNLIM	-40 to 125	PL4Q
PLMK1C1106Q PWRQ1	ACTIVE	TSSOP	PW	14	2000	RoHS & Green	NIPDAU	Level-1-260C-UNLIM	-40 to 125	P1106Q
PLMK1C1108Q PWRQ1	ACTIVE	TSSOP	PW	16	2000	RoHS & Green	NIPDAU	Level-1-260C-UNLIM	-40 to 125	P1108Q

- (1) The marketing status values are defined as follows:  
**ACTIVE:** Product device recommended for new designs.  
**LIFEBUY:** TI has announced that the device will be discontinued, and a lifetime-buy period is in effect.  
**NRND:** Not recommended for new designs. Device is in production to support existing customers, but TI does not recommend using this part in a new design. **PREVIEW:** Device has been announced but is not in production. Samples may or may not be available.  
**OBSOLETE:** TI has discontinued the production of the device.
- (2) **RoHS:** TI defines "RoHS" to mean semiconductor products that are compliant with the current EU RoHS requirements for all 10 RoHS substances, including the requirement that RoHS substance do not exceed 0.1% by weight in homogeneous materials. Where designed to be soldered at high temperatures, "RoHS" products are suitable for use in specified lead-free processes. TI may reference these types of products as "Pb-Free".  
**RoHS Exempt:** TI defines "RoHS Exempt" to mean products that contain lead but are compliant with EU RoHS pursuant to a specific EU RoHS exemption.  
**Green:** TI defines "Green" to mean the content of Chlorine (Cl) and Bromine (Br) based flame retardants meet JS709B low halogen requirements of <=1000ppm threshold. Antimony trioxide based flame retardants must also meet the <=1000ppm threshold requirement.
- (3) MSL, Peak Temp. - The Moisture Sensitivity Level rating according to the JEDEC industry standard classifications, and peak solder temperature.
- (4) There may be additional marking, which relates to the logo, the lot trace code information, or the environmental category on the device.
- (5) Multiple Device markings will be inside parentheses. Only one Device Marking contained in parentheses and separated by a "~" will appear on a device. If a line is indented then it is a continuation of the previous line and the two combined represent the entire Device Marking for that device.
- (6) Lead finish/Ball material - Orderable Devices may have multiple material finish options. Finish options are separated by a vertical ruled line. Lead finish/Ball material values may wrap to two lines if the finish value exceeds the maximum column width.

**Important Information and Disclaimer:** The information provided on this page represents TI's knowledge and belief as of the date that it is provided. TI bases its knowledge and belief on information provided by third parties, and makes no representation or warranty as to the accuracy of such information. Efforts are underway to better integrate information from third parties. TI has taken and continues to take reasonable steps to provide representative and accurate information but may not have conducted destructive testing or chemical analysis on incoming materials and chemicals. TI and TI suppliers consider certain information to be proprietary, and thus CAS numbers and other limited information may not be available for release.

In no event shall TI's liability arising out of such information exceed the total purchase price of the TI part(s) at issue in this document sold by TI to Customer on an annual basis.

### 12.1 Tape and Reel Information

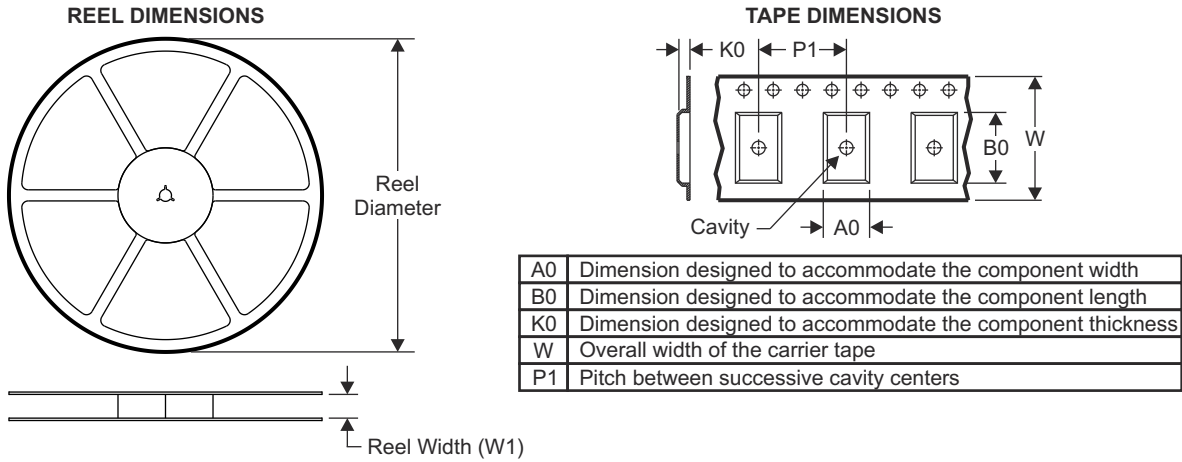

#### QUADRANT ASSIGNMENTS FOR PIN 1 ORIENTATION IN TAPE

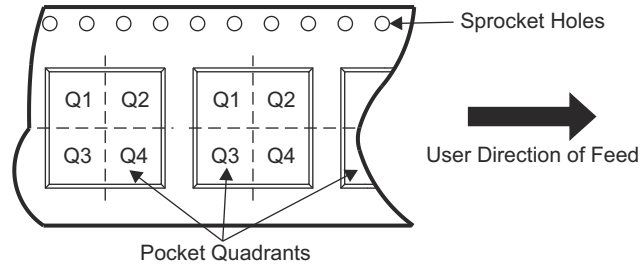

Device	Package Type	Package Drawing	Pins	SPQ	Reel Diameter (mm)	Reel Width W1 (mm)	A0 (mm)	B0 (mm)	K0 (mm)	P1 (mm)	W (mm)	Pin1 Quadrant
PLMK1C1102QDQFRQ1	WSON	DQF	8	250	178	8.4	2.25	2.25	1.0	4	8	Q2
PLMK1C1104QDQFRQ1	WSON	DQF	8	250	178	8.4	2.25	2.25	1.0	4	8	Q2
PLMK1C1106QPWRQ1	TSSOP	PW	14	2000	330	12.4	6.9	5.6	1.6	8	12	Q1
PLMK1C1108QPWRQ1	TSSOP	PW	16	2000	330	12.4	6.9	5.6	1.6	8	12	Q1

**ADVANCE INFORMATION**

TAPE AND REEL BOX DIMENSIONS

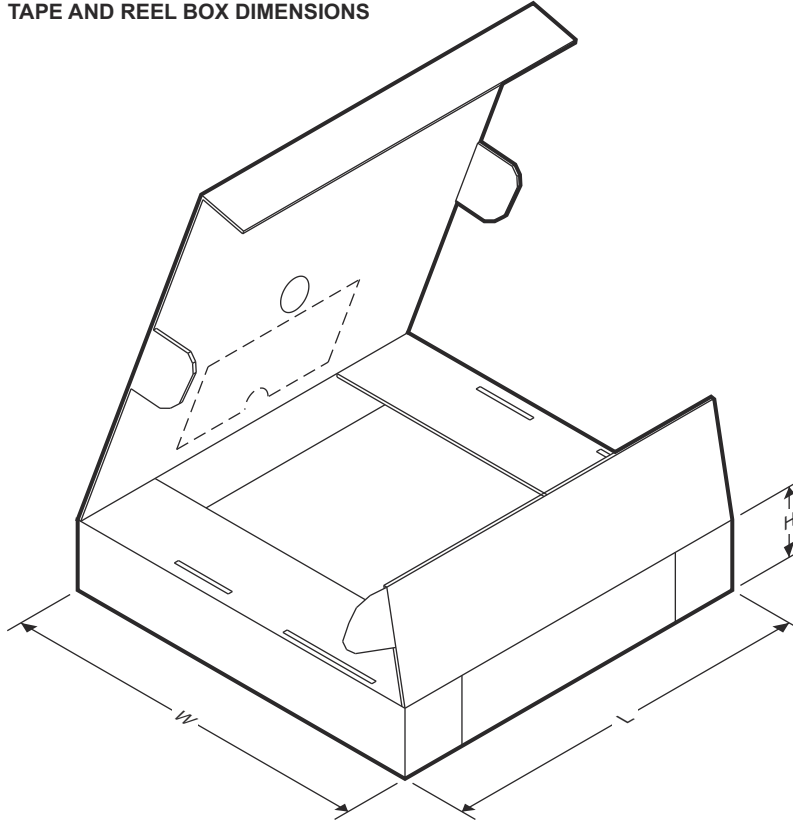

ADVANCE INFORMATION

Device	Package Type	Package Drawing	Pins	SPQ	Length (mm)	Width (mm)	Height (mm)
PLMK1C1102QDQFRQ1	WSON	DQF	8	250	205	200	33
PLMK1C1104QDQFRQ1	WSON	DQF	8	250	205	200	33
PLMK1C1106QPWRQ1	TSSOP	PW	14	2000	356	356	35
PLMK1C1108QPWRQ1	TSSOP	PW	16	2000	356	356	35

**PACKAGING INFORMATION**

Orderable part number	Status (1)	Material type (2)	Package   Pins	Package qty   Carrier	RoHS (3)	Lead finish/ Ball material (4)	MSL rating/ Peak reflow (5)	Op temp (°C)	Part marking (6)
PLMK1C1102QDQFTQ1	Active	Preproduction	WSO (DQF)   8	250   SMALL T&R	-	Call TI	Call TI	-40 to 125	
PLMK1C1104QDQFTQ1	Active	Preproduction	WSO (DQF)   8	250   SMALL T&R	-	Call TI	Call TI	-40 to 125	
PLMK1C1106QPWTQ1	Active	Preproduction	TSSOP (PW)   14	250   SMALL T&R	-	Call TI	Call TI	-40 to 125	
PLMK1C1108QPWTQ1	Active	Preproduction	TSSOP (PW)   16	250   SMALL T&R	-	Call TI	Call TI	-40 to 125	

(1) **Status:** For more details on status, see our [product life cycle](#).

(2) **Material type:** When designated, preproduction parts are prototypes/experimental devices, and are not yet approved or released for full production. Testing and final process, including without limitation quality assurance, reliability performance testing, and/or process qualification, may not yet be complete, and this item is subject to further changes or possible discontinuation. If available for ordering, purchases will be subject to an additional waiver at checkout, and are intended for early internal evaluation purposes only. These items are sold without warranties of any kind.

(3) **RoHS values:** Yes, No, RoHS Exempt. See the [TI RoHS Statement](#) for additional information and value definition.

(4) **Lead finish/Ball material:** Parts may have multiple material finish options. Finish options are separated by a vertical ruled line. Lead finish/Ball material values may wrap to two lines if the finish value exceeds the maximum column width.

(5) **MSL rating/Peak reflow:** The moisture sensitivity level ratings and peak solder (reflow) temperatures. In the event that a part has multiple moisture sensitivity ratings, only the lowest level per JEDEC standards is shown. Refer to the shipping label for the actual reflow temperature that will be used to mount the part to the printed circuit board.

(6) **Part marking:** There may be an additional marking, which relates to the logo, the lot trace code information, or the environmental category of the part.

Multiple part markings will be inside parentheses. Only one part marking contained in parentheses and separated by a "~" will appear on a part. If a line is indented then it is a continuation of the previous line and the two combined represent the entire part marking for that device.

**Important Information and Disclaimer:** The information provided on this page represents TI's knowledge and belief as of the date that it is provided. TI bases its knowledge and belief on information provided by third parties, and makes no representation or warranty as to the accuracy of such information. Efforts are underway to better integrate information from third parties. TI has taken and continues to take reasonable steps to provide representative and accurate information but may not have conducted destructive testing or chemical analysis on incoming materials and chemicals. TI and TI suppliers consider certain information to be proprietary, and thus CAS numbers and other limited information may not be available for release.

In no event shall TI's liability arising out of such information exceed the total purchase price of the TI part(s) at issue in this document sold by TI to Customer on an annual basis.

**OTHER QUALIFIED VERSIONS OF LMK1C1102-Q1, LMK1C1104-Q1, LMK1C1106-Q1, LMK1C1108-Q1 :**

- Catalog : [LMK1C1102](#), [LMK1C1104](#), [LMK1C1106](#), [LMK1C1108](#)

NOTE: Qualified Version Definitions:

- Catalog - TI's standard catalog product

## GENERIC PACKAGE VIEW

**DQF 8**

**WSON - 0.8 mm max height**

2 x 2, 0.5 mm pitch

PLASTIC SMALL OUTLINE - NO LEAD

This image is a representation of the package family, actual package may vary.  
Refer to the product data sheet for package details.

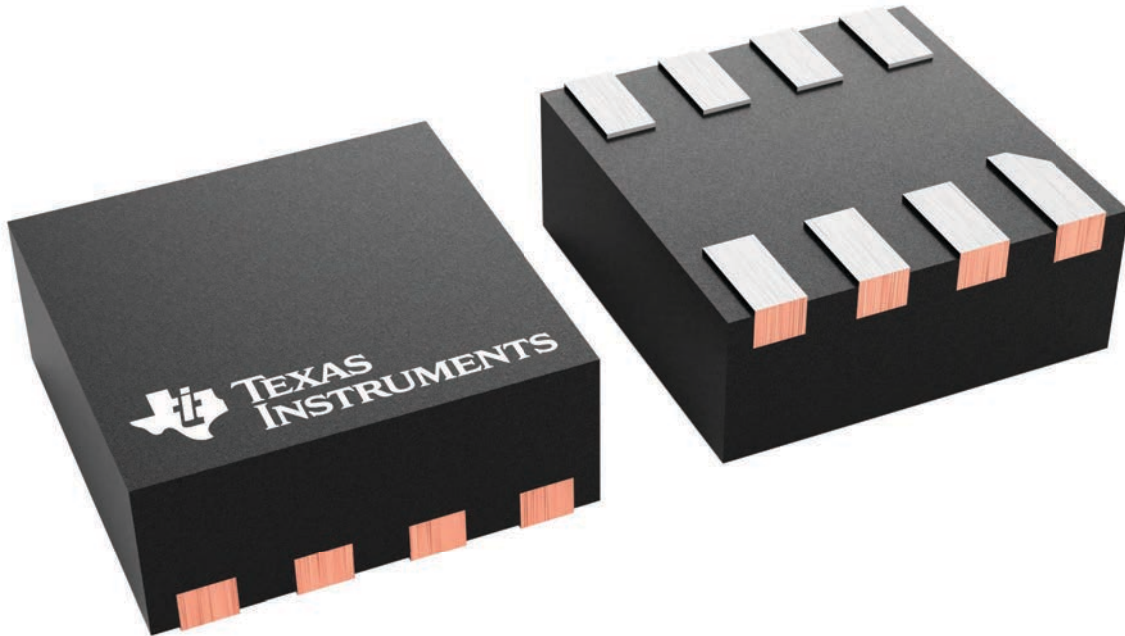

4232898/A



4220204/B 12/2023

NOTES:

1. All linear dimensions are in millimeters. Any dimensions in parenthesis are for reference only. Dimensioning and tolerancing per ASME Y14.5M.
2. This drawing is subject to change without notice.
3. This dimension does not include mold flash, protrusions, or gate burrs. Mold flash, protrusions, or gate burrs shall not exceed 0.15 mm per side.
4. This dimension does not include interlead flash. Interlead flash shall not exceed 0.25 mm per side.
5. Reference JEDEC registration MO-153.

# EXAMPLE BOARD LAYOUT

PW0016A

TSSOP - 1.2 mm max height

SMALL OUTLINE PACKAGE



LAND PATTERN EXAMPLE  
EXPOSED METAL SHOWN  
SCALE: 10X



SOLDER MASK DETAILS

4220204/B 12/2023

NOTES: (continued)

- 6. Publication IPC-7351 may have alternate designs.
- 7. Solder mask tolerances between and around signal pads can vary based on board fabrication site.

# EXAMPLE STENCIL DESIGN

PW0016A

TSSOP - 1.2 mm max height

SMALL OUTLINE PACKAGE



SOLDER PASTE EXAMPLE  
BASED ON 0.125 mm THICK STENCIL  
SCALE: 10X

4220204/B 12/2023

NOTES: (continued)

8. Laser cutting apertures with trapezoidal walls and rounded corners may offer better paste release. IPC-7525 may have alternate design recommendations.
9. Board assembly site may have different recommendations for stencil design.



4220202/B 12/2023

NOTES:

1. All linear dimensions are in millimeters. Any dimensions in parenthesis are for reference only. Dimensioning and tolerancing per ASME Y14.5M.
2. This drawing is subject to change without notice.
3. This dimension does not include mold flash, protrusions, or gate burrs. Mold flash, protrusions, or gate burrs shall not exceed 0.15 mm per side.
4. This dimension does not include interlead flash. Interlead flash shall not exceed 0.25 mm per side.
5. Reference JEDEC registration MO-153.

# EXAMPLE BOARD LAYOUT

PW0014A

TSSOP - 1.2 mm max height

SMALL OUTLINE PACKAGE



LAND PATTERN EXAMPLE  
EXPOSED METAL SHOWN  
SCALE: 10X



4220202/B 12/2023

NOTES: (continued)

- 6. Publication IPC-7351 may have alternate designs.
- 7. Solder mask tolerances between and around signal pads can vary based on board fabrication site.

# EXAMPLE STENCIL DESIGN

PW0014A

TSSOP - 1.2 mm max height

SMALL OUTLINE PACKAGE



SOLDER PASTE EXAMPLE  
BASED ON 0.125 mm THICK STENCIL  
SCALE: 10X

4220202/B 12/2023

NOTES: (continued)

8. Laser cutting apertures with trapezoidal walls and rounded corners may offer better paste release. IPC-7525 may have alternate design recommendations.
9. Board assembly site may have different recommendations for stencil design.

## IMPORTANT NOTICE AND DISCLAIMER

TI PROVIDES TECHNICAL AND RELIABILITY DATA (INCLUDING DATASHEETS), DESIGN RESOURCES (INCLUDING REFERENCE DESIGNS), APPLICATION OR OTHER DESIGN ADVICE, WEB TOOLS, SAFETY INFORMATION, AND OTHER RESOURCES "AS IS" AND WITH ALL FAULTS, AND DISCLAIMS ALL WARRANTIES, EXPRESS AND IMPLIED, INCLUDING WITHOUT LIMITATION ANY IMPLIED WARRANTIES OF MERCHANTABILITY, FITNESS FOR A PARTICULAR PURPOSE OR NON-INFRINGEMENT OF THIRD PARTY INTELLECTUAL PROPERTY RIGHTS.

These resources are intended for skilled developers designing with TI products. You are solely responsible for (1) selecting the appropriate TI products for your application, (2) designing, validating and testing your application, and (3) ensuring your application meets applicable standards, and any other safety, security, regulatory or other requirements.

These resources are subject to change without notice. TI grants you permission to use these resources only for development of an application that uses the TI products described in the resource. Other reproduction and display of these resources is prohibited. No license is granted to any other TI intellectual property right or to any third party intellectual property right. TI disclaims responsibility for, and you fully indemnify TI and its representatives against any claims, damages, costs, losses, and liabilities arising out of your use of these resources.

TI's products are provided subject to [TI's Terms of Sale](#), [TI's General Quality Guidelines](#), or other applicable terms available either on [ti.com](http://ti.com) or provided in conjunction with such TI products. TI's provision of these resources does not expand or otherwise alter TI's applicable warranties or warranty disclaimers for TI products. Unless TI explicitly designates a product as custom or customer-specified, TI products are standard, catalog, general purpose devices.

TI objects to and rejects any additional or different terms you may propose.

Copyright © 2026, Texas Instruments Incorporated

Last updated 10/2025