

## LP2981x 100mA, Low-Dropout Regulator in SOT-23 Package

### 1 Features

- Input voltage ( $V_{IN}$ ) range:
  - Legacy chip: 2.2V to 16V
  - New chip: 2.5V to 16V
- Output voltage ( $V_{OUT}$ ) range: 1.2V to 5.0V
- Output voltage ( $V_{OUT}$ ) accuracy:
  - $\pm 0.75\%$  for A-grade legacy chip
  - $\pm 1.25\%$  for standard-grade legacy chip
  - $\pm 0.5\%$  for new chip (A-grade and standard grade)
- Output Voltage ( $V_{OUT}$ ) accuracy over load, and temperature:  $\pm 1\%$  (new chip)
- Output current: Up to 100mA
- Low  $I_Q$  (new chip):  $69\mu A$  at  $I_{LOAD} = 0mA$
- Low  $I_Q$  (new chip):  $620\mu A$  at  $I_{LOAD} = 100mA$
- Shutdown current over temperature:
  - $< 1\mu A$  (legacy chip)
  - $\leq 1.75\mu A$  (new chip)
- Output current limiting and thermal protection
- Stable with  $2.2\mu F$  ceramic capacitors (new chip)
- High PSRR (new chip):
  - 75dB at 1kHz, 45dB at 1MHz
- Operating junction temperature:  $-40^\circ C$  to  $+125^\circ C$
- Package: 5-pin SOT-23 (DBV)

### 2 Applications

- [Electricity meters](#)
- [Micro inverters](#)
- [Server PSU \(12V output\)](#)
- [Residential breakers](#)
- [Single and multiaxis servo drives](#)

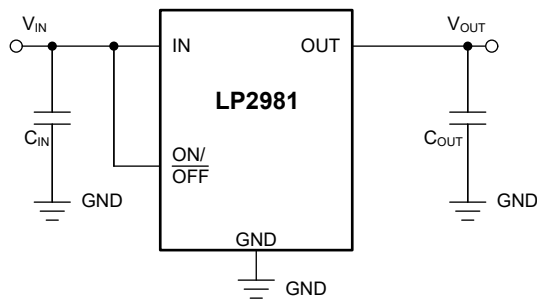

Typical Application Circuit

### 3 Description

The LP2981 and LP2981A (LP2981x) are fixed-output, low-dropout (LDO) voltage regulators supporting an input voltage range from 2.5V to 16V (for new chip only) and up to 100mA of load current. The LP2981x support an output range of 1.2V to 5.0V (new chip).

Additionally, the LP2981x (new chip) has a  $\pm 1\%$  output accuracy across load and temperature that can meet the needs of low-voltage microcontrollers (MCUs) and processors.

In the new chip, wide bandwidth PSRR performance is 75dB at 1kHz and 45dB at 1MHz to help attenuate the switching frequency of an upstream DC/DC converter and minimize post regulator filtering.

In the new chip, the internal soft-start mechanism reduces inrush current during start up, thus minimizing input capacitance. Standard protection features, such as overcurrent and overtemperature protection, are included.

#### Package Information

PART NUMBER	PACKAGE <sup>(1)</sup>	PACKAGE SIZE <sup>(2)</sup>
LP2981x	DBV (SOT-23, 5)	2.9mm × 2.8mm

- (1) For more information, see the [Mechanical, Packaging, and Orderable Information](#).
- (2) The package size (length × width) is a nominal value and includes pins, where applicable.

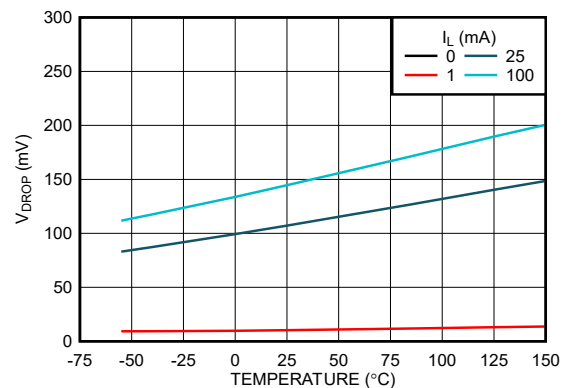

Dropout Voltage vs Temperature (New Chip)



## Table of Contents

<b>1 Features</b> .....	<b>1</b>	<b>7 Application and Implementation</b> .....	<b>17</b>
<b>2 Applications</b> .....	<b>1</b>	7.1 Application Information.....	17
<b>3 Description</b> .....	<b>1</b>	7.2 Typical Application.....	20
<b>4 Pin Configuration and Functions</b> .....	<b>3</b>	7.3 Power Supply Recommendations.....	22
<b>5 Specifications</b> .....	<b>3</b>	7.4 Layout.....	23
5.1 Absolute Maximum Ratings.....	3	<b>8 Device and Documentation Support</b> .....	<b>24</b>
5.2 ESD Ratings.....	4	8.1 Device Nomenclature.....	24
5.3 Recommended Operating Conditions.....	4	8.2 Documentation Support.....	24
5.4 Thermal Information.....	4	8.3 Receiving Notification of Documentation Updates....	24
5.5 Electrical Characteristics.....	5	8.4 Support Resources.....	24
5.6 Typical Characteristics.....	8	8.5 Trademarks.....	24
<b>6 Detailed Description</b> .....	<b>13</b>	8.6 Electrostatic Discharge Caution.....	24
6.1 Overview.....	13	8.7 Glossary.....	24
6.2 Functional Block Diagrams.....	13	<b>9 Revision History</b> .....	<b>25</b>
6.3 Feature Description.....	14	<b>10 Mechanical, Packaging, and Orderable Information</b> .....	<b>25</b>
6.4 Device Functional Modes.....	16		

## 4 Pin Configuration and Functions

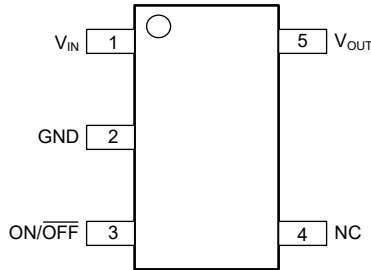

**Figure 4-1. DBV Package, 5-Pin SOT-23 (Top View)**

**Table 4-1. Pin Functions**

PIN		TYPE	DESCRIPTION
NO.	NAME		
1	IN	I	Input supply pin. Use a capacitor with a value of 1 $\mu$ F or larger from this pin to ground. See the <a href="#">Input Capacitor</a> section for more information.
2	GND	—	Common ground (device substrate).
3	ON/OFF	I	Enable pin for the LDO. Driving the ON/OFF pin high enables the device. Driving this pin low disables the device. High and low thresholds are listed in the <a href="#">Electrical Characteristics</a> table. Tie this pin to V <sub>IN</sub> if unused.
4	NC	—	Do not connect.
5	OUT	O	Output of the regulator. Use a capacitor with a value of 2.2 $\mu$ F or larger from this pin to ground <sup>(1)</sup> . See the <a href="#">Output Capacitor</a> section for more information.

- (1) The nominal output capacitance must be greater than 1 $\mu$ F. Throughout this document, the nominal derating on these capacitors is 50%. Make sure that the effective capacitance at the pin is greater than 1 $\mu$ F.

## 5 Specifications

### 5.1 Absolute Maximum Ratings

over operating free-air temperature range (unless otherwise noted)<sup>(1) (2)</sup>

		MIN	MAX	UNIT	
V <sub>IN</sub>	Continuous input voltage range (for legacy chip)	-0.3	16	V	
	Continuous input voltage range (for new chip)	-0.3	18		
V <sub>OUT</sub>	Output voltage range (for legacy chip)	-0.3	9		
	Output voltage range (for new chip)	-0.3	V <sub>IN</sub> + 0.3 or 9 (whichever is smaller)		
V <sub>ON/OFF</sub>	ON/OFF pin voltage range (for legacy chip)	-0.3	16		
	ON/OFF pin voltage range (for new chip)	-0.3	18		
V <sub>IN</sub> - V <sub>OUT</sub>	Input-output voltage (for legacy chip)	-0.3	16		
	Input-output voltage (for new chip)	-0.3	18		
Current	Maximum output current	Internally limited			mA
Temperature	Operating junction, T <sub>J</sub>	-55	150		°C
	Storage, T <sub>stg</sub>	-65	150		

- (1) Operation outside the *Absolute Maximum Ratings* may cause permanent device damage. *Absolute Maximum Ratings* do not imply functional operation of the device at these or any other conditions beyond those listed under *Recommended Operating Conditions*. If used outside the *Recommended Operating Conditions* but within the *Absolute Maximum Ratings*, the device may not be fully functional, and this may affect device reliability, functionality, performance, and shorten the device lifetime.
- (2) All voltages with respect to GND.

## 5.2 ESD Ratings

			VALUE (Legacy Chip)	VALUE (New Chip)	UNIT
V <sub>(ESD)</sub>	Electrostatic discharge	Human body model (HBM), per ANSI/ESDA/JEDEC JS-001 <sup>(1)</sup>	±2000	±3000	V
		Charged device model (CDM), per JEDEC specification JESD22-C101 <sup>(2)</sup>	±500	±1000	
		Machine model (MM)	±100	N/A	

(1) JEDEC document JEP155 states that 2-kV HBM allows safe manufacturing with a standard ESD control process.

(2) JEDEC document JEP157 states that 500-V CDM allows safe manufacturing with a standard ESD control process.

## 5.3 Recommended Operating Conditions

		MIN	NOM	MAX	UNIT	
V <sub>IN</sub>	Supply input voltage (for legacy chip)	2.2		16	V	
	Supply input voltage (for new chip)	2.5		16		
V <sub>IN</sub> – V <sub>OUT</sub>	Input-output differential (for legacy chip)	0.7		11		
	Input-output differential (for new chip)	0		16		
V <sub>OUT</sub>	Output voltage (for new chip)	1.2		5		
V <sub>ON/OFF</sub>	Enable voltage (for legacy chip)	0		V <sub>IN</sub>		
	Enable voltage (for new chip)	0		16		
I <sub>OUT</sub>	Output current	0		100		mA
C <sub>IN</sub> <sup>(1)</sup>	Input capacitor		1			μF
C <sub>OUT</sub>	Output capacitor (for legacy chip) <sup>(4)</sup>	3.3				
	Output capacitance (for new chip) <sup>(1)</sup>	1	2.2	200		
C <sub>OUT</sub> ESR <sup>(2)</sup>	Output capacitor ESR (for new chip) <sup>(3)</sup>	0		1	Ω	
T <sub>J</sub>	Operating junction temperature	–40		125	°C	

(1) All capacitor values are assumed to derate to 50% of the nominal capacitor value. Maintain an effective output capacitance of 1 μF minimum for stability.

(2) Details related to supported ESR range for the legacy chip are available in sections [Recommended Capacitors for the Legacy Chip](#) and [Output Capacitor](#).

(3) Maximum supported ESR range for new chip is 1Ω. For output capacitor with higher ESR values, place a low ESR MLCC capacitor.

(4) Details related to minimum required output capacitor for legacy chip are available in section [Output Capacitor](#).

## 5.4 Thermal Information

THERMAL METRIC <sup>(1)</sup>		Legacy Chip <sup>(2)</sup>	New Chip <sup>(2)</sup>	UNIT
		DBV (SOT23-5)	DBV (SOT23-5)	
		5 PINS	5 PINS	
R <sub>θJA</sub>	Junction-to-ambient thermal resistance	205.2	178.6	°C/W
R <sub>θJC(top)</sub>	Junction-to-case (top) thermal resistance	11.83	77.9	°C/W
R <sub>θJB</sub>	Junction-to-board thermal resistance	37.7	47.2	°C/W
ψ <sub>JT</sub>	Junction-to-top characterization parameter	12.2	15.9	°C/W
ψ <sub>JB</sub>	Junction-to-board characterization parameter	33.8	46.9	°C/W

(1) For more information about traditional and new thermal metrics, see the [Semiconductor and IC Package Thermal Metrics](#) application note.

(2) Thermal performance results are based on the JEDEC standard of 2s2p PCB configuration. These thermal metric parameters can be further improved by 35-55% based on thermally optimized PCB layout designs. See the analysis of the [Impact of board layout on LDO thermal performance](#) application report.

## 5.5 Electrical Characteristics

specified at  $T_J = 25^\circ\text{C}$ ,  $V_{IN} = V_{OUT(nom)} + 1.0\text{ V}$  or  $V_{IN} = 2.5\text{ V}$  (whichever is greater),  $I_{OUT} = 1\text{ mA}$ ,  $V_{ON/OFF} = 2\text{ V}$ ,  $C_{IN} = 1.0\ \mu\text{F}$ , and  $C_{OUT} = 2.2\ \mu\text{F}$  (unless otherwise noted)

PARAMETER		TEST CONDITIONS		MIN	TYP	MAX	UNIT
$\Delta V_{OUT}$	Output voltage tolerance	$I_L = 1\text{ mA}$	Legacy chip (Standard grade)	-1.25		1.25	%
			Legacy chip (A grade)	-0.75		0.75	
			New chip	-0.5		0.5	
		$1\text{ mA} < I_L < 100\text{ mA}$	Legacy chip (Standard grade)	-2.0		2.0	
			Legacy chip (A grade)	-1.0		1.0	
			New chip	-0.5		0.5	
		$1\text{ mA} < I_L < 100\text{ mA}, -40^\circ\text{C} \leq T_J \leq 125^\circ\text{C}$	Legacy chip (Standard grade)	-3.5		3.5	
			Legacy chip (A grade)	-2.5		2.5	
			New chip	-1		1	
$\Delta V_{OUT(\Delta V_{IN})}$	Line regulation	$V_{O(NOM)} + 1\text{ V} \leq V_{IN} \leq 16\text{ V}$	Legacy chip		0.007	0.014	%V
			New chip		0.002	0.014	
		$V_{O(NOM)} + 1\text{ V} \leq V_{IN} \leq 16\text{ V}, -40^\circ\text{C} \leq T_J \leq 125^\circ\text{C}$	Legacy chip		0.007	0.032	
			New chip		0.002	0.032	
$\Delta V_{OUT(\Delta I_{LOAD})}$	Load regulation	$1\text{ mA} < I_L < 100\text{ mA}, -40^\circ\text{C} \leq T_J \leq 125^\circ\text{C}, V_{IN} = V_{O(NOM)} + 0.5\text{ V}$	New chip		0.1	0.5	%/A
$V_{IN} - V_{OUT}$	Dropout voltage <sup>(1)</sup>	$I_{OUT} = 0\text{ mA}$	Legacy chip		1	3	mV
			New chip		1	2.75	
		$I_{OUT} = 0\text{ mA}, -40^\circ\text{C} \leq T_J \leq 125^\circ\text{C}$	Legacy chip			5	
			New chip			3	
		$I_{OUT} = 1\text{ mA}$	Legacy chip		7	10	
			New chip		11.5	14	
		$I_{OUT} = 1\text{ mA}, -40^\circ\text{C} \leq T_J \leq 125^\circ\text{C}$	Legacy chip			15	
			New chip			17	
		$I_{OUT} = 25\text{ mA}$	Legacy chip		70	100	
			New chip		110	132	
		$I_{OUT} = 25\text{ mA}, -40^\circ\text{C} \leq T_J \leq 125^\circ\text{C}$	Legacy chip			150	
			New chip			167	
		$I_{OUT} = 100\text{ mA}$	Legacy chip		200	250	
			New chip		160	175	
		$I_{OUT} = 100\text{ mA}, -40^\circ\text{C} \leq T_J \leq 125^\circ\text{C}$	Legacy chip			375	
			New chip			218	

### 5.5 Electrical Characteristics (continued)

specified at  $T_J = 25\text{ }^\circ\text{C}$ ,  $V_{IN} = V_{OUT(nom)} + 1.0\text{ V}$  or  $V_{IN} = 2.5\text{ V}$  (whichever is greater),  $I_{OUT} = 1\text{ mA}$ ,  $V_{ON/OFF} = 2\text{ V}$ ,  $C_{IN} = 1.0\text{ }\mu\text{F}$ , and  $C_{OUT} = 2.2\text{ }\mu\text{F}$  (unless otherwise noted)

PARAMETER		TEST CONDITIONS	MIN	TYP	MAX	UNIT	
$I_{GND}$	GND pin current	$I_{OUT} = 0\text{ mA}$	Legacy chip	65	95	$\mu\text{A}$	
			New chip	69	95		
		$I_{OUT} = 0\text{ mA}, -40^\circ\text{C} \leq T_J \leq 125^\circ\text{C}$	Legacy chip		125		
			New chip		123		
		$I_{OUT} = 1\text{ mA}$	Legacy chip	80	110		
			New chip	78	110		
		$I_{OUT} = 1\text{ mA}, -40^\circ\text{C} \leq T_J \leq 125^\circ\text{C}$	Legacy chip		170		
			New chip		140		
		$I_{OUT} = 25\text{ mA}$	Legacy chip	200	300		
			New chip	225	295		
		$I_{OUT} = 25\text{ mA}, -40^\circ\text{C} \leq T_J \leq 125^\circ\text{C}$	Legacy chip		550		
			New chip		345		
		$I_{OUT} = 100\text{ mA}$	Legacy chip	600	1000		
			New chip	620	790		
$I_{OUT} = 100\text{ mA}, -40^\circ\text{C} \leq T_J \leq 125^\circ\text{C}$	Legacy chip		1700				
	New chip		950				
$V_{ON/OFF} < 0.3\text{ V}, V_{IN} = 16\text{ V}$	Legacy chip	0.01	0.8				
	New chip	1.25	1.75				
$V_{ON/OFF} < 0.15\text{ V}, V_{IN} = 16\text{ V}, -40^\circ\text{C} \leq T_J \leq 105^\circ\text{C}$	Legacy chip	0.05	2				
	New chip		5				
$V_{ON/OFF} < 0.15\text{ V}, V_{IN} = 16\text{ V}, -40^\circ\text{C} \leq T_J \leq 125^\circ\text{C}$	Legacy chip						
	New chip	1.12	2.75				
$V_{UVLO+}$	Rising bias supply UVLO	$V_{IN}$ rising, $-40^\circ\text{C} \leq T_J \leq 125^\circ\text{C}$		2.2	2.4	V	
$V_{UVLO-}$	Falling bias supply UVLO	$V_{IN}$ falling, $-40^\circ\text{C} \leq T_J \leq 125^\circ\text{C}$	New chip	1.9		V	
$V_{UVLO(HYST)}$	UVLO hysteresis	$-40^\circ\text{C} \leq T_J \leq 125^\circ\text{C}$		0.130		V	
$I_{O(SC)}$	Short output current	$R_L = 0\text{ }\Omega$ (steady state)	Legacy chip	150		mA	
			New chip	150			
$V_{ON/OFF}$	ON/OFF input voltage	Low = Output OFF	Legacy chip	0.5		V	
			New chip	0.72			
		Low = Output OFF, $V_{OUT} + 1 \leq V_{IN} \leq 16\text{ V}, -40^\circ\text{C} \leq T_J \leq 125^\circ\text{C}$	Legacy chip		0.15		
			New chip		0.15		
		High = Output ON	Legacy chip	1.4			
			New chip	0.85			
		High = Output ON, $V_{OUT} + 1 \leq V_{IN} \leq 16\text{ V}, -40^\circ\text{C} \leq T_J \leq 125^\circ\text{C}$	Legacy chip	1.6			
			New chip	1.6			
$I_{ON/OFF}$	ON/OFF input current	$V_{ON/OFF} = 0\text{ V}$	Legacy chip	0.01		$\mu\text{A}$	
			New chip	0.42			
		$V_{ON/OFF} = 0\text{ V}, V_{OUT} + 1 \leq V_{IN} \leq 16\text{ V}, -40^\circ\text{C} \leq T_J \leq 125^\circ\text{C}$	Legacy chip		-1		
			New chip		-0.9		
		$V_{ON/OFF} = 5\text{ V}$	Legacy chip	5			
			New chip	0.011			
		$V_{ON/OFF} = 5\text{ V}, V_{OUT} + 1 \leq V_{IN} \leq 16\text{ V}, -40^\circ\text{C} \leq T_J \leq 125^\circ\text{C}$	Legacy chip		15		
			New chip		2.20		

## 5.5 Electrical Characteristics (continued)

specified at  $T_J = 25\text{ }^\circ\text{C}$ ,  $V_{IN} = V_{OUT(nom)} + 1.0\text{ V}$  or  $V_{IN} = 2.5\text{ V}$  (whichever is greater),  $I_{OUT} = 1\text{ mA}$ ,  $V_{ON/OFF} = 2\text{ V}$ ,  $C_{IN} = 1.0\text{ }\mu\text{F}$ , and  $C_{OUT} = 2.2\text{ }\mu\text{F}$  (unless otherwise noted)

PARAMETER		TEST CONDITIONS	MIN	TYP	MAX	UNIT
$I_{O(PK)}$	Peak output current	$V_{OUT} \geq V_{O(NOM)} - 5\%$ (steady state)	Legacy chip	400		mA
			New chip	350		
$\Delta V_O/\Delta V_{IN}$	Ripple rejection	$f = 1\text{ kHz}$ , $C_{OUT} = 10\text{ }\mu\text{F}$	Legacy chip	63		dB
			New chip	75		
$V_n$	Output noise voltage	Bandwidth = 300 Hz to 50 kHz, $C_{OUT} = 2.2\text{ }\mu\text{F}$ , $V_{OUT} = 3.3\text{ V}$ , $I_{LOAD} = 150\text{ mA}$	Legacy chip	160		$\mu\text{VRMS}$
		Bandwidth = 300 Hz to 50 kHz, $C_{OUT} = 2.2\text{ }\mu\text{F}$ , $V_{OUT} = 3.3\text{ V}$ , $I_{LOAD} = 150\text{ mA}$	New chip	140		
$T_{sd+}$	Thermal shutdown threshold	Shutdown, temperature increasing	New chip	170		$^\circ\text{C}$
$T_{sd-}$		Reset, temperature decreasing		150		

- (1) Dropout voltage ( $V_{DO}$ ) is defined as the input-to-output differential at which the output voltage drops 100 mV below the value measured with a 1-V differential.  $V_{DO}$  is measured with  $V_{IN} = V_{OUT(nom)} - 100\text{ mV}$  for fixed output devices.

## 5.6 Typical Characteristics

at  $T_A = 25^\circ\text{C}$ ,  $V_{IN} = V_{O(NOM)} + 1\text{V}$ ,  $C_{OUT} = 10\mu\text{F}$ ,  $C_{IN} = 1\mu\text{F}$  all voltage options, ON/OFF pin tied to  $V_{IN}$  (unless otherwise noted)

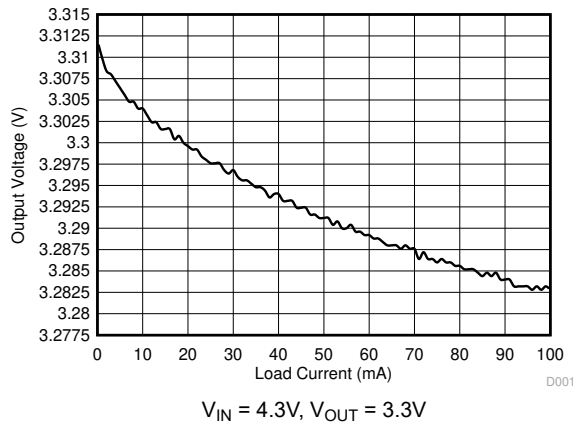

Figure 5-1. Output Voltage vs Load Current (Legacy Chip)

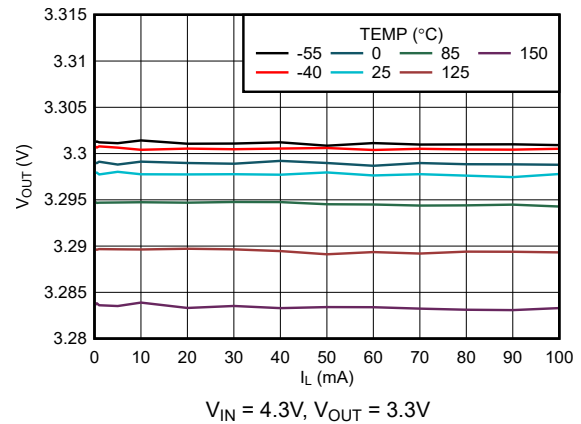

Figure 5-2. Output Voltage vs Load Current (New Chip)

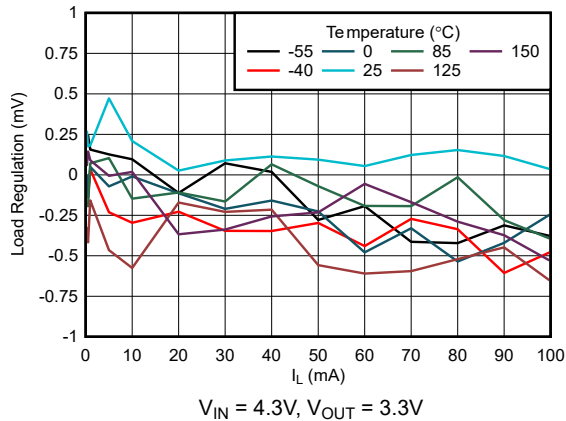

Figure 5-3. Load Regulation vs Temperature (New Chip)

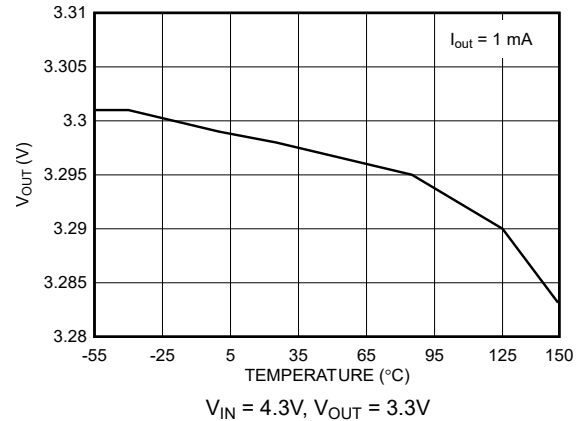

Figure 5-4. Output Voltage vs Temperature (New Chip)

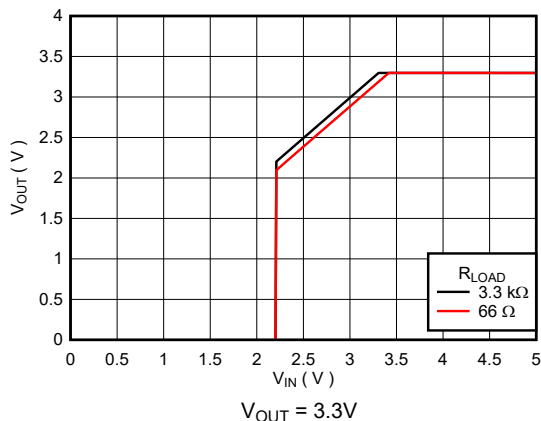

Figure 5-5. Output Voltage vs  $V_{IN}$  (New Chip)

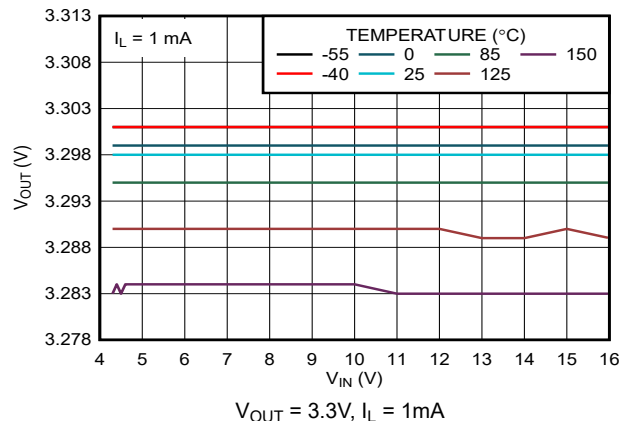
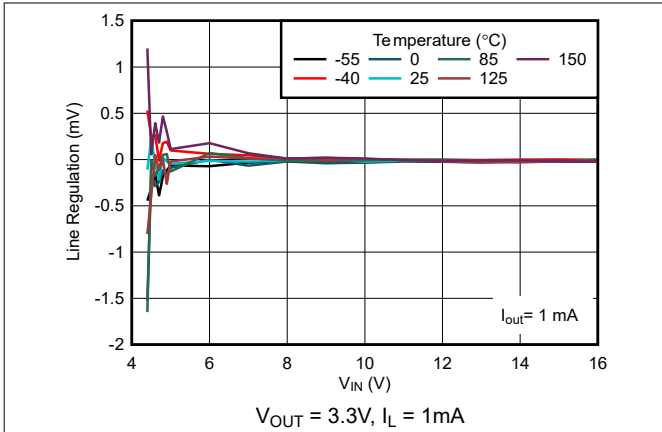

Figure 5-6. Output Voltage vs  $V_{IN}$  and Temperature (New Chip)



### 5.6 Typical Characteristics (continued)

at  $T_A = 25^\circ\text{C}$ ,  $V_{IN} = V_{O(NOM)} + 1\text{V}$ ,  $C_{OUT} = 10\mu\text{F}$ ,  $C_{IN} = 1\mu\text{F}$  all voltage options, ON/OFF pin tied to  $V_{IN}$  (unless otherwise noted)



**Figure 5-7. Line Regulation vs  $V_{IN}$  and Temperature (New Chip)**

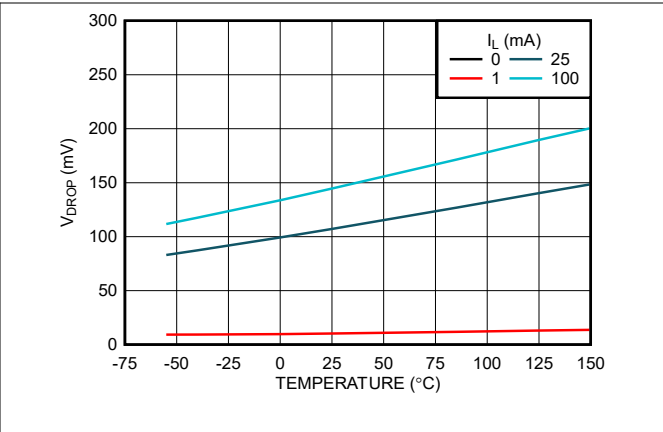

**Figure 5-8. Dropout Voltage ( $V_{DO}$ ) vs Temperature (New Chip)**

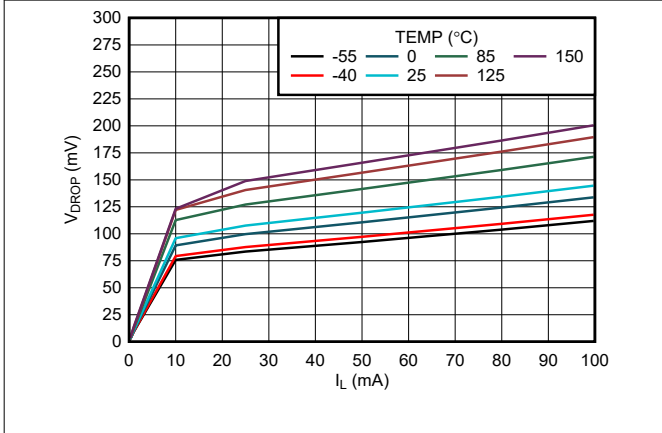

**Figure 5-9. Dropout Voltage ( $V_{DO}$ ) vs Load Current (New Chip)**

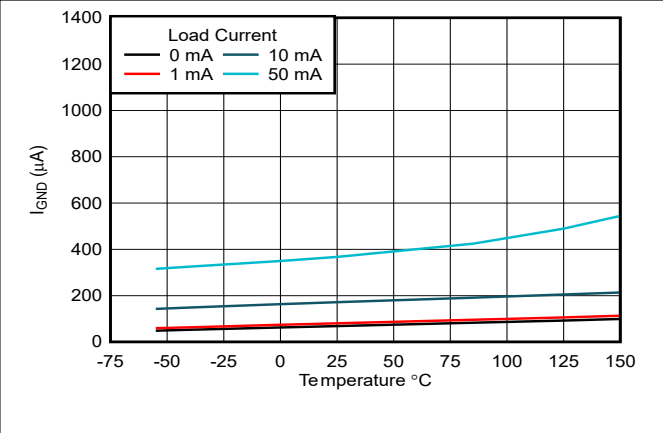

**Figure 5-10. Ground Pin Current ( $I_{GND}$ ) vs Temperature (New Chip)**

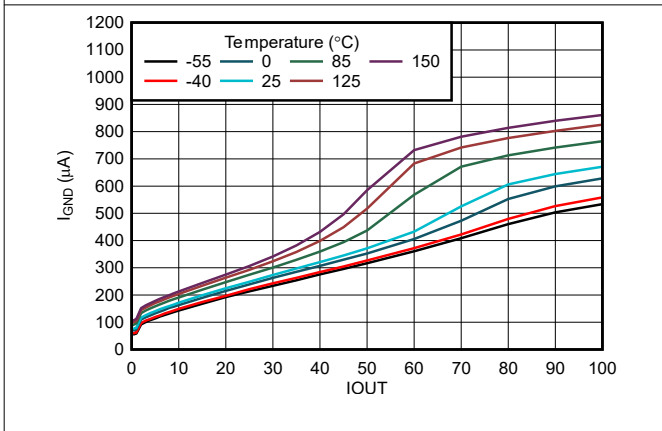

**Figure 5-11. Ground Pin Current ( $I_{GND}$ ) vs Load Current (New Chip)**

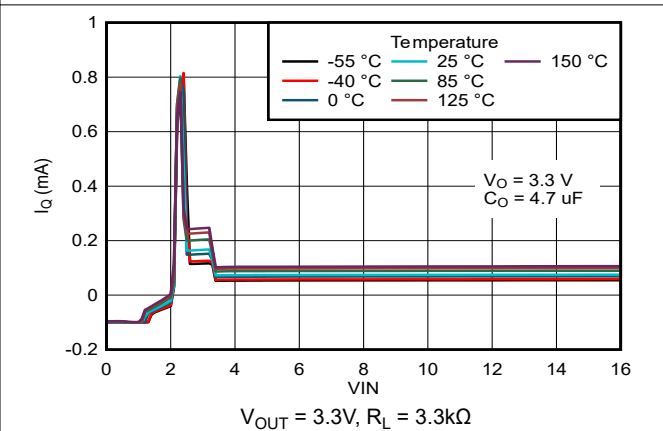

**Figure 5-12. Input Current vs Input Voltage ( $V_{IN}$ ) (New Chip)**

### 5.6 Typical Characteristics (continued)

at  $T_A = 25^\circ\text{C}$ ,  $V_{IN} = V_{O(NOM)} + 1\text{V}$ ,  $C_{OUT} = 10\mu\text{F}$ ,  $C_{IN} = 1\mu\text{F}$  all voltage options, ON/OFF pin tied to  $V_{IN}$  (unless otherwise noted)

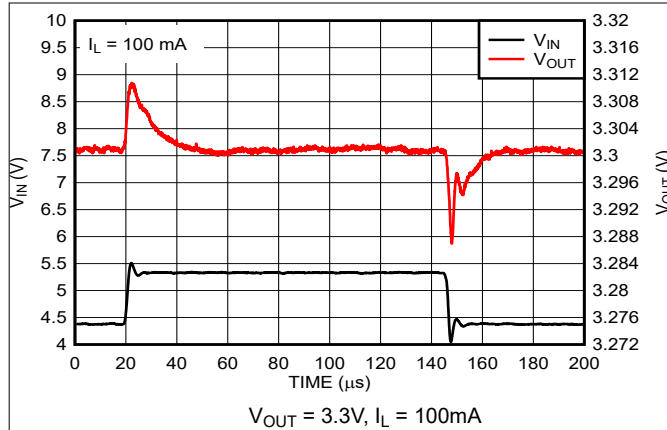

Figure 5-13. Line Transient Response (New Chip)

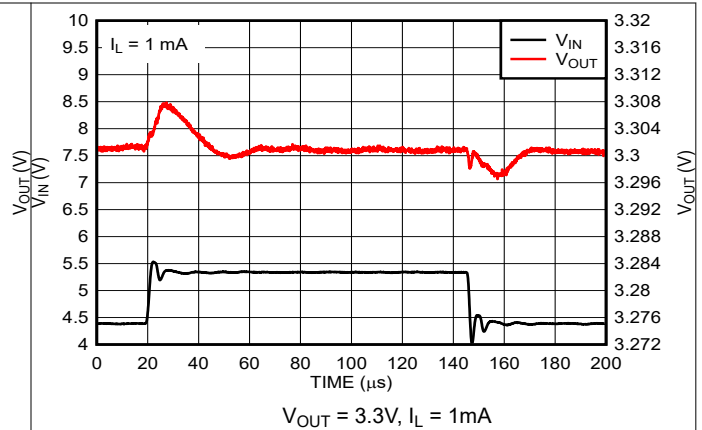

Figure 5-14. Line Transient Response (New Chip)

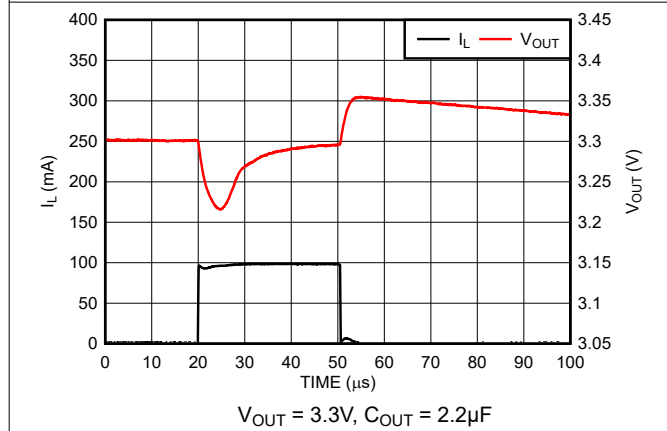

Figure 5-15. Load Transient Response (New Chip)

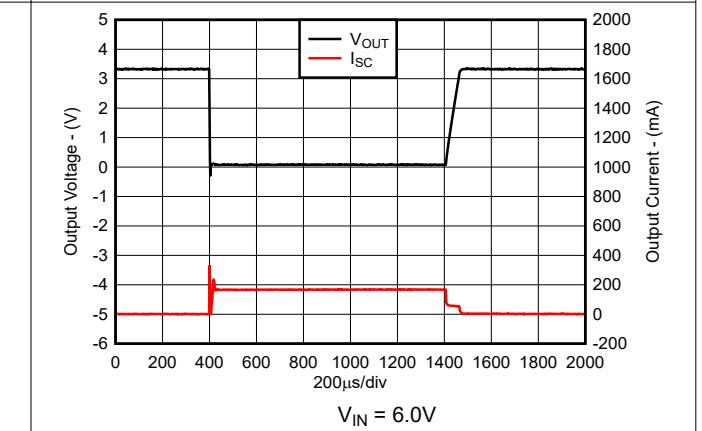

Figure 5-16. Short-Circuit Current vs Time (New Chip)

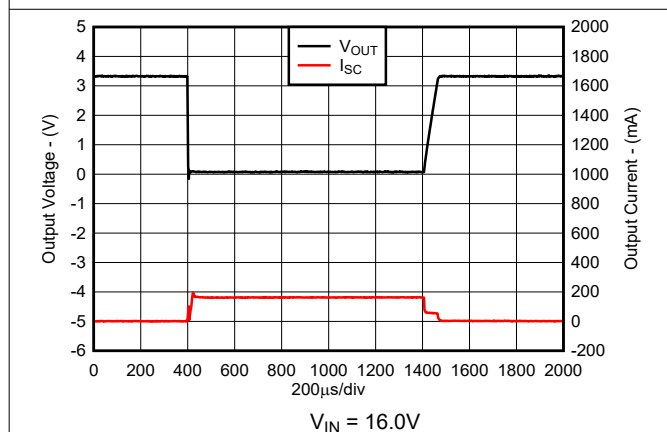

Figure 5-17. Short-Circuit Current vs Time (New Chip)

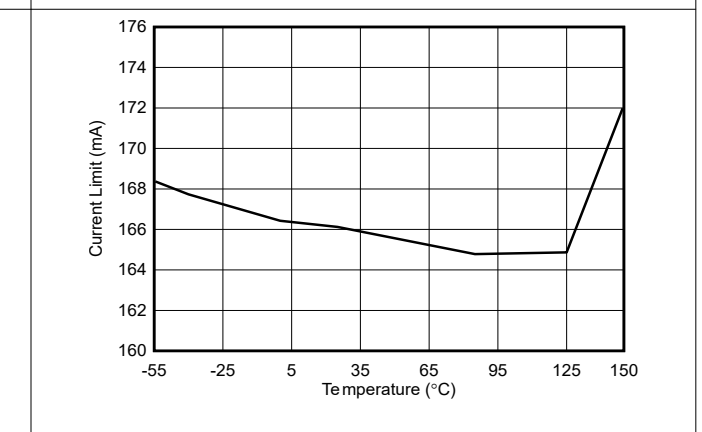
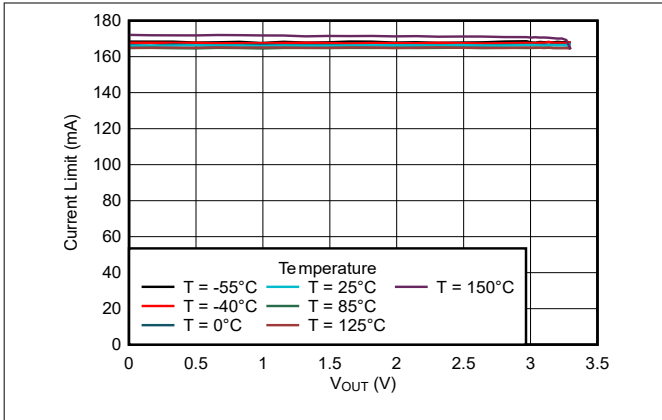

Figure 5-18. Instantaneous Short-Circuit Current vs Temperature (New Chip)

### 5.6 Typical Characteristics (continued)

at  $T_A = 25^\circ\text{C}$ ,  $V_{IN} = V_{O(NOM)} + 1\text{V}$ ,  $C_{OUT} = 10\mu\text{F}$ ,  $C_{IN} = 1\mu\text{F}$  all voltage options, ON/OFF pin tied to  $V_{IN}$  (unless otherwise noted)



**Figure 5-19. Short-Circuit Current vs Output Voltage ( $V_{OUT}$ ) (New Chip)**

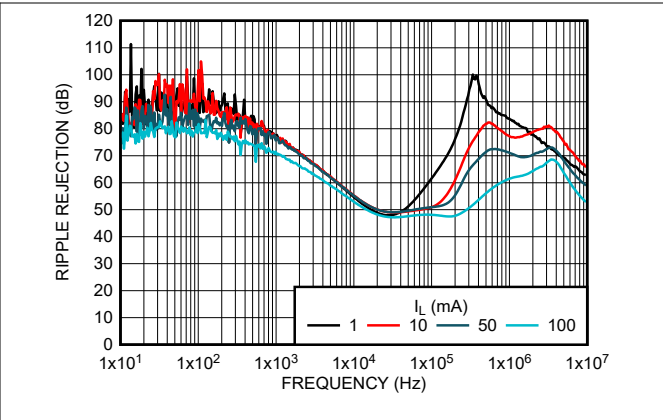

**Figure 5-20. Ripple Rejection vs Load Current ( $I_L$ ) and Frequency (New Chip)**

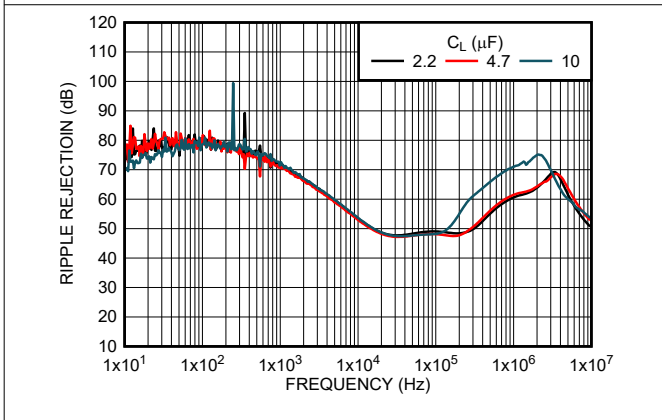

**Figure 5-21. Ripple Rejection vs Output Capacitor ( $C_L$ ) and Frequency (New Chip)**

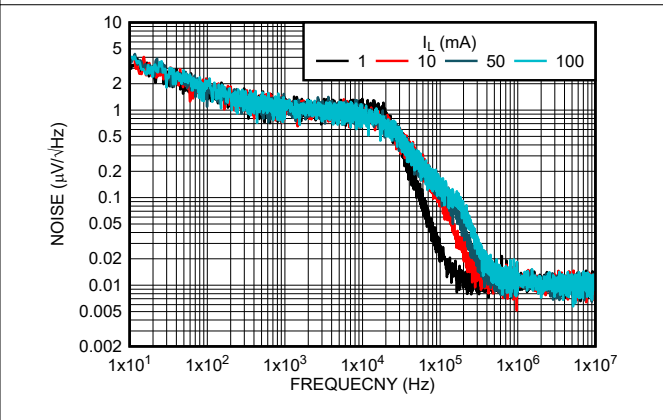

**Figure 5-22. Output Noise Density vs Load Current ( $I_L$ ) Frequency (New Chip)**

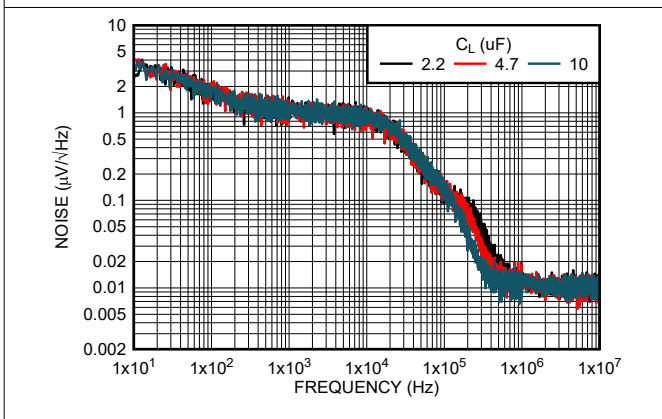

**Figure 5-23. Output Noise Density vs Output Capacitor ( $C_L$ ) Frequency (New Chip)**

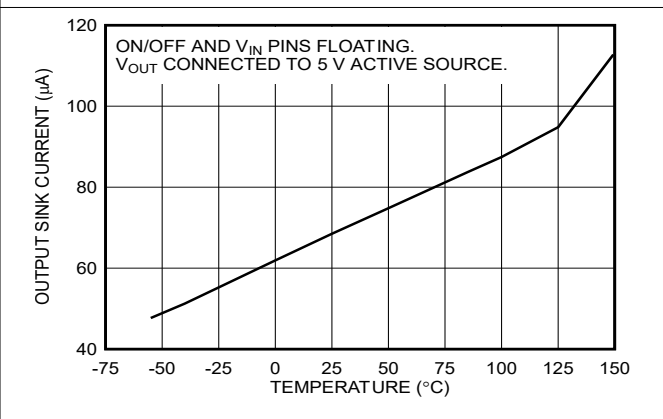

**Figure 5-24. Output Reverse Leakage vs Temperature (New Chip)**

### 5.6 Typical Characteristics (continued)

at  $T_A = 25^\circ\text{C}$ ,  $V_{IN} = V_{O(NOM)} + 1\text{V}$ ,  $C_{OUT} = 10\mu\text{F}$ ,  $C_{IN} = 1\mu\text{F}$  all voltage options, ON/OFF pin tied to  $V_{IN}$  (unless otherwise noted)

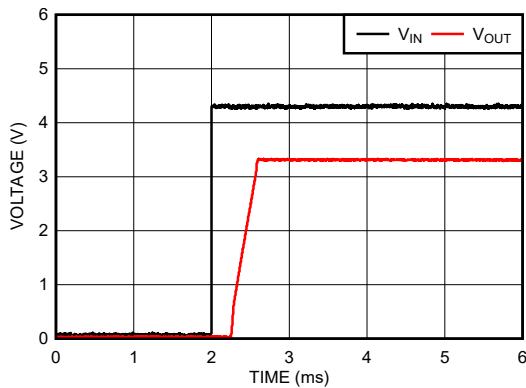

$V_{OUT} = 3.3\text{V}$ ,  $R_L = 3.3\text{k}\Omega$

Figure 5-25. Turn-On Waveform (New Chip)

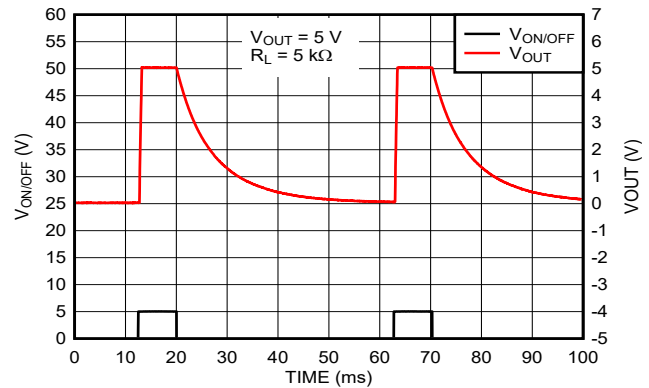

$V_{OUT} = 5\text{V}$ ,  $R_L = 5\text{k}\Omega$

Figure 5-26. Turn-Off Waveform (New Chip)

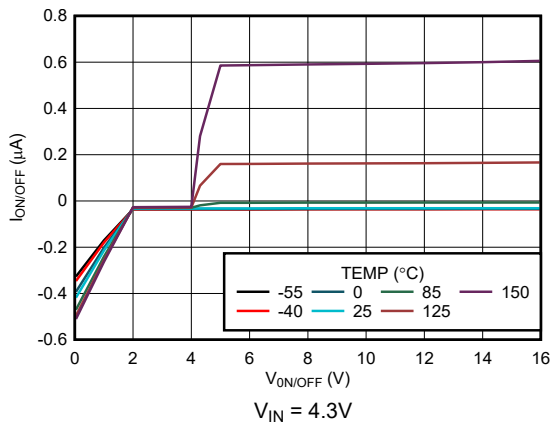

Figure 5-27. ON/OFF Pin Current vs  $V_{ON/OFF}$  (New Chip)

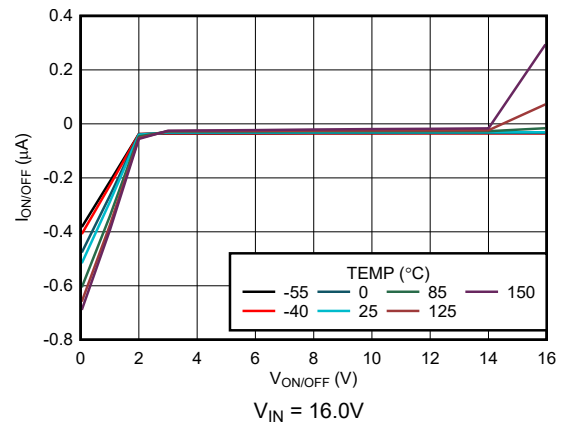

Figure 5-28. ON/OFF Pin Current vs  $V_{ON/OFF}$  (New Chip)

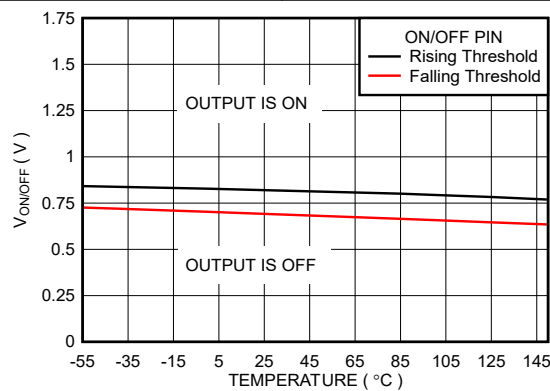

Figure 5-29. ON/OFF Threshold vs Temperature (New Chip)

## 6 Detailed Description

### 6.1 Overview

The LP2981 and LP2981A (LP2981x) are fixed-output, high PSRR, low-dropout regulators that offer exceptional, cost-effective performance for both portable and non-portable applications. The new chip has an output tolerance of  $\pm 1\%$  across load and temperature variation. The new chip is capable of delivering 100mA of continuous load current.

This device features integrated overcurrent protection, thermal shutdown and output enable. The new chip has a built-in soft-start mechanism for controlled inrush current and provide internal output pulldown mechanism. This device delivers excellent line and load transient performance. The operating ambient temperature range of the devices is  $-40^{\circ}\text{C}$  to  $+125^{\circ}\text{C}$ .

### 6.2 Functional Block Diagrams

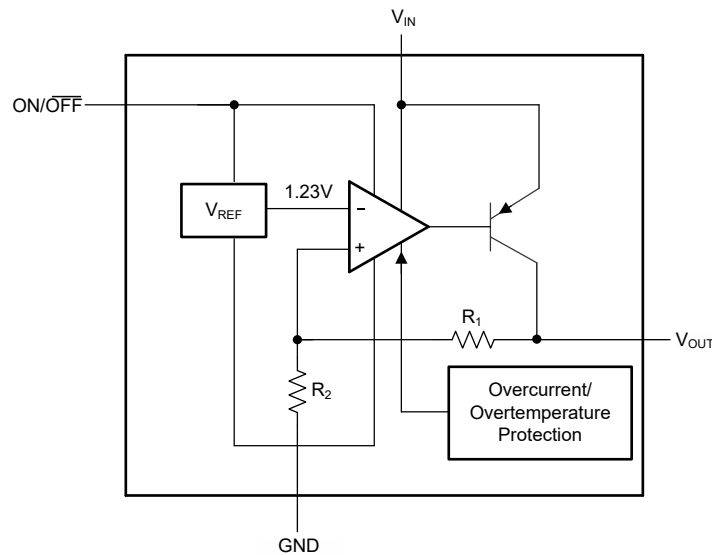

Figure 6-1. Functional Block Diagram (Legacy Chip)

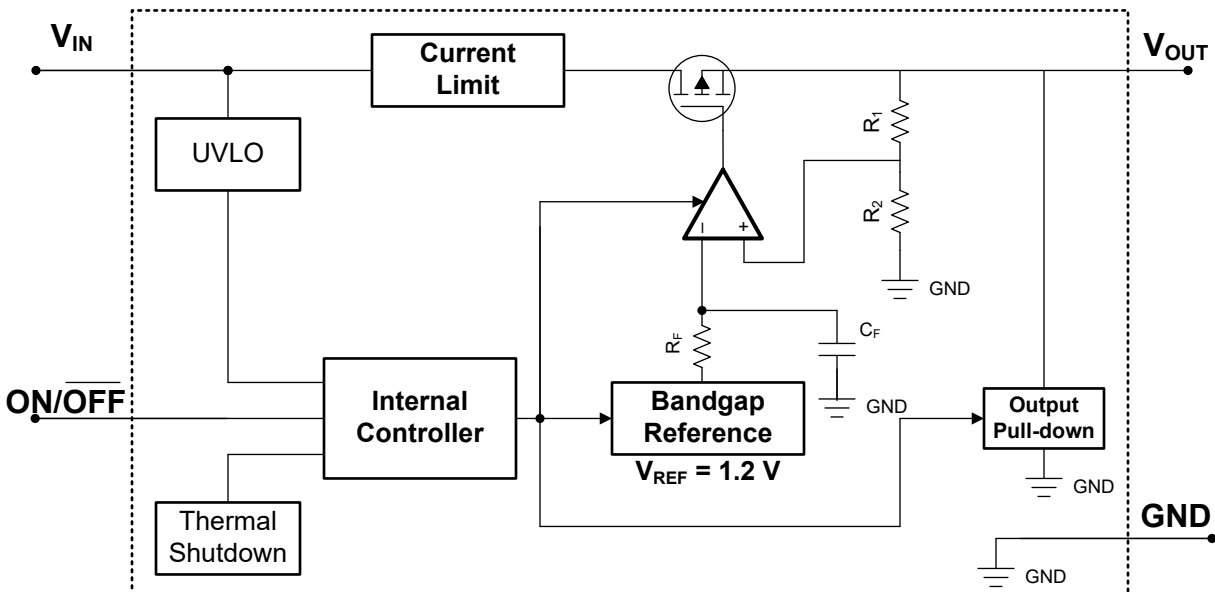

Figure 6-2. Functional Block Diagram (New Chip)

## 6.3 Feature Description

### 6.3.1 Output Enable

The ON/ $\overline{\text{OFF}}$  pin for the device is an active-high pin. The output voltage is enabled when the voltage of the ON/ $\overline{\text{OFF}}$  pin is greater than the high-level input voltage of the ON/ $\overline{\text{OFF}}$  pin and disabled when the ON/ $\overline{\text{OFF}}$  pin voltage is less than the low-level input voltage of the ON/ $\overline{\text{OFF}}$  pin. If independent control of the output voltage is not needed, connect the ON/ $\overline{\text{OFF}}$  pin to the input of the device.

For the legacy chip, apply a signal with a slew rate of  $\geq 40\text{mV}/\mu\text{s}$ . A slow slew rate can cause the shutdown function to operate incorrectly.

For the new chip, there are no slew rate restrictions. Also, the new chip devices have an internal pulldown circuit that activates when the device is disabled by pulling the ON/ $\overline{\text{OFF}}$  pin voltage lower than the low-level input voltage of the ON/ $\overline{\text{OFF}}$  pin to actively discharge the output voltage.

### 6.3.2 Dropout Voltage

Dropout voltage ( $V_{\text{DO}}$ ) is defined as the input voltage minus the output voltage ( $V_{\text{IN}} - V_{\text{OUT}}$ ) at the rated output current ( $I_{\text{RATED}}$ ), where the pass transistor is fully on.  $I_{\text{RATED}}$  is the maximum  $I_{\text{OUT}}$  listed in the [Recommended Operating Conditions](#) table. The pass transistor is in the ohmic or triode region of operation, and acts as a switch. The dropout voltage indirectly specifies a minimum input voltage greater than the nominal programmed output voltage at which the output voltage is expected to stay in regulation. If the input voltage falls to less than the nominal output regulation, then the output voltage falls as well.

For a CMOS regulator, the dropout voltage is determined by the drain-source on-state resistance ( $R_{\text{DS(ON)}}$ ) of the pass transistor. Therefore, if the linear regulator operates at less than the rated current, the dropout voltage for that current scales accordingly. The following equation calculates the  $R_{\text{DS(ON)}}$  of the device.

$$R_{\text{DS(ON)}} = \frac{V_{\text{DO}}}{I_{\text{RATED}}} \quad (1)$$

### 6.3.3 Current Limit

#### 6.3.3.1 Current Limit (Legacy Chip)

The internal current-limit circuit is used to protect the LP2981x against high-load current faults or shorting events. This device is not designed to operate in a steady-state current limit. During a current-limit event, the device sources constant current. Therefore, the output voltage falls when load impedance decreases. If a current limit occurs and the resulting output voltage is low, excessive power can be dissipated across the LDOs resulting in a thermal shutdown of the output. A foldback feature limits the short-circuit current to protect the regulator from damage under all load conditions. If  $V_{\text{OUT}}$  is forced below 0V before ON/ $\overline{\text{OFF}}$  goes high and the load current required exceeds the foldback current limit, the device can not start up correctly.

#### 6.3.3.2 Current Limit (New Chip)

This device has an internal current limit circuit that protects the regulator during transient high-load current faults or shorting events. The current limit is a brick-wall scheme. In a high-load current fault, the brick-wall scheme limits the output current to the current limit ( $I_{\text{CL}}$ ).  $I_{\text{CL}}$  is listed in the [Electrical Characteristics](#) table.

The output voltage is not regulated when the device is in current limit. When a current limit event occurs, the device begins to heat up because of the increase in power dissipation. When the device is in brick-wall current limit, the pass transistor dissipates power  $[(V_{\text{IN}} - V_{\text{OUT}}) \times I_{\text{CL}}]$ . If thermal shutdown is triggered, the device turns off. After the device cools down, the internal thermal shutdown circuit turns the device back on. If the output current fault condition continues, the device cycles between current limit and thermal shutdown. For more information on current limits, see the [Know Your Limits application note](#).

Figure 6-3 shows a diagram of the current limit.

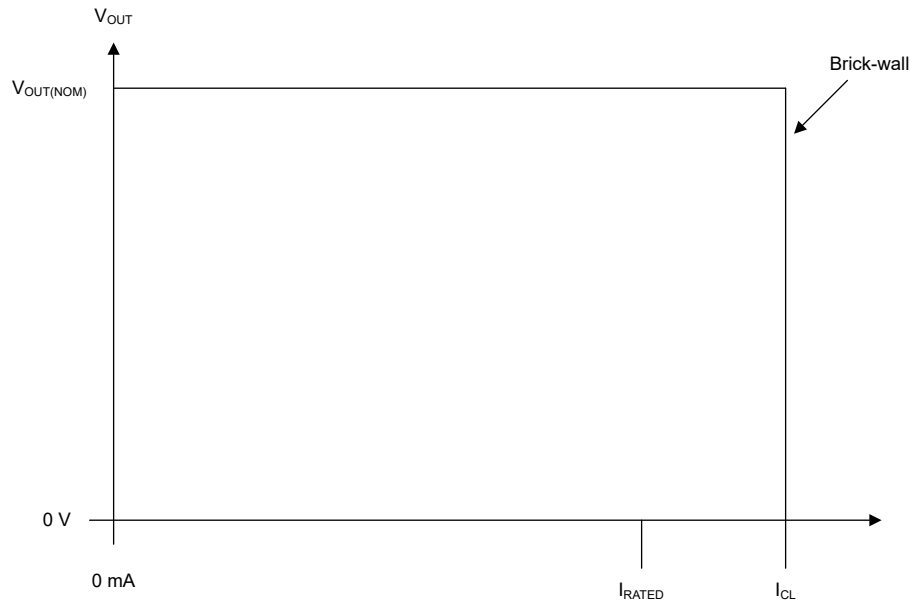

**Figure 6-3. Current Limit**

### 6.3.4 Undervoltage Lockout (UVLO)

For the new chip, the device has an independent undervoltage lockout (UVLO) circuit that monitors the input voltage, allowing a controlled and consistent turn on and off of the output voltage. To prevent the device from turning off if the input drops during turn on, the UVLO has hysteresis as specified in the [Electrical Characteristics](#) table.

### 6.3.5 Thermal Shutdown

The device contains a thermal shutdown protection circuit to disable the device when the junction temperature ( $T_J$ ) of the pass transistor rises to  $T_{SD(\text{shutdown})}$  (typical). Thermal shutdown hysteresis makes sure that the device resets (turns on) when the temperature falls to  $T_{SD(\text{reset})}$  (typical). Thermal shutdown circuit specifications are defined in the [Electrical Characteristics](#).

The thermal time-constant of the semiconductor die is fairly short, thus the device can cycle on and off when thermal shutdown is reached until power dissipation is reduced. Power dissipation during start up can be high from large  $V_{IN} - V_{OUT}$  voltage drops across the device or from high inrush currents charging large output capacitors. Under some conditions, the thermal shutdown protection disables the device before start-up completes.

For reliable operation, limit the junction temperature to the maximum listed in the [Recommended Operating Conditions](#) table. Operation above this maximum temperature causes the device to exceed operational specifications. Although the internal protection circuitry of the device is designed to protect against thermal overall conditions, this circuitry is not intended to replace proper heat sinking. Continuously running the device into thermal shutdown or above the maximum recommended junction temperature reduces long-term reliability.

### 6.3.6 Output Pulldown

The new chip has an output pulldown circuit. The output pulldown activates in the following conditions:

- When the device is disabled ( $V_{ON/OFF} < V_{ON/OFF(\text{LOW})}$ )
- If  $1.0\text{V} < V_{IN} < V_{UVLO}$

Do not rely on the output pulldown circuit for discharging a large amount of output capacitance after the input supply has collapsed because reverse current can flow from the output to the input. This reverse current flow can cause damage to the device. See the [Reverse Current](#) section for more details.

## 6.4 Device Functional Modes

Table 6-1 shows the conditions that lead to the different modes of operation. See the [Electrical Characteristics](#) table for parameter values.

**Table 6-1. Device Functional Mode Comparison**

OPERATING MODE	PARAMETER			
	$V_{IN}$	$V_{ON/OFF}$	$I_{OUT}$	$T_J$
Normal operation	$V_{IN} > V_{OUT(nom)} + V_{DO}$ and $V_{IN} > V_{IN(min)}$	$V_{ON/OFF} > V_{ON/OFF(HI)}$	$I_{OUT} < I_{OUT(max)}$	$T_J < T_{SD(shutdown)}$
Dropout operation	$V_{IN(min)} < V_{IN} < V_{OUT(nom)} + V_{DO}$	$V_{ON/OFF} > V_{ON/OFF(HI)}$	$I_{OUT} < I_{OUT(max)}$	$T_J < T_{SD(shutdown)}$
Disabled (any true condition disables the device)	$V_{IN} < V_{UVLO}$	$V_{ON/OFF} < V_{ON/OFF(LOW)}$	Not applicable	$T_J > T_{SD(shutdown)}$

### 6.4.1 Normal Operation

The device regulates to the nominal output voltage when the following conditions are met:

- The input voltage is greater than the nominal output voltage plus the dropout voltage ( $V_{OUT(nom)} + V_{DO}$ )
- The output current is less than the current limit ( $I_{OUT} < I_{CL}$ )
- The device junction temperature is less than the thermal shutdown temperature ( $T_J < T_{SD}$ )
- The  $\overline{ON/OFF}$  voltage has previously exceeded the  $\overline{ON/OFF}$  rising threshold voltage and has not yet decreased to less than the enable falling threshold

### 6.4.2 Dropout Operation

If the input voltage is lower than the nominal output voltage plus the specified dropout voltage, but all other conditions are met for normal operation, the device operates in dropout mode. In this mode, the output voltage tracks the input voltage. During this mode, the transient performance of the device becomes significantly degraded because the pass transistor is in the ohmic or triode region, and acts as a switch. Line or load transients in dropout can result in large output-voltage deviations.

When the device is in a steady dropout state (defined as when the device is in dropout,  $V_{IN} < V_{OUT(NOM)} + V_{DO}$ , directly after being in a normal regulation state, but *not* during start up), the pass transistor is driven into the ohmic or triode region. When the input voltage returns to a value greater than or equal to the nominal output voltage plus the dropout voltage ( $V_{OUT(NOM)} + V_{DO}$ ), the output voltage can overshoot for a short period of time while the device pulls the pass transistor back into the linear region.

### 6.4.3 Disabled

The output of the device can be shutdown by forcing the voltage of the  $\overline{ON/OFF}$  pin to less than the maximum  $\overline{ON/OFF}$  pin low-level input voltage (see the [Electrical Characteristics](#) table). When disabled, the pass transistor is turned off, internal circuits are shutdown, and the output voltage is actively discharged to ground by an internal discharge circuit from the output to ground.



## 7 Application and Implementation

### Note

Information in the following applications sections is not part of the TI component specification, and TI does not warrant its accuracy or completeness. TI's customers are responsible for determining suitability of components for their purposes, as well as validating and testing their design implementation to confirm system functionality.

### 7.1 Application Information

The LP2981x is a linear voltage regulator operating from 2.5V to 16V (new chip) on the input and regulates voltages between 1.2V to 5V with  $\pm 1\%$  accuracy (across line, load and temperature) and 100mA maximum output current.

Successfully implementing an LDO in an application depends on the application requirements. If the requirements are simply input voltage and output voltage, compliance specifications (such as internal power dissipation or stability) must be verified to provide a solid design. If timing, start-up, noise, power supply rejection ratio (PSRR), or any other transient specification is required, then the design becomes more challenging.

#### 7.1.1 Recommended Capacitor Types

##### 7.1.1.1 Recommended Capacitors (Legacy Chip)

###### 7.1.1.1.1 Tantalum Capacitors

For the legacy chip, tantalum capacitors are the best choice for use at the output of the LDO. Most good quality tantalums can be used with the device (legacy chip), but check the manufacturer data sheet to verify that the ESR is in range. At lower temperatures, as ESR increases, a capacitor with ESR, near the upper limit for stability at room temperature can cause instability. For very low temperature applications, output tantalum capacitors can be used in parallel configuration to prevent the ESR from going up too high.

###### 7.1.1.1.2 Ceramic Capacitors

For the legacy chip, ceramic capacitors are not recommended for use at the output of the LDO. This recommendation is because the ESR of a ceramic can be low enough to go below the minimum stable value for the LP2981x (legacy chip). A measured 2.2 $\mu$ F ceramic capacitor is verified to have an ESR of approximately 15m $\Omega$ , which is low enough to cause oscillations. If a ceramic capacitor is used on the output, a 1 $\Omega$  resistor is required to be placed in series with the capacitor.

###### 7.1.1.1.3 Aluminum Capacitors

For the legacy chip, aluminum electrolytics are not typically suggested for use with the LDO, because of the large physical size. These aluminum capacitors must meet the same ESR requirements over the operating temperature range, more difficult because of the steep increase at cold temperature. An aluminum electrolytic can exhibit an ESR increase of as much as 50x when going from +20°C to -40°C. Also, some aluminum electrolytics are not operational below -25°C because the electrolyte can freeze.

##### 7.1.1.2 Recommended Capacitors (New Chip)

The new chip is designed to be stable using low equivalent series resistance (ESR) ceramic capacitors at the input and output. Multilayer ceramic capacitors have become the industry standard for these types of applications and are recommended, but must be used with good judgment. Ceramic capacitors that employ X7R-, X5R-, and C0G-rated dielectric materials provide relatively good capacitive stability across temperature, whereas using Y5V-rated capacitors is discouraged because of large variations in capacitance.

Maximum supported ESR range across complete temperature (-40°C to 125°C) and load current range (0mA–50mA) is less than 1 $\Omega$ . If adding to an existing implementation, where different types of capacitors with higher ESR are used, place a low ESR MLCC capacitor with a 100nF value as close as possible to the device output pin ( $V_{OUT}$ ).

Regardless of the ceramic capacitor type selected, the effective capacitance varies with operating voltage and temperature. Generally, expect the effective capacitance to decrease by as much as 50%. The input and output capacitors listed in the [Recommended Operating Conditions](#) table account for an effective capacitance of approximately 50% of the nominal value.

### 7.1.2 Input and Output Capacitor Requirements

#### 7.1.2.1 Input Capacitor

For the legacy chip, an input capacitor ( $C_{IN}$ )  $\geq 1\mu\text{F}$  is required (the amount of capacitance can be increased without limit). Any good-quality tantalum or ceramic capacitor can be used. The capacitor must be located no more than half an inch from the input pin and returned to a clean analog ground.

For the new chip, although an input capacitor is not required for stability, good analog design practice is to connect a capacitor from IN to GND. This capacitor counteracts reactive input sources and improves transient response, input ripple, and PSRR. Use an input capacitor if the source impedance is more than  $0.5\Omega$ . A higher value capacitor can be necessary if large, fast rise-time load or line transients are anticipated or if the device is located several inches from the input power source.

#### 7.1.2.2 Output Capacitor

##### 7.1.2.2.1 Output Capacitor (Legacy Chip)

The output capacitor must meet both the requirement for minimum amount of capacitance and equivalent series resistance (ESR) value. Curves are provided that show the allowable ESR range as a function of load current for various output voltages and capacitor values (see [Figure 7-3](#), [Figure 7-4](#), [Figure 7-5](#), and [Figure 7-6](#)).

- Minimum  $C_{OUT}$ :  $3.3\mu\text{F}$  (can be increased without limit to improve transient response stability margin)
- ESR range: See [Figure 7-3](#), [Figure 7-4](#), [Figure 7-5](#), and [Figure 7-6](#).

Both the minimum capacitance and ESR requirement must be met over the entire operating temperature range. Depending on the type of capacitor used, both of these parameters can vary significantly with temperature (see the [Recommended Capacitors \(Legacy Chip\)](#) section).

##### 7.1.2.2.2 Output Capacitor (New Chip)

Dynamic device performance is improved by using an output capacitor. Use an output capacitor, preferably ceramic capacitors, within the range (both capacitance and max ESR) specified in the [Recommended Operating Conditions](#) table for stability.

### 7.1.3 Estimating Junction Temperature

The JEDEC standard now recommends the use of psi ( $\Psi$ ) thermal metrics to estimate the junction temperatures of the linear regulator when in-circuit on a typical PCB board application. These metrics are not thermal resistance parameters and instead offer a practical and relative way to estimate junction temperature. These psi metrics are determined to be significantly independent of the copper area available for heat-spreading. The [Thermal Information](#) table lists the primary thermal metrics, which are the junction-to-top characterization parameter ( $\psi_{JT}$ ) and junction-to-board characterization parameter ( $\psi_{JB}$ ). These parameters provide two methods for calculating the junction temperature ( $T_J$ ), as described in the following equations. Use the junction-to-top characterization parameter ( $\psi_{JT}$ ) with the temperature at the top-center of the device package ( $T_T$ ) to calculate the junction temperature. Use the junction-to-board characterization parameter ( $\psi_{JB}$ ) with the PCB surface temperature 1mm from the device package ( $T_B$ ) to calculate the junction temperature.

$$T_J = T_T + \psi_{JT} \times P_D \quad (2)$$

where:

- $P_D$  is the dissipated power
- $T_T$  is the temperature at the center-top of the device package

$$T_J = T_B + \psi_{JB} \times P_D \quad (3)$$

where:

- $T_B$  is the PCB surface temperature measured 1mm from the device package and centered on the package edge

For detailed information on the thermal metrics and how to use these metrics, see the [Semiconductor and IC Package Thermal Metrics](#) application note.

#### 7.1.4 Power Dissipation ( $P_D$ )

Circuit reliability requires consideration of the device power dissipation, location of the circuit on the printed circuit board (PCB), and correct sizing of the thermal plane. The PCB area around the regulator must have few or no other heat-generating devices that cause added thermal stress.

To first-order approximation, power dissipation in the regulator depends on the input-to-output voltage difference and load conditions. The following equation calculates power dissipation ( $P_D$ ).

$$P_D = (V_{IN} - V_{OUT}) \times I_{OUT} \quad (4)$$

---

#### Note

Power dissipation can be minimized, and therefore greater efficiency can be achieved, by correct selection of the system voltage rails. For the lowest power dissipation use the minimum input voltage required for correct output regulation.

---

For devices with a thermal pad, the primary heat conduction path for the device package is through the thermal pad to the PCB. Solder the thermal pad to a copper pad area under the device. This pad area must contain an array of plated vias that conduct heat to additional copper planes for increased heat dissipation.

The maximum power dissipation determines the maximum allowable ambient temperature ( $T_A$ ) for the device. According to the following equation, power dissipation and junction temperature are most often related by the junction-to-ambient thermal resistance ( $R_{\theta JA}$ ) of the combined PCB and device package and the temperature of the ambient air ( $T_A$ ).

$$T_J = T_A + (R_{\theta JA} \times P_D) \quad (5)$$

Thermal resistance ( $R_{\theta JA}$ ) is highly dependent on the heat-spreading capability built into the particular PCB design, and therefore varies according to the total copper area, copper weight, and location of the planes. The junction-to-ambient thermal resistance listed in the [Thermal Information](#) table is determined by the JEDEC standard PCB and copper-spreading area, and is used as a relative measure of package thermal performance. As mentioned in the [An empirical analysis of the impact of board layout on LDO thermal performance](#) application note,  $R_{\theta JA}$  can be improved by 35% to 55% compared to the [Thermal Information](#) table value with the PCB board layout optimization.

#### 7.1.5 Reverse Current

Excessive reverse current can damage this device. Reverse current flows through the intrinsic body diode of the pass transistor instead of the normal conducting channel. At high magnitudes, this current flow degrades the long-term reliability of the device.

Conditions where reverse current can occur are outlined in this section, all of which can exceed the absolute maximum rating of  $V_{OUT} \leq V_{IN} + 0.3 \text{ V}$ .

- If the device has a large  $C_{OUT}$  and the input supply collapses with little or no load current
- The output is biased when the input supply is not established
- The output is biased above the input supply

If reverse current flow is expected in the application, use external protection to protect the device. Reverse current is not limited in the device, so external limiting is required if extended reverse voltage operation is anticipated.

Figure 7-1 shows one approach for protecting the device.

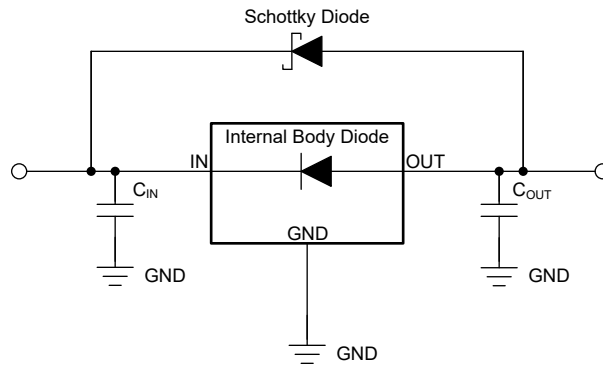

**Figure 7-1. Example Circuit for Reverse Current Protection Using a Schottky Diode**

## 7.2 Typical Application

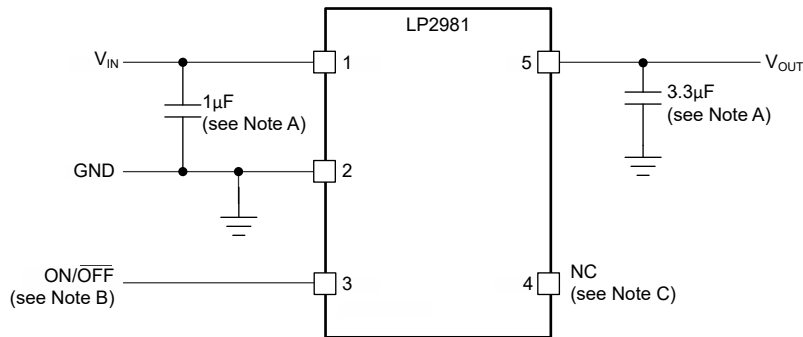

- A. Minimum  $C_{OUT}$  value for stability (can be increased without limit for improved stability and transient response).
- B. ON/OFF must be actively terminated. Connect to  $V_{IN}$  if shutdown feature is not used.
- C. For the new chip, pin 4 (NC) is not internally connected.

**Figure 7-2. LP2981x Typical Application**

### 7.2.1 Design Requirements

Table 7-1 lists the parameters for this application.

**Table 7-1. Design Parameters**

PARAMETER	DESIGN REQUIREMENT
Input voltage	12 V $\pm$ 10%, provided by an external regulator
Output voltage	3.3 V $\pm$ 1%
Output current	100 mA (maximum), 1 mA (minimum)
RMS noise, 300 Hz to 50 kHz	< 1 mV <sub>RMS</sub>
PSRR at 1 kHz	> 40 dB

## 7.2.2 Detailed Design Procedure

### 7.2.2.1 ON and OFF Input Operation

The LP2981x is shut off by pulling the ON/OFF input low, and turned on by driving the input high. If this feature is not to be used, the ON/OFF input must be tied to  $V_{IN}$  to keep the regulator on at all times (the ON/OFF input must **not** be left floating).

For proper operation, the signal source used to drive the ON/OFF input must be able to swing above and below the specified turn-on or turn-off voltage thresholds which specify an ON or OFF state (see the [Electrical Characteristics](#) ).

The ON/OFF signal can come from either a totem-pole output, or an open-collector output with pullup resistor to the LP2981 and LP2891A input voltage or another logic supply. The high-level voltage can exceed the LP2981 and LP2891A input voltage, but must remain within the ratings list in the [Absolute Maximum Ratings](#) for the ON/OFF pin.

### 7.2.3 Application Curves

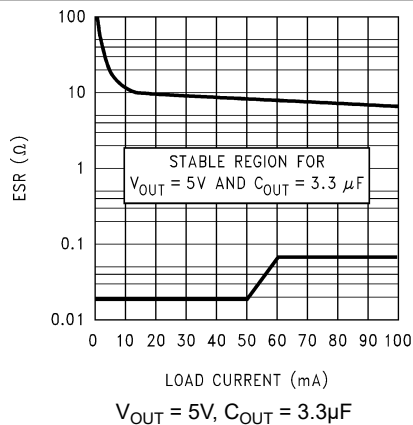

Figure 7-3. 5V, 3.3 $\mu$ F ESR Curves (Legacy Chip)

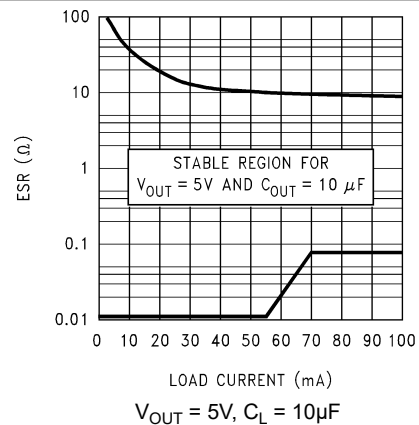

Figure 7-4. 5V, 10 $\mu$ F ESR Curves (Legacy Chip)

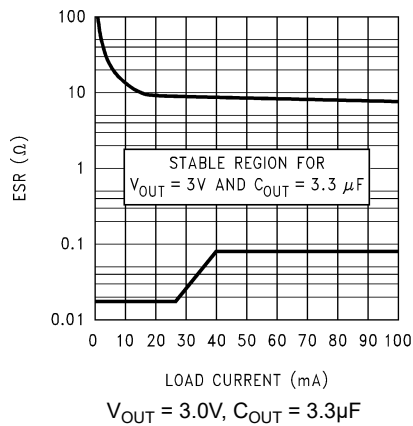

Figure 7-5. 3.0V, 3.3 $\mu$ F ESR Curves (Legacy Chip)

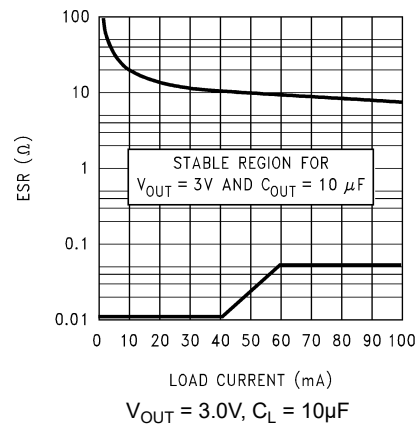

Figure 7-6. 3.0V, 10 $\mu$ F ESR Curves (Legacy Chip)

### 7.2.3 Application Curves (continued)

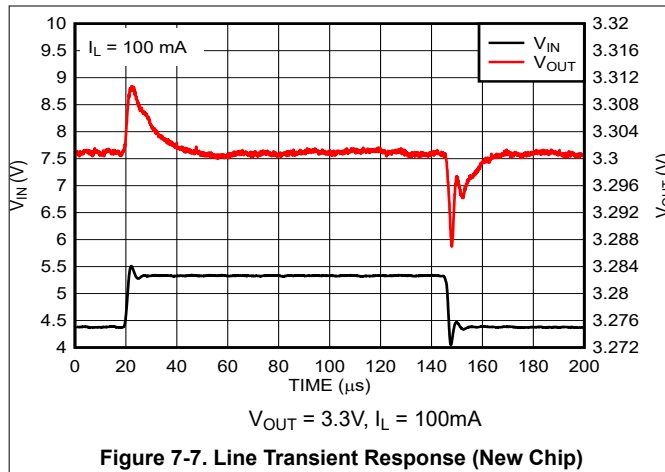

Figure 7-7. Line Transient Response (New Chip)

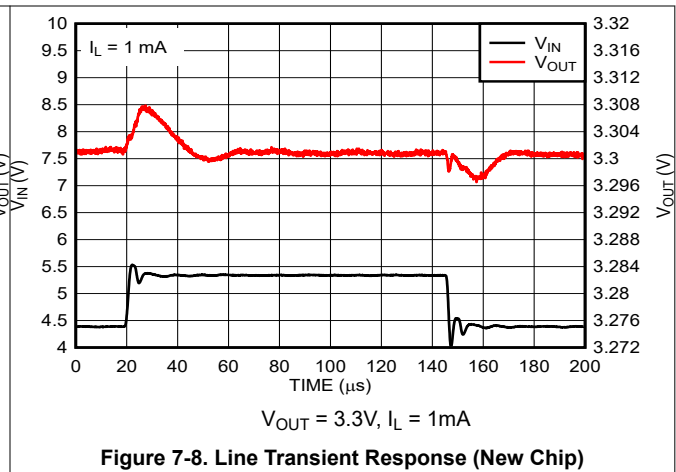

Figure 7-8. Line Transient Response (New Chip)

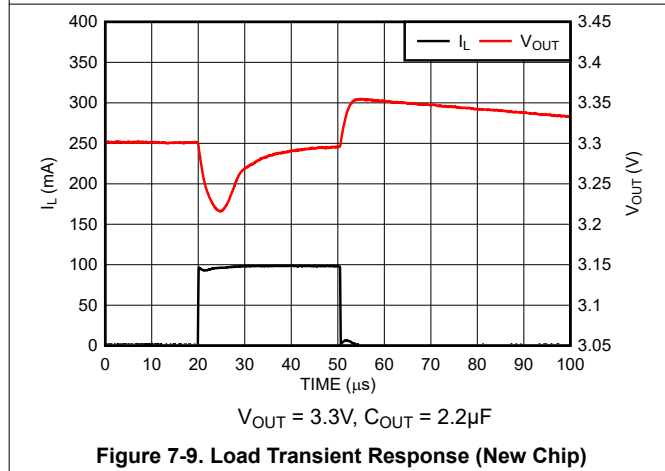

Figure 7-9. Load Transient Response (New Chip)

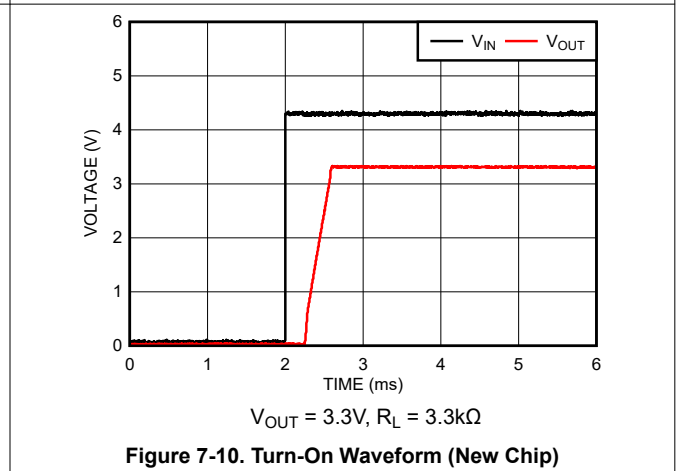

Figure 7-10. Turn-On Waveform (New Chip)

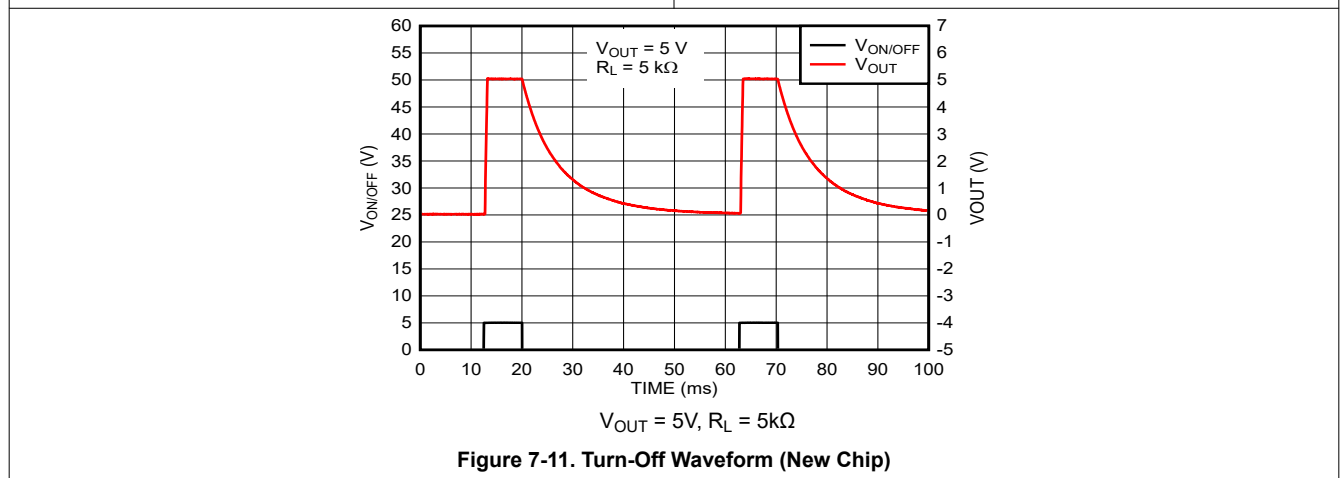

Figure 7-11. Turn-Off Waveform (New Chip)

### 7.3 Power Supply Recommendations

The LP2981x is designed to operate from an input voltage supply range between 2.5V and 16V (for the new chip). The input voltage range provides adequate headroom for the device to have a regulated output. This input supply must be well regulated. If the input supply is noisy, additional input capacitors with low ESR can help improve the output noise performance.

## 7.4 Layout

### 7.4.1 Layout Guidelines

For best overall performance, place all circuit components on the same side of the printed-circuit board and as near as practical to the respective LDO pin connections. Place ground return connections to the input and output capacitors, and to the LDO ground pin as close to each other as possible, connected by a wide, component-side, copper surface. The use of vias and long traces to create LDO circuit connections is strongly discouraged and negatively affects system performance. This grounding and layout scheme minimizes inductive parasitics, and thereby reduces load-current transients, minimizes noise, and increases circuit stability. A ground reference plane is also recommended and is either embedded in the PCB or located on the bottom side of the PCB opposite the components. This reference plane serves to assure accuracy of the output voltage, shield noise, and behaves similar to a thermal plane to spread (or sink) heat from the LDO device. In most applications, this ground plane is necessary to meet thermal requirements.

### 7.4.2 Layout Example

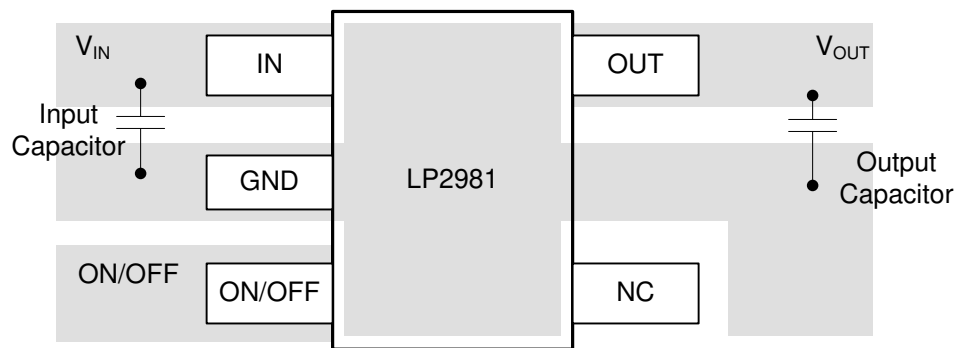

**Figure 7-12. Recommended Layout**

## 8 Device and Documentation Support

### 8.1 Device Nomenclature

**Table 8-1. Available Options**

PRODUCT <sup>(1)</sup>	V <sub>OUT</sub>
LP2981c-xyyyz	<p><b>c</b> is the accuracy specification for the legacy chip (A or blank). See the <a href="#">Electrical Characteristics</a> for more information. This character is insignificant for the new chip.</p> <p><b>yyy</b> is the package designator (DBV = SOT-23). <b>z</b> is the reel designator size. See the Package Addendum for more information on package quantity. <b>xx</b> is the nominal output voltage (for example, 33 = 3.3V; 50 = 5.0V). This device ships with either the legacy chip (CSO: DLN or GF8) or the new chip (CSO: RFB), which uses the latest manufacturing flow. The reel packaging label provides CSO information to distinguish which chip is used. Device performance for new and legacy chips is denoted throughout the document.</p>

(1) For the most current package and ordering information, see the Package Option Addendum at the end of this document, or visit the device product folder at [www.ti.com](http://www.ti.com).

### 8.2 Documentation Support

#### 8.2.1 Related Documentation

For related documentation see the following:

- Texas Instruments, [LDO Noise Demystified application note](#)
- Texas Instruments, [LDO PSRR Measurement Simplified application note](#)
- Texas Instruments, [A Topical Index of TI LDO Application Notes application note](#)
- Texas Instruments, [Know Your Limits application note](#)

### 8.3 Receiving Notification of Documentation Updates

To receive notification of documentation updates, navigate to the device product folder on ti.com. In the upper right corner, click on *Alert me* to register and receive a weekly digest of any product information that has changed. For change details, review the revision history included in any revised document.

### 8.4 Support Resources

[TI E2E™ support forums](#) are an engineer's go-to source for fast, verified answers and design help — straight from the experts. Search existing answers or ask your own question to get the quick design help you need.

Linked content is provided "AS IS" by the respective contributors. They do not constitute TI specifications and do not necessarily reflect TI's views; see TI's [Terms of Use](#).

### 8.5 Trademarks

TI E2E™ is a trademark of Texas Instruments.

All trademarks are the property of their respective owners.

### 8.6 Electrostatic Discharge Caution



This integrated circuit can be damaged by ESD. Texas Instruments recommends that all integrated circuits be handled with appropriate precautions. Failure to observe proper handling and installation procedures can cause damage.

ESD damage can range from subtle performance degradation to complete device failure. Precision integrated circuits may be more susceptible to damage because very small parametric changes could cause the device not to meet its published specifications.

### 8.7 Glossary

#### [TI Glossary](#)

This glossary lists and explains terms, acronyms, and definitions.



## 9 Revision History

NOTE: Page numbers for previous revisions may differ from page numbers in the current version.

<b>Changes from Revision H (May 2024) to Revision I (February 2025)</b>	<b>Page</b>
• Added LP2981A information throughout document.....	1
• Added clarification to last sentence of <i>Description</i> section that the soft-start mechanism refers to the new chip.....	1
• Changed description of NC (pin 4).....	3
• Changed <i>Short-Circuit Current vs Time (New Chip)</i> , <i>Instantaneous Short-Circuit Current vs Temperature (New Chip)</i> , <i>Short-Circuit Current vs Output Voltage (V<sub>OUT</sub>) (New Chip)</i> curves.....	8
• Changed <i>Overview</i> section.....	13
• Changed <i>Functional Block Diagrams</i> section.....	13
• Changed <i>Output Enable</i> section.....	14
• Added <i>Current Limit (Legacy Chip)</i> and <i>Current Limit (New Chip)</i> sections.....	14
• Added maximum supported ESR range discussion to <i>Recommended Capacitors (New Chip)</i> section.....	17
• Changed <i>Output Capacitor</i> section.....	18
• Changed <i>Device Nomenclature</i> section.....	24

---

<b>Changes from Revision G (July 2016) to Revision H (December 2023)</b>	<b>Page</b>
• Updated the numbering format for tables, figures, and cross-references throughout the document.....	1
• Changed entire document to align with current family format.....	1
• Added M3 devices to document.....	1
• Added <i>Device Nomenclature</i> section.....	24
• Added three references to <i>Related Documentation</i> .....	24

---

## 10 Mechanical, Packaging, and Orderable Information

The following pages include mechanical, packaging, and orderable information. This information is the most current data available for the designated devices. This data is subject to change without notice and revision of this document. For browser-based versions of this data sheet, refer to the left-hand navigation.

**PACKAGING INFORMATION**

Orderable part number	Status (1)	Material type (2)	Package   Pins	Package qty   Carrier	RoHS (3)	Lead finish/ Ball material (4)	MSL rating/ Peak reflow (5)	Op temp (°C)	Part marking (6)
<a href="#">LP2981-28DBVR</a>	Active	Production	SOT-23 (DBV)   5	3000   LARGE T&R	Yes	SN	Level-1-260C-UNLIM	-40 to 125	LP5G
LP2981-28DBVR.A	Active	Production	SOT-23 (DBV)   5	3000   LARGE T&R	Yes	SN	Level-1-260C-UNLIM	-40 to 125	LP5G
<a href="#">LP2981-28DBVT</a>	Active	Production	SOT-23 (DBV)   5	250   SMALL T&R	Yes	SN	Level-1-260C-UNLIM	-40 to 125	LP5G
LP2981-28DBVT.A	Active	Production	SOT-23 (DBV)   5	250   SMALL T&R	Yes	SN	Level-1-260C-UNLIM	-40 to 125	LP5G
<a href="#">LP2981-28DBVTG4</a>	Active	Production	SOT-23 (DBV)   5	250   SMALL T&R	Yes	NIPDAU	Level-1-260C-UNLIM	-40 to 125	LP5G
LP2981-28DBVTG4.A	Active	Production	SOT-23 (DBV)   5	250   SMALL T&R	Yes	NIPDAU	Level-1-260C-UNLIM	-40 to 125	LP5G
<a href="#">LP2981-29DBVR</a>	Active	Production	SOT-23 (DBV)   5	3000   LARGE T&R	Yes	NIPDAU	Level-1-260C-UNLIM	-40 to 125	LP3G
LP2981-29DBVR.A	Active	Production	SOT-23 (DBV)   5	3000   LARGE T&R	Yes	NIPDAU	Level-1-260C-UNLIM	-40 to 125	LP3G
<a href="#">LP2981-30DBVR</a>	Active	Production	SOT-23 (DBV)   5	3000   LARGE T&R	Yes	NIPDAU   SN	Level-1-260C-UNLIM	-40 to 125	(LP7G, LP7L)
LP2981-30DBVR.A	Active	Production	SOT-23 (DBV)   5	3000   LARGE T&R	Yes	SN	Level-1-260C-UNLIM	-40 to 125	(LP7G, LP7L)
<a href="#">LP2981-30DBVT</a>	Active	Production	SOT-23 (DBV)   5	250   SMALL T&R	Yes	NIPDAU   SN	Level-1-260C-UNLIM	-40 to 125	(LP7G, LP7L)
LP2981-30DBVT.A	Active	Production	SOT-23 (DBV)   5	250   SMALL T&R	Yes	NIPDAU	Level-1-260C-UNLIM	-40 to 125	(LP7G, LP7L)
<a href="#">LP2981-33DBVR</a>	Active	Production	SOT-23 (DBV)   5	3000   LARGE T&R	Yes	NIPDAU   SN	Level-1-260C-UNLIM	-40 to 125	(LPBG, LPBL)
LP2981-33DBVR.A	Active	Production	SOT-23 (DBV)   5	3000   LARGE T&R	Yes	SN	Level-1-260C-UNLIM	-40 to 125	(LPBG, LPBL)
<a href="#">LP2981-33DBVT</a>	Obsolete	Production	SOT-23 (DBV)   5	-	-	Call TI	Call TI	-40 to 125	(LPBG, LPBL)
<a href="#">LP2981-50DBVR</a>	Active	Production	SOT-23 (DBV)   5	3000   LARGE T&R	Yes	NIPDAU   SN	Level-1-260C-UNLIM	-40 to 125	(LPDG, LPDL)
LP2981-50DBVR.A	Active	Production	SOT-23 (DBV)   5	3000   LARGE T&R	Yes	SN	Level-1-260C-UNLIM	-40 to 125	(LPDG, LPDL)
<a href="#">LP2981-50DBVRG4</a>	Active	Production	SOT-23 (DBV)   5	3000   LARGE T&R	Yes	NIPDAU	Level-1-260C-UNLIM	-40 to 125	(LPDG, LPDL)
LP2981-50DBVRG4.A	Active	Production	SOT-23 (DBV)   5	3000   LARGE T&R	Yes	NIPDAU	Level-1-260C-UNLIM	-40 to 125	(LPDG, LPDL)
<a href="#">LP2981-50DBVT</a>	Obsolete	Production	SOT-23 (DBV)   5	-	-	Call TI	Call TI	-40 to 125	(LPDG, LPDL)
<a href="#">LP2981A-28DBVR</a>	Active	Production	SOT-23 (DBV)   5	3000   LARGE T&R	Yes	NIPDAU   SN	Level-1-260C-UNLIM	-40 to 125	(LP6G, LP6L)
LP2981A-28DBVR.A	Active	Production	SOT-23 (DBV)   5	3000   LARGE T&R	Yes	NIPDAU	Level-1-260C-UNLIM	-40 to 125	(LP6G, LP6L)
<a href="#">LP2981A-28DBVT</a>	Active	Production	SOT-23 (DBV)   5	250   SMALL T&R	Yes	NIPDAU   SN	Level-1-260C-UNLIM	-40 to 125	(LP6G, LP6L)
LP2981A-28DBVT.A	Active	Production	SOT-23 (DBV)   5	250   SMALL T&R	Yes	NIPDAU	Level-1-260C-UNLIM	-40 to 125	(LP6G, LP6L)
<a href="#">LP2981A-29DBVR</a>	Active	Production	SOT-23 (DBV)   5	3000   LARGE T&R	Yes	NIPDAU	Level-1-260C-UNLIM	-40 to 125	LRBG
LP2981A-29DBVR.A	Active	Production	SOT-23 (DBV)   5	3000   LARGE T&R	Yes	NIPDAU	Level-1-260C-UNLIM	-40 to 125	LRBG
<a href="#">LP2981A-30DBVR</a>	Active	Production	SOT-23 (DBV)   5	3000   LARGE T&R	Yes	NIPDAU   SN	Level-1-260C-UNLIM	-40 to 125	(LP8G, LP8L)
LP2981A-30DBVR.A	Active	Production	SOT-23 (DBV)   5	3000   LARGE T&R	Yes	SN	Level-1-260C-UNLIM	-40 to 125	(LP8G, LP8L)
<a href="#">LP2981A-30DBVRG4</a>	Active	Production	SOT-23 (DBV)   5	3000   LARGE T&R	Yes	NIPDAU	Level-1-260C-UNLIM	-40 to 125	LP8G

Orderable part number	Status (1)	Material type (2)	Package   Pins	Package qty   Carrier	RoHS (3)	Lead finish/ Ball material (4)	MSL rating/ Peak reflow (5)	Op temp (°C)	Part marking (6)
LP2981A-30DBVRG4.A	Active	Production	SOT-23 (DBV)   5	3000   LARGE T&R	Yes	NIPDAU	Level-1-260C-UNLIM	-40 to 125	LP8G
<a href="#">LP2981A-30DBVTG4</a>	Active	Production	SOT-23 (DBV)   5	250   SMALL T&R	Yes	NIPDAU	Level-1-260C-UNLIM	-40 to 125	LP8G
LP2981A-30DBVTG4.A	Active	Production	SOT-23 (DBV)   5	250   SMALL T&R	Yes	NIPDAU	Level-1-260C-UNLIM	-40 to 125	LP8G
<a href="#">LP2981A-33DBVR</a>	Active	Production	SOT-23 (DBV)   5	3000   LARGE T&R	Yes	NIPDAU   SN	Level-1-260C-UNLIM	-40 to 125	(LPCG, LPCL)
LP2981A-33DBVR.A	Active	Production	SOT-23 (DBV)   5	3000   LARGE T&R	Yes	SN	Level-1-260C-UNLIM	-40 to 125	(LPCG, LPCL)
<a href="#">LP2981A-33DBVRG4</a>	Active	Production	SOT-23 (DBV)   5	3000   LARGE T&R	Yes	NIPDAU	Level-1-260C-UNLIM	-40 to 125	LPCG
LP2981A-33DBVRG4.A	Active	Production	SOT-23 (DBV)   5	3000   LARGE T&R	Yes	NIPDAU	Level-1-260C-UNLIM	-40 to 125	LPCG
<a href="#">LP2981A-33DBVTG4</a>	Active	Production	SOT-23 (DBV)   5	250   SMALL T&R	Yes	NIPDAU	Level-1-260C-UNLIM	-40 to 125	LPCG
LP2981A-33DBVTG4.A	Active	Production	SOT-23 (DBV)   5	250   SMALL T&R	Yes	NIPDAU	Level-1-260C-UNLIM	-40 to 125	LPCG
<a href="#">LP2981A-50DBVR</a>	Active	Production	SOT-23 (DBV)   5	3000   LARGE T&R	Yes	NIPDAU   SN	Level-1-260C-UNLIM	-40 to 125	(LPEG, LPEL)
LP2981A-50DBVR.A	Active	Production	SOT-23 (DBV)   5	3000   LARGE T&R	Yes	SN	Level-1-260C-UNLIM	-40 to 125	(LPEG, LPEL)
<a href="#">LP2981A-50DBVRG4</a>	Active	Production	SOT-23 (DBV)   5	3000   LARGE T&R	Yes	NIPDAU	Level-1-260C-UNLIM	-40 to 125	(LPEG, LPEL)
LP2981A-50DBVRG4.A	Active	Production	SOT-23 (DBV)   5	3000   LARGE T&R	Yes	NIPDAU	Level-1-260C-UNLIM	-40 to 125	(LPEG, LPEL)
<a href="#">LP2981A-50DBVT</a>	Active	Production	SOT-23 (DBV)   5	250   SMALL T&R	Yes	NIPDAU	Level-1-260C-UNLIM	-40 to 125	(LPEG, LPEL)
LP2981A-50DBVT.A	Active	Production	SOT-23 (DBV)   5	250   SMALL T&R	Yes	NIPDAU	Level-1-260C-UNLIM	-40 to 125	(LPEG, LPEL)

(1) **Status:** For more details on status, see our [product life cycle](#).

(2) **Material type:** When designated, preproduction parts are prototypes/experimental devices, and are not yet approved or released for full production. Testing and final process, including without limitation quality assurance, reliability performance testing, and/or process qualification, may not yet be complete, and this item is subject to further changes or possible discontinuation. If available for ordering, purchases will be subject to an additional waiver at checkout, and are intended for early internal evaluation purposes only. These items are sold without warranties of any kind.

(3) **RoHS values:** Yes, No, RoHS Exempt. See the [TI RoHS Statement](#) for additional information and value definition.

(4) **Lead finish/Ball material:** Parts may have multiple material finish options. Finish options are separated by a vertical ruled line. Lead finish/Ball material values may wrap to two lines if the finish value exceeds the maximum column width.

(5) **MSL rating/Peak reflow:** The moisture sensitivity level ratings and peak solder (reflow) temperatures. In the event that a part has multiple moisture sensitivity ratings, only the lowest level per JEDEC standards is shown. Refer to the shipping label for the actual reflow temperature that will be used to mount the part to the printed circuit board.

(6) **Part marking:** There may be an additional marking, which relates to the logo, the lot trace code information, or the environmental category of the part.

Multiple part markings will be inside parentheses. Only one part marking contained in parentheses and separated by a "~" will appear on a part. If a line is indented then it is a continuation of the previous line and the two combined represent the entire part marking for that device.

**Important Information and Disclaimer:** The information provided on this page represents TI's knowledge and belief as of the date that it is provided. TI bases its knowledge and belief on information provided by third parties, and makes no representation or warranty as to the accuracy of such information. Efforts are underway to better integrate information from third parties. TI has taken and continues to take reasonable steps to provide representative and accurate information but may not have conducted destructive testing or chemical analysis on incoming materials and chemicals. TI and TI suppliers consider certain information to be proprietary, and thus CAS numbers and other limited information may not be available for release.

In no event shall TI's liability arising out of such information exceed the total purchase price of the TI part(s) at issue in this document sold by TI to Customer on an annual basis.

## TAPE AND REEL INFORMATION



### QUADRANT ASSIGNMENTS FOR PIN 1 ORIENTATION IN TAPE



\*All dimensions are nominal

Device	Package Type	Package Drawing	Pins	SPQ	Reel Diameter (mm)	Reel Width W1 (mm)	A0 (mm)	B0 (mm)	K0 (mm)	P1 (mm)	W (mm)	Pin1 Quadrant
LP2981-28DBVR	SOT-23	DBV	5	3000	178.0	9.0	3.23	3.17	1.37	4.0	8.0	Q3
LP2981-28DBVTG4	SOT-23	DBV	5	250	178.0	9.0	3.23	3.17	1.37	4.0	8.0	Q3
LP2981-30DBVR	SOT-23	DBV	5	3000	178.0	8.4	3.2	3.2	1.4	4.0	8.0	Q3
LP2981-33DBVR	SOT-23	DBV	5	3000	178.0	8.4	3.2	3.2	1.4	4.0	8.0	Q3
LP2981-50DBVR	SOT-23	DBV	5	3000	178.0	8.4	3.2	3.2	1.4	4.0	8.0	Q3
LP2981A-28DBVR	SOT-23	DBV	5	3000	178.0	9.0	3.23	3.17	1.37	4.0	8.0	Q3
LP2981A-30DBVR	SOT-23	DBV	5	3000	180.0	8.4	3.2	3.2	1.4	4.0	8.0	Q3
LP2981A-30DBVRG4	SOT-23	DBV	5	3000	178.0	9.0	3.3	3.2	1.4	4.0	8.0	Q3
LP2981A-30DBVTG4	SOT-23	DBV	5	250	178.0	9.0	3.23	3.17	1.37	4.0	8.0	Q3
LP2981A-33DBVR	SOT-23	DBV	5	3000	180.0	8.4	3.2	3.2	1.4	4.0	8.0	Q3
LP2981A-33DBVRG4	SOT-23	DBV	5	3000	178.0	9.0	3.3	3.2	1.4	4.0	8.0	Q3
LP2981A-33DBVTG4	SOT-23	DBV	5	250	178.0	9.0	3.23	3.17	1.37	4.0	8.0	Q3
LP2981A-50DBVR	SOT-23	DBV	5	3000	180.0	8.4	3.2	3.2	1.4	4.0	8.0	Q3

**TAPE AND REEL BOX DIMENSIONS**

\*All dimensions are nominal

Device	Package Type	Package Drawing	Pins	SPQ	Length (mm)	Width (mm)	Height (mm)
LP2981-28DBVR	SOT-23	DBV	5	3000	180.0	180.0	18.0
LP2981-28DBVTG4	SOT-23	DBV	5	250	180.0	180.0	18.0
LP2981-30DBVR	SOT-23	DBV	5	3000	208.0	191.0	35.0
LP2981-33DBVR	SOT-23	DBV	5	3000	208.0	191.0	35.0
LP2981-50DBVR	SOT-23	DBV	5	3000	208.0	191.0	35.0
LP2981A-28DBVR	SOT-23	DBV	5	3000	180.0	180.0	18.0
LP2981A-30DBVR	SOT-23	DBV	5	3000	210.0	185.0	35.0
LP2981A-30DBVRG4	SOT-23	DBV	5	3000	180.0	180.0	18.0
LP2981A-30DBVTG4	SOT-23	DBV	5	250	180.0	180.0	18.0
LP2981A-33DBVR	SOT-23	DBV	5	3000	210.0	185.0	35.0
LP2981A-33DBVRG4	SOT-23	DBV	5	3000	180.0	180.0	18.0
LP2981A-33DBVTG4	SOT-23	DBV	5	250	180.0	180.0	18.0
LP2981A-50DBVR	SOT-23	DBV	5	3000	210.0	185.0	35.0

# DBV0005A



## PACKAGE OUTLINE

SOT-23 - 1.45 mm max height

SMALL OUTLINE TRANSISTOR

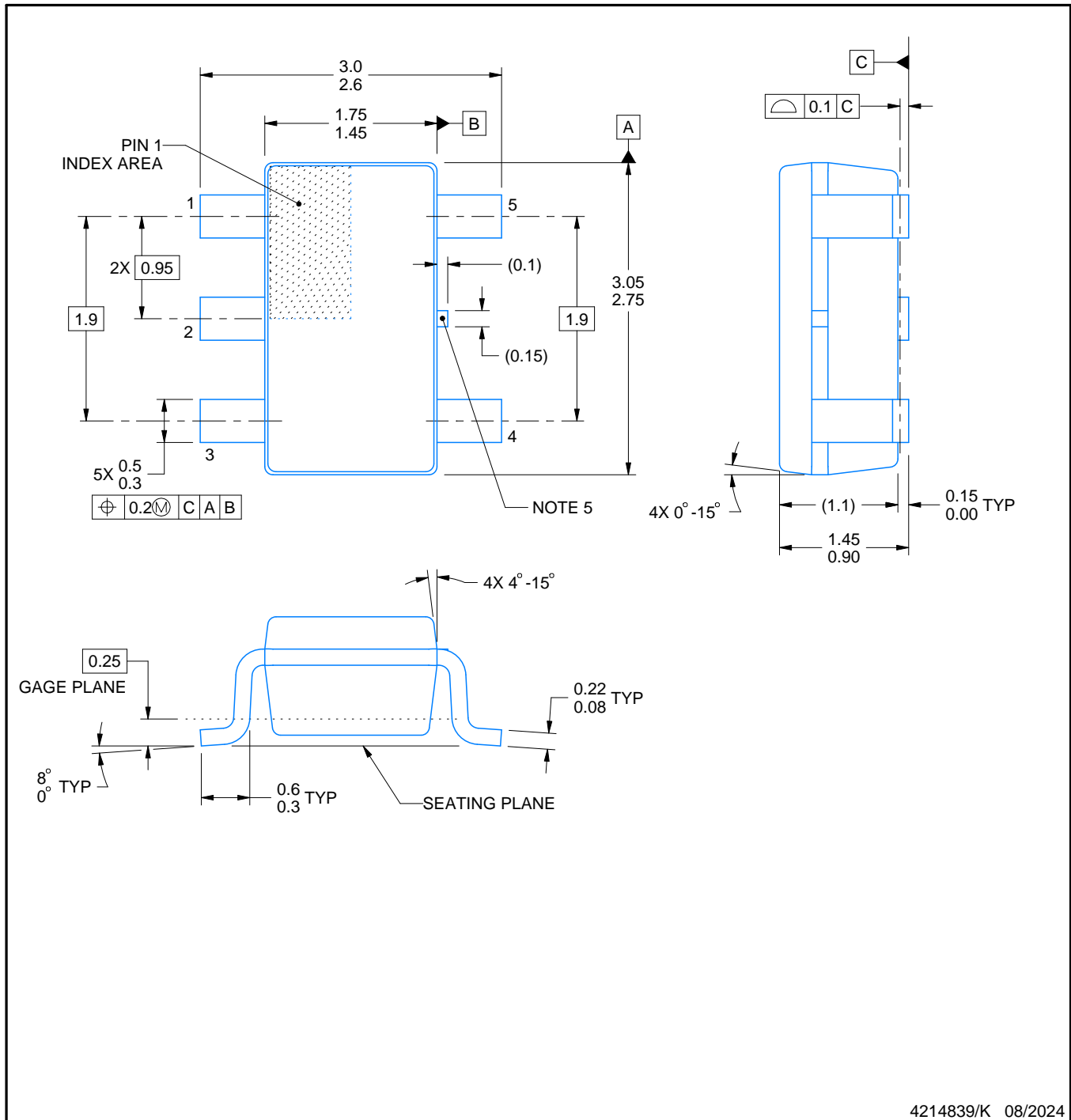

4214839/K 08/2024

### NOTES:

1. All linear dimensions are in millimeters. Any dimensions in parenthesis are for reference only. Dimensioning and tolerancing per ASME Y14.5M.
2. This drawing is subject to change without notice.
3. Reference JEDEC MO-178.
4. Body dimensions do not include mold flash, protrusions, or gate burrs. Mold flash, protrusions, or gate burrs shall not exceed 0.25 mm per side.
5. Support pin may differ or may not be present.

# EXAMPLE BOARD LAYOUT

DBV0005A

SOT-23 - 1.45 mm max height

SMALL OUTLINE TRANSISTOR



LAND PATTERN EXAMPLE  
EXPOSED METAL SHOWN  
SCALE:15X



SOLDER MASK DETAILS

4214839/K 08/2024

NOTES: (continued)

- 6. Publication IPC-7351 may have alternate designs.
- 7. Solder mask tolerances between and around signal pads can vary based on board fabrication site.



# EXAMPLE STENCIL DESIGN

DBV0005A

SOT-23 - 1.45 mm max height

SMALL OUTLINE TRANSISTOR



SOLDER PASTE EXAMPLE  
BASED ON 0.125 mm THICK STENCIL  
SCALE:15X

4214839/K 08/2024

NOTES: (continued)

8. Laser cutting apertures with trapezoidal walls and rounded corners may offer better paste release. IPC-7525 may have alternate design recommendations.
9. Board assembly site may have different recommendations for stencil design.

## IMPORTANT NOTICE AND DISCLAIMER

TI PROVIDES TECHNICAL AND RELIABILITY DATA (INCLUDING DATASHEETS), DESIGN RESOURCES (INCLUDING REFERENCE DESIGNS), APPLICATION OR OTHER DESIGN ADVICE, WEB TOOLS, SAFETY INFORMATION, AND OTHER RESOURCES "AS IS" AND WITH ALL FAULTS, AND DISCLAIMS ALL WARRANTIES, EXPRESS AND IMPLIED, INCLUDING WITHOUT LIMITATION ANY IMPLIED WARRANTIES OF MERCHANTABILITY, FITNESS FOR A PARTICULAR PURPOSE OR NON-INFRINGEMENT OF THIRD PARTY INTELLECTUAL PROPERTY RIGHTS.

These resources are intended for skilled developers designing with TI products. You are solely responsible for (1) selecting the appropriate TI products for your application, (2) designing, validating and testing your application, and (3) ensuring your application meets applicable standards, and any other safety, security, regulatory or other requirements.

These resources are subject to change without notice. TI grants you permission to use these resources only for development of an application that uses the TI products described in the resource. Other reproduction and display of these resources is prohibited. No license is granted to any other TI intellectual property right or to any third party intellectual property right. TI disclaims responsibility for, and you fully indemnify TI and its representatives against any claims, damages, costs, losses, and liabilities arising out of your use of these resources.

TI's products are provided subject to [TI's Terms of Sale](#), [TI's General Quality Guidelines](#), or other applicable terms available either on [ti.com](#) or provided in conjunction with such TI products. TI's provision of these resources does not expand or otherwise alter TI's applicable warranties or warranty disclaimers for TI products. Unless TI explicitly designates a product as custom or customer-specified, TI products are standard, catalog, general purpose devices.

TI objects to and rejects any additional or different terms you may propose.

Copyright © 2025, Texas Instruments Incorporated

Last updated 10/2025