

OPA2810 Dual-Channel, 27-V, Rail-to-Rail Input/Output FET-Input Operational Amplifier

1 Features

- Gain-bandwidth product: 70 MHz
- Small-signal bandwidth: 105 MHz
- Slew rate: 192 V/ μ s
- Wide supply range: 4.75 V to 27 V
- Low noise:
 - Input voltage noise: 6 nV/ $\sqrt{\text{Hz}}$ (f = 500 kHz)
 - Input current noise: 5 fA/ $\sqrt{\text{Hz}}$ (f = 10 kHz)
- Rail-to-rail input and output:
 - FET input stage: 2-pA input bias current (typical)
 - High linear output current: 75 mA
- Input offset: ± 1.5 mV (maximum)
- Offset drift: ± 2 μ V/ $^{\circ}$ C (typical)
- Low power: 3.6 mA/channel
- Extended temperature operation: -40° C to $+125^{\circ}$ C
- Single-channel version: [OPA810](#)

2 Applications

- Wideband photodiode transimpedance amplifiers
- High-Z front-ends
- Impedance measurements
- Power analyzers
- Multichannel sensor interface
- Level shifting and buffering
- Optoelectronic drivers

3 Description

The OPA2810 is a dual-channel, FET-input, voltage-feedback operational amplifier with low input bias current. The OPA2810 is unity-gain stable with a small-signal unity-gain bandwidth of 105 MHz, and offers excellent DC precision and dynamic AC performance at a low quiescent current (I_Q) of 3.6 mA per channel (typical). The OPA2810 is fabricated on Texas Instrument's proprietary, high-speed SiGe BiCMOS process and achieves significant performance improvements over comparable FET-input amplifiers at similar levels of quiescent power. With a gain-bandwidth product (GBWP) of 70 MHz, slew-rate of 192 V/ μ s, and voltage low noise of 6 nV/ $\sqrt{\text{Hz}}$, the OPA2810 is well suited for use in a wide range of high fidelity data acquisition and signal processing applications.

The OPA2810 is characterized to operate over a wide supply range of 4.75 V to 27 V, and features rail-to-rail inputs and outputs. The OPA2810 amplifier delivers 75 mA of linear output current, suitable for driving optoelectronics components and analog-to-digital converter (ADC) inputs or buffering DAC outputs into heavy loads.

The OPA2810 is available in 8-pin SOIC, SOT23, and VSSOP packages and is rated to work over the extended industrial temperature range of -40° C to $+125^{\circ}$ C. The [OPA810](#) is a single-channel variant of this device, available in 8-pin SOIC and 5-pin SOT-23 and SC70 packages.

Device Information⁽¹⁾

PART NUMBER	PACKAGE	BODY SIZE (NOM)
OPA2810	SOIC (8)	4.90 mm x 3.91 mm
	SOT-23 (8)	2.90 mm x 1.60 mm
	VSSOP (8)	3.00 mm x 3.00 mm

(1) For all available packages, see the orderable addendum at the end of the data sheet.

Multichannel Sensor Interface

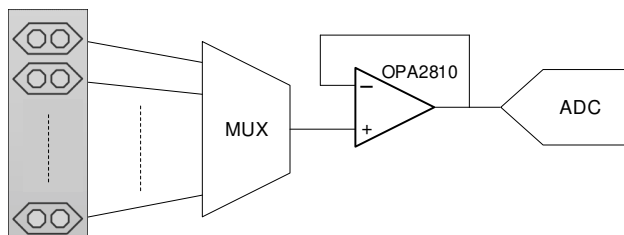

Harmonic Distortion vs Frequency

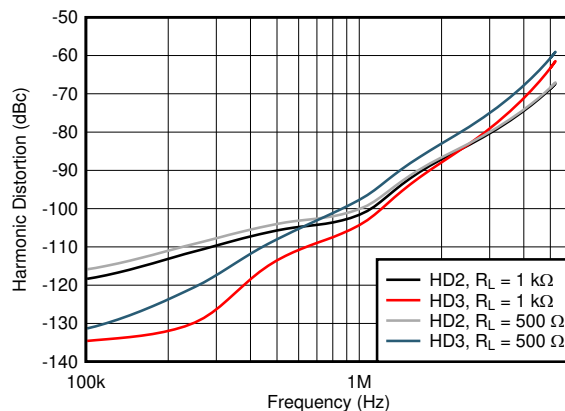

D048



Table of Contents

1	Features	1	8.1	Overview	25
2	Applications	1	8.2	Functional Block Diagram	25
3	Description	1	8.3	Feature Description	26
4	Revision History	2	8.4	Device Functional Modes	27
5	Device Comparison Table	3	9	Application and Implementation	28
6	Pin Configuration and Functions	3	9.1	Application Information	28
7	Specifications	4	9.2	Typical Applications	33
7.1	Absolute Maximum Ratings	4	10	Power Supply Recommendations	36
7.2	ESD Ratings	4	11	Layout	36
7.3	Recommended Operating Conditions	4	11.1	Layout Guidelines	36
7.4	Thermal Information	4	11.2	Layout Example	38
7.5	Electrical Characteristics: 10 V	5	12	Device and Documentation Support	39
7.6	Electrical Characteristics: 24 V	8	12.1	Documentation Support	39
7.7	Electrical Characteristics: 5 V	11	12.2	Receiving Notification of Documentation Updates	39
7.8	Typical Characteristics: $V_S = 10\text{ V}$	14	12.3	Community Resources	39
7.9	Typical Characteristics: $V_S = 24\text{ V}$	17	12.4	Trademarks	39
7.10	Typical Characteristics: $V_S = 5\text{ V}$	20	12.5	Electrostatic Discharge Caution	39
7.11	Typical Characteristics: $\pm 2.375\text{ V}$ to $\pm 12\text{ V}$ Split Supply	22	12.6	Glossary	39
8	Detailed Description	25	13	Mechanical, Packaging, and Orderable Information	39

4 Revision History

Changes from Revision B (December 2018) to Revision C	Page
• Added OPA810 single-channel version information to front page	1
• Added OPA810 to <i>Device Comparison Table</i>	3
• Changed <i>Functional Block Diagram</i> and <i>Feature Description</i> sections to meet format requirements	25

Changes from Revision A (June 2018) to Revision B	Page
• Added D (SOIC) package to document	1
• Changed value of minimum linear output drive at $T_A = -40^\circ\text{C}$ to 125°C in 10 V, 24 V and 5 V Electrical Characteristics tables	6
• Changed test condition for linear output drive at $T_A = -40^\circ\text{C}$ to $+125^\circ\text{C}$ in 10 V, 24 V and 5 V Electrical Characteristics tables	6
• Deleted specification for minimum output short-circuit current in 10 V, 24 V and 5 V Electrical Characteristics tables	6
• Deleted ' \pm ' sign from the test condition for PSRR at 25°C in 10 V, 24 V and 5 V Electrical Characteristics tables	7
• Changed footnote for PSRR in 10 V, 24 V and 5 V Electrical Characteristics tables	7
• Added $V_{CM} = 0.5\text{ V}$ to the test condition for PSRR at 25°C in 5 V Electrical Characteristics table	12
• Changed changed test condition for open-loop voltage gain in auxiliary CMOS input stage section in 5 V Electrical Characteristics table	13

Changes from Original (August 2017) to Revision A	Page
• Changed device status from Advance Information to Production Data	1

5 Device Comparison Table

DEVICE	$V_{S\pm}$ (V)	I_Q / Channel (mA)	GBWP (MHz)	SLEW RATE ($V/\mu s$)	VOLTAGE NOISE (nV/\sqrt{Hz})	AMPLIFIER DESCRIPTION
OPA2810	± 12	3.6	70	192	6	Unity-gain stable FET input (dual-ch)
OPA810	± 12	3.7	70	200	6.3	Unity-gain stable FET input (single-ch)
THS4631	± 15	13	210	900	7	Unity-gain stable FET input
OPA656	± 6	14	230	290	7	Unity-gain stable FET input
OPA657	± 6	14	1600	700	4.8	Gain of 7 stable FET input
OPA659	± 6	32	350	2550	8.9	Unity-gain stable FET input

6 Pin Configuration and Functions

**D, DCN, and DGK Packages
8-Pin SOIC, SOT-23, and VSSOP
Top View**

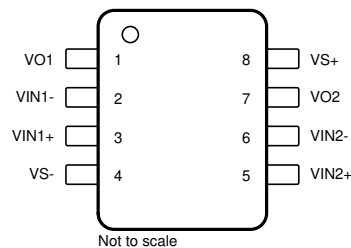

Pin Functions

PIN		TYPE ⁽¹⁾	DESCRIPTION
NAME	NO.		
VO1	1	O	Amplifier 1 output pin
VIN1-	2	I	Amplifier 1 inverting input pin
VIN1+	3	I	Amplifier 1 noninverting input pin
VS-	4	P	Negative power supply pin
VIN2+	5	I	Amplifier 2 noninverting input pin
VIN2-	6	I	Amplifier 2 inverting input pin
VO2	7	O	Amplifier 2 output pin
VS+	8	P	Positive power supply pin

(1) I = input, O = output, and P = power.

7 Specifications

7.1 Absolute Maximum Ratings

over operating free-air temperature range (unless otherwise noted)⁽¹⁾

		MIN	MAX	UNIT
V _S	Supply voltage (total bipolar supplies) ⁽²⁾		±14	V
V _{IN}	Input voltage	V _{S-} – 0.5	V _{S+} + 0.5	V
V _{IN,Diff}	Differential input voltage ⁽³⁾		±7	V
I _I	Continuous input current		±10	mA
I _O	Continuous output current ⁽⁴⁾	T _A = –40°C to +85°C	±40	mA
		T _A = 125°C	±12	mA
P _D	Continuous power dissipation	See Thermal Information		
T _J	Junction temperature		150	°C
T _{stg}	Storage temperature	–65	125	°C

- (1) Stresses beyond those listed under *Absolute Maximum Ratings* may cause permanent damage to the device. These are stress ratings only, which do not imply functional operation of the device at these or any other conditions beyond those indicated under *Recommended Operating Conditions*. Exposure to absolute-maximum-rated conditions for extended periods may affect device reliability.
- (2) V_S is the total supply voltage given by V_S = V_{S+} – V_{S-}.
- (3) Equal to the lower of ±7 V or total supply voltage.
- (4) Long-term continuous output current for electromigration limits.

7.2 ESD Ratings

			VALUE	UNIT
V _(ESD)	Electrostatic discharge	Human-body model (HBM), per ANSI/ESDA/JEDEC JS-001 ⁽¹⁾	±2500	V
		Charged-device model (CDM), per JEDEC specification JESD22-C101 ⁽²⁾	±1500	

- (1) JEDEC document JEP155 states that 500-V HBM allows safe manufacturing with a standard ESD control process.
- (2) JEDEC document JEP157 states that 250-V CDM allows safe manufacturing with a standard ESD control process.

7.3 Recommended Operating Conditions

over operating free-air temperature range (unless otherwise noted)

		MIN	NOM	MAX	UNIT
V _S	Total supply voltage	4.75		27	V
T _A	Ambient temperature	–40	25	125	°C

7.4 Thermal Information

THERMAL METRIC ⁽¹⁾		OPA2810			UNIT
		D (SOIC)	DCN (SOT-23)	DGK (VSSOP)	
		8 PINS	8 PINS	8 PINS	
R _{θJA}	Junction-to-ambient thermal resistance	123.9	130.9	177.2	°C/W
R _{θJC(top)}	Junction-to-case (top) thermal resistance	56.3	86.6	64.6	°C/W
R _{θJB}	Junction-to-board thermal resistance	69.4	42.3	99.0	°C/W
ψ _{JT}	Junction-to-top characterization parameter	13.5	25.9	9.7	°C/W
ψ _{JB}	Junction-to-board characterization parameter	68.1	42.3	97.3	°C/W
R _{θJC(bot)}	Junction-to-case (bottom) thermal resistance	—	—	—	°C/W

- (1) For more information about traditional and new thermal metrics, see the [Semiconductor and IC Package Thermal Metrics](#) application report.

7.5 Electrical Characteristics: 10 V

Test conditions unless otherwise noted: $T_A = 25^\circ\text{C}$, $V_{S+} = 5\text{ V}$, $V_{S-} = -5\text{ V}$, $R_L = 1\text{ k}\Omega$, input and output are biased to midsupply⁽¹⁾.

PARAMETER		TEST CONDITIONS	MIN	TYP	MAX	UNIT	Test Level ⁽²⁾
AC PERFORMANCE							
SSBW	Small-signal bandwidth	$G = 1$, $V_o = 20\text{ mV}_{PP}$, $R_F = 0\ \Omega$		75		MHz	C
		$G = 1$, $V_o = 20\text{ mV}_{PP}$, $R_F = 0\ \Omega$, $C_L = 33\text{ pF}$		105		MHz	C
		$G = -1$, $V_o = 20\text{ mV}_{PP}$		50		MHz	C
		$G = 2$, $V_o = 20\text{ mV}_{PP}$		49		MHz	C
		$G = 5$, $V_o = 20\text{ mV}_{PP}$		15		MHz	C
LSBW	Large-signal bandwidth	$G = 2$, $V_o = 2\text{ V}_{PP}$		38		MHz	C
		$G = 2$, $V_o = 4\text{ V}_{PP}$		26		MHz	C
GBWP	Gain-bandwidth product	$G = 11$, $V_o = 20\text{ mV}_{PP}$		70		MHz	C
	Bandwidth for 0.1dB flatness	$G = 2$, $V_o = 20\text{ mV}_{PP}$		13		MHz	C
SR	Slew rate (20%-80%) ⁽³⁾	$G = 2$, $V_o = -2\text{-V to } 2\text{-V step}$		192		V/ μs	C
		$G = -1$, $V_o = -2\text{-V to } 2\text{-V step}$		187		V/ μs	C
		$G = 2$, $V_o = -4.5\text{-V to } 3.5\text{-V step}$		193		V/ μs	C
	Rise time	$V_o = 200\text{-mV step}$		4		ns	C
	Fall time	$V_o = 200\text{-mV step}$		5		ns	C
	Settling time to 0.1%	$G = 2$, $V_o = 2\text{-V step}$		73		ns	C
		$G = 2$, $V_o = 8\text{-V step}$		97		ns	C
		$G = -1$, $V_o = 8\text{-V step}$		96		ns	C
	Settling time to 0.001%	$G = 2$, $V_o = 2\text{-V step}$		374		ns	C
		$G = 2$, $V_o = 8\text{-V step}$		213		ns	C
		$G = -1$, $V_o = 8\text{-V step}$		163		ns	C
	Overshoot/undershoot	$G = +1$, $R_F = 0\ \Omega$, $V_o = 200\text{ mV}_{PP}$		9/10		%	C
		$G = +1$, $R_F = 0\ \Omega$, $V_o = 2\text{ V}_{PP}$		4/5		%	C
	Input overdrive recovery	$G = 1$, $R_F = 0\ \Omega$, ($V_{S-} - 0.5\text{ V}$) to ($V_{S+} + 0.5\text{ V}$) input (see Figure 14)		44		ns	C
	Output overdrive recovery	$G = -1$, ($V_{S-} - 0.5\text{ V}$) to ($V_{S+} + 0.5\text{ V}$) input (see Figure 15)		55		ns	C
HD2	Second-order harmonic distortion	$f = 100\text{ kHz}$, $R_L = 1\text{ k}\Omega$, $V_o = 2\text{ V}_{PP}$		-118		dBc	C
		$f = 100\text{ kHz}$, $R_L = 1\text{ k}\Omega$, $V_o = 8\text{ V}_{PP}$		-101		dBc	C
		$f = 1\text{ MHz}$, $R_L = 1\text{ k}\Omega$, $V_o = 2\text{ V}_{PP}$		-99		dBc	C
		$f = 1\text{ MHz}$, $R_L = 1\text{ k}\Omega$, $V_o = 8\text{ V}_{PP}$		-82		dBc	C
HD3	Third-order harmonic distortion	$f = 100\text{ kHz}$, $R_L = 1\text{ k}\Omega$, $V_o = 2\text{ V}_{PP}$		-134		dBc	C
		$f = 100\text{ kHz}$, $R_L = 1\text{ k}\Omega$, $V_o = 8\text{ V}_{PP}$		-105		dBc	C
		$f = 1\text{ MHz}$, $R_L = 1\text{ k}\Omega$, $V_o = 2\text{ V}_{PP}$		-104		dBc	C
		$f = 1\text{ MHz}$, $R_L = 1\text{ k}\Omega$, $V_o = 8\text{ V}_{PP}$		-92		dBc	C
e_n	Input-referred voltage noise	$f = 500\text{ kHz}$, flatband		6		nV/ $\sqrt{\text{Hz}}$	C
		$f = 0.1\text{-}10\text{ Hz}$ integrated		0.42		μV_{rms}	C
e_i	Input-referred current noise	$f = 10\text{ kHz}$		5		fA/ $\sqrt{\text{Hz}}$	C
z_O	Close-loop output impedance	$f = 100\text{ kHz}$		0.007		Ω	C

(1) For AC specifications, $G = 2\text{ V/V}$, $R_F = 1\text{ k}\Omega$ and $C_L = 4.7\text{ pF}$ (unless otherwise noted).

(2) Test levels (all values set by characterization and simulation): (A) 100% tested at 25°C , overtemperature limits by characterization and simulation; (B) Not tested in production, limits set by characterization and simulation; (C) Typical value only for information.

(3) Lower of the measured positive and negative slew rate.

Electrical Characteristics: 10 V (continued)

 Test conditions unless otherwise noted: $T_A = 25^\circ\text{C}$, $V_{S+} = 5\text{ V}$, $V_{S-} = -5\text{ V}$, $R_L = 1\text{ k}\Omega$, input and output are biased to midsupply⁽¹⁾.

PARAMETER		TEST CONDITIONS	MIN	TYP	MAX	UNIT	Test Level ⁽²⁾
DC PERFORMANCE							
A_{OL}	Open-loop voltage gain	$f = \text{DC}$, $V_O = \pm 2.5\text{ V}$	108	120		dB	A
		$T_A = -40^\circ\text{C}$ to $+125^\circ\text{C}$	108				B
V_{OS}	Input offset voltage	$T_A = 25^\circ\text{C}$		0.1	1.5	mV	A
		$T_A = -40^\circ\text{C}$ to $+85^\circ\text{C}$			2.4	mV	B
		$T_A = -40^\circ\text{C}$ to $+125^\circ\text{C}$			2.8	mV	B
	Input offset voltage drift	$T = 25^\circ\text{C}$		1.5		$\mu\text{V}/^\circ\text{C}$	B
		$T_A = -40^\circ\text{C}$ to $+125^\circ\text{C}$			13	$\mu\text{V}/^\circ\text{C}$	B
	Input bias current	$T_A = 25^\circ\text{C}$		2	20	pA	A
		$T_A = -40^\circ\text{C}$ to $+85^\circ\text{C}$ ⁽⁴⁾		20	60	pA	B
		$T_A = -40^\circ\text{C}$ to $+125^\circ\text{C}$ ⁽⁴⁾		100	350	pA	B
	Input offset current	$T_A = 25^\circ\text{C}$		1	20	pA	A
		$T_A = -40^\circ\text{C}$ to $+85^\circ\text{C}$		5		pA	B
		$T_A = -40^\circ\text{C}$ to $+125^\circ\text{C}$		50		pA	B
CMRR	Common-mode rejection ratio	$f = \text{DC}$, $T_A = 25^\circ\text{C}$, $V_{CM} = -3\text{ V}$ to $+1\text{ V}$	85	100		dB	A
		$T_A = -40^\circ\text{C}$ to $+125^\circ\text{C}$	85			dB	B
INPUT							
	Allowable input differential voltage	See Figure 57		± 7		V	C
	Common-mode input impedance	In closed-loop configuration		$12 \parallel 2.5$		$\text{G}\Omega \parallel \text{pF}$	C
	Differential input capacitance	In open-loop configuration		0.5		pF	C
	Most positive input voltage	$\Delta V_{OS} < 5\text{ mV}$ ⁽⁵⁾	$V_{S+} + 0.2$	$V_{S+} + 0.3$		V	A
		$T_A = -40^\circ\text{C}$ to $+125^\circ\text{C}$	$V_{S+} + 0.2$			V	B
	Most negative input voltage	$\Delta V_{OS} < 5\text{ mV}$ ⁽⁵⁾	$V_{S-} - 0.2$	$V_{S-} - 0.3$		V	A
		$T_A = -40^\circ\text{C}$ to $+125^\circ\text{C}$	$V_{S-} - 0.2$			V	B
	Most positive input voltage for main-JFET stage	$T = 25^\circ\text{C}$ (see Figure 18)	$V_{S+} - 2.9$	$V_{S+} - 2.5$		V	C
		$T_A = -40^\circ\text{C}$ to $+125^\circ\text{C}$	$V_{S+} - 3$			V	C
OUTPUT							
V_{OCRH}	Output voltage range high	$T_A = 25^\circ\text{C}$, $R_L = 667\ \Omega$	$V_{S+} - 0.18$	$V_{S+} - 0.11$		V	A
		$T_A = -40^\circ\text{C}$ to $+125^\circ\text{C}$, $R_L = 667\ \Omega$	$V_{S+} - 0.2$			V	B
V_{OCRL}	Output voltage range low	$T_A = 25^\circ\text{C}$, $R_L = 667\ \Omega$	$V_{S-} + 0.15$	$V_{S-} + 0.08$		V	A
		$T_A = -40^\circ\text{C}$ to $+125^\circ\text{C}$, $R_L = 667\ \Omega$	$V_{S-} + 0.2$			V	B
$I_{O(\text{max})}$	Linear output drive (sourcing and sinking)	$T_A = 25^\circ\text{C}$, $V_O = 2.65\text{ V}$, $R_L = 51\ \Omega$, $V_{OS} < 2\text{ mV}$	52	75		mA	A
		$T_A = -40^\circ\text{C}$ to $+125^\circ\text{C}$, $V_O = 1.4\text{ V}$, $V_{OS} < 2\text{ mV}$	28			mA	B
I_{SC}	Output short-circuit current	$T_A = 25^\circ\text{C}$, $T_{\text{Delay}} = 5\text{ ms}$		100		mA	B
C_L	Capacitive load drive	$< 1\text{ dB}$ peaking, $R_S = 0\ \Omega$		35		pF	C

(4) Maximum bias current specification is set using $\pm 5\sigma$ limits (corresponding to 0.58 DPPM) obtained using the statistical distribution from electrical characterization over temperature of a sample set of 70 units. Maximum specification is not specified by final automated test equipment (ATE) nor by QA sample testing.

(5) Change in input offset from its value when input is biased to midsupply.

Electrical Characteristics: 10 V (continued)

Test conditions unless otherwise noted: $T_A = 25^\circ\text{C}$, $V_{S+} = 5\text{ V}$, $V_{S-} = -5\text{ V}$, $R_L = 1\text{ k}\Omega$, input and output are biased to midsupply⁽¹⁾.

PARAMETER		TEST CONDITIONS	MIN	TYP	MAX	UNIT	Test Level ⁽²⁾
POWER SUPPLY							
V_S	Operating voltage	$T_A = 25^\circ\text{C}$	4.75		27	V	A
		$T_A = -40^\circ\text{C}$ to $+125^\circ\text{C}$	4.75		27	V	B
I_Q	Quiescent current per channel	$T_A = 25^\circ\text{C}$	3.125	3.6	4.05	mA	A
		$T_A = -40^\circ\text{C}$ to $+125^\circ\text{C}$	2.9		4.4	mA	B
PSRR	Power supply rejection ratio	$\Delta V_S = 2\text{ V}^{(6)}$	82	100		dB	A
		$T_A = -40^\circ\text{C}$ to $+125^\circ\text{C}$	82			dB	B
AUXILIARY CMOS INPUT STAGE							
	Gain-bandwidth product	$V_{CM} = (V_{S+}) - 1\text{ V}$		35		MHz	C
	Open-loop voltage gain	$V_{CM} = (V_{S+}) - 1\text{ V}$, $f = \text{DC}$, $V_o = 2\text{ V}$ to 4 V	80	100		dB	A
	Input-referred voltage noise	$V_{CM} = V_{S+} - 1\text{ V}$, $f = 1\text{ MHz}$		21		nV/ $\sqrt{\text{Hz}}$	C
	Input offset voltage	$V_{CM} = V_{S+} - 1.5\text{ V}$, no-load			4	mV	A
		$V_{CM} = V_{S+} - 0.5\text{ V}$, no-load			4.8	mV	A
		$V_{CM} = V_{S+} - 0.5\text{ V}$, $T_A = -40^\circ\text{C}$ to $+125^\circ\text{C}$, no-load			6.4	mV	B
	Input bias current	$V_{CM} = V_{S+} - 1.5\text{ V}$		2	20	pA	A
		$V_{CM} = V_{S+} - 1.5\text{ V}$, $T_A = -40^\circ\text{C}$ to $+125^\circ\text{C}$		0.15	0.5	nA	B
	Common-mode rejection ratio	$V_{CM} = V_{S+} - 1.5\text{ V}$ to $V_{S+} - 0.5\text{ V}$		75		dB	B
	Power supply rejection ratio	$V_{CM} = V_{S+} - 1.5\text{ V}$, $\Delta V_S = \pm 2\text{ V}^{(6)}$		75		dB	B
CHANNEL MATCHING							
	Channel-to-channel GBWP mismatch	$T_A = 25^\circ\text{C}$		3		%	C
	Channel-to-channel crosstalk	$f = 100\text{ kHz}$		-93		dBc	C
	Input offset voltage mismatch	$T_A = 25^\circ\text{C}$		0.1	2.5	mV	A

(6) The supply voltages are $V_{S+} = 5\text{ V} \pm 1\text{ V}$ and $V_{S-} = -5\text{ V}$ for +PSRR, and $V_{S+} = 5\text{ V}$ and $V_{S-} = -5\text{ V} \pm 1\text{ V}$ for -PSRR.

7.6 Electrical Characteristics: 24 V

Test conditions unless otherwise noted: $T_A = 25^\circ\text{C}$, $V_{S+} = 12\text{ V}$, $V_{S-} = -12\text{ V}$, $R_L = 1\text{ k}\Omega$, input and output are biased to midsupply⁽¹⁾.

PARAMETER		TEST CONDITIONS	MIN	TYP	MAX	UNIT	Test Level ⁽²⁾
AC PERFORMANCE							
SSBW	Small-signal bandwidth	$G = 1, V_o = 20\text{ mV}_{PP}, R_F = 0\ \Omega$		75		MHz	C
		$G = 1, V_o = 20\text{ mV}_{PP}, R_F = 0\ \Omega, C_L = 33\text{ pF}$		105		MHz	C
		$G = -1, V_o = 20\text{ mV}_{PP}$		51		MHz	C
		$G = 2, V_o = 20\text{ mV}_{PP}$		49		MHz	C
		$G = 5, V_o = 20\text{ mV}_{PP}$		15		MHz	C
LSBW	Large-signal bandwidth	$G = 2, V_o = 2\text{ V}_{PP}$		38		MHz	C
		$G = 2, V_o = 10\text{ V}_{PP}$		14		MHz	C
GBWP	Gain-bandwidth product	$G = 11, V_o = 20\text{ mV}_{PP}$		70		MHz	C
	Bandwidth for 0.1dB flatness	$G = 2, V_o = 20\text{ mV}_{PP}$		12		MHz	C
SR	Slew rate (20%-80%) ⁽³⁾	$G = 2, V_o = -2\text{-V to } 2\text{-V step}$		226		V/ μs	C
		$G = -1, V_o = -2\text{-V to } 2\text{-V step}$		218		V/ μs	C
		$G = 2, V_o = -4.5\text{-V to } 3.5\text{-V step}$		243		V/ μs	C
	Rise time	$V_o = 200\text{-mV step}$		4		ns	C
	Fall time	$V_o = 200\text{-mV step}$		5		ns	C
	Settling time to 0.1%	$G = 2, V_o = 2\text{-V step}$		72		ns	C
		$G = 2, V_o = 10\text{-V step}$		90		ns	C
		$G = -1, V_o = 10\text{-V step}$		89		ns	C
	Settling time to 0.001%	$G = 2, V_o = 2\text{-V step}$		370		ns	C
		$G = 2, V_o = 10\text{-V step}$		210		ns	C
		$G = -1, V_o = 10\text{-V step}$		150		ns	C
	Overshoot/undershoot	$G = 1, R_F = 0\ \Omega, V_o = 200\text{ mV}_{PP}$		7.5/9		%	C
		$G = 1, R_F = 0\ \Omega, V_o = 2\text{ V}_{PP}$		4/5		%	C
	Input overdrive recovery	$G = 1, R_F = 0\ \Omega, (V_{S-} - 0.5\text{ V})$ to $(V_{S+} + 0.5\text{ V})$ input (see Figure 31)		66		ns	C
	Output overdrive recovery	$G = -1, (V_{S-} - 0.5\text{ V})$ to $(V_{S+} + 0.5\text{ V})$ input (see Figure 32)		30		ns	C
HD2	Second-order harmonic distortion	$f = 100\text{ kHz}, R_L = 1\text{ k}\Omega, V_o = 2\text{ V}_{PP}$		-123		dBc	C
		$f = 100\text{ kHz}, R_L = 1\text{ k}\Omega, V_o = 10\text{ V}_{PP}$		-113		dBc	C
		$f = 1\text{ MHz}, R_L = 1\text{ k}\Omega, V_o = 2\text{ V}_{PP}$		-105		dBc	C
		$f = 1\text{ MHz}, R_L = 1\text{ k}\Omega, V_o = 10\text{ V}_{PP}$		-92		dBc	C
HD3	Third-order harmonic distortion	$f = 100\text{ kHz}, R_L = 1\text{ k}\Omega, V_o = 2\text{ V}_{PP}$		-134		dBc	C
		$f = 100\text{ kHz}, R_L = 1\text{ k}\Omega, V_o = 10\text{ V}_{PP}$		-130		dBc	C
		$f = 1\text{ MHz}, R_L = 1\text{ k}\Omega, V_o = 2\text{ V}_{PP}$		-103		dBc	C
		$f = 1\text{ MHz}, R_L = 1\text{ k}\Omega, V_o = 10\text{ V}_{PP}$		-86		dBc	C
e_n	Input-referred voltage noise	$f = 500\text{ kHz}, \text{flatband}$		6		nV/ $\sqrt{\text{Hz}}$	C
		$f = 0.1\text{-}10\text{ Hz integrated}$		0.36		μV_{rms}	C
e_i	Input-referred current noise	$f = 10\text{ kHz}$		5		fA/ $\sqrt{\text{Hz}}$	C
z_o	Close-loop output impedance	$f = 100\text{ kHz}$		0.007		Ω	C

(1) For AC specifications, $G = 2\text{ V/V}$, $R_F = 1\text{ k}\Omega$ and $C_L = 4.7\text{ pF}$ (unless otherwise noted).

(2) Test levels (all values set by characterization and simulation): (A) 100% tested at 25°C , overtemperature limits by characterization and simulation; (B) Not tested in production, limits set by characterization and simulation; (C) Typical value only for information.

(3) Lower of the measured positive and negative slew rate.

Electrical Characteristics: 24 V (continued)

Test conditions unless otherwise noted: $T_A = 25^\circ\text{C}$, $V_{S+} = 12\text{ V}$, $V_{S-} = -12\text{ V}$, $R_L = 1\text{ k}\Omega$, input and output are biased to midsupply⁽¹⁾.

PARAMETER		TEST CONDITIONS	MIN	TYP	MAX	UNIT	Test Level ⁽²⁾
DC PERFORMANCE							
A_{OL}	Open-loop voltage gain	$f = \text{DC}$, $V_o = \pm 8\text{ V}$	108	120		dB	A
		$T_A = -40^\circ\text{C}$ to $+125^\circ\text{C}$	108			dB	B
V_{OS}	Input offset voltage	$T_A = 25^\circ\text{C}$		0.1	1.5	mV	A
		$T_A = -40^\circ\text{C}$ to $+85^\circ\text{C}$			2.4	mV	B
		$T_A = -40^\circ\text{C}$ to $+125^\circ\text{C}$			2.8	mV	B
	Input offset voltage drift	$T_A = 25^\circ\text{C}$		1.5		$\mu\text{V}/^\circ\text{C}$	B
		$T_A = -40^\circ\text{C}$ to $+125^\circ\text{C}$			13	$\mu\text{V}/^\circ\text{C}$	B
	Input bias current	$T_A = 25^\circ\text{C}$		2	20	pA	A
		$T_A = -40^\circ\text{C}$ to $+85^\circ\text{C}$ ⁽⁴⁾		20	60	pA	B
		$T_A = -40^\circ\text{C}$ to $+125^\circ\text{C}$ ⁽⁴⁾		100	460	pA	B
	Input offset current	$T_A = 25^\circ\text{C}$		1	20	pA	A
		$T_A = -40^\circ\text{C}$ to $+85^\circ\text{C}$		5		pA	B
		$T_A = -40^\circ\text{C}$ to $+125^\circ\text{C}$		50		pA	B
CMRR	Common-mode rejection ratio	$f = \text{DC}$, $T_A = 25^\circ\text{C}$, $V_{CM} = \pm 5\text{ V}$	90	105		dB	A
		$T_A = -40^\circ\text{C}$ to $+125^\circ\text{C}$	90			dB	B
INPUT							
	Allowable input differential voltage	see Figure 57		± 7		V	C
	Common-mode input impedance	In closed-loop configuration		$12 \parallel 2.5$		$\text{G}\Omega \parallel \text{pF}$	C
	Differential input capacitance	In open-loop configuration		0.5		pF	C
	Most positive input voltage	$\Delta V_{OS} < 5\text{ mV}$ ⁽⁵⁾	$V_{S+} + 0.2$	$V_{S+} + 0.3$		V	A
		$T_A = -40^\circ\text{C}$ to $+125^\circ\text{C}$	$V_{S+} + 0.1$			V	B
	Most negative input voltage	$\Delta V_{OS} < 5\text{ mV}$ ⁽⁵⁾	$V_{S-} - 0.2$	$V_{S-} - 0.3$		V	A
		$T_A = -40^\circ\text{C}$ to $+125^\circ\text{C}$	$V_{S-} - 0.2$			V	B
	Most positive input voltage for main-JFET stage	$T_A = 25^\circ\text{C}$ (see Figure 35)	$V_{S+} - 2.9$	$V_{S+} - 2.5$		V	C
		$T_A = -40^\circ\text{C}$ to $+125^\circ\text{C}$	$V_{S+} - 3$			V	C
OUTPUT							
V_{OCRH}	Output voltage range high	$T_A = 25^\circ\text{C}$, $R_L = 667\ \Omega$	$V_{S+} - 0.33$	$V_{S+} - 0.22$		V	A
		$T_A = -40^\circ\text{C}$ to $+125^\circ\text{C}$, $R_L = 667\ \Omega$	$V_{S+} - 0.36$			V	B
V_{OCRL}	Output voltage range low	$T_A = 25^\circ\text{C}$, $R_L = 667\ \Omega$	$V_{S-} + 0.23$	$V_{S-} + 0.15$		V	A
		$T_A = -40^\circ\text{C}$ to $+125^\circ\text{C}$, $R_L = 667\ \Omega$	$V_{S-} + 0.33$			V	B
$I_{O(\text{max})}$	Linear output drive (sourcing and sinking)	$T_A = 25^\circ\text{C}$, $V_o = 7.25\text{ V}$, $R_L = 151\ \Omega$, $V_{OS} < 2\text{ mV}$	48	64		mA	A
		$T_A = -40^\circ\text{C}$ to $+90^\circ\text{C}$, $V_o = 4.35\text{ V}$, $V_{OS} < 2\text{ mV}$	29			mA	B
I_{SC}	Output short-circuit current	$T_A = 25^\circ\text{C}$, $T_{\text{Delay}} = 5\text{ ms}$		108		mA	B
C_L	Capacitive load drive	$< 1\text{ dB}$ peaking, $R_S = 0\ \Omega$		35		pF	C

(4) Maximum bias current specification is set using $\pm 5\sigma$ limits (corresponding to 0.58 DPPM) obtained using the statistical distribution from electrical characterization over temperature of a sample set of 70 units. Maximum specification is not specified by final automated test equipment (ATE) nor by QA sample testing.

(5) Change in input offset from its value when input is biased to midsupply.

Electrical Characteristics: 24 V (continued)

Test conditions unless otherwise noted: $T_A = 25^\circ\text{C}$, $V_{S+} = 12\text{ V}$, $V_{S-} = -12\text{ V}$, $R_L = 1\text{ k}\Omega$, input and output are biased to midsupply⁽¹⁾.

PARAMETER		TEST CONDITIONS	MIN	TYP	MAX	UNIT	Test Level ⁽²⁾
POWER SUPPLY							
VS	Operating voltage	$T_A = 25^\circ\text{C}$	4.75		27	V	A
		$T_A = -40^\circ\text{C}$ to $+125^\circ\text{C}$	4.75		27	V	B
I _Q	Quiescent current per channel	$T_A = 25^\circ\text{C}$	3.2	3.7	4.1	mA	A
		$T_A = -40^\circ\text{C}$ to $+125^\circ\text{C}$	3.0		4.5	mA	B
PSRR	Power supply rejection ratio	$\Delta V_S = 2\text{ V}^{(6)}$	90	105		dB	A
		$T_A = -40^\circ\text{C}$ to $+125^\circ\text{C}$	90			dB	B
AUXILIARY CMOS INPUT STAGE							
	Gain-bandwidth product	$V_{CM} = V_{S+} - 1\text{ V}$		35		MHz	C
	Open-loop voltage gain	$V_{CM} = V_{S+} - 1\text{ V}$, $f = \text{DC}$, $V_o = 7\text{ V}$ to -7 V	80	95		dB	A
	Input-referred voltage noise	$V_{CM} = V_{S+} - 1\text{ V}$, $f = 1\text{ MHz}$		21		nV/ $\sqrt{\text{Hz}}$	C
	Input offset voltage	$V_{CM} = V_{S+} - 1.5\text{ V}$, no-load			4	mV	A
		$V_{CM} = V_{S+} - 0.5\text{ V}$, no-load			4.8	mV	A
		$V_{CM} = V_{S+} - 0.5\text{ V}$, $T_A = -40^\circ\text{C}$ to $+125^\circ\text{C}$, no-load			6.4	mV	B
	Input bias current	$V_{CM} = V_{S+} - 1.5\text{ V}$		2	24	pA	A
		$V_{CM} = V_{S+} - 1.5\text{ V}$, $T_A = -40^\circ\text{C}$ to $+125^\circ\text{C}$		0.15	1	nA	B
	Common-mode rejection ratio	$V_{CM} = V_{S+} - 1.5\text{ V}$ to $V_{S+} - 0.5\text{ V}$		75		dB	B
	Power supply rejection ratio	$V_{CM} = V_{S+} - 1.5\text{ V}$, $\Delta V_S = \pm 2\text{ V}^{(6)}$		70		dB	B
CHANNEL MATCHING							
	Channel-to-channel GBWP mismatch	$T_A = 25^\circ\text{C}$		3		%	C
	Channel-to-channel crosstalk	$f = 100\text{ kHz}$		-93		dBc	C
	Input offset voltage mismatch	$T_A = 25^\circ\text{C}$		0.1	2.5	mV	A

(6) The supply voltages are $V_{S+} = 12\text{ V} \pm 1\text{ V}$ and $V_{S-} = -12\text{ V}$ for +PSRR, and $V_{S+} = 12\text{ V}$ and $V_{S-} = -12\text{ V} \pm 1\text{ V}$ for -PSRR.

7.7 Electrical Characteristics: 5 V

Test conditions unless otherwise noted: $T_A = 25^\circ\text{C}$, $V_{S+} = 5\text{ V}$, $V_{S-} = 0\text{ V}$, $V_{CM} = 1.25\text{ V}$, $R_L = 1\text{ k}\Omega$, and output is biased to midsupply⁽¹⁾.

PARAMETER		TEST CONDITIONS	MIN	TYP	MAX	UNIT	Test Level ⁽²⁾
AC PERFORMANCE							
SSBW	Small-signal bandwidth	$G = 1$, $V_o = 20\text{ mV}_{PP}$, $R_F = 0\ \Omega$		74		MHz	C
		$G = 1$, $V_o = 20\text{ mV}_{PP}$, $R_F = 0\ \Omega$, $C_L = 33\text{ pF}$		103		MHz	C
		$G = -1$, $V_o = 20\text{ mV}_{PP}$		51		MHz	C
		$G = 2$, $V_o = 20\text{ mV}_{PP}$		49		MHz	C
		$G = 5$, $V_o = 20\text{ mV}_{PP}$		15		MHz	C
LSBW	Large-signal bandwidth	$G = 2$, $V_o = 2\text{ V}_{PP}$		33		MHz	C
GBWP	Gain-bandwidth product	$G = 11$, $V_o = 20\text{ mV}_{PP}$		70		MHz	C
	Bandwidth for 0.1dB flatness	$G = 2$, $V_o = 20\text{ mV}_{PP}$		11		MHz	C
SR	Slew rate (20%-80%) ⁽³⁾	$G = 2$, $V_o = -1\text{-V}$ to 1-V step		119		V/ μs	C
		$G = 2$, $V_o = -2\text{-V}$ to 2-V step, $V_S = \pm 2.5\text{ V}$		88		V/ μs	C
	Rise time	$V_o = 200\text{-mV}$ step		4		ns	C
	Fall time	$V_o = 200\text{-mV}$ step		5		ns	C
	Settling time to 0.1%	$G = 2$, $V_o = -2\text{-V}$ to 0-V step, $V_S = \pm 2.5\text{ V}$		108		ns	C
	Settling time to 0.001%	$G = 2$, $V_o = -2\text{-V}$ to 0-V step, $V_S = \pm 2.5\text{ V}$		197		ns	C
	Overshoot/undershoot	$G = 1$, $V_o = 200\text{ mV}_{PP}$		10/11		%	C
		$G = 1$, $V_o = -1.25\text{-V}$ to 0.75-V step		1/7		%	C
	Input overdrive recovery	$G = 1$, ($V_{S-} - 0.5\text{ V}$) to ($V_{S+} + 0.5\text{ V}$) input, $V_S = \pm 2.5\text{ V}$ (see Figure 39)		71		ns	C
	Output overdrive recovery	$G = -1$, ($V_{S-} - 0.5\text{ V}$) to ($V_{S+} + 0.5\text{ V}$) input, $V_S = \pm 2.5\text{ V}$ (see Figure 40)		91		ns	C
HD2	Second-order harmonic distortion	$f = 100\text{ kHz}$, $R_L = 1\text{ k}\Omega$, $V_o = 2\text{ V}_{PP}$		-102		dBc	C
		$f = 1\text{ MHz}$, $R_L = 1\text{ k}\Omega$, $V_o = 2\text{ V}_{PP}$		-85		dBc	C
HD3	Third-order harmonic distortion	$f = 100\text{ kHz}$, $R_L = 1\text{ k}\Omega$, $V_o = 2\text{ V}_{PP}$		-113		dBc	C
		$f = 1\text{ MHz}$, $R_L = 1\text{ k}\Omega$, $V_o = 2\text{ V}_{PP}$		-97		dBc	C
e_n	Input-referred voltage noise	$f = 500\text{ kHz}$, latband		6		nV/ $\sqrt{\text{Hz}}$	C
		$f = 0.1\text{-}10\text{ Hz}$ integrated		0.42		μV_{rms}	C
e_i	Input-referred current noise	$f = 10\text{ kHz}$		5		fA/ $\sqrt{\text{Hz}}$	C
z_o	Close-loop output impedance	$f = 100\text{ kHz}$		0.007		Ω	C
DC PERFORMANCE							
A_{OL}	Open-loop voltage gain	$f = \text{DC}$, $V_o = 1.25\text{ V}$ to 3.25 V	104	118		dB	A
		$T_A = -40^\circ\text{C}$ to $+125^\circ\text{C}$	104			dB	B
V_{OS}	Input offset voltage	$T_A = 25^\circ\text{C}$, no-load		0.1	1.5	mV	A
		$T_A = -40^\circ\text{C}$ to $+85^\circ\text{C}$			2.4	mV	B
		$T_A = -40^\circ\text{C}$ to $+125^\circ\text{C}$			2.8	mV	B
	Input offset voltage drift	$T_A = 25^\circ\text{C}$, no-load		1.5		$\mu\text{V}/^\circ\text{C}$	B
		$T_A = -40^\circ\text{C}$ to $+125^\circ\text{C}$			13	$\mu\text{V}/^\circ\text{C}$	B

(1) For AC specifications, $V_{S+} = 3.5\text{ V}$, $V_{S-} = -1.5\text{ V}$, $G = 2\text{ V/V}$, $R_F = 1\text{ k}\Omega$, $C_L = 4.7\text{ pF}$, input and output are biased to 0 V (unless otherwise noted).

(2) Test levels (all values set by characterization and simulation): (A) 100% tested at 25°C , overtemperature limits by characterization and simulation; (B) Not tested in production, limits set by characterization and simulation; (C) Typical value only for information.

(3) Lower of the measured positive and negative slew rate.

Electrical Characteristics: 5 V (continued)

Test conditions unless otherwise noted: $T_A = 25^\circ\text{C}$, $V_{S+} = 5\text{ V}$, $V_{S-} = 0\text{ V}$, $V_{CM} = 1.25\text{ V}$, $R_L = 1\text{ k}\Omega$, and output is biased to midsupply⁽¹⁾.

PARAMETER		TEST CONDITIONS	MIN	TYP	MAX	UNIT	Test Level ⁽²⁾
	Input bias current	$T_A = 25^\circ\text{C}$		2	20	pA	A
		$T_A = -40^\circ\text{C}$ to $+85^\circ\text{C}$ ⁽⁴⁾		20	50	pA	B
		$T_A = -40^\circ\text{C}$ to $+125^\circ\text{C}$ ⁽⁴⁾		100	340	pA	B
	Input offset current	$T_A = 25^\circ\text{C}$		1	20	pA	A
		$T_A = -40^\circ\text{C}$ to $+85^\circ\text{C}$		5		pA	B
		$T_A = -40^\circ\text{C}$ to $+125^\circ\text{C}$		50		pA	B
CMRR	Common-mode rejection ratio	$f = \text{DC}$, $T_A = 25^\circ\text{C}$, $V_{CM} = 0.75\text{ V}$ to 1.75 V	78	92		dB	A
		$T_A = -40^\circ\text{C}$ to $+125^\circ\text{C}$	75			dB	B
INPUT							
	Allowable input differential voltage	See Figure 57		± 5		V	C
	Common-mode input impedance	In closed-loop configuration		$12 \parallel 2.5$		$\text{G}\Omega \parallel \mu\text{F}$	C
	Differential input capacitance	In open-loop configuration		0.5		pF	C
	Most positive input voltage	$\Delta V_{OS} < 5\text{ mV}$ ⁽⁵⁾	$V_{S+} + 0.2$	$V_{S+} + 0.3$		V	A
		$T_A = -40^\circ\text{C}$ to $+125^\circ\text{C}$	$V_{S+} + 0.2$			V	B
	Most negative input voltage	$\Delta V_{OS} < 5\text{ mV}$ ⁽⁵⁾	$V_{S-} - 0.2$	$V_{S-} - 0.3$		V	A
		$T_A = -40^\circ\text{C}$ to $+125^\circ\text{C}$	$V_{S-} - 0.2$			V	B
	Most positive input voltage for main-JFET stage	$T = 25^\circ\text{C}$ (see Figure 43)	$V_{S+} - 2.9$	$V_{S+} - 2.5$		V	C
		$T_A = -40^\circ\text{C}$ to $+125^\circ\text{C}$	$V_{S+} - 3$			V	C
OUTPUT							
V_{OCRH}	Output voltage range high	$T_A = 25^\circ\text{C}$, $R_L = 667\ \Omega$	$V_{S+} - 0.12$	$V_{S+} - 0.09$		V	A
		$T_A = -40^\circ\text{C}$ to $+125^\circ\text{C}$, $R_{LOAD} = 667\ \Omega$	$V_{S+} - 0.15$			V	B
V_{OCRL}	Output voltage range low	$T_A = 25^\circ\text{C}$, $R_L = 667\ \Omega$	$V_{S-} + 0.1$	$V_{S-} + 0.06$		V	A
		$T_A = -40^\circ\text{C}$ to $+125^\circ\text{C}$, $R_L = 667\ \Omega$	$V_{S-} + 0.15$			V	B
$I_{O(max)}$	Linear output drive (sourcing and sinking)	$T_A = 25^\circ\text{C}$, $V_O = 1.4\text{ V}$, $R_L = 27.5\ \Omega$, $V_{OS} < 2\text{ mV}$, $V_{S+} = 3\text{ V}$ and $V_{S-} = -2\text{ V}$	50	64		mA	A
		$T_A = -40^\circ\text{C}$ to 125°C , $V_O = 0.6\text{ V}$, $V_{OS} < 2\text{ mV}$, $V_{S+} = 3\text{ V}$ and $V_{S-} = -2\text{ V}$	22			mA	B
I_{SC}	Output short-circuit current	$T_A = 25^\circ\text{C}$, $T_{Delay} = 5\text{ ms}$		96		mA	B
C_L	Capacitive load drive	$< 1\text{ dB}$ peaking, $R_S = 0\ \Omega$		35		pF	C
POWER SUPPLY							
V_S	Operating voltage	$T_A = 25^\circ\text{C}$	4.75		27	V	A
		$T_A = -40^\circ\text{C}$ to $+125^\circ\text{C}$	4.75		27	V	B
I_Q	Quiescent current per channel	$T_A = 25^\circ\text{C}$	3.05	3.6	4	mA	A
		$T_A = -40^\circ\text{C}$ to $+125^\circ\text{C}$	2.8		4.4	mA	B
PSRR	Power supply rejection ratio	$\Delta V_S = 0.5\text{ V}$, $V_{CM} = 0.5\text{ V}$ ⁽⁶⁾	80	100		dB	A
		$T_A = -40^\circ\text{C}$ to $+125^\circ\text{C}$	80			dB	B

(4) Maximum bias current specification is set using $\pm 5\sigma$ limits (corresponding to 0.58 DPPM) obtained using the statistical distribution from electrical characterization over temperature of a sample set of 70 units. Maximum specification is not specified by final automated test equipment (ATE) nor by QA sample testing.

(5) Change in input offset from its value when input is biased to 0 V.

(6) The supply voltages are $V_{S+} = 5\text{ V} \pm 0.25\text{ V}$ and $V_{S-} = 0\text{ V}$ for +PSRR, and $V_{S+} = 5\text{ V}$ and $V_{S-} = 0\text{ V} \pm 0.25\text{ V}$ for -PSRR.

Electrical Characteristics: 5 V (continued)

Test conditions unless otherwise noted: $T_A = 25^\circ\text{C}$, $V_{S+} = 5\text{ V}$, $V_{S-} = 0\text{ V}$, $V_{CM} = 1.25\text{ V}$, $R_L = 1\text{ k}\Omega$, and output is biased to midsupply⁽¹⁾.

PARAMETER	TEST CONDITIONS	MIN	TYP	MAX	UNIT	Test Level ⁽²⁾
AUXILIARY CMOS INPUT STAGE						
Gain-bandwidth product	$V_{CM} = V_{S+} - 1\text{ V}$		35		MHz	C
Open-loop voltage gain	$V_{CM} = V_{S+} - 1\text{ V}$, $f = \text{DC}$, $V_o = 1.5\text{ V}$ to 2.5 V	80	100		dB	A
Input-referred voltage noise	$V_{CM} = V_{S+} - 1\text{ V}$, $f = 1\text{ MHz}$		21		nV/ $\sqrt{\text{Hz}}$	C
Input offset voltage	$V_{CM} = V_{S+} - 1.5\text{ V}$, no-load			4	mV	A
	$V_{CM} = V_{S+} - 0.5\text{ V}$, no-load			4.8	mV	A
	$V_{CM} = V_{S+} - 0.5\text{ V}$, $T_A = -40^\circ\text{C}$ to $+125^\circ\text{C}$, no-load			6.4	mV	B
Input bias current	$V_{CM} = V_{S+} - 1.5\text{ V}$		2	20	pA	A
	$V_{CM} = V_{S+} - 1.5\text{ V}$, $T_A = -40^\circ\text{C}$ to $+125^\circ\text{C}$		0.15	0.5	nA	B
Common-mode rejection ratio	$V_{CM} = V_{S+} - 1.5\text{ V}$ to $V_{S+} - 0.5\text{ V}$		75		dB	B
Power supply rejection ratio	$V_{CM} = V_{S+} - 1.5\text{ V}$, $\Delta V_S = \pm 0.5\text{ V}$ ⁽⁶⁾		75		dB	B
CHANNEL MATCHING						
Channel-to-channel GBWP mismatch	$T_A = 25^\circ\text{C}$		3		%	C
Channel-to-channel crosstalk	$f = 100\text{ kHz}$		-93		dBc	C
Input offset voltage mismatch	$T_A = 25^\circ\text{C}$		0.1	2.5	mV	A

7.8 Typical Characteristics: $V_S = 10\text{ V}$

at $V_{S+} = 5\text{ V}$, $V_{S-} = -5\text{ V}$, $R_L = 1\text{ k}\Omega$, input and output are biased to midsupply, and $T_A \approx 25^\circ\text{C}$. For AC specifications, $V_O = 2\text{ V}_{PP}$, $G = 2\text{ V/V}$, $R_F = 1\text{ k}\Omega$, and $C_L = 4.7\text{ pF}$ (unless otherwise noted)

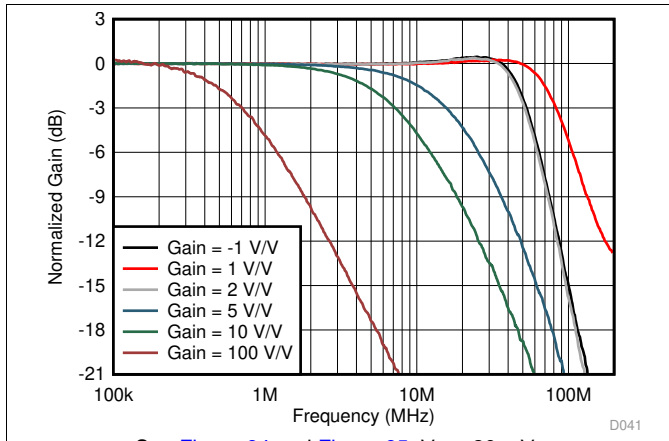

See Figure 64 and Figure 65, $V_O = 20\text{ mV}_{PP}$

Figure 1. Small-Signal Frequency Response vs Gain

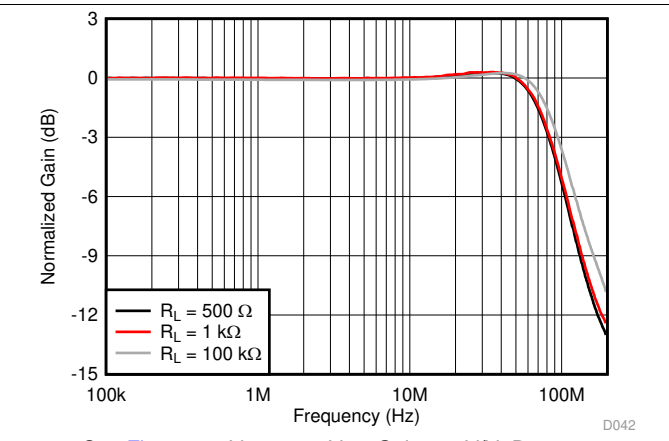

See Figure 64, $V_O = 20\text{ mV}_{PP}$, Gain = 1 V/V, $R_F = 0\ \Omega$

Figure 2. Small-Signal Frequency Response vs Output Load

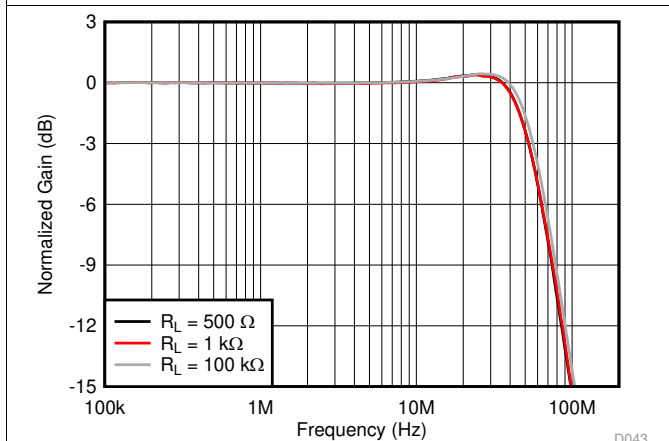

See Figure 64, $V_O = 20\text{ mV}_{PP}$, Gain = 2 V/V

Figure 3. Small-Signal Frequency Response vs Output Load

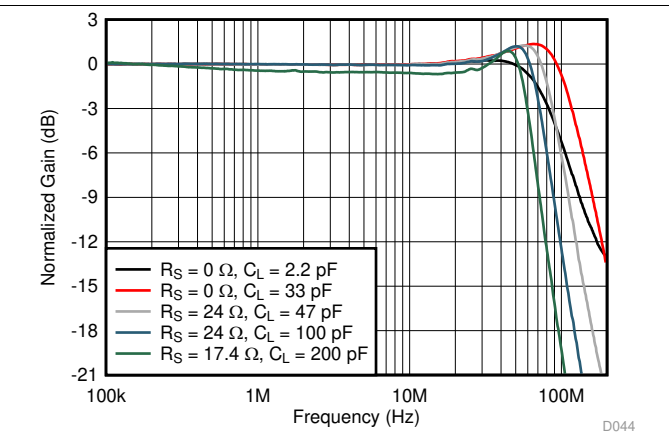

See Figure 64 and Figure 62, $V_O = 20\text{ mV}_{PP}$, Gain = 1 V/V, $R_F = 0\ \Omega$

Figure 4. Small-Signal Frequency Response vs C_L

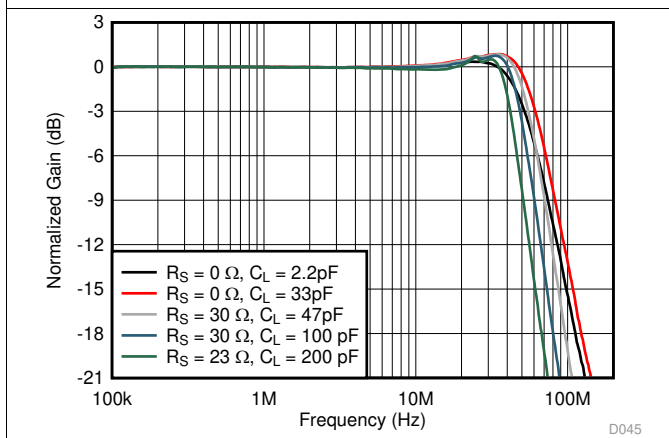

See Figure 64 and Figure 62, $V_O = 20\text{ mV}_{PP}$, Gain = 2 V/V

Figure 5. Small-Signal Frequency Response vs C_L

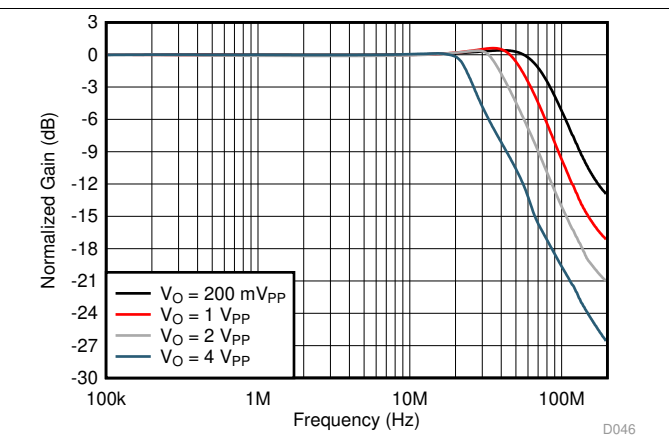

See Figure 64, Gain = 1 V/V, $R_F = 0\ \Omega$

Figure 6. Large-Signal Frequency Response vs Output Voltage

Typical Characteristics: $V_S = 10\text{ V}$ (continued)

at $V_{S+} = 5\text{ V}$, $V_{S-} = -5\text{ V}$, $R_L = 1\text{ k}\Omega$, input and output are biased to midsupply, and $T_A \approx 25^\circ\text{C}$. For AC specifications, $V_O = 2\text{ V}_{PP}$, $G = 2\text{ V/V}$, $R_F = 1\text{ k}\Omega$, and $C_L = 4.7\text{ pF}$ (unless otherwise noted)

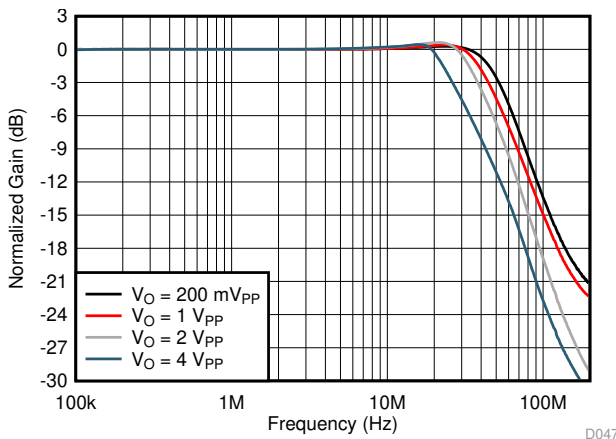

See Figure 64, Gain = 2 V/V

Figure 7. Large-Signal Frequency Response vs Output Voltage

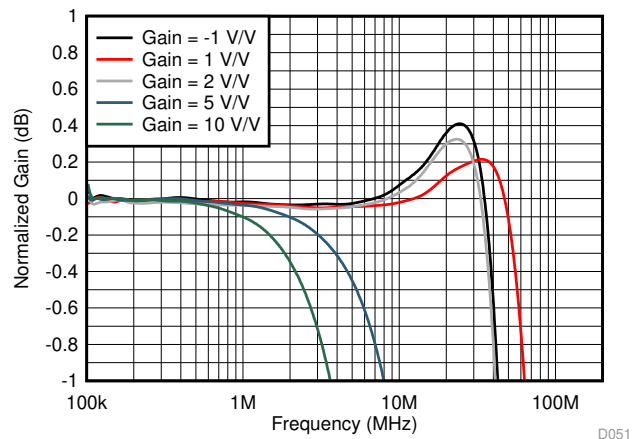

See Figure 64 and Figure 65, $V_O = 20\text{ mV}_{PP}$

Figure 8. Small-Signal Response Flatness vs Gain

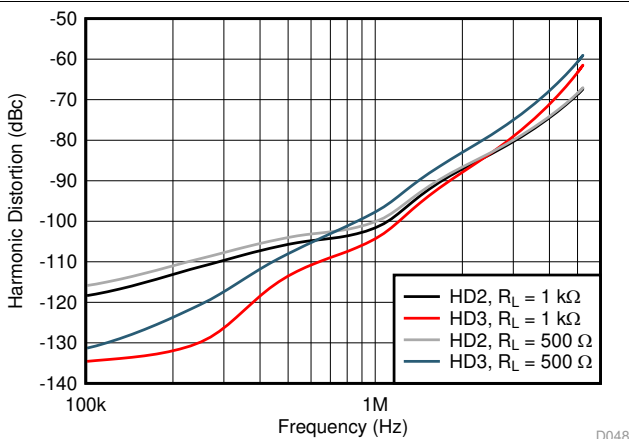

See Figure 64, Gain = 2 V/V

Figure 9. Harmonic Distortion vs Frequency

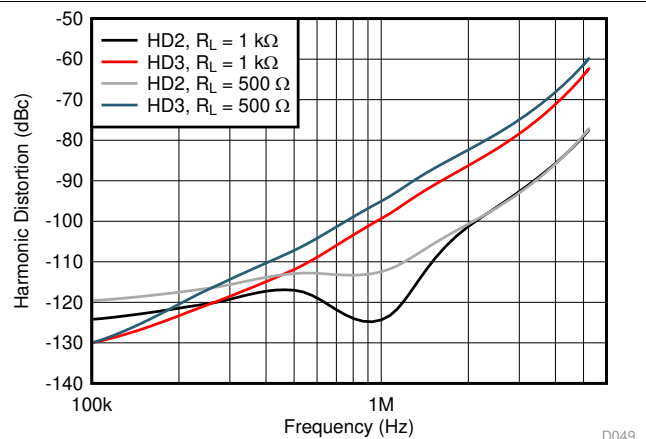

See Figure 65, Gain = -1 V/V

Figure 10. Harmonic Distortion vs Frequency

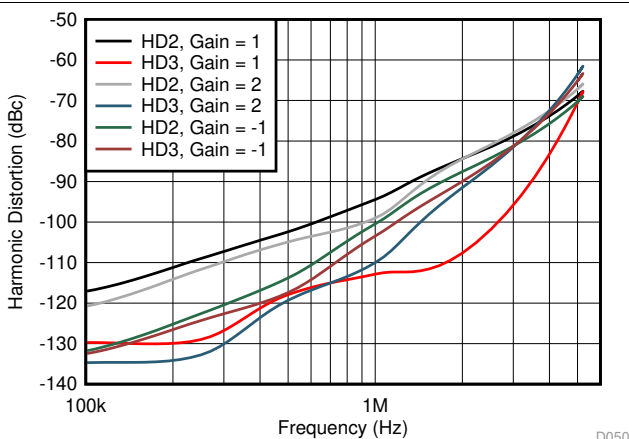

See Figure 64 and Figure 65, $R_F = 0\ \Omega$ for Gain = 1 V/V

Figure 11. Harmonic Distortion vs Gain

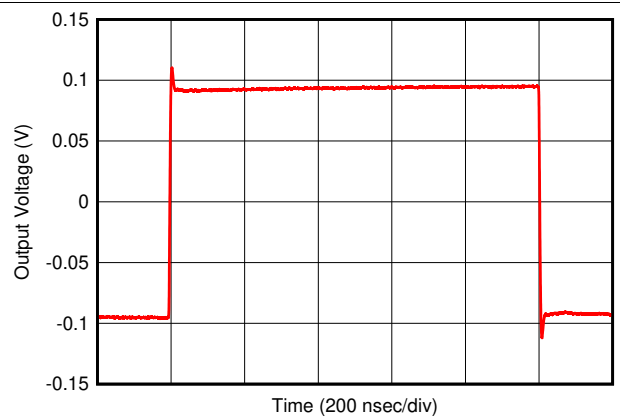

See Figure 64, Gain = 1 V/V, $R_F = 0\ \Omega$

Figure 12. Small-Signal Transient Response

Typical Characteristics: $V_S = 10\text{ V}$ (continued)

at $V_{S+} = 5\text{ V}$, $V_{S-} = -5\text{ V}$, $R_L = 1\text{ k}\Omega$, input and output are biased to midsupply, and $T_A \approx 25^\circ\text{C}$. For AC specifications, $V_O = 2\text{ V}_{PP}$, $G = 2\text{ V/V}$, $R_F = 1\text{ k}\Omega$, and $C_L = 4.7\text{ pF}$ (unless otherwise noted)

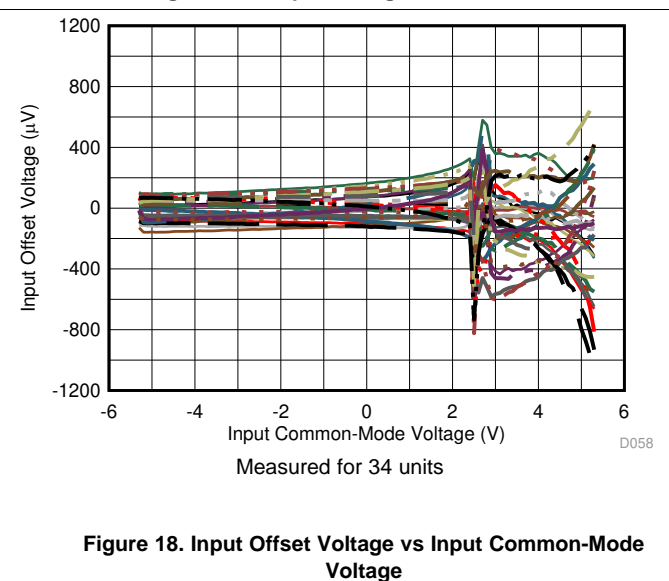
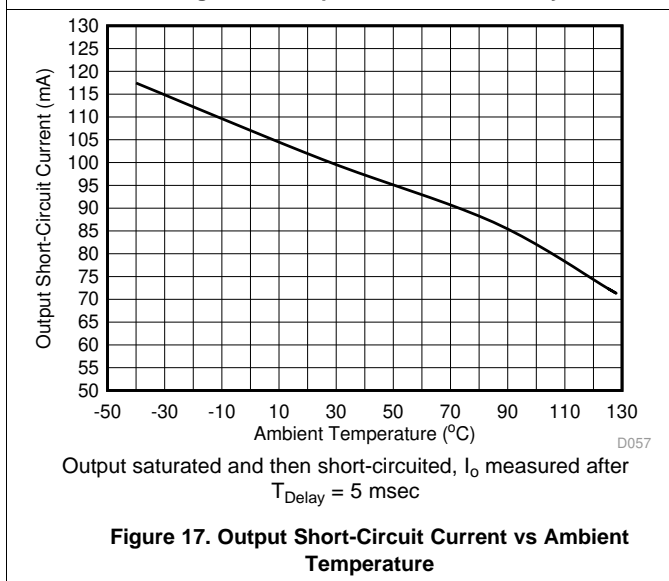
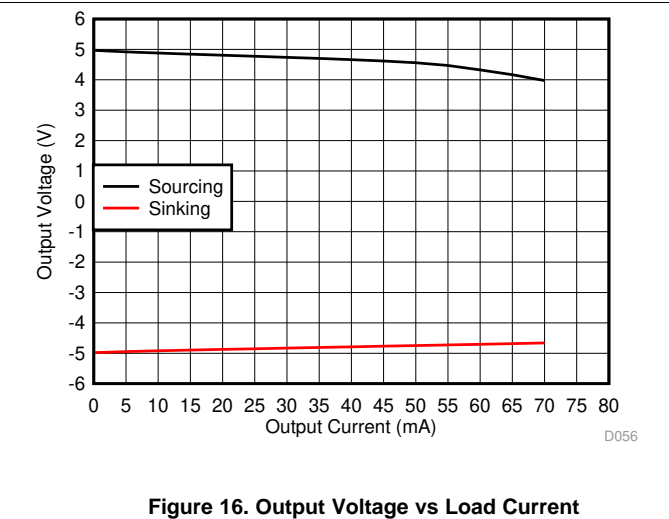
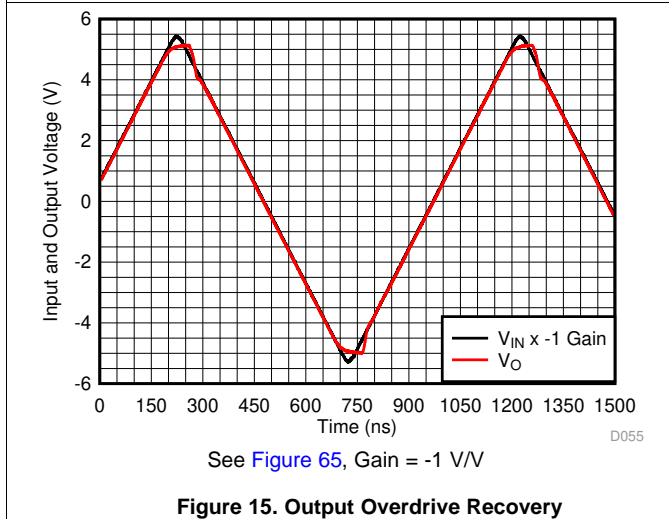
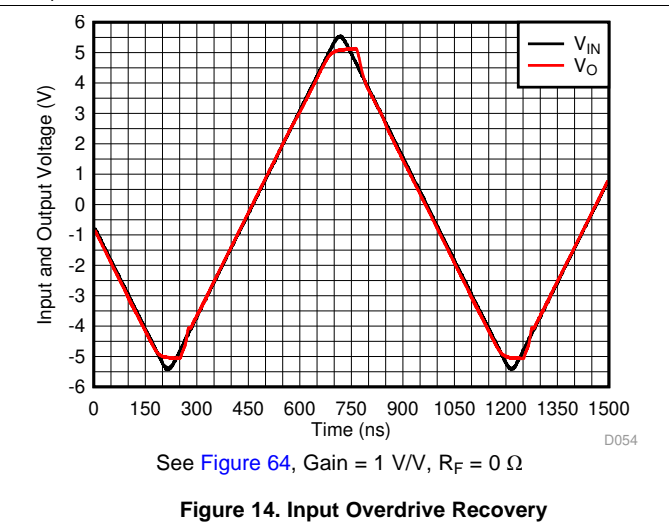
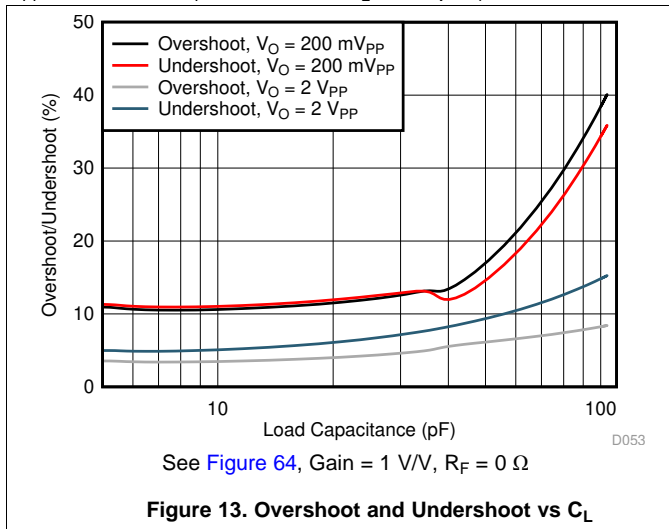

7.9 Typical Characteristics: $V_S = 24\text{ V}$

at $V_{S+} = 12\text{ V}$, $V_{S-} = -12\text{ V}$, $R_L = 1\text{ k}\Omega$ and output are biased to midsupply, and $T_A \approx 25^\circ\text{C}$. For AC specifications, $V_O = 2\text{ V}_{PP}$, $G = 2\text{ V/V}$, $R_F = 1\text{ k}\Omega$, and $C_L = 4.7\text{ pF}$ (unless otherwise noted)

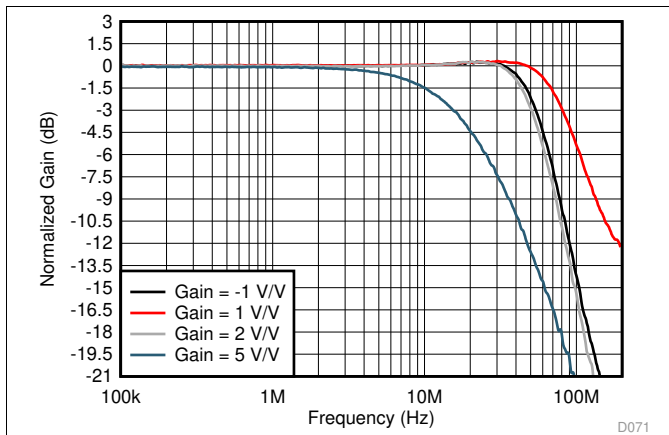

See Figure 64 and Figure 65, $V_O = 20\text{ mV}_{PP}$

Figure 19. Noninverting Small-Signal Frequency Response vs Gain

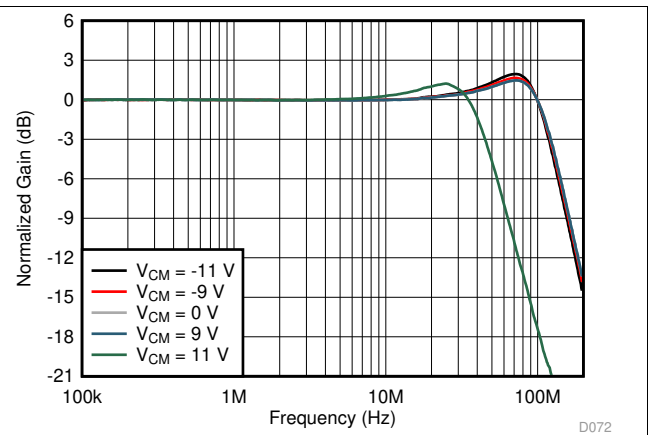

See Figure 64, $V_O = 20\text{ mV}_{PP}$, Gain = 1 V/V, $C_L = 33\text{ pF}$, $R_F = 0\ \Omega$

Figure 20. Small-Signal Frequency Response vs Output Common-Mode Voltage

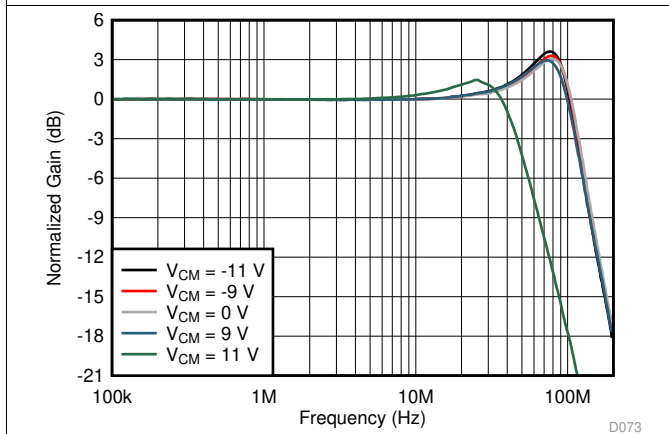

See Figure 64, $V_O = 20\text{ mV}_{PP}$, Gain = 1 V/V, $C_L = 47\text{ pF}$, $R_F = 0\ \Omega$

Figure 21. Small-Signal Frequency Response vs Output Common-Mode Voltage

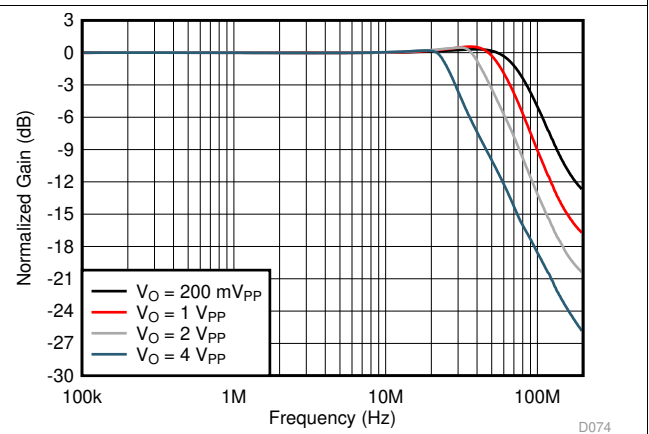

See Figure 64, Gain = 1 V/V, $R_F = 0\ \Omega$

Figure 22. Large-Signal Frequency Response vs Output Voltage

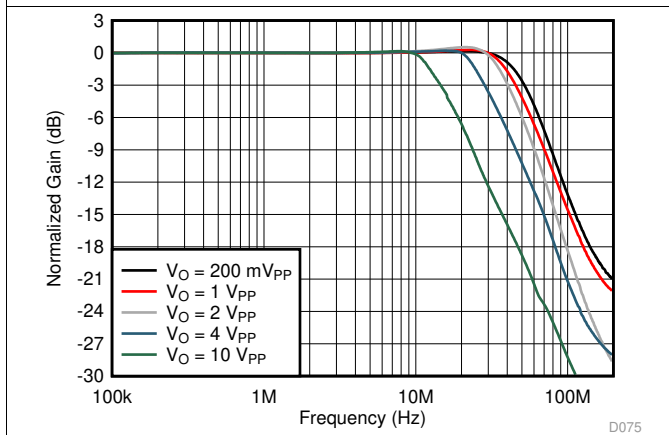

See Figure 64, Gain = 2 V/V

Figure 23. Large-Signal Frequency Response vs V_O

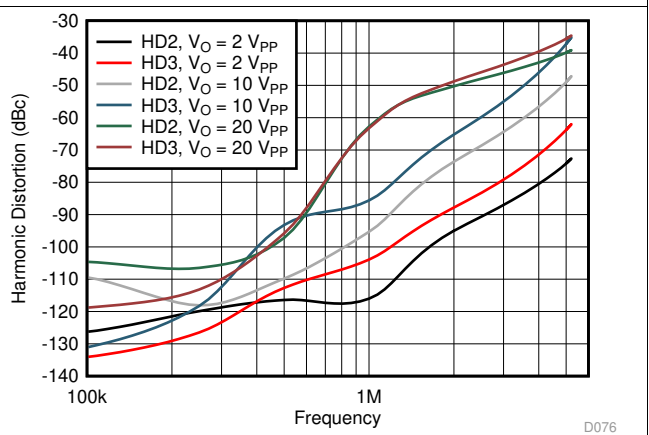

See Figure 64, Gain = 2 V/V

Figure 24. Harmonic Distortion vs Frequency vs V_O

Typical Characteristics: $V_S = 24\text{ V}$ (continued)

at $V_{S+} = 12\text{ V}$, $V_{S-} = -12\text{ V}$, $R_L = 1\text{ k}\Omega$, input and output are biased to midsupply, and $T_A \approx 25^\circ\text{C}$. For AC specifications, $V_O = 2\text{ V}_{PP}$, $G = 2\text{ V/V}$, $R_F = 1\text{ k}\Omega$, and $C_L = 4.7\text{ pF}$ (unless otherwise noted)

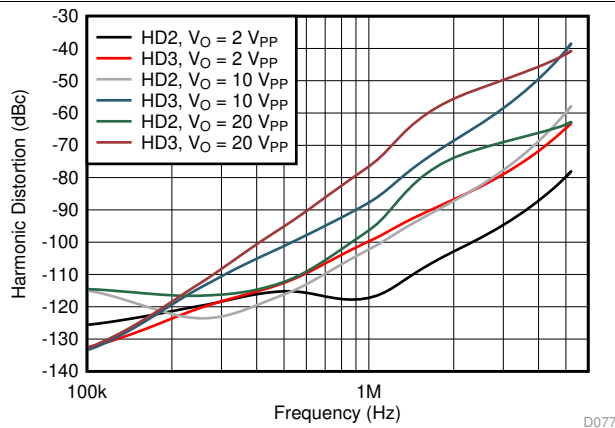

See Figure 65, Gain = -1 V/V

Figure 25. Harmonic Distortion vs Frequency vs V_O

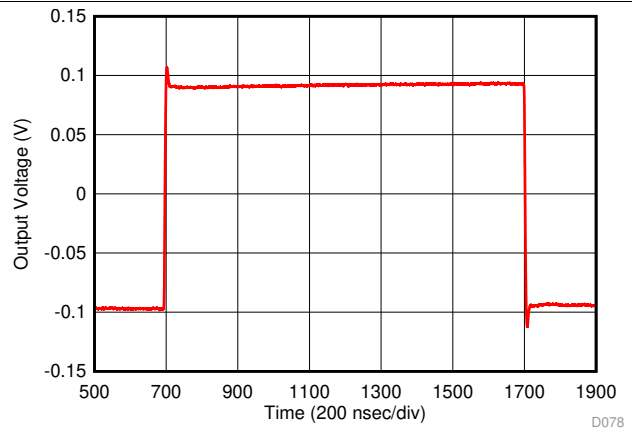

See Figure 64, Gain = 1 V/V, $R_F = 0\ \Omega$

Figure 26. Small-Signal Transient Response

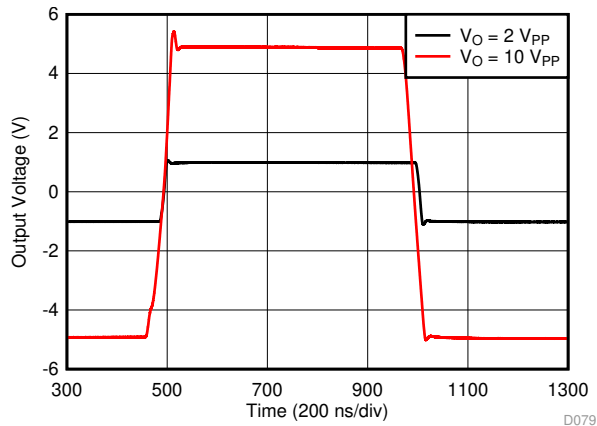

See Figure 64, Gain = 1 V/V, $R_F = 0\ \Omega$

Figure 27. Large-Signal Transient Response

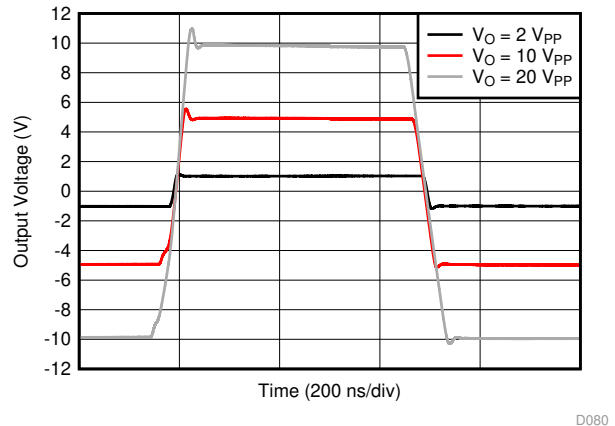

See Figure 64, Gain = 2 V/V

Figure 28. Large-Signal Transient Response

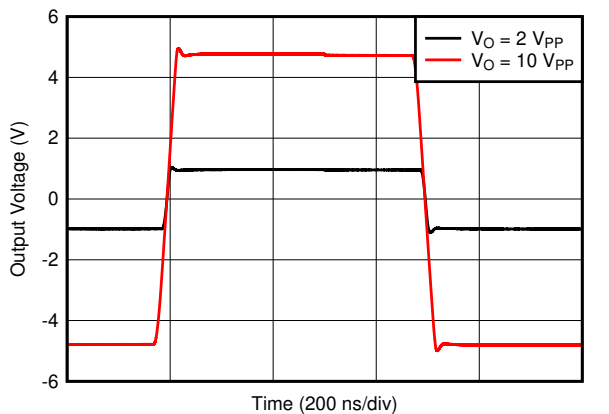

See Figure 65, Gain = -1 V/V

Figure 29. Large-Signal Transient Response

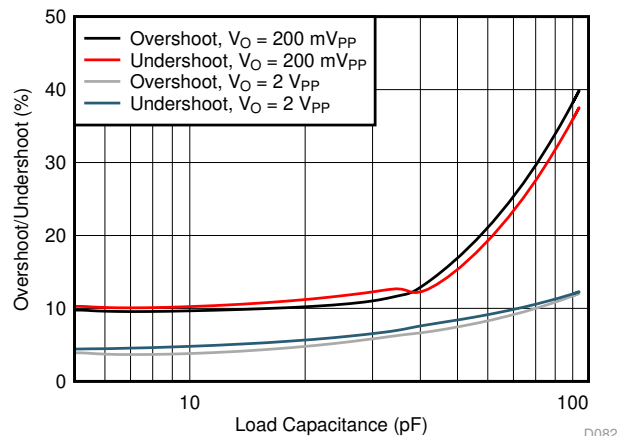

See Figure 64, Gain = 1 V/V, $R_F = 0\ \Omega$

Figure 30. Overshoot and Undershoot vs C_L

Typical Characteristics: $V_S = 24\text{ V}$ (continued)

at $V_{S+} = 12\text{ V}$, $V_{S-} = -12\text{ V}$, $R_L = 1\text{ k}\Omega$, input and output are biased to midsupply, and $T_A \approx 25^\circ\text{C}$. For AC specifications, $V_O = 2\text{ V}_{PP}$, $G = 2\text{ V/V}$, $R_F = 1\text{ k}\Omega$, and $C_L = 4.7\text{ pF}$ (unless otherwise noted)

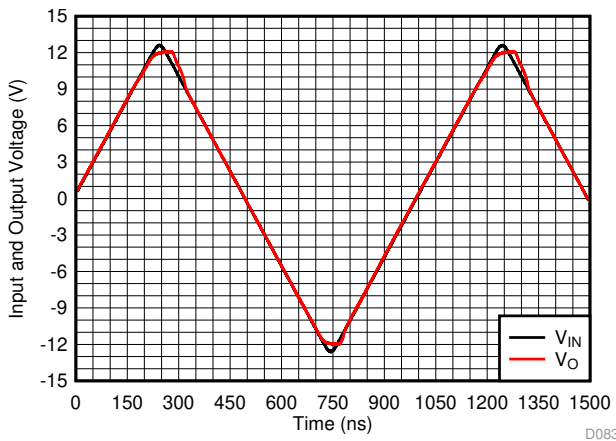

See Figure 64, Gain = 1 V/V, $R_F = 0\ \Omega$

Figure 31. Input Overdrive Recovery

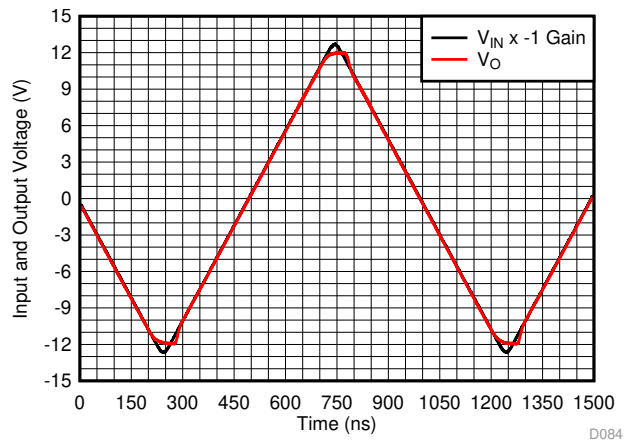

See Figure 65, Gain = -1 V/V

Figure 32. Output Overdrive Recovery

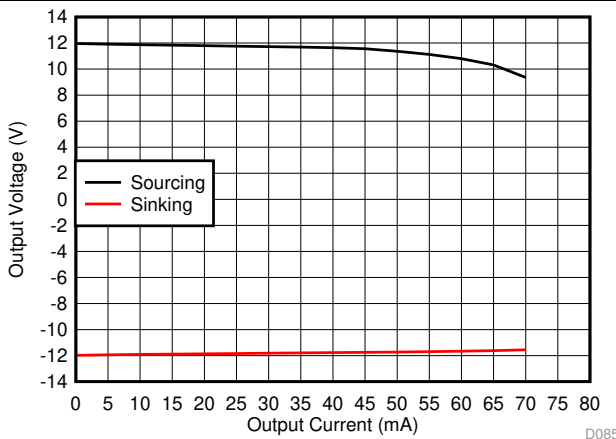
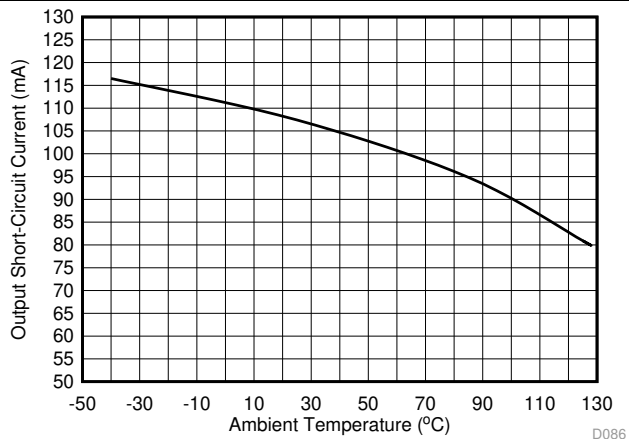

Figure 33. Output Voltage Range vs Load Current



Output saturated and then short-circuited, I_o measured after $T_{Delay} = 5\text{ msec}$

Figure 34. Output Short-Circuit Current vs Ambient Temperature

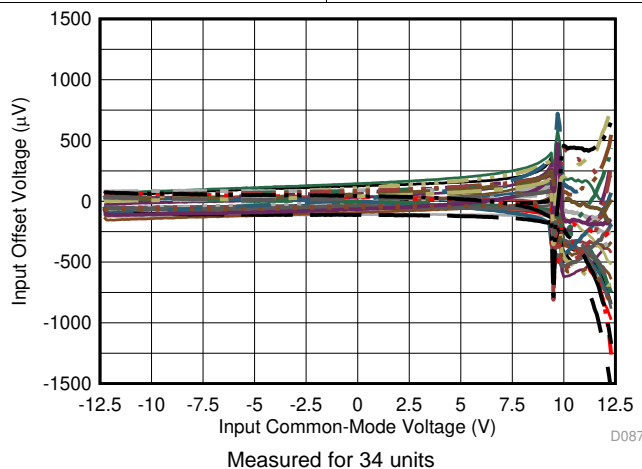

Figure 35. Input Offset Voltage vs Input Common-Mode Voltage

7.10 Typical Characteristics: $V_S = 5\text{ V}$

at $V_{S+} = 5\text{ V}$, $V_{S-} = 0\text{ V}$, $V_{CM} = 1.25\text{ V}$, $R_L = 1\text{ k}\Omega$, output is biased to midsupply, and $T_A \approx 25^\circ\text{C}$. For AC specifications, $V_{S+} = 3.5\text{ V}$, $V_{S-} = -1.5\text{ V}$, $V_{CM} = 0\text{ V}$, $V_O = 2\text{ V}_{PP}$, $G = 2\text{ V/V}$, $R_F = 1\text{ k}\Omega$, and $C_L = 4.7\text{ pF}$ (unless otherwise noted)

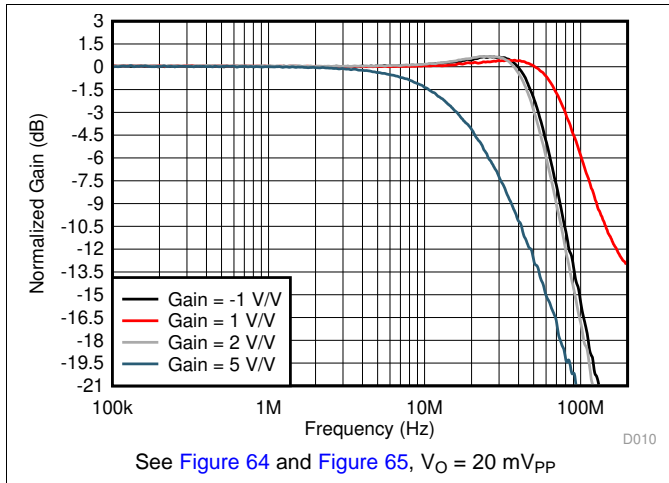

Figure 36. Small-Signal Response vs Gain

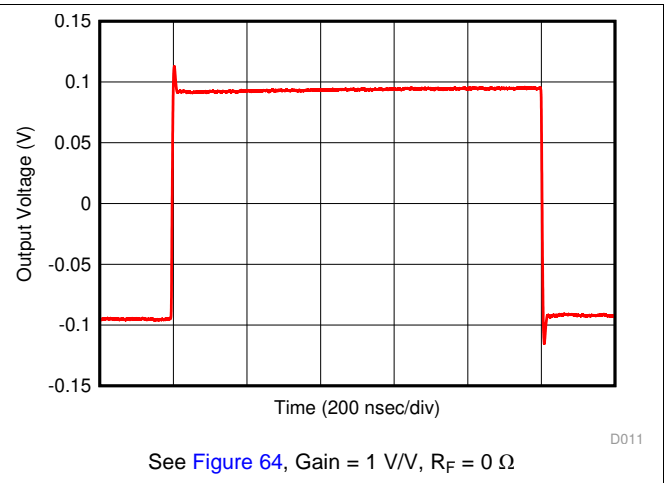

Figure 37. Small-Signal Transient Response

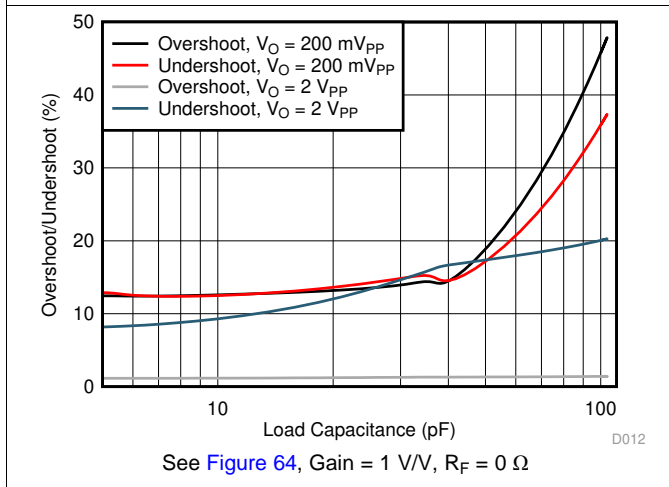

Figure 38. Overshoot and Undershoot vs C_L

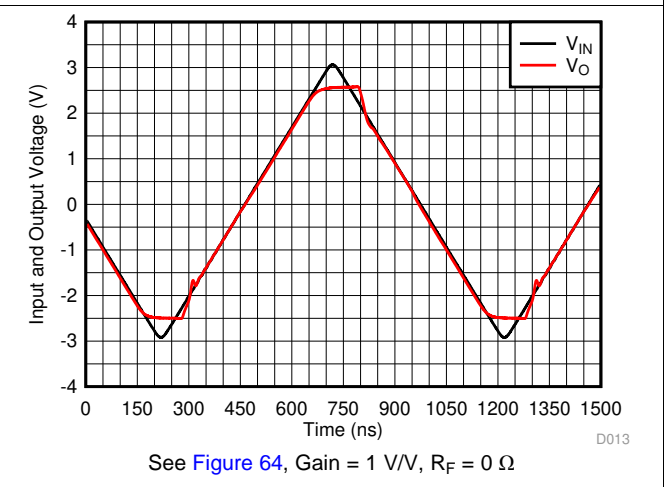

Figure 39. Input Overdrive Recovery

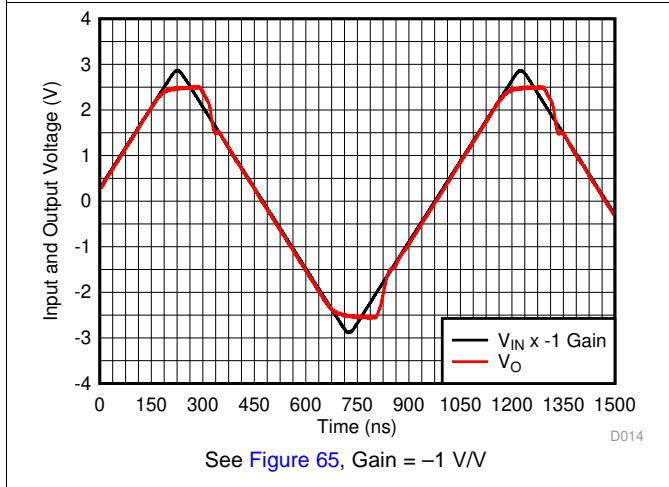

Figure 40. Output Overdrive Recovery

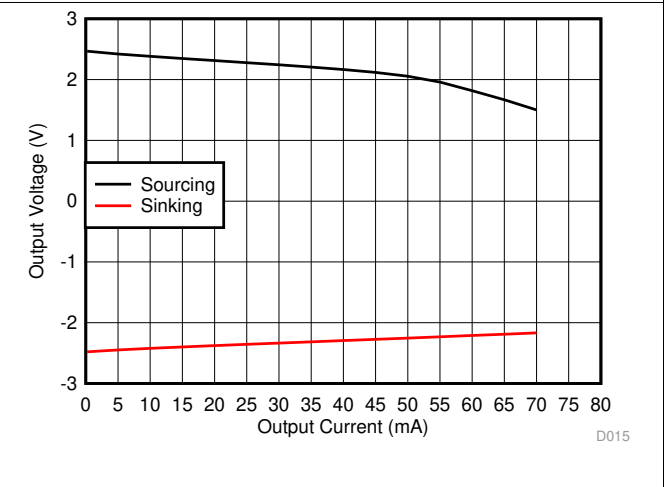
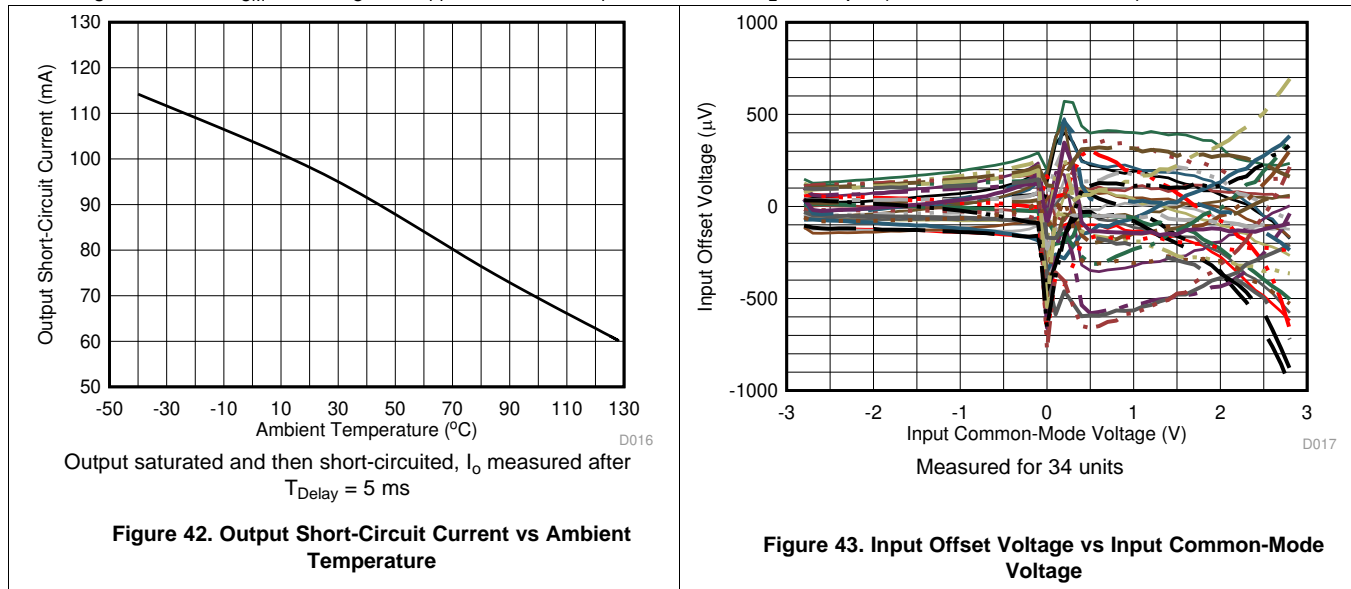

Figure 41. Output Voltage Range vs Output Current

Typical Characteristics: $V_S = 5\text{ V}$ (continued)

at $V_{S+} = 5\text{ V}$, $V_{S-} = 0\text{ V}$, $V_{CM} = 1.25\text{ V}$, $R_L = 1\text{ k}\Omega$, output is biased to midsupply, and $T_A \approx 25^\circ\text{C}$. For AC specifications, $V_{S+} = 3.5\text{ V}$, $V_{S-} = -1.5\text{ V}$, $V_{CM} = 0\text{ V}$, $V_O = 2\text{ V}_{PP}$, $G = 2\text{ V/V}$, $R_F = 1\text{ k}\Omega$, and $C_L = 4.7\text{ pF}$ (unless otherwise noted)



7.11 Typical Characteristics: $\pm 2.375\text{ V}$ to $\pm 12\text{ V}$ Split Supply

at $V_O = 2\text{ V}_{PP}$, $R_F = 1\text{ k}\Omega$, $R_L = 1\text{ k}\Omega$ and $T_A \approx 25^\circ\text{C}$ (unless otherwise noted)

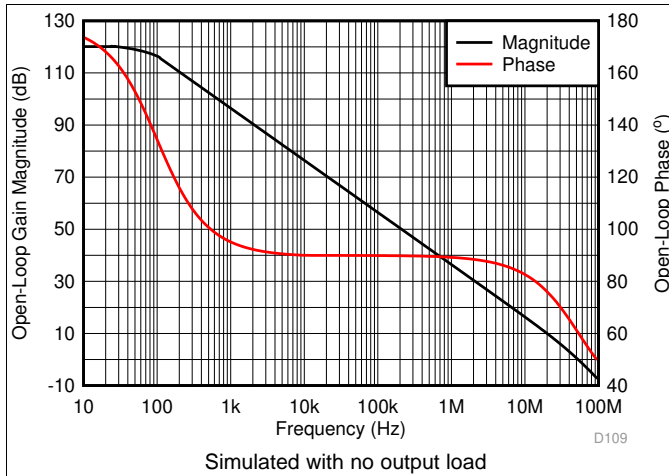
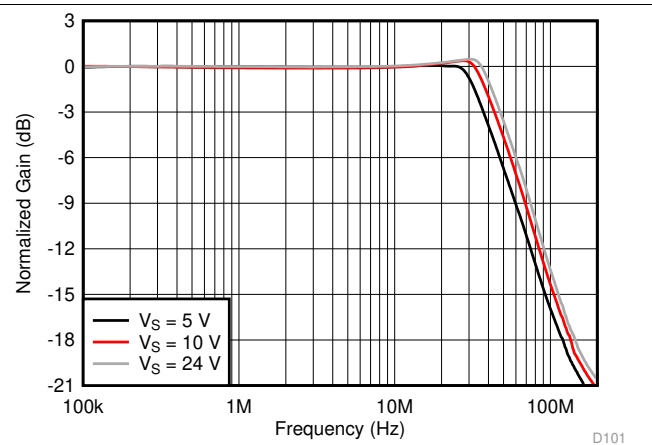
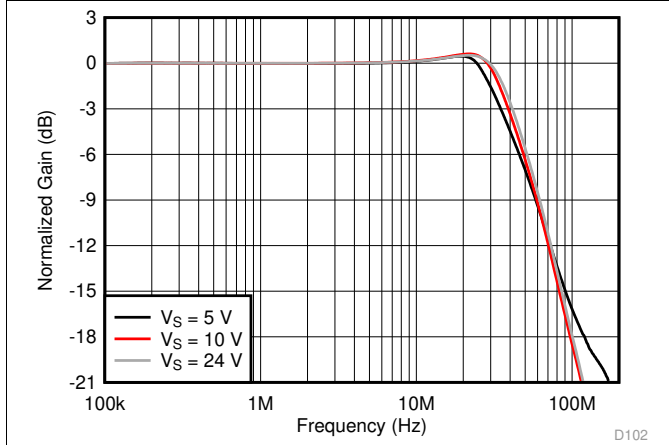

Figure 44. Open-Loop Gain and Phase vs Frequency



See Figure 64, Gain = 1 V/V, $R_F = 0\ \Omega$

Figure 45. Large-Signal Response vs Supply Voltage



See Figure 64, Gain = 2 V/V

Figure 46. Large-Signal Response vs Supply Voltage

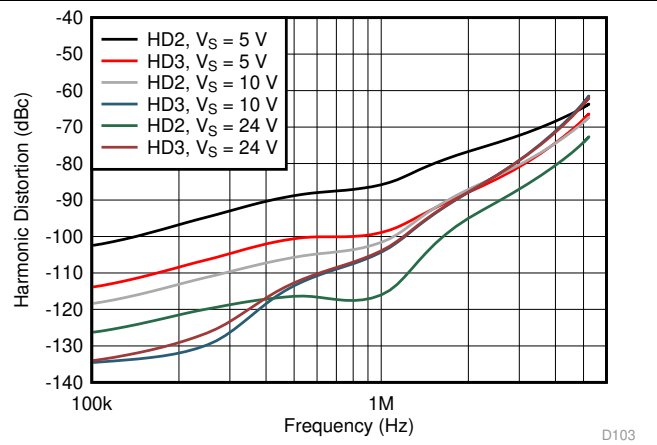

See Figure 64, Gain = 2 V/V

Figure 47. Harmonic Distortion vs Frequency vs Supply Voltage

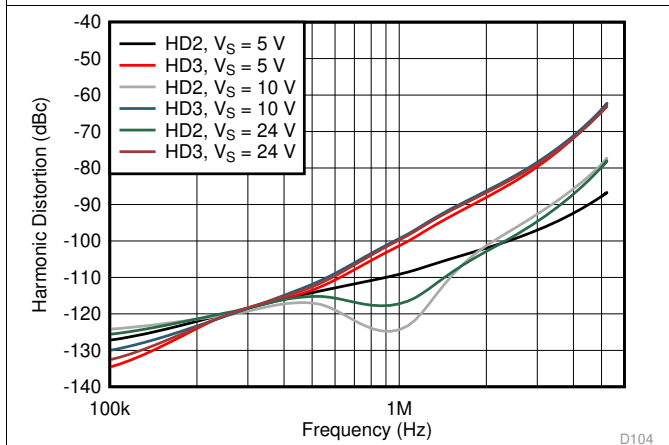

See Figure 65, Gain = -1 V/V

Figure 48. Harmonic Distortion vs Frequency vs Supply Voltage

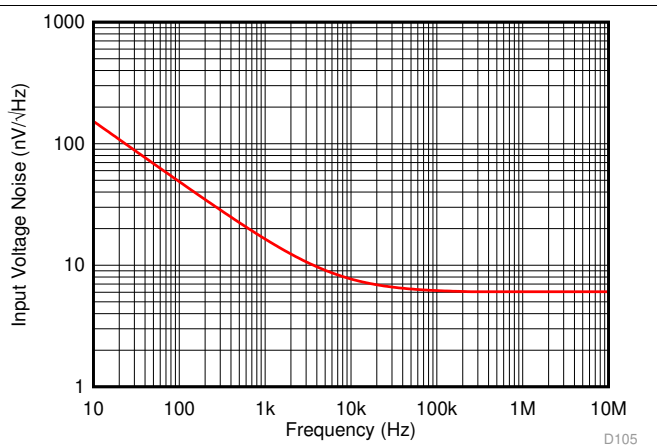

Measured then fit to ideal 1/f model

Figure 49. Input Voltage Noise Density vs Frequency

Typical Characteristics: $\pm 2.375\text{ V}$ to $\pm 12\text{ V}$ Split Supply (continued)

at $V_O = 2 V_{PP}$, $R_F = 1\text{ k}\Omega$, $R_L = 1\text{ k}\Omega$ and $T_A \approx 25^\circ\text{C}$ (unless otherwise noted)

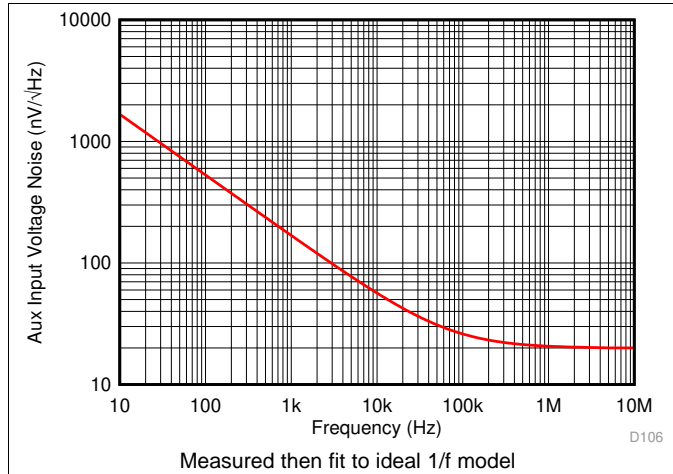

Figure 50. Auxiliary Input Stage Voltage Noise Density vs Frequency

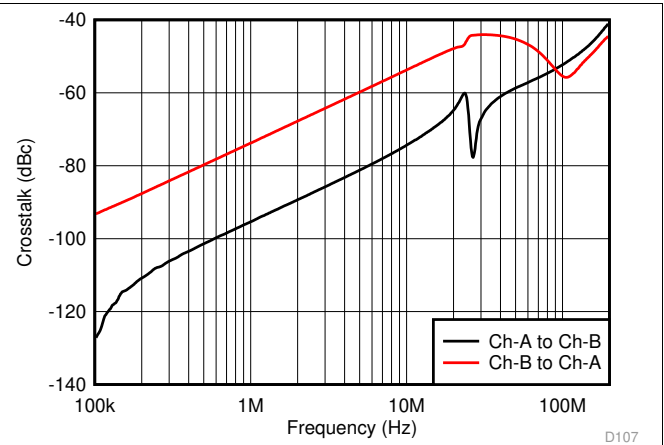

Figure 51. Crosstalk vs Frequency

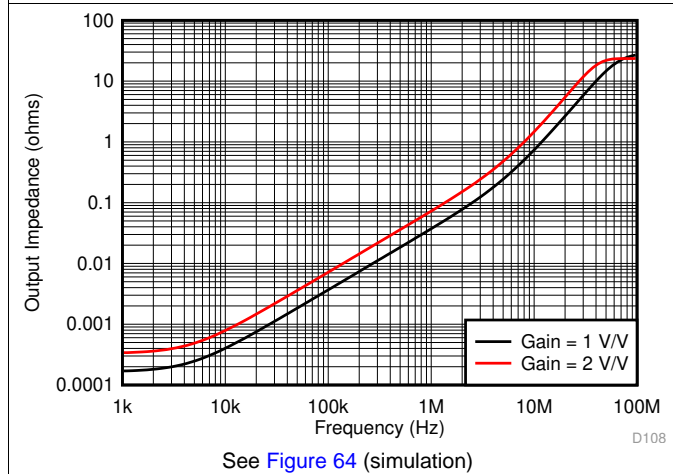

Figure 52. Closed-Loop Output Impedance vs Frequency

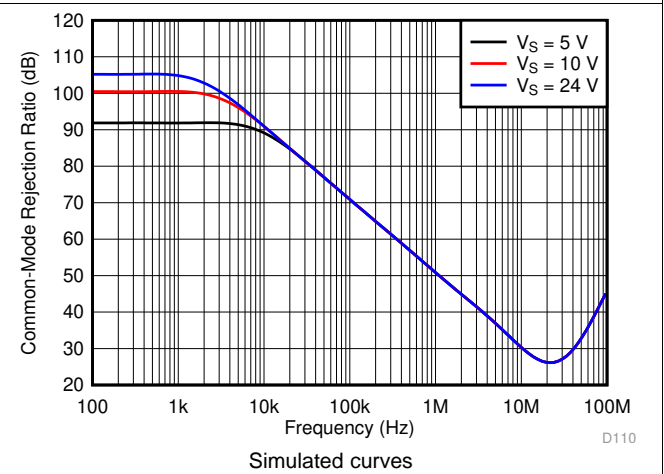

Figure 53. Common-Mode Rejection Ratio vs Frequency

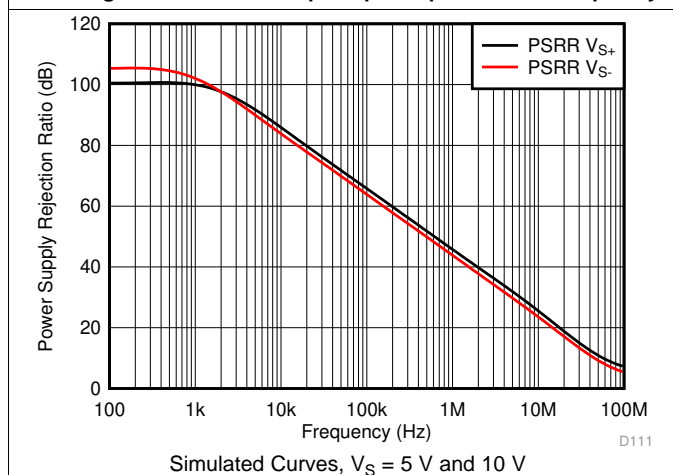

Figure 54. Power Supply Rejection Ratio vs Frequency

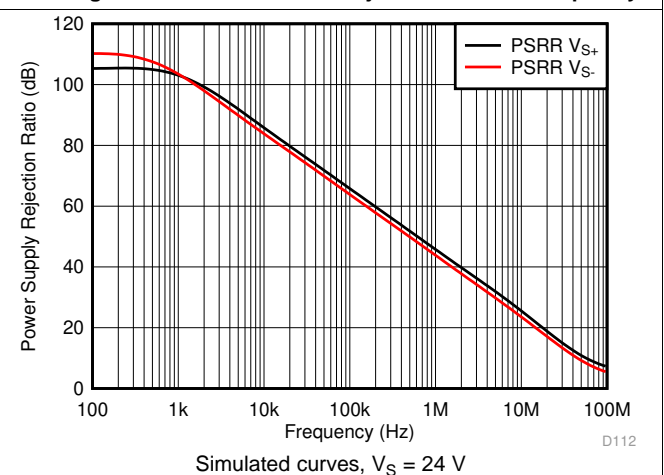
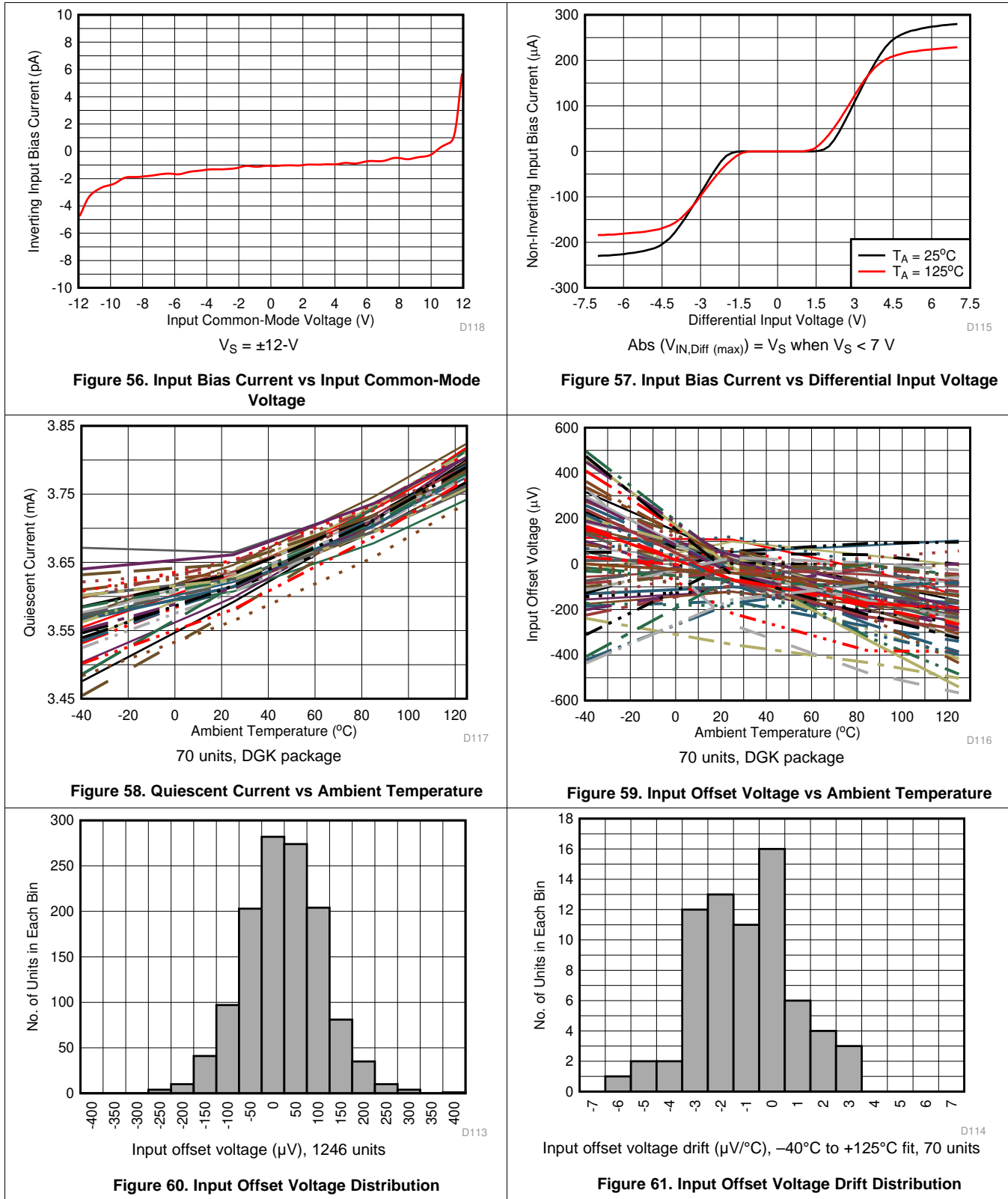

Figure 55. Power Supply Rejection Ratio vs Frequency

Typical Characteristics: ±2.375 V to ±12 V Split Supply (continued)

at $V_O = 2 V_{PP}$, $R_F = 1\text{ k}\Omega$, $R_L = 1\text{ k}\Omega$ and $T_A \approx 25^\circ\text{C}$ (unless otherwise noted)



8 Detailed Description

8.1 Overview

The OPA2810 is a dual-channel, FET-input, unity-gain stable voltage-feedback operational amplifier with extremely low input bias current across its common-mode input voltage range. The OPA2810, characterized to operate over a wide supply range of 4.75 V to 27 V, has a small-signal unity-gain bandwidth of 105 MHz and offers both excellent DC precision and dynamic AC performance at low quiescent power. The OPA2810 is fabricated on Texas Instrument's proprietary, high-speed SiGe BiCMOS process and achieves significant performance improvements over comparable FET-input amplifiers at similar levels of quiescent power. With a gain-bandwidth product (GBWP) of 70MHz, extremely high slew-rate (192 V/ μ s), and low-noise (6 nV/ $\sqrt{\text{Hz}}$) the OPA2810 is ideal in a wide range of data acquisition and signal processing applications. The OPA2810 includes input clamps to allow maximum input differential voltage of up to 7 V, making it suitable for use with multiplexers and processing of signals with fast transients. It achieves these benchmark levels of performance while consuming a typical quiescent current (I_Q) of 3.6 mA /channel.

The OPA2810 can source and sink large amounts of current without degradation in its linearity performance. The wide-bandwidth of the OPA2810 implies that the device has low output-impedance across a wide frequency range, thereby allowing the amplifier to drive capacitive loads up to 35 pF without requiring output isolation. This device is suitable for a wide range of data acquisition, test and measurement front-end buffer, impedance measurement, power analyzer, wideband photodiode transimpedance and signal processing applications.

8.2 Functional Block Diagram

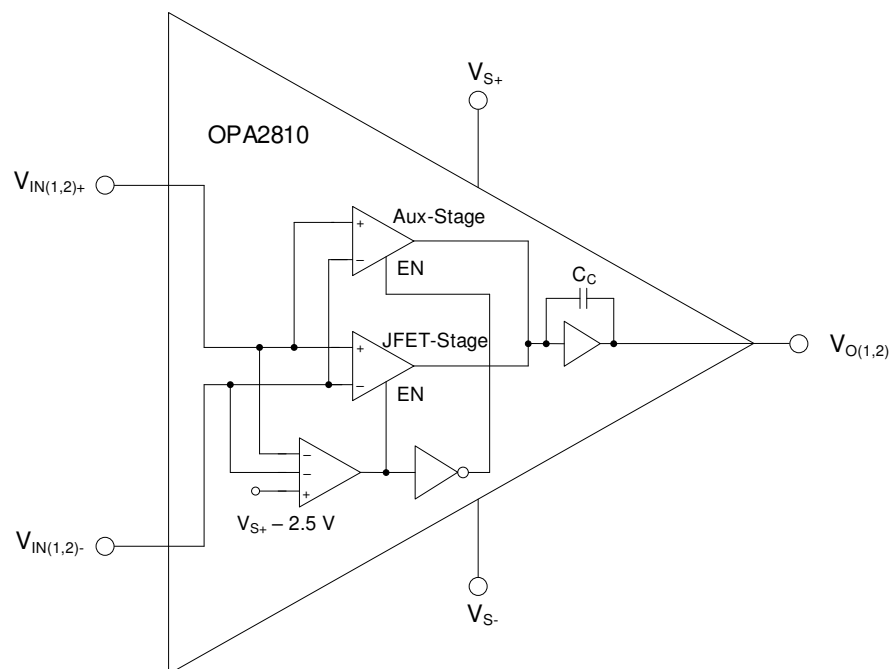

8.3 Feature Description

8.3.1 OPA2810 Architecture

The OPA2810 features a true high-impedance input stage including a JFET differential-input pair main stage and a CMOS differential-input auxiliary (Aux) stage operational within 2.5 V of the positive supply voltage. The bias current is limited to a maximum of 20 pA throughout the common-mode input range of the amplifier. The [Functional Block Diagram](#) section shows a block diagram representation for the input stage of the OPA2810.

The amplifier exhibits superior performance for high-speed signals (distortion, noise and input offset voltage) while the Aux stage enables rail-to-rail inputs and prevents phase reversal. The OPA2810 also includes input clamps which enable maximum input differential voltage of up to 7 V (lower of 7 V and total supply voltage). This architecture offers significantly greater differential input voltage capability as compared to one to two times the diode forward voltage drop maximum rating in standard amplifiers, and makes this device suitable for use with multiplexers and processing of signals with fast transients. The input bias currents are also clamped to maximum 300 μ A, as [Figure 57](#) shows, which does not load the previous driver stage or require current-limiting resistors (except limiting current through the input ESD diodes when input common-mode voltages are greater than the supply voltages). This also enables the use of one of the channels as a comparator in systems which require an amplifier and a comparator for signal-gain and fault-detection, respectively. For the lowest offset, distortion and noise performance, limit the common-mode input voltage to the main JFET-input stage (greater than 2.5 V away from the positive supply).

The OPA2810 is a rail-to-rail output amplifier and swings to either of the rails at the output, as shown in [Figure 16](#) for 10-V supply operation. This is particularly useful for inputs biased near the rails or when the amplifier is configured in a closed-loop gain such that the output approaches the supply voltage. When the output saturates, it recovers with 55 ns when inputs exceed the supply voltages by 0.5 V in an $G = -1$ V/V inverting gain with a 10-V supply. The outputs are short-circuit protected with the limits of [Figure 17](#).

An amplifier phase margin reduces and it becomes unstable when driving a capacitive load (C_L) at the output, as [Figure 62](#) shows. Use of a series resistor (R_S) between the amplifier output and load capacitance introduces a zero which cancels the pole formed by the amplifier output impedance and C_L in the open-loop transfer function. The OPA2810 drives capacitive loads of up to 35 pF without causing instability. It is recommended to use a series resistor for larger load capacitance values, as [Figure 4](#) shows for OPA2810 configured as a unity-gain buffer.

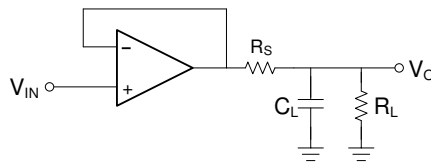

Figure 62. OPA2810 Driving Capacitive Load

Feature Description (continued)

8.3.2 ESD Protection

All the device pins are protected with internal ESD protection diodes to the power supplies as [Figure 63](#) shows. These diodes provide moderate protection to input overdrive voltages above the supplies. The protection diodes can typically support 10-mA continuous input and output currents. The differential input clamps only limit the bias current when the input common-mode voltages are within the supply voltage range, whereas current limiting series resistors must be added at the inputs if common-mode voltages higher than the supply voltages are possible. Keep these resistor values as low as possible because using high values degrades noise performance and frequency response.

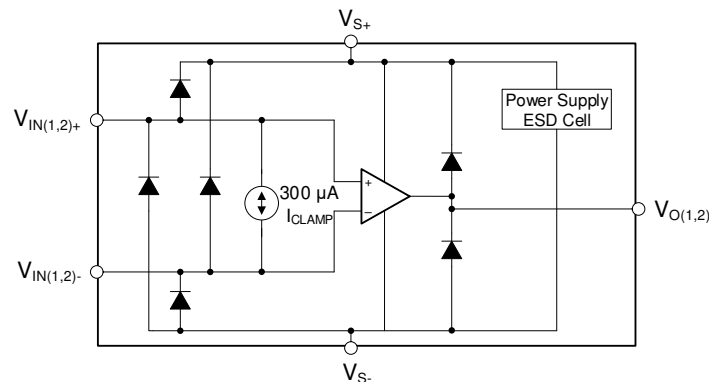

Figure 63. Internal ESD Protection

8.4 Device Functional Modes

8.4.1 Split-Supply Operation (± 2.375 V to ± 13.5 V)

To facilitate testing with common lab equipment, the OPA2810 can be configured to allow for split-supply operation (see the [OPA2810DGK Evaluation Module](#)). This configuration eases lab testing because the mid-point between the power rails is ground, and most signal generators, network analyzers, oscilloscopes, spectrum analyzers and other lab equipment reference the inputs and outputs to ground. [Figure 64](#) shows the OPA2810 configured as a noninverting amplifier and [Figure 65](#) shows the OPA2810 configured as an inverting amplifier. For split-supply operation referenced to ground, the power supplies V_{S+} and V_{S-} are symmetrical around ground and $V_{REF} = GND$. Split-supply operation is preferred in systems where the signals swing around ground because of the ease-of-use; however, the system requires two supply rails.

8.4.2 Single-Supply Operation (4.75 V to 27 V)

Many newer systems use a single power supply to improve efficiency and reduce the cost of the extra power supply. The OPA2810 can be used with a single supply (negative supply set to ground) with no change in performance if the input and output are biased within the linear operation of the device. To change the circuit from split supply to a balanced, single-supply configuration, level shift all the voltages by half the difference between the power-supply rails. An additional advantage of configuring an amplifier for single-supply operation is that the effects of PSRR are minimized because the low-supply rail is grounded. See the [Single-Supply Op Amp Design Techniques application report](#) for examples of single-supply designs.

9 Application and Implementation

NOTE

Information in the following applications sections is not part of the TI component specification, and TI does not warrant its accuracy or completeness. TI's customers are responsible for determining suitability of components for their purposes. Customers should validate and test their design implementation to confirm system functionality.

9.1 Application Information

9.1.1 Selection of Feedback Resistors

The OPA2810 is a classic voltage feedback amplifier with each channel having two high-impedance inputs and a low-impedance output. Standard application circuits include the noninverting and inverting gain configurations as [Figure 64](#) and [Figure 65](#) show. The DC operating point for each configuration is level-shifted by the reference voltage V_{REF} which is typically set to midsupply in single-supply operation. V_{REF} is often connected to ground in split-supply applications.

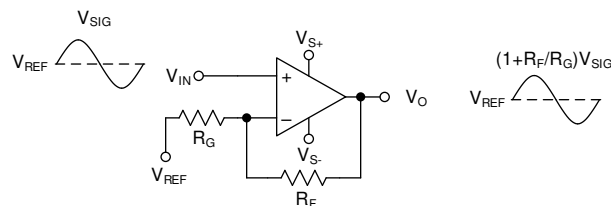

Figure 64. Noninverting Amplifier

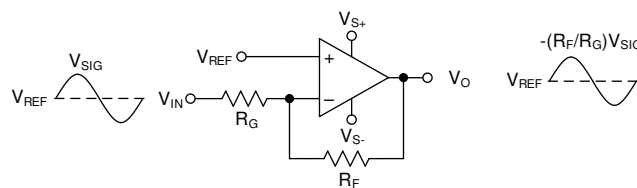

Figure 65. Inverting Amplifier

The closed-loop gain of an amplifier in noninverting configuration is shown in [Equation 1](#).

$$V_O = V_{IN} \left(1 + \frac{R_F}{R_G} \right) + V_{REF} \quad (1)$$

The closed-loop gain of an amplifier in an inverting configuration is shown in [Equation 2](#).

$$V_O = V_{IN} \left(-\frac{R_F}{R_G} \right) + V_{REF} \quad (2)$$

The magnitude of the low-frequency gain is determined by the ratio of the magnitudes of the feedback resistor (R_F) and the gain setting resistor R_G . The order of magnitudes of the individual values of R_F and R_G offer a trade-off between amplifier stability, power dissipated in the feedback resistor network, and total output noise. The feedback network increases the loading on the amplifier output. Using large values of the feedback resistors reduces the power dissipated at the amplifier output. On the other hand, this increases the inherent voltage and

Application Information (continued)

amplifier current noise contribution seen at the output while lowering the frequency at which a pole occurs in the feedback factor (β). This pole causes a decrease in the phase margin at zero-gain crossover frequency and potential instability. Using small feedback resistors increases power dissipation and also degrades amplifier linearity due to a heavier amplifier output load. Figure 66 shows a representative schematic of the OPA2810 in an inverting configuration with the input capacitors shown.

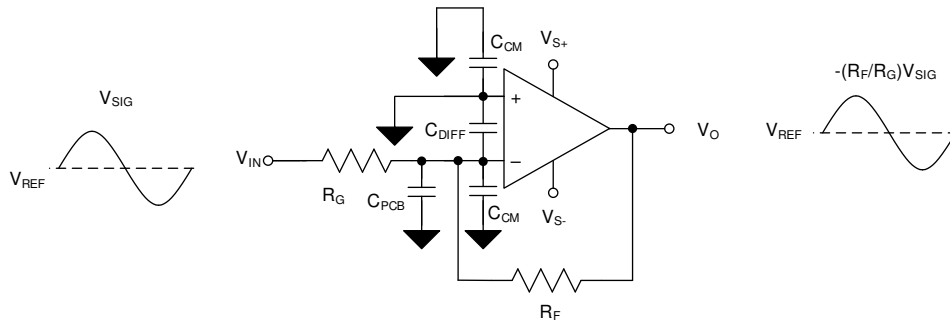

Figure 66. Inverting Amplifier with Input Capacitors

The effective capacitance seen at the amplifier's inverting input pin is shown in Equation 3 which forms a pole in β at a cut-off frequency of Equation 4.

$$C_{IN} = C_{CM} + C_{DIFF} + C_{PCB} \quad (3)$$

$$F_C = \frac{1}{2\pi R_F C_{IN}} \quad (4)$$

where:

- C_{CM} is the amplifier common-mode input capacitance
- C_{DIFF} is the amplifier differential input capacitance
- and, C_{PCB} is the PCB parasitic capacitance.

For low-power systems, greater the values of the feedback resistors, the earlier in frequency does the phase margin begin to reduce and cause instability. Figure 67 and Figure 68 illustrate the loop gain magnitude and phase plots, respectively, for the OPA2810 simulation in TINA-TI configured as an inverting amplifier with values of feedback resistors varying by orders of magnitudes.

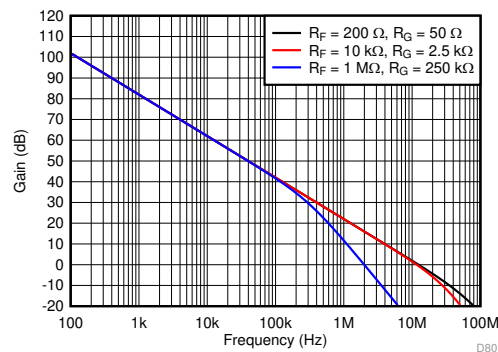

Figure 67. Loop-Gain vs. Frequency for Circuit of Figure 66

Application Information (continued)

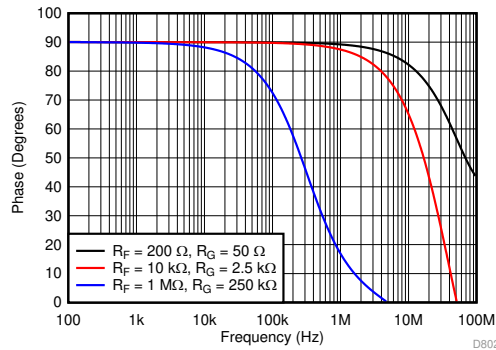

Figure 68. Loop-Gain Phase vs. Frequency for Circuit of Figure 66

A lower phase margin results in peaking in the frequency response and lower bandwidth as Figure 69 shows, which is synonymous with overshoot and ringing in the pulse response results. The OPA2810 offers a flat-band voltage noise density of 6 nV/√Hz. TI recommends selecting an R_F so the voltage noise contribution does not exceed that of the amplifier. Figure 70 shows the voltage noise density variation with value of resistance at 25°C. A 2-kΩ resistor exhibits a thermal noise density of 5.75 nV/√Hz which is comparable to the flatband noise of the OPA2810. Hence, TI recommends using an R_F lower than 2 kΩ while being large enough to not dissipate excessive power for the output voltage swing and supply current requirements of the application. The [Noise Analysis and the Effect of Resistor Elements on Total Noise](#) section shows a detailed analysis of the various contributors to noise.

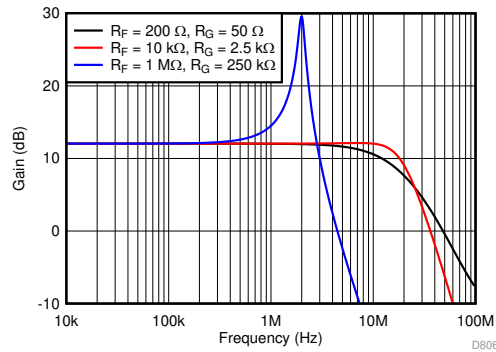

Figure 69. Closed-Loop Gain vs. Frequency for Circuit of Figure 66

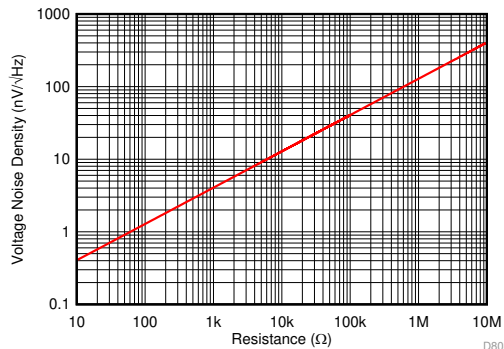

Figure 70. Thermal Noise Density vs Resistance

Application Information (continued)

9.1.2 Noise Analysis and the Effect of Resistor Elements on Total Noise

The OPA2810 provides a low input-referred broadband noise voltage density of $6 \text{ nV}/\sqrt{\text{Hz}}$ while requiring a low 3.6-mA quiescent supply current. To take full advantage of this low input noise, careful attention to the other possible noise contributors is required. Figure 71 shows the operational amplifier noise analysis model with all the noise terms included. In this model, all the noise terms are taken to be noise voltage or current density terms in $\text{nV}/\sqrt{\text{Hz}}$ or $\text{pA}/\sqrt{\text{Hz}}$.

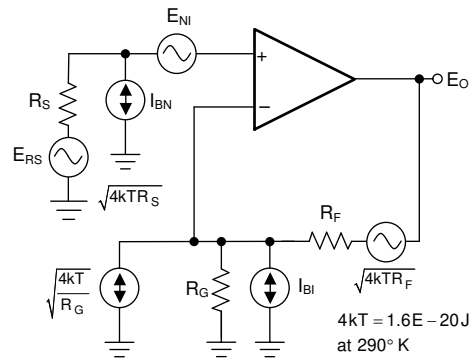

Figure 71. Operational Amplifier Noise Analysis Model

The total output spot noise voltage is computed as the square root of the squared contributing terms to the output noise voltage. This computation adds all the contributing noise powers at the output by superposition, then calculates the square root to get back to a spot noise voltage. Figure 71 shows the general form for this output noise voltage using the terms shown in Equation 5.

$$E_O = \sqrt{\left(E_{NI}^2 + (I_{BN}R_S)^2 + 4kTR_S\right)NG^2 + \left(I_{BI}R_F\right)^2 + 4kTR_FNG} \quad (5)$$

Dividing this expression by the noise gain ($NG = 1 + R_F / R_G$) shows the equivalent input referred spot noise voltage at the noninverting input; see Equation 6.

$$E_N = \sqrt{E_{NI}^2 + (I_{BN}R_S)^2 + 4kTR_S + \left(\frac{I_{BI}R_F}{NG}\right)^2 + \frac{4kTR_F}{NG}} \quad (6)$$

Substituting large resistor values into Equation 6 can quickly dominate the total equivalent input referred noise. A source impedance on the noninverting input of $2\text{-k}\Omega$ adds a Johnson voltage noise term equal to that of the amplifier ($6 \text{ nV}/\sqrt{\text{Hz}}$).

Table 1 compares the noise contributions from the various terms when the OPA2810 is configured in a noninverting gain of $5V/V$ as Figure 72 shows. Two cases are considered where the resistor values in case 2 are $10\times$ the resistor values in case 1. The total output noise in case 1 is $31.3 \text{ nV}/\sqrt{\text{Hz}}$ while the noise in case 2 is $49.7 \text{ nV}/\sqrt{\text{Hz}}$. The large value resistors in case 2 dilute the benefits of selecting a low noise amplifier like the OPA2810. To minimize total system noise, reduce the size of the resistor values. This increases the amplifiers output load and results in a degradation of distortion performance. The increased loading increases the dynamic power consumption of the amplifier. The circuit designer must make the appropriate tradeoffs to maximize the overall performance of the amplifier to match the system requirements.

Application Information (continued)

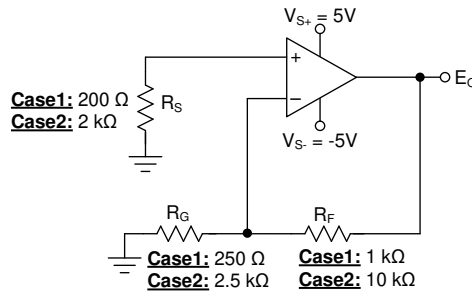

Figure 72. Comparing Noise Contributors for Two Cases With the Amplifier in a Noninverting Gain of 5 V/V

Table 1. Comparing Noise Contributions for the Circuit in Figure 72

Noise Source	Output Noise Equation	Case 1				Case 2			
		Noise Source Value	Voltage Noise Contribution (nV/√Hz)	Noise Power Contribution (nV ² /Hz)	Contribution (%)	Noise Source Value	Voltage Noise Contribution (nV/√Hz)	Noise Power Contribution (nV ² /Hz)	Contribution (%)
Source resistor, R_S	$E_{RS} (1+R_F/R_G)$	$1.82 \text{ nV}/\sqrt{\text{Hz}}$	9.1	82.81	7.77	$5.76 \text{ nV}/\sqrt{\text{Hz}}$	28.8	829.44	32.41
Gain resistor, R_G	$E_{RG} (R_F/R_G)$	$2.04 \text{ nV}/\sqrt{\text{Hz}}$	8.16	66.59	6.24	$6.44 \text{ nV}/\sqrt{\text{Hz}}$	25.76	663.58	25.93
Feedback resistor, R_F	E_{RF}	$4.07 \text{ nV}/\sqrt{\text{Hz}}$	4.07	16.57	1.55	$12.87 \text{ nV}/\sqrt{\text{Hz}}$	12.87	165.64	6.47
Amplifier voltage noise, E_{NI}	$E_{NI} (1+R_F/R_G)$	$6 \text{ nV}/\sqrt{\text{Hz}}$	30	900	84.43	$6 \text{ nV}/\sqrt{\text{Hz}}$	30	900	35.17
Inverting current noise, I_{BI}	$I_{BI} (R_F R_G)$	$5 \text{ fA}/\sqrt{\text{Hz}}$	5.0E-3	—	—	$5 \text{ fA}/\sqrt{\text{Hz}}$	50E-3	—	—
Noninverting current noise, I_{BN}	$I_{BN} R_S (1+R_F/R_G)$	$5 \text{ fA}/\sqrt{\text{Hz}}$	1.0E-3	—	—	$5 \text{ fA}/\sqrt{\text{Hz}}$	10E-3	—	—

9.2 Typical Applications

9.2.1 Transimpedance Amplifier

The high GBWP and low input voltage and current noise for the OPA2810 make it an ideal wideband transimpedance amplifier for moderate to high transimpedance gains.

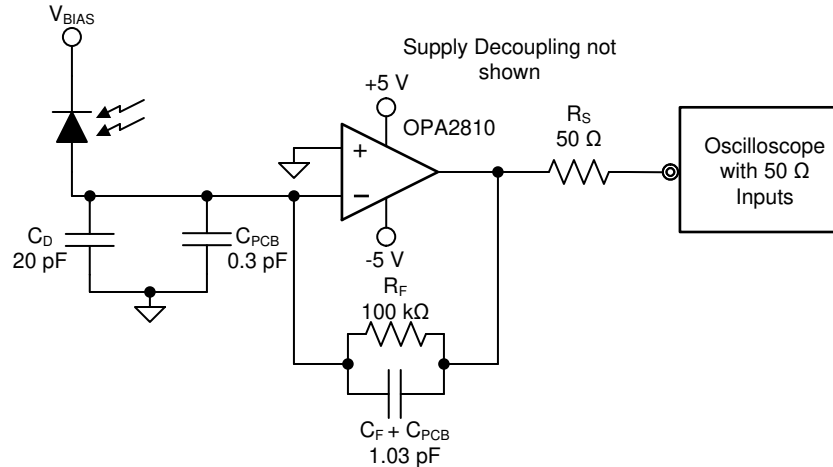

Figure 73. Wideband, High-Sensitivity, Transimpedance Amplifier

9.2.1.1 Design Requirements

Design a high-bandwidth, high-gain transimpedance amplifier with the design requirements listed in [Table 2](#).

Table 2. Design Requirements

TARGET BANDWIDTH (MHz)	TRANSIMPEDANCE GAIN (KΩ)	PHOTODIODE CAPACITANCE (pF)
> 2	100	20

9.2.1.2 Detailed Design Procedure

Designs that require high bandwidth from a large area detector with relatively high transimpedance gain benefit from the low input voltage noise of the OPA2810. This input voltage noise is peaked up over frequency by the diode source capacitance, and can, in many cases, become the limiting factor to input sensitivity. The key elements to the design are the expected diode capacitance (C_D) with the reverse bias voltage (V_{BIAS}) applied, the desired transimpedance gain, R_F , and the GBWP for the OPA2810 (70 MHz). [Figure 73](#) shows a transimpedance circuit with the parameters as described in [Table 2](#). With these three variables set (and including the parasitic input capacitance for the OPA2810 and the PCB added to C_D), the feedback capacitor value (C_F) may be set to control the frequency response. [Transimpedance Considerations for High-Speed Amplifiers application report](#) discusses using high-speed amplifiers for transimpedance applications. To achieve a maximally-flat second-order Butterworth frequency response, set the feedback pole to:

$$\frac{1}{2\pi R_F C_F} = \sqrt{\frac{GBWP}{4\pi R_F C_D}} \quad (7)$$

The input capacitance of the amplifier is the sum of the common-mode and differential capacitance (2.5 + 0.5) pF. The parasitic capacitance from the photodiode package and the PCB is approximately 0.3 pF. Using [Equation 3](#), this results in a total input capacitance of $C_D = 23.3$ pF. From [Equation 7](#), set the feedback pole at 1.55 MHz. Setting the pole at 1.55 MHz requires a total feedback capacitance of 1.03 pF.

The approximate –3-dB bandwidth of the transimpedance amplifier circuit is shown in:

$$f_{-3dB} = \sqrt{GBWP / (2\pi R_F C_D)} Hz \quad (8)$$

Equation 8 estimates a closed-loop bandwidth of 2.19 MHz. Figure 74 and Figure 75 show the loop-gain magnitude and phase plots from the TINA-TI simulations of the transimpedance amplifier circuit of Figure 73. The $1/\beta$ gain curve has a zero from R_F and C_{IN} at 70 kHz and a pole from R_F and C_F cancelling the $1/\beta$ zero at 1.5 MHz resulting in a 20 dB/decade rate-of-closure at the loop gain crossover frequency (frequency where $A_{OL} = 1/\beta$), ensuring a stable circuit. A phase margin of 62° is obtained with a closed-loop bandwidth of 3 MHz and a 100-k Ω transimpedance gain.

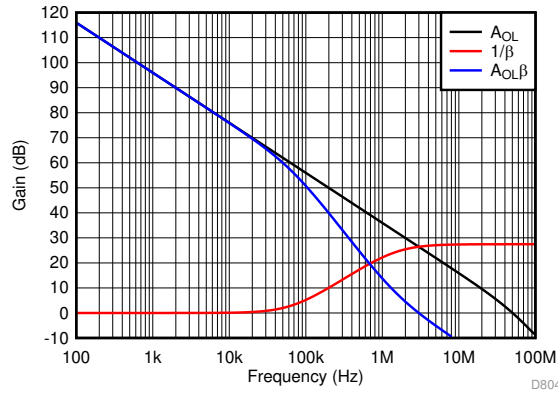

Figure 74. Loop-Gain Magnitude vs Frequency for Transimpedance Amplifier Circuit of Figure 73

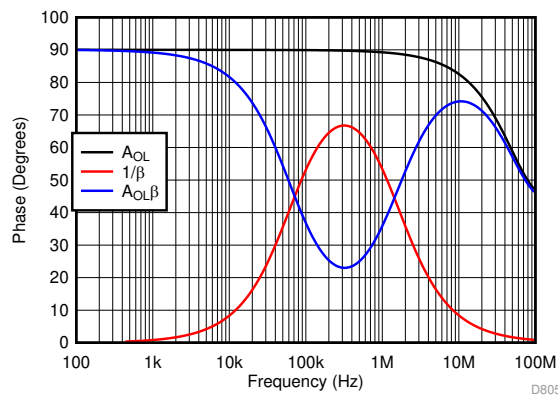

Figure 75. Loop-Gain Phase vs Frequency for Transimpedance Amplifier Circuit of Figure 73

9.2.2 Multichannel Sensor Interface

High-Z input amplifiers are particularly useful when interfaced with sensors that have relatively high output impedance. Such multichannel systems usually interface these sensors with the signal chain through a multiplexer. **Figure 76** shows one such implementation using an amplifier for interface with each sensor, and driving into an ADC through a multiplexer. An alternate circuit, shown in **Figure 77**, may use a single higher GBWP and fast-settling amplifier at the output of the multiplexer. This gives rise to large signal transients when switching between channels, where the settling performance of the amplifier and maximum allowed differential input voltage limits signal chain performance and amplifier reliability, respectively.

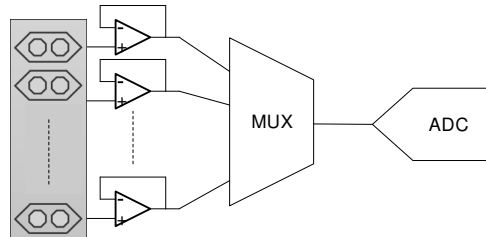

Figure 76. Multichannel Sensor Interface Using Multiple Amplifiers

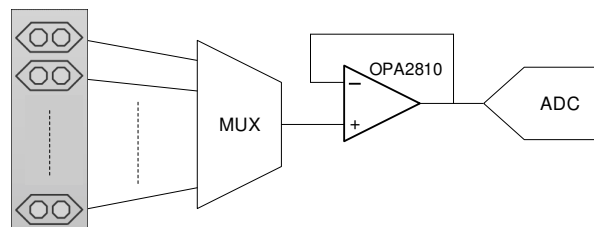
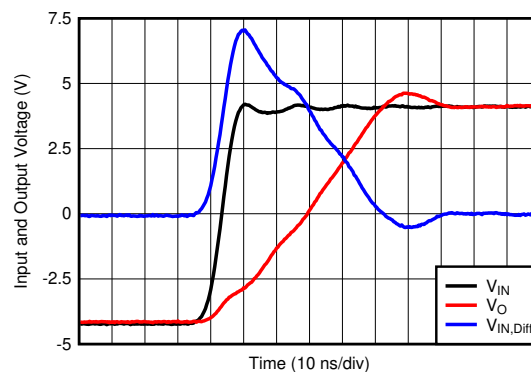

Figure 77. Multichannel Sensor Interface Using a Single Higher GBWP Amplifier

Figure 78 shows the output voltage and input differential voltage when a 8-V step is applied at the noninverting terminal of the OPA2810 configured as a unity-gain buffer of **Figure 77**.



BD_M

Figure 78. Large-Signal Transient Response Using OPA2810

Because of the fast input transient, the amplifier is slew-limited and the inputs cease to track each other (a maximum $V_{IN,Diff}$ of 7V is seen in **Figure 78**) until the output reaches its final value and the negative feedback loop is closed. For standard amplifiers with a 0.7-1.5V maximum $V_{IN,Diff}$ rating, it is required to use current-limiting resistors in series with the input pins to protect from irreversible damage, which also limits the device frequency response. The OPA2810 has built-in input clamps that allow the application of as much as 7V of $V_{IN,Diff}$, with no external resistors required and no damage to the device or a shift in performance specifications. Such an input-stage architecture coupled, with its fast settling performance, makes the OPA2810 a good fit for multichannel sensor multiplexed systems.

10 Power Supply Recommendations

The OPA2810 is intended for operation on supplies ranging from 4.75 V to 27 V. The OPA2810 may be operated on single-sided supplies, split and balanced bipolar supplies or unbalanced bipolar supplies. Operating from a single supply can have numerous advantages. With the negative supply at ground, the DC errors due to the $-PSRR$ term can be minimized. Typically, AC performance improves slightly at 10-V operation with minimal increase in supply current. Minimize the distance (< 0.1 ") from the power supply pins to high-frequency, 0.01- μ F decoupling capacitors. A larger capacitor (2.2 μ F typical) is used along with a high-frequency, 0.01- μ F supply-decoupling capacitor at the device supply pins. For single-supply operation, only the positive supply has these capacitors. When a split-supply is used, use these capacitors from each supply to ground. If necessary, place the larger capacitors further from the device and share these capacitors among several devices in the same area of the printed circuit board (PCB). An optional supply decoupling capacitor across the two power supplies (for split-supply operation) reduces second harmonic distortion.

11 Layout

11.1 Layout Guidelines

Achieving optimum performance with a high-frequency amplifier like the OPA2810 requires careful attention to board layout parasitics and external component types. The [OPA2810EVM](#) can be used as a reference when designing the circuit board. Recommendations that optimize performance include:

1. **Minimize parasitic capacitance** to any AC ground for all of the signal I/O pins. Parasitic capacitance on the output and inverting input pins can cause instability—on the noninverting input, it can react with the source impedance to cause unintentional band-limiting. To reduce unwanted capacitance, open a window around the signal I/O pins in all of the ground and power planes around those pins. Otherwise, ground and power planes must be unbroken elsewhere on the board.
2. **Minimize the distance** (< 0.1 ") from the power-supply pins to high-frequency 0.01- μ F decoupling capacitors. At the device pins, do not allow the ground and power plane layout to be in close proximity to the signal I/O pins. Avoid narrow power and ground traces to minimize inductance between the pins and the decoupling capacitors. The power-supply connections must always be decoupled with these capacitors. Larger (2.2- μ F to 6.8- μ F) decoupling capacitors, effective at lower frequency, must also be used on the supply pins. These can be placed somewhat farther from the device and shared among several devices in the same area of the PC board.
3. **Careful selection and placement of external components preserve the high frequency performance of the OPA2810.** Resistors must be a low reactance type. Surface-mount resistors work best and allow a tighter overall layout. Metal film and carbon composition axially leaded resistors can also provide good high frequency performance. Again, keep their leads and PCB trace length as short as possible. Never use wirewound type resistors in a high frequency application. Because the output pin and inverting input pin are the most sensitive to parasitic capacitance, always position the feedback and series output resistor, if any, as close as possible to the output pin. Other network components, such as noninverting input termination resistors, must also be placed close to the package. Even with a low parasitic capacitance shunting the external resistors, excessively high resistor values can create significant time constants that can degrade performance. Good axial metal film or surface mount resistors have approximately 0.2 pF in shunt with the resistor. For resistor values > 10 k Ω , this parasitic capacitance can add a pole or zero close to the GBWP of 70 MHz and subsequently affects circuit operation. Keep resistor values as low as possible consistent with load driving considerations. Lowering the resistor values keep the resistor noise terms low, and minimize the effect of its parasitic capacitance, however lower resistor values increase the dynamic power consumption because R_F and R_G become part of the amplifiers output load network. Transimpedance applications (see the [Transimpedance Amplifier](#) section) can use whatever feedback resistor is required by the application as long as the feedback compensation capacitor is set considering all parasitic capacitance terms on the inverting node.
4. **Connections to other wideband devices** on the board may be made with short direct traces or through onboard transmission lines. For short connections, consider the trace and the input to the next device as a lumped capacitive load. Relatively wide traces (50 mils to 100 mils) must be used, preferably with ground and power planes opened up around them. Estimate the total capacitive load and set R_S for sufficient phase margin and stability. Low parasitic capacitive loads (< 35 pF) may not need an R_S because the OPA2810 is nominally compensated to operate with a 35-pF parasitic load. Higher parasitic capacitive loads without an R_S are allowed as the signal gain increases (increasing the unloaded phase margin) If a long trace is

Layout Guidelines (continued)

required, and the 6-dB signal loss intrinsic to a doubly-terminated transmission line is acceptable, implement a matched impedance transmission line using microstrip or stripline techniques (consult an ECL design handbook for microstrip and stripline layout techniques). A 50-Ω environment is normally not necessary onboard, and a higher impedance environment improves distortion. With a characteristic board trace impedance defined based on board material and trace dimensions, a matching series resistor into the trace from the output of the OPA2810 is used as well as a terminating shunt resistor at the input of the destination device. Remember also that the terminating impedance is the parallel combination of the shunt resistor and the input impedance of the destination device— this total effective impedance must be set to match the trace impedance. If the 6-dB attenuation of a doubly-terminated transmission line is unacceptable, a long trace can be series-terminated at the source end only. Treat the trace as a capacitive load in this case and set the series resistor value to obtain sufficient phase margin and stability. This does not preserve signal integrity as well as a doubly-terminated line. If the input impedance of the destination device is low, the signal attenuates because of the voltage divider formed by the series output into the terminating impedance.

5. **Take care to design the PCB layout for optimal thermal dissipation.** For the extreme case of 125°C operating ambient, using the approximate maximum 177.2°C/W for the two packages, and an internal power of 24-V supply × 9-mA 125°C supply current (both amplifiers) gives a maximum internal power dissipation of 216 mW. This power gives a 38°C increase from ambient to junction temperature. Load power adds to this value and this dissipation must also be calculated to determine the worst-case safe operating point.
6. **Socketing a high speed part like the OPA2810 is not recommended.** The additional lead length and pin-to-pin capacitance introduced by the socket can create an extremely troublesome parasitic network which can make it almost impossible to achieve a smooth, stable frequency response. Best results are obtained by soldering the OPA2810 onto the board.

11.1.1 Thermal Considerations

The OPA2810 does not require heat sinking or airflow in most applications. Maximum allowed junction temperature sets the maximum allowed internal power dissipation. Do not allow the maximum junction temperature to exceed 150°C.

Operating junction temperature (T_J) is given by $T_A + P_D \times \theta_{JA}$. The total internal power dissipation (P_D) is the sum of quiescent power (P_{DQ}) and additional power dissipated in the output stage (P_{DL}) to deliver load power. Quiescent power is the specified no-load supply current times the total supply voltage across the part. P_{DL} depends on the required output signal and load but would, for a grounded resistive load, be at a maximum when the output is fixed at a voltage equal to half of either supply voltage (for equal split-supplies). Under this condition $P_{DL} = V_S^2 / (4 \times R_L)$ where R_L includes feedback network loading.

The power in the output stage and not into the load that determines internal power dissipation.

As a worst-case example, compute the maximum T_J using an OPA2810-DGK (VSSOP package) configured as a unity gain buffer, operating on ±12-V supplies at an ambient temperature of 25°C and driving a grounded 500-Ω load.

$$P_D = 24 \text{ V} \times 9 \text{ mA} + 12^2 / (4 \times 500 \text{ } \Omega) = 288 \text{ mW}$$

$$\text{Maximum } T_J = 25^\circ\text{C} + (0.288 \text{ W} \times 177.2^\circ\text{C/W}) = 76^\circ\text{C}, \text{ which is well below the maximum allowed junction temperature of } 150^\circ\text{C}.$$

11.2 Layout Example

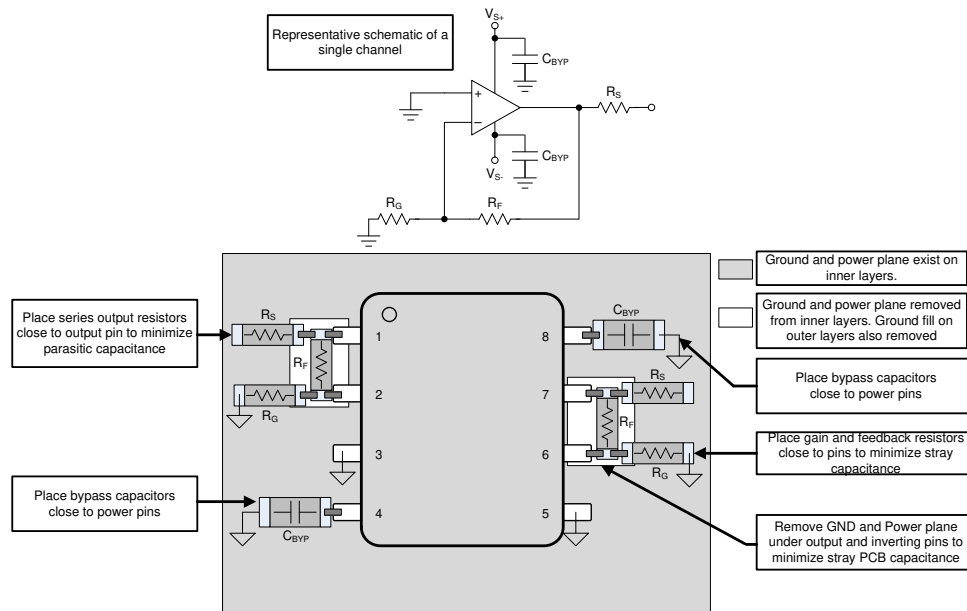

Figure 79. Layout Recommendation

12 Device and Documentation Support

12.1 Documentation Support

12.1.1 Related Documentation

For related documentation see the following:

- Texas Instruments, [OPA2810DGK Evaluation Module user's guide](#)
- Texas Instruments, [OPA810 140-MHz, Rail-to-Rail Input/Output, FET-Input Operational Amplifier data sheet](#)
- Texas Instruments, [Single-Supply Op Amp Design Techniques application report](#)
- Texas Instruments, [Transimpedance Considerations for High-Speed Amplifiers application report](#)
- Texas Instruments, [Blog: What you need to know about transimpedance amplifiers – part 1](#)
- Texas Instruments, [Blog: What you need to know about transimpedance amplifiers – part 2](#)
- Texas Instruments, [Noise Analysis for High-Speed Op Amps application report](#)
- Texas Instruments, [TINA model and simulation tool](#)

12.2 Receiving Notification of Documentation Updates

To receive notification of documentation updates, navigate to the device [product folder](#) on ti.com. In the upper right corner, click on *Alert me* to register and receive a weekly digest of any product information that has changed. For change details, review the revision history included in any revised document.

12.3 Community Resources

[TI E2E™ support forums](#) are an engineer's go-to source for fast, verified answers and design help — straight from the experts. Search existing answers or ask your own question to get the quick design help you need.

Linked content is provided "AS IS" by the respective contributors. They do not constitute TI specifications and do not necessarily reflect TI's views; see TI's [Terms of Use](#).

12.4 Trademarks

E2E is a trademark of Texas Instruments.

All other trademarks are the property of their respective owners.

12.5 Electrostatic Discharge Caution



This integrated circuit can be damaged by ESD. Texas Instruments recommends that all integrated circuits be handled with appropriate precautions. Failure to observe proper handling and installation procedures can cause damage.

ESD damage can range from subtle performance degradation to complete device failure. Precision integrated circuits may be more susceptible to damage because very small parametric changes could cause the device not to meet its published specifications.

12.6 Glossary

[SLYZ022](#) — *TI Glossary*.

This glossary lists and explains terms, acronyms, and definitions.

13 Mechanical, Packaging, and Orderable Information

The following pages include mechanical, packaging, and orderable information. This information is the most current data available for the designated devices. This data is subject to change without notice and revision of this document. For browser-based versions of this data sheet, refer to the left-hand navigation.

PACKAGING INFORMATION

Orderable Device	Status (1)	Package Type	Package Drawing	Pins	Package Qty	Eco Plan (2)	Lead finish/ Ball material (6)	MSL Peak Temp (3)	Op Temp (°C)	Device Marking (4/5)	Samples
OPA2810IDCNR	ACTIVE	SOT-23	DCN	8	3000	RoHS & Green	NIPDAU	Level-2-260C-1 YEAR	-40 to 125	2810	Samples
OPA2810IDCNT	ACTIVE	SOT-23	DCN	8	250	RoHS & Green	NIPDAU	Level-2-260C-1 YEAR	-40 to 125	2810	Samples
OPA2810IDGKR	ACTIVE	VSSOP	DGK	8	2500	RoHS & Green	NIPDAUAG	Level-2-260C-1 YEAR	-40 to 125	2810	Samples
OPA2810IDGKT	ACTIVE	VSSOP	DGK	8	250	RoHS & Green	NIPDAUAG SN	Level-2-260C-1 YEAR	-40 to 125	2810	Samples
OPA2810IDR	ACTIVE	SOIC	D	8	2500	RoHS & Green	NIPDAU	Level-2-260C-1 YEAR	-40 to 125	O2810	Samples
OPA2810IDT	ACTIVE	SOIC	D	8	250	RoHS & Green	NIPDAU	Level-2-260C-1 YEAR	-40 to 125	O2810	Samples

(1) The marketing status values are defined as follows:

ACTIVE: Product device recommended for new designs.

LIFEBUY: TI has announced that the device will be discontinued, and a lifetime-buy period is in effect.

NRND: Not recommended for new designs. Device is in production to support existing customers, but TI does not recommend using this part in a new design.

PREVIEW: Device has been announced but is not in production. Samples may or may not be available.

OBSOLETE: TI has discontinued the production of the device.

(2) **RoHS:** TI defines "RoHS" to mean semiconductor products that are compliant with the current EU RoHS requirements for all 10 RoHS substances, including the requirement that RoHS substance do not exceed 0.1% by weight in homogeneous materials. Where designed to be soldered at high temperatures, "RoHS" products are suitable for use in specified lead-free processes. TI may reference these types of products as "Pb-Free".

RoHS Exempt: TI defines "RoHS Exempt" to mean products that contain lead but are compliant with EU RoHS pursuant to a specific EU RoHS exemption.

Green: TI defines "Green" to mean the content of Chlorine (Cl) and Bromine (Br) based flame retardants meet JS709B low halogen requirements of <=1000ppm threshold. Antimony trioxide based flame retardants must also meet the <=1000ppm threshold requirement.

(3) MSL, Peak Temp. - The Moisture Sensitivity Level rating according to the JEDEC industry standard classifications, and peak solder temperature.

(4) There may be additional marking, which relates to the logo, the lot trace code information, or the environmental category on the device.

(5) Multiple Device Markings will be inside parentheses. Only one Device Marking contained in parentheses and separated by a "~" will appear on a device. If a line is indented then it is a continuation of the previous line and the two combined represent the entire Device Marking for that device.

(6) Lead finish/Ball material - Orderable Devices may have multiple material finish options. Finish options are separated by a vertical ruled line. Lead finish/Ball material values may wrap to two lines if the finish value exceeds the maximum column width.

Important Information and Disclaimer: The information provided on this page represents TI's knowledge and belief as of the date that it is provided. TI bases its knowledge and belief on information provided by third parties, and makes no representation or warranty as to the accuracy of such information. Efforts are underway to better integrate information from third parties. TI has taken and continues to take reasonable steps to provide representative and accurate information but may not have conducted destructive testing or chemical analysis on incoming materials and chemicals. TI and TI suppliers consider certain information to be proprietary, and thus CAS numbers and other limited information may not be available for release.

In no event shall TI's liability arising out of such information exceed the total purchase price of the TI part(s) at issue in this document sold by TI to Customer on an annual basis.

TAPE AND REEL INFORMATION

QUADRANT ASSIGNMENTS FOR PIN 1 ORIENTATION IN TAPE

*All dimensions are nominal

Device	Package Type	Package Drawing	Pins	SPQ	Reel Diameter (mm)	Reel Width W1 (mm)	A0 (mm)	B0 (mm)	K0 (mm)	P1 (mm)	W (mm)	Pin1 Quadrant
OPA2810DCNR	SOT-23	DCN	8	3000	180.0	8.4	3.23	3.17	1.37	4.0	8.0	Q3
OPA2810DCNT	SOT-23	DCN	8	250	180.0	8.4	3.23	3.17	1.37	4.0	8.0	Q3
OPA2810DGKR	VSSOP	DGK	8	2500	330.0	12.4	5.3	3.4	1.4	8.0	12.0	Q1
OPA2810DGKT	VSSOP	DGK	8	250	330.0	12.4	5.3	3.4	1.4	8.0	12.0	Q1
OPA2810DGKT	VSSOP	DGK	8	250	330.0	12.4	5.25	3.35	1.25	8.0	12.0	Q1
OPA2810IDR	SOIC	D	8	2500	330.0	12.4	6.4	5.2	2.1	8.0	12.0	Q1
OPA2810IDT	SOIC	D	8	250	180.0	12.4	6.4	5.2	2.1	8.0	12.0	Q1

TAPE AND REEL BOX DIMENSIONS

*All dimensions are nominal

Device	Package Type	Package Drawing	Pins	SPQ	Length (mm)	Width (mm)	Height (mm)
OPA2810IDCNR	SOT-23	DCN	8	3000	213.0	191.0	35.0
OPA2810IDCNT	SOT-23	DCN	8	250	213.0	191.0	35.0
OPA2810IDGKR	VSSOP	DGK	8	2500	366.0	364.0	50.0
OPA2810IDGKT	VSSOP	DGK	8	250	366.0	364.0	50.0
OPA2810IDGKT	VSSOP	DGK	8	250	366.0	364.0	50.0
OPA2810IDR	SOIC	D	8	2500	356.0	356.0	35.0
OPA2810IDT	SOIC	D	8	250	210.0	185.0	35.0



D0008A

PACKAGE OUTLINE

SOIC - 1.75 mm max height

SMALL OUTLINE INTEGRATED CIRCUIT



4214825/C 02/2019

NOTES:

- Linear dimensions are in inches [millimeters]. Dimensions in parenthesis are for reference only. Controlling dimensions are in inches. Dimensioning and tolerancing per ASME Y14.5M.
- This drawing is subject to change without notice.
- This dimension does not include mold flash, protrusions, or gate burrs. Mold flash, protrusions, or gate burrs shall not exceed $.006$ [0.15] per side.
- This dimension does not include interlead flash.
- Reference JEDEC registration MS-012, variation AA.

EXAMPLE BOARD LAYOUT

D0008A

SOIC - 1.75 mm max height

SMALL OUTLINE INTEGRATED CIRCUIT



LAND PATTERN EXAMPLE
 EXPOSED METAL SHOWN
 SCALE:8X



SOLDER MASK DETAILS

4214825/C 02/2019

NOTES: (continued)

- 6. Publication IPC-7351 may have alternate designs.
- 7. Solder mask tolerances between and around signal pads can vary based on board fabrication site.

EXAMPLE STENCIL DESIGN

D0008A

SOIC - 1.75 mm max height

SMALL OUTLINE INTEGRATED CIRCUIT



SOLDER PASTE EXAMPLE
BASED ON .005 INCH [0.125 MM] THICK STENCIL
SCALE:8X

4214825/C 02/2019

NOTES: (continued)

8. Laser cutting apertures with trapezoidal walls and rounded corners may offer better paste release. IPC-7525 may have alternate design recommendations.
9. Board assembly site may have different recommendations for stencil design.

DGK0008A



PACKAGE OUTLINE

VSSOP - 1.1 mm max height

SMALL OUTLINE PACKAGE



NOTES:

PowerPAD is a trademark of Texas Instruments.

1. All linear dimensions are in millimeters. Any dimensions in parenthesis are for reference only. Dimensioning and tolerancing per ASME Y14.5M.
2. This drawing is subject to change without notice.
3. This dimension does not include mold flash, protrusions, or gate burrs. Mold flash, protrusions, or gate burrs shall not exceed 0.15 mm per side.
4. This dimension does not include interlead flash. Interlead flash shall not exceed 0.25 mm per side.
5. Reference JEDEC registration MO-187.

EXAMPLE BOARD LAYOUT

DGK0008A

™ VSSOP - 1.1 mm max height

SMALL OUTLINE PACKAGE



LAND PATTERN EXAMPLE
EXPOSED METAL SHOWN
SCALE: 15X

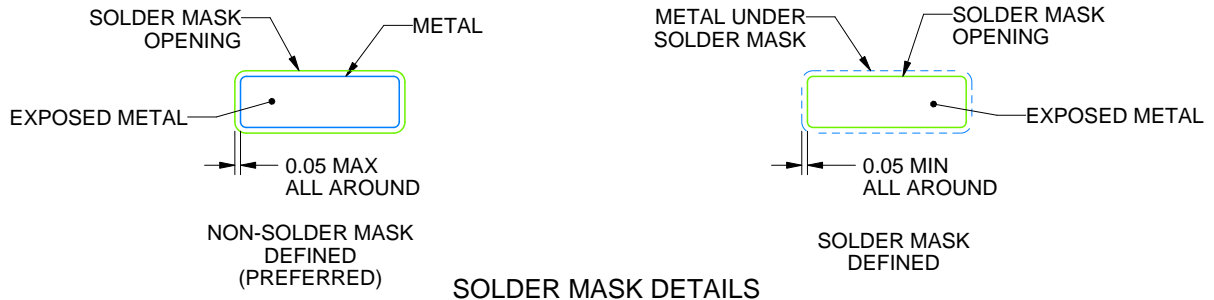

4214862/A 04/2023

NOTES: (continued)

6. Publication IPC-7351 may have alternate designs.
7. Solder mask tolerances between and around signal pads can vary based on board fabrication site.
8. Vias are optional depending on application, refer to device data sheet. If any vias are implemented, refer to their locations shown on this view. It is recommended that vias under paste be filled, plugged or tented.
9. Size of metal pad may vary due to creepage requirement.

EXAMPLE STENCIL DESIGN

DGK0008A

TM VSSOP - 1.1 mm max height

SMALL OUTLINE PACKAGE



SOLDER PASTE EXAMPLE
SCALE: 15X

4214862/A 04/2023

NOTES: (continued)

11. Laser cutting apertures with trapezoidal walls and rounded corners may offer better paste release. IPC-7525 may have alternate design recommendations.
12. Board assembly site may have different recommendations for stencil design.

DCN (R-PDSO-G8)

PLASTIC SMALL-OUTLINE PACKAGE (DIE DOWN)

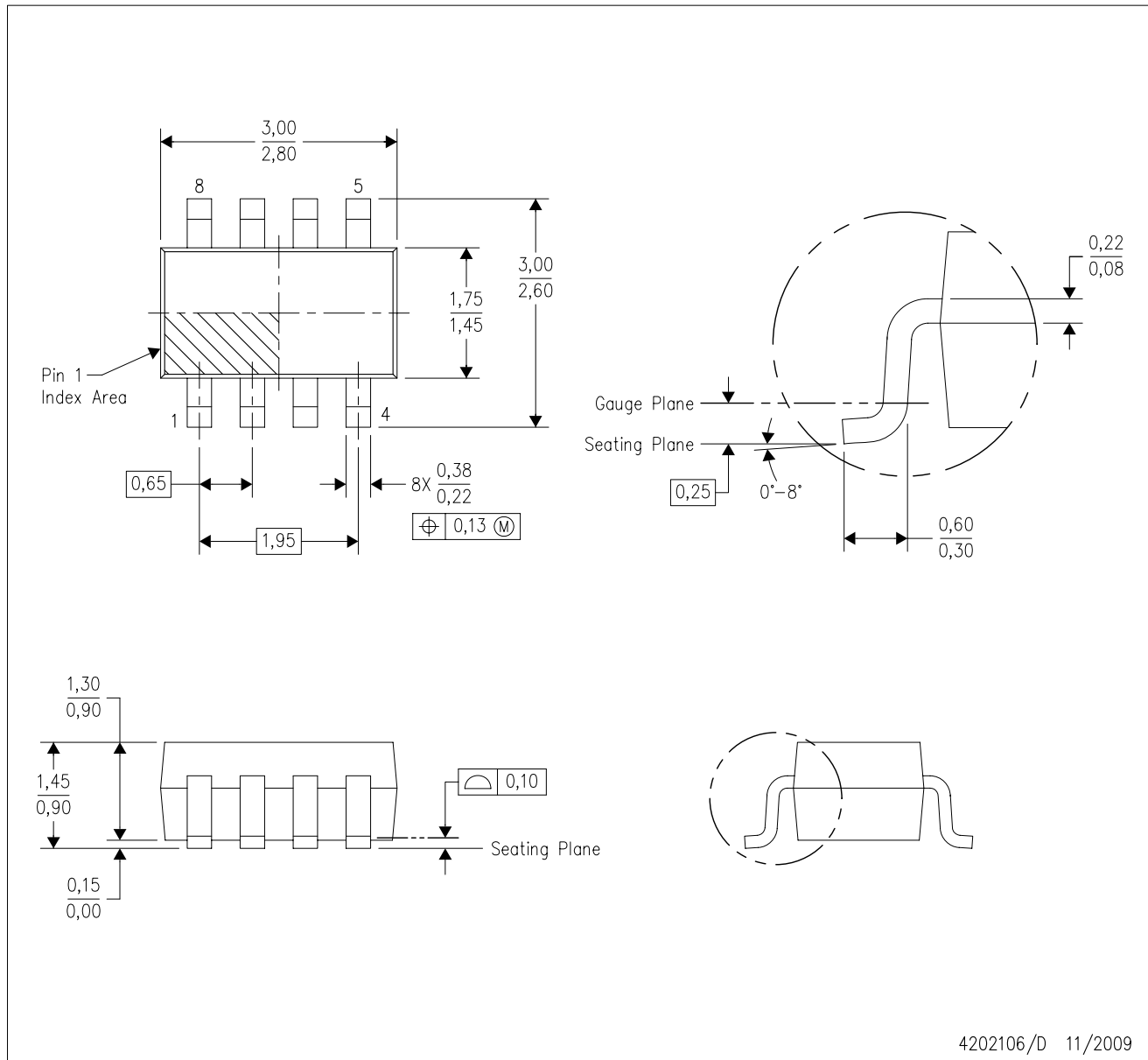

- NOTES:
- A. All linear dimensions are in millimeters.
 - B. This drawing is subject to change without notice.
 - C. Package outline exclusive of metal burr & dambar protrusion/intrusion.
 - D. Package outline inclusive of solder plating.
 - E. A visual index feature must be located within the Pin 1 index area.
 - F. Falls within JEDEC MO-178 Variation BA.
 - G. Body dimensions do not include flash or protrusion. Mold flash and protrusion shall not exceed 0.25 per side.

DCN (R-PDSO-G8)

PLASTIC SMALL-OUTLINE PACKAGE (DIE DOWN)

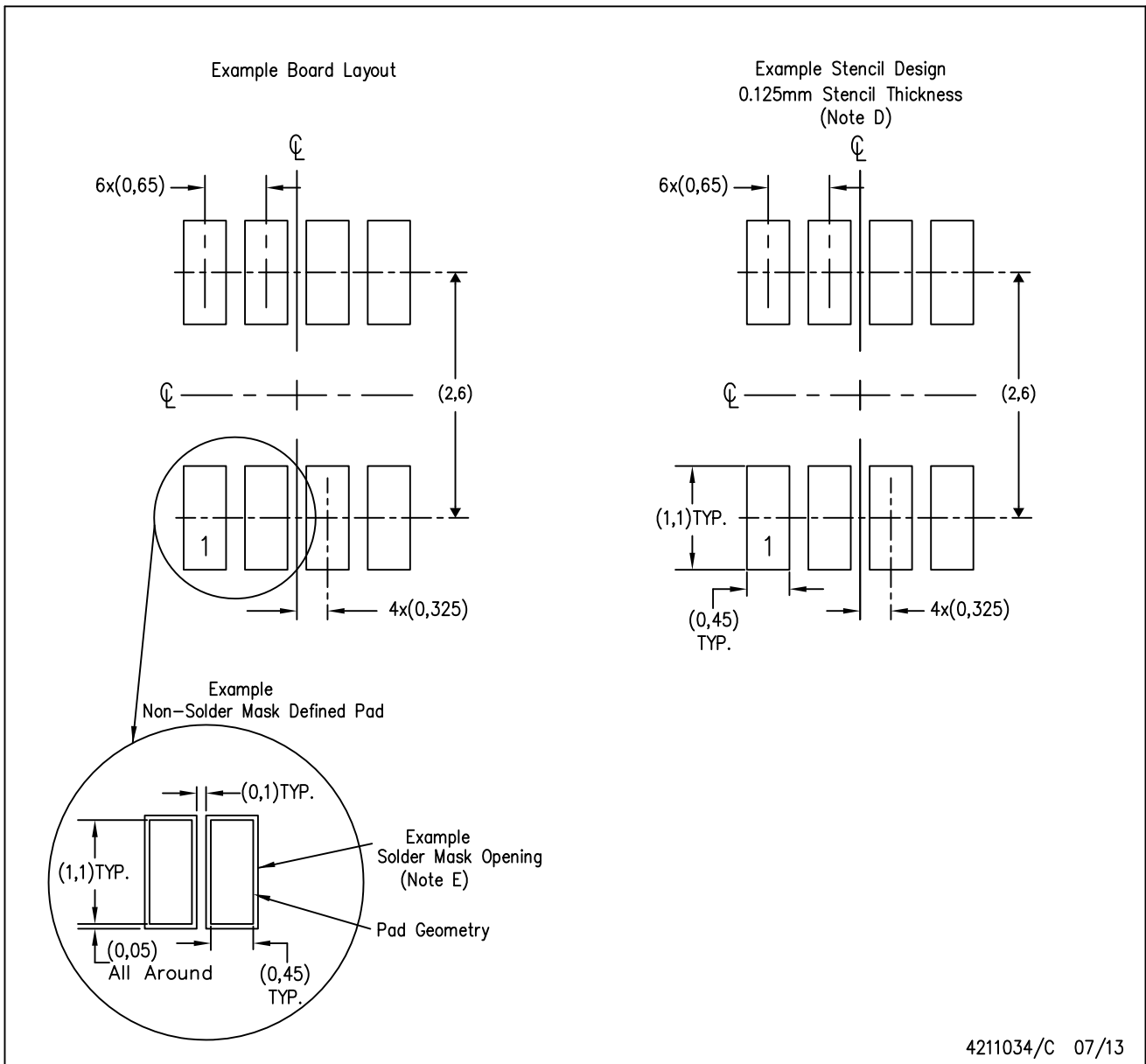

- NOTES:
- A. All linear dimensions are in millimeters.
 - B. This drawing is subject to change without notice.
 - C. Publication IPC-7351 is recommended for alternate designs.
 - D. Laser cutting apertures with trapezoidal walls and also rounding corners will offer better paste release. Customers should contact their board assembly site for stencil design recommendations. Refer to IPC-7525.
 - E. Customers should contact their board fabrication site for solder mask tolerances between and around signal pads.

IMPORTANT NOTICE AND DISCLAIMER

TI PROVIDES TECHNICAL AND RELIABILITY DATA (INCLUDING DATA SHEETS), DESIGN RESOURCES (INCLUDING REFERENCE DESIGNS), APPLICATION OR OTHER DESIGN ADVICE, WEB TOOLS, SAFETY INFORMATION, AND OTHER RESOURCES "AS IS" AND WITH ALL FAULTS, AND DISCLAIMS ALL WARRANTIES, EXPRESS AND IMPLIED, INCLUDING WITHOUT LIMITATION ANY IMPLIED WARRANTIES OF MERCHANTABILITY, FITNESS FOR A PARTICULAR PURPOSE OR NON-INFRINGEMENT OF THIRD PARTY INTELLECTUAL PROPERTY RIGHTS.

These resources are intended for skilled developers designing with TI products. You are solely responsible for (1) selecting the appropriate TI products for your application, (2) designing, validating and testing your application, and (3) ensuring your application meets applicable standards, and any other safety, security, regulatory or other requirements.

These resources are subject to change without notice. TI grants you permission to use these resources only for development of an application that uses the TI products described in the resource. Other reproduction and display of these resources is prohibited. No license is granted to any other TI intellectual property right or to any third party intellectual property right. TI disclaims responsibility for, and you will fully indemnify TI and its representatives against, any claims, damages, costs, losses, and liabilities arising out of your use of these resources.

TI's products are provided subject to [TI's Terms of Sale](#) or other applicable terms available either on [ti.com](https://www.ti.com) or provided in conjunction with such TI products. TI's provision of these resources does not expand or otherwise alter TI's applicable warranties or warranty disclaimers for TI products.

TI objects to and rejects any additional or different terms you may have proposed.

Mailing Address: Texas Instruments, Post Office Box 655303, Dallas, Texas 75265
Copyright © 2024, Texas Instruments Incorporated