

# OPA858 5.5GHz Gain Bandwidth Product, Gain of 7V/V Stable, FET Input Amplifier

## 1 Features

- High gain bandwidth product: 5.5GHz
- Decompensated, gain  $\geq 7V/V$  (stable)
- Ultra-low bias current MOSFET inputs: 10pA
- Low input voltage noise:  $2.5nV/\sqrt{Hz}$
- Slew rate: 2000V/ $\mu s$
- Low Input capacitance:
  - Common-mode: 0.6pF
  - Differential: 0.2pF
- Wide input common-mode range:
  - 1.4V from positive supply
  - Includes negative supply
- 2.5V<sub>PP</sub> output swing in TIA configuration
- Supply voltage range: 3.3V to 5.25V
- Quiescent current: 20.5mA
- Package: 8-pin WSON
- Temperature range:  $-40^{\circ}C$  to  $+125^{\circ}C$

## 2 Applications

- [Optical time domain reflectometry \(OTDR\)](#)
- [3D scanner](#)
- [Laser distance measurement](#)
- [Solid-state scanning LIDAR](#)
- [Optical ToF position sensor](#)
- [Drone vision](#)
- [Industrial robot LIDAR](#)
- [Vacuum robot LIDAR](#)
- Silicon photomultiplier (SiPM) buffer amplifier
- Photomultiplier tube post amplifier

## 3 Description

The OPA858 is a wideband, low-noise operational amplifier with CMOS inputs for wideband transimpedance and voltage amplifier applications. When the device is configured as a transimpedance amplifier (TIA), the 5.5GHz gain bandwidth product (GBWP) enables high closed-loop bandwidths at transimpedance gains in the range of tens to hundreds of kilohms.

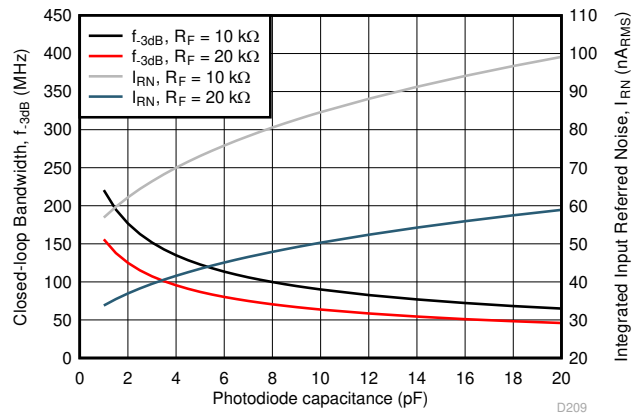
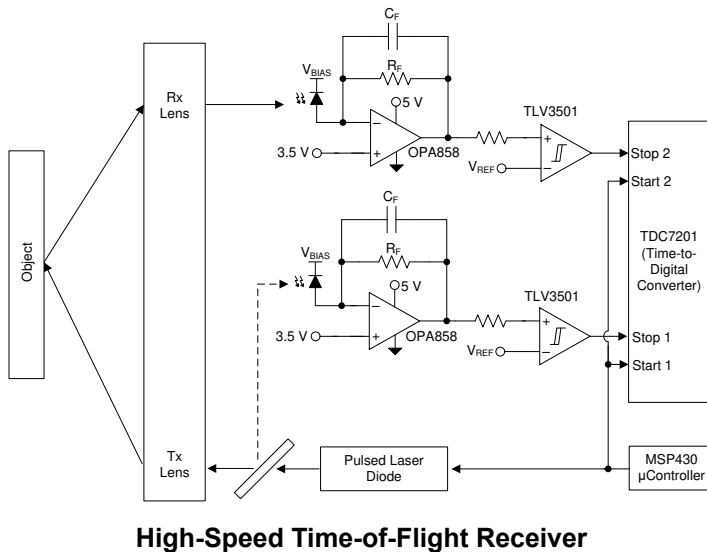
The following graph shows the bandwidth and noise performance of the OPA858 as a function of the photodiode capacitance when the amplifier is configured as a TIA. The total noise is calculated along a bandwidth range extending from dc to the calculated frequency ( $f$ ) on the left scale. The OPA858 package has a feedback pin (FB) that simplifies the feedback network connection between the input and the output.

The OPA858 is optimized to operate in optical time-of-flight (ToF) systems where the OPA858 is used with time-to-digital converters, such as the [TDC7201](#). Use the OPA858 to drive a high-speed analog-to-digital converter (ADC) in high-resolution LIDAR systems with a differential output amplifier, such as the [THS4541](#) or [LMH5401](#) devices.

### Package Information

PART NUMBER <sup>(1)</sup>	PACKAGE <sup>(2)</sup>	PACKAGE SIZE <sup>(3)</sup>
OPA858	DSG (WSON, 8)	2.00mm × 2.00mm
	Bare die	0.751mm × 0.705mm

- (1) See the [Device Comparison Table](#).
- (2) For more information, see [Section 12](#).
- (3) The package size (length × width) is a nominal value and includes pins, where applicable.



Photodiode Capacitance vs Bandwidth and Noise

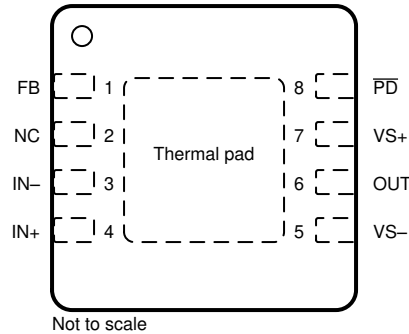
## Table of Contents

<b>1 Features</b> .....	<b>1</b>	8.4 Device Functional Modes.....	<b>20</b>
<b>2 Applications</b> .....	<b>1</b>	<b>9 Application and Implementation</b> .....	<b>21</b>
<b>3 Description</b> .....	<b>1</b>	9.1 Application Information.....	<b>21</b>
<b>4 Device Comparison Table</b> .....	<b>2</b>	9.2 Typical Applications.....	<b>22</b>
<b>5 Pin Configuration and Functions</b> .....	<b>3</b>	9.3 Power Supply Recommendations.....	<b>25</b>
<b>6 Specifications</b> .....	<b>5</b>	9.4 Layout.....	<b>26</b>
6.1 Absolute Maximum Ratings .....	<b>5</b>	<b>10 Device and Documentation Support</b> .....	<b>28</b>
6.2 ESD Ratings .....	<b>5</b>	10.1 Device Support.....	<b>28</b>
6.3 Recommended Operating Conditions .....	<b>5</b>	10.2 Documentation Support.....	<b>28</b>
6.4 Thermal Information .....	<b>5</b>	10.3 Receiving Notification of Documentation Updates..	<b>28</b>
6.5 Electrical Characteristics .....	<b>6</b>	10.4 Support Resources.....	<b>28</b>
6.6 Typical Characteristics.....	<b>8</b>	10.5 Trademarks.....	<b>28</b>
<b>7 Parameter Measurement Information</b> .....	<b>15</b>	10.6 Electrostatic Discharge Caution.....	<b>28</b>
<b>8 Detailed Description</b> .....	<b>16</b>	10.7 Glossary.....	<b>28</b>
8.1 Overview.....	<b>16</b>	<b>11 Revision History</b> .....	<b>28</b>
8.2 Functional Block Diagram.....	<b>16</b>	<b>12 Mechanical, Packaging, and Orderable Information</b> .....	<b>29</b>
8.3 Feature Description.....	<b>17</b>		

## 4 Device Comparison Table

DEVICE	INPUT TYPE	MINIMUM STABLE GAIN	VOLTAGE NOISE (nV/ $\sqrt{\text{Hz}}$ )	INPUT CAPACITANCE (pF)	GAIN BANDWIDTH (GHz)
OPA858	CMOS	7V/V	2.5	0.8	5.5
<a href="#">OPA855</a>	Bipolar	7V/V	0.98	0.8	8
<a href="#">LMH6629</a>	Bipolar	10V/V	0.69	5.7	4

## 5 Pin Configuration and Functions



**Figure 5-1. DSG Package,  
8-Pin WSON With Exposed Thermal Pad  
(Top View)**

**Table 5-1. Pin Functions**

PIN		TYPE	DESCRIPTION
NAME	NO.		
FB	1	Input	Feedback connection to output of amplifier
IN-	3	Input	Inverting input
IN+	4	Input	Noninverting input
NC	2	—	Do not connect
OUT	6	Output	Amplifier output
PD	8	Input	Power down connection. $\overline{\text{PD}}$ = logic low = power off mode; $\text{PD}$ = logic high = normal operation.
VS-	5	—	Negative voltage supply
VS+	7	—	Positive voltage supply
Thermal pad		—	Connect the thermal pad to VS-

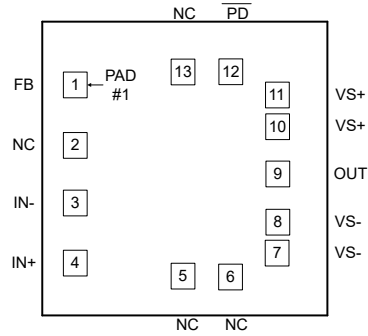


Figure 5-2. Bare Die Package

Table 5-2. Bond Pad Functions

PAD		TYPE	DESCRIPTION
NAME	NO.		
FB	1	Input	Feedback connection to output of amplifier
IN–	3	Input	Inverting input
IN+	4	Input	Noninverting input
NC	2,5,6,13	—	Do not connect
OUT	9	Output	Amplifier output
PD	12	Input	Power down connection. $\overline{PD}$ = logic low = power off mode; $\overline{PD}$ = logic high = normal operation.
VS–	7,8	—	Negative voltage supply
VS+	10,11	—	Positive voltage supply
Backside		—	Connect to VS–

Table 5-3. Bare Die Information

DIE THICKNESS	BACKSIDE FINISH	BACKSIDE POTENTIAL	BOND PAD METALLIZATION
381 $\mu\text{m}$	Silicon with backgrind	Wafer backside is electrically connected to VS–	AlCu

Table 5-4. Bond Pad Coordinates of Bare Die Version in Microns

PAD NUMBER	PAD NAME	X-MIN	Y-MIN	X-MAX	Y-MAX
1	FB	14.5	537.4	79.5	602.4
2	NC	14.5	379	79.5	444
3	IN–	14.5	227	79.5	292
4	IN+	14.5	68.6	79.5	133.6
5	NC	296.725	34.825	361.725	99.825
6	NC	421.725	34.825	486.725	99.825
7	VS–	545.5	93.8	610.5	158.8
8	VS–	545.5	178.8	610.5	243.8
9	OUT	545.5	303	610.5	368
10	VS+	545.5	427.2	610.5	492.2
11	VS+	545.5	512.2	610.5	577.2
12	$\overline{PD}$	421.325	571.175	486.325	636.175
13	NC	297.125	571.175	362.125	636.175

## 6 Specifications

### 6.1 Absolute Maximum Ratings

over operating free-air temperature range (unless otherwise noted)<sup>(1)</sup>

		MIN	MAX	UNIT
V <sub>S</sub>	Total supply voltage (V <sub>S+</sub> – V <sub>S-</sub> )		5.5	V
V <sub>IN+</sub> , V <sub>IN-</sub>	Input voltage	(V <sub>S-</sub> ) – 0.5	(V <sub>S+</sub> ) + 0.5	V
V <sub>ID</sub>	Differential input voltage		1	V
V <sub>OUT</sub>	Output voltage	(V <sub>S-</sub> ) – 0.5	(V <sub>S+</sub> ) + 0.5	V
I <sub>IN</sub>	Continuous input current		±10	mA
I <sub>OUT</sub>	Continuous output current <sup>(2)</sup>		±100	mA
T <sub>J</sub>	Junction temperature		150	°C
T <sub>A</sub>	Operating free-air temperature	–40	125	°C
T <sub>stg</sub>	Storage temperature	–65	150	°C

- (1) Operation outside the *Absolute Maximum Ratings* can cause permanent device damage. *Absolute Maximum Ratings* do not imply functional operation of the device at these or any other conditions beyond those listed under *Recommended Operating Conditions*. If used outside the *Recommended Operating Conditions* but within the *Absolute Maximum Ratings*, the device can not be fully functional, and this can affect device reliability, functionality, performance, and shorten the device lifetime.
- (2) Long-term continuous output current for electromigration limits.

### 6.2 ESD Ratings

			VALUE	UNIT
V <sub>(ESD)</sub>	Electrostatic discharge	Human-body model (HBM), per ANSI/ESDA/ JEDEC JS-001 <sup>(1)</sup>	±1000	V
		Charged-device model (CDM), per JEDEC specification JESD22-C101 <sup>(2)</sup>	±1500	

- (1) JEDEC document JEP155 states that 500-V HBM allows safe manufacturing with a standard ESD control process.
- (2) JEDEC document JEP157 states that 250-V CDM allows safe manufacturing with a standard ESD control process.

### 6.3 Recommended Operating Conditions

over operating free-air temperature range (unless otherwise noted)

		MIN	NOM	MAX	UNIT
V <sub>S</sub>	Total supply voltage (V <sub>S+</sub> – V <sub>S-</sub> )	3.3	5	5.25	V
T <sub>A</sub>	Operating free-air temperature	–40		125	°C

### 6.4 Thermal Information

THERMAL METRIC <sup>(1)</sup>		OPA858	UNIT
		DSG (WSON)	
		8 PINS	
R <sub>θJA</sub>	Junction-to-ambient thermal resistance	80.1	°C/W
R <sub>θJC(top)</sub>	Junction-to-case (top) thermal resistance	100	°C/W
R <sub>θJB</sub>	Junction-to-board thermal resistance	45	°C/W
Ψ <sub>JT</sub>	Junction-to-top characterization parameter	6.8	°C/W
Ψ <sub>JB</sub>	Junction-to-board characterization parameter	45.2	°C/W
R <sub>θJC(bot)</sub>	Junction-to-case (bottom) thermal resistance	22.7	°C/W

- (1) For more information about traditional and new thermal metrics, see the [Semiconductor and IC Package Thermal Metrics](#) application report.

## 6.5 Electrical Characteristics

$V_{S+} = 5\text{ V}$ ,  $V_{S-} = 0\text{ V}$ ,  $G = 7\text{ V/V}$ ,  $R_F = 453\ \Omega$ , input common-mode biased at midsupply,  $R_L = 200\ \Omega$ , output load is referenced to midsupply, and  $T_A = 25^\circ\text{C}$  (unless otherwise noted)

PARAMETER		TEST CONDITIONS	MIN	TYP	MAX	UNIT	TEST LEVEL <sup>(1)</sup>
<b>AC PERFORMANCE</b>							
SSBW	Small-signal bandwidth	$V_{OUT} = 100\text{ mV}_{PP}$		1.2		GHz	C
LSBW	Large-signal bandwidth	$V_{OUT} = 2\text{ V}_{PP}$		600		MHz	C
GBWP	Gain-bandwidth product			5.5		GHz	C
	Bandwidth for 0.1-dB flatness			130		MHz	C
SR	Slew rate (10%–90%)	$V_{OUT} = 2\text{-V step}$		2000		V/ $\mu\text{s}$	C
$t_r$	Rise time	$V_{OUT} = 100\text{-mV step}$		0.3		ns	C
$t_f$	Fall time	$V_{OUT} = 100\text{-mV step}$		0.3		ns	C
	Settling time to 0.1%	$V_{OUT} = 2\text{-V step}$		8		ns	C
	Settling time to 0.001%	$V_{OUT} = 2\text{-V step}$		3000		ns	C
	Overshoot or undershoot	$V_{OUT} = 2\text{-V step}$		7%			C
	Overdrive recovery	2x output overdrive (0.1% recovery)		200		ns	C
HD2	Second-order harmonic distortion	$f = 10\text{ MHz}$ , $V_{OUT} = 2\text{ V}_{PP}$		88		dBc	C
		$f = 100\text{ MHz}$ , $V_{OUT} = 2\text{ V}_{PP}$		64			
HD3	Third-order harmonic distortion	$f = 10\text{ MHz}$ , $V_{OUT} = 2\text{ V}_{PP}$		86		dBc	C
		$f = 100\text{ MHz}$ , $V_{OUT} = 2\text{ V}_{PP}$		68			
$e_n$	Input-referred voltage noise	$f = 1\text{ MHz}$		2.5		nV/ $\sqrt{\text{Hz}}$	C
$Z_{OUT}$	Closed-loop output impedance	$f = 1\text{ MHz}$		0.15		$\Omega$	C
<b>DC PERFORMANCE</b>							
$A_{OL}$	Open-loop voltage gain <sup>(2)</sup>		72	75		dB	A
$V_{OS}$	Input offset voltage <sup>(2)</sup>	$T_A = 25^\circ\text{C}$	–5	$\pm 0.8$	5	mV	A
$\Delta V_{OS}/\Delta T$	Input offset voltage drift	$T_A = -40^\circ\text{C to } +125^\circ\text{C}$		$\pm 2$		$\mu\text{V}/^\circ\text{C}$	B
$I_{BN}$ , $I_{BI}$	Input bias current <sup>(2)</sup>	$T_A = 25^\circ\text{C}$		$\pm 0.4$	5	pA	A
$I_{BOS}$	Input offset current <sup>(2)</sup>	$T_A = 25^\circ\text{C}$		$\pm 0.01$	5	pA	A
CMRR	Common-mode rejection ratio <sup>(2)</sup>	$V_{CM} = \pm 0.5\text{ V}$ , referenced to midsupply	70	90		dB	A
<b>INPUT</b>							
	Common-mode input resistance			1		G $\Omega$	C
$C_{CM}$	Common-mode input capacitance			0.62		pF	C
	Differential input resistance			1		G $\Omega$	C
$C_{DIFF}$	Differential input capacitance			0.2		pF	C
$V_{IH}$	Common-mode input voltage (high) <sup>(2)</sup>	CMRR > 66 dB, $V_{S+} = 3.3\text{ V}$	1.7	1.9		V	A
$V_{IL}$	Common-mode input voltage (low) <sup>(2)</sup>	CMRR > 66 dB, $V_{S+} = 3.3\text{ V}$		0	0.4	V	A
$V_{IH}$	Common-mode input voltage (high) <sup>(2)</sup>	CMRR > 66 dB	3.4	3.6		V	A
		$T_A = -40^\circ\text{C to } +125^\circ\text{C}$ , CMRR > 66 dB		3.4			B
$V_{IL}$	Common-mode input voltage (low) <sup>(2)</sup>	CMRR > 66 dB		0	0.4	V	A
		$T_A = -40^\circ\text{C to } +125^\circ\text{C}$ , CMRR > 66 dB		0.35			B

## 6.5 Electrical Characteristics (continued)

$V_{S+} = 5\text{ V}$ ,  $V_{S-} = 0\text{ V}$ ,  $G = 7\text{ V/V}$ ,  $R_F = 453\ \Omega$ , input common-mode biased at midsupply,  $R_L = 200\ \Omega$ , output load is referenced to midsupply, and  $T_A = 25^\circ\text{C}$  (unless otherwise noted)

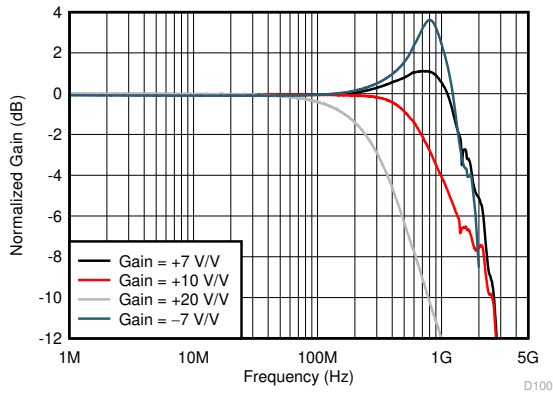
PARAMETER		TEST CONDITIONS	MIN	TYP	MAX	UNIT	TEST LEVEL <sup>(1)</sup>
<b>OUTPUT</b>							
$V_{OH}$	Output voltage (high)	$T_A = 25^\circ\text{C}$ , $V_{S+} = 3.3\text{ V}$	2.3	2.4		V	A
		$T_A = 25^\circ\text{C}$	3.95	4.1			A
		$T_A = -40^\circ\text{C}$ to $+125^\circ\text{C}$		3.9			B
$V_{OL}$	Output voltage (low)	$T_A = 25^\circ\text{C}$ , $V_{S+} = 3.3\text{ V}$		1.05	1.15	V	A
		$T_A = 25^\circ\text{C}$		1.05	1.15		A
		$T_A = -40^\circ\text{C}$ to $+125^\circ\text{C}$		1.2			B
	Linear output drive (sink and source) <sup>(2)</sup>	$R_L = 10\ \Omega$ , $A_{OL} > 60\text{ dB}$	65	80		mA	A
		$T_A = -40^\circ\text{C}$ to $+125^\circ\text{C}$ , $R_L = 10\ \Omega$ , $A_{OL} > 60\text{ dB}$		64			B
$I_{SC}$	Output short-circuit current <sup>(2)</sup>		85	105		mA	A
<b>POWER SUPPLY</b>							
$I_Q$	Quiescent current	$V_{S+} = 5\text{ V}$	18	20.5	24	mA	A
		$V_{S+} = 3.3\text{ V}$	17.5	20	23.5		A
		$V_{S+} = 5.25\text{ V}$	18	21	24		A
		$T_A = 125^\circ\text{C}$		24.5			B
		$T_A = -40^\circ\text{C}$		18.5			B
PSRR+	Positive power-supply rejection ratio <sup>(2)</sup>		74	84		dB	A
PSRR-	Negative power-supply rejection ratio <sup>(2)</sup>		70	80		dB	A
<b>POWER DOWN</b>							
	Disable voltage threshold	Amplifier off when < this voltage	0.65	1		V	A
	Enable voltage threshold	Amplifier on when > this voltage		1.5	1.8	V	A
	Power-down quiescent current			70	140	$\mu\text{A}$	A
	$\overline{\text{PD}}$ bias current			70	200	$\mu\text{A}$	A
	Turn-on time delay	Time to $V_{OUT} = 90\%$ of final value		13		ns	C
	Turn-off time delay			120		ns	C

(1) Test levels (all values set by characterization and simulation): (A) 100% tested at  $25^\circ\text{C}$ , overtemperature limits by characterization and simulation; (B) Not tested in production, limits set by characterization and simulation; (C) Typical value only for information.

(2) MIN and MAX limits do not apply for bare die.

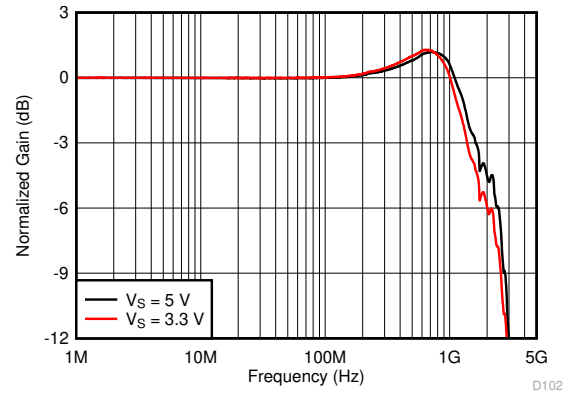
## 6.6 Typical Characteristics

at  $V_{S+} = 2.5\text{ V}$ ,  $V_{S-} = -2.5\text{ V}$ ,  $V_{IN+} = 0\text{ V}$ ,  $R_F = 453\ \Omega$ , gain =  $7\text{ V/V}$ ,  $R_L = 200\ \Omega$ , output load referenced to midsupply, and  $T_A = 25^\circ\text{C}$  (unless otherwise noted)



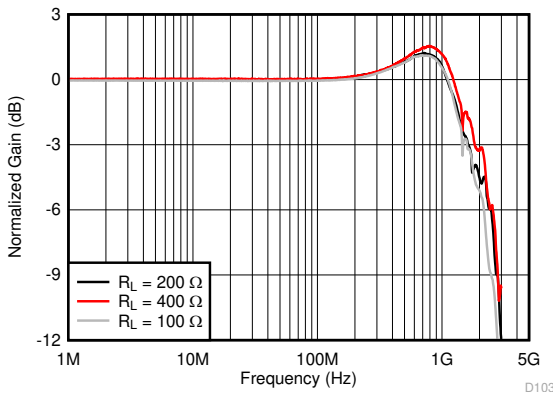
$V_{OUT} = 100\text{ mV}_{PP}$ ; see Figure 7-1 and Figure 7-2 for circuit configuration

**Figure 6-1. Small-Signal Frequency Response vs Gain**



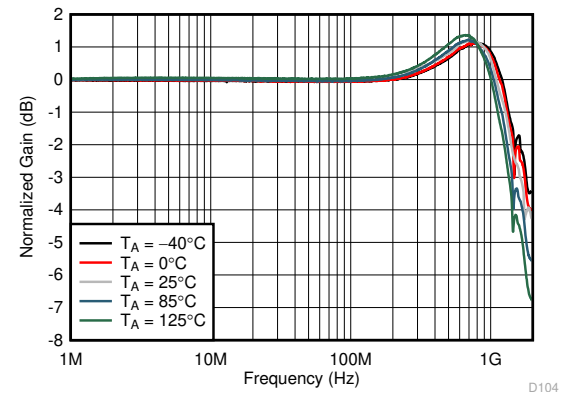
$V_{OUT} = 100\text{ mV}_{PP}$

**Figure 6-2. Small-Signal Frequency Response vs Supply Voltage**



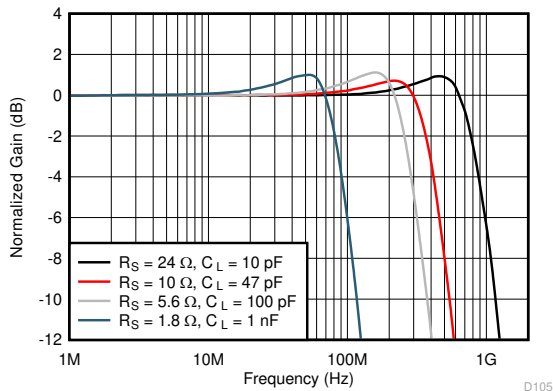
$V_{OUT} = 100\text{ mV}_{PP}$

**Figure 6-3. Small-Signal Frequency Response vs Output Load**



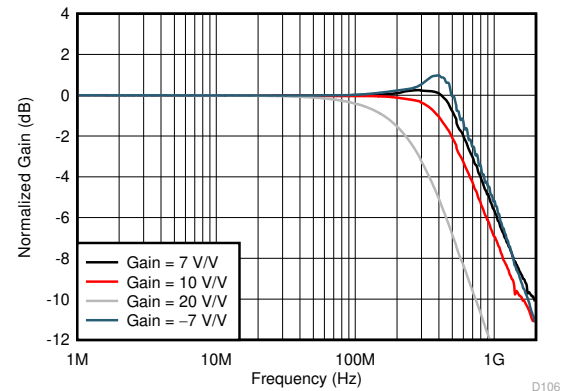
$V_{OUT} = 100\text{ mV}_{PP}$

**Figure 6-4. Small-Signal Frequency Response vs Ambient Temperature**



$V_{OUT} = 100\text{ mV}_{PP}$ ; see Figure 7-3 for circuit configuration

**Figure 6-5. Small-Signal Frequency Response vs Capacitive Load**



$V_{OUT} = 2\text{ V}_{PP}$

**Figure 6-6. Large-Signal Frequency Response vs Gain**

### 6.6 Typical Characteristics (continued)

at  $V_{S+} = 2.5\text{ V}$ ,  $V_{S-} = -2.5\text{ V}$ ,  $V_{IN+} = 0\text{ V}$ ,  $R_F = 453\ \Omega$ , gain =  $7\text{ V/V}$ ,  $R_L = 200\ \Omega$ , output load referenced to midsupply, and  $T_A = 25^\circ\text{C}$  (unless otherwise noted)

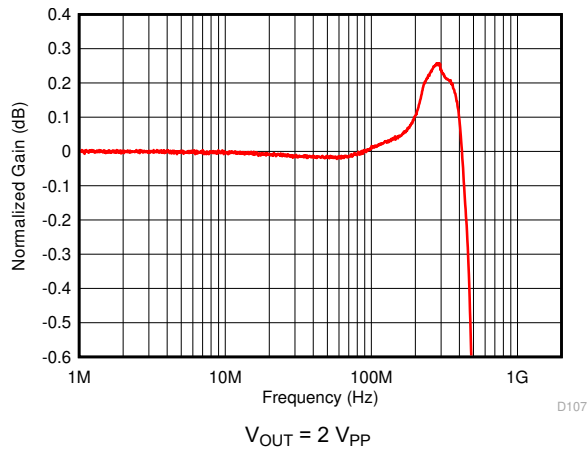


Figure 6-7. Large-Signal Response for 0.1-dB Gain Flatness

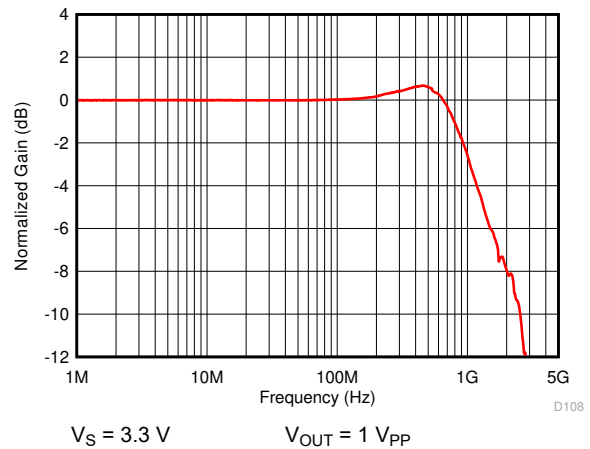


Figure 6-8. Large-Signal Frequency Response

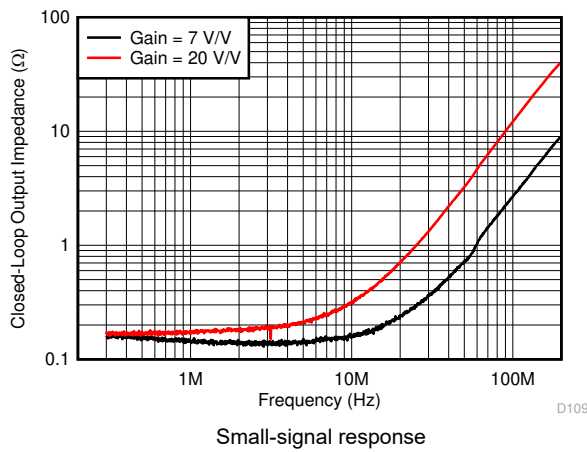


Figure 6-9. Closed-Loop Output Impedance vs Frequency

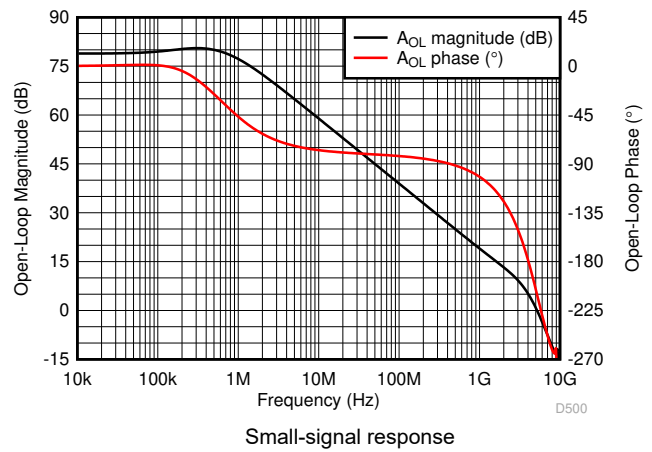


Figure 6-10. Open-Loop Magnitude and Phase vs Frequency

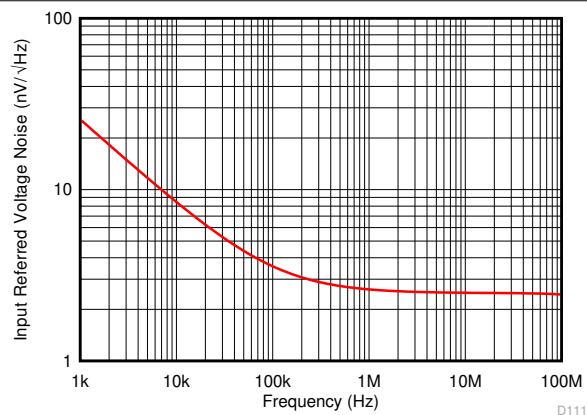


Figure 6-11. Voltage Noise Density vs Frequency

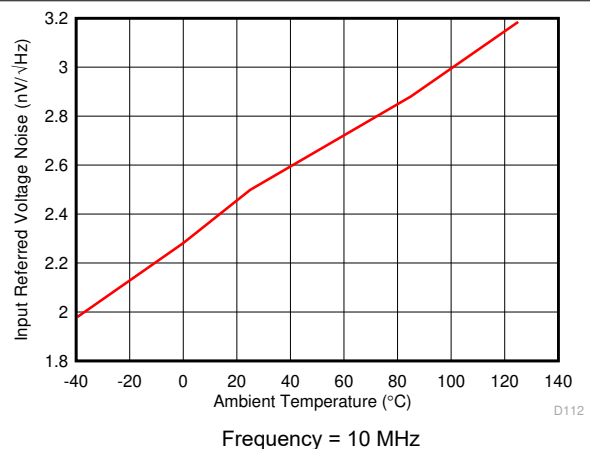


Figure 6-12. Voltage Noise Density vs Ambient Temperature

### 6.6 Typical Characteristics (continued)

at  $V_{S+} = 2.5\text{ V}$ ,  $V_{S-} = -2.5\text{ V}$ ,  $V_{IN+} = 0\text{ V}$ ,  $R_F = 453\ \Omega$ , gain =  $7\text{ V/V}$ ,  $R_L = 200\ \Omega$ , output load referenced to midsupply, and  $T_A = 25^\circ\text{C}$  (unless otherwise noted)

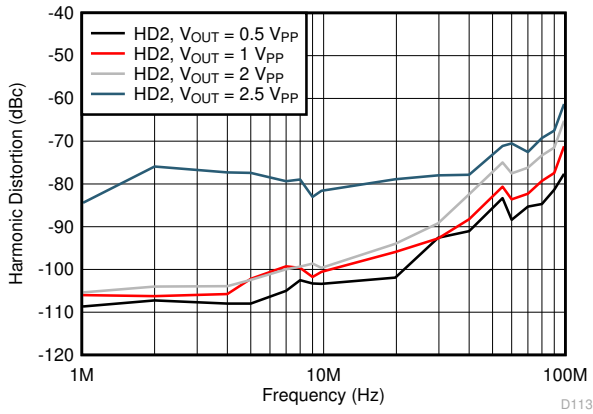


Figure 6-13. Harmonic Distortion (HD2) vs Output Swing

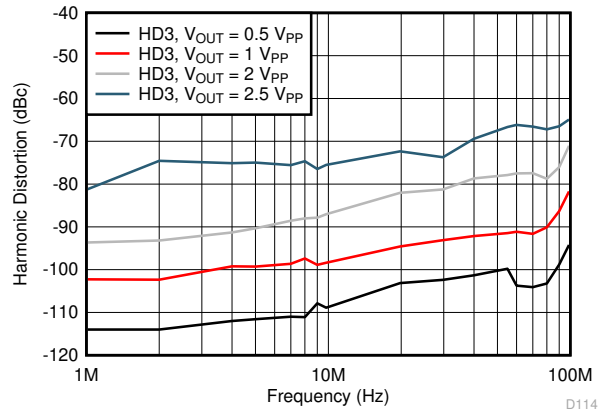


Figure 6-14. Harmonic Distortion (HD3) vs Output Swing

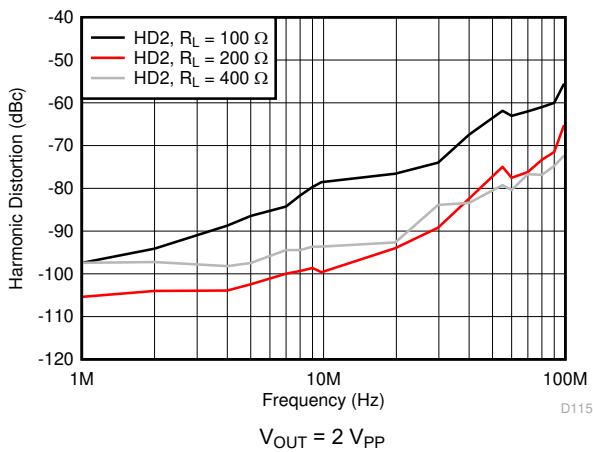


Figure 6-15. Harmonic Distortion (HD2) vs Output Load

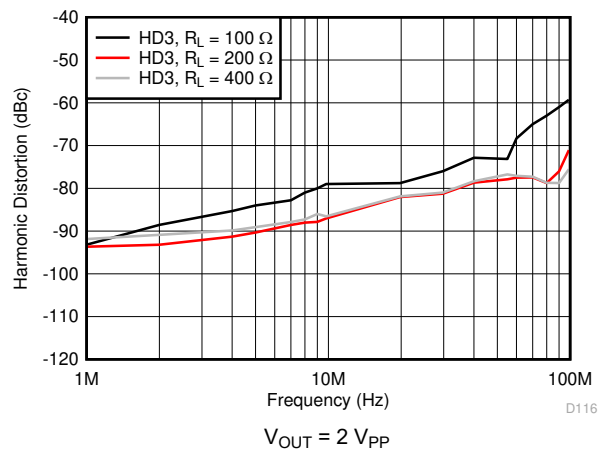


Figure 6-16. Harmonic Distortion (HD3) vs Output Load

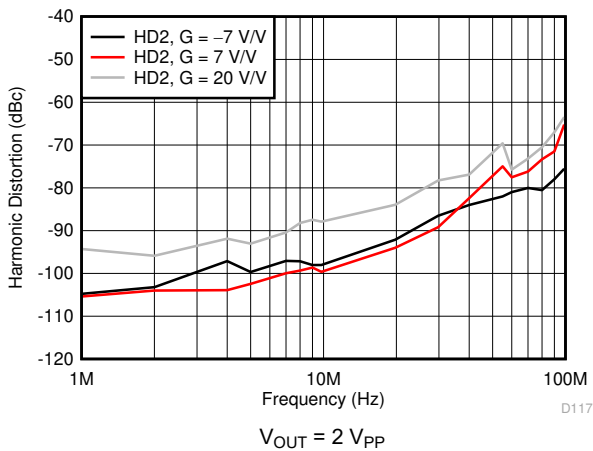


Figure 6-17. Harmonic Distortion (HD2) vs Gain

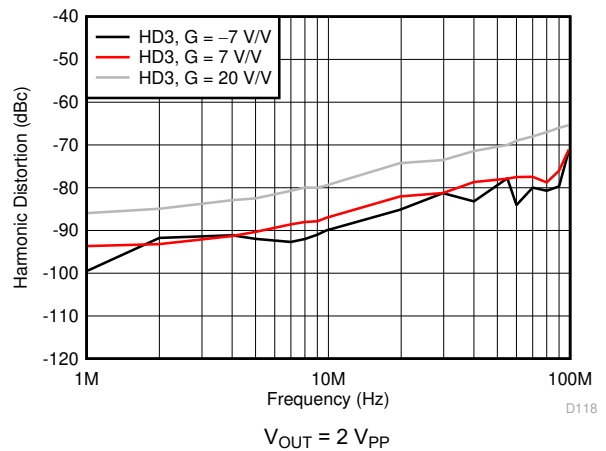
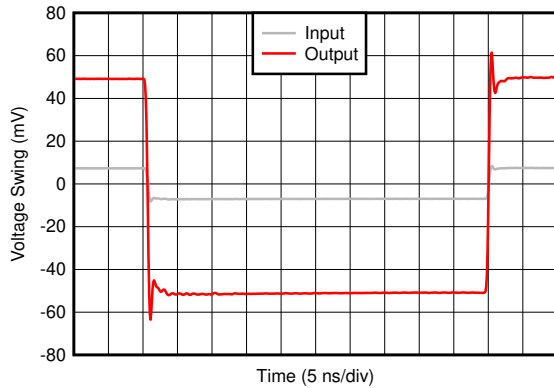


Figure 6-18. Harmonic Distortion (HD3) vs Gain

### 6.6 Typical Characteristics (continued)

at  $V_{S+} = 2.5\text{ V}$ ,  $V_{S-} = -2.5\text{ V}$ ,  $V_{IN+} = 0\text{ V}$ ,  $R_F = 453\ \Omega$ , gain =  $7\text{ V/V}$ ,  $R_L = 200\ \Omega$ , output load referenced to midsupply, and  $T_A = 25^\circ\text{C}$  (unless otherwise noted)

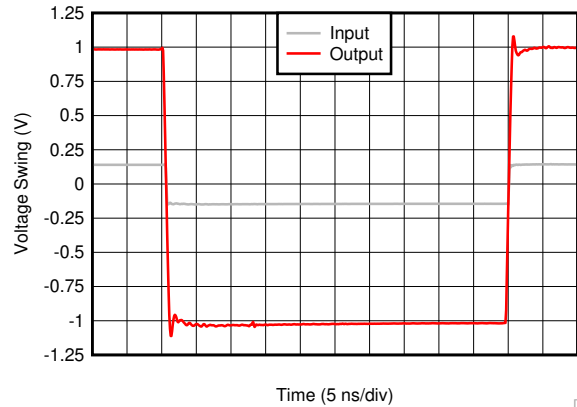


Time (5 ns/div)

D119

Average rise-and-fall time (10%–90%) = 450 ps

**Figure 6-19. Small-Signal Transient Response**

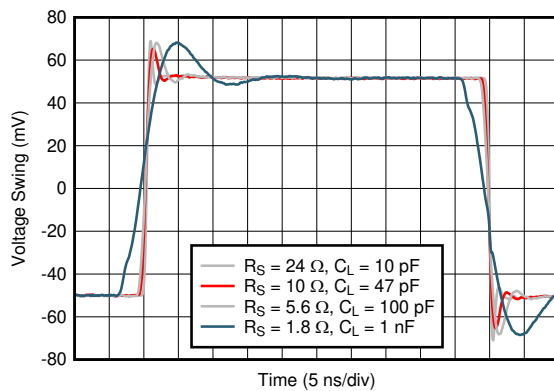


Time (5 ns/div)

D120

Average rise-and-fall time (10%–90%) = 750 ps

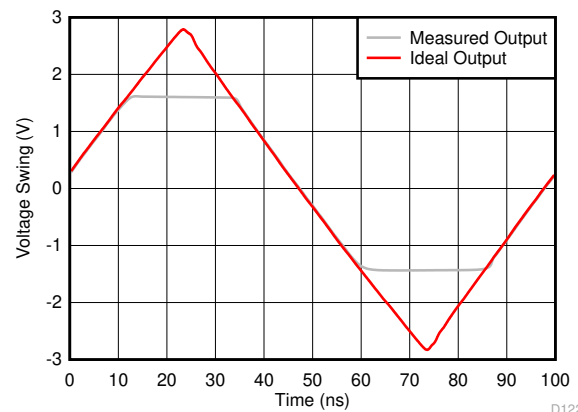
**Figure 6-20. Large-Signal Transient Response**



Time (5 ns/div)

D121

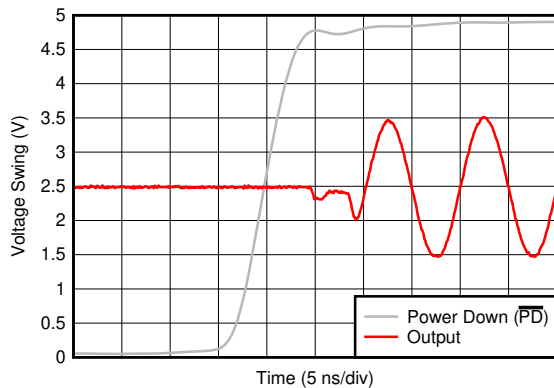
**Figure 6-21. Small-Signal Transient Response vs Capacitive Load**



2 × output overdrive

D122

**Figure 6-22. Output Overload Response**

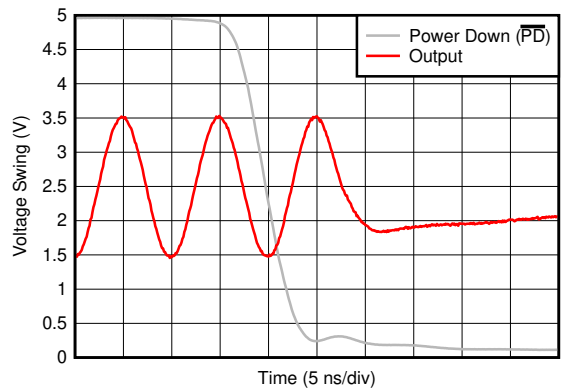


Time (5 ns/div)

D123

$V_{S+} = 5\text{ V}$ ,  $V_{S-} = \text{ground}$

**Figure 6-23. Turn-On Transient Response**



Time (5 ns/div)

D124

$V_{S+} = 5\text{ V}$ ,  $V_{S-} = \text{ground}$

**Figure 6-24. Turn-Off Transient Response**

### 6.6 Typical Characteristics (continued)

at  $V_{S+} = 2.5\text{ V}$ ,  $V_{S-} = -2.5\text{ V}$ ,  $V_{IN+} = 0\text{ V}$ ,  $R_F = 453\ \Omega$ , gain =  $7\text{ V/V}$ ,  $R_L = 200\ \Omega$ , output load referenced to midsupply, and  $T_A = 25^\circ\text{C}$  (unless otherwise noted)

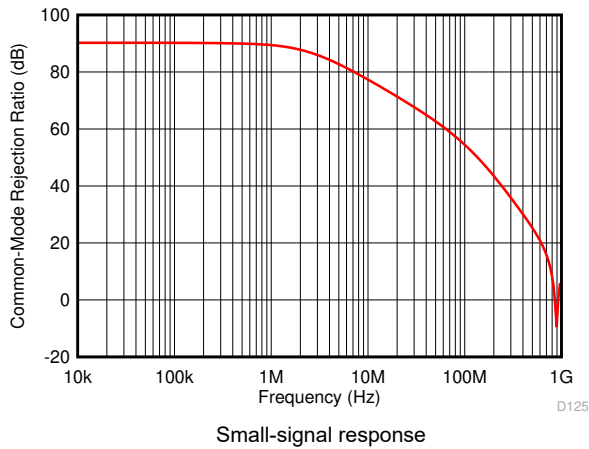


Figure 6-25. Common-Mode Rejection Ratio vs Frequency

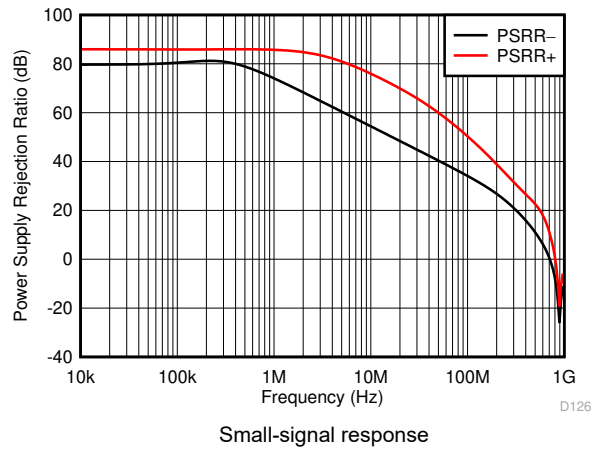


Figure 6-26. Power Supply Rejection Ratio vs Frequency

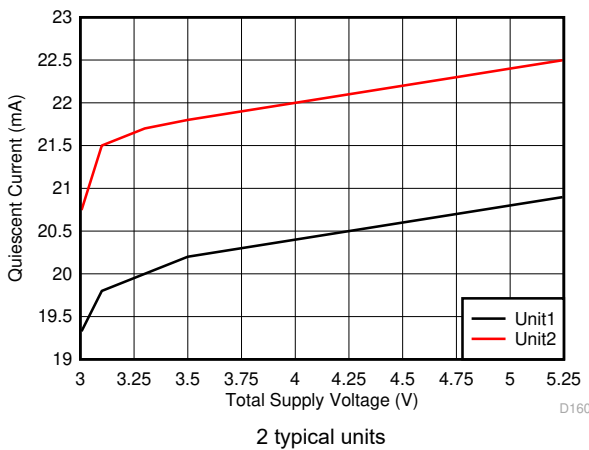


Figure 6-27. Quiescent Current vs Supply Voltage

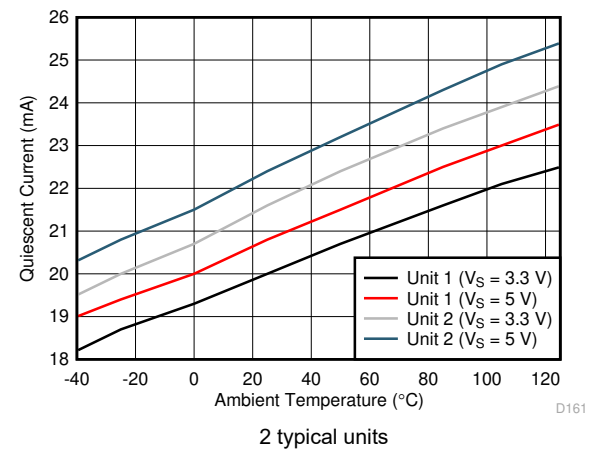


Figure 6-28. Quiescent Current vs Ambient Temperature

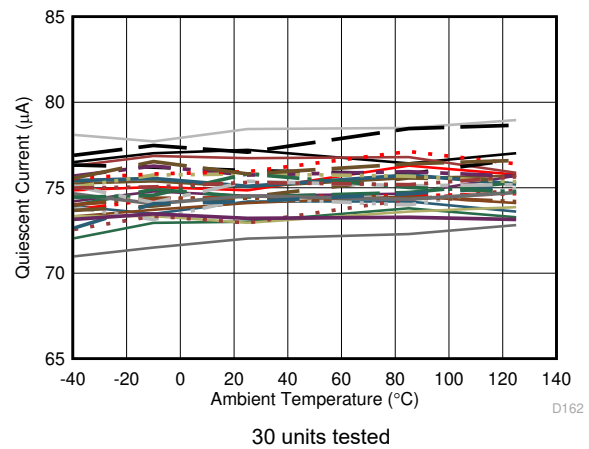


Figure 6-29. Quiescent Current (Amplifier Disabled) vs Ambient Temperature

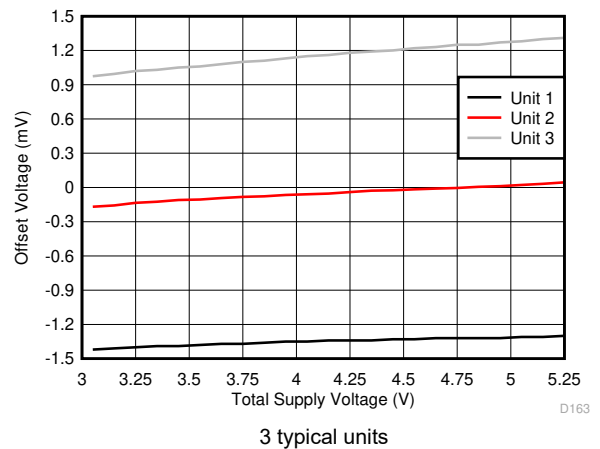
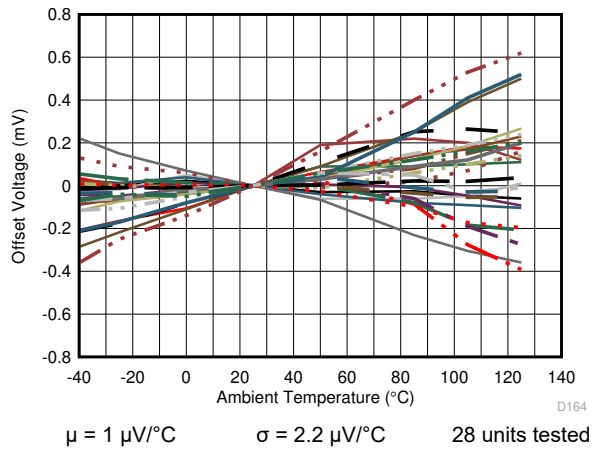


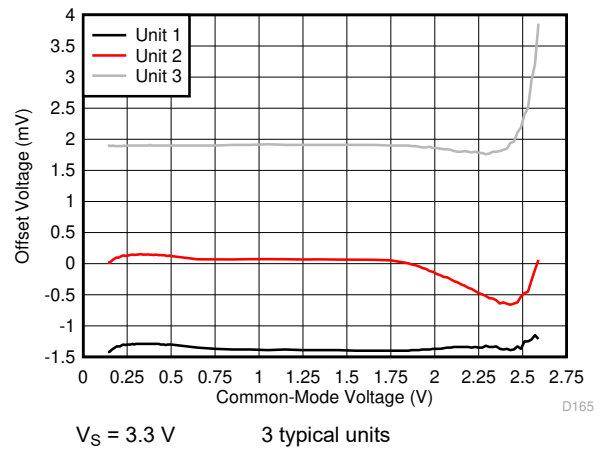
Figure 6-30. Offset Voltage vs Supply Voltage

### 6.6 Typical Characteristics (continued)

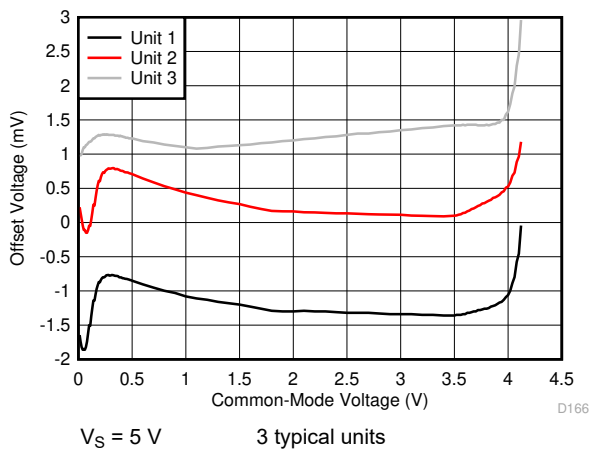
at  $V_{S+} = 2.5\text{ V}$ ,  $V_{S-} = -2.5\text{ V}$ ,  $V_{IN+} = 0\text{ V}$ ,  $R_F = 453\ \Omega$ , gain = 7 V/V,  $R_L = 200\ \Omega$ , output load referenced to midsupply, and  $T_A = 25^\circ\text{C}$  (unless otherwise noted)



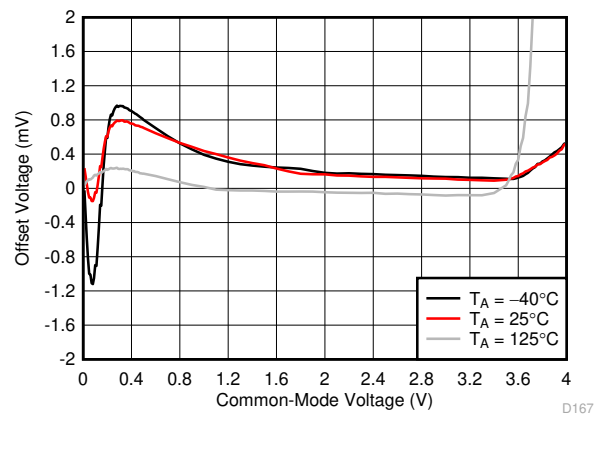
**Figure 6-31. Offset Voltage vs Ambient Temperature**



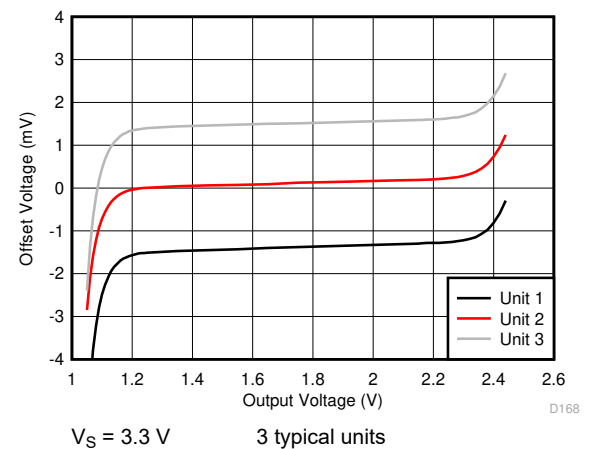
**Figure 6-32. Offset Voltage vs Input Common-Mode Voltage**



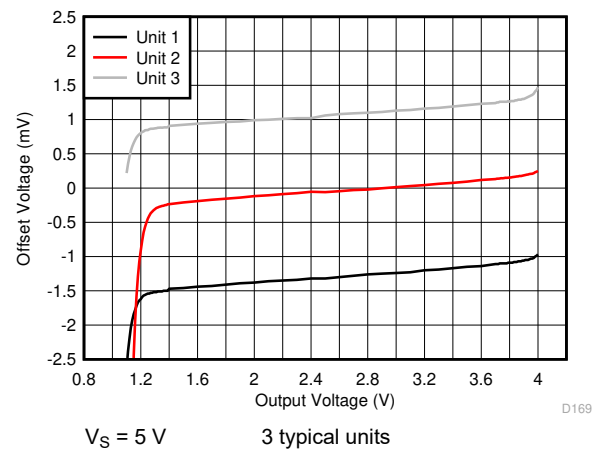
**Figure 6-33. Offset Voltage vs Input Common-Mode Voltage**



**Figure 6-34. Offset Voltage vs Input Common-Mode Voltage vs Ambient Temperature**



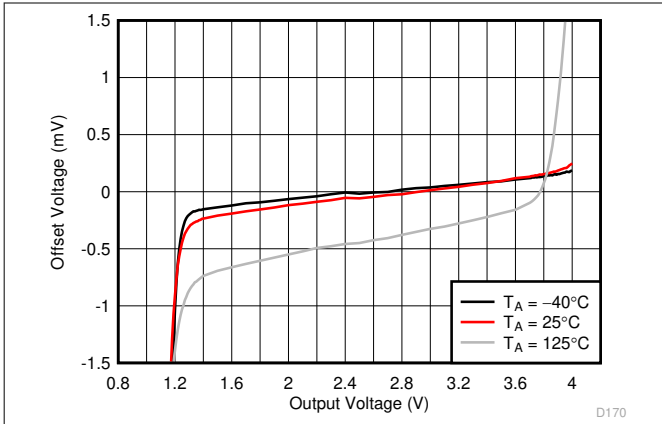
**Figure 6-35. Offset Voltage vs Output Swing**



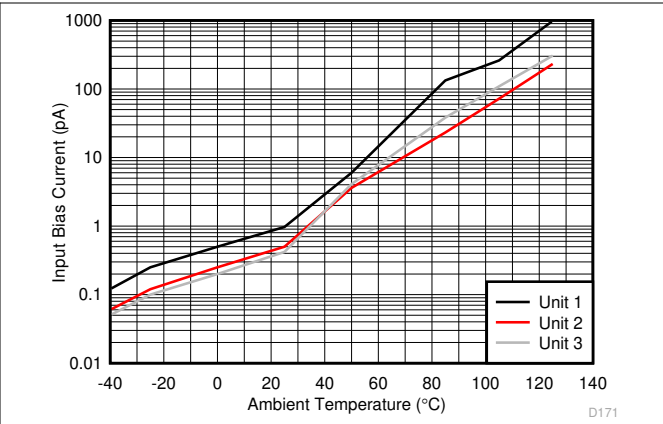
**Figure 6-36. Offset Voltage vs Output Swing**

### 6.6 Typical Characteristics (continued)

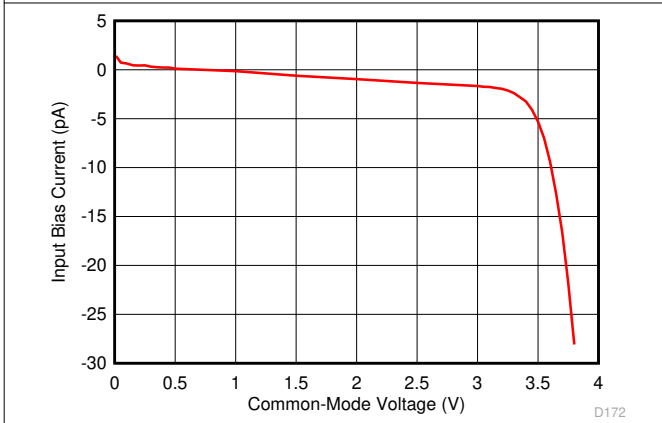
at  $V_{S+} = 2.5\text{ V}$ ,  $V_{S-} = -2.5\text{ V}$ ,  $V_{IN+} = 0\text{ V}$ ,  $R_F = 453\ \Omega$ , gain =  $7\text{ V/V}$ ,  $R_L = 200\ \Omega$ , output load referenced to midsupply, and  $T_A = 25^\circ\text{C}$  (unless otherwise noted)



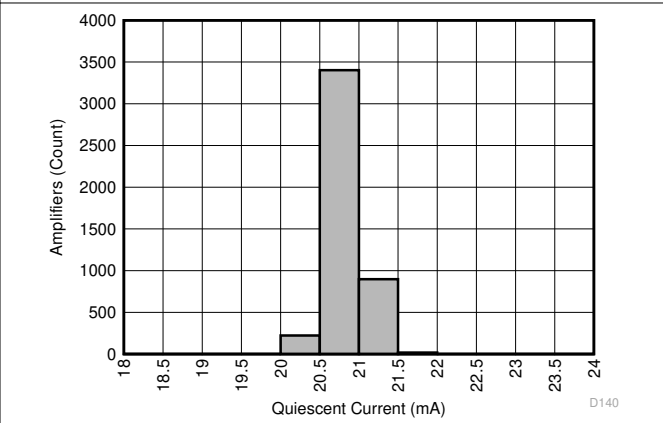
**Figure 6-37. Offset Voltage vs Output Swing vs Ambient Temperature**



**Figure 6-38. Input Bias Current vs Ambient Temperature**

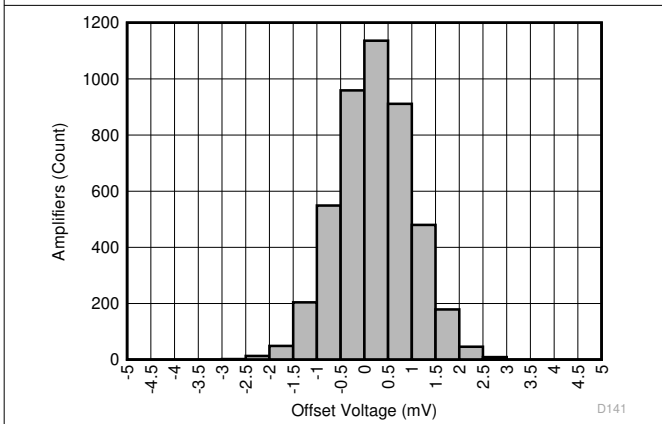


**Figure 6-39. Input Bias Current vs Input Common-Mode Voltage**



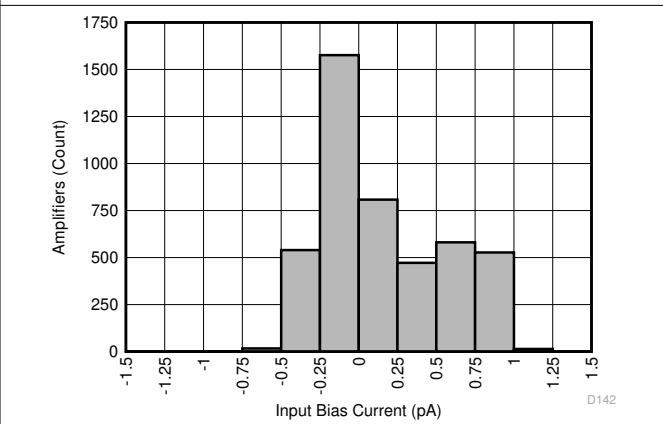
$\mu = 20.35\text{ mA}$        $\sigma = 0.2\text{ mA}$       4555 units tested

**Figure 6-40. Quiescent Current Distribution**



$\mu = -0.28\text{ mV}$        $\sigma = 0.8\text{ mV}$       4555 units tested

**Figure 6-41. Offset Voltage Distribution**

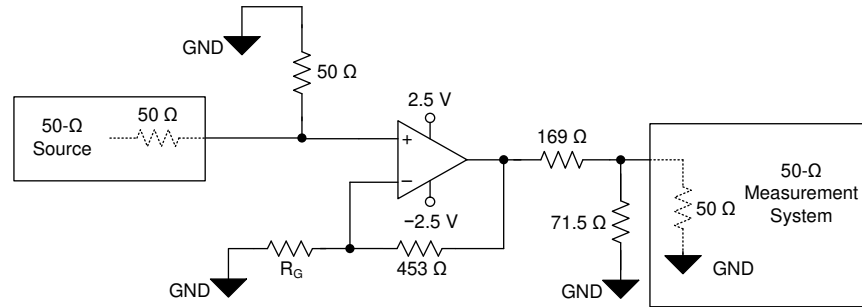


$\mu = -0.1\text{ pA}$        $\sigma = 0.39\text{ pA}$       4555 units tested

**Figure 6-42. Input Bias Current Distribution**

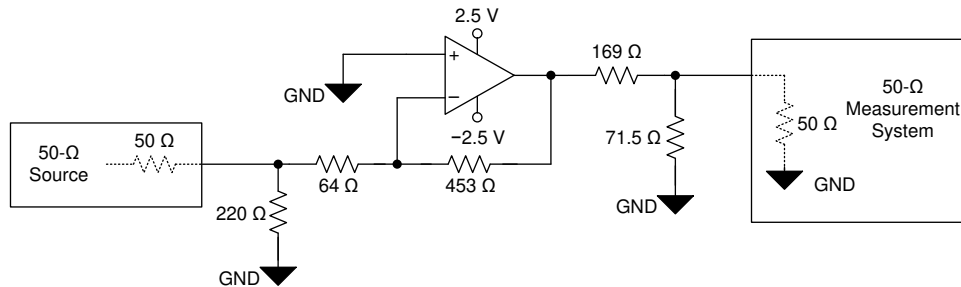
## 7 Parameter Measurement Information

The various test setup configurations for the OPA858 are shown in [Figure 7-1](#), [Figure 7-2](#), and [Figure 7-3](#).

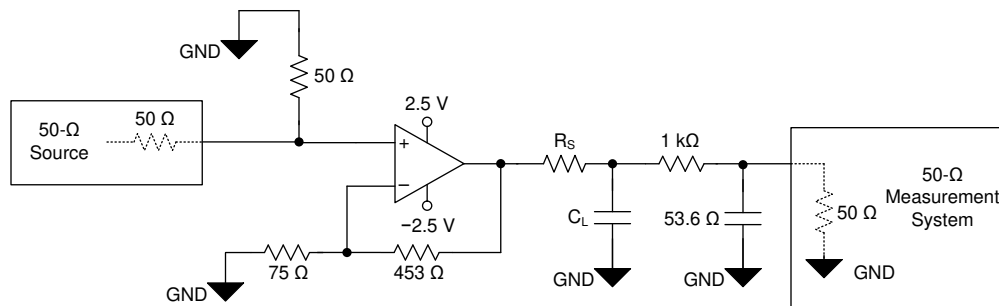


$R_G$  values depend on gain configuration

**Figure 7-1. Noninverting Configuration**



**Figure 7-2. Inverting Configuration (Gain =  $-7$  V/V)**



**Figure 7-3. Capacitive Load Driver Configuration**

## 8 Detailed Description

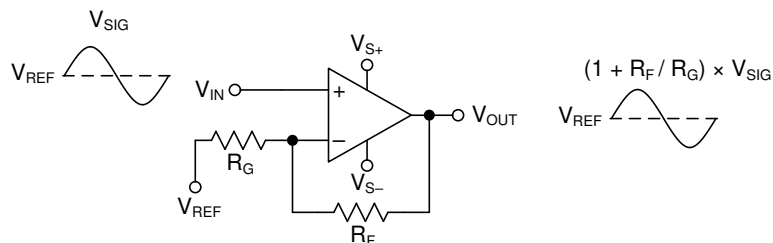
### 8.1 Overview

The ultra-wide, 5.5-GHz gain bandwidth product (GBWP) of the OPA858, combined with the broadband voltage noise of  $2.5 \text{ nV}/\sqrt{\text{Hz}}$ , produces a viable amplifier for wideband transimpedance applications, high-speed data acquisition systems, and applications with weak signal inputs that require low-noise and high-gain front ends. The OPA858 combines multiple features to optimize dynamic performance. In addition to the wide, small-signal bandwidth, the OPA858 has 600 MHz of large-signal bandwidth ( $V_{\text{OUT}} = 2 V_{\text{PP}}$ ), and a slew rate of  $2000 \text{ V}/\mu\text{s}$ .

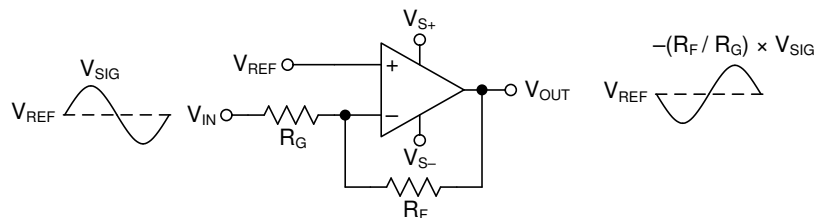
The OPA858 is offered in a 2-mm × 2-mm, 8-pin WSON package that features a feedback (FB) pin for a simple feedback network connection between the amplifiers output and inverting input. Excess capacitance on an amplifiers input pin can reduce phase margin causing instability. This problem is exacerbated in the case of very wideband amplifiers like the OPA858. To reduce the effects of stray capacitance on the input node, the OPA858 pinout features an isolation pin (NC) between the feedback and inverting input pins that increases the physical spacing between them, thereby reducing parasitic coupling at high frequencies. The OPA858 also features a very low capacitance input stage with only 0.8-pF of total input capacitance.

### 8.2 Functional Block Diagram

The OPA858 is a classic voltage-feedback operational amplifier (op amp) with two high-impedance inputs and a low-impedance output. Standard application circuits are supported, such as the two basic options in [Figure 8-1](#) and [Figure 8-2](#). The dc operating point for each configuration is level-shifted by the reference voltage ( $V_{\text{REF}}$ ), which is typically set to midsupply in single-supply operation.  $V_{\text{REF}}$  is typically connected to ground in split-supply applications.



**Figure 8-1. Noninverting Amplifier**

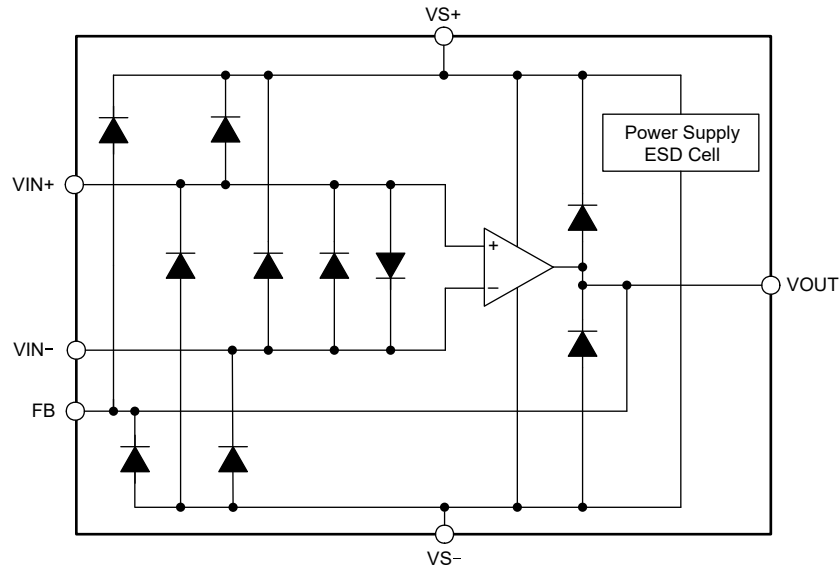


**Figure 8-2. Inverting Amplifier**

## 8.3 Feature Description

### 8.3.1 Input and ESD Protection

The OPA858 is fabricated on a low-voltage, high-speed, BiCMOS process. The internal, junction breakdown voltages are low for these small geometry devices, and as a result, all device pins are protected with internal ESD protection diodes to the power supplies as [Figure 8-3](#) shows. There are two anti-parallel diodes between the inputs of the amplifier that clamp the inputs during an over-range or fault condition.

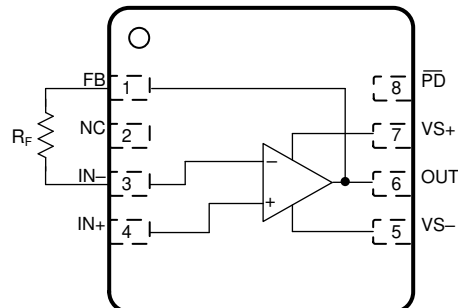


**Figure 8-3. Internal ESD Structure**

### 8.3.2 Feedback Pin

The OPA858 pin layout is optimized to minimize parasitic inductance and capacitance, which is a critical care about in high-speed analog design. The FB pin (pin 1) is internally connected to the output of the amplifier. The FB pin is separated from the inverting input of the amplifier (pin 3) by a no connect (NC) pin (pin 2). The NC pin must be left floating. There are two advantages to this pin layout:

1. A feedback resistor ( $R_F$ ) can connect between the FB and IN $-$  pin on the same side of the package (see [Figure 8-4](#)) rather than going around the package.
2. The isolation created by the NC pin minimizes the capacitive coupling between the FB and IN $-$  pins by increasing the physical separation between the pins.



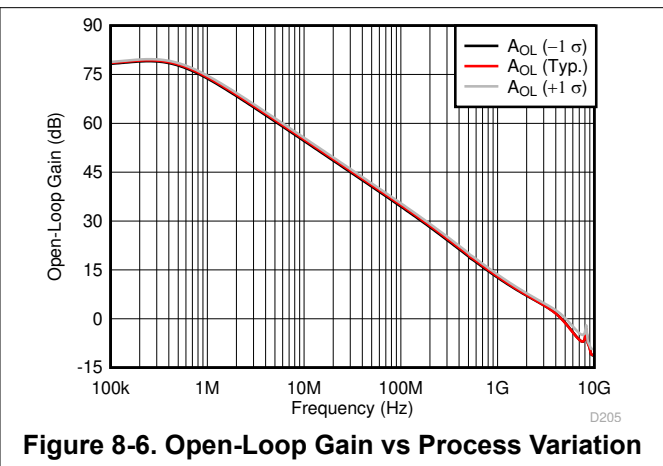
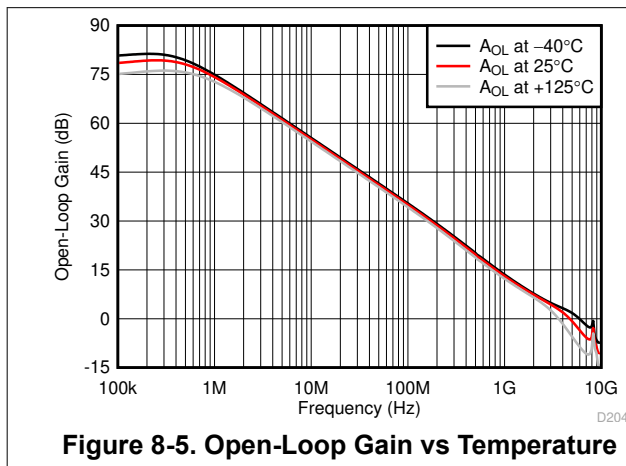
**Figure 8-4.  $R_F$  Connection Between FB and IN $-$  Pins**

### 8.3.3 Wide Gain-Bandwidth Product

Figure 6-10 shows the open-loop magnitude and phase response of the OPA858. Calculate the gain bandwidth product of any op amp by determining the frequency at which the  $A_{OL}$  is 60 dB and multiplying that frequency by a factor of 1000. The second pole in the  $A_{OL}$  response occurs before the magnitude crosses 0 dB, and the resultant phase margin is less than  $0^\circ$ . This result indicates instability at a gain of 0 dB (1 V/V). Amplifiers that are not unity-gain stable are known as decompensated amplifiers. Decompensated amplifiers typically have higher gain-bandwidth product, higher slew rate, and lower voltage noise, compared to a unity-gain stable amplifier with the same amount of quiescent power consumption.

Figure 8-5 shows the open-loop magnitude ( $A_{OL}$ ) of the OPA858 as a function of temperature. The results show minimal variation over temperature. The phase margin of the OPA858 configured in a noise gain of 7 V/V (16.9 dB) is close to  $55^\circ$  across temperature. Similarly Figure 8-6 shows the  $A_{OL}$  magnitude of the OPA858 as a function of process variation. The results show the  $A_{OL}$  curve for the nominal process corner and the variation one standard deviation from the nominal. The simulated results suggest less than  $1^\circ$  of phase margin difference within a standard deviation of process variation when the amplifier is configured in a gain of 7 V/V.

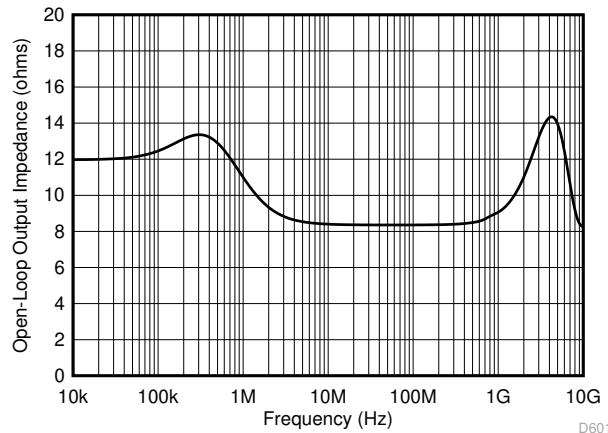
One of the primary applications for the OPA858 is as a high-speed transimpedance amplifier (TIA), as Figure 9-4 shows. The low-frequency noise gain of a TIA is 0 dB (1 V/V). At high frequencies the ratio of the total input capacitance and the feedback capacitance set the noise gain. To maximize the TIA closed-loop bandwidth, the feedback capacitance is typically smaller than the input capacitance, which implies that the high-frequency noise gain is greater than 0 dB. As a result, op amps configured as TIAs are not required to be unity-gain stable, which makes a decompensated amplifier a viable option for a TIA. [What You Need To Know About Transimpedance Amplifiers – Part 1](#) and [What You Need To Know About Transimpedance Amplifiers – Part 2](#) describe transimpedance amplifier compensation in greater detail.



### 8.3.4 Slew Rate and Output Stage

In addition to wide bandwidth, the OPA858 features a high slew rate of 2000 V/ $\mu$ s. The slew rate is a critical parameter in high-speed pulse applications with narrow sub-10-ns pulses, such as optical time-domain reflectometry (OTDR) and LIDAR. The high slew rate of the OPA858 implies that the device accurately reproduces a 2-V, sub-ns pulse edge; see also Figure 6-20. The wide bandwidth and slew rate make the OPA858 an excellent amplifier for high-speed signal-chain front ends.

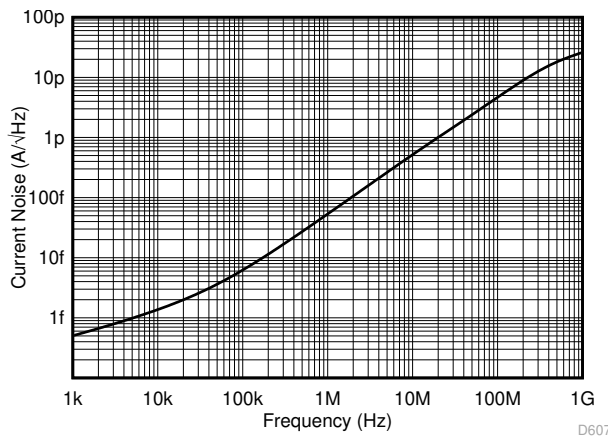
Figure 8-7 shows the open-loop output impedance of the OPA858 as a function of frequency. To achieve high slew rates and low output impedance across frequency, the output swing of the OPA858 is limited to approximately 3 V. The OPA858 is typically used in conjunction with high-speed pipeline ADCs and flash ADCs that have limited input ranges. Therefore, the OPA858 output swing range coupled with the class-leading voltage noise specification for a CMOS amplifier maximizes the overall dynamic range of the signal chain.



**Figure 8-7. Open-Loop Output Impedance ( $Z_{OL}$ ) vs Frequency**

### 8.3.5 Current Noise

The input impedance of CMOS and JFET input amplifiers at low frequencies exceed several G $\Omega$ s. However, at higher frequencies, the transistors parasitic capacitance to the drain, source, and substrate reduces the impedance. The high impedance at low frequencies eliminates any bias current and the associated shot noise. At higher frequencies, the input current noise increases (see Figure 8-8) as a result of capacitive coupling between the CMOS gate oxide and the underlying transistor channel. This phenomenon is a natural artifact of the construction of the transistor and is unavoidable.



**Figure 8-8. Input Current Noise ( $I_{BN}$  and  $I_{BI}$ ) vs Frequency**

## 8.4 Device Functional Modes

### 8.4.1 Split-Supply and Single-Supply Operation

The OPA858 can be configured with single-sided supplies or split supplies; see also [Figure 9-8](#). Split-supply operation using balanced supplies with the input common-mode set to ground can help ease lab testing (because most signal generators, network analyzers, spectrum analyzers, and other lab equipment typically reference inputs and outputs to ground). In split-supply operation, connect the thermal pad to the negative supply.

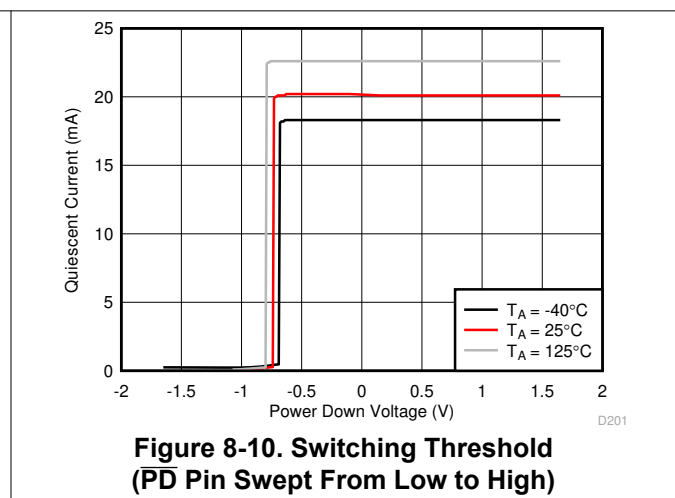
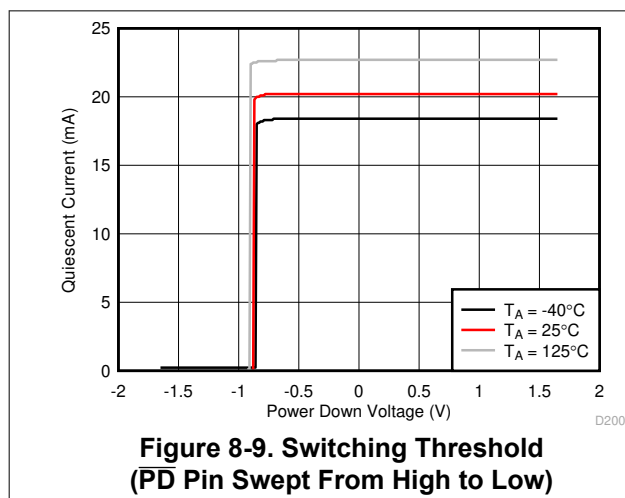
Newer systems use a single power supply to improve efficiency and reduce the cost of the extra power supply. The OPA858 can be used with a single positive supply (negative supply at ground) with no change in performance if the input common-mode and output swing are biased within the linear operation of the device. In single-supply operation, level shift the dc input and output reference voltages by half the difference between the power supply rails. This configuration maintains the input common-mode and output load reference at midsupply. To eliminate gain errors, the source driving the reference input common-mode voltage must have low output impedance across the frequency range of interest. In this case, connect the thermal pad to ground.

### 8.4.2 Power-Down Mode

The OPA858 features a power-down mode to reduce the quiescent current to conserve power. [Figure 6-23](#) and [Figure 6-24](#) show the OPA858 transient response as the  $\overline{\text{PD}}$  pin toggles between the disabled and enabled states.

The  $\overline{\text{PD}}$  disable and enable threshold voltages are with reference to the negative supply. If the amplifier is configured with the positive supply at 3.3 V and the negative supply at ground, then the disable threshold voltage is 0.65 V and the enable threshold voltage is 1.8 V. If the amplifier is configured with  $\pm 1.65$ -V supplies, then the disable threshold voltage is  $-1$  V and the enable threshold voltage is 0.15 V. If the amplifier is configured with  $\pm 2.5$ -V supplies, then the disable threshold voltage is  $-1.85$  V and the enable threshold voltage is  $-0.7$  V.

[Figure 8-9](#) shows the switching behavior of a typical amplifier as the  $\overline{\text{PD}}$  pin is swept down from the enabled to the disabled state. Similarly, [Figure 8-10](#) shows the switching behavior of a typical amplifier as the  $\overline{\text{PD}}$  pin is swept up from the disabled to the enabled state. The small difference in the switching thresholds between the down sweep and up sweep is due to the hysteresis designed into the amplifier to increase noise immunity on  $\overline{\text{PD}}$ .



Connecting the  $\overline{\text{PD}}$  pin low disables the amplifier and places the output in a high-impedance state. When the amplifier is configured as a noninverting amplifier, the feedback ( $R_F$ ) and gain ( $R_G$ ) resistor network form a parallel load to the output of the amplifier. To protect the input stage of the amplifier, the OPA858 uses internal, back-to-back protection diodes between the inverting and noninverting input pins; see also [Figure 8-3](#). In the

power-down state, if the differential voltage between the input pins of the amplifier exceeds a diode voltage drop, an additional low-impedance path is created between the noninverting input pin and the output pin.

## 9 Application and Implementation

### Note

Information in the following applications sections is not part of the TI component specification, and TI does not warrant its accuracy or completeness. TI's customers are responsible for determining suitability of components for their purposes, as well as validating and testing their design implementation to confirm system functionality.

## 9.1 Application Information

### 9.1.1 Using the OPA858 as a Transimpedance Amplifier

The OPA858 design has been optimized to meet the industry's growing demand for wideband, low-noise photodiode amplifiers. The closed-loop bandwidth of a transimpedance amplifier is a function of the following:

1. The total input capacitance. This includes the photodiode capacitance, input capacitance of the amplifier (common-mode and differential capacitance) and any stray capacitance from the PCB.
2. The op amp gain bandwidth product (GBWP).
3. The transimpedance gain  $R_F$ .

Figure 9-1 shows the OPA858 configured as a TIA with the avalanche photodiode (APD) reverse biased such that the APD cathode is tied to a large positive bias voltage. In this configuration the APD sources current into the op amp feedback loop so that the output swings in a negative direction relative to the input common-mode voltage. To maximize the output swing in the negative direction, the OPA858 common-mode is set close to the positive limit, 1.6 V from the positive supply rail.

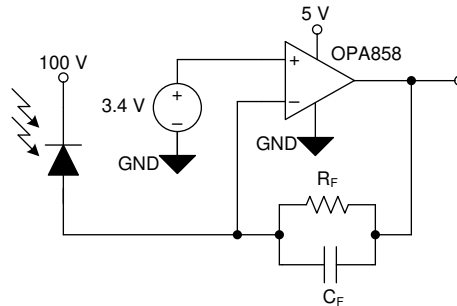


Figure 9-1. Transimpedance Amplifier Circuit

The feedback resistance  $R_F$  and the input capacitance form a zero in the noise gain that results in instability if left unchecked. To counteract the effect of the zero, a pole is inserted by adding the feedback capacitor ( $C_F$ ) into the noise gain transfer function. The [Transimpedance Considerations for High-Speed Amplifiers](#) application report discusses theories and equations that show how to compensate a transimpedance amplifier for a particular gain and input capacitance. The bandwidth and compensation equations from the application report are available in an Excel® calculator. [What You Need To Know About Transimpedance Amplifiers – Part 1](#) provides a link to the calculator.

The equations and calculators in the application report and blog posts referenced above are used to model the bandwidth ( $f_{-3dB}$ ) and noise ( $I_{RN}$ ) performance of the OPA858 configured as a TIA. The resultant performance is shown in [Figure 9-2](#) and [Figure 9-3](#). The left side Y-axis shows the closed-loop bandwidth performance, while the right side of the graph shows the integrated input referred noise. The noise bandwidth to calculate  $I_{RN}$ , for a fixed  $R_F$  and  $C_{PD}$  is set equal to the  $f_{-3dB}$  frequency.

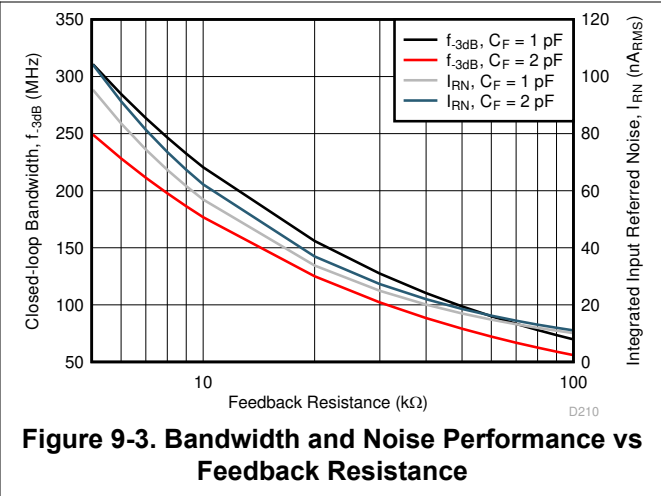
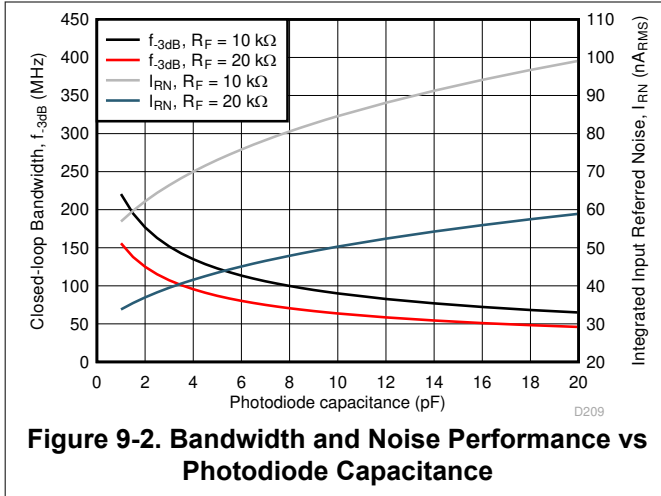


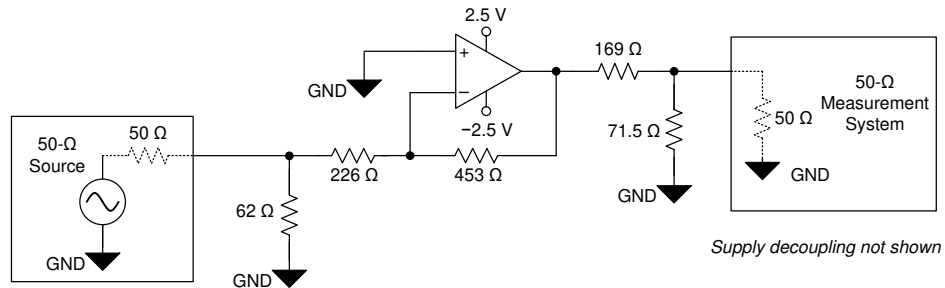
Figure 9-2 shows the amplifier performance as a function of photodiode capacitance ( $C_{PD}$ ) for  $R_F = 10\text{ k}\Omega$  and  $20\text{ k}\Omega$ . Increasing  $C_{PD}$  decreases the closed-loop bandwidth. To maximize bandwidth, reduce any stray parasitic capacitance from the PCB. The OPA858 is designed with  $0.8\text{ pF}$  of total input capacitance to minimize the effect on system performance.

Figure 9-3 shows the amplifier performance as a function of  $R_F$  for  $C_{PD} = 1\text{ pF}$  and  $2\text{ pF}$ . Increasing  $R_F$  results in lower bandwidth. To maximize the signal-to-noise ratio (SNR) in an optical front-end system, maximize the gain in the TIA stage. Increasing  $R_F$  by a factor of  $X$  increases the signal level by  $X$ , but only increases the resistor noise contribution by  $\sqrt{X}$ , thereby improving SNR.

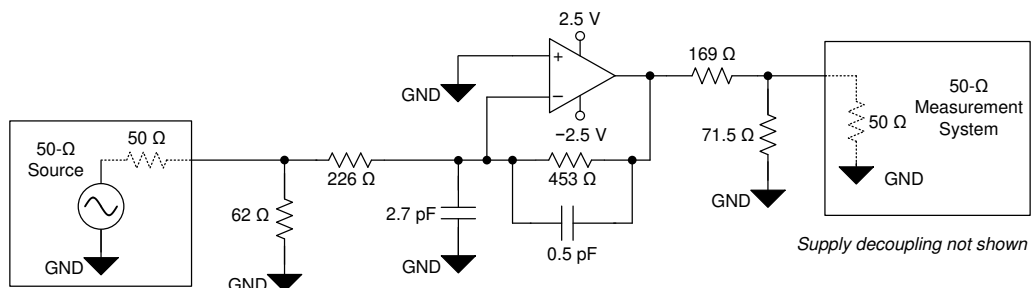
## 9.2 Typical Applications

### 9.2.1 TIA in an Optical Front-End System

The high GBWP, low input voltage noise, and high slew rate of the OPA858 makes the device a viable wideband, high input impedance voltage amplifier.



**Figure 9-4. OPA858 in a Gain of  $-2V/V$  (No Noise Gain Shaping)**



**Figure 9-5. OPA858 in a Gain of  $-2V/V$  (With Noise Gain Shaping)**

### 9.2.1.1 Design Requirements

Design a high-bandwidth, high-gain, voltage amplifier with the design requirements listed in [Table 9-1](#). An inverting amplifier configuration is chosen here; however, the theory is applicable to a noninverting configuration as well. In an inverting configuration the signal gain and noise gain transfer functions are not equal, unlike the noninverting configuration.

**Table 9-1. Design Requirements**

TARGET BANDWIDTH (MHz)	SIGNAL GAIN (V/V)	FEEDBACK RESISTANCE (Ω)	FREQUENCY PEAKING (dB)
> 750	-2	453	< 2

### 9.2.1.2 Detailed Design Procedure

The OPA858 is compensated to have less than 1 dB of peaking in a gain of 7 V/V. Using the device in lower gains results in increased peaking and potential instability. [Figure 9-4](#) shows the OPA858 configured in a signal gain of -2 V/V. The dc noise gain ( $1/\beta$ ) of the amplifier is affected by the 62-Ω termination resistor and the 50-Ω source resistor and is given by [Equation 1](#). At higher frequencies the noise gain is affected by reactive elements such as inductors and capacitors. These include both discrete board components as well as printed circuit board (PCB) parasitics.

$$\text{Noise Gain} = \frac{1}{\beta} = \left( 1 + \frac{453 \Omega}{226 \Omega + (62 \Omega \parallel 50 \Omega)} \right) = 2.79 \text{ V/V} = 5.04 \text{ dB} \quad (1)$$

The stability and phase margin of the amplifier depend on the loop gain of the amplifier, which is the product of the  $A_{OL}$  and the feedback factor ( $\beta$ ) of the amplifier. The  $\beta$  of a negative-feedback loop system is the portion of the output signal that is fed back to the input, and in the case of an amplifier is the inverse of the noise gain. The noise gain of the amplifier at high frequencies can be increased by adding an input capacitor and a feedback capacitor as [Figure 9-5](#) shows. If done carefully, increasing  $1/\beta$  improves the phase margin just as any amplifier is more stable in a high gain configuration versus a unity-gain buffer configuration. The modified network with the added capacitors alters the high-frequency noise gain, but does not alter the signal gain. The [AN-1604 Decompensated Operational Amplifiers](#) application report provides a detailed analysis of noise gain-shaping techniques for decompensated amplifiers and shows how to choose external resistors and capacitor values.

[Figure 9-6](#) shows the uncompensated frequency response of the OPA858 configured as shown in [Figure 9-4](#). Without any added noise gain shaping components, the OPA858 shows approximately 13 dB of peaking.

[Figure 9-7](#) shows the noise gain compensated frequency response of the OPA858 configured as shown in [Figure 9-5](#). The noise gain shaping elements reduce the peaking to less than 1.5 dB. The 2.7-pF input capacitor, the input capacitance of the amplifier, the gain resistor, and the feedback resistor create a zero in the noise gain at a frequency  $f$ , as [Equation 2](#) shows.

$$f = \frac{1}{2\pi(R_F \parallel R_G)C_{IN}} \quad (2)$$

where

- $R_F$  is the feedback resistor
- $R_G$  is the input or gain resistor (includes the effect of the source and termination resistor)
- $C_{IN}$  is the total input capacitance, which includes the external 2.7-pF capacitor, the amplifier input capacitance, and any parasitic PCB capacitance.

The zero in Equation 2 increases the noise gain at higher frequencies, which is important when compensating a decompensated amplifier. However, the noise gain zero reduces the loop gain phase which results in a lower phase margin. To counteract the phase reduction due to the noise gain zero, add a pole to the noise gain curve by inserting the 0.5-pF feedback capacitor. The pole occurs at a frequency shown in Equation 3. The noise gain pole and zero locations must be selected so that the rate-of-closure between the magnitude curves of  $A_{OL}$  and  $1/\beta$  is approximately 20 dB. To provide this rate of closure, the noise gain pole must occur before the  $1/\beta$  magnitude curve intersects the  $A_{OL}$  magnitude curve. In other words, the noise gain pole must occur before  $|A_{OL}| = |1/\beta|$ . The point at which the two curves intersect is known as the loop gain crossover frequency.

$$f = \frac{1}{2\pi R_F C_F} \quad (3)$$

where

- $C_F$  is the feedback capacitor (includes any added PCB parasitic)

For more information on op-amp stability, watch the [TI Precision Lab series on stability](#) video.

### 9.2.1.3 Application Curves

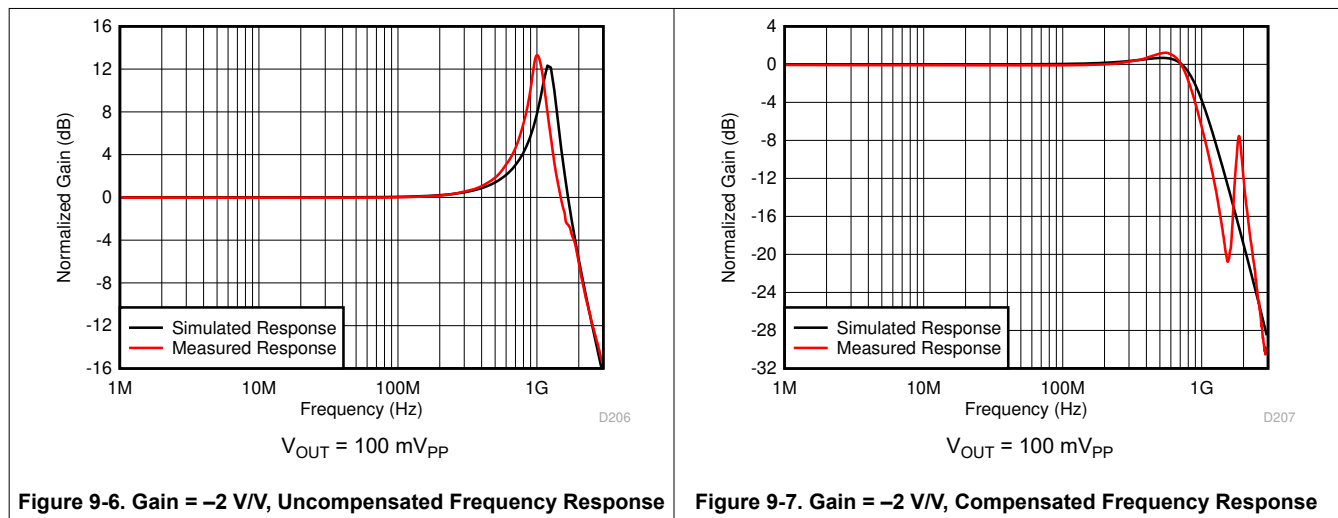
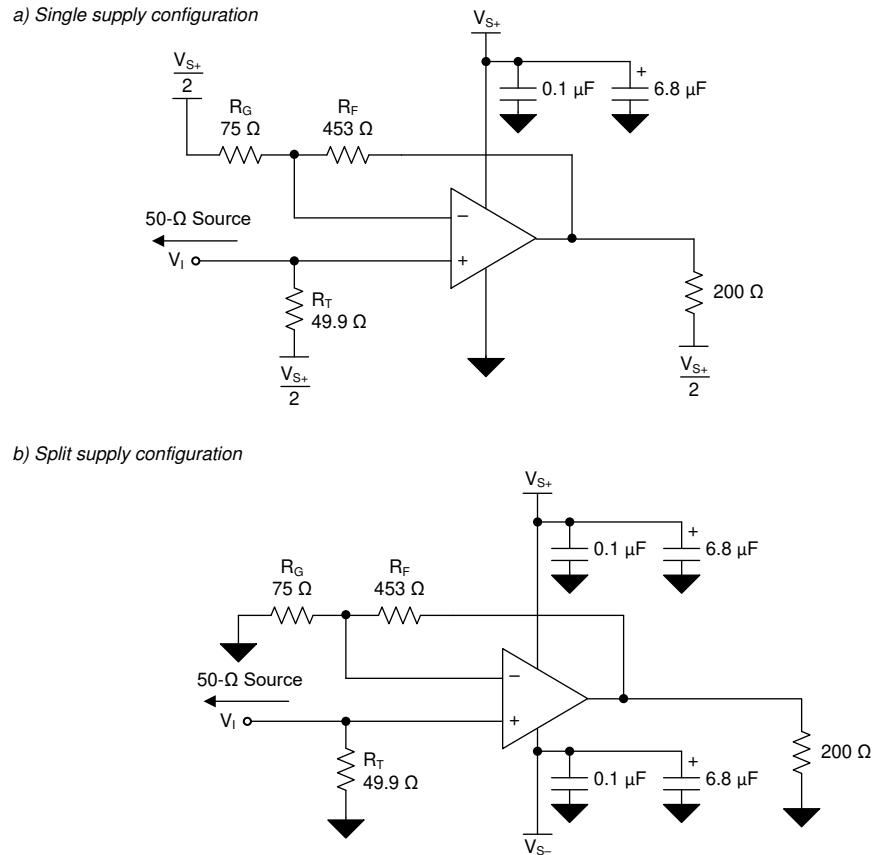


Figure 9-6. Gain =  $-2 \text{ V/V}$ , Uncompensated Frequency Response

Figure 9-7. Gain =  $-2 \text{ V/V}$ , Compensated Frequency Response

### 9.3 Power Supply Recommendations

The OPA858 operates on supplies from 3.3 V to 5.25 V. The OPA858 operates on single-sided supplies, split and balanced bipolar supplies, and unbalanced bipolar supplies. Because the OPA858 does not feature rail-to-rail inputs or outputs, the input common-mode and output swing ranges are limited at 3.3-V supplies.



**Figure 9-8. Split and Single Supply Circuit Configuration**

## 9.4 Layout

### 9.4.1 Layout Guidelines

Achieving optimum performance with a high-frequency amplifier like the OPA858 requires careful attention to board layout parasitics and external component types. Recommendations that optimize performance include:

- Minimize parasitic capacitance from the signal I/O pins to ac ground.** Parasitic capacitance on the output and inverting input pins can cause instability. To reduce unwanted capacitance, cut out the power and ground traces under the signal input and output pins. Otherwise, ground and power planes must be unbroken elsewhere on the board. When configuring the amplifier as a TIA, if the required feedback capacitor is less than 0.15 pF, consider using two series resistors, each of half the value of a single resistor in the feedback loop to minimize the parasitic capacitance from the resistor.
- Minimize the distance (less than 0.25-in) from the power-supply pins to high-frequency bypass capacitors.** Use high-quality, 100-pF to 0.1- $\mu$ F, C0G and NPO-type decoupling capacitors with voltage ratings at least three times greater than the amplifiers maximum power supplies. This configuration makes sure that there is a low-impedance path to the amplifiers power-supply pins across the amplifiers gain bandwidth specification. At the device pins, do not allow the ground and power plane layout to be in close proximity to the signal I/O pins. Avoid narrow power and ground traces to minimize inductance between the pins and the decoupling capacitors. The power-supply connections must always be decoupled with these capacitors. Larger (2.2- $\mu$ F to 6.8- $\mu$ F) decoupling capacitors that are effective at lower frequency must be used on the supply pins. Place these decoupling capacitors further from the device. Share the decoupling capacitors among several devices in the same area of the printed circuit board (PCB).
- Careful selection and placement of external components preserves the high-frequency performance of the OPA858.** Use low-reactance resistors. Surface-mount resistors work best and allow a tighter overall layout. Never use wire-wound resistors in a high-frequency application. Because the output pin and inverting input pin are the most sensitive to parasitic capacitance, always position the feedback and series output resistor, if any, as close to the output pin as possible. Place other network components (such as noninverting input termination resistors) close to the package. Even with a low parasitic capacitance shunting the external resistors, high resistor values create significant time constants that can degrade performance. When configuring the OPA858 as a voltage amplifier, keep resistor values as low as possible and consistent with load driving considerations. Decreasing the resistor values keeps the resistor noise terms low and minimizes the effect of the parasitic capacitance. However, lower resistor values increase the dynamic power consumption because  $R_F$  and  $R_G$  become part of the output load network of the amplifier.

### 9.4.2 Layout Example

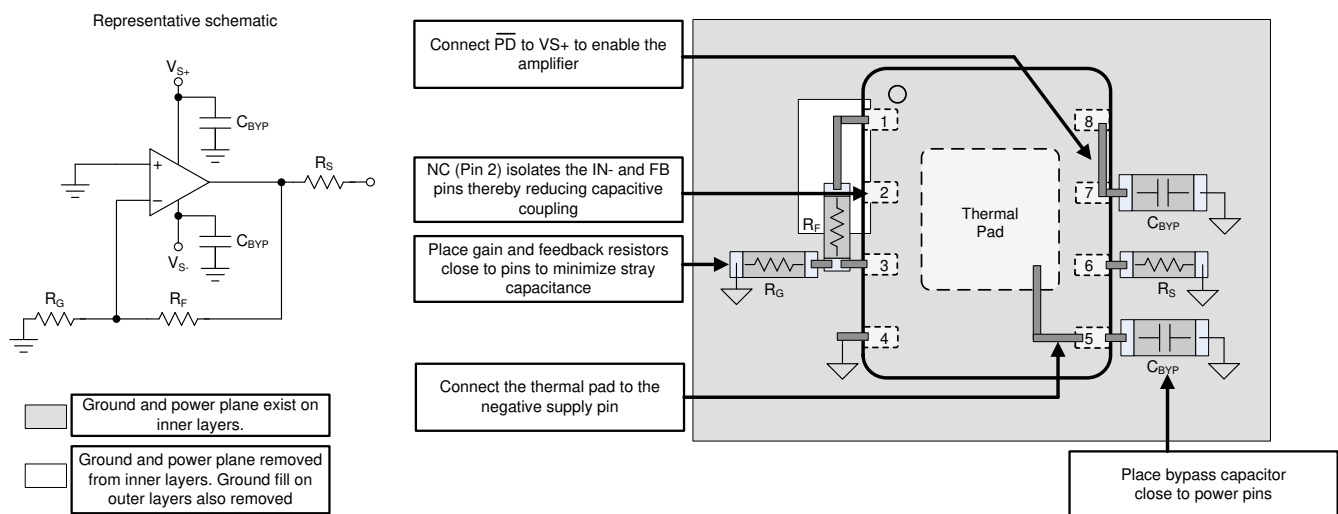


Figure 9-9. Layout Recommendation

When configuring the OPA858 as a transimpedance amplifier, take care to minimize the inductance between the avalanche photodiode (APD) and the amplifier. Always place the photodiode on the same side of the PCB as the amplifier. Placing the amplifier and the APD on opposite sides of the PCB increases the parasitic effects due to via inductance. APD packaging can be quite large, which often requires the APD to be placed further away from the amplifier than ideal. [Figure 9-10](#) shows that the added distance between the two device results in increased inductance between the APD and op amp feedback network. The added inductance is detrimental to a decompensated amplifiers stability because this inductance isolates the APD capacitance from the noise-gain transfer function. The noise gain is given by [Equation 4](#). The added PCB trace inductance between the feedback network increases the denominator in [Equation 4](#) thereby reducing the noise gain and the phase margin. In cases where a leaded APD in a TO-can package is used, further minimize inductance by cutting the leads of the TO-can package as short as possible.

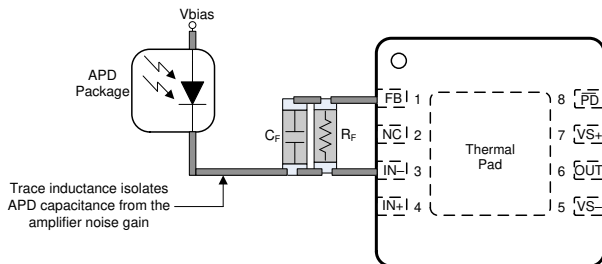
$$\text{Noise Gain} = \left(1 + \frac{Z_F}{Z_{IN}}\right) \tag{4}$$

where

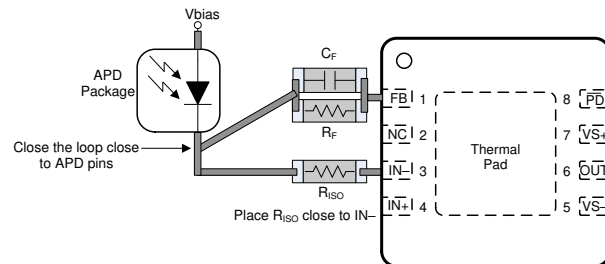
- $Z_F$  is the total impedance of the feedback network.
- $Z_{IN}$  is the total impedance of the input network.

The layout shown in [Figure 9-10](#) is improved by following some of the guidelines in [Figure 9-11](#). The two key rules to follow are:

1. Add an isolation resistor  $R_{ISO}$  as close as possible to the inverting input of the amplifier. Select the value of  $R_{ISO}$  to be between  $10\ \Omega$  and  $20\ \Omega$ . The resistor dampens the potential resonance caused by the trace inductance and the amplifiers internal capacitance.
2. Close the loop between the feedback elements ( $R_F$  and  $C_F$ ) and  $R_{ISO}$  as close to the APD pins as possible. This closure provides a more balanced layout and reduces the inductive isolation between the APD and the feedback network.



**Figure 9-10. Nonideal TIA Layout**



**Figure 9-11. Improved TIA Layout**

## 10 Device and Documentation Support

### 10.1 Device Support

#### 10.1.1 Development Support

- [LIDAR Pulsed Time of Flight Reference Design](#)
- [LIDAR-Pulsed Time-of-Flight Reference Design Using High-Speed Data Converters](#)
- [Wide Bandwidth Optical Front-end Reference Design](#)

### 10.2 Documentation Support

#### 10.2.1 Related Documentation

For related documentation, see the following:

- Texas Instruments, [OPA858EVM user's guide](#)
- Texas Instruments, [Training Video: High-Speed Transimpedance Amplifier Design Flow](#)
- Texas Instruments, [Training Video: How to Design Transimpedance Amplifier Circuits](#)
- Texas Instruments, [Training Video: How to Convert a TINA-TI Model into a Generic SPICE Model](#)
- Texas Instruments, [Transimpedance Considerations for High-Speed Amplifiers application report](#)
- Texas Instruments, [What You Need To Know About Transimpedance Amplifiers – Part 1](#)
- Texas Instruments, [What You Need To Know About Transimpedance Amplifiers – Part 2](#)

### 10.3 Receiving Notification of Documentation Updates

To receive notification of documentation updates, navigate to the device product folder on [ti.com](http://ti.com). Click on *Notifications* to register and receive a weekly digest of any product information that has changed. For change details, review the revision history included in any revised document.

### 10.4 Support Resources

[TI E2E™ support forums](#) are an engineer's go-to source for fast, verified answers and design help — straight from the experts. Search existing answers or ask your own question to get the quick design help you need.

Linked content is provided "AS IS" by the respective contributors. They do not constitute TI specifications and do not necessarily reflect TI's views; see TI's [Terms of Use](#).

### 10.5 Trademarks

TI E2E™ is a trademark of Texas Instruments.

Excel® is a registered trademark of Microsoft Corporation.

All trademarks are the property of their respective owners.

### 10.6 Electrostatic Discharge Caution



This integrated circuit can be damaged by ESD. Texas Instruments recommends that all integrated circuits be handled with appropriate precautions. Failure to observe proper handling and installation procedures can cause damage.

ESD damage can range from subtle performance degradation to complete device failure. Precision integrated circuits may be more susceptible to damage because very small parametric changes could cause the device not to meet its published specifications.

### 10.7 Glossary

[TI Glossary](#) This glossary lists and explains terms, acronyms, and definitions.

## 11 Revision History

NOTE: Page numbers for previous revisions may differ from page numbers in the current version.

Changes from Revision A (July 2018) to Revision B (May 2025)	Page
• Added the bare die package and associated content to data sheet.....	1

---

**Changes from Revision \* (April 2018) to Revision A (July 2018)****Page**

- Changed from Advance Information to Production Data (active)..... **1**
- 

**12 Mechanical, Packaging, and Orderable Information**

The following pages include mechanical, packaging, and orderable information. This information is the most current data available for the designated devices. This data is subject to change without notice and revision of this document. For browser-based versions of this data sheet, refer to the left-hand navigation.

**PACKAGING INFORMATION**

Orderable part number	Status (1)	Material type (2)	Package   Pins	Package qty   Carrier	RoHS (3)	Lead finish/ Ball material (4)	MSL rating/ Peak reflow (5)	Op temp (°C)	Part marking (6)
<a href="#">OPA858IDSGR</a>	Active	Production	WSON (DSG)   8	3000   LARGE T&R	Yes	NIPDAU	Level-1-260C-UNLIM	-40 to 125	X858
OPA858IDSGR.B	Active	Production	WSON (DSG)   8	3000   LARGE T&R	Yes	NIPDAU	Level-1-260C-UNLIM	-40 to 125	X858
<a href="#">OPA858IDSGT</a>	Active	Production	WSON (DSG)   8	250   SMALL T&R	Yes	SN	Level-1-260C-UNLIM	-40 to 125	X858
OPA858IDSGT.B	Active	Production	WSON (DSG)   8	250   SMALL T&R	Yes	SN	Level-1-260C-UNLIM	-40 to 125	X858
<a href="#">OPA858YR</a>	Active	Production	DIESALE (Y)   0	3000   LARGE T&R	Yes	Call TI	N/A for Pkg Type	-40 to 125	

(1) **Status:** For more details on status, see our [product life cycle](#).

(2) **Material type:** When designated, preproduction parts are prototypes/experimental devices, and are not yet approved or released for full production. Testing and final process, including without limitation quality assurance, reliability performance testing, and/or process qualification, may not yet be complete, and this item is subject to further changes or possible discontinuation. If available for ordering, purchases will be subject to an additional waiver at checkout, and are intended for early internal evaluation purposes only. These items are sold without warranties of any kind.

(3) **RoHS values:** Yes, No, RoHS Exempt. See the [TI RoHS Statement](#) for additional information and value definition.

(4) **Lead finish/Ball material:** Parts may have multiple material finish options. Finish options are separated by a vertical ruled line. Lead finish/Ball material values may wrap to two lines if the finish value exceeds the maximum column width.

(5) **MSL rating/Peak reflow:** The moisture sensitivity level ratings and peak solder (reflow) temperatures. In the event that a part has multiple moisture sensitivity ratings, only the lowest level per JEDEC standards is shown. Refer to the shipping label for the actual reflow temperature that will be used to mount the part to the printed circuit board.

(6) **Part marking:** There may be an additional marking, which relates to the logo, the lot trace code information, or the environmental category of the part.

Multiple part markings will be inside parentheses. Only one part marking contained in parentheses and separated by a "-" will appear on a part. If a line is indented then it is a continuation of the previous line and the two combined represent the entire part marking for that device.

**Important Information and Disclaimer:** The information provided on this page represents TI's knowledge and belief as of the date that it is provided. TI bases its knowledge and belief on information provided by third parties, and makes no representation or warranty as to the accuracy of such information. Efforts are underway to better integrate information from third parties. TI has taken and continues to take reasonable steps to provide representative and accurate information but may not have conducted destructive testing or chemical analysis on incoming materials and chemicals. TI and TI suppliers consider certain information to be proprietary, and thus CAS numbers and other limited information may not be available for release.

In no event shall TI's liability arising out of such information exceed the total purchase price of the TI part(s) at issue in this document sold by TI to Customer on an annual basis.

**OTHER QUALIFIED VERSIONS OF OPA858 :**

- Automotive : [OPA858-Q1](#)

NOTE: Qualified Version Definitions:

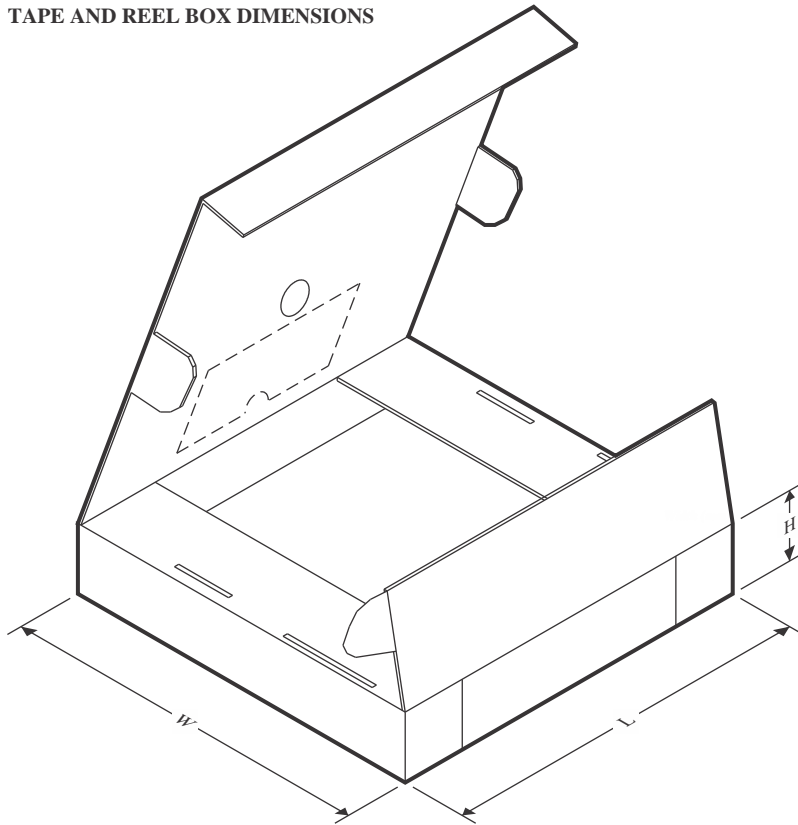
- Automotive - Q100 devices qualified for high-reliability automotive applications targeting zero defects

**TAPE AND REEL INFORMATION**

**QUADRANT ASSIGNMENTS FOR PIN 1 ORIENTATION IN TAPE**


\*All dimensions are nominal

Device	Package Type	Package Drawing	Pins	SPQ	Reel Diameter (mm)	Reel Width W1 (mm)	A0 (mm)	B0 (mm)	K0 (mm)	P1 (mm)	W (mm)	Pin1 Quadrant
OPA858IDSGR	WSON	DSG	8	3000	180.0	8.4	2.3	2.3	1.15	4.0	8.0	Q2
OPA858IDSGT	WSON	DSG	8	250	180.0	8.4	2.3	2.3	1.15	4.0	8.0	Q2
OPA858YR	DIESALE	Y	0	3000	180.0	8.4	0.74	0.78	0.45	4.0	8.0	Q1

**TAPE AND REEL BOX DIMENSIONS**


\*All dimensions are nominal

Device	Package Type	Package Drawing	Pins	SPQ	Length (mm)	Width (mm)	Height (mm)
OPA858IDSGR	WSON	DSG	8	3000	210.0	185.0	35.0
OPA858IDSGT	WSON	DSG	8	250	210.0	185.0	35.0
OPA858YR	DIESALE	Y	0	3000	210.0	185.0	35.0

## GENERIC PACKAGE VIEW

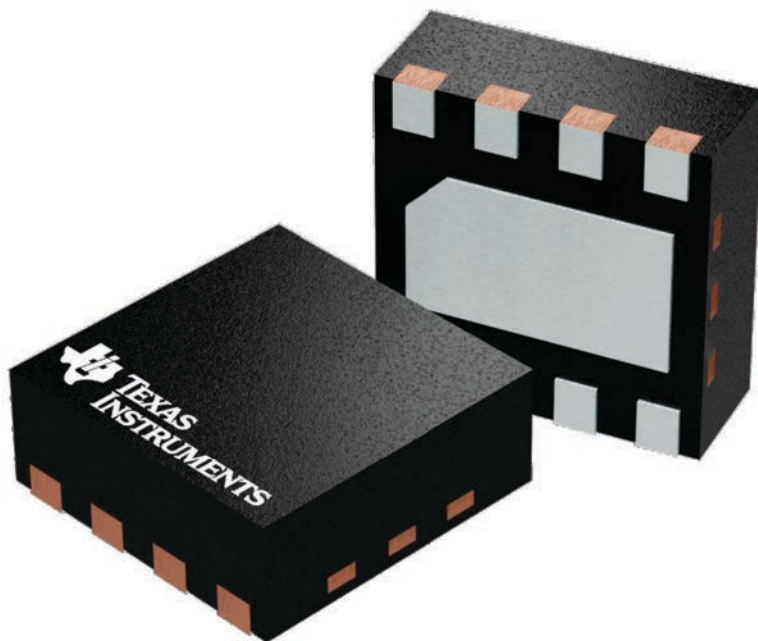
**DSG 8**

**WSON - 0.8 mm max height**

2 x 2, 0.5 mm pitch

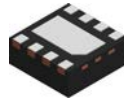
PLASTIC SMALL OUTLINE - NO LEAD

This image is a representation of the package family, actual package may vary.  
Refer to the product data sheet for package details.



4224783/A

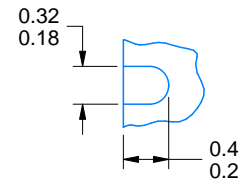
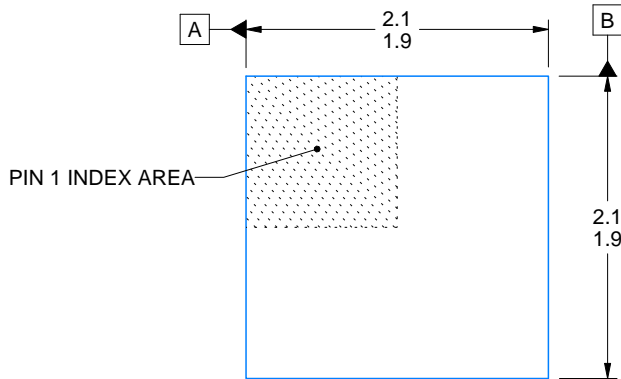
# DSG0008A



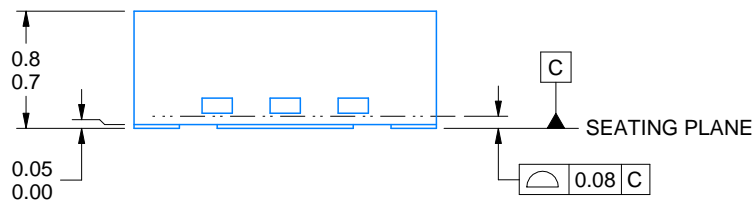
# PACKAGE OUTLINE

## WSON - 0.8 mm max height

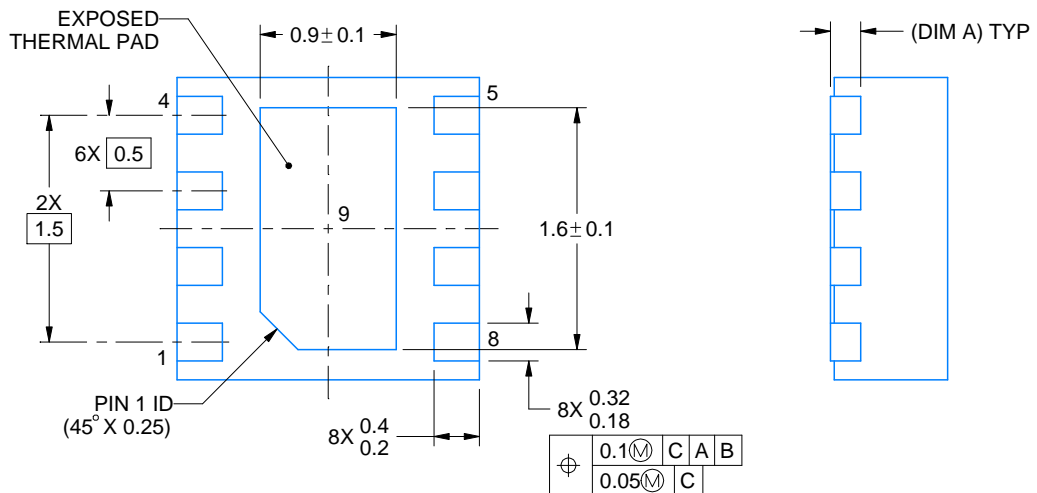
PLASTIC SMALL OUTLINE - NO LEAD



ALTERNATIVE TERMINAL SHAPE TYPICAL



SIDE WALL METAL THICKNESS DIM A	
OPTION 1	OPTION 2
0.1	0.2



4218900/E 08/2022

### NOTES:

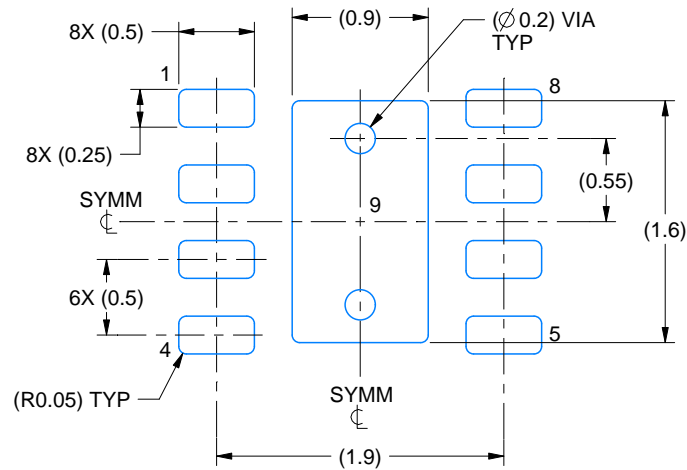
1. All linear dimensions are in millimeters. Any dimensions in parenthesis are for reference only. Dimensioning and tolerancing per ASME Y14.5M.
2. This drawing is subject to change without notice.
3. The package thermal pad must be soldered to the printed circuit board for thermal and mechanical performance.

# EXAMPLE BOARD LAYOUT

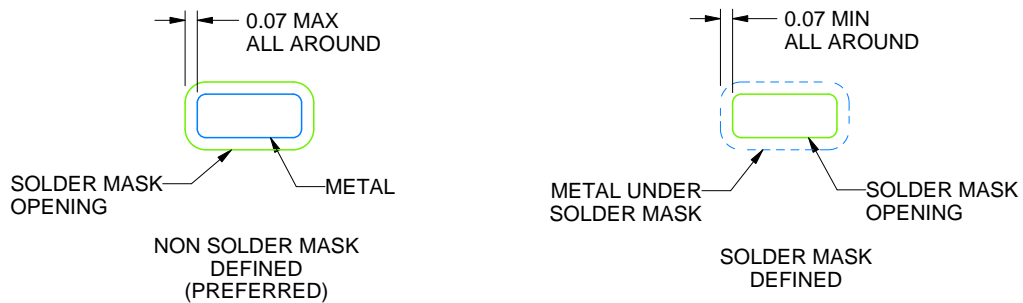
DSG0008A

WSON - 0.8 mm max height

PLASTIC SMALL OUTLINE - NO LEAD



LAND PATTERN EXAMPLE  
SCALE:20X



SOLDER MASK DETAILS

4218900/E 08/2022

NOTES: (continued)

4. This package is designed to be soldered to a thermal pad on the board. For more information, see Texas Instruments literature number SLUA271 ([www.ti.com/lit/slua271](http://www.ti.com/lit/slua271)).
5. Vias are optional depending on application, refer to device data sheet. If any vias are implemented, refer to their locations shown on this view. It is recommended that vias under paste be filled, plugged or tented.



## IMPORTANT NOTICE AND DISCLAIMER

TI PROVIDES TECHNICAL AND RELIABILITY DATA (INCLUDING DATASHEETS), DESIGN RESOURCES (INCLUDING REFERENCE DESIGNS), APPLICATION OR OTHER DESIGN ADVICE, WEB TOOLS, SAFETY INFORMATION, AND OTHER RESOURCES "AS IS" AND WITH ALL FAULTS, AND DISCLAIMS ALL WARRANTIES, EXPRESS AND IMPLIED, INCLUDING WITHOUT LIMITATION ANY IMPLIED WARRANTIES OF MERCHANTABILITY, FITNESS FOR A PARTICULAR PURPOSE OR NON-INFRINGEMENT OF THIRD PARTY INTELLECTUAL PROPERTY RIGHTS.

These resources are intended for skilled developers designing with TI products. You are solely responsible for (1) selecting the appropriate TI products for your application, (2) designing, validating and testing your application, and (3) ensuring your application meets applicable standards, and any other safety, security, regulatory or other requirements.

These resources are subject to change without notice. TI grants you permission to use these resources only for development of an application that uses the TI products described in the resource. Other reproduction and display of these resources is prohibited. No license is granted to any other TI intellectual property right or to any third party intellectual property right. TI disclaims responsibility for, and you fully indemnify TI and its representatives against any claims, damages, costs, losses, and liabilities arising out of your use of these resources.

TI's products are provided subject to [TI's Terms of Sale](#), [TI's General Quality Guidelines](#), or other applicable terms available either on [ti.com](#) or provided in conjunction with such TI products. TI's provision of these resources does not expand or otherwise alter TI's applicable warranties or warranty disclaimers for TI products. Unless TI explicitly designates a product as custom or customer-specified, TI products are standard, catalog, general purpose devices.

TI objects to and rejects any additional or different terms you may propose.

Copyright © 2026, Texas Instruments Incorporated

Last updated 10/2025