

SNx4AHCT540 Octal Buffers/Drivers With 3-State Outputs

1 Features

- Inputs are TTL-voltage compatible
- Latch-up performance exceeds 250mA per JESD 17
- ESD protection exceeds JESD 22
 - 2000V human-body model (A114-A)
 - 200V machine model (A115-A)
 - 1000V charged-device model (C101)

2 Description

The 'AHCT540 octal buffers/drivers are ideal for driving bus lines or buffer memory address registers. These devices feature inputs and outputs on opposite sides of the package to facilitate printed circuit board layout.

Device Information

PART NUMBER	PACKAGE ⁽¹⁾	PACKAGE SIZE ⁽²⁾	BODY SIZE ⁽³⁾
SNx4AHCT540	N (PDIP, 20)	24.33mm × 9.4mm	24.33mm × 6.35mm
	DB (SSOP, 20)	7.2mm × 7.8mm	7.2mm × 5.3mm
	PW (TSSOP, 20)	6.50mm × 6.4mm	6.50mm × 4.40mm
	DGV (TVSOP, 20)	5.00mm × 6.4mm	5.00mm × 4.40mm
	DW (SOIC, 20)	12.80mm × 10.3mm	12.80mm × 7.50mm
	J (CDIP, 20)	24.2mm × 7.62mm	24.2 mm × 6.92mm

- (1) For more information, see [Mechanical, Packaging, and Orderable Information](#).
- (2) The package size (length × width) is a nominal value and includes pins, where applicable.
- (3) The body size (length × width) is a nominal value and does not include pins.

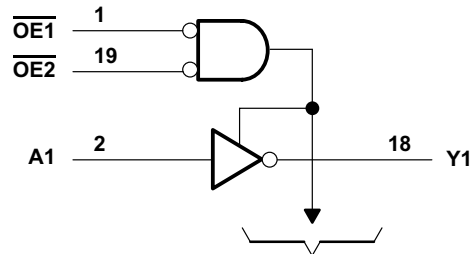

To Seven Other Channels
Logic Diagram (Positive Logic)



Table of Contents

1 Features	1	6.3 Device Functional Modes.....	7
2 Description	1	7 Application and Implementation	8
3 Pin Configuration and Functions	3	7.1 Power Supply Recommendations.....	8
4 Specifications	4	7.2 Layout.....	8
4.1 Absolute Maximum Ratings.....	4	8 Device and Documentation Support	9
4.2 ESD Ratings.....	4	8.1 Documentation Support (Analog).....	9
4.3 Recommended Operating Conditions.....	4	8.2 Receiving Notification of Documentation Updates.....	9
4.4 Thermal Information.....	4	8.3 Support Resources.....	9
4.5 Electrical Characteristics.....	5	8.4 Trademarks.....	9
4.6 Switching Characteristics.....	5	8.5 Electrostatic Discharge Caution.....	9
4.7 Operating Characteristics.....	5	8.6 Glossary.....	9
5 Parameter Measurement Information	6	9 Revision History	9
6 Detailed Description	7	10 Mechanical, Packaging, and Orderable Information	9
6.1 Overview.....	7		
6.2 Functional Block Diagram.....	7		

3 Pin Configuration and Functions

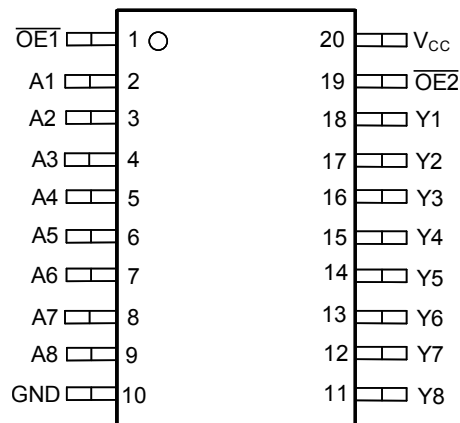

Figure 3-1. SN54AHCT540: J Package, 20-Pin CDIP; SN74AHCT540: DB, DGV, DW, N, NS, or PW Package; 20-Pin SSOP, TVSOP, SOIC, PDIP, PDIP, or TSSOP(Top View)

Table 3-1. Pin Functions

PIN		I/O	DESCRIPTION
NO.	NAME		
1	$\overline{OE1}$	I	Output Enable 1
2	A1	I	A1 Input
3	A2	I	A2 Input
4	A3	I	A3 Input
5	A4	I	A4 Input
6	A5	I	A5 Input
7	A6	I	A6 Input
8	A7	I	A7 Input
9	A8	I	A8 Input
10	GND	—	Ground
11	Y8	O	Y8 Output
12	Y7	O	Y7 Output
13	Y6	O	Y6 Output
14	Y5	O	Y5 Output
15	Y4	O	Y4 Output
16	Y3	O	Y3 Output
17	Y2	O	Y2 Output
18	Y1	O	Y1 Output
19	$\overline{OE2}$	I	Output Enable 2
20	V _{CC}	—	Power Pin

4 Specifications

4.1 Absolute Maximum Ratings

over operating free-air temperature range (unless otherwise noted)⁽¹⁾

		MIN	MAX	UNIT
V _{CC}	Supply voltage	-0.5	7	V
V _I ⁽²⁾	Input voltage	-0.5	7	V
V _O ⁽²⁾	Output voltage	-0.5	V _{CC} + 0.5	V
I _{IK}	Input clamp current	(V _I < 0)	-20	mA
I _{OK}	Output clamp current	(V _O < 0 or V _O > V _{CC})	±20	mA
I _O	Continuous output current	(V _O = 0 to V _{CC})	±25	mA
	Continuous current through V _{CC} or GND		±75	mA
T _{stg}	Storage temperature range	-65	150	°C

- (1) Stresses beyond those listed under “absolute maximum ratings” may cause permanent damage to the device. These are stress ratings only, and functional operation of the device at these or any other conditions beyond those indicated under “recommended operating conditions” is not implied. Exposure to absolute-maximum-rated conditions for extended periods may affect device reliability.
- (2) The input and output voltage ratings may be exceeded if the input and output current ratings are observed.

4.2 ESD Ratings

		VALUE	UNIT
V _(ESD)	Electrostatic discharge	Human body model (HBM), per ANSI/ESDA/JEDEC JS-001, all pins ⁽¹⁾	±2000
		Charged device model (CDM), per JEDEC specification JESD22-C101, all pins ⁽²⁾	±1000

- (1) JEDEC document JEP155 states that 500-V HBM allows safe manufacturing with a standard ESD control process.
- (2) JEDEC document JEP157 states that 250-V CDM allows safe manufacturing with a standard ESD control process.

4.3 Recommended Operating Conditions

over operating free-air temperature range (unless otherwise noted)⁽¹⁾

		SN54AHCT540		SN74AHCT540		UNIT
		MIN	MAX	MIN	MAX	
V _{CC}	Supply voltage	4.5	5.5	4.5	5.5	V
V _{IH}	High-level input voltage	2		2		V
V _{IL}	Low-level Input voltage		0.8		0.8	V
V _I	Input voltage	0	5.5	0	5.5	V
V _O	Output voltage	0	V _{CC}	0	V _{CC}	V
I _{OH}	High-level output current		-8		-8	mA
I _{OL}	Low-level output current		8		8	mA
Δt/Δv	Input Transition rise or fall rate		20		20	ns/V
T _A	Operating free-air temperature	-55	125	-40	125	°C

- (1) All unused inputs of the device must be held at V_{CC} or GND to ensure proper device operation. Refer to the TI application report, *Implications of Slow or Floating CMOS Inputs*, literature number [SCBA004](#).

4.4 Thermal Information

THERMAL METRIC ⁽¹⁾	SN74AHCT540						UNIT	
	DB (SSOP)	DGV (TVSOP)	DW (SOIC)	N (PDIP)	NS (PDIP)	PW (TSSOP)		
	20 PINS	20 PINS	20 PINS	20 PINS	20 PINS	20 PINS		
R _{θJA}	Junction-to-ambient thermal resistance	70	92	58	69	60	116.8	°C/W

- (1) For more information about traditional and new thermal metrics, see the *Semiconductor and IC Package Thermal Metrics* application report ([SPRA953](#)).

4.5 Electrical Characteristics

over operating free-air temperature range (unless otherwise noted)

PARAMETER	TEST CONDITIONS	V _{CC}	T _A = 25°C			T _A = -55°C TO 125°C		T _A = -40°C TO 85°C		T _A = -40°C TO 125°C		UNIT
						SN54AHCT540		SN74AHCT540		Recommended		
			MIN	TYP	MAX	MIN	MAX	MIN	MAX	MIN	MAX	
V _{OH}	I _{OH} = -50 μA	4.5 V	4.4	4.5		4.4		4.4		4.4	V	
	I _{OH} = -8 mA		3.94		3.8		3.8		3.8			
V _{OL}	I _{OL} = 50 μA	4.5 V			0.1		0.1		0.1		0.1	V
	I _{OH} = 8 mA				0.36		0.44		0.44		0.44	
I _I	V _I = 5.5 V or GND	0 V to 5.5 V			±0.1		±1 ⁽¹⁾		±1		±1	μA
I _{OZ}	V _O = V _{CC} or GND	5.5 V			±0.25		±2.5		±2.5		±2.5	μA
I _{CC}	V _I = V _{CC} or GND, I _O = 0	5.5 V			4		40		20		40	μA
ΔI _{CC} ⁽²⁾	One input at 3.4 V, Other inputs at V _{CC} or GND	5.5 V			1.35		1.5		1.5		1.5	mA
C _i	V _I = V _{CC} or GND	5 V			2	10			10			pF
C _O	V _O = V _{CC} or GND	5V			4							pF

(1) On products compliant to MIL-PRF-38535, this parameter is not production tested at V_{CC} = 0 V.

(2) This is the increase in supply current for each input at one of the specified TTL voltage levels, rather than 0 V or V_{CC}.

4.6 Switching Characteristics

over recommended operating free-air temperature range, V_{CC} = 5 V ± 0.5 V (unless otherwise noted) (see [Load Circuit and Voltage Waveforms](#))

PARAMETER	FROM (INPUT)	TO (OUTPUT)	LOAD CAPACITANCE	T _A = 25°C		T _A = -55°C TO 125°C		T _A = -40°C TO 85°C		T _A = -40°C TO 125°C		UNIT
						SN54AHCT540		SN54AHCT540		Recommended		
				TYP	MAX	MIN	MAX	MIN	MAX	MIN	MAX	
t _{PLH}	A	Y	C _L = 15 pF	4.0 ⁽¹⁾	6.0 ⁽¹⁾	1 ⁽¹⁾	7.5 ⁽¹⁾	1	7.5	1	7.5	ns
t _{PHL}				4.0 ⁽¹⁾	6.0 ⁽¹⁾	1 ⁽¹⁾	7.5 ⁽¹⁾	1	7.5	1	7.5	
t _{PZH}	\overline{OE}	Y	C _L = 15 pF	5.5 ⁽¹⁾	8.0 ⁽¹⁾	1 ⁽¹⁾	9 ⁽¹⁾	1	9.0	1	9.0	ns
t _{PZL}				5.5 ⁽¹⁾	8.0 ⁽¹⁾	1 ⁽¹⁾	9 ⁽¹⁾	1	9.0	1	9.0	
t _{PHZ}	\overline{OE}	Y	C _L = 15 pF	5.0 ⁽¹⁾	8.0 ⁽¹⁾	1 ⁽¹⁾	9 ⁽¹⁾	1	9	1	9	ns
t _{PLZ}				5.0 ⁽¹⁾	8.0 ⁽¹⁾	1 ⁽¹⁾	9 ⁽¹⁾	1	9	1	9	
t _{PLH}	A	Y	C _L = 50 pF	6.0	8.5	1	10	1	10	1	10	ns
t _{PHL}				6.0	8.5	1	10	1	10	1	10	
t _{PZH}	\overline{OE}	Y	C _L = 50 pF	7.5	11.0	1	12	1	12	1	12	ns
t _{PZL}				7.5	11.0	1	12	1	12	1	12	
t _{PHZ}	\overline{OE}	Y	C _L = 50 pF	8.0	11.0	1	12	1	12	1	12	ns
t _{PLZ}				8.0	11.0	1	12	1	12	1	12	
t _{sk(o)}			C _L = 50 pF		1 ⁽²⁾				1			

(1) On products compliant to MIL-PRF-38535, this parameter is not production tested.

(2) On products compliant to MIL-PRF-38535, this parameter does not apply

4.7 Operating Characteristics

V_{CC} = 5 V, T_A = 25°C

PARAMETER	TEST CONDITIONS	TYP	UNIT
C _{pd}	Power dissipation capacitance No load, f = 1 MHz	12	pF

5 Parameter Measurement Information

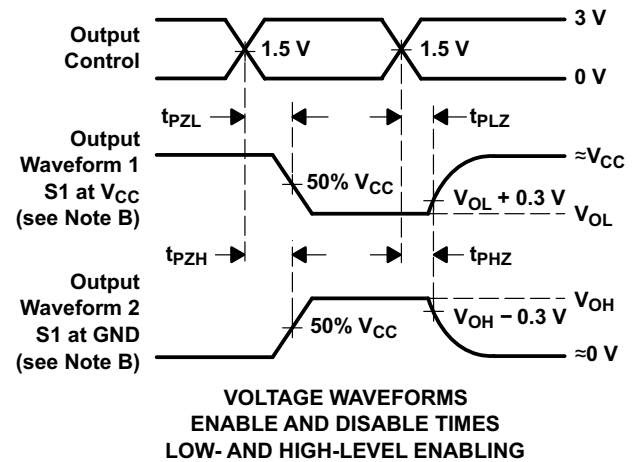
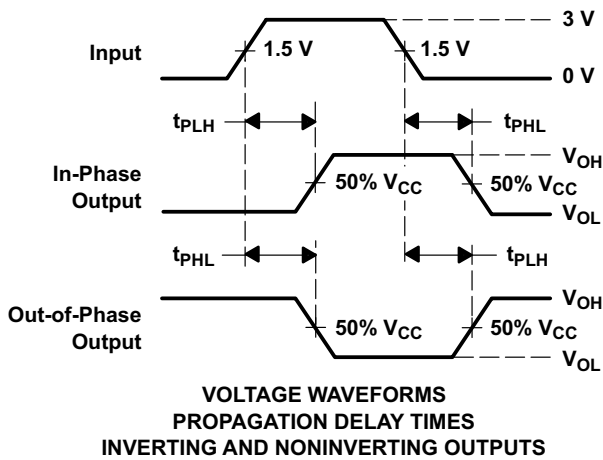
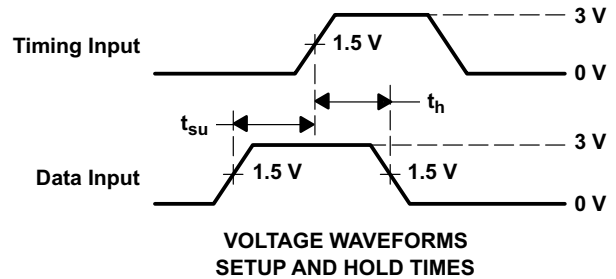
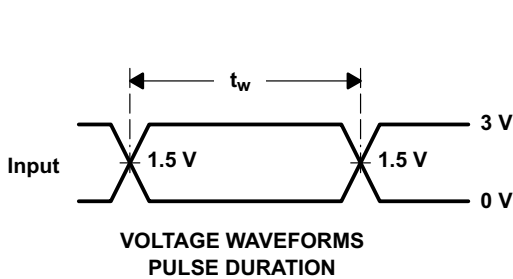
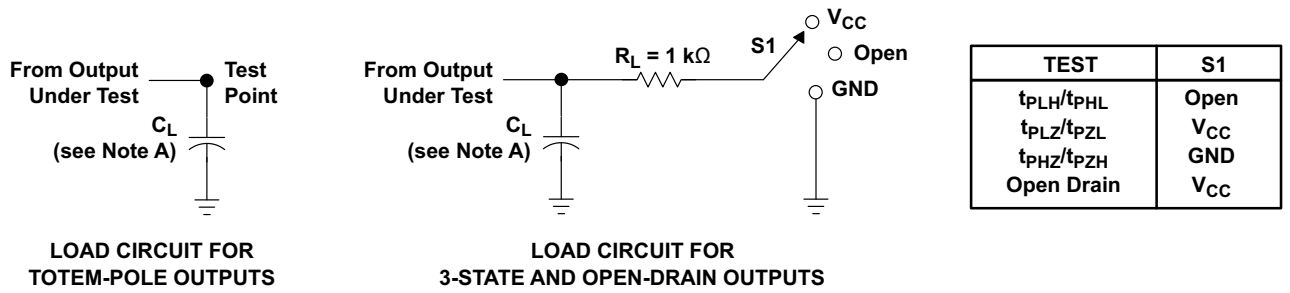

- A. C_L includes probe and jig capacitance.
- B. Waveform 1 is for an output with internal conditions such that the output is low except when disabled by the output control. Waveform 2 is for an output with internal conditions such that the output is high except when disabled by the output control.
- C. All input pulses are supplied by generators having the following characteristics: $PRR \leq 1\text{ MHz}$, $Z_O = 50\ \Omega$, $t_r \leq 3\text{ ns}$, $t_f \leq 3\text{ ns}$.
- D. The outputs are measured one at a time with one input transition per measurement.
- E. All parameters and waveforms are not applicable to all devices.

Figure 5-1. Load Circuit and Voltage Waveforms

6 Detailed Description

6.1 Overview

The 3-state control gate is a two-input AND gate with active-low inputs so that if either output-enable ($\overline{OE1}$ or $\overline{OE2}$) input is high, all corresponding outputs are in the high-impedance state. The outputs provide inverted data when they are not in the high-impedance state.

To ensure the high-impedance state during power up or power down, \overline{OE} should be tied to V_{CC} through a pullup resistor; the minimum value of the resistor is determined by the current-sinking capability of the driver.

6.2 Functional Block Diagram

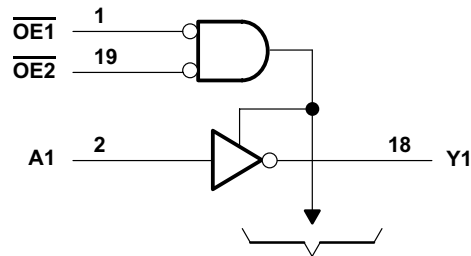

To Seven Other Channels
Figure 6-1. Logic Diagram (Positive Logic)

6.3 Device Functional Modes

Function Table

(Each Buffer/Driver) shows the device functions for each buffer and driver.

**Function Table
(Each Buffer/Driver)**

INPUTS			OUTPUT
$\overline{OE1}$	$\overline{OE2}$	A	Y
L	L	L	H
L	L	H	L
H	X	X	Z
X	H	X	Z

7 Application and Implementation

Note

Information in the following applications sections is not part of the TI component specification, and TI does not warrant its accuracy or completeness. TI's customers are responsible for determining suitability of components for their purposes, as well as validating and testing their design implementation to confirm system functionality.

7.1 Power Supply Recommendations

The power supply can be any voltage between the MIN and MAX supply voltage rating located in the [Recommended Operating Conditions](#) table. Each V_{CC} terminal should have a good bypass capacitor to prevent power disturbance. For devices with a single supply, 0.1 μF is recommended. If there are multiple V_{CC} terminals then 0.01 μF or 0.022 μF is recommended for each power terminal. It is acceptable to parallel multiple bypass caps to reject different frequencies of noise. A 0.1 μF and 1 μF are commonly used in parallel. The bypass capacitor should be installed as close to the power terminal as possible for best results.

7.2 Layout

7.2.1 Layout Guidelines

When using multiple bit logic devices, inputs should not float. In many cases, functions or parts of functions of digital logic devices are unused. Some examples are when only two inputs of a triple-input AND gate are used, or when only 3 of the 4-buffer gates are used. Such input pins should not be left unconnected because the undefined voltages at the outside connections result in undefined operational states. Specified in the [Figure 7-1](#) are rules that must be observed under all circumstances. All unused inputs of digital logic devices must be connected to a high or low bias to prevent them from floating. The logic level that should be applied to any particular unused input depends on the function of the device. Generally they will be tied to GND or V_{CC} , whichever makes more sense or is more convenient. It is acceptable to float outputs unless the part is a transceiver. If the transceiver has an output enable pin, it will disable the outputs section of the part when asserted. This will not disable the input section of the I/Os so they also cannot float when disabled.

7.2.2 Layout Example

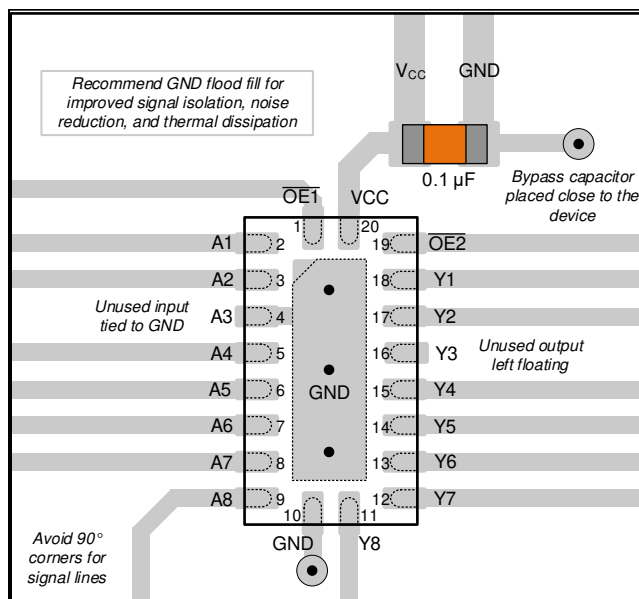

Figure 7-1. Example Layout for the SN74AHCT540

8 Device and Documentation Support

8.1 Documentation Support (Analog)

8.1.1 Related Links

The table below lists quick access links. Categories include technical documents, support and community resources, tools and software, and quick access to sample or buy.

Table 8-1. Related Links

PARTS	PRODUCT FOLDER	SAMPLE & BUY	TECHNICAL DOCUMENTS	TOOLS & SOFTWARE	SUPPORT & COMMUNITY
SN54AHCT540	Click here	Click here	Click here	Click here	Click here
SN74AHCT540	Click here	Click here	Click here	Click here	Click here

8.2 Receiving Notification of Documentation Updates

To receive notification of documentation updates, navigate to the device product folder on ti.com. Click on *Notifications* to register and receive a weekly digest of any product information that has changed. For change details, review the revision history included in any revised document.

8.3 Support Resources

[TI E2E™ support forums](#) are an engineer's go-to source for fast, verified answers and design help — straight from the experts. Search existing answers or ask your own question to get the quick design help you need.

Linked content is provided "AS IS" by the respective contributors. They do not constitute TI specifications and do not necessarily reflect TI's views; see TI's [Terms of Use](#).

8.4 Trademarks

TI E2E™ is a trademark of Texas Instruments.
All trademarks are the property of their respective owners.

8.5 Electrostatic Discharge Caution



This integrated circuit can be damaged by ESD. Texas Instruments recommends that all integrated circuits be handled with appropriate precautions. Failure to observe proper handling and installation procedures can cause damage.

ESD damage can range from subtle performance degradation to complete device failure. Precision integrated circuits may be more susceptible to damage because very small parametric changes could cause the device not to meet its published specifications.

8.6 Glossary

[TI Glossary](#) This glossary lists and explains terms, acronyms, and definitions.

9 Revision History

NOTE: Page numbers for previous revisions may differ from page numbers in the current version.

Changes from Revision M (June 2013) to Revision N (August 2024)	Page
• Added J package to <i>Device Information</i> table, <i>Pin Configuration and Functions</i> section, and <i>Thermal Information</i> section.....	1
• Deleted machine model and FK and W packages from data sheet.....	1
• Updated RθJA values: PW = 83 to 116.8, all values in °C/W	4

10 Mechanical, Packaging, and Orderable Information

The following pages include mechanical, packaging, and orderable information. This information is the most current data available for the designated devices. This data is subject to change without notice and revision of this document. For browser-based versions of this data sheet, refer to the left-hand navigation.

PACKAGING INFORMATION

Orderable part number	Status (1)	Material type (2)	Package Pins	Package qty Carrier	RoHS (3)	Lead finish/ Ball material (4)	MSL rating/ Peak reflow (5)	Op temp (°C)	Part marking (6)
5962-9685101QRA	Active	Production	CDIP (J) 20	20 TUBE	No	SNPB	N/A for Pkg Type	-55 to 125	5962-9685101QR A SNJ54AHCT540J
SN74AHCT540DBR	Active	Production	SSOP (DB) 20	2000 LARGE T&R	Yes	NIPDAU	Level-1-260C-UNLIM	-40 to 125	HB540
SN74AHCT540DBR.A	Active	Production	SSOP (DB) 20	2000 LARGE T&R	Yes	NIPDAU	Level-1-260C-UNLIM	-40 to 125	HB540
SN74AHCT540DGSR	Active	Production	VSSOP (DGS) 20	5000 LARGE T&R	Yes	NIPDAU	Level-1-260C-UNLIM	-40 to 125	HB540
SN74AHCT540DGVR	Active	Production	TVSOP (DGV) 20	2000 LARGE T&R	Yes	NIPDAU	Level-1-260C-UNLIM	-40 to 125	HB540
SN74AHCT540DGVR.A	Active	Production	TVSOP (DGV) 20	2000 LARGE T&R	Yes	NIPDAU	Level-1-260C-UNLIM	-40 to 125	HB540
SN74AHCT540DW	Obsolete	Production	SOIC (DW) 20	-	-	Call TI	Call TI	-40 to 125	AHCT540
SN74AHCT540DWR	Active	Production	SOIC (DW) 20	2000 LARGE T&R	Yes	NIPDAU	Level-1-260C-UNLIM	-40 to 125	AHCT540
SN74AHCT540DWR.A	Active	Production	SOIC (DW) 20	2000 LARGE T&R	Yes	NIPDAU	Level-1-260C-UNLIM	-40 to 125	AHCT540
SN74AHCT540DWRE4	Active	Production	SOIC (DW) 20	2000 LARGE T&R	Yes	NIPDAU	Level-1-260C-UNLIM	-40 to 125	AHCT540
SN74AHCT540N	Active	Production	PDIP (N) 20	20 TUBE	Yes	NIPDAU	N/A for Pkg Type	-40 to 125	SN74AHCT540N
SN74AHCT540N.A	Active	Production	PDIP (N) 20	20 TUBE	Yes	NIPDAU	N/A for Pkg Type	-40 to 125	SN74AHCT540N
SN74AHCT540NSR	Active	Production	SOP (NS) 20	2000 LARGE T&R	Yes	NIPDAU	Level-1-260C-UNLIM	-40 to 125	AHCT540
SN74AHCT540NSR.A	Active	Production	SOP (NS) 20	2000 LARGE T&R	Yes	NIPDAU	Level-1-260C-UNLIM	-40 to 125	AHCT540
SN74AHCT540PW	Obsolete	Production	TSSOP (PW) 20	-	-	Call TI	Call TI	-40 to 125	HB540
SN74AHCT540PWR	Active	Production	TSSOP (PW) 20	2000 LARGE T&R	Yes	NIPDAU	Level-1-260C-UNLIM	-40 to 125	HB540
SN74AHCT540PWR.A	Active	Production	TSSOP (PW) 20	2000 LARGE T&R	Yes	NIPDAU	Level-1-260C-UNLIM	-40 to 125	HB540
SN74AHCT540RKS	Active	Production	VQFN (RKS) 20	3000 LARGE T&R	Yes	NIPDAU	Level-1-260C-UNLIM	-40 to 125	AHCT540
SNJ54AHCT540J	Active	Production	CDIP (J) 20	20 TUBE	No	SNPB	N/A for Pkg Type	-55 to 125	5962-9685101QR A SNJ54AHCT540J
SNJ54AHCT540J.A	Active	Production	CDIP (J) 20	20 TUBE	No	SNPB	N/A for Pkg Type	-55 to 125	5962-9685101QR A SNJ54AHCT540J

(1) **Status:** For more details on status, see our [product life cycle](#).

(2) **Material type:** When designated, preproduction parts are prototypes/experimental devices, and are not yet approved or released for full production. Testing and final process, including without limitation quality assurance, reliability performance testing, and/or process qualification, may not yet be complete, and this item is subject to further changes or possible discontinuation. If available for ordering, purchases will be subject to an additional waiver at checkout, and are intended for early internal evaluation purposes only. These items are sold without warranties of any kind.

(3) **RoHS values:** Yes, No, RoHS Exempt. See the [TI RoHS Statement](#) for additional information and value definition.

(4) **Lead finish/Ball material:** Parts may have multiple material finish options. Finish options are separated by a vertical ruled line. Lead finish/Ball material values may wrap to two lines if the finish value exceeds the maximum column width.

(5) **MSL rating/Peak reflow:** The moisture sensitivity level ratings and peak solder (reflow) temperatures. In the event that a part has multiple moisture sensitivity ratings, only the lowest level per JEDEC standards is shown. Refer to the shipping label for the actual reflow temperature that will be used to mount the part to the printed circuit board.

(6) **Part marking:** There may be an additional marking, which relates to the logo, the lot trace code information, or the environmental category of the part.

Multiple part markings will be inside parentheses. Only one part marking contained in parentheses and separated by a "~" will appear on a part. If a line is indented then it is a continuation of the previous line and the two combined represent the entire part marking for that device.

Important Information and Disclaimer:The information provided on this page represents TI's knowledge and belief as of the date that it is provided. TI bases its knowledge and belief on information provided by third parties, and makes no representation or warranty as to the accuracy of such information. Efforts are underway to better integrate information from third parties. TI has taken and continues to take reasonable steps to provide representative and accurate information but may not have conducted destructive testing or chemical analysis on incoming materials and chemicals. TI and TI suppliers consider certain information to be proprietary, and thus CAS numbers and other limited information may not be available for release.

In no event shall TI's liability arising out of such information exceed the total purchase price of the TI part(s) at issue in this document sold by TI to Customer on an annual basis.

OTHER QUALIFIED VERSIONS OF SN54AHCT540, SN74AHCT540 :

- Catalog : [SN74AHCT540](#)
- Automotive : [SN74AHCT540-Q1](#), [SN74AHCT540-Q1](#)
- Military : [SN54AHCT540](#)

NOTE: Qualified Version Definitions:

- Catalog - TI's standard catalog product
- Automotive - Q100 devices qualified for high-reliability automotive applications targeting zero defects
- Military - QML certified for Military and Defense Applications

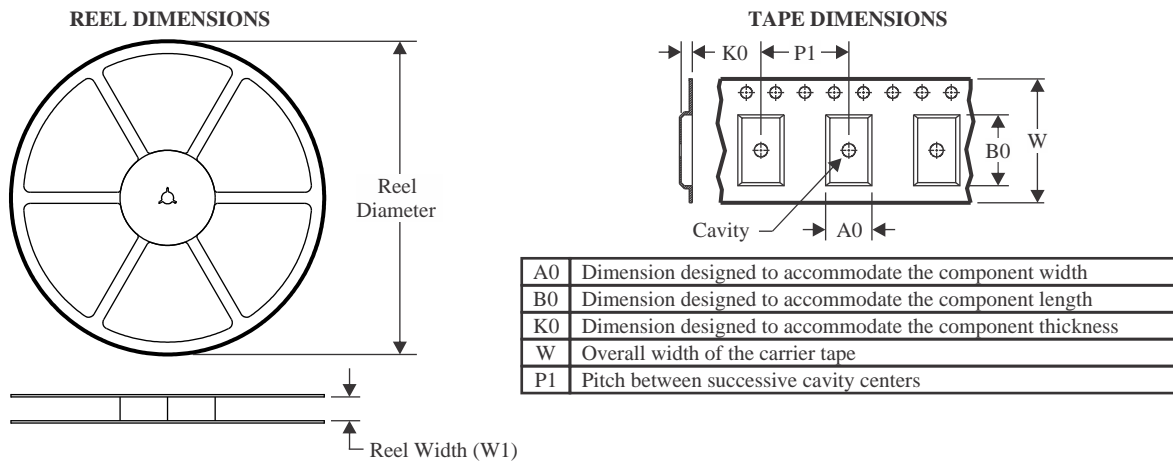
TAPE AND REEL INFORMATION

QUADRANT ASSIGNMENTS FOR PIN 1 ORIENTATION IN TAPE



*All dimensions are nominal

Device	Package Type	Package Drawing	Pins	SPQ	Reel Diameter (mm)	Reel Width W1 (mm)	A0 (mm)	B0 (mm)	K0 (mm)	P1 (mm)	W (mm)	Pin1 Quadrant
SN74AHCT540DBR	SSOP	DB	20	2000	330.0	16.4	8.2	7.5	2.5	12.0	16.0	Q1
SN74AHCT540DGSR	VSSOP	DGS	20	5000	330.0	16.4	5.4	5.4	1.45	8.0	16.0	Q1
SN74AHCT540DGVR	TVSOP	DGV	20	2000	330.0	12.4	6.9	5.6	1.6	8.0	12.0	Q1
SN74AHCT540DWR	SOIC	DW	20	2000	330.0	24.4	10.8	13.3	2.7	12.0	24.0	Q1
SN74AHCT540NSR	SOP	NS	20	2000	330.0	24.4	8.4	13.0	2.5	12.0	24.0	Q1
SN74AHCT540PWR	TSSOP	PW	20	2000	330.0	16.4	6.95	7.0	1.4	8.0	16.0	Q1
SN74AHCT540RKS	VQFN	RKS	20	3000	180.0	12.4	2.8	4.8	1.2	4.0	12.0	Q1

TAPE AND REEL BOX DIMENSIONS

*All dimensions are nominal

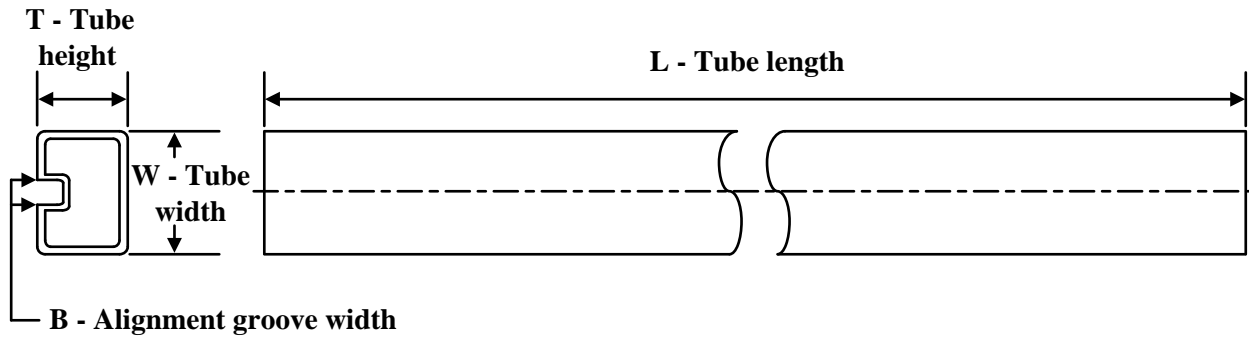
Device	Package Type	Package Drawing	Pins	SPQ	Length (mm)	Width (mm)	Height (mm)
SN74AHCT540DBR	SSOP	DB	20	2000	353.0	353.0	32.0
SN74AHCT540DGSR	VSSOP	DGS	20	5000	353.0	353.0	32.0
SN74AHCT540DGVR	TVSOP	DGV	20	2000	353.0	353.0	32.0
SN74AHCT540DWR	SOIC	DW	20	2000	356.0	356.0	45.0
SN74AHCT540NSR	SOP	NS	20	2000	356.0	356.0	45.0
SN74AHCT540PWR	TSSOP	PW	20	2000	353.0	353.0	32.0
SN74AHCT540RKS	VQFN	RKS	20	3000	210.0	185.0	35.0

TUBE

*All dimensions are nominal

Device	Package Name	Package Type	Pins	SPQ	L (mm)	W (mm)	T (μm)	B (mm)
SN74AHCT540N	N	PDIP	20	20	506	13.97	11230	4.32
SN74AHCT540N.A	N	PDIP	20	20	506	13.97	11230	4.32

PW0020A

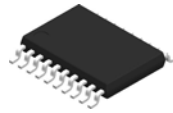

PACKAGE OUTLINE

TSSOP - 1.2 mm max height

SMALL OUTLINE PACKAGE



4220206/A 02/2017

NOTES:

- All linear dimensions are in millimeters. Any dimensions in parenthesis are for reference only. Dimensioning and tolerancing per ASME Y14.5M.
- This drawing is subject to change without notice.
- This dimension does not include mold flash, protrusions, or gate burrs. Mold flash, protrusions, or gate burrs shall not exceed 0.15 mm per side.
- This dimension does not include interlead flash. Interlead flash shall not exceed 0.25 mm per side.
- Reference JEDEC registration MO-153.

EXAMPLE BOARD LAYOUT

PW0020A

TSSOP - 1.2 mm max height

SMALL OUTLINE PACKAGE



LAND PATTERN EXAMPLE
EXPOSED METAL SHOWN
SCALE: 10X



SOLDER MASK DETAILS

4220206/A 02/2017

NOTES: (continued)

6. Publication IPC-7351 may have alternate designs.
7. Solder mask tolerances between and around signal pads can vary based on board fabrication site.

EXAMPLE STENCIL DESIGN

PW0020A

TSSOP - 1.2 mm max height

SMALL OUTLINE PACKAGE



SOLDER PASTE EXAMPLE
BASED ON 0.125 mm THICK STENCIL
SCALE: 10X

4220206/A 02/2017

NOTES: (continued)

8. Laser cutting apertures with trapezoidal walls and rounded corners may offer better paste release. IPC-7525 may have alternate design recommendations.
9. Board assembly site may have different recommendations for stencil design.

DGS0020A



PACKAGE OUTLINE

VSSOP - 1.1 mm max height

SMALL OUTLINE PACKAGE

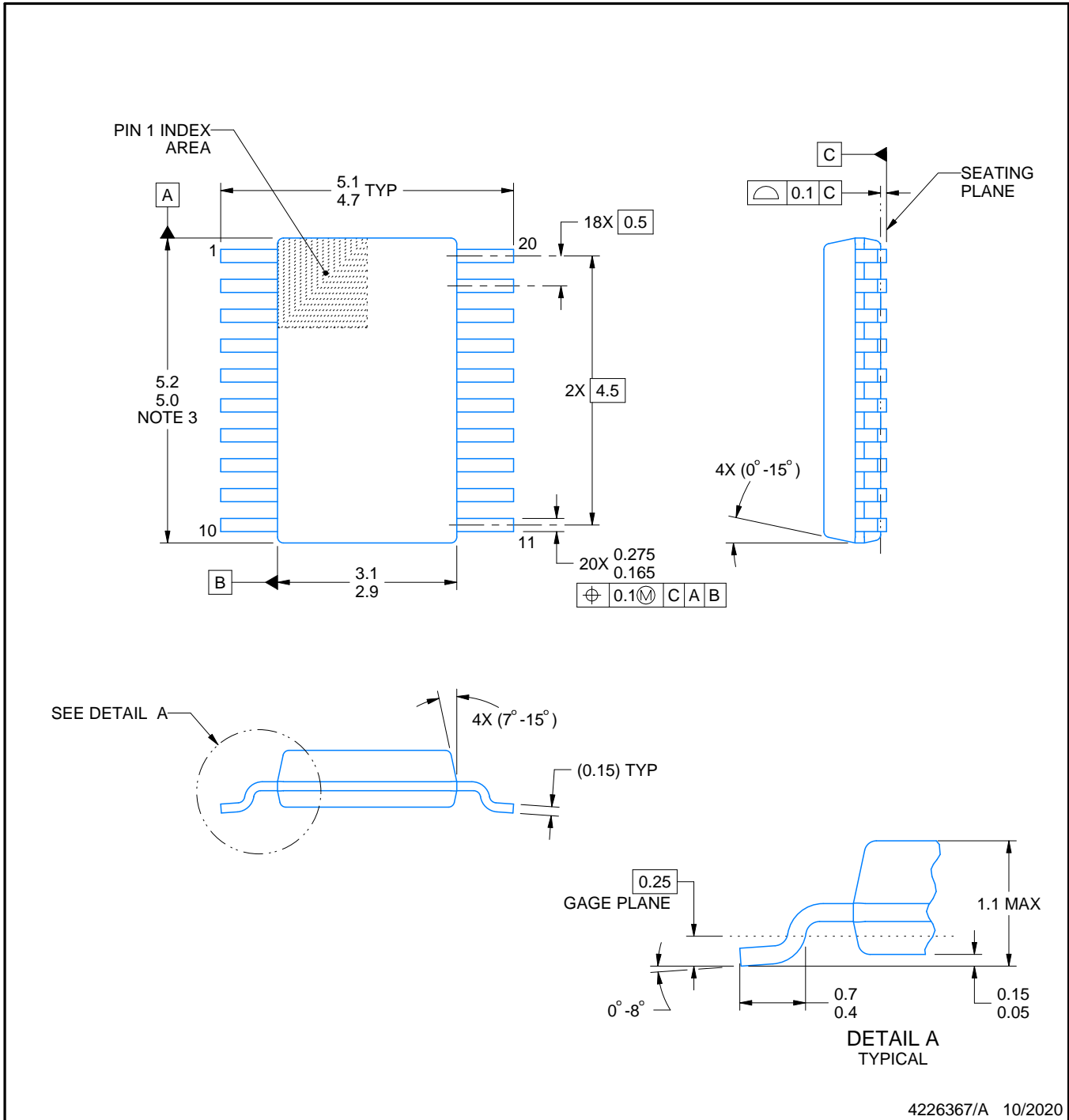

4226367/A 10/2020

NOTES:

PowerPAD is a trademark of Texas Instruments.

1. All linear dimensions are in millimeters. Any dimensions in parenthesis are for reference only. Dimensioning and tolerancing per ASME Y14.5M.
2. This drawing is subject to change without notice.
3. This dimension does not include mold flash, protrusions, or gate burrs. Mold flash, protrusions, or gate burrs shall not exceed 0.15 mm per side.
4. No JEDEC registration as of September 2020.
5. Features may differ or may not be present.

EXAMPLE BOARD LAYOUT

DGS0020A

VSSOP - 1.1 mm max height

SMALL OUTLINE PACKAGE

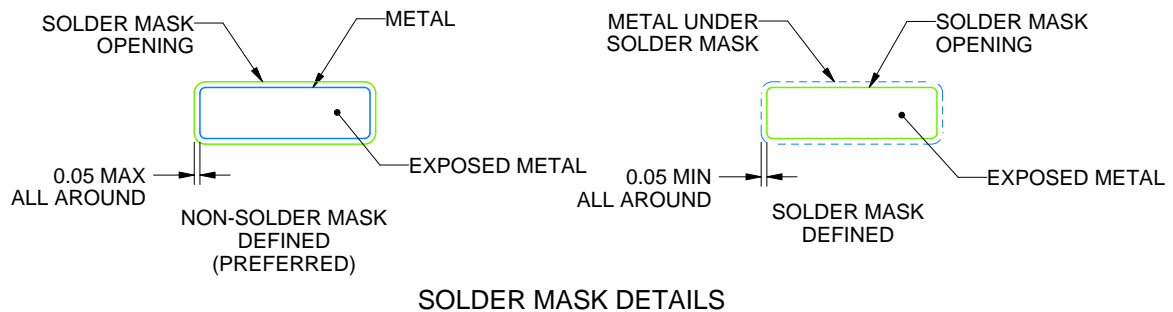
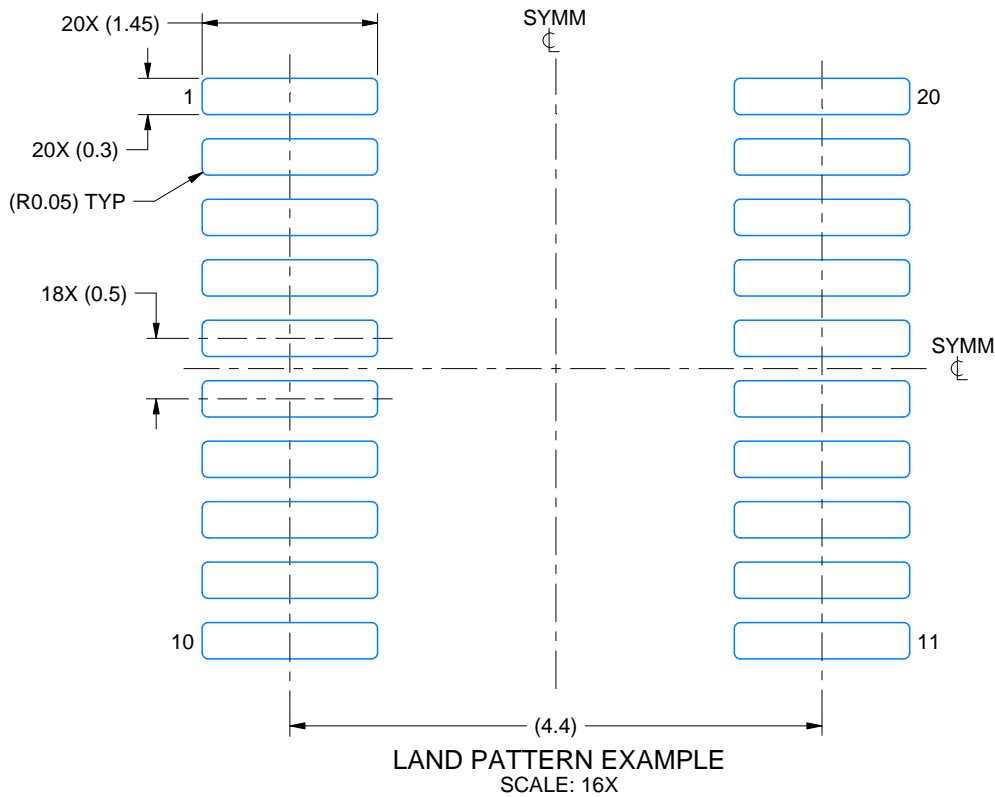

4226367/A 10/2020

NOTES: (continued)

6. Publication IPC-7351 may have alternate designs.
7. Solder mask tolerances between and around signal pads can vary based on board fabrication site.
8. This package is designed to be soldered to a thermal pad on the board. For more information, see Texas Instruments literature numbers SLMA002 (www.ti.com/lit/slma002) and SLMA004 (www.ti.com/lit/slma004).
9. Size of metal pad may vary due to creepage requirement.
10. Vias are optional depending on application, refer to device data sheet. It is recommended that vias under paste be filled, plugged or tented.

EXAMPLE STENCIL DESIGN

DGS0020A

VSSOP - 1.1 mm max height

SMALL OUTLINE PACKAGE

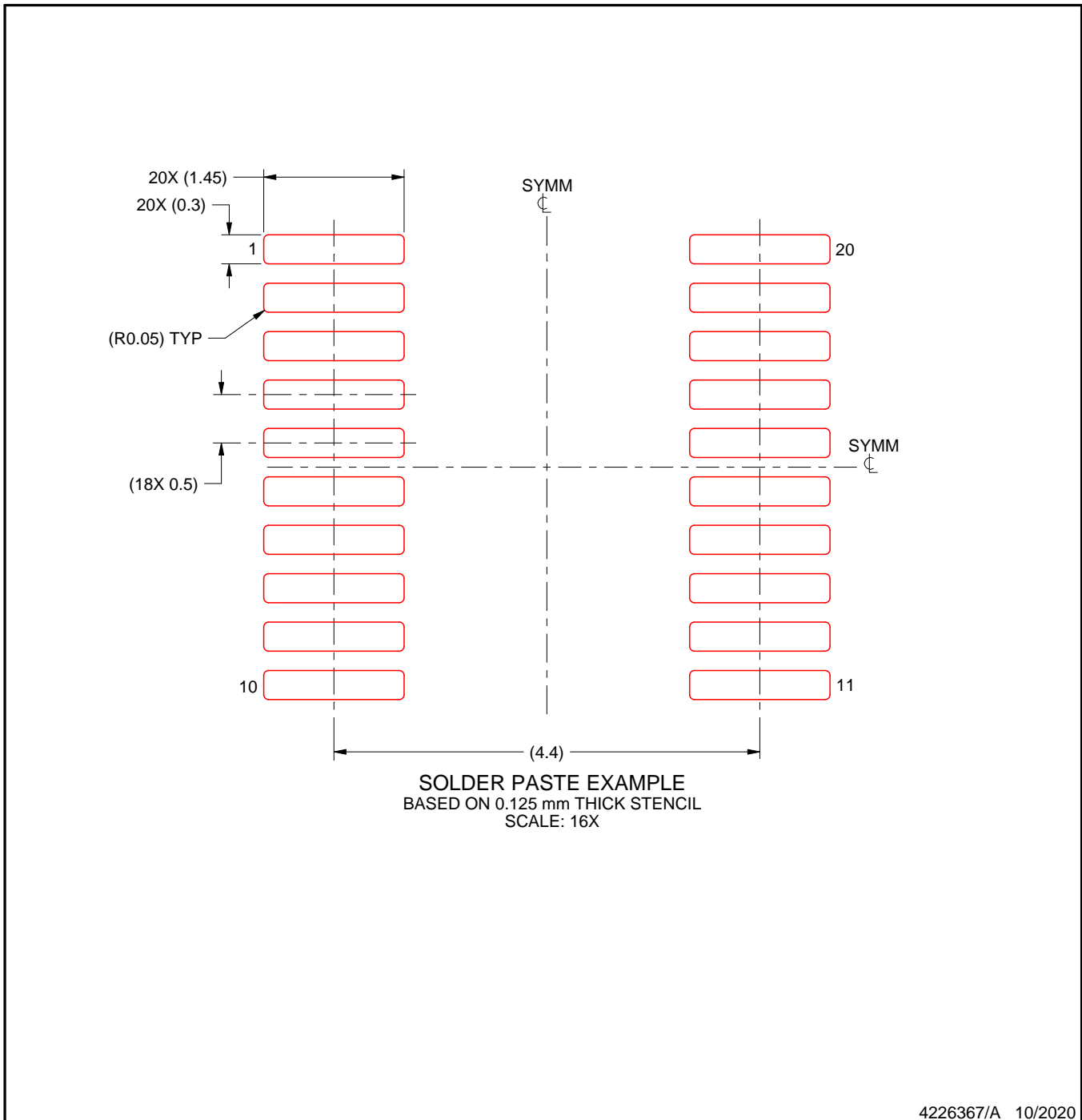

NOTES: (continued)

11. Laser cutting apertures with trapezoidal walls and rounded corners may offer better paste release. IPC-7525 may have alternate design recommendations.
12. Board assembly site may have different recommendations for stencil design.

DB0020A



PACKAGE OUTLINE

SSOP - 2 mm max height

SMALL OUTLINE PACKAGE



4214851/B 08/2019

NOTES:

1. All linear dimensions are in millimeters. Any dimensions in parenthesis are for reference only. Dimensioning and tolerancing per ASME Y14.5M.
2. This drawing is subject to change without notice.
3. This dimension does not include mold flash, protrusions, or gate burrs. Mold flash, protrusions, or gate burrs shall not exceed 0.15 mm per side.
4. This dimension does not include interlead flash. Interlead flash shall not exceed 0.25 mm per side.
5. Reference JEDEC registration MO-150.

EXAMPLE BOARD LAYOUT

DB0020A

SSOP - 2 mm max height

SMALL OUTLINE PACKAGE



LAND PATTERN EXAMPLE
EXPOSED METAL SHOWN
SCALE: 10X

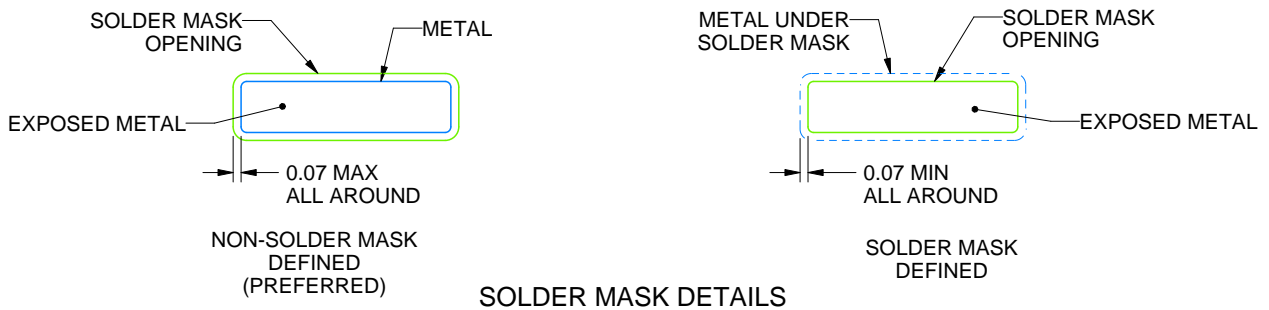

4214851/B 08/2019

NOTES: (continued)

- 6. Publication IPC-7351 may have alternate designs.
- 7. Solder mask tolerances between and around signal pads can vary based on board fabrication site.

EXAMPLE STENCIL DESIGN

DB0020A

SSOP - 2 mm max height

SMALL OUTLINE PACKAGE



SOLDER PASTE EXAMPLE
BASED ON 0.125 mm THICK STENCIL
SCALE: 10X

4214851/B 08/2019

NOTES: (continued)

8. Laser cutting apertures with trapezoidal walls and rounded corners may offer better paste release. IPC-7525 may have alternate design recommendations.
9. Board assembly site may have different recommendations for stencil design.

GENERIC PACKAGE VIEW

RKS 20

VQFN - 1 mm max height

2.5 x 4.5, 0.5 mm pitch

PLASTIC QUAD FLATPACK - NO LEAD

This image is a representation of the package family, actual package may vary.
Refer to the product data sheet for package details.

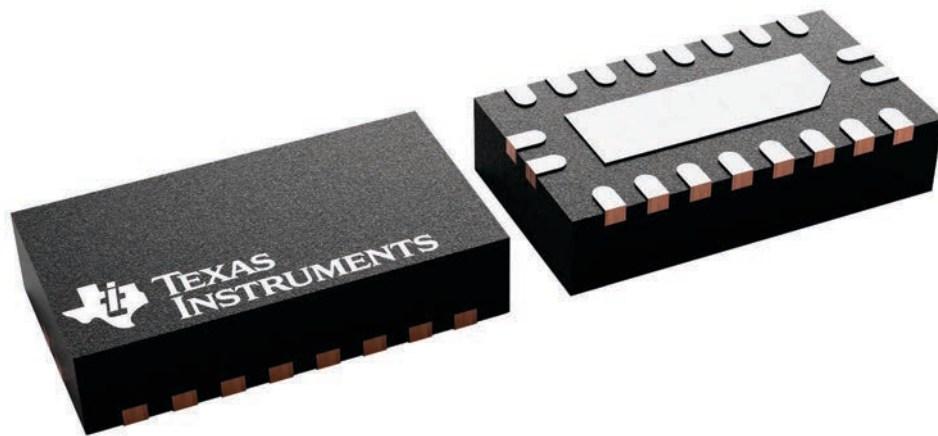

4226872/A

EXAMPLE BOARD LAYOUT

RKS0020A

VQFN - 1 mm max height

PLASTIC QUAD FLATPACK - NO LEAD

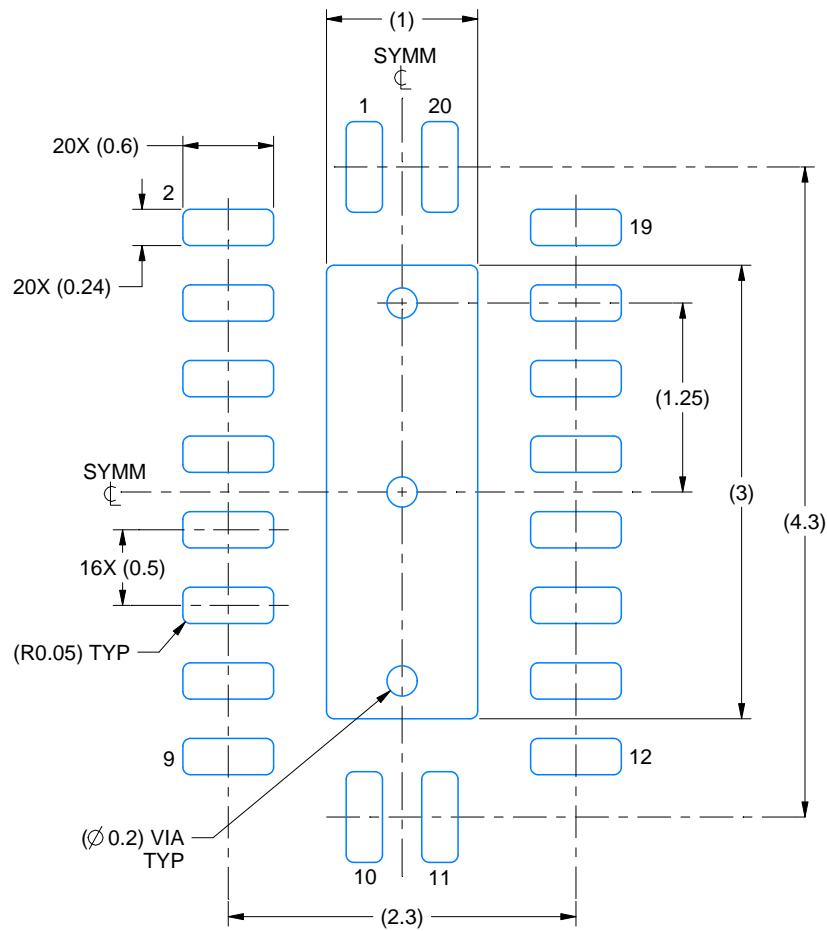

LAND PATTERN EXAMPLE
SCALE:20X

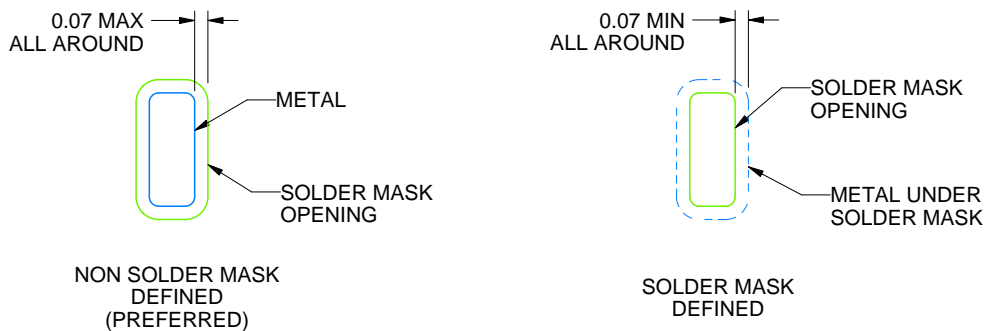

SOLDER MASK DETAILS

4222490/B 02/2021

NOTES: (continued)

- This package is designed to be soldered to a thermal pad on the board. For more information, see Texas Instruments literature number SLUA271 (www.ti.com/lit/slua271).
- Vias are optional depending on application, refer to device data sheet. If some or all are implemented, recommended via locations are shown.

EXAMPLE STENCIL DESIGN

RKS0020A

VQFN - 1 mm max height

PLASTIC QUAD FLATPACK - NO LEAD

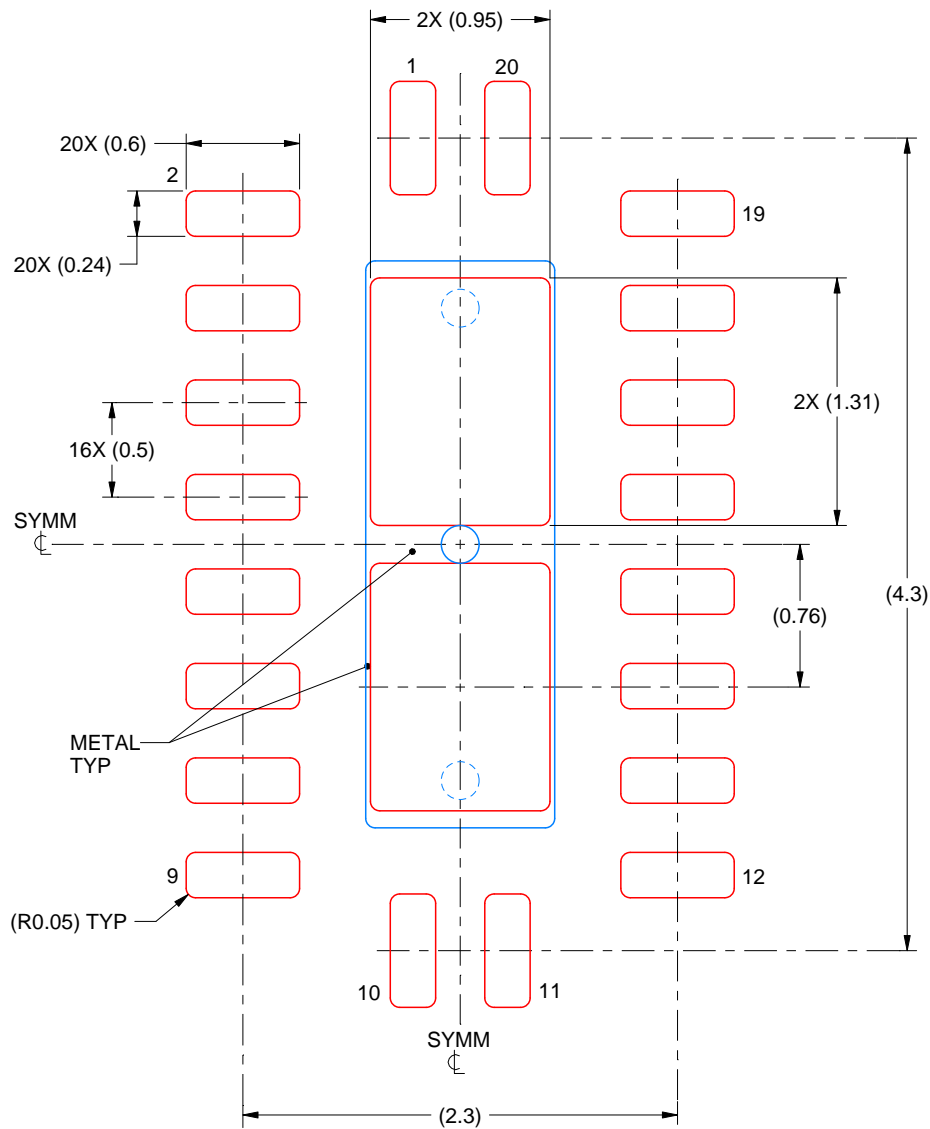

SOLDER PASTE EXAMPLE
 BASED ON 0.125 mm THICK STENCIL

EXPOSED PAD
 83% PRINTED SOLDER COVERAGE BY AREA
 SCALE:25X

4222490/B 02/2021

NOTES: (continued)

6. Laser cutting apertures with trapezoidal walls and rounded corners may offer better paste release. IPC-7525 may have alternate design recommendations.

MECHANICAL DATA

NS (R-PDSO-G**)

PLASTIC SMALL-OUTLINE PACKAGE

14-PINS SHOWN



- NOTES:
- A. All linear dimensions are in millimeters.
 - B. This drawing is subject to change without notice.
 - C. Body dimensions do not include mold flash or protrusion, not to exceed 0,15.

J (R-GDIP-T**)

14 LEADS SHOWN

CERAMIC DUAL IN-LINE PACKAGE



DIM \ PINS **	14	16	18	20
A	0.300 (7,62) BSC	0.300 (7,62) BSC	0.300 (7,62) BSC	0.300 (7,62) BSC
B MAX	0.785 (19,94)	.840 (21,34)	0.960 (24,38)	1.060 (26,92)
B MIN	—	—	—	—
C MAX	0.300 (7,62)	0.300 (7,62)	0.310 (7,87)	0.300 (7,62)
C MIN	0.245 (6,22)	0.245 (6,22)	0.220 (5,59)	0.245 (6,22)



4040083/F 03/03

- NOTES:
- All linear dimensions are in inches (millimeters).
 - This drawing is subject to change without notice.
 - This package is hermetically sealed with a ceramic lid using glass frit.
 - Index point is provided on cap for terminal identification only on press ceramic glass frit seal only.
 - Falls within MIL STD 1835 GDIP1-T14, GDIP1-T16, GDIP1-T18 and GDIP1-T20.

DGV (R-PDSO-G**)

PLASTIC SMALL-OUTLINE

24 PINS SHOWN



4073251/E 08/00

- NOTES: A. All linear dimensions are in millimeters.
 B. This drawing is subject to change without notice.
 C. Body dimensions do not include mold flash or protrusion, not to exceed 0,15 per side.
 D. Falls within JEDEC: 24/48 Pins – MO-153
 14/16/20/56 Pins – MO-194

N (R-PDIP-T**)

PLASTIC DUAL-IN-LINE PACKAGE

16 PINS SHOWN



- NOTES:
- A. All linear dimensions are in inches (millimeters).
 - B. This drawing is subject to change without notice.
 - C. Falls within JEDEC MS-001, except 18 and 20 pin minimum body length (Dim A).
 - D. The 20 pin end lead shoulder width is a vendor option, either half or full width.

DW0020A



PACKAGE OUTLINE

SOIC - 2.65 mm max height

SOIC



4220724/A 05/2016

NOTES:

1. All linear dimensions are in millimeters. Dimensions in parenthesis are for reference only. Dimensioning and tolerancing per ASME Y14.5M.
2. This drawing is subject to change without notice.
3. This dimension does not include mold flash, protrusions, or gate burrs. Mold flash, protrusions, or gate burrs shall not exceed 0.15 mm per side.
4. This dimension does not include interlead flash. Interlead flash shall not exceed 0.43 mm per side.
5. Reference JEDEC registration MS-013.

EXAMPLE BOARD LAYOUT

DW0020A

SOIC - 2.65 mm max height

SOIC



LAND PATTERN EXAMPLE
SCALE:6X



SOLDER MASK DETAILS

4220724/A 05/2016

NOTES: (continued)

- 6. Publication IPC-7351 may have alternate designs.
- 7. Solder mask tolerances between and around signal pads can vary based on board fabrication site.

EXAMPLE STENCIL DESIGN

DW0020A

SOIC - 2.65 mm max height

SOIC



SOLDER PASTE EXAMPLE
BASED ON 0.125 mm THICK STENCIL
SCALE:6X

4220724/A 05/2016

NOTES: (continued)

8. Laser cutting apertures with trapezoidal walls and rounded corners may offer better paste release. IPC-7525 may have alternate design recommendations.
9. Board assembly site may have different recommendations for stencil design.

IMPORTANT NOTICE AND DISCLAIMER

TI PROVIDES TECHNICAL AND RELIABILITY DATA (INCLUDING DATASHEETS), DESIGN RESOURCES (INCLUDING REFERENCE DESIGNS), APPLICATION OR OTHER DESIGN ADVICE, WEB TOOLS, SAFETY INFORMATION, AND OTHER RESOURCES "AS IS" AND WITH ALL FAULTS, AND DISCLAIMS ALL WARRANTIES, EXPRESS AND IMPLIED, INCLUDING WITHOUT LIMITATION ANY IMPLIED WARRANTIES OF MERCHANTABILITY, FITNESS FOR A PARTICULAR PURPOSE OR NON-INFRINGEMENT OF THIRD PARTY INTELLECTUAL PROPERTY RIGHTS.

These resources are intended for skilled developers designing with TI products. You are solely responsible for (1) selecting the appropriate TI products for your application, (2) designing, validating and testing your application, and (3) ensuring your application meets applicable standards, and any other safety, security, regulatory or other requirements.

These resources are subject to change without notice. TI grants you permission to use these resources only for development of an application that uses the TI products described in the resource. Other reproduction and display of these resources is prohibited. No license is granted to any other TI intellectual property right or to any third party intellectual property right. TI disclaims responsibility for, and you fully indemnify TI and its representatives against any claims, damages, costs, losses, and liabilities arising out of your use of these resources.

TI's products are provided subject to [TI's Terms of Sale](#), [TI's General Quality Guidelines](#), or other applicable terms available either on [ti.com](#) or provided in conjunction with such TI products. TI's provision of these resources does not expand or otherwise alter TI's applicable warranties or warranty disclaimers for TI products. Unless TI explicitly designates a product as custom or customer-specified, TI products are standard, catalog, general purpose devices.

TI objects to and rejects any additional or different terms you may propose.

Copyright © 2026, Texas Instruments Incorporated

Last updated 10/2025