

# TAA5412-Q1 Automotive stereo audio ADC with 112dB dynamic range, high-voltage input, micbias and diagnostics

## 1 Features

- AEC-Q100 qualified for automotive applications
  - Temperature grade 1:  $-40^{\circ}\text{C} \leq T_A \leq +125^{\circ}\text{C}$
- ADC performance:
  - Line/Microphone differential input dynamic range: 112dB
  - Differential input THD+N:  $-99\text{dB}$
  - Channel summing mode supports high SNR: 114dB
- ADC input voltage:
  - Differential,  $10V_{\text{RMS}}$  full-scale inputs
  - Single-ended,  $5V_{\text{RMS}}$  full-scale inputs
- ADC sample rate ( $f_s$ ) = 4kHz to 768kHz
- Programmable microphone bias (3V to 10V):
  - With an integrated efficient boost converter, or
  - With external high voltage HVDD supply
- Programmable microphone input fault diagnostics:
  - Open inputs or shorted inputs
  - Short to ground, MICBIAS, or VBAT
  - MICBIAS over current protection
- Up to 4 Record Channels
  - 2 Channel Analog + 2 Channel Digital
  - 1 Channel Analog + 3 Channel Digital
  - 4 Channel Digital
- Low-latency and Ultra low-latency decimation filter options
- Programmable HPF and biquad digital filters
- Automatic gain controller (AGC)
- Programmable channel settings:
  - Digital volume control:  $-80\text{dB}$  to  $47\text{dB}$
  - Gain calibration with 0.1dB resolution
  - Phase calibration with 325.5ns resolution
- Gain and phase calibration for ADC channels
- I<sup>2</sup>C or SPI controls
- Audio serial data interface:
  - Format: TDM, I<sup>2</sup>S, or left-justified (LJ)
  - Word length: 16, 20, 24, or 32 Bits
  - Bus controller and target modes
- Programmable PLL for flexible clocking
- Low Power Modes
  - $< 18.5\text{mW}$  for 2-ch recording
- Single-supply operation AVDD: 3.3V
- I/O supply operation: 3.3V, 1.8V or 1.2V

## 2 Applications

- [Emergency call \(eCall\)](#)
- [Telematics control unit](#)
- [Automotive head units](#)
- [Automotive external amplifiers](#)

## 3 Description

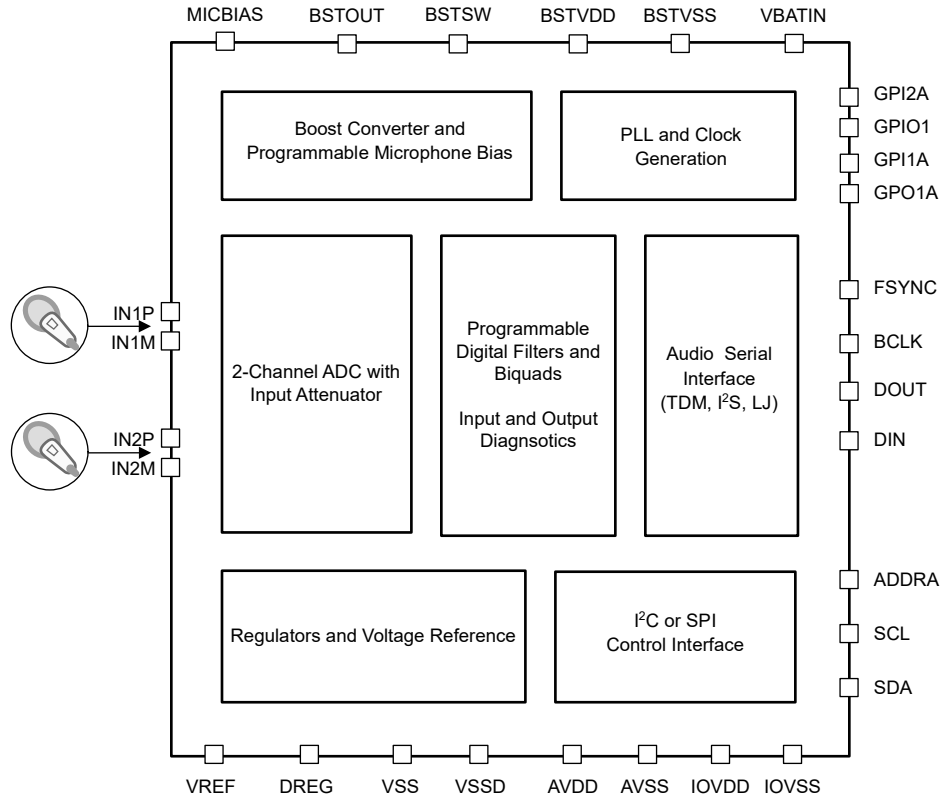
The TAA5412-Q1 is a 2-channel high-performance, audio analog-to-digital converter (ADC) that supports analog input signals up to  $10V_{\text{RMS}}$  with 112dB dynamic range. The TAA5412-Q1 supports line and microphone inputs, and allows for both single-ended and differential input configurations with options for AC and DC coupling. This device offers an integrated high-voltage, programmable microphone bias, and input diagnostic circuitry that allows direct connection to microphone-based automotive systems with full fault diagnostic capability for direct-coupled inputs. The TAA5412-Q1 integrates an efficient boost converter to generate a high voltage microphone bias using an external, low-voltage, 3.3V supply. The device can also directly use an external high-voltage supply (HVDD), which is any readily available supply in the system to generate this microphone bias. The TAA5412-Q1 integrates the programable channel gain, digital volume control, a low-jitter phase-locked loop (PLL), a programmable high-pass filter (HPF), biquad filters, decimation filters with low and ultra-low latency filter modes, and allows for sample rates up to 768kHz. The TAA5412-Q1 supports time-division multiplexing (TDM), I<sup>2</sup>S, or left-justified (LJ) audio formats, and can be controlled with either the I<sup>2</sup>C or SPI interface. These integrated high-performance features, along with a single, 3.3V supply operation, make the TAA5412-Q1 device an excellent choice for scalable, space-constrained automotive systems.

### Device Information

PART NUMBER	PACKAGE <sup>(1)</sup>	PACKAGE SIZE (NOM) <sup>(2)</sup>
TAA5412-Q1	WQFN (32)	5.0mm x 5.0mm with 0.5mm pitch

- (1) For all available packages, see the package option addendum at the end of the data sheet.
- (2) The package size (length × width) is a nominal value and includes pins, where applicable.





**Simplified Block Diagram**

## Table of Contents

<b>1 Features</b> .....	1
<b>2 Applications</b> .....	1
<b>3 Description</b> .....	1
<b>4 Pin Configuration and Functions</b> .....	4
<b>5 Specifications</b> .....	6
5.1 Absolute Maximum Ratings.....	6
5.2 ESD Ratings.....	6
5.3 Recommended Operating Conditions.....	6
5.4 Thermal Information.....	7
5.5 Electrical Characteristics.....	7
5.6 Timing Requirements: I <sup>2</sup> C Interface.....	12
5.7 Switching Characteristics: I <sup>2</sup> C Interface.....	13
5.8 Timing Requirements: SPI Interface.....	13
5.9 Switching Characteristics: SPI Interface.....	13
5.10 Timing Requirements: TDM, I <sup>2</sup> S or LJ Interface.....	13
5.11 Switching Characteristics: TDM, I <sup>2</sup> S or LJ Interface.....	14
5.12 Timing Requirements: PDM Digital Microphone Interface.....	14
5.13 Switching Characteristics: PDM Digital Microphone Interface.....	14
5.14 Timing Diagrams.....	15
5.15 Typical Characteristics.....	16
<b>6 Detailed Description</b> .....	20
6.1 Overview.....	20
6.2 Functional Block Diagram.....	21
6.3 Feature Description.....	22
6.4 Device Functional Modes.....	61
6.5 Programming.....	61
<b>7 Register Maps</b> .....	67
7.1 Device Configuration Registers.....	67
7.2 Programmable Coefficient Registers.....	150
<b>8 Application and Implementation</b> .....	163
8.1 Application Information.....	163
8.2 Typical Application.....	163
8.3 Power Supply Recommendations.....	168
8.4 Layout.....	169
<b>9 Revision History</b> .....	170
<b>10 Device and Documentation Support</b> .....	171
10.1 Documentation Support.....	171
10.2 Receiving Notification of Documentation Updates.....	171
10.3 Support Resources.....	171
10.4 Trademarks.....	171
10.5 Electrostatic Discharge Caution.....	171
10.6 Glossary.....	171
<b>11 Mechanical, Packaging, and Orderable   Information</b> .....	171

## 4 Pin Configuration and Functions

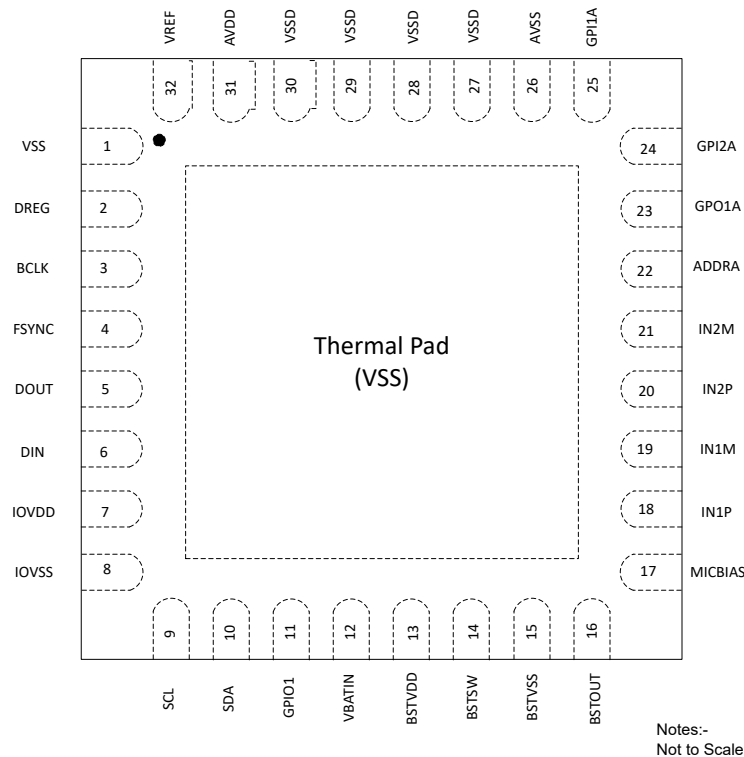


Figure 4-1. TAA5412-Q1 RTV Package, 32-Pin WQFN With Exposed Thermal Pad, Top View

Table 4-1. Pin Functions

PIN		TYPE <sup>(1)</sup>	DESCRIPTION
NAME	NO.		
VSS	1	Ground	Ground pin. Short directly to board ground plane.
DREG	2	Digital Supply	Digital on-chip regulator output voltage for digital supply (1.5V, nominal)
BCLK	3	Digital I/O	Audio serial data interface bus bit clock
FSYNC	4	Digital I/O	Audio serial data interface bus frame synchronization signal
DOUT	5	Digital I/O	Audio serial data interface bus output
DIN	6	Digital Input	Audio serial data interface bus input
IOVDD	7	Digital Supply	Digital I/O power supply (1.2V or 1.8V or 3.3V, nominal)
IOVSS	8	Ground	Ground pin for digital I/O power supply. Short directly to board ground plane.
SCL	9	Digital Input	Clock for I <sup>2</sup> C control interface
SDA	10	Digital Input	Data for I <sup>2</sup> C control interface
GPIO1	11	Digital I/O	General-purpose digital input/output 1 (multipurpose functions such as daisy-chain input, audio data output, PLL input clock source, interrupt, and so forth)
VBATIN	12	Analog Input	Analog VBAT input monitoring pin (used for input diagnostics)
BSTVDD	13	Analog Supply	Boost converter supply voltage (3.3V, nominal)

**Table 4-1. Pin Functions (continued)**

PIN		TYPE <sup>(1)</sup>	DESCRIPTION
NAME	NO.		
BSTSW	14	Analog Supply	Boost converter switching pin
BSTVSS	15	Ground	Ground pin for boost converter supply. Short directly to board ground plane.
BSTOUT	16	Analog Supply	Boost converter output voltage
MICBIAS	17	Analog	Microphone bias output (Programmable output up to 10V)
IN1P	18	Analog Input	Analog input 1P pin
IN1M	19	Analog Input	Analog input 1M pin
IN2P	20	Analog Input	Analog input 2P pin
IN2M	21	Analog Input	Analog input 2M pin
ADDRA	22	Digital Input	I <sup>2</sup> C address selection pin
GPO1A	23	Digital Output	General-purpose digital output 1A (multipurpose functions such as audio data output, interrupt, and so forth)
GPI2A	24	Digital Input	General-purpose digital input 2A (multipurpose functions such as daisy-chain input, audio data input, PLL input clock source, and so forth)
GPI1A	25	Digital Input	General-purpose digital input 1A (multipurpose functions such as daisy-chain input, audio data input, PLL input clock source, and so forth)
AVSS	26	Ground	Ground pin for analog power supply. Short directly to board ground plane.
VSSD	27	Ground	Short directly to board ground plane
VSSD	28	Ground	Short directly to board ground plane
VSSD	29	Ground	Short directly to board ground plane
VSSD	30	Ground	Short directly to board ground plane
AVDD	31	Analog Supply	Analog power supply (3.3V, nominal)
VREF	32	Analog	Analog reference voltage filter output
VSS	Thermal Pad	Ground	Thermal Pad shorted to internal device ground. Short directly to board ground plane

(1) I = Input, O = Output, I/O = Input or Output, G = Ground, P = Power.

## 5 Specifications

### 5.1 Absolute Maximum Ratings

over the operating ambient temperature range (unless otherwise noted)<sup>(1)</sup>

		MIN	MAX	UNIT
Supply voltage	AVDD to AVSS	-0.3	3.9	V
Supply voltage	BSTVDD to BSTVSS	-0.3	3.9	V
Supply voltage	IOVDD to IOVSS	-0.3	3.9	V
Supply voltage	BSTOUT (External HVDD Mode) to BSTVSS	-0.3	14	V
Ground voltage differences	Between AVSS, IOVSS, BSTVSS and VSS (thermal pad)	-0.3	0.3	V
Battery voltage	VBATIN to AVSS	-0.3	18	V
Analog input voltage	Analog input pins voltage to AVSS	-0.3	18	V
Digital input voltage	Digital input pins voltage to IOVSS or VSS (thermal pad)	-0.3	IOVDD + 0.3	V
Temperature	Operating ambient, T <sub>A</sub>	-40	125	°C
	Junction, T <sub>J</sub>	-40	150	
	Storage, T <sub>stg</sub>	-65	150	

- (1) Operation outside the Absolute Maximum Ratings may cause permanent device damage. Absolute Maximum Ratings do not imply functional operation of the device at these or any other conditions beyond those listed under Recommended Operating Conditions. If used outside the Recommended Operating Conditions but within the Absolute Maximum Ratings, the device may not be fully functional, and this may affect device reliability, functionality, performance, and shorten the device lifetime.

### 5.2 ESD Ratings

			VALUE	UNIT
V <sub>(ESD)</sub>	Electrostatic discharge	Human-body model (HBM), per AEC Q100-002 <sup>(1)</sup>	±2000	V
		Charged-device model (CDM), per AEC Q100-011	±500	

- (1) AEC Q100-002 indicates that HBM stressing shall be in accordance with the ANSI/ESDA/JEDEC JS-001 specification.

### 5.3 Recommended Operating Conditions

over operating free-air temperature range (unless otherwise noted)

		MIN	NOM	MAX	UNIT
<b>POWER</b>					
AVDD <sup>(1)</sup>	Analog supply voltage to AVSS - AVDD 3.3V operation	3.0	3.3	3.6	V
BSTVDD	Boost converter supply voltage to BSTVSS	3.0	3.3	3.6	V
IOVDD <sup>(2)</sup>	IO supply voltage to IOVSS - IOVDD 3.3V operation	3.0	3.3	3.6	V
	IO supply voltage to IOVSS - IOVDD 1.8V operation	1.65	1.8	1.95	
	IO supply voltage to IOVSS - IOVDD 1.2V operation	1.08	1.2	1.32	
BSTOUT	BSTOUT supply voltage to BSTVSS in external HVDD Mode	5.6	9	12	V
<b>INPUTS</b>					
VBAT_IN	VBATIN input pin voltage to AVSS	0	12.6	18	V
INxx	Analog input pins voltage to AVSS for line-in recording	0		14.2	V
	Analog input pins voltage to AVSS for microphone recording	0.1	MICBIAS – 0.1		V
	Analog input pins voltage to AVSS during short to VBATIN			VBATIN	V
	Digital input pins (except ADDRA, GPO1A, GPI1A, GPI2A) voltage to IOVSS	0		IOVDD	V
	Digital input pins (ADDRA, GPO1A, GPI1A, GPI2A) voltage to AVSS	0		AVDD	V
<b>TEMPERATURE</b>					
T <sub>A</sub>	Operating ambient temperature	-40		125	°C

over operating free-air temperature range (unless otherwise noted)

		MIN	NOM	MAX	UNIT
<b>OTHERS</b>					
	GPIO1/GPIxx (used as CCLK input) clock frequency			36.864 <sup>(3)</sup>	MHz
C <sub>b</sub>	SCL and SDA bus capacitance for I <sup>2</sup> C interface supports standard-mode and fast-mode			400	pF
	SCL and SDA bus capacitance for I <sup>2</sup> C interface supports fast-mode plus			550	
C <sub>L</sub>	Digital output load capacitance		20	50	pF
	Boost converter inductor		2.2		μH

- (1) AVSS and VSS (thermal pad); all ground pins must be tied together and must not differ in voltage by more than 0.2V.
- (2) Set the IOVDD\_IO\_MODE bit correctly for IOVDD 1.8V and 1.2V Operation.
- (3) CCLK input rise time (V<sub>IL</sub> to V<sub>IH</sub>) and fall time (V<sub>IH</sub> to V<sub>IL</sub>) must be less than 5ns. For better audio noise performance, CCLK input must be used with low jitter.

## 5.4 Thermal Information

THERMAL METRIC <sup>(1)</sup>		TAA5412-Q1		UNIT
		RTV (WQFN)		
		32 PINS		
R <sub>θJA</sub>	Junction-to-ambient thermal resistance	39.7		°C/W
R <sub>θJC(top)</sub>	Junction-to-case (top) thermal resistance	18.4		°C/W
R <sub>θJB</sub>	Junction-to-board thermal resistance	19.5		°C/W
ψ <sub>JT</sub>	Junction-to-top characterization parameter	0.2		°C/W
ψ <sub>JB</sub>	Junction-to-board characterization parameter	19.5		°C/W
R <sub>θJC(bot)</sub>	Junction-to-case (bottom) thermal resistance	11.5		°C/W

- (1) For more information about traditional and new thermal metrics, see the [Semiconductor and IC Package Thermal Metrics](#) application report.

## 5.5 Electrical Characteristics

At T<sub>A</sub> = 25°C, AVDD = 3.3V, IOVDD = 3.3V, BSTVDD = 3.3V, HVDD = 11V (for external HVDD case), f<sub>IN</sub> = 1kHz sinusoidal signal, f<sub>S</sub> = 48kHz, 32-bit audio data, BCLK = 256 x f<sub>S</sub>, TDM target mode, PLL on, channel gain = 0dB, linear phase decimation filters, AC-coupled differential input with V<sub>CM</sub> = 7.2V, MICBIAS programmed voltage = 8V and other default configurations; measured filter free with an audio precision with a 20Hz to a 20kHz un-weighted bandwidth, unless otherwise noted

PARAMETER	TEST CONDITIONS	MIN	NOM	MAX	UNIT
<b>ADC PERFORMANCE FOR LINE/MIC INPUT RECORDING</b>					
	Differential input full-scale DC signal voltage	AC-coupled input, input fault diagnostic not supported	10		V <sub>RMS</sub>
		DC-coupled input, DC common-mode voltage INxP = INxM = 7.2V, input fault diagnostic supported			
	Single-ended input full-scale DC signal voltage	AC-coupled input, input fault diagnostic not supported	5		V <sub>RMS</sub>
		DC-coupled input, DC common-mode voltage INxP = INxM = 7.2V, input fault diagnostic supported			
SNR	Signal-to-noise ratio, A-weighted <sup>(1) (2)</sup>	IN1x differential AC-coupled input and AC signal shorted to ground, 0dB channel gain	100	112	dB
		IN1x differential DC-coupled input and AC signal shorted to ground, 0dB channel gain		112	
SNR	Signal-to-noise ratio, A-weighted <sup>(1) (2)</sup>	IN1x differential AC-coupled input and AC signal shorted to ground, 12dB channel gain		100	dB
		IN1x differential DC-coupled input and AC signal shorted to ground, 12dB channel gain		100	

**TAA5412-Q1**

SLASF37A – JANUARY 2024 – REVISED JANUARY 2025

At  $T_A = 25^\circ\text{C}$ ,  $AVDD = 3.3\text{V}$ ,  $IOVDD = 3.3\text{V}$ ,  $BSTVDD = 3.3\text{V}$ ,  $HVDD = 11\text{V}$  (for external HVDD case),  $f_{IN} = 1\text{kHz}$  sinusoidal signal,  $f_S = 48\text{kHz}$ , 32-bit audio data,  $BCLK = 256 \times f_S$ , TDM target mode, PLL on, channel gain = 0dB, linear phase decimation filters, AC-coupled differential input with  $V_{CM} = 7.2\text{V}$ , MICBIAS programmed voltage = 8V and other default configurations; measured filter free with an audio precision with a 20Hz to a 20kHz un-weighted bandwidth, unless otherwise noted

PARAMETER		TEST CONDITIONS	MIN	NOM	MAX	UNIT
SNR	Signal-to-noise ratio, A-weighted <sup>(1) (2)</sup>	Wideband Mode <sup>(3)</sup> : IN1x differential AC-coupled or DC-coupled input and AC signal shorted to ground, 0dB channel gain (Integrated till 20kHz)		101		dB
	Signal-to-noise ratio	Wideband Mode <sup>(3)</sup> : IN1x differential AC-coupled or DC-coupled input and AC signal shorted to ground, 0dB channel gain (Integrated till 85kHz)		90		
SNR	Signal-to-noise ratio, A-weighted <sup>(1) (2)</sup>	Power Tune Mode <sup>(4)</sup> : IN1x differential AC-coupled input and AC signal shorted to ground, 0dB channel gain		104		dB
		Power Tune Mode <sup>(4)</sup> : IN1x differential DC-coupled input and AC signal shorted to ground, 0dB channel gain		104		
SNR	Signal-to-noise ratio, A-weighted <sup>(1) (2)</sup>	IN1x single-ended AC-coupled input and AC signal shorted to ground, 0dB channel gain		106		dB
DR	Dynamic range, A-weighted <sup>(2)</sup>	IN1x differential AC-coupled input and –60dBFS AC signal input, 0dB channel gain	100	112		dB
		IN1x differential DC-coupled input and –60dBFS AC signal input, 0dB channel gain		112		
DR	Dynamic range, A-weighted <sup>(2)</sup>	IN1x differential AC-coupled input and –72dBFS AC signal input, 12dB channel gain		100		dB
		IN1x differential DC-coupled input and –72dBFS AC signal input, 12dB channel gain		100		
DR	Dynamic range, A-weighted <sup>(2)</sup>	Power Tune Mode <sup>(4)</sup> : IN1x differential AC-coupled input and –60dBFS AC signal input, 0dB channel gain		104		dB
		Power Tune Mode <sup>(4)</sup> : IN1x differential DC-coupled input and –60dBFS AC signal input, 0dB channel gain		104		
DR	Dynamic range, A-weighted <sup>(2)</sup>	IN1x single-ended AC-coupled input and and –60dBFS AC signal input, 0dB channel gain		106		dB
THD+N	Total harmonic distortion <sup>(2)</sup>	IN1x differential AC-coupled input and –1dBFS AC signal input, 0dB channel gain		–99	–80	dB
		IN1x differential DC-coupled input and –1dBFS AC signal input, 0dB channel gain		–95		
<b>ADC OTHER PARAMETERS</b>						
	AC Input impedance	Input pins INxP or INxM		34		kΩ
	Digital volume control range	Programmable 0.5dB steps	–80		47	dB
	Input Signal Bandwidth	Upto 192KSPS FS Rate		0.46		FS
		>192KSPS		85		kHz
	Output data sample rate	Programmable	4		768	kHz
	Output data sample word length	Programmable	16		32	Bits
	Digital high-pass filter cutoff frequency	First-order IIR filter with programmable coefficients, –3dB point (default setting)		1		Hz
	Interchannel isolation	–1dBFS AC signal line-in differential input to non measurement channel		–134		dB
	Interchannel gain mismatch	–6dBFS AC signal line-in differential input, 1kHz sinusoidal signal, 0dB channel gain		±0.1		dB



At  $T_A = 25^\circ\text{C}$ ,  $AVDD = 3.3\text{V}$ ,  $IOVDD = 3.3\text{V}$ ,  $BSTVDD = 3.3\text{V}$ ,  $HVDD = 11\text{V}$  (for external HVDD case),  $f_{IN} = 1\text{kHz}$  sinusoidal signal,  $f_S = 48\text{kHz}$ , 32-bit audio data,  $BCLK = 256 \times f_S$ , TDM target mode, PLL on, channel gain = 0dB, linear phase decimation filters, AC-coupled differential input with  $V_{CM} = 7.2\text{V}$ , MICBIAS programmed voltage = 8V and other default configurations; measured filter free with an audio precision with a 20Hz to a 20kHz un-weighted bandwidth, unless otherwise noted

PARAMETER		TEST CONDITIONS	MIN	NOM	MAX	UNIT
	Interchannel phase mismatch	–6dBFS AC signal line-in differential input, 1kHz sinusoidal signal		±0.01		Degrees
PSRR	Power-supply rejection ratio	100mV <sub>pp</sub> , 1kHz sinusoidal signal on AVDD, differential input, 0dB channel gain		92		dB
CMRR	Common-mode rejection ratio	Differential DC-coupled input, 0dB channel gain, –6dBFS AC input, 1kHz signal on both pins and measured level at output		80		dB
<b>MICROPHONE BIAS</b>						
	MICBIAS noise	BW = 20Hz to 20kHz, A-weighted, 1μF capacitor between MICBIAS and AVSS		20		μV <sub>RMS</sub>
	MICBIAS voltage	Programmable 0.5V steps	3		10	V
	MICBIAS current drive	MICBIAS voltage 10V			30	mA
	MICBIAS load regulation	MICBIAS voltage 10V, measured up to maximum load	0		1	%
	MICBIAS over current protection threshold	MICBIAS voltage 10V	32			mA
<b>INPUT DIAGNOSTICS</b>						
	Fault monitoring repetition rate	Programmable, DC-coupled input	1	4	8	ms
	Fault response time	Fault monitoring repetition rate 4ms, DC-coupled input		16		ms
	Threshold voltage for (INxx – AVSS) input shorted to ground	Programmable 60mV steps, DC-coupled input	0		900	mV
	Threshold voltage for (INxP – INxM) input shorted together	Programmable 30mV steps, DC-coupled input	0		450	mV
	Threshold voltage for (MICBIAS – INxx) input shorted to MICBIAS	Programmable 30mV steps, DC-coupled input	0		450	mV
	Threshold voltage for (VBAT – INxx) input shorted to VBATIN	Programmable 30mV steps, DC-coupled input	0		450	mV
<b>DIGITAL I/O</b>						
V <sub>IL</sub>	Low-level digital input logic voltage threshold	All digital pins except GPI1A, GPI2A, ADDRA, SDA and SCL, IOVDD 1.8V or 1.2V operation	–0.3		0.35 x IOVDD	V
		All digital pins except GPI1A, GPI2A, ADDRA, SDA and SCL, IOVDD 3.3V operation	–0.3		0.8	
V <sub>IH</sub>	High-level digital input logic voltage threshold	All digital pins except GPI1A, GPI2A, ADDRA, SDA and SCL, IOVDD 1.8V or 1.2V operation	0.65 x IOVDD		IOVDD + 0.3	V
		All digital pins except GPI1A, GPI2A, ADDRA, SDA and SCL, IOVDD 3.3V operation	2		IOVDD + 0.3	
V <sub>OL</sub>	Low-level digital output voltage	All digital pins except GPO1A, SDA and SCL, I <sub>OL</sub> = –2mA, IOVDD 1.8V or 1.2V operation			0.45	V
		All digital pins except GPO1A, SDA and SCL, I <sub>OL</sub> = –2mA, IOVDD 3.3V operation			0.4	
V <sub>OH</sub>	High-level digital output voltage	All digital pins except GPO1A, SDA and SCL, I <sub>OH</sub> = 2mA, IOVDD 1.8V or 1.2V operation	IOVDD – 0.45			V
		All digital pins except GPO1A, SDA and SCL, I <sub>OH</sub> = 2mA, IOVDD 3.3V operation	2.4			

**TAA5412-Q1**

SLASF37A – JANUARY 2024 – REVISED JANUARY 2025

At  $T_A = 25^\circ\text{C}$ ,  $AVDD = 3.3\text{V}$ ,  $IOVDD = 3.3\text{V}$ ,  $BSTVDD = 3.3\text{V}$ ,  $HVDD = 11\text{V}$  (for external HVDD case),  $f_{IN} = 1\text{kHz}$  sinusoidal signal,  $f_S = 48\text{kHz}$ , 32-bit audio data,  $BCLK = 256 \times f_S$ , TDM target mode, PLL on, channel gain = 0dB, linear phase decimation filters, AC-coupled differential input with  $V_{CM} = 7.2\text{V}$ , MICBIAS programmed voltage = 8V and other default configurations; measured filter free with an audio precision with a 20Hz to a 20kHz un-weighted bandwidth, unless otherwise noted

PARAMETER		TEST CONDITIONS	MIN	NOM	MAX	UNIT
$V_{IL(AVDD)}$	Low-level digital input logic voltage threshold	For Pins GPI1A, GPI2A, ADDRA	-0.3		$0.35 \times AVDD$	V
$V_{IH(AVDD)}$	High-level digital input logic voltage threshold	For Pins GPI1A, GPI2A, ADDRA	$0.65 \times AVDD$		$AVDD + 0.3$	V
$V_{OL(AVDD)}$	Low-level digital output voltage	For GPO1A Pin			0.45	V
$V_{OH(AVDD)}$	High-level digital output voltage	For GPO1A Pin	$AVDD - 0.45$			V
$V_{IL(I2C)}$	Low-level digital input logic voltage threshold	SDA and SCL	-0.5		$0.3 \times IOVDD$	V
$V_{IH(I2C)}$	High-level digital input logic voltage threshold	SDA and SCL	$0.7 \times IOVDD$		$IOVDD + 0.5$	V
$V_{OL1(I2C)}$	Low-level digital output voltage	SDA, $I_{OL(I2C)} = -3\text{mA}$ , $IOVDD = 3.3\text{V}$ operation			0.4	V
$V_{OL2(I2C)}$	Low-level digital output voltage	SDA, $I_{OL(I2C)} = -2\text{mA}$ , $IOVDD = 1.8\text{V}$ or $1.2\text{V}$ operation			$0.2 \times IOVDD$	V
$I_{OL(I2C)}$	Low-level digital output current	SDA, $V_{OL(I2C)} = 0.4\text{V}$ , standard-mode or fast-mode	3			mA
		SDA, $V_{OL(I2C)} = 0.4\text{V}$ , fast-mode plus	20			
$I_{IL}$	Input logic-low leakage for digital inputs	All digital pins, input = 0V	-5	0.1	5	$\mu\text{A}$
$I_{IH}$	Input logic-high leakage for digital inputs	All digital pins, input = $IOVDD$	-5	0.1	5	$\mu\text{A}$
$C_{IN}$	Input capacitance for digital inputs	All digital pins		5		pF
$R_{PD}$	Pulldown resistance for digital I/O pins when asserted on			20		k $\Omega$

**TYPICAL SUPPLY CURRENT CONSUMPTION**

$I_{AVDD}$	Current consumption in sleep mode (software shutdown mode)	All device external clocks stopped	9		$\mu\text{A}$
$I_{BSTVDD}$ , or $I_{HVDD}$			0.01		
$I_{IOVDD}$			1		
$I_{AVDD}$	Current consumption with MICBIAS ON, MICBIAS voltage 10V, 30mA load, ADC off	$f_S = 48\text{kHz}$ , $BCLK = 256 \times f_S$	1.6		mA
$I_{BSTVDD}$			16.6		
$I_{IOVDD}$			0.02		
$I_{AVDD}$	Current consumption with ADC 2-channel operation, MICBIAS off, PLL on	$f_S = 16\text{kHz}$ , $BCLK = 512 \times f_S$	8.7		mA
$I_{IOVDD}$			0.1		
$I_{AVDD}$	Current consumption with ADC 2-channel operation, MICBIAS on, PLL off	$f_S = 48\text{kHz}$ , $BCLK = 512 \times f_S$	6.2		mA
$I_{BSTVDD}$			16		
$I_{IOVDD}$			0.3		

At  $T_A = 25^\circ\text{C}$ ,  $AVDD = 3.3\text{V}$ ,  $IOVDD = 3.3\text{V}$ ,  $BSTVDD = 3.3\text{V}$ ,  $HVDD = 11\text{V}$  (for external HVDD case),  $f_{IN} = 1\text{kHz}$  sinusoidal signal,  $f_S = 48\text{kHz}$ , 32-bit audio data,  $BCLK = 256 \times f_S$ , TDM target mode, PLL on, channel gain = 0dB, linear phase decimation filters, AC-coupled differential input with  $V_{CM} = 7.2\text{V}$ , MICBIAS programmed voltage = 8V and other default configurations; measured filter free with an audio precision with a 20Hz to a 20kHz un-weighted bandwidth, unless otherwise noted

PARAMETER		TEST CONDITIONS	MIN	NOM	MAX	UNIT
$I_{AVDD}$	Current consumption with ADC 2-channel operation, MICBIAS off, PLL off, Power tune mode <sup>(4)</sup>	$f_S = 48\text{kHz}$ , $BCLK = 512 \times f_S$	5.3			mA
$I_{IOVDD}$			0.3			

- (1) Ratio of output level with 1kHz full-scale sine-wave input, to the output level with the AC signal input shorted to ground, measured A-weighted over a 20Hz to 20kHz bandwidth using an audio analyzer.
- (2) All performance measurements done with 20kHz low-pass filter and, where noted, A-weighted filter. Failure to use such a filter can result in higher THD+N and lower SNR and dynamic range readings than shown in the Electrical Characteristics. The low-pass filter removes out-of-band noise, which, although not audible, can affect dynamic specification values.
- (3)  $ADC\_CHx\_BW\_MODE = 1'b1$  for Wideband Mode
- (4)  $PWR\_TUNE\_CFG0 = 0xD4$  and  $PLL\_DIS = 1'b1$  for Power Tune Mode

## 5.6 Timing Requirements: I<sup>2</sup>C Interface

At  $T_A = 25^\circ\text{C}$ , IOVDD = 3.3 V or 1.8V or 1.2V (unless otherwise noted); see Figure 5-1 for timing diagram. Set the IOVDD\_IO\_MODE bit correctly for IOVDD 1.8V and 1.2V operation.

		MIN	NOM	MAX	UNIT
<b>STANDARD-MODE</b>					
f <sub>SCL</sub>	SCL clock frequency	0		100	kHz
t <sub>HD,STA</sub>	Hold time (repeated) START condition. After this period, the first clock pulse is generated.	4			μs
t <sub>LOW</sub>	Low period of the SCL clock	4.7			μs
t <sub>HIGH</sub>	High period of the SCL clock	4			μs
t <sub>SU,STA</sub>	Setup time for a repeated START condition	4.7			μs
t <sub>HD,DAT</sub>	Data hold time	0		3.45	μs
t <sub>SU,DAT</sub>	Data setup time	250			ns
t <sub>r</sub>	SDA and SCL rise time			1000	ns
t <sub>f</sub>	SDA and SCL fall time			300	ns
t <sub>SU,STO</sub>	Setup time for STOP condition	4			μs
t <sub>BUF</sub>	Bus free time between a STOP and START condition	4.7			μs
<b>FAST-MODE</b>					
f <sub>SCL</sub>	SCL clock frequency	0		400	kHz
t <sub>HD,STA</sub>	Hold time (repeated) START condition. After this period, the first clock pulse is generated.	0.6			μs
t <sub>LOW</sub>	Low period of the SCL clock	1.3			μs
t <sub>HIGH</sub>	High period of the SCL clock	0.6			μs
t <sub>SU,STA</sub>	Setup time for a repeated START condition	0.6			μs
t <sub>HD,DAT</sub>	Data hold time	0		0.9	μs
t <sub>SU,DAT</sub>	Data setup time	100			ns
t <sub>r</sub>	SDA and SCL rise time	20		300	ns
t <sub>f</sub>	SDA and SCL fall time		$20 \times$ (IOVDD / 5.5 V)	300	ns
t <sub>SU,STO</sub>	Setup time for STOP condition	0.6			μs
t <sub>BUF</sub>	Bus free time between a STOP and START condition	1.3			μs
<b>FAST-MODE PLUS</b>					
f <sub>SCL</sub>	SCL clock frequency	0		1000	kHz
t <sub>HD,STA</sub>	Hold time (repeated) START condition. After this period, the first clock pulse is generated.	0.26			μs
t <sub>LOW</sub>	Low period of the SCL clock	0.5			μs
t <sub>HIGH</sub>	High period of the SCL clock	0.26			μs
t <sub>SU,STA</sub>	Setup time for a repeated START condition	0.26			μs
t <sub>HD,DAT</sub>	Data hold time	0			μs
t <sub>SU,DAT</sub>	Data setup time	50			ns
t <sub>r</sub>	SDA and SCL Rise Time			120	ns
t <sub>f</sub>	SDA and SCL Fall Time		$20 \times$ (IOVDD / 5.5 V)	120	ns
t <sub>SU,STO</sub>	Setup time for STOP condition	0.26			μs
t <sub>BUF</sub>	Bus free time between a STOP and START condition	0.5			μs

### 5.7 Switching Characteristics: I<sup>2</sup>C Interface

At T<sub>A</sub> = 25°C, IOVDD = 3.3 V or 1.8V or 1.2V (unless otherwise noted); see Figure 5-1 for timing diagram. Set the IOVDD\_IO\_MODE bit correctly for IOVDD 1.8V and 1.2V operation.

PARAMETER		TEST CONDITIONS	MIN	TYP	MAX	UNIT
t <sub>d</sub> (SDA)	SCL to SDA delay	Standard-mode	200		1250	ns
		Fast-mode	200		850	ns
		Fast-mode plus			400	ns

### 5.8 Timing Requirements: SPI Interface

At T<sub>A</sub> = 25°C, IOVDD = 3.3V or 1.8V and 20pF load on all outputs (unless otherwise noted); see Figure 5-2 for timing diagram. Set the IOVDD\_IO\_MODE bit correctly for IOVDD 1.8V and 1.2V operation.

PARAMETER		TEST CONDITIONS	MIN	NOM	MAX	UNIT
t <sub>(SCLK)</sub>	SCLK period		40			ns
t <sub>H</sub> (SCLK)	SCLK high pulse duration		18			ns
t <sub>L</sub> (SCLK)	SCLK low pulse duration		18			ns
t <sub>LEAD</sub>	Enable lead time		16			ns
t <sub>TRAIL</sub>	Enable trail time		16			ns
t <sub>DSEQ</sub>	Sequential transfer delay		20			ns
t <sub>SU</sub> (PICO)	PICO data setup time		8			ns
t <sub>HLD</sub> (PICO)	PICO data hold time		8			ns
t <sub>r</sub> (SCLK)	SCLK rise time	10% - 90% rise time			6	ns
t <sub>f</sub> (SCLK)	SCLK fall time	90% - 10% fall time			6	ns

### 5.9 Switching Characteristics: SPI Interface

At T<sub>A</sub> = 25°C, IOVDD = 3.3V or 1.8V and 20pF load on all outputs (unless otherwise noted); see Figure 5-2 for timing diagram. Set the IOVDD\_IO\_MODE bit correctly for IOVDD 1.8V and 1.2V operation.

PARAMETER		TEST CONDITIONS	MIN	TYP	MAX	UNIT
t <sub>a</sub> (POCI)	POCI access time	IOVDD = 1.8V or 1.2V			18	ns
		IOVDD = 3.3V			14	
t <sub>d</sub> (POCI)	SCLK to POCI delay	50% of SCLK to 50% of POCI, IOVDD = 1.8V or 1.2V			19	ns
		50% of SCLK to 50% of POCI, IOVDD = 3.3V			15	
t <sub>dis</sub> (POCI)	POCI disable time	IOVDD = 1.8V or 1.2V			18	ns
		IOVDD = 3.3V			14	

### 5.10 Timing Requirements: TDM, I<sup>2</sup>S or LJ Interface

At T<sub>A</sub> = 25°C, IOVDD = 3.3V or 1.8V or 1.2V and 20pF load on all outputs (unless otherwise noted); see Figure 5-3 for timing diagram. Set the IOVDD\_IO\_MODE bit correctly for IOVDD 1.8V and 1.2V operation.

PARAMETER		TEST CONDITIONS	MIN	NOM	MAX	UNIT
t <sub>(BCLK)</sub>	BCLK period		40			ns
t <sub>H</sub> (BCLK)	BCLK high pulse duration <sup>(1)</sup>		18			ns
t <sub>L</sub> (BCLK)	BCLK low pulse duration <sup>(1)</sup>		18			ns
t <sub>SU</sub> (FSYNC)	FSYNC setup time		8			ns
t <sub>HLD</sub> (FSYNC)	FSYNC hold time		8			ns
t <sub>r</sub> (BCLK)	BCLK rise time	10% - 90% rise time			10	ns
t <sub>f</sub> (BCLK)	BCLK fall time	90% - 10% fall time			10	ns

(1) To meet the timing specifications, the BCLK minimum high or low pulse duration must be higher than 25ns, if the DOUT data line is latched on the opposite BCLK edge polarity from the one used by the device to transmit the DOUT data.

### 5.11 Switching Characteristics: TDM, I<sup>2</sup>S or LJ Interface

At  $T_A = 25^\circ\text{C}$ , IOVDD = 3.3V or 1.8V or 1.2V and 20pF load on all outputs (unless otherwise noted); see Figure 5-3 for timing diagram. Set the IOVDD\_IO\_MODE bit correctly for IOVDD 1.8V and 1.2V operation.

PARAMETER		TEST CONDITIONS	MIN	TYP	MAX	UNIT
$t_{d(\text{DOUT-BCLK})}$	BCLK to DOUT delay	50% of BCLK to 50% of DOUT, IOVDD = 1.8V or 1.2V			18	ns
		50% of BCLK to 50% of DOUT, IOVDD = 3.3V			14	
$t_{d(\text{DOUT-FSYNC})}$	FSYNC to DOUT delay in TDM or LJ mode (for MSB data with TX_OFFSET = 0)	50% of FSYNC to 50% of DOUT, IOVDD = 1.8V or 1.2V			18	ns
		50% of FSYNC to 50% of DOUT, IOVDD = 3.3V			14	
$f_{(\text{BCLK})}$	BCLK output clock frequency; controller mode <sup>(1)</sup>				24.576	MHz
$t_{H(\text{BCLK})}$	BCLK high pulse duration; controller mode	IOVDD = 1.8V or 1.2V	14			ns
		IOVDD = 3.3V	14			
$t_{L(\text{BCLK})}$	BCLK low pulse duration; controller mode	IOVDD = 1.8V or 1.2V	14			ns
		IOVDD = 3.3V	14			
$t_{d(\text{FSYNC})}$	BCLK to FSYNC delay; controller mode	50% of BCLK to 50% of FSYNC, IOVDD = 1.8V or 1.2V			18	ns
		50% of BCLK to 50% of FSYNC, IOVDD = 3.3V			14	
$t_{r(\text{BCLK})}$	BCLK rise time; controller mode	10% - 90% rise time, IOVDD = 1.8V or 1.2V			10	ns
		10% - 90% rise time, IOVDD = 3.3V			10	
$t_{f(\text{BCLK})}$	BCLK fall time; controller mode	90% - 10% fall time, IOVDD = 1.8V or 1.2V			8	ns
		90% - 10% fall time, IOVDD = 3.3V			8	

(1) To meet the timing specifications, the BCLK output clock frequency must be lower than 18.5MHz, if the DOUT data line is latched on the opposite BCLK edge polarity from the one used by the device to transmit DOUT data.

### 5.12 Timing Requirements: PDM Digital Microphone Interface

At  $T_A = 25^\circ\text{C}$ , IOVDD = 3.3V or 1.8V or 1.2V and 20pF load on all outputs (unless otherwise noted); see Figure 5-4 for timing diagram. Set the IOVDD\_IO\_MODE bit correctly for IOVDD 1.8V and 1.2V operation.

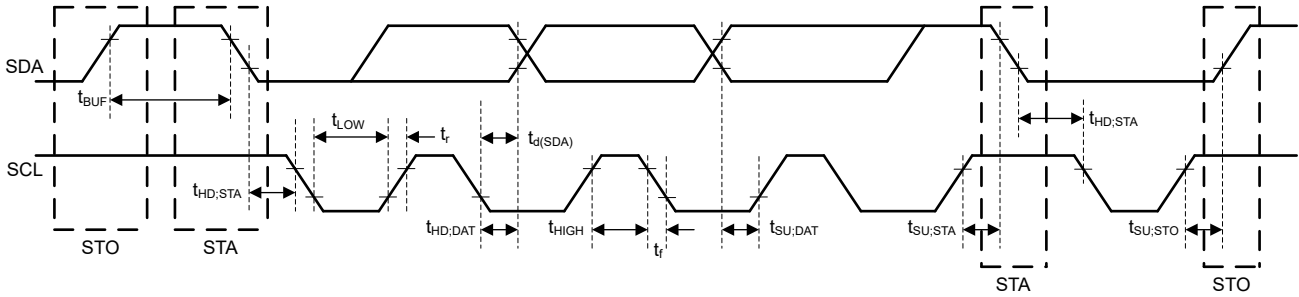
		MIN	NOM	MAX	UNIT
$t_{\text{SU}(\text{PDMINx})}$	PDMINx setup time	30			ns
$t_{\text{HLD}(\text{PDMINx})}$	PDMINx hold time	0			ns

### 5.13 Switching Characteristics: PDM Digital Microphone Interface

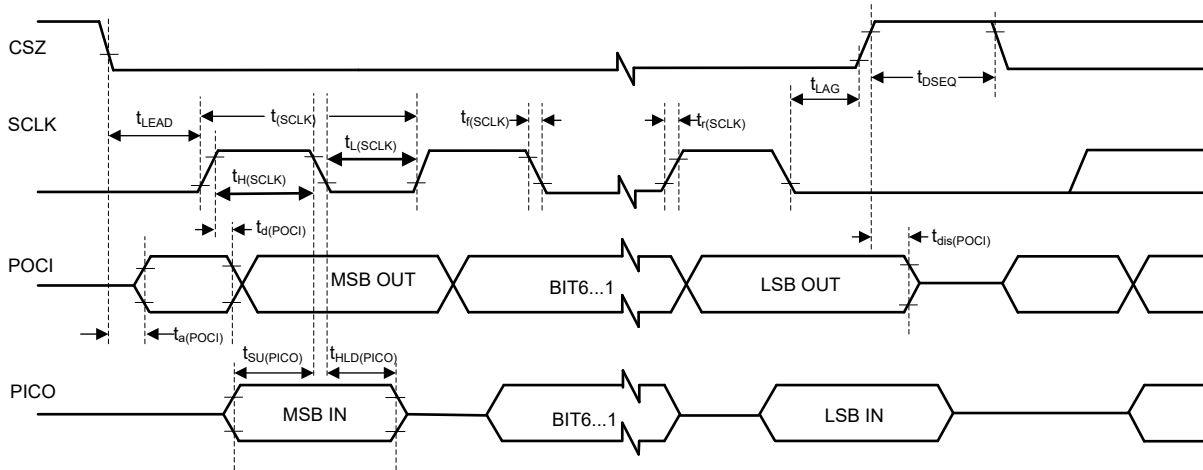
At  $T_A = 25^\circ\text{C}$ , IOVDD = 3.3V or 1.8V or 1.2V and 20pF load on all outputs (unless otherwise noted); see Figure 5-4 for timing diagram. Set the IOVDD\_IO\_MODE bit correctly for IOVDD 1.8V and 1.2V operation.

PARAMETER		TEST CONDITIONS	MIN	TYP	MAX	UNIT
$f_{(\text{PDMCLK})}$	PDMCLK clock frequency		0.768		6.144	MHz
$t_{H(\text{PDMCLK})}$	PDMCLK high pulse duration		72			ns
$t_{L(\text{PDMCLK})}$	PDMCLK low pulse duration		72			ns
$t_{r(\text{PDMCLK})}$	PDMCLK rise time	10% - 90% rise time			18	ns
$t_{f(\text{PDMCLK})}$	PDMCLK fall time	90% - 10% fall time			18	ns

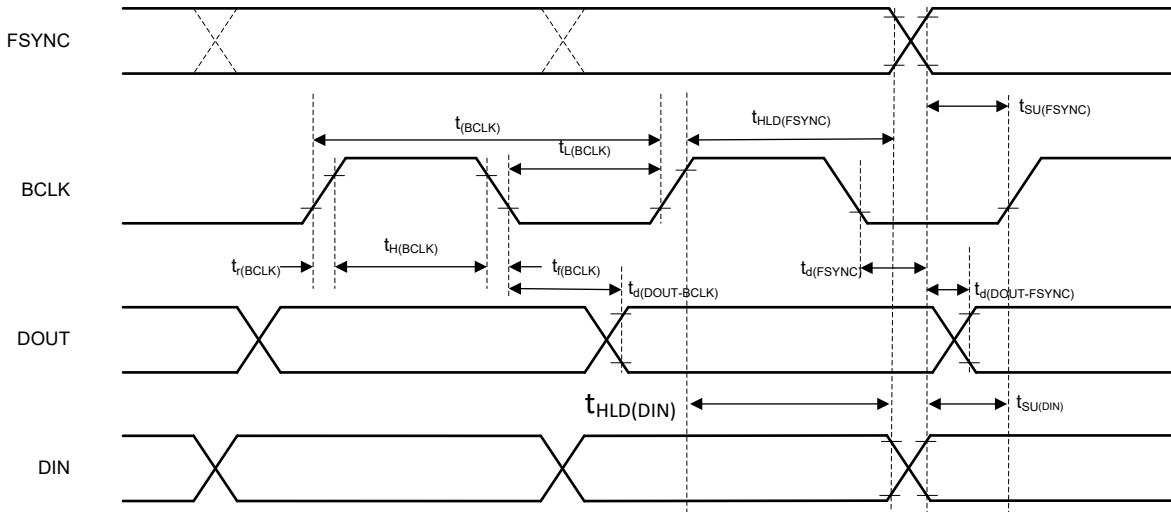
### 5.14 Timing Diagrams



**Figure 5-1. I<sup>2</sup>C Interface Timing Diagram**



**Figure 5-2. SPI Interface Timing Diagram**



**Figure 5-3. TDM, I<sup>2</sup>S, LJ Interface Timing Diagram**

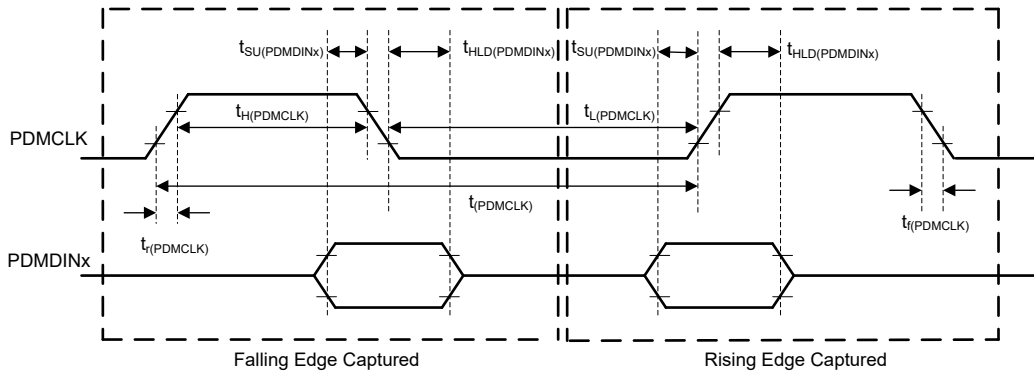


Figure 5-4. PDM Digital Microphone Interface Timing Diagram

### 5.15 Typical Characteristics

At  $T_A = 25^\circ\text{C}$ ,  $AVDD = 3.3\text{V}$ ,  $IOVDD = 3.3\text{V}$ ,  $f_{IN} = 1\text{kHz}$  sinusoidal signal,  $f_S = 48\text{kHz}$ , 32-bit audio data,  $BCLK = 256 \times f_S$ , TDM target mode, linear phase decimation filters, AC-coupled differential input with  $V_{CM} = 7.2\text{V}$ , PLL on, channel gain = 0dB, MICBIAS programmed voltage = 8V and other default configurations; measured filter free with an audio precision with a 20Hz to 20kHz un-weighted bandwidth, unless otherwise noted

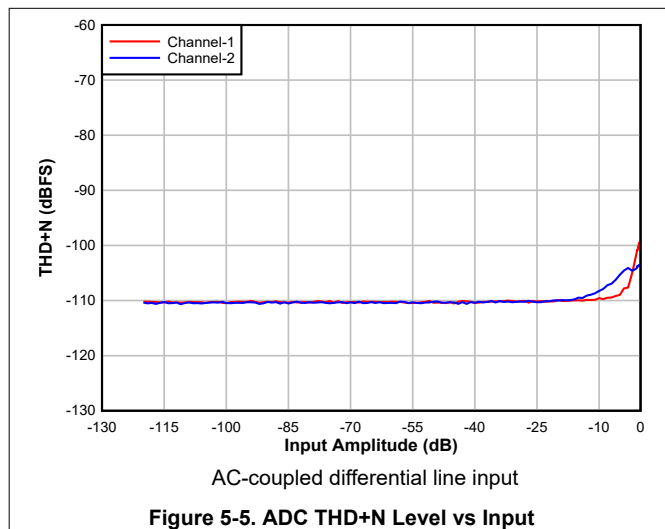


Figure 5-5. ADC THD+N Level vs Input

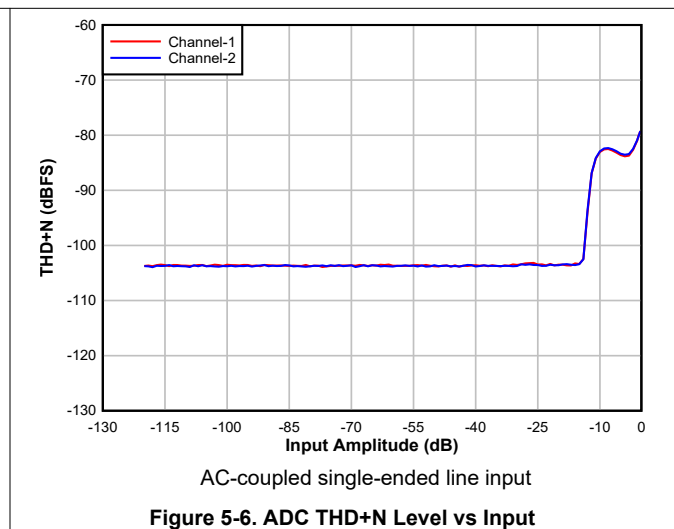


Figure 5-6. ADC THD+N Level vs Input

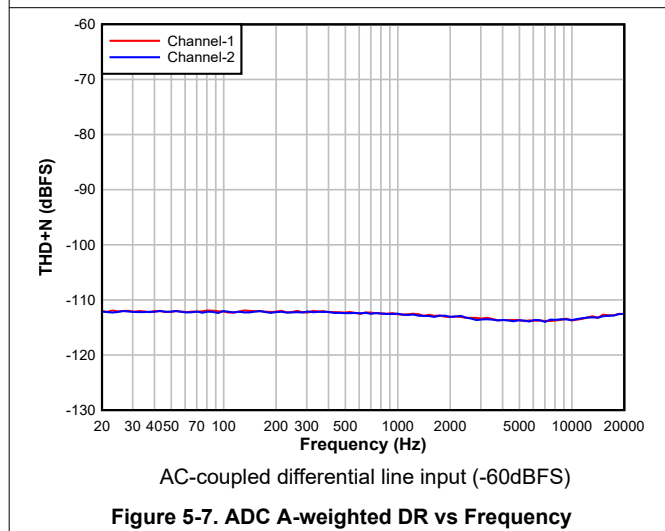


Figure 5-7. ADC A-weighted DR vs Frequency

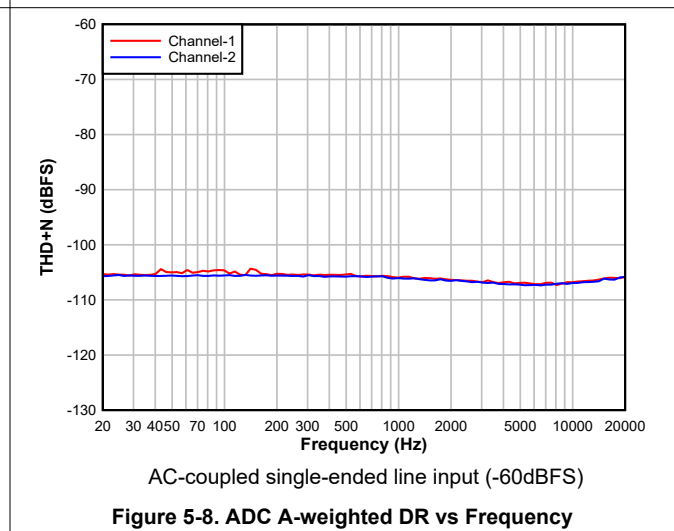
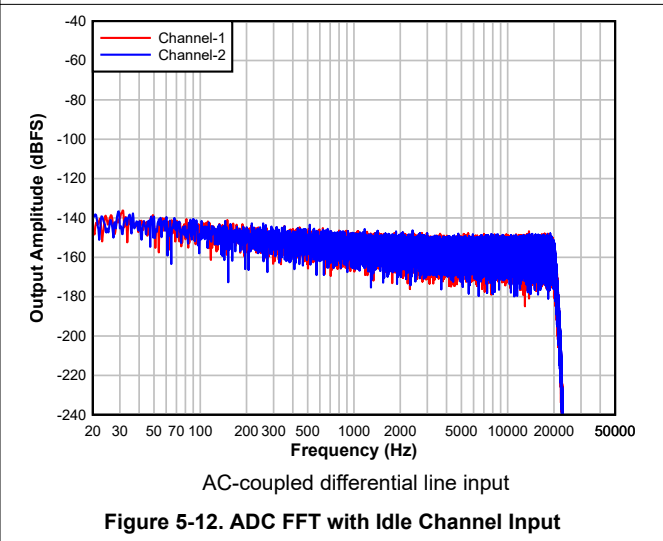
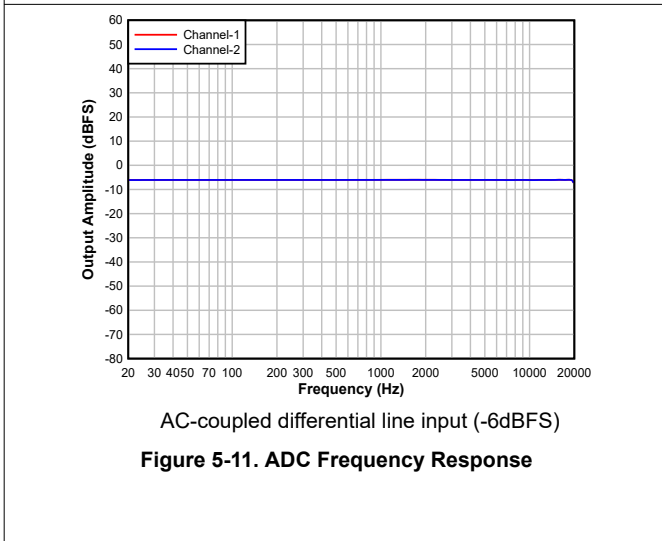
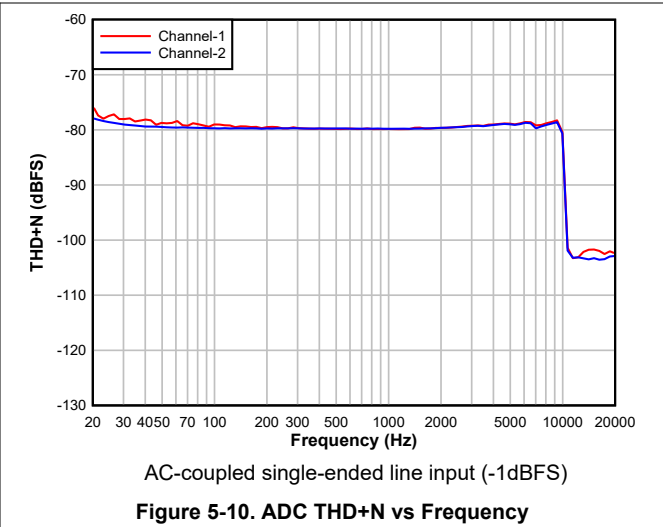
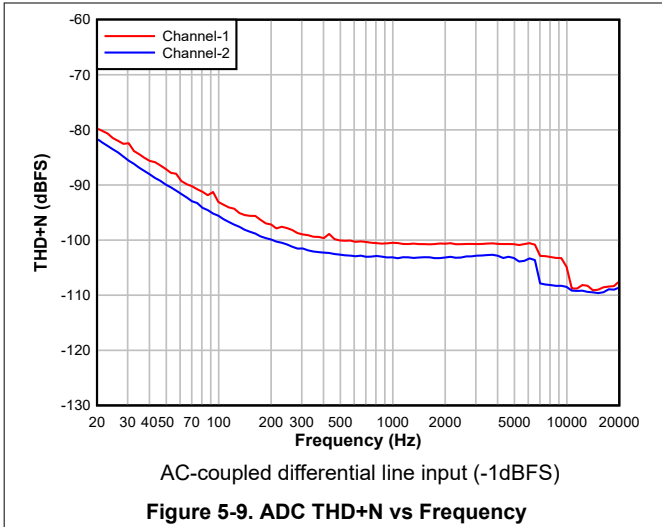


Figure 5-8. ADC A-weighted DR vs Frequency



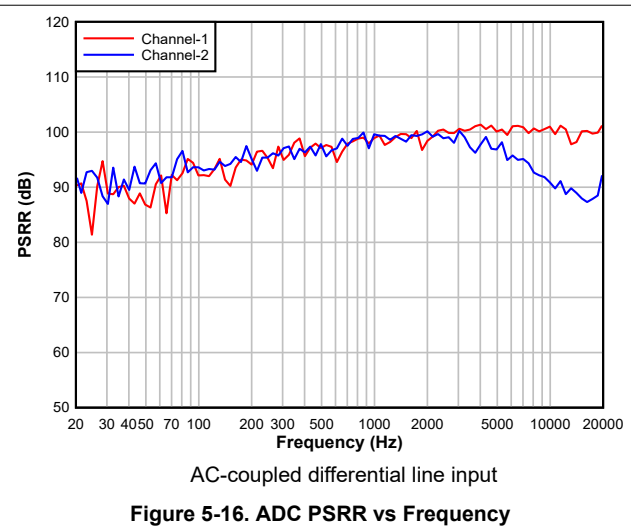
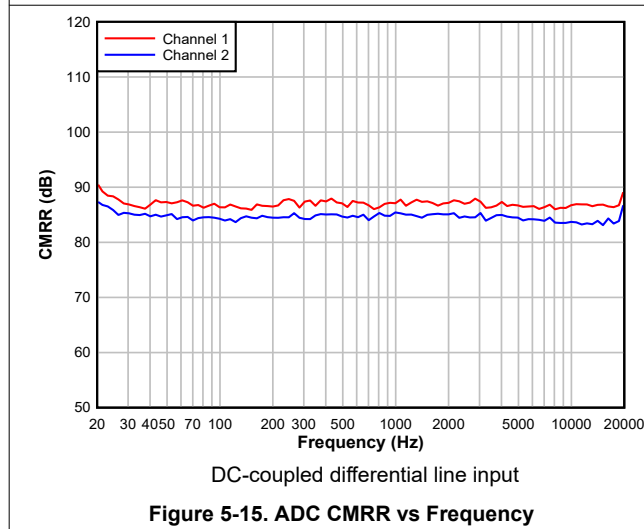
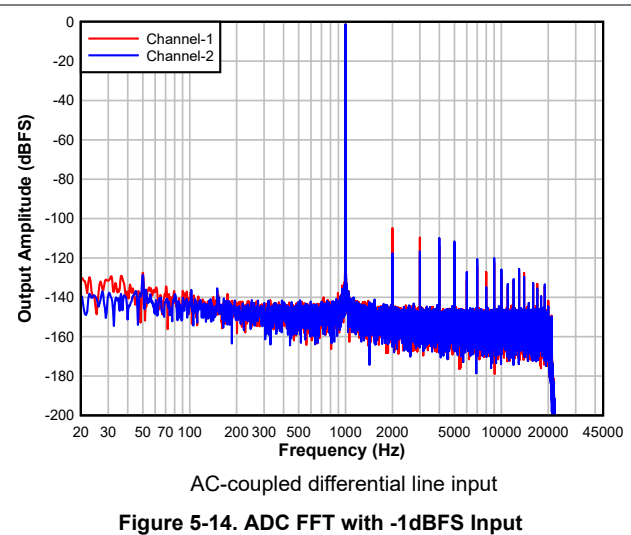
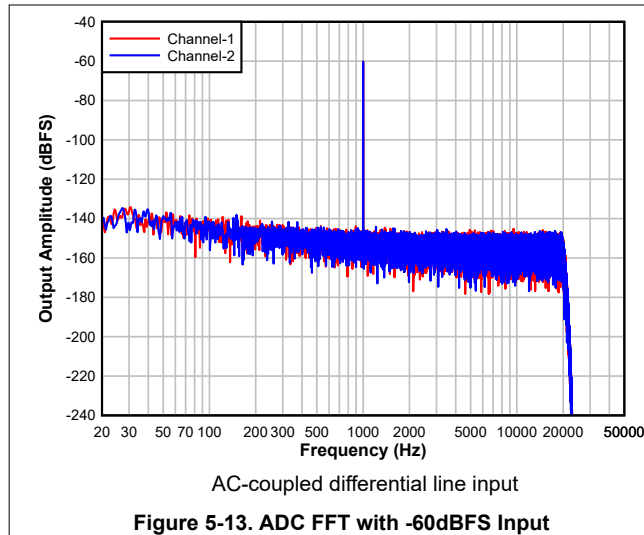
### 5.15 Typical Characteristics (continued)

At  $T_A = 25^\circ\text{C}$ ,  $AVDD = 3.3\text{V}$ ,  $IOVDD = 3.3\text{V}$ ,  $f_{IN} = 1\text{kHz}$  sinusoidal signal,  $f_S = 48\text{ kHz}$ , 32-bit audio data,  $BCLK = 256 \times f_S$ , TDM target mode, linear phase decimation filters, AC-coupled differential input with  $V_{CM} = 7.2\text{V}$ , PLL on, channel gain = 0dB, MICBIAS programmed voltage = 8V and other default configurations; measured filter free with an audio precision with a 20Hz to 20kHz un-weighted bandwidth, unless otherwise noted



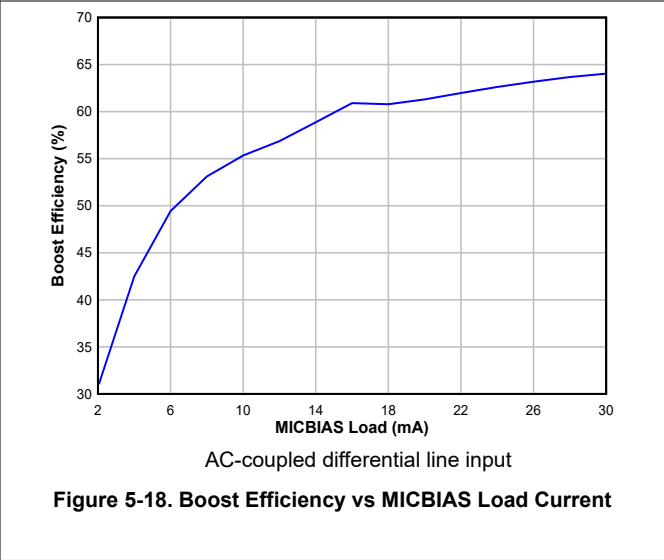
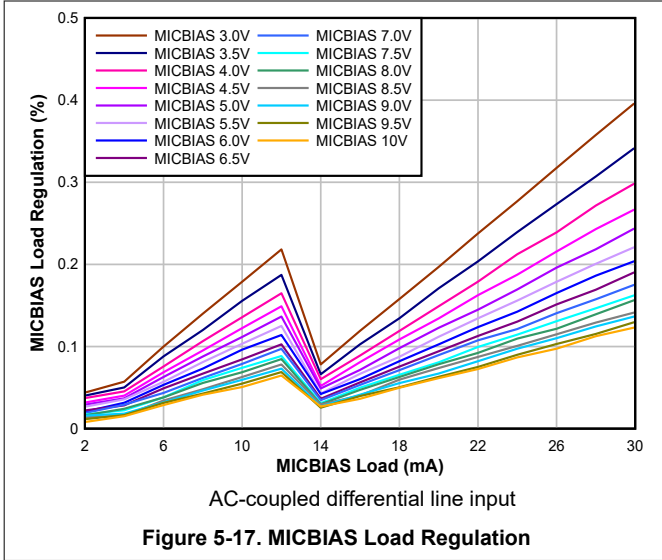
## 5.15 Typical Characteristics (continued)

At  $T_A = 25^\circ\text{C}$ ,  $AVDD = 3.3\text{V}$ ,  $IOVDD = 3.3\text{V}$ ,  $f_{IN} = 1\text{kHz}$  sinusoidal signal,  $f_S = 48\text{kHz}$ , 32-bit audio data,  $BCLK = 256 \times f_S$ , TDM target mode, linear phase decimation filters, AC-coupled differential input with  $V_{CM} = 7.2\text{V}$ , PLL on, channel gain = 0dB, MICBIAS programmed voltage = 8V and other default configurations; measured filter free with an audio precision with a 20Hz to 20kHz un-weighted bandwidth, unless otherwise noted



### 5.15 Typical Characteristics (continued)

At  $T_A = 25^\circ\text{C}$ ,  $AVDD = 3.3\text{V}$ ,  $IOVDD = 3.3\text{V}$ ,  $f_{IN} = 1\text{kHz}$  sinusoidal signal,  $f_S = 48\text{kHz}$ , 32-bit audio data,  $BCLK = 256 \times f_S$ , TDM target mode, linear phase decimation filters, AC-coupled differential input with  $V_{CM} = 7.2\text{V}$ , PLL on, channel gain = 0dB, MICBIAS programmed voltage = 8V and other default configurations; measured filter free with an audio precision with a 20Hz to 20kHz un-weighted bandwidth, unless otherwise noted



## 6 Detailed Description

### 6.1 Overview

The TAA5412-Q1 is from a scalable TA5xxx-Q1 family of audio converter devices. As part of the extended family of devices, the TAA5412-Q1 consists of a high-performance, low-power, flexible, multi-channel, audio analog-to-digital converter (ADC) with extensive feature integration. This device is intended for automotive applications such as vehicle cabin active noise cancellation, hands-free in-vehicle communication, emergency call, and multimedia applications. The high dynamic range of this device enables far-field audio recording with high fidelity. This device integrates a host of features that reduce cost, board space, and power consumption in space-constrained automotive sub-system designs. Package, performance, and device-compatible configuration registers make this device well suited for scalable system designs.

The TAA5412-Q1 consists of the following blocks:

- 2-channel, multibit, high-performance delta-sigma ( $\Delta\Sigma$ ) ADCs
- Configurable single-ended or differential audio inputs with high voltage signal swing
- High-voltage, low-noise programmable microphone bias output
- Over current diagnostics and protection for MICBIAS
- Highly flexible, comprehensive input fault diagnostic
- Automatic gain controller (AGC)
- Programmable decimation filters with linear-phase, low-latency or ultra low-latency options
- Programmable channel gain, volume control, and biquad filters for each channel
- Programmable phase and gain calibration with fine resolution for each channel
- Programmable high-pass filter (HPF) with programmable cut-off frequency and digital channel mixer
- Up to 4-channel pulse density modulation (PDM) digital microphone interface with high-performance decimation filter
- Integrated low-jitter, phase-locked loop (PLL) supporting a wide range of system clocks
- Integrated digital and analog voltage regulators to support single-supply operation
- Dual I<sup>2</sup>S or LJ or TDM interface with independent sample rates (synchronous)
- Synchronous sample rate converter (SRC)

Communication to the TAA5412-Q1 for configuring the control registers is supported using an I<sup>2</sup>C or SPI interface. The device supports a highly flexible audio serial interface [time-division multiplexing (TDM), I<sup>2</sup>S, or left-justified (LJ)] to transmit audio data seamlessly in the system across devices.

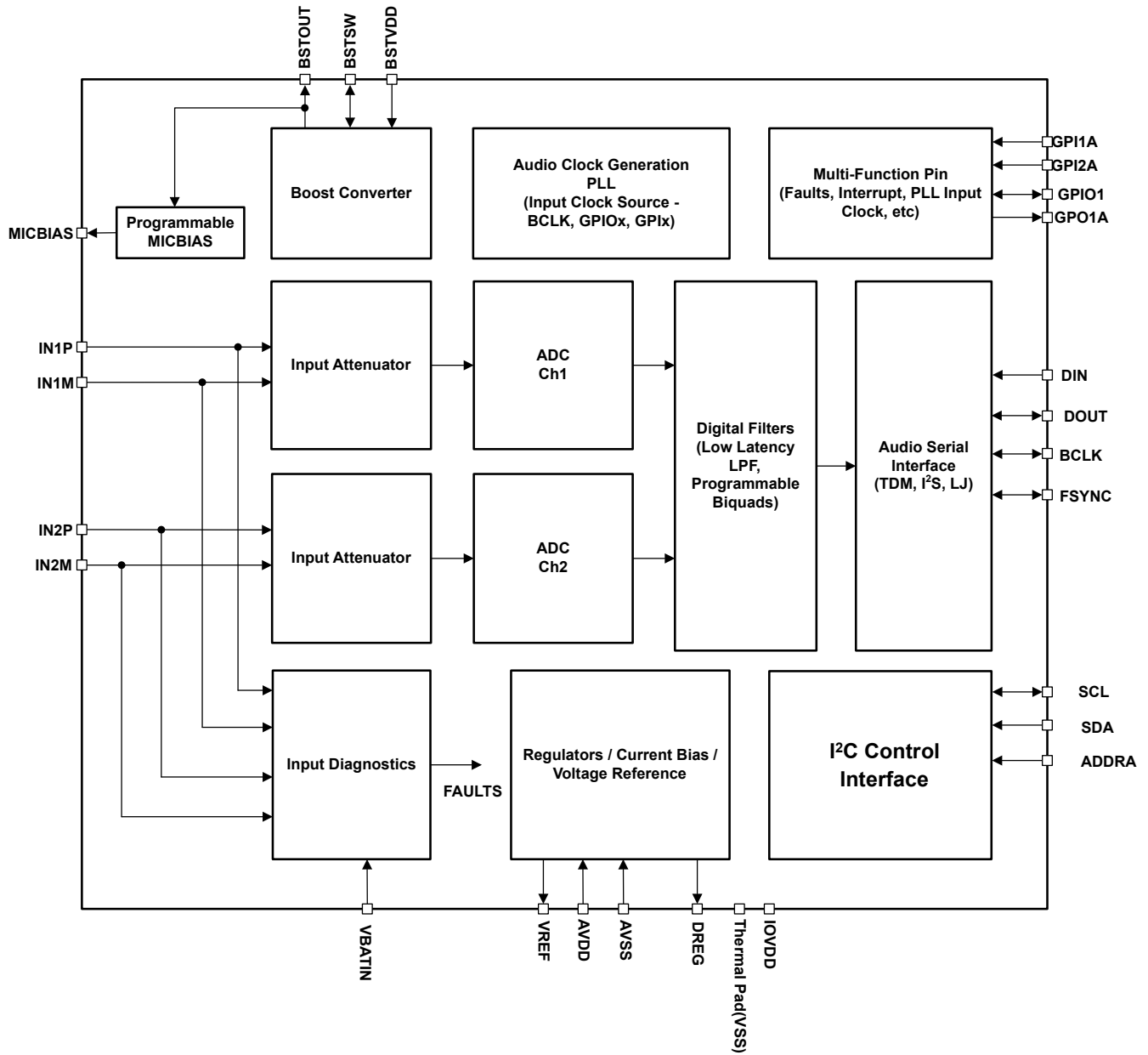
The device can support multiple devices by sharing the common I<sup>2</sup>C and TDM buses across devices. Moreover, the device includes a daisy-chain feature and a secondary audio serial output data pin. These features relax the shared TDM bus timing requirements and board design complexities when operating multiple devices for applications requiring high audio data bandwidth.

[Table 6-1](#) lists the reference abbreviations used throughout this document to registers that control the device.

**Table 6-1. Abbreviations for Register References**

REFERENCE	ABBREVIATION	DESCRIPTION	EXAMPLE
Page y, register z, bit k	Py_Rz_D[k]	Single data bit. The value of a single bit in a register.	Page 1, register 36, bit 0 = P1_R36_D[0]
Page y, register z, bits k-m	Py_Rz_D[k:m]	Range of data bits. A range of data bits (inclusive).	Page 1, register 36, bits 3, 2, 1, 0 = P1_R36_D[3:0]
Page y, register z	Py_Rz	One entire register. All eight bits in the register as a unit.	Page 1, register 36 = P1_R36
Page y, registers z-n	Py_Rz-Rn	Range of registers. A range of registers in the same page.	Page 1, registers 36, 37, 38 = P1_R36-R38

## 6.2 Functional Block Diagram



## 6.3 Feature Description

### 6.3.1 Serial Interfaces

This device has two serial interfaces: control and audio data. The control serial interface is used for device configuration. The audio data serial interface is used for transmitting audio data to the host device.

#### 6.3.1.1 Control Serial Interfaces

The device contains configuration registers and programmable coefficients that can be set to the desired values for a specific system and application use. All these registers can be accessed using either I<sup>2</sup>C or SPI communication to the device. For more information, see [Section 7](#) and [Section 6.5](#).

#### 6.3.1.2 Audio Serial Interfaces

Digital audio data flows between the host processor and the TAA5412-Q1 on the digital audio serial interface (ASI), or audio bus. This highly flexible ASI bus includes a TDM mode for multichannel operation, support for I<sup>2</sup>S or left-justified protocols format, programmable data length options, very flexible controller-target configurability for bus clock lines and the ability to communicate with multiple devices within a system directly.

The TAA5412-Q1 supports up to two ASI Interfaces. Secondary ASI Clock and Data Pins can be configured by setting GPIO's. Frame Sync of two ASI's must be synchronous. See the [TAX5X1X Synchronous Sample Rate Conversion application report](#) for more details on Secondary ASI.

The bus protocol TDM, I<sup>2</sup>S, or left-justified (LJ) format can be selected for primary ASI by using the PASI\_FORMAT[1:0], P0\_R26\_D[7:6] register bits. As shown in [Table 6-2](#) and [Table 6-3](#), these modes are all most significant byte (MSB)-first, pulse code modulation (PCM) data format, with the output channel data word-length programmable as 16, 20, 24, or 32 bits by configuring the PASI\_WLEN[1:0], P0\_R26\_D[5:4] register bits.

**Table 6-2. Primary Audio Serial Interface Format**

P0_R26_D[7:6] : PASI_FORMAT[1:0]	PRIMARY AUDIO SERIAL INTERFACE FORMAT
00 (default)	Time division multiplexing (TDM) mode
01	Inter IC sound (I <sup>2</sup> S) mode
10	Left-justified (LJ) mode
11	Reserved (do not use this setting)

**Table 6-3. Primary Audio Serial Interface Data Word-Length**

P0_R7_D[5:4] : PASI_WLEN[1:0]	PRIMARY AUDIO OUTPUT CHANNEL DATA WORD-LENGTH
00	Data word-length set to 16 bits
01	Data word-length set to 20 bits
10	Data word-length set to 24 bits
11 (default)	Data word-length set to 32 bits

The frame sync pin, FSYNC, is used in this audio bus protocol to define the beginning of a frame and has the same frequency as the output data sample rates. The bit clock pin, BCLK, is used to clock out the digital audio data across the serial bus. The number of bit-clock cycles in a frame must accommodate multiple device active output channels with the programmed data word length.

A frame consists of multiple time-division channel slots (up to 32) to allow all input/output channel audio data transmissions to complete on the audio bus by a device or multiple devices sharing the same audio bus. The device supports up to eight input channels and eight output channels that can be configured on primary ASI bus to place their audio data on bus slot 0 to slot 31. [Table 6-4](#) lists the output channel-1 slot configuration settings. In I<sup>2</sup>S and LJ mode, the slots are divided into two sets, left-channel slots and right-channel slots, as described in the [Section 6.3.1.2.2](#) and [Section 6.3.1.2.3](#) sections.

**Table 6-4. Output Channel-1 Slot Assignment Settings**

P0_R30_D[4:0] : PASI_TX_CH1_SLOT[4:0]	OUTPUT CHANNEL 1 SLOT ASSIGNMENT
0 0000 = 0d (default)	Slot 0 for TDM or left slot 0 for I <sup>2</sup> S, LJ.
0 0001 = 1d	Slot 1 for TDM or left slot 1 for LJ.
...	...
0 1111 = 15d	Slot 15 for TDM or left slot 15 for LJ.
1 0000 = 16d	Slot 16 for TDM or right slot 0 for I <sup>2</sup> S, LJ.
...	...
1 1110 = 30d	Slot 30 for TDM or right slot 14 for LJ.
1 1111 = 31d	Slot 31 for TDM or right slot 15 for LJ.

Similarly, the slot assignment setting for output channel 2 to channel 8 can be done using the PASI\_TX\_CH2\_SLOT (P0\_R31) to PASI\_TX\_CH8\_SLOT (P0\_R37) registers and for input channel 1 to channel 8 by using the PASI\_RX\_CH1\_SLOT\_NUM (P0\_R40\_D[4:0]) to PAS\_RX\_CH8\_SLOT\_NUM (P0\_R47\_D[4:0]) registers, respectively.

The slot word length is the same as the primary ASI channel word length set for the device. The output channel data word length must be set to the same value for all TAA5412-Q1 devices if all devices share the same ASI bus in a system. The maximum number of slots possible for the ASI bus in a system is limited by the available

bus bandwidth, which depends upon the BCLK frequency, output data sample rate used, and the channel data word length configured.



The device also includes a feature that offsets the start of the slot data transfer with respect to the frame sync by up to 31 cycles of the bit clock. Offset can be configured independently for input and output data paths. [Table 6-4](#) and [Table 6-5](#) lists the programmable offset configuration settings for transmission and receive paths respectively.

**Table 6-5. Programmable Offset Settings for the ASI Slot Start for transmission**

P0_R28_D[4:0] : PASI_TX_OFFSET[4:0]	PROGRAMMABLE OFFSET SETTING FOR SLOT DATA TRANSMISSION START
0 0000 = 0d (default)	The device follows the standard protocol timing without any offset.
0 0001 = 1d	Slot start is offset by one BCLK cycle, as compared to standard protocol timing. For I <sup>2</sup> S or LJ, the left and right slot start is offset by one BCLK cycle, as compared to standard protocol timing.
.....	.....
1 1110 = 30d	Slot start is offset by 30 BCLK cycles, as compared to standard protocol timing. For I <sup>2</sup> S or LJ, the left and right slot start is offset by 30 BCLK cycles, as compared to standard protocol timing.
1 1111 = 31d	Slot start is offset by 31 BCLK cycles, as compared to standard protocol timing. For I <sup>2</sup> S or LJ, the left and right slot start is offset by 31 BCLK cycles, as compared to standard protocol timing.

**Table 6-6. Programmable Offset Settings for the ASI Slot Start for Receive**

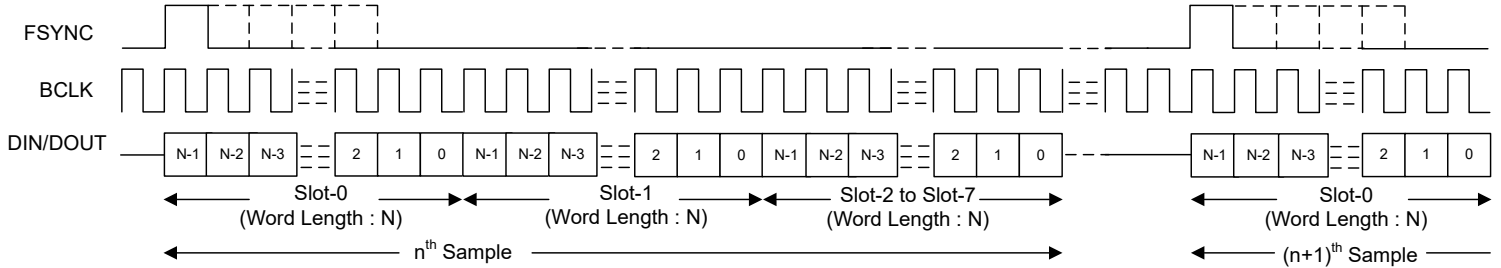
P0_R38_D[4:0] : PASI_RX_OFFSET[4:0]	PROGRAMMABLE OFFSET SETTING FOR SLOT DATA RECEIVE START
0 0000 = 0d (default)	The device follows the standard protocol timing without any offset.
0 0001 = 1d	Slot start is offset by one BCLK cycle, as compared to standard protocol timing. For I <sup>2</sup> S or LJ, the left and right slot start is offset by one BCLK cycle, as compared to standard protocol timing.
.....	.....
1 1110 = 30d	Slot start is offset by 30 BCLK cycles, as compared to standard protocol timing. For I <sup>2</sup> S or LJ, the left and right slot start is offset by 30 BCLK cycles, as compared to standard protocol timing.
1 1111 = 31d	Slot start is offset by 31 BCLK cycles, as compared to standard protocol timing. For I <sup>2</sup> S or LJ, the left and right slot start is offset by 31 BCLK cycles, as compared to standard protocol timing.

The device also features the ability to invert the polarity of the frame sync pin, FSYNC, used to transfer the audio data as compared to the default FSYNC polarity used in standard protocol timing. This feature can be set using the PASI\_FSYNC\_POL, P0\_R26\_D[3] register bit. Similarly, the device can invert the polarity of the bit clock pin, BCLK, which can be set using the PASI\_BCLK\_POL, P0\_R26\_D[2] register bit.

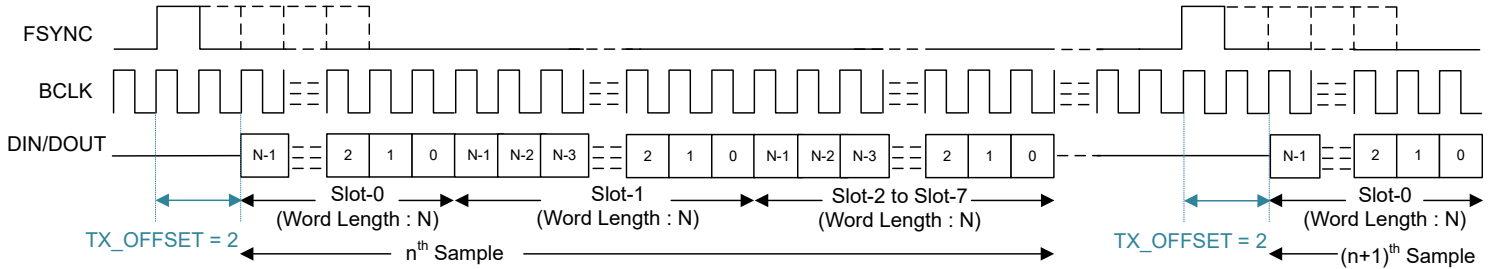
In addition, the word clock and bit clock can be independently configured in either Controller or Target mode, for flexible connectivity to a wide variety of processors. The word clock is used to define the beginning of a frame, and may be programmed as either a pulse or a square-wave signal. The frequency of this clock corresponds to the maximum of the selected ADC sampling frequencies.

**6.3.1.2.1 Time Division Multiplexed Audio (TDM) Interface**

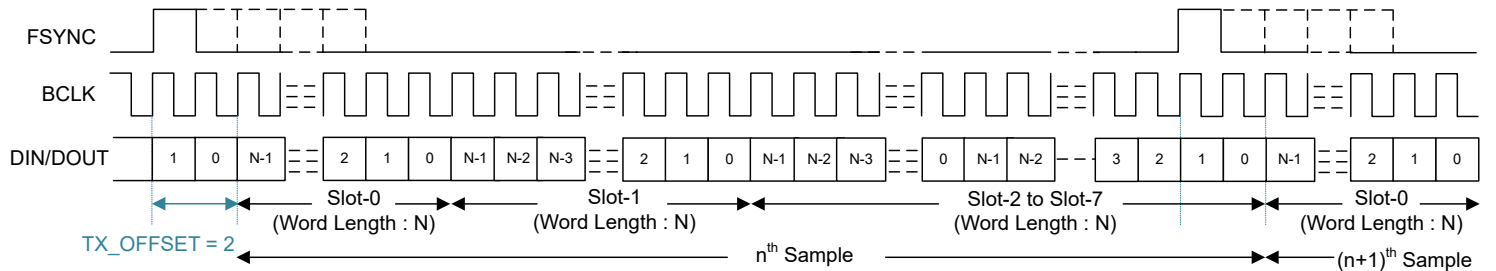
In TDM mode, also known as DSP mode, the rising edge of FSYNC starts the data transfer with the slot 0 data first. Immediately after the slot 0 data transmission, the remaining slot data are transmitted in order. FSYNC and each data bit (except the MSB of slot 0 when TX\_OFFSET equals 0) is transmitted on the rising edge of BCLK. [Figure 6-1](#) to [Figure 6-4](#) illustrate the protocol timing for TDM operation with various configurations for transmit DOUT line. The same protocol timing is applicable for receive DIN line as well to support daisy chain input.



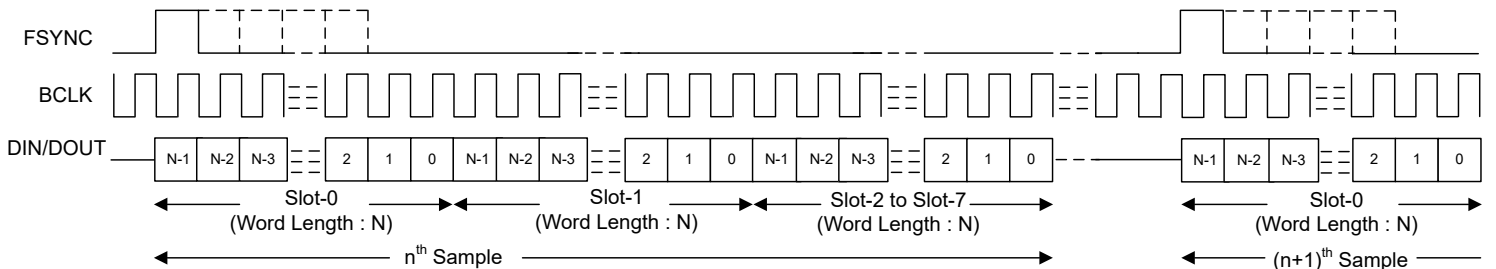
**Figure 6-1. TDM Mode Standard Protocol Timing (PASI\_TX\_OFFSET = 0)**



**Figure 6-2. TDM Mode Protocol Timing (PASI\_TX\_OFFSET = 2)**



**Figure 6-3. TDM Mode Protocol Timing (No Idle BCLK Cycles, PASI\_TX\_OFFSET = 2)**



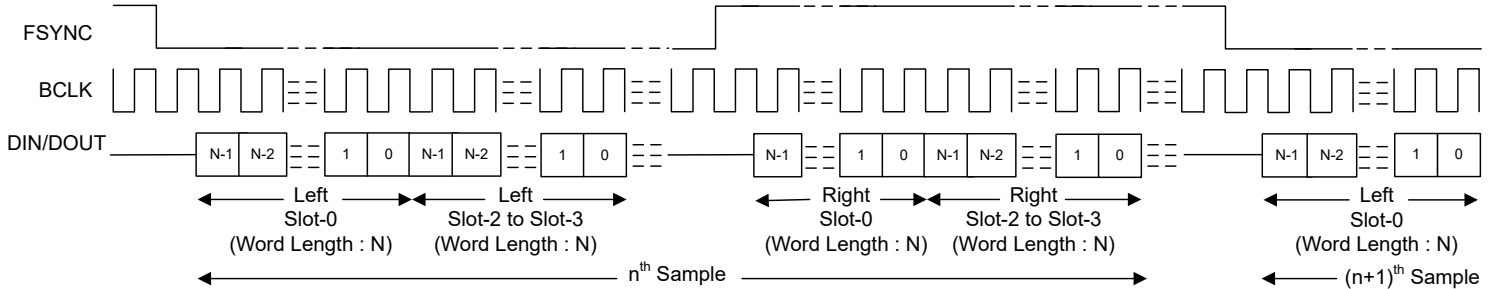
**Figure 6-4. TDM Mode Protocol Timing (PASI\_TX\_OFFSET = 0 and PASI\_BCLK\_POL = 1)**

For proper operation of the audio bus in TDM mode, the number of bit clocks per frame must be greater than or equal to the number of active output channels times the programmed word length of the output channel data. The device supports FSYNC as a pulse with a 1-cycle-wide bit clock, but also supports multiples as well. For a higher BCLK frequency operation, using TDM mode with a PASI\_TX\_OFFSET value higher than 0 is recommended.

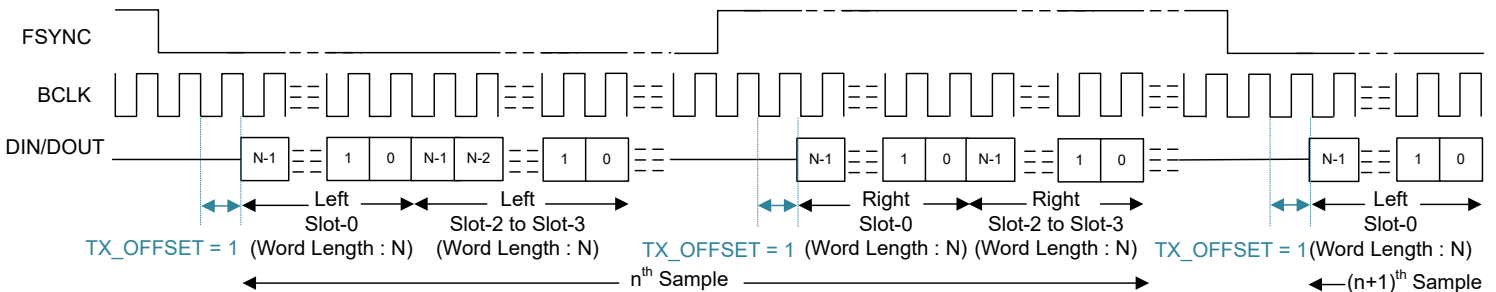
### 6.3.1.2.2 Inter IC Sound (I<sup>2</sup>S) Interface

The standard I<sup>2</sup>S protocol is defined for only two channels: left and right. The device extends the same protocol timing for multichannel operation. In I<sup>2</sup>S mode, the MSB of the left slot 0 is transmitted on the falling edge of BCLK in the second cycle after the *falling* edge of FSYNC. Immediately after the left slot 0 data transmission, the remaining left slot data are transmitted in order. The MSB of the right slot 0 is transmitted on the falling edge of

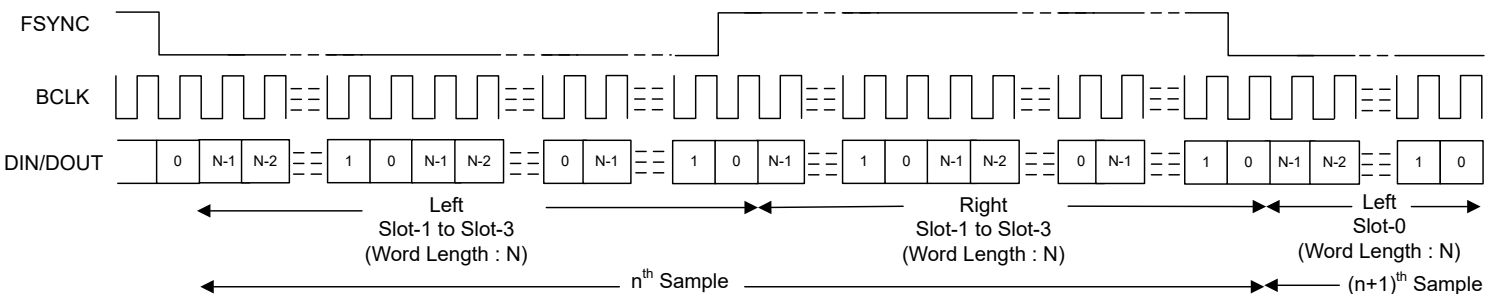
BCLK in the second cycle after the *rising* edge of FSYNC. Immediately after the right slot 0 data transmission, the remaining right slot data are transmitted in order. FSYNC and each data bit is transmitted on the falling edge of BCLK. Figure 6-5 to Figure 6-8 illustrate the protocol timing for I<sup>2</sup>S operation with various configurations for transmit DOUT line. The same protocol timing is applicable for receive DIN line as well to support daisy chain input.



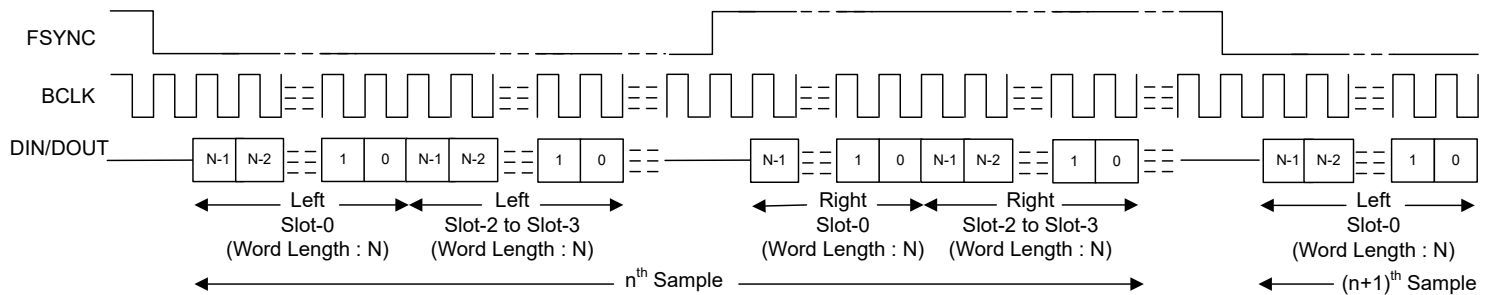
**Figure 6-5. I<sup>2</sup>S Mode Standard Protocol Timing (PASI\_TX\_OFFSET = 0)**



**Figure 6-6. I<sup>2</sup>S Protocol Timing (PASI\_TX\_OFFSET = 1)**



**Figure 6-7. I<sup>2</sup>S Protocol Timing (No Idle BCLK Cycles, PASI\_TX\_OFFSET = 0)**



**Figure 6-8. I<sup>2</sup>S Protocol Timing (PASI\_TX\_OFFSET = 0 and PASI\_BCLK\_POL = 1)**

For proper operation of the audio bus in I<sup>2</sup>S mode, the number of bit clocks per frame must be greater than or equal to the number of active output channels (including left and right slots) times the programmed word length

of the output channel data. The device FSYNC low pulse must be a number of BCLK cycles wide that is greater than or equal to the number of active left slots times the data word length configured. Similarly, the FSYNC high pulse must be a number of BCLK cycles wide that is greater than or equal to the number of active right slots times the data word length configured.

### 6.3.1.2.3 Left-Justified (LJ) Interface

The standard LJ protocol is defined for only two channels: left and right. The device extends the same protocol timing for multichannel operation. In LJ mode, the MSB of the left slot 0 is transmitted in the same BCLK cycle after the *rising* edge of FSYNC. Each subsequent data bit is transmitted on the falling edge of BCLK. Immediately after the left slot 0 data transmission, the remaining left slot data are transmitted in order. The MSB of the right slot 0 is transmitted in the same BCLK cycle after the *falling* edge of FSYNC. Each subsequent data bit is transmitted on the falling edge of BCLK. Immediately after the right slot 0 data transmission, the remaining right slot data are transmitted in order. FSYNC is transmitted on the falling edge of BCLK. Figure 6-9 to Figure 6-12 illustrate the protocol timing for LJ operation with various configurations for transmit DOUT line. The same protocol timing is applicable for receive DIN line as well to support daisy chain input.

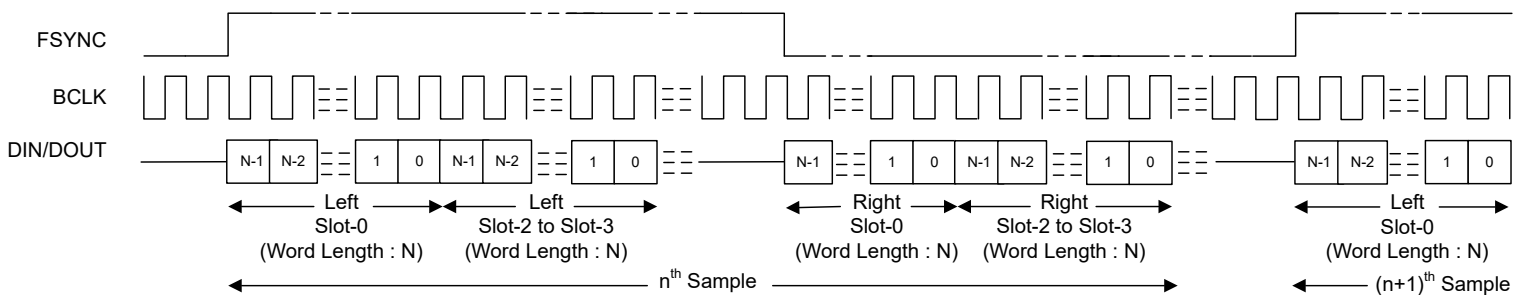


Figure 6-9. LJ Mode Standard Protocol Timing (TX\_OFFSET = 0)

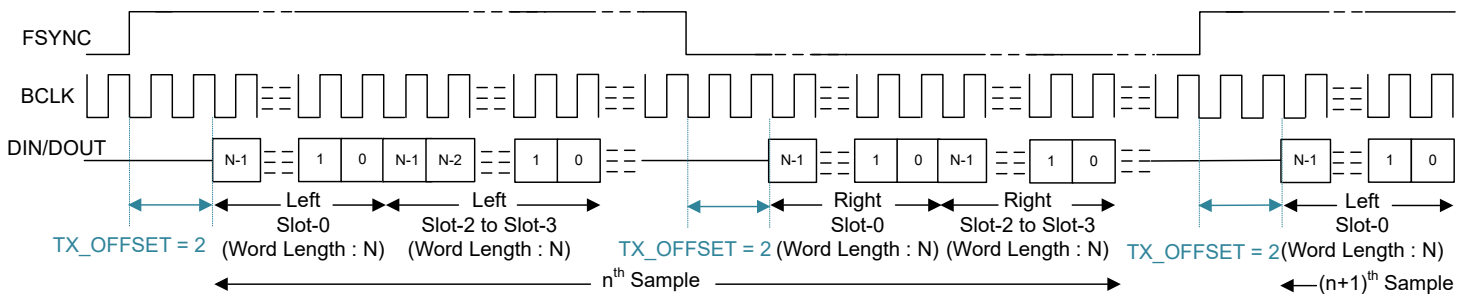


Figure 6-10. LJ Protocol Timing (TX\_OFFSET = 2)

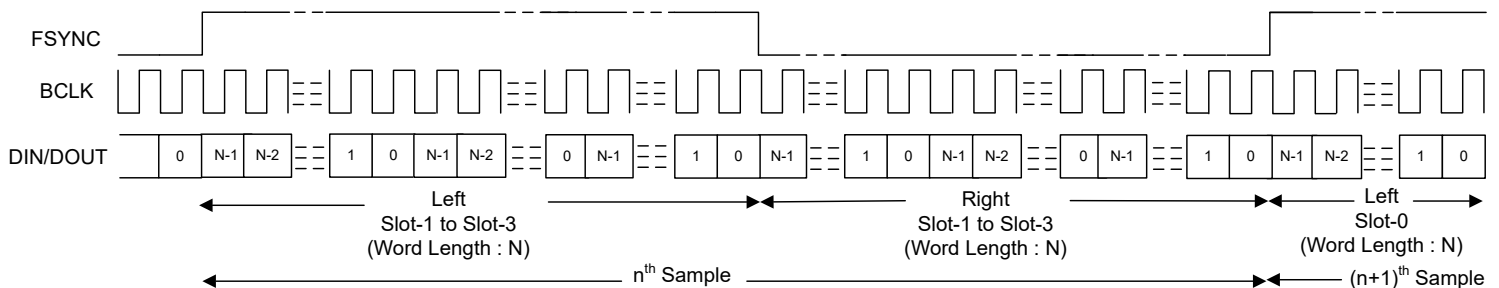
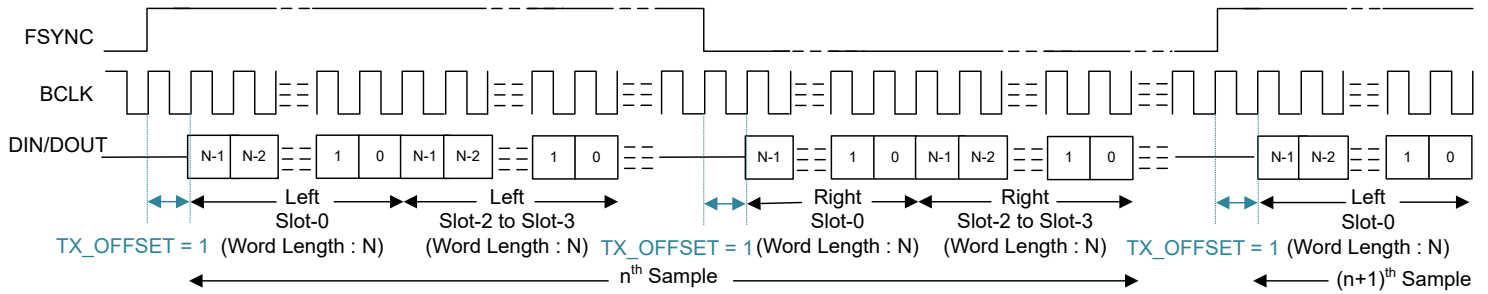


Figure 6-11. LJ Protocol Timing (No Idle BCLK Cycles, TX\_OFFSET = 0)

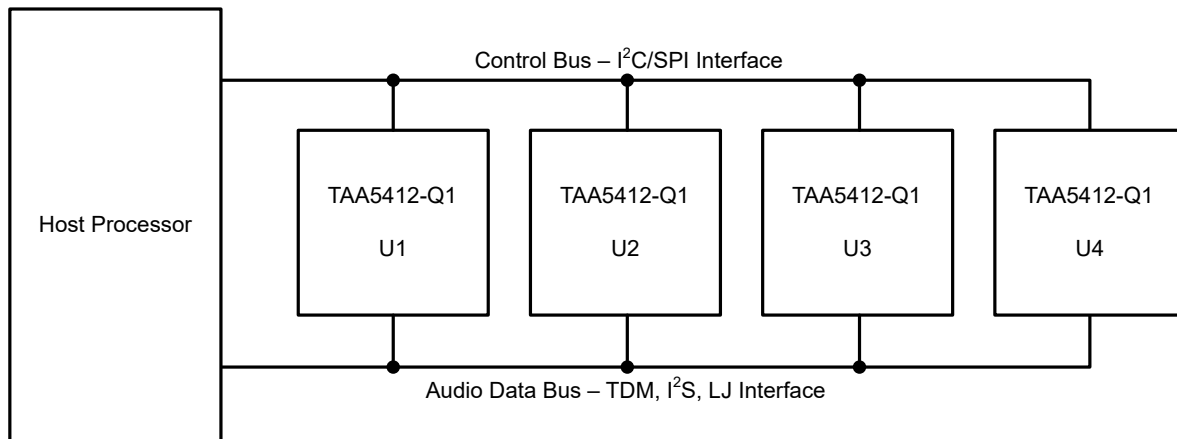


**Figure 6-12. LJ Protocol Timing (TX\_OFFSET = 1 and BCLK\_POL = 1)**

For proper operation of the audio bus in LJ mode, the number of bit clocks per frame must be greater than or equal to the number of active output channels (including left and right slots) times the programmed word length of the output channel data. The device FSYNC high pulse must be a number of BCLK cycles wide that is greater than or equal to the number of active left slots times the data word length configured. Similarly, the FSYNC low pulse must be number of BCLK cycles wide that is greater than or equal to the number of active right slots times the data word length configured. For a higher BCLK frequency operation, using LJ mode with a TX\_OFFSET value higher than 0 is recommended.

### 6.3.1.3 Using Multiple Devices With Shared Buses

The device has many supported features and flexible options that can be used in the system to seamlessly connect multiple TAA5412-Q1 devices by sharing a single common I<sup>2</sup>C or SPI control bus and an audio serial interface bus. This architecture enables multiple applications to be applied to a system that require a microphone or speaker array for beam-forming operation, audio conferencing, noise cancellation, and so forth. [Figure 6-13](#) shows a diagram of multiple TAA5412-Q1 devices in a configuration where the control and audio data buses are shared.



**Figure 6-13. Multiple TAA5412-Q1 Devices With Shared Control and Audio Data Buses**

The TAA5412-Q1 consists of the following features to enable seamless connection and interaction of multiple devices using a shared bus:

- Supports up to two pin-programmable I<sup>2</sup>C target addresses
- I<sup>2</sup>C broadcast simultaneously writes to (or triggers) all TAA5412-Q1 devices
- Supports up to 32 configuration input/output channel slots for the audio serial interface
- Tri-state feature (with enable and disable) for the unused audio data slots of the device
- Supports a bus-holder feature (with enable and disable) to keep the last driven value on the audio bus
- The GPIO1, GPIxA or GPO1A pin can be configured as a secondary input/output data lane or as a secondary audio serial interface

- The GPIO1, GPIxA or GPO1A pin can be used in a daisy-chain configuration of multiple TAA5412-Q1 devices
- Supports one BCLK cycle data latching timing to relax the timing requirement for the high-speed interface
- Programmable controller and target options for both primary and secondary audio serial interface
- Ability to synchronize the multiple devices for the simultaneous sampling requirement across devices

See the [Multiple TAC5x1x Devices With a Shared TDM and I<sup>2</sup>C/SPI Bus application report](#) for further details.

### 6.3.2 Phase-Locked Loop (PLL) and Clock Generation

The device has a smart auto-configuration block to generate all necessary internal clocks required for the ADC modulator and the digital filter engine used for signal processing. This configuration is done by monitoring the frequency of the FSYNC and BCLK signal on the audio buses.

The device supports the various data sample rates (of the FSYNC signal frequency) and the BCLK to FSYNC ratio to configure all clock dividers, including the PLL configuration, internally without host programming. [Table 6-7](#) and [Table 6-8](#) list the supported FSYNC and BCLK frequencies.

**Table 6-7. Supported FSYNC (Multiples or Submultiples of 48kHz) and BCLK Frequencies**

BCLK TO FSYNC RATIO	BCLK (MHz)								
	FSYNC (8 kHz)	FSYNC (16 kHz)	FSYNC (24 kHz)	FSYNC (32 kHz)	FSYNC (48 kHz)	FSYNC (96 kHz)	FSYNC (192 kHz)	FSYNC (384 kHz)	FSYNC (768 kHz)
16	Reserved	0.256	0.384	0.512	0.768	1.536	3.072	6.144	12.288
24	Reserved	0.384	0.576	0.768	1.152	2.304	4.608	9.216	18.432
32	0.256	0.512	0.768	1.024	1.536	3.072	6.144	12.288	24.576
48	0.384	0.768	1.152	1.536	2.304	4.608	9.216	18.432	Reserved
64	0.512	1.024	1.536	2.048	3.072	6.144	12.288	24.576	Reserved
96	0.768	1.536	2.304	3.072	4.608	9.216	18.432	Reserved	Reserved
128	1.024	2.048	3.072	4.096	6.144	12.288	24.576	Reserved	Reserved
192	1.536	3.072	4.608	6.144	9.216	18.432	Reserved	Reserved	Reserved
256	2.048	4.096	6.144	8.192	12.288	24.576	Reserved	Reserved	Reserved
384	3.072	6.144	9.216	12.288	18.432	Reserved	Reserved	Reserved	Reserved
512	4.096	8.192	12.288	16.384	24.576	Reserved	Reserved	Reserved	Reserved
1024	8.192	16.384	24.576	Reserved	Reserved	Reserved	Reserved	Reserved	Reserved
2048	16.384	Reserved	Reserved	Reserved	Reserved	Reserved	Reserved	Reserved	Reserved

**Table 6-8. Supported FSYNC (Multiples or Submultiples of 44.1kHz) and BCLK Frequencies**

BCLK TO FSYNC RATIO	BCLK (MHz)								
	FSYNC (7.35 kHz)	FSYNC (14.7 kHz)	FSYNC (22.05 kHz)	FSYNC (29.4 kHz)	FSYNC (44.1 kHz)	FSYNC (88.2 kHz)	FSYNC (176.4 kHz)	FSYNC (352.8 kHz)	FSYNC (705.6 kHz)
16	Reserved	Reserved	0.3528	0.4704	0.7056	1.4112	2.8224	5.6448	11.2896
24	Reserved	0.3528	0.5292	0.7056	1.0584	2.1168	4.2336	8.4672	16.9344
32	Reserved	0.4704	0.7056	0.9408	1.4112	2.8224	5.6448	11.2896	22.5792
48	0.3528	0.7056	1.0584	1.4112	2.1168	4.2336	8.4672	16.9344	Reserved
64	0.4704	0.9408	1.4112	1.8816	2.8224	5.6448	11.2896	22.5792	Reserved
96	0.7056	1.4112	2.1168	2.8224	4.2336	8.4672	16.9344	Reserved	Reserved
128	0.9408	1.8816	2.8224	3.7632	5.6448	11.2896	22.5792	Reserved	Reserved
192	1.4112	2.8224	4.2336	5.6448	8.4672	16.9344	Reserved	Reserved	Reserved
256	1.8816	3.7632	5.6448	7.5264	11.2896	22.5792	Reserved	Reserved	Reserved
384	2.8224	5.6448	8.4672	11.2896	16.9344	Reserved	Reserved	Reserved	Reserved
512	3.7632	7.5264	11.2896	15.0528	22.5792	Reserved	Reserved	Reserved	Reserved
1024	7.5264	15.0528	22.5792	Reserved	Reserved	Reserved	Reserved	Reserved	Reserved

**Table 6-8. Supported FSYNC (Multiples or Submultiples of 44.1kHz) and BCLK Frequencies (continued)**

BCLK TO FSYNC RATIO	BCLK (MHz)								
	FSYNC (7.35 kHz)	FSYNC (14.7 kHz)	FSYNC (22.05 kHz)	FSYNC (29.4 kHz)	FSYNC (44.1 kHz)	FSYNC (88.2 kHz)	FSYNC (176.4 kHz)	FSYNC (352.8 kHz)	FSYNC (705.6 kHz)
2048	15.0528	Reserved	Reserved	Reserved	Reserved	Reserved	Reserved	Reserved	Reserved

The TAA5412-Q1 also supports non-Audio sample rates beyond those listed in prior tables. Refer to [Clocking Configuration of Device and Flexible Clocking For TAx5x1x Family application report](#) for more details.

The TAA5412-Q1 sample rate can be configured using registers CLK\_CFG0 (P0\_R50) and CLK\_CFG1 (P0\_R51) for primary and secondary ASI respectively. CLK\_DET\_STS0 (P0\_R62) and CLK\_DET\_STS1 (P0\_R63) registers also capture the device auto detect result for the FSYNC frequency in auto detection mode for the primary and secondary ASI respectively. The registers CLK\_DET\_STS2 (P0\_R64) and CLK\_DET\_STS3 (P0\_R65) capture the BCLK to FSYNC ratio detected by the device in the auto detection mode for the selected ASI which is chosen to be the PLL reference through the CLK\_SRC\_SEL (P0\_R52\_D[3:1]) registers. If the device finds any unsupported combinations of FSYNC frequency and BCLK to FSYNC ratios, the device generates an ASI clock-error interrupt and shuts down various blocks of the device accordingly.

The TAA5412-Q1 also supports enabling channels while some ADC channels are already in operation. This requires a pre-configuration before power to describe maximum number of channels which can be enabled while in operation to ensure proper clock generation and use. This can be configured by using register DYN\_PUPD\_CFG (P0\_R119). ADC\_DYN\_PUPD\_EN (P0\_R119\_D[7]) bit can be used to enable ADC channels dynamic power up. Number of maximum channels supported for dynamic power-up and power-down can be configured using ADC\_DYN\_MAXCH\_SEL (P0\_R119\_D[6]) bit.

The device uses an integrated, low-jitter, phase-locked loop (PLL) to generate internal clocks required for the modulators and digital filter engine, as well as other control blocks. The device also supports an option to use BCLK, GPIO1, or the GPIOx pin (as CCLK) as the audio clock source without using the PLL to reduce power consumption. However, the ADC performance may degrade based on jitter from the external clock source, and some processing features may not be supported if the external audio clock source frequency is not high enough. Therefore, TI recommends using the PLL for high-performance applications. The various options for the PLL reference can be set through the CLK\_SRC\_SEL (P0\_R52\_D[3:1]) registers. More details and information on how to configure and use the device in low-power mode without using the PLL are discussed in the [TAA5412-Q1 Power Consumption Matrix Across Various Usage Scenarios application report](#).

The device also supports an audio bus controller mode operation using the GPIOx or GPIOx pin (as CCLK) as the reference input clock source and supports various flexible options and a wide variety of system clocks. More details and information on controller mode configuration and operation are discussed in the [Clocking Configuration of Device and Flexible Clocking For TAx5x1x Family application report](#).

The audio bus clock error detection and auto-detect feature automatically generates all internal clocks, but can be disabled using the IGNORE\_CLK\_ERR (P0\_R4\_D[6]) and CUSTOM\_CLK\_CFG (P0\_R50\_D[0]) register bits, respectively. In the system, this disable feature can be used to support custom clock frequencies that are not covered by the auto detect scheme. For such application use cases, care must be taken to ensure that the multiple clock dividers are all configured appropriately. TI recommends using the PPC3 GUI for device configuration settings; for more details see the [TAx5x1x-Q1EVM-PDK Evaluation module user's guide](#) and the [PurePath™ console graphical development suite](#). The [Clocking Configuration of Device and Flexible Clocking For TAx5x1x Family application report](#) also covers various aspects of the custom clock configurations. Refer [Clock Error Configuration, Detection, and Modes Supported in TAx5x1x Family application report](#) for more details about the clock detection module of the device.

When the PLL is turned off, the digital volume control and other features using programmable coefficients like biquads, mixer, AGC etc., except the high pass filter (HPF) are not applicable.

### 6.3.3 Input Channel Configuration

The TAA5412-Q1 consists of two pairs of analog input pins (INxP and INxM) that can be configured as either differential or single-ended inputs for the recording channel. The device supports simultaneous recording of up



to two analog channels using the multichannel ADC. The input source for the analog pins can be either analog microphones or line, aux inputs from the system board. [Table 6-9](#) describes how to set the input configuration for the record channel.

**Table 6-9. Input Source Selection for the Record Channel**

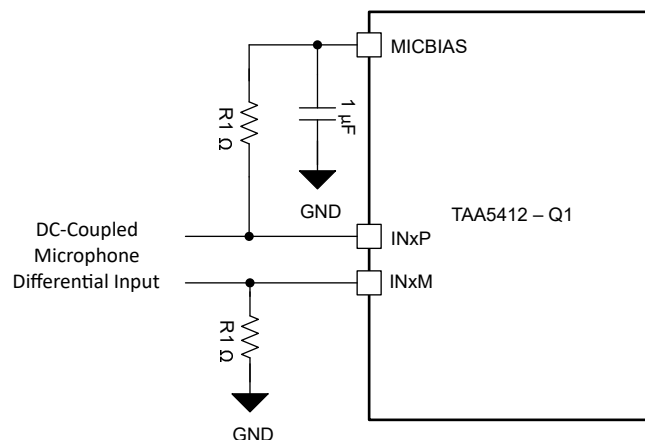
P0_R80_D[7:6] : ADC_CH1_INSRC[1:0]	INPUT CHANNEL 1 RECORD SOURCE SELECTION
00 (default)	Analog differential input for channel 1
01	Analog single-ended input for channel 1
10 or 11	Reserved (do not use this setting)

Similarly, the input source selection setting for input channel 2 can be configured using the ADC\_CH2\_INSRC[1:0] (P0\_R85\_D[7:6]) register bits. The device has an integrated mux to swap the recording channels using the ADC\_CH\_SWAP (P0\_R119\_D[1]) register

The device supports the input DC fault diagnostic feature for microphone recording with the DC-coupled inputs configuration; however, the device also supports an option for AC-coupled inputs if the DC diagnostic is not required for the specific input pins. For mono AC Coupled input, the ADC channel-2 pins IN2P and IN2M can be used as DIN1P and DIN1M for diagnostics.

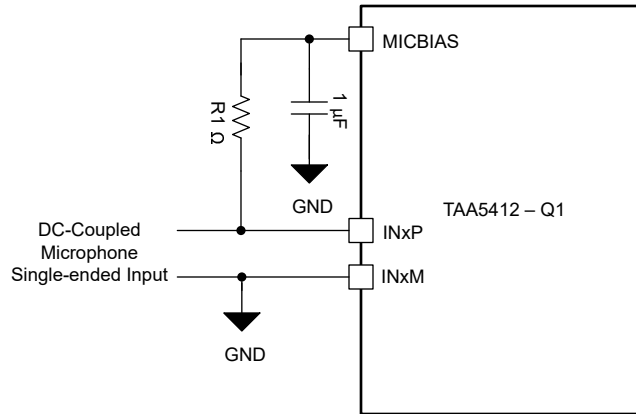
For the DC-coupled line input configuration, the DC common-mode difference ( $INxP - INxM$ ) for the analog input pins must be 0V to support the  $10V_{RMS}$  full-scale differential input. The DC differential common-mode voltage is later filtered out by the digital high-pass filter and the digital output full-scale corresponds to the  $10V_{RMS}$  AC signal in this case.

[Figure 6-14](#) and [Figure 6-15](#) show how to connect a DC-coupled microphone for a differential and single-ended input, respectively. The value of the external bias resistor, R1, must be appropriately chosen based upon the microphone impedance. For a differential input, the value of the external bias resistor is recommended to be used for half of the microphone impedance, whereas for a single-ended input, the external bias resistor is recommended to be the same as the microphone impedance.



**Figure 6-14. DC-Coupled Microphone Differential Input Connection**

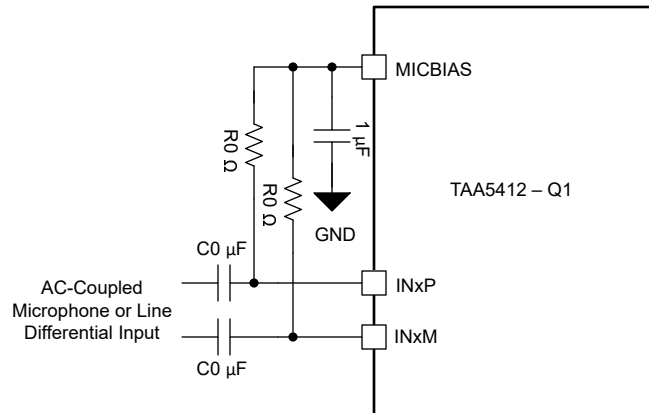




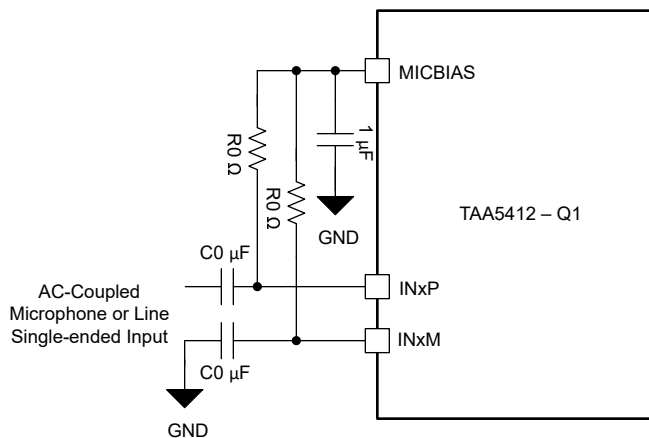
**Figure 6-15. DC-Coupled Microphone Single-Ended Input Connection**

In AC-coupled mode, the value of the coupling capacitor must be so chosen that the high-pass filter formed by the coupling capacitor and the input impedance do not affect the signal content. At power-up, before proper recording can begin, this coupling capacitor must be charged up to the common-mode voltage. For single-ended input configuration, the INxM pin must be grounded after the AC coupling capacitor in AC-coupled mode.

Figure 6-16 and Figure 6-17 show how to connect an AC-coupled microphone or line source for a differential and single-ended input, respectively. In AC-coupled mode, the device input pins INxP and INxM, must be biased appropriately for the DC common-mode value either using the on-chip MICBIAS output voltage along with external bias resistor, R0, or using an external bias generator circuit. The maximum value for resistor R0 depends upon the signal swing and the MICBIAS value programmed. See the [TAC5xxx-Q1 AC Coupled External Resistor Calculator](#) to calculate the R0 value for the desired system configuration.



**Figure 6-16. AC-Coupled Microphone or Line Differential Input Connection**



**Figure 6-17. AC-Coupled Microphone or Line Single-Ended Input Connection**

If the application uses digital PDM microphones for the recording, GPIO1, GPIxA and GPO1A pins can be reconfigured in the device to support up to four channels for the digital microphone recording (when the analog channels are not used). The device can also support simultaneous recording on one analog and three digital channels. The device supports up to one analog and up to four digital microphone channels and can support the simultaneous recording on four channels at a given time. These combinations can be enabled using the INTF4\_CFG (B0\_P0\_R19) register. More details on enabling the PDM channels are present in [Section 6.3.6](#).

### 6.3.4 Reference Voltage

All audio data converters require a DC reference voltage. The TAA5412-Q1 achieves its low-noise performance by internally generating a low-noise reference voltage. This reference voltage is generated using a band-gap circuit with good PSRR performance. This audio converter reference voltage must be filtered externally using a minimum 1µF capacitor connected from the VREF pin to the analog ground (VSS).

To achieve low power consumption, this audio reference block is powered down in sleep mode or software shutdown; see the [Section 6.4](#) for more details. When exiting sleep mode, the audio reference block should be powered up by setting SLEEP\_EXIT\_VREF\_EN (P0\_R2\_D[3]) to 1'b1. Internal fast-charge scheme helps

the VREF pin to settle to its steady-state voltage faster (a function of the decoupling capacitor on the VREF pin). This time is approximately equal to 3.5ms when using a 1µF decoupling capacitor. If a higher value of the decoupling capacitor is used on the VREF pin, the fast-charge setting must be reconfigured using the VREF\_QCHG, P0\_R2\_D[5:4] register bits, which support options of 3.5ms (default), 10ms, 50ms, or 100ms.

### 6.3.5 Microphone Bias

The device integrates a built-in, low-noise, programmable, high-voltage, microphone bias pin (MICBIAS) that can be used in the system for biasing the analog microphone. The integrated bias amplifier supports up to 30mA of load current, which can be used for multiple microphones and is designed to provide a combination of high PSRR, low noise, and programmable bias voltages to allow the biasing to be fine tuned for specific microphone combinations. The TAA5412-Q1 has an integrated efficient boost converter to generate the high voltage supply for the programmable microphone bias using an external, low-voltage, 3.3V BSTVDD supply.

When using the MICBIAS pin for biasing multiple microphones, TI recommends avoiding common impedance on the board layout for the MICBIAS connection to minimize coupling across microphones. [Table 6-10](#) shows the available microphone bias programmable options.

**Table 6-10. MICBIAS Programmable Settings**

P1_R115_D[7:4] : MBIAS_VAL[3:0]	MICBIAS OUTPUT VOLTAGE
0000	Bypass to BSTOUT
0001	Set to 3.0 V
0010	Set to 3.5 V
0011-1000	Set to 4.0 V- 6.5 V
1001	Set to 7.0 V
1010	Set to 7.5 V(default)
1011	Set to 8.0 V
1100	Set to 8.5 V
1101	Set to 9.0 V
1110	Set to 9.5 V
1111	Set to 10.0 V

The microphone bias output can be powered on or powered off (default) by configuring the MICBIAS\_PDZ, P0\_R120\_D[5] register bit. Additionally, the device provides an option to configure the GPIO1 or GPIxA pins to directly control the microphone bias output power on or power off. This feature is useful in some systems to control the microphone directly without engaging the host for I<sup>2</sup>C or SPI communication. The MICBIAS\_PDZ, P0\_R120\_D[5] register bit value is ignored if the GPIO1 or GPIxA pins are configured to control the microphone bias power on or power off.

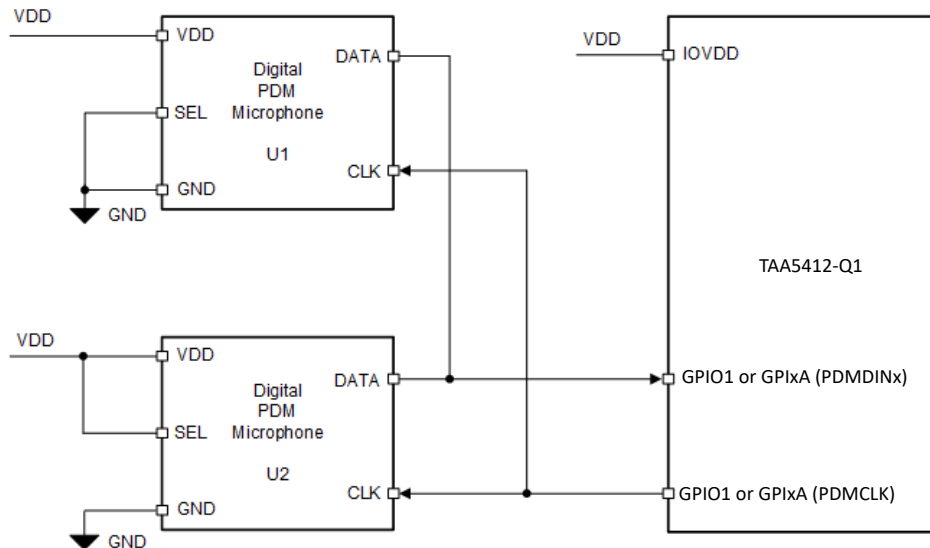
### 6.3.6 Digital PDM Microphone Record Channel

In addition to supporting analog microphones, the TAA5412-Q1 also interfaces to digital pulse-density-modulation (PDM) microphones and uses high-order and high-performance decimation filters to generate pulse code modulation (PCM) output data that can be transmitted on the audio serial interface to the host. The device supports up to four digital microphone recording channels (when the analog channels are not used). The device can also support simultaneous recording on one analog and three digital microphone channels.

The GPIO1, GPIxA and GPO1A pins can be configured for the PDM data lines (PDMDINx) and PDM Clock (PDMCLK) functions as per the [Section 6.3.8](#) for the digital PDM microphone recording.

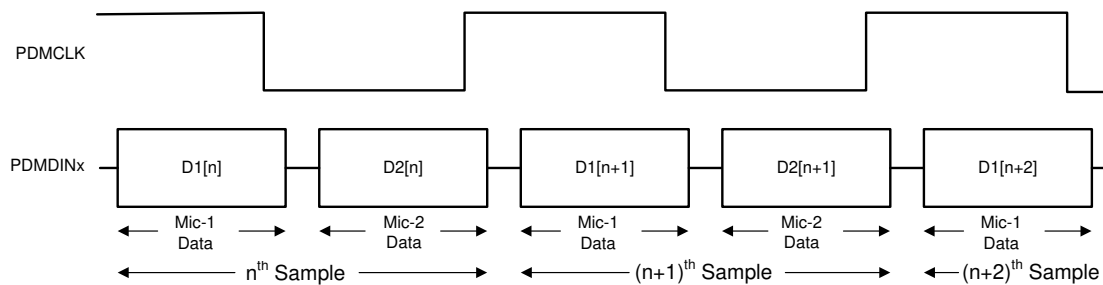
The device internally generates PDMCLK with a programmable frequency of either 6.144MHz, 3.072MHz, 1.536MHz, or 768kHz (for output data sample rates in multiples or submultiples of 48kHz) or 5.6448MHz, 2.8224MHz, 1.4112MHz, or 705.6kHz (for output data sample rates in multiples or submultiples of 44.1kHz) using the PDM\_CLK\_CFG[1:0] (P0\_R53\_D[7:6]) register bits. PDMCLK can be routed on the GPIO1 and GPO1A pins using the respective configuration registers: GPIO1\_CFG (P0\_R10[7:4]) and GPO1A\_CFG

(P0\_R12[7:4]). This clock can be connected to the external digital microphone device. Figure 6-18 shows a connection diagram of the digital PDM microphones.



**Figure 6-18. Digital PDM Microphones Connection Diagram for the TAA5412-Q1**

The single-bit output of the external digital microphone device can be connected to the GPIO1 or GPIOA pin. The device supports two PDM data lines: PDM DIN1 and PDM DIN2 set through the registers PDM DIN1\_SEL (P0\_R19\_D[3:2]) and PDM DIN2\_SEL (P0\_R19\_D[1:0]). When using GPIOA, make sure that the GPI function is enabled using the GPI\_CFG (P0\_R13[1]). This single data line can be shared by two digital microphones to place their data on the opposite edge of PDMCLK. Internally, the device latches the steady value of the data on either the rising or falling edge of PDMCLK based on the configuration register bits set in PDM DIN1\_EDGE (P0\_R19\_D[4]) and PDM DIN2\_EDGE (P0\_R19\_D[5]). Figure 6-19 shows the digital PDM microphone interface timing diagram.



**Figure 6-19. Digital PDM Microphone Protocol Timing Diagram**

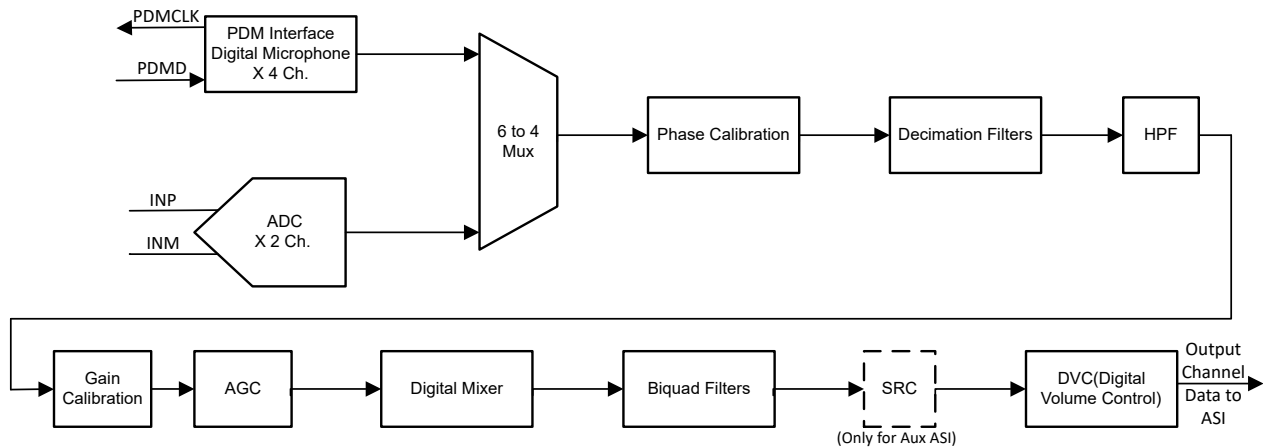
When the digital microphone is used for recording, the analog blocks of the respective ADC channel are powered down and bypassed for power efficiency. Channel 3 and channel 4 support only the digital microphone interface. Use the PDM\_CH1\_SEL[1:0] (P0\_R19\_D[7]) and PDM\_CH2\_SEL[1:0] (P0\_R19\_D[6]) register bits to select the analog microphone or digital microphone for channel 1 to channel 2 respectively.

### **6.3.7 Signal-Chain Processing**

The TAA5412-Q1 signal chain is comprised of very-low-noise, high-performance, and low-power analog blocks and highly flexible and programmable digital processing blocks. The high performance and flexibility combined with a compact package makes the TAA5412-Q1 optimized for a variety of end-equipments and applications that require multichannel audio capture. [Section 6.3.7.1](#) describe key components in ADC signal chain further.

### 6.3.7.1 ADC Signal-Chain

Figure 6-20 shows the key components of the record path signal chain.



**Figure 6-20. ADC Signal-Chain Processing Flowchart**

The front-end ADC is very low noise, with a 112dB dynamic range performance. This low-noise and low-distortion, multibit, delta-sigma ADC enables the TAA5412-Q1 to record a far-field audio signal with very high fidelity, both in quiet and loud environments. Moreover, the ADC architecture has inherent antialias filtering with a high rejection of out-of-band frequency noise around multiple modulator frequency components. Therefore, the device prevents noise from aliasing into the audio band during ADC sampling. Further on in the signal chain, an integrated, high-performance multistage digital decimation filter sharply cuts off any out-of-band frequency noise with high stop-band attenuation.

The device also has an integrated programmable biquad filter that allows for custom low-pass, high-pass, or any other desired frequency shaping. Thus, the overall signal chain architecture removes the requirement to add external components for antialiasing low-pass filtering and thus saves drastically on the external system component cost and board space. See the [TAC5212 Integrated Analog Antialiasing Filter and Flexible Digital Filter application report](#) for further details.

The signal chain also consists of various highly programmable digital processing blocks such as phase calibration, gain calibration, high-pass filter, digital summer or mixer, biquad filters, synchronous sample rate converter, and volume control. The details of these processing blocks are discussed further in this section. The device also supports up to four digital PDM microphone recording channels when the analog recording channels are not used.

The desired input channels for recording can be enabled or disabled by using the CH\_EN (P0\_R118) register, and the output channels for the audio serial interface can be enabled or disabled by using the ASI\_TX\_CHx\_CFG registers. In general, the device supports simultaneous power-up and power-down of all active channels for simultaneous recording. However, based on the application's needs, if some channels must be powered up or powered down dynamically when the other channel recording is on, then that use case is supported by setting the DYN\_PUPD\_CFG (P0\_R119) register.

The device supports an input signal bandwidth up to 90kHz, which allows the high-frequency non-audio signal to be recorded by using a 216kHz (or higher) sample rate. Wide bandwidth mode can be enabled or disabled by setting ADC\_CHx\_BW\_MODE bit (P0\_R80\_D[0] and P0\_R85\_D[0]).

For sample rates of 48kHz or lower, the device supports all features and various programmable processing blocks. However, for sample rates higher than 48kHz, there are limitations in the number of simultaneous channel recordings supported and the number of biquad filters and such. See the [TAC5212 Sampling Rates and Programmable Processing Blocks Supported application report](#) for further details.

### 6.3.7.1.1 6 to 4 Input Select Multiplexer (6:4 MUX)

The device supports up to two analog and up to four digital microphone channels and can support the simultaneous recording on four channels at a given time. The TAA5412-Q1 ADC input signal chain consists of a 6:4 Multiplexer to enable the these combinations:

1. All 4 digital PDM channels.
2. 2 digital PDM channels and 2 analog channels
3. 3 digital PDM channels and 1 analog channel.

These combinations can be enabled using the INTF4\_CFG (B0\_P0\_R19) register. More details on enabling the PDM channels are present in [Section 6.3.6](#).

### 6.3.7.1.2 Programmable Channel Gain and Digital Volume Control

The device has an independent programmable channel gain setting for each input channel that can be set to the appropriate value based on the maximum input signal expected in the system and the ADC VREF setting used (see the [Section 6.3.4](#) section), which determines the ADC full-scale signal level.

The channel gain can be set using the programmable digital volume control with a range from –80dB to 47dB in steps of 0.5dB with the option to mute the channel recording. The digital volume control value can be changed dynamically while the ADC channel is powered-up and recording. During volume control changes, the soft ramp-up or ramp-down volume feature is used internally to avoid any audible artifacts. Soft-stepping can be entirely disabled using the ADC\_DSP\_DISABLE\_SOFT\_STEP (P0\_R114\_D[1]) register bit.

The digital volume control setting is independently available for each output channel, including the digital microphone record channel. However, the device also supports an option to gang-up the volume control setting for all channels together using the channel 1 digital volume control setting, regardless if channel 1 is powered up or powered down. This gang-up can be enabled using the ADC\_DSP\_DVOL\_GANG (P0\_R114\_D[0]) register bit.

[Table 6-11](#) shows the programmable options available for the digital volume control.

**Table 6-11. Digital Volume Control (DVC) Programmable Settings**

P0_R82_D[7:0] : ADC_CH1_DVOL[7:0]	DVC SETTING FOR OUTPUT CHANNEL 1
0000 0000 = 0d	Output channel 1 DVC is set to mute
0000 0001 = 1d	Output channel 1 DVC is set to –80 dB
0000 0010 = 2d	Output channel 1 DVC is set to –79.5 dB
0000 0011 = 3d	Output channel 1 DVC is set to –79 dB
...	...
1010 0000 = 160d	Output channel 1 DVC is set to –0.5 dB
1010 0001 = 161d (default)	Output channel 1 DVC is set to 0 dB
1010 0010 = 162d	Output channel 1 DVC is set to 0.5 dB
...	...
1111 1101 = 253d	Output channel 1 DVC is set to 46 dB
1111 1110 = 254d	Output channel 1 DVC is set to 46.5 dB
1111 1111 = 255d	Output channel 1 DVC is set to 47 dB

Similarly, the digital volume control setting for output channel 2 to channel 4 can be configured using the CH2\_DVOL (P0\_R87) to CH4\_DVOL (P0\_R95) register bits, respectively.

The internal digital processing engine soft ramps up the volume from a muted level to the programmed volume level when the channel is powered up, and the internal digital processing engine soft ramps down the volume from a programmed volume to mute when the channel is powered down. This soft-stepping of volume is done to prevent abruptly powering up and powering down the record channel. This feature can also be entirely disabled using the ADC\_DSP\_DISABLE\_SOFT\_STEP (P0\_R114\_D[1]) register bit.

The Digital Volume (DVOL) control offers user the control over the gain without need for a Programmable Gain Amplifier (PGA). In TAA5412-Q1, the PGA opamp is integrated into the ADC front-end offering very high performance equivalent to other low noise PGA based audio signal chains at a fraction of the power of traditional PGA based devices. For more details refer [Microphone Interface with TAX5XXX Devices](#).

The programmable channel digital volume control feature is not applicable if the PLL is turned off. For setting channel attenuation, user can configure this by using the programmable high pass filter coefficients as described in [Section 6.3.7.1.5](#).

#### 6.3.7.1.3 Programmable Channel Gain Calibration

Along with the digital volume control, this device also provides programmable channel gain calibration. The gain of each channel can be finely calibrated or adjusted in steps of 0.1dB for a range of  $-0.8\text{dB}$  to  $0.7\text{dB}$  gain error. This adjustment is useful when trying to match the gain across channels resulting from external components and microphone sensitivity. This feature, in combination with the regular digital volume control, allows the gains across all channels to be matched for a wide gain error range with a resolution of 0.1dB. [Table 6-12](#) shows the programmable options available for the channel gain calibration.

**Table 6-12. Channel Gain Calibration Programmable Settings**

P0_R83_D[7:4] : ADC_CH1_FGAIN[3:0]	CHANNEL GAIN CALIBRATION SETTING FOR INPUT CHANNEL 1
0000 = 0d	Input channel 1 gain calibration is set to $-0.8\text{dB}$
0001 = 1d	Input channel 1 gain calibration is set to $-0.7\text{dB}$
...	...
1000 = 8d (default)	Input channel 1 gain calibration is set to $0\text{dB}$
...	...
1110 = 14d	Input channel 1 gain calibration is set to $0.6\text{dB}$
1111 = 15d	Input channel 1 gain calibration is set to $0.7\text{dB}$

Similarly, the channel gain calibration setting for input channel 2 to channel 4 can be configured using the ADC\_CH2\_CFG3 (P0\_R88) to ADC\_CH4\_CFG3 (P0\_R96) register bits, respectively.

#### 6.3.7.1.4 Programmable Channel Phase Calibration

In addition to the gain calibration, the phase delay in each record channel can be finely calibrated or adjusted in steps of one modulator clock cycle for a cycle range of 1 to 63 for the phase error. The modulator clock for analog and digital microphones is set independently. For analog microphones, it is the clock used for ADC MOD CLK, and is 3.072MHz (the output data sample rate is multiples or submultiples of 48kHz) or 2.8224MHz (the output data sample rate is multiples or submultiples of 44.1 kHz) in default configurations. For power savings, the ADC modulator clock can also be reduced to 1.536MHz (the output data sample rate is multiples or submultiples of 48kHz) or 1.4112MHz (the output data sample rate is multiples or submultiples of 44.1 kHz) by using ADC\_CLK\_BY2\_MODE (B0\_P78\_D[7]) register bit. For the digital microphone use case, it is the clock used for PDM\_CLK, and is also 3.072MHz (the output data sample rate is multiples or submultiples of 48kHz) or 2.8224MHz (the output data sample rate is multiples or submultiples of 44.1 kHz) in default configurations. User can configure the PDM\_CLK using the PDM\_CLK\_CFG[1:0] (P0\_R53\_D[7:6]) register bits. The programmable channel phase calibration feature is very useful for many applications that must match the phase with fine resolution between each channel, including any phase mismatch across channels resulting from external components or microphones. [Table 6-13](#) shows the available programmable options for channel phase calibration.

**Table 6-13. Channel Phase Calibration Programmable Settings**

P0_R84_D[7:2] : ADC_CH1_PCAL[5:0]	CHANNEL PHASE CALIBRATION SETTING FOR INPUT CHANNEL 1
00 0000 = 0d (default)	No phase calibration
00 0001 = 1d	Input channel 1 phase calibration delay is set to one cycle of the modulator clock
...	...
11 1111 = 63d	Input channel 1 phase calibration delay is set to 63 cycles of the modulator clock



Similarly, the channel phase calibration setting for input channel 2 to channel 4 can be configured using the ADC\_CH2\_PCAL (P0\_R89\_D[7:2]) to ADC\_CH4\_PCAL (P0\_R97\_D[7:2]) register bits, respectively.

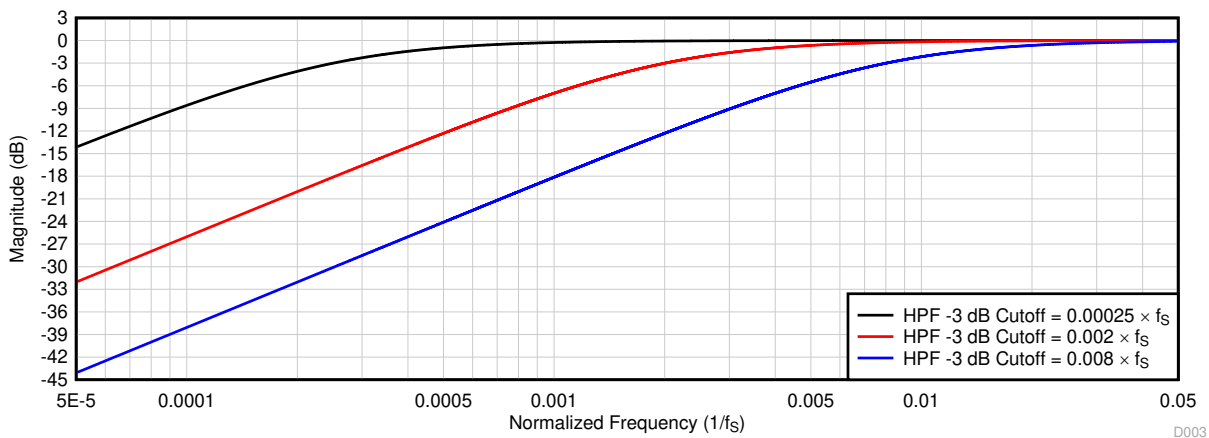
By default, the phase calibration is enabled for both analog and digital microphone channels. This can be changed to only analog or only digital microphones through the PCAL\_ANA\_DIG\_SEL (P0\_R84\_D[1:0]) register bits. When using analog input and PDM input together for simultaneous conversion, there is a limit on the available phase calibration options for the analog channels when analog and PDM clocks are different. When using ADC MOD CLK = 1.536MHz or 1.4112MHz and PDM\_CLK = 6.144MHz or 5.6448MHz, phase calibration delays of only 1 to 16 are supported for the analog channels. When using ADC MOD CLK = 3.072MHz or 2.8224 and PDM\_CLK = 6.144MHz or 5.6448MHz, phase calibration delays of only 1 to 32 are supported for the analog channels. When using ADC MOD CLK = 1.536MHz or 1.4112MHz and PDM\_CLK = 3.072MHz or 2.8224MHz also, phase calibration delays of only 1 to 32 are supported for the analog channels.

**6.3.7.1.5 Programmable Digital High-Pass Filter**

To remove the DC offset component and attenuate the undesired low-frequency noise content in the record data, the device supports a programmable high-pass filter (HPF). The HPF is not a channel-independent filter setting but is globally applicable for all ADC channels. This HPF is constructed using the first-order infinite impulse response (IIR) filter, and is efficient enough to filter out possible DC components of the signal. Table 6-14 shows the predefined -3dB cutoff frequencies available that can be set by using the ADC\_DSP\_HPFF\_SEL[1:0] register bits of P0\_R114\_D[5:4]. Additionally, to achieve a custom -3dB cutoff frequency for a specific application, the device also allows the first-order IIR filter coefficients to be programmed when the ADC\_DSP\_HPFF\_SEL[1:0] register bits are set to 2'b00. Figure 6-21 illustrates a frequency response plot for the HPF filter.

**Table 6-14. HPF Programmable Settings**

P0_R114_D[5:4] : ADC_DSP_HPFF_SEL L[1:0]	-3dB CUTOFF FREQUENCY SETTING	-3dB CUTOFF FREQUENCY AT 16kHz SAMPLE RATE	-3dB CUTOFF FREQUENCY AT 48kHz SAMPLE RATE
00	Programmable 1st-order IIR filter	Programmable 1st-order IIR filter	Programmable 1st-order IIR filter
01 (default)	$0.00002 \times f_s$	0.25Hz	1Hz
10	$0.00025 \times f_s$	4Hz	12Hz
11	$0.002 \times f_s$	32Hz	96Hz



**Figure 6-21. HPF Filter Frequency Response Plot**

Equation 1 gives the transfer function for the first-order programmable IIR filter:

$$H(z) = \frac{N_0 + N_1 z^{-1}}{2^{31} - D_1 z^{-1}} \quad (1)$$

The frequency response for this first-order programmable IIR filter with default coefficients is flat at a gain of 0dB (all-pass filter). The host device can override the frequency response by programming the IIR coefficients in [Table 6-15](#) to achieve the desired frequency response for high-pass filtering or any other desired filtering. If the ADC\_DSP\_HP\_SEL[1:0] are set to 2'b00, the host device must write these coefficients values for the desired frequency response before powering-up any ADC channel for recording. [Table 6-15](#) shows the filter coefficients for the first-order IIR filter.

**Table 6-15. 1st-Order IIR Filter Coefficients**

FILTER	FILTER COEFFICIENT	DEFAULT COEFFICIENT VALUE	COEFFICIENT REGISTER MAPPING
Programmable 1st-order IIR filter (can be allocated to HPF or any other desired filter)	N <sub>0</sub>	0x7FFFFFFF	P10_R120-R123
	N <sub>1</sub>	0x00000000	P10_R124-R127
	D <sub>1</sub>	0x00000000	P11_R8-R11

#### 6.3.7.1.6 Programmable Digital Biquad Filters

The device supports up to 12 programmable digital biquad filters available for ADC signal chain limited to 3/channel. These highly efficient filters achieve the desired frequency response. The TAA5412-Q1 also supports on the fly programmable Biquad filters for two channel record use case. In digital signal processing, a digital biquad filter is a second-order, recursive linear filter with two poles and two zeros. [Equation 2](#) gives the transfer function of each biquad filter:

$$H(z) = \frac{N_0 + 2N_1 z^{-1} + N_2 z^{-2}}{2^{31} - 2D_1 z^{-1} - D_2 z^{-2}} \quad (2)$$

The frequency response for the biquad filter section with default coefficients is flat at a gain of 0 dB (all-pass filter). The host device can override the frequency response by programming the biquad coefficients to achieve the desired frequency response for a low-pass, high-pass, or any other desired frequency shaping. The programmable coefficients for the mixer operation are located in the B0\_P8 and B0\_P9. If biquad filtering is required, then the host device must write these coefficients values before powering up any ADC channels for recording. In two channel use case, the TAA5412-Q1 also supports on the fly programmable filters. In this case, the device uses two banks of filters for one channel with a switch bit to perform the switch from one filter bank to the other. As described in [Table 6-16](#), these biquad filters can be allocated for each output channel based on the ADC\_DSP\_BQ\_CFG[1:0] register setting of P0\_R114\_D[3:2]. By setting ADC\_DSP\_BQ\_CFG[1:0] to 2'b00, the biquad filtering for all record channels is disabled and the host device can choose this setting if no additional filtering is required for the system application. See the [TAC5x1x and TAC5x1x-Q1 Programmable Biquad Filters - Configuration and Applications application report](#) for further details.

**Table 6-16. Biquad Filter Allocation to the Record Output Channel**

PROGRAMMABLE BIQUAD FILTER	RECORD OUTPUT CHANNEL ALLOCATION USING P0_R114_D[3:2] REGISTER SETTING		
	ADC_DSP_BQ_CFG[1:0] = 2'b01 (1 Biquad per Channel)	ADC_DSP_BQ_CFG[1:0] = 2'b10 (Default) (2 Biquads per Channel)	ADC_DSP_BQ_CFG[1:0] = 2'b11 (3 Biquads per Channel)
Biquad filter 1	Allocated to output channel 1	Allocated to output channel 1	Allocated to output channel 1
Biquad filter 2	Allocated to output channel 2	Allocated to output channel 2	Allocated to output channel 2
Biquad filter 3	Allocated to output channel 3	Allocated to output channel 3	Allocated to output channel 3
Biquad filter 4	Allocated to output channel 4	Allocated to output channel 4	Allocated to output channel 4
Biquad filter 5	Not used	Allocated to output channel 1	Allocated to output channel 1
Biquad filter 6	Not used	Allocated to output channel 2	Allocated to output channel 2

**Table 6-16. Biquad Filter Allocation to the Record Output Channel (continued)**

PROGRAMMABLE BIQUAD FILTER	RECORD OUTPUT CHANNEL ALLOCATION USING P0_R114_D[3:2] REGISTER SETTING		
	ADC_DSP_BQ_CFG[1:0] = 2'b01 (1 Biquad per Channel)	ADC_DSP_BQ_CFG[1:0] = 2'b10 (Default) (2 Biquads per Channel)	ADC_DSP_BQ_CFG[1:0] = 2'b11 (3 Biquads per Channel)
Biquad filter 7	Not used	Allocated to output channel 3	Allocated to output channel 3
Biquad filter 8	Not used	Allocated to output channel 4	Allocated to output channel 4
Biquad filter 9	Not used	Not used	Allocated to output channel 1
Biquad filter 10	Not used	Not used	Allocated to output channel 2
Biquad filter 11	Not used	Not used	Allocated to output channel 3
Biquad filter 12	Not used	Not used	Allocated to output channel 4

Table 6-17 shows the biquad filter coefficients mapping to the register space.

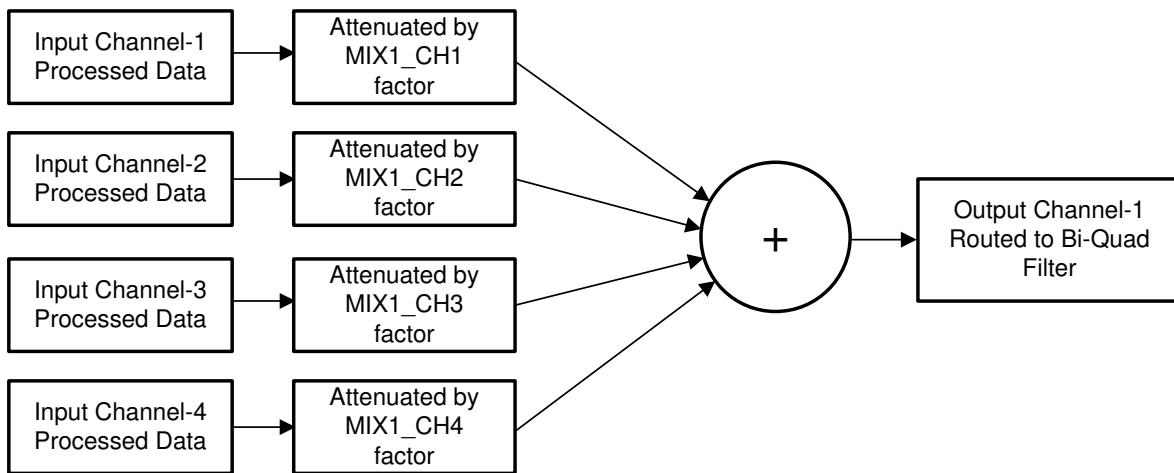
**Table 6-17. Biquad Filter Coefficients Register Mapping**

PROGRAMMABLE BIQUAD FILTER	BIQUAD FILTER COEFFICIENTS REGISTER MAPPING	PROGRAMMABLE BIQUAD FILTER	BIQUAD FILTER COEFFICIENTS REGISTER MAPPING
Biquad filter 1	P8_R8-R27	Biquad filter 7	P9_R8-R27
Biquad filter 2	P8_R28-R47	Biquad filter 8	P9_R28-R47
Biquad filter 3	P8_R48-R67	Biquad filter 9	P9_R48-R67
Biquad filter 4	P8_R68-R87	Biquad filter 10	P9_R68-R87
Biquad filter 5	P8_R88-R107	Biquad filter 11	P9_R88-R107
Biquad filter 6	P8_R108-R127	Biquad filter 12	P9_R108-R127

**6.3.7.1.7 Programmable Channel Summer and Digital Mixer**

For applications that require an even higher SNR than that supported for each channel, the device digital summing mode can be used. In this mode, the digital record data are summed up across the channel with an equal weightage factor, which helps in reducing the effective record noise.

The device supports a fully programmable mixer feature that can mix the various input channels with their custom programmable scale factor to generate the final output channels. Figure 6-22 shows a block diagram that describes the mixer 1 operation to generate output channel 1. The programmable coefficients for the mixer operation are located in B0\_P10.



**Figure 6-22. Programmable Digital Mixer Block Diagram**

A similar mixer operation is performed by mixer 2, mixer 3, and mixer 4 to generate output channel 2, channel 3, and channel 4, respectively. TI recommends using the PPC3 GUI for configuring the programmable coefficients

settings; for more details see the [TAX5x1x-Q1EVM-PDK Evaluation module user's guide](#) and the [PurePath™ console graphical development suite](#). Additional details on the configurations can be found in the [Using the TAX5x1x Programmable Digital Channel Mixer application report](#).

### 6.3.7.1.8 Configurable Digital Decimation Filters

The device record channel includes a high dynamic range and a built-in digital decimation filter to process the oversampled data from the multibit delta-sigma ( $\Delta\Sigma$ ) modulator to generate digital data at the same Nyquist sampling rate as the FSYNC rate. The decimation filter can also be used for processing the oversampled PDM stream from the digital microphone. The decimation filter can be chosen from four different types, depending on the required frequency response, group delay, power consumption, and phase linearity requirements for the target application. The selection of the decimation filter option can be done by configuring the ADC\_DSP\_DECI\_FILT, P0\_R114\_D[7:6] register bits. Low power filter can be configured by setting ADC\_LOW\_PWR\_FILT, P0\_R78\_D[2] bit. [Table 6-18](#) shows the configuration register setting for the decimation filter mode selection for the record channel.

**Table 6-18. Decimation Filter Mode Selection for the Record Channel**

P0_R78_D[2] : ADC_LOW_PWR_FILT	P0_R114_D[7:6] : ADC_DSP_DECI_FILT[1:0]	DECIMATION FILTER MODE SELECTION
0	00 (default)	Linear phase filters are used for the decimation
0	01	Low latency filters are used for the decimation
0	10	Ultra-low latency filters are used for the decimation
0	11	Reserved (do not use this setting)
1	x	Low power filters are used for the decimation

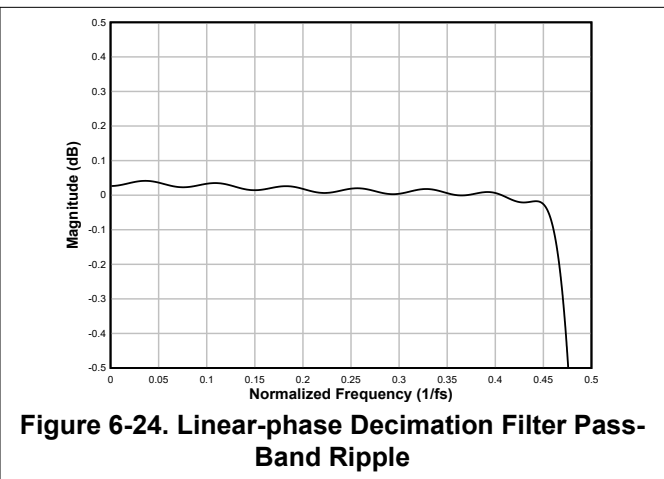
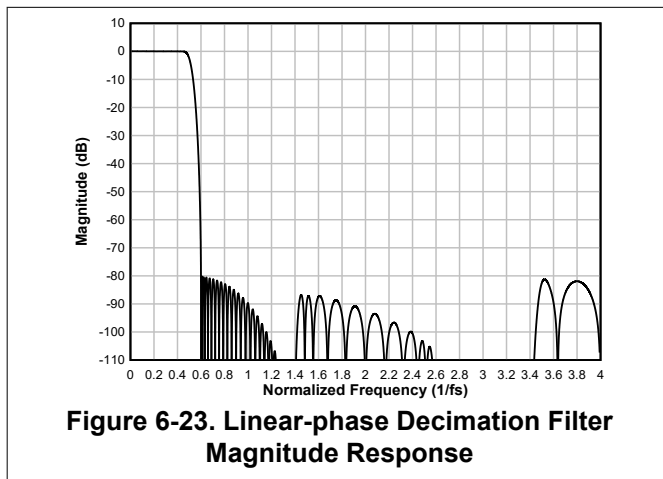
The following sections describe the filter response for the different latency options and samples rates.

#### 6.3.7.1.8.1 Linear-phase filters

The linear-phase decimation filters are the default filters set by the device and can be used for all applications that require a perfect linear phase with zero-phase deviation within the pass-band specification of the filter. The filter performance specifications and various plots for all supported output sampling rates are listed in this section.

##### 6.3.7.1.8.1.1 Sampling Rate: 8kHz or 7.35kHz

[Figure 6-23](#) and [Figure 6-24](#) respectively show the magnitude response and the pass-band ripple for this decimation filter with a sampling rate of 8kHz or 7.35kHz, and [Table 6-19](#) lists its specifications.



**Table 6-19. Linear-phase Decimation Filter Specifications**

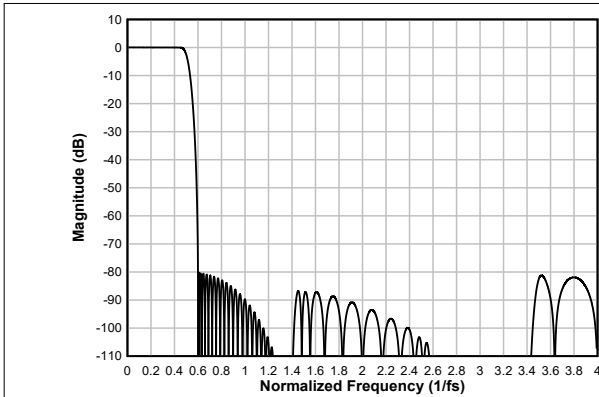
PARAMETER	TEST CONDITIONS	MIN	TYP	MAX	UNIT
Pass-band ripple	Frequency range is 0 to $0.454 \times f_S$	-0.04		0.04	dB
Stop-band attenuation	Frequency range is $0.6 \times f_S$ to $4 \times f_S$	80.2			dB
	Frequency range is $4 \times f_S$ onwards	84.7			

**Table 6-19. Linear-phase Decimation Filter Specifications (continued)**

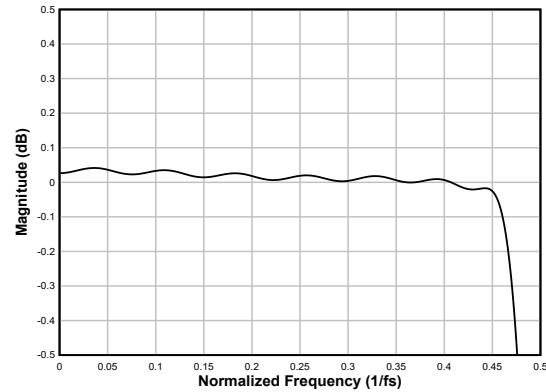
PARAMETER	TEST CONDITIONS	MIN	TYP	MAX	UNIT
Group delay or latency	Frequency range is 0 to $0.454 \times f_S$		16.1		$1/f_S$

**6.3.7.1.8.1.2 Sampling Rate: 16kHz or 14.7kHz**

Figure 6-25 and Figure 6-26 respectively show the magnitude response and the pass-band ripple for this decimation filter with a sampling rate of 16kHz or 14.7kHz, and Table 6-20 lists its specifications.



**Figure 6-25. Linear-phase Decimation Filter Magnitude Response**



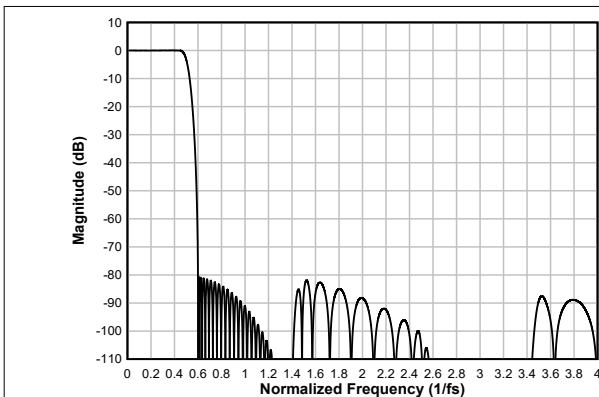
**Figure 6-26. Linear-phase Decimation Filter Pass-Band Ripple**

**Table 6-20. Linear-phase Decimation Filter Specifications**

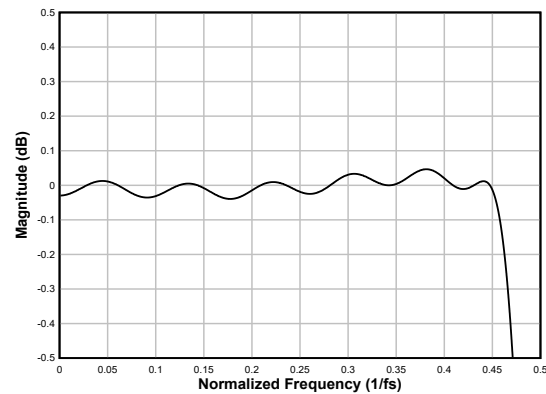
PARAMETER	TEST CONDITIONS	MIN	TYP	MAX	UNIT
Pass-band ripple	Frequency range is 0 to $0.454 \times f_S$	-0.04		0.04	dB
Stop-band attenuation	Frequency range is $0.6 \times f_S$ to $4 \times f_S$	80.2			dB
	Frequency range is $4 \times f_S$ onwards	84.7			
Group delay or latency	Frequency range is 0 to $0.454 \times f_S$		16.1		$1/f_S$

**6.3.7.1.8.1.3 Sampling Rate: 24kHz or 22.05kHz**

Figure 6-27 and Figure 6-28 respectively show the magnitude response and the pass-band ripple for this decimation filter with a sampling rate of 24kHz or 22.05kHz, and Table 6-21 lists its specifications.



**Figure 6-27. Linear-phase Decimation Filter Magnitude Response**



**Figure 6-28. Linear-phase Decimation Filter Pass-Band Ripple**

**Table 6-21. Linear-phase Decimation Filter Specifications**

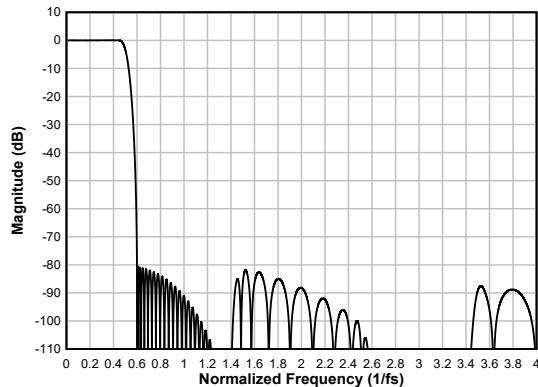
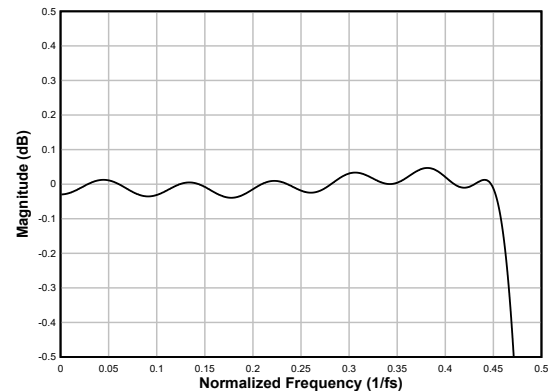
PARAMETER	TEST CONDITIONS	MIN	TYP	MAX	UNIT
Pass-band ripple	Frequency range is 0 to $0.455 \times f_S$	-0.05		0.05	dB
Stop-band attenuation	Frequency range is $0.6 \times f_S$ to $4 \times f_S$	80.6			dB
	Frequency range is $4 \times f_S$ onwards	93			

**Table 6-21. Linear-phase Decimation Filter Specifications (continued)**

PARAMETER	TEST CONDITIONS	MIN	TYP	MAX	UNIT
Group delay or latency	Frequency range is 0 to $0.455 \times f_S$		14.7		$1/f_S$

**6.3.7.1.8.1.4 Sampling Rate: 32kHz or 29.4kHz**

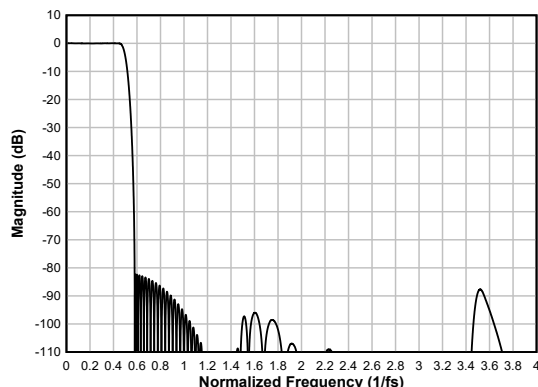
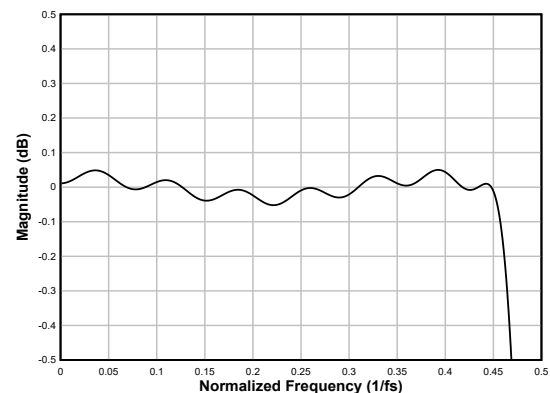
Figure 6-29 and Figure 6-30 respectively show the magnitude response and the pass-band ripple for this decimation filter with a sampling rate of 32kHz or 29.4kHz, and Table 6-22 lists its specifications.

**Figure 6-29. Linear-phase Decimation Filter Magnitude Response****Figure 6-30. Linear-phase Decimation Filter Pass-Band Ripple****Table 6-22. Linear-phase Decimation Filter Specifications**

PARAMETER	TEST CONDITIONS	MIN	TYP	MAX	UNIT
Pass-band ripple	Frequency range is 0 to $0.455 \times f_S$	-0.05		0.05	dB
Stop-band attenuation	Frequency range is $0.6 \times f_S$ to $4 \times f_S$	80.6			dB
	Frequency range is $4 \times f_S$ onwards	92.9			
Group delay or latency	Frequency range is 0 to $0.455 \times f_S$		14.7		$1/f_S$

**6.3.7.1.8.1.5 Sampling Rate: 48kHz or 44.1kHz**

Figure 6-31 and Figure 6-32 respectively show the magnitude response and the pass-band ripple for this decimation filter with a sampling rate of 48kHz or 44.1kHz, and Table 6-23 lists its specifications.

**Figure 6-31. Linear-phase Decimation Filter Magnitude Response****Figure 6-32. Linear-phase Decimation Filter Pass-Band Ripple**

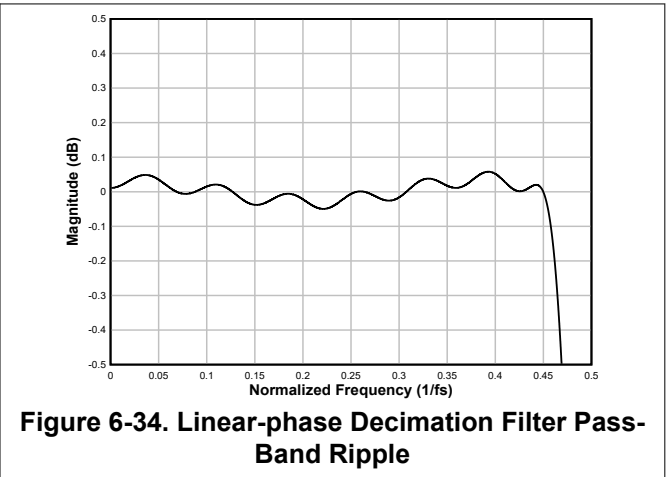
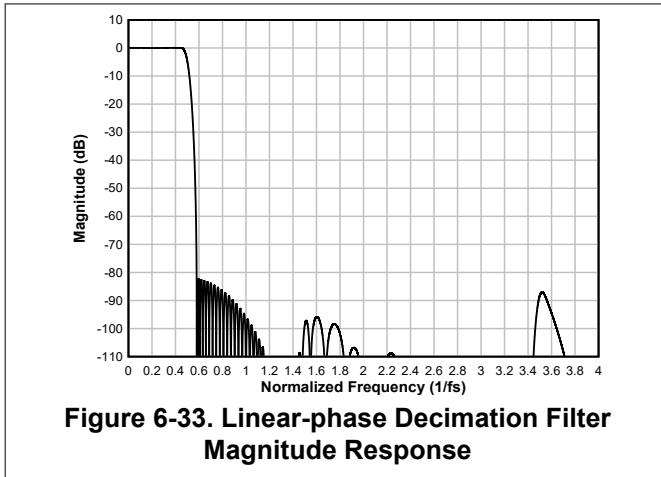


**Table 6-23. Linear-phase Decimation Filter Specifications**

PARAMETER	TEST CONDITIONS	MIN	TYP	MAX	UNIT
Pass-band ripple	Frequency range is 0 to $0.454 \times f_S$	-0.05		0.05	dB
Stop-band attenuation	Frequency range is $0.58 \times f_S$ to $4 \times f_S$	82.2			dB
	Frequency range is $4 \times f_S$ onwards	98			
Group delay or latency	Frequency range is 0 to $0.454 \times f_S$		17		$1/f_S$

**6.3.7.1.8.1.6 Sampling Rate: 96kHz or 88.2kHz**

Figure 6-33 and Figure 6-34 respectively show the magnitude response and the pass-band ripple for this decimation filter with a sampling rate of 96kHz or 88.2kHz, and Table 6-24 lists its specifications.

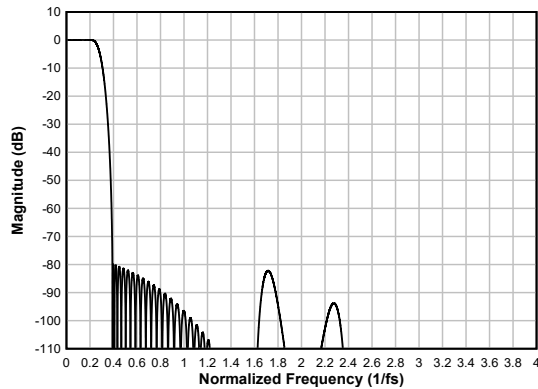


**Table 6-24. Linear-phase Decimation Filter Specifications**

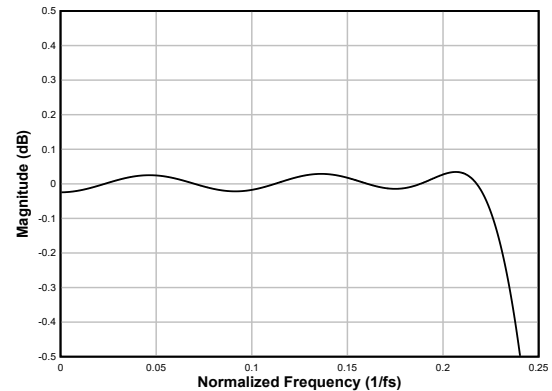
PARAMETER	TEST CONDITIONS	MIN	TYP	MAX	UNIT
Pass-band ripple	Frequency range is 0 to $0.455 \times f_S$	-0.05		0.06	dB
Stop-band attenuation	Frequency range is $0.58 \times f_S$ to $4 \times f_S$	82.2			dB
	Frequency range is $4 \times f_S$ onwards	87			
Group delay or latency	Frequency range is 0 to $0.455 \times f_S$		16.9		$1/f_S$

**6.3.7.1.8.1.7 Sampling Rate: 192kHz or 176.4kHz**

Figure 6-35 and Figure 6-36 respectively show the magnitude response and the pass-band ripple for this decimation filter with a sampling rate of 192kHz or 176.4kHz, and Table 6-25 lists its specifications.



**Figure 6-35. Linear-phase Decimation Filter Magnitude Response**



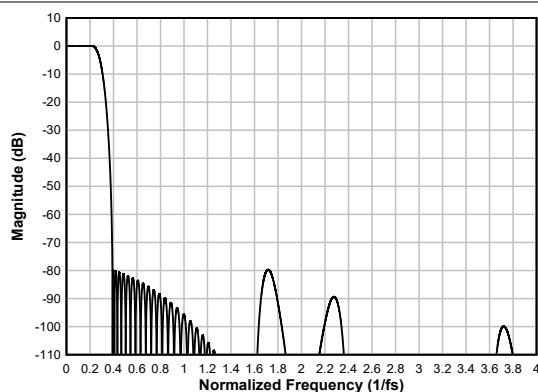
**Figure 6-36. Linear-phase Decimation Filter Pass-Band Ripple**

**Table 6-25. Linear-phase Decimation Filter Specifications**

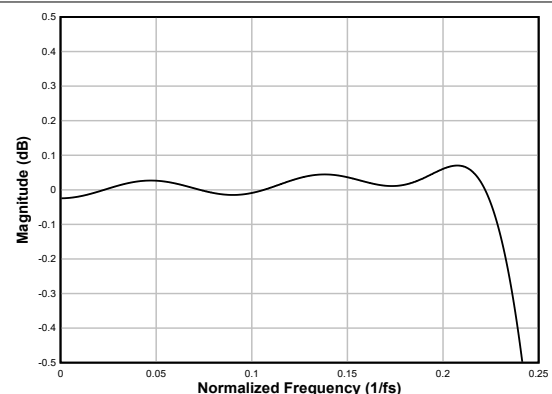
PARAMETER	TEST CONDITIONS	MIN	TYP	MAX	UNIT
Pass-band ripple	Frequency range is 0 to $0.223 \times f_S$	-0.04		0.04	dB
Stop-band attenuation	Frequency range is $0.391 \times f_S$ to $4 \times f_S$	80			dB
	Frequency range is $4 \times f_S$ onwards	82.2			
Group delay or latency	Frequency range is 0 to $0.258 \times f_S$		11.6		$1/f_S$

#### 6.3.7.1.8.1.8 Sampling Rate: 384kHz or 352.8kHz

Figure 6-37 and Figure 6-38 respectively show the magnitude response and the pass-band ripple for this decimation filter with a sampling rate of 384kHz or 352.8kHz, and Table 6-26 Linear-phase Decimation Filter Specifications lists its specifications



**Figure 6-37. Linear-phase Decimation Filter Magnitude Response**



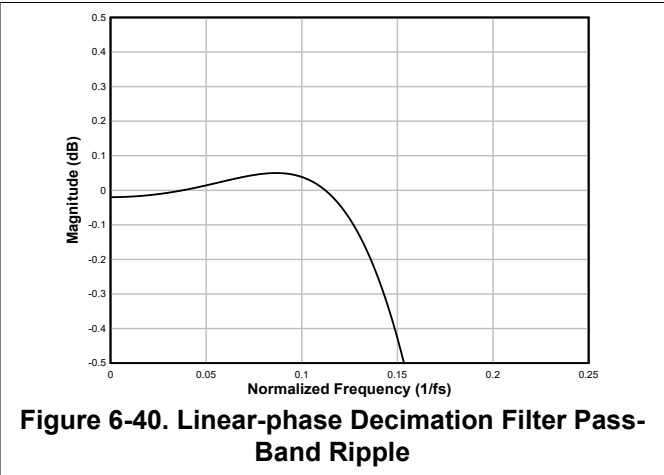
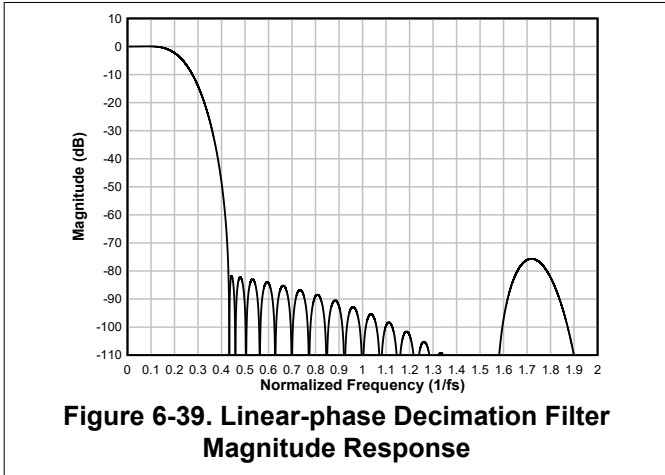
**Figure 6-38. Linear-phase Decimation Filter Pass-Band Ripple**

**Table 6-26. Linear-phase Decimation Filter Specifications**

PARAMETER	TEST CONDITIONS	MIN	TYP	MAX	UNIT
Pass-band ripple	Frequency range is 0 to $0.223 \times f_S$	-0.07		0.07	dB
Stop-band attenuation	Frequency range is $0.391 \times f_S$ to $4 \times f_S$	80			dB
	Frequency range is $4 \times f_S$ onwards	88.1			
Group delay or latency	Frequency range is 0 to $0.258 \times f_S$		11.4		$1/f_S$

**6.3.7.1.8.1.9 Sampling Rate: 768kHz or 705.6kHz**

Figure 6-39 and Figure 6-40 respectively show the magnitude response and the pass-band ripple for this decimation filter with a sampling rate of 384kHz or 352.8kHz, and Table 6-27 Linear-phase Decimation Filter Specifications lists its specifications



**Table 6-27. Linear-phase Decimation Filter Specifications**

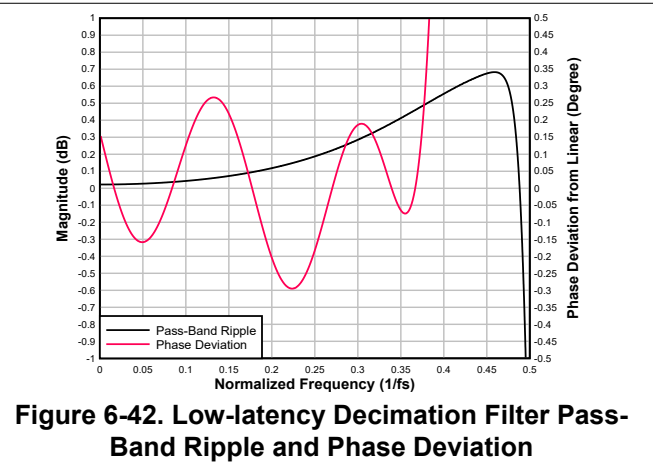
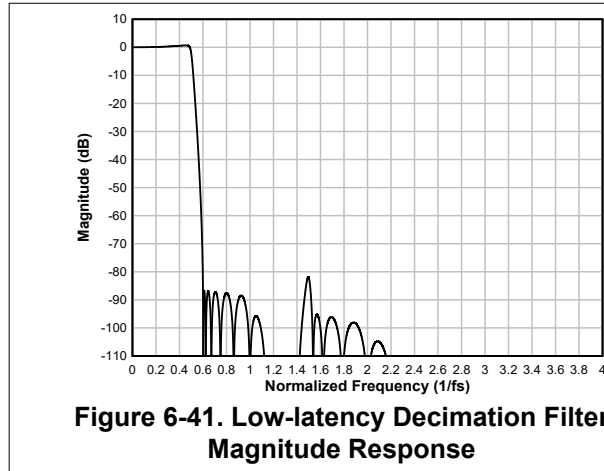
PARAMETER	TEST CONDITIONS	MIN	TYP	MAX	UNIT
Pass-band ripple	Frequency range is 0 to $0.223 \times f_S$	-0.05		0.05	dB
Stop-band attenuation	Frequency range is $0.391 \times f_S$ to $4 \times f_S$	82.6			dB
	Frequency range is $4 \times f_S$ onwards	83.6			
Group delay or latency	Frequency range is 0 to $0.258 \times f_S$		6.4		$1/f_S$

### 6.3.7.1.8.2 Low-latency Filters

For applications where low latency with minimal phase deviation (within the audio band) is critical, the low-latency decimation filters on the TAA5412-Q1 can be used. The device supports these filters with a group delay of approximately seven samples with an almost linear phase response within the  $0.376 \times f_s$  frequency band. This section provides the filter performance specifications and various plots for all supported output sampling rates for the low-latency filters.

#### 6.3.7.1.8.2.1 Sampling Rate: 24kHz or 22.05kHz

Figure 6-41 shows the magnitude response and Figure 6-42 shows the pass-band ripple and phase deviation for this decimation filter with a sampling rate of 24kHz or 22.05kHz. Table 6-28 lists its specifications.

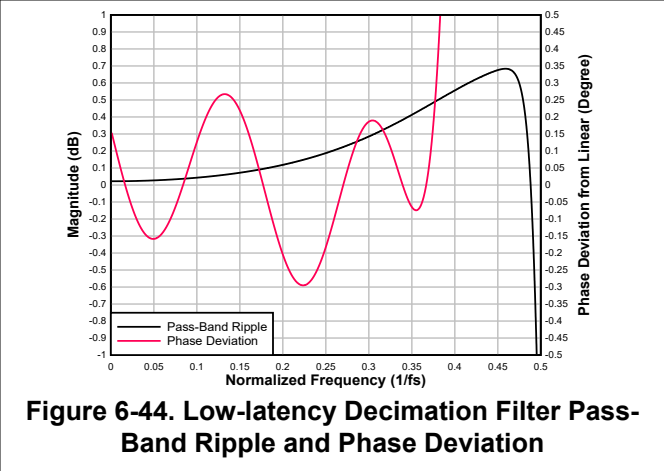
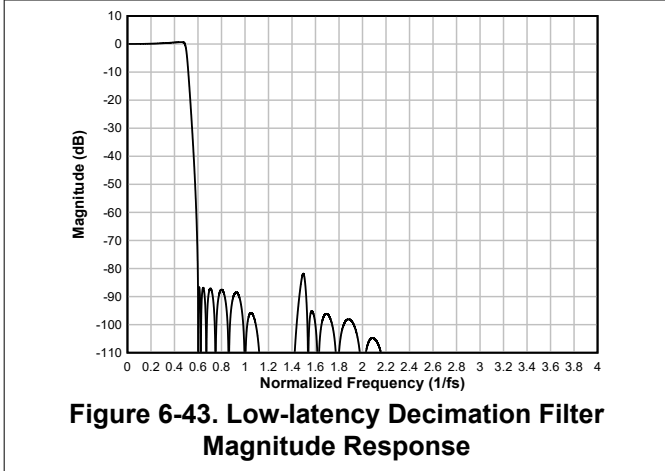


**Table 6-28. Low-latency Decimation Filter Specifications**

PARAMETER	TEST CONDITIONS	MIN	TYP	MAX	UNIT
Pass-band ripple	Frequency range is 0 to $0.492 \times f_s$	-0.67		-0.67	dB
Stop-band attenuation	Frequency range is $0.6 \times f_s$ to $4 \times f_s$	81.8			dB
	Frequency range is $4 \times f_s$ onwards	115			
Group delay or latency	Frequency range is 0 to $0.376 \times f_s$		6.5		$1/f_s$
Group delay deviation	Frequency range is 0 to $0.376 \times f_s$	-0.092		0.029	$1/f_s$
Phase deviation	Frequency range is 0 to $0.376 \times f_s$	-0.3		0.27	Degrees

#### 6.3.7.1.8.2.2 Sampling Rate: 32kHz or 29.4kHz

Figure 6-43 shows the magnitude response and Figure 6-44 shows the pass-band ripple and phase deviation for this decimation filter with a sampling rate of 32kHz or 29.4kHz. Table 6-29 lists its specifications.

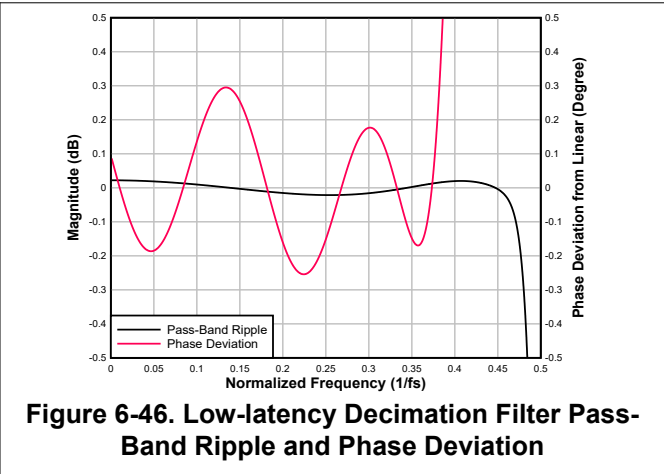
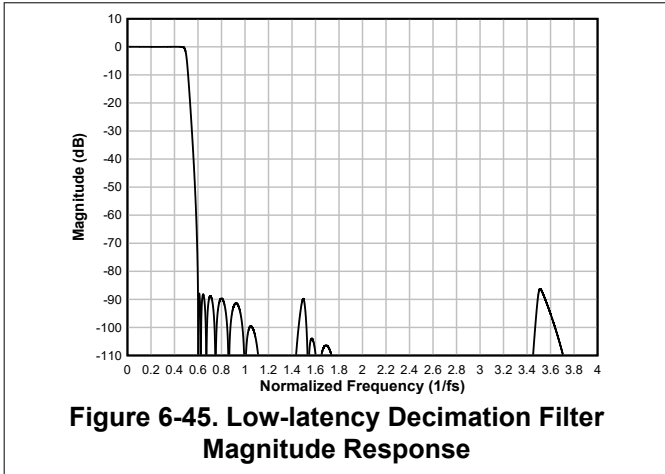


**Table 6-29. Low-latency Decimation Filter Specifications**

PARAMETER	TEST CONDITIONS	MIN	TYP	MAX	UNIT
Pass-band ripple	Frequency range is 0 to $0.492 \times f_S$	-0.67		-0.67	dB
Stop-band attenuation	Frequency range is $0.6 \times f_S$ to $4 \times f_S$	81.8			dB
	Frequency range is $4 \times f_S$ onwards	115			
Group delay or latency	Frequency range is 0 to $0.376 \times f_S$		6.5		$1/f_S$
Group delay deviation	Frequency range is 0 to $0.376 \times f_S$	-0.092		0.029	$1/f_S$
Phase deviation	Frequency range is 0 to $0.376 \times f_S$	-0.3		0.27	Degrees

**6.3.7.1.8.2.3 Sampling Rate: 48kHz or 44.1kHz**

Figure 6-45 shows the magnitude response and Figure 6-46 shows the pass-band ripple and phase deviation for this decimation filter with a sampling rate of 48kHz or 44.1kHz. Table 6-30 lists its specifications.



**Table 6-30. Low-latency Decimation Filter Specifications**

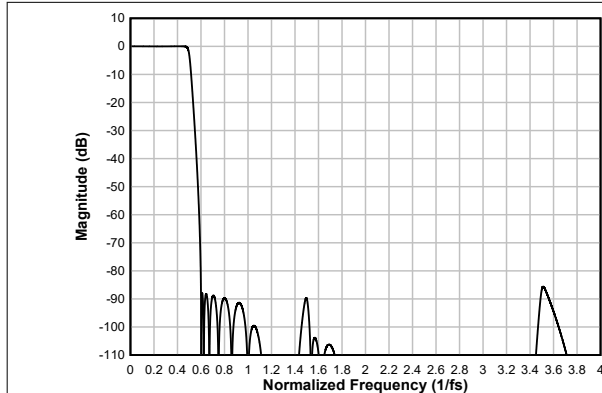
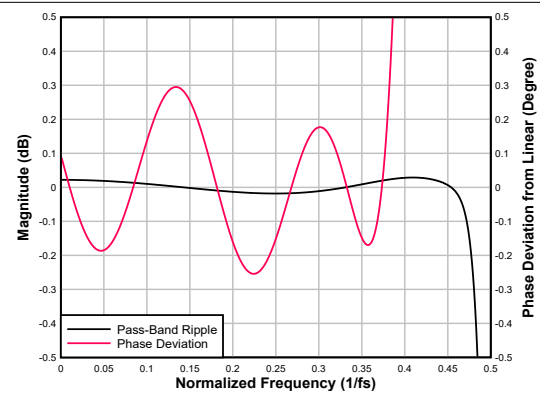
PARAMETER	TEST CONDITIONS	MIN	TYP	MAX	UNIT
Pass-band ripple	Frequency range is 0 to $0.456 \times f_S$	-0.02		-0.02	dB
Stop-band attenuation	Frequency range is $0.6 \times f_S$ to $4 \times f_S$	86.3			dB
	Frequency range is $4 \times f_S$ onwards	96.8			
Group delay or latency	Frequency range is 0 to $0.376 \times f_S$		6.6		$1/f_S$
Group delay deviation	Frequency range is 0 to $0.376 \times f_S$	-0.086		0.027	$1/f_S$

**Table 6-30. Low-latency Decimation Filter Specifications (continued)**

PARAMETER	TEST CONDITIONS	MIN	TYP	MAX	UNIT
Phase deviation	Frequency range is 0 to $0.376 \times f_S$	-0.25		0.3	Degrees

**6.3.7.1.8.2.4 Sampling Rate: 96kHz or 88.2kHz**

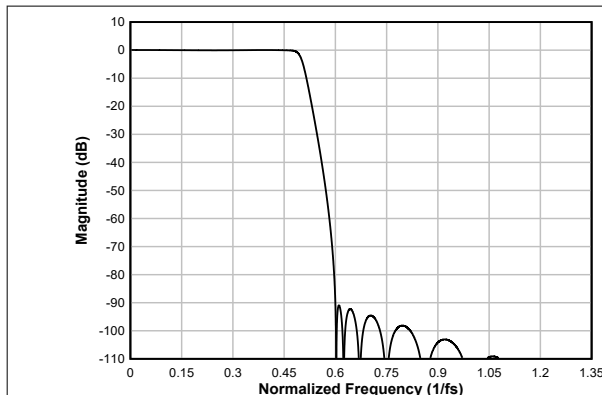
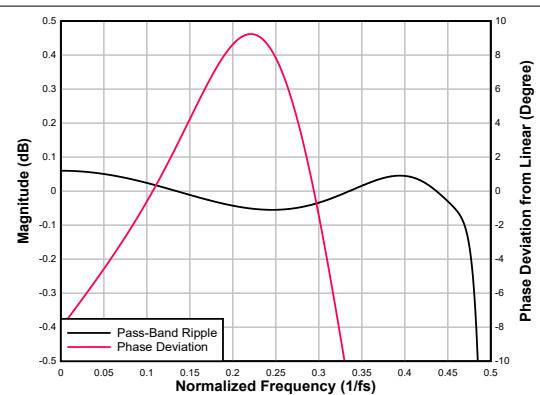
Figure 6-47 shows the magnitude response and Figure 6-48 shows the pass-band ripple and phase deviation for this decimation filter with a sampling rate of 96kHz or 88.2kHz. Table 6-31 lists its specifications.

**Figure 6-47. Low-latency Decimation Filter Magnitude Response****Figure 6-48. Low-latency Decimation Filter Pass-Band Ripple and Phase Deviation****Table 6-31. Low-latency Decimation Filter Specifications**

PARAMETER	TEST CONDITIONS	MIN	TYP	MAX	UNIT
Pass-band ripple	Frequency range is 0 to $0.456 \times f_S$	-0.02		0.03	dB
Stop-band attenuation	Frequency range is $0.599 \times f_S$ to $4 \times f_S$	85.6			
	Frequency range is $4 \times f_S$ onwards	95.7			
Group delay or latency	Frequency range is 0 to $0.376 \times f_S$		6.6		$1/f_S$
Group delay deviation	Frequency range is 0 to $0.376 \times f_S$	-0.086		0.022	$1/f_S$
Phase deviation	Frequency range is 0 to $0.376 \times f_S$	-0.25		0.022	Degrees

**6.3.7.1.8.2.5 Sampling Rate: 192kHz or 176.4kHz**

Figure 6-49 shows the magnitude response and Figure 6-50 shows the pass-band ripple and phase deviation for this decimation filter with a sampling rate of 192kHz or 176.4kHz. Table 6-32 lists its specifications.

**Figure 6-49. Low-latency Decimation Filter Magnitude Response****Figure 6-50. Low-latency Decimation Filter Pass-Band Ripple and Phase Deviation**

**Table 6-32. Low-latency Decimation Filter Specifications**

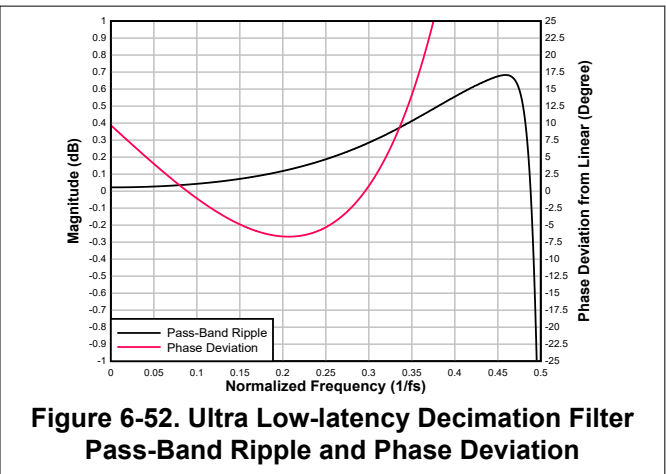
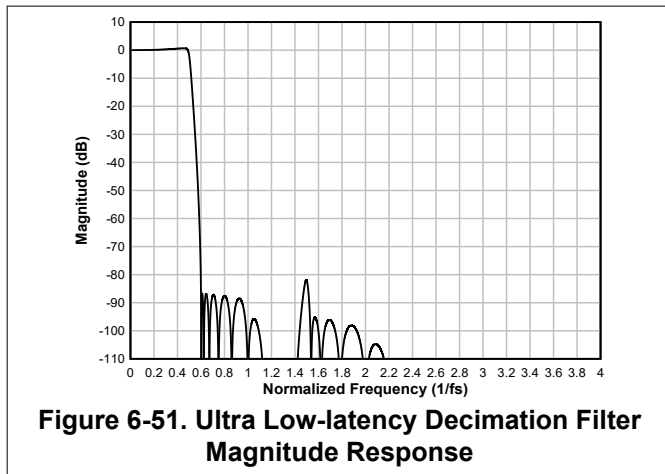
PARAMETER	TEST CONDITIONS	MIN	TYP	MAX	UNIT
Pass-band ripple	Frequency range is 0 to $0.456 \times f_S$	-0.06		0.06	dB
Stop-band attenuation	Frequency range is $0.571 \times f_S$ to $1.35 \times f_S$	90.5			dB
	Frequency range is $1 \times f_S$ onwards	86.9			
Group delay or latency	Frequency range is 0 to $0.327 \times f_S$		6.8		$1/f_S$
Group delay deviation	Frequency range is 0 to $0.327 \times f_S$	-0.296		0.829	$1/f_S$
Phase deviation	Frequency range is 0 to $0.327 \times f_S$	-9.24		9.24	Degrees

**6.3.7.1.8.3 Ultra-Low-Latency Filters**

For applications where ultra-low latency (within the audio band) is critical, the ultra-low-latency decimation filters on the TAA5412-Q1 can be used. The device supports these filters with a group delay of approximately four samples with an almost linear phase response within the  $0.325 \times f_S$  frequency band. This section provides the filter performance specifications and various plots for all supported output sampling rates for the ultra-low-latency filters.

**6.3.7.1.8.3.1 Sampling Rate: 24kHz or 22.05kHz**

Figure 6-51 shows the magnitude response and Figure 6-52 shows the pass-band ripple and phase deviation for this decimation filter with a sampling rate of 24kHz or 22.05kHz. Table 6-33 lists its specifications.

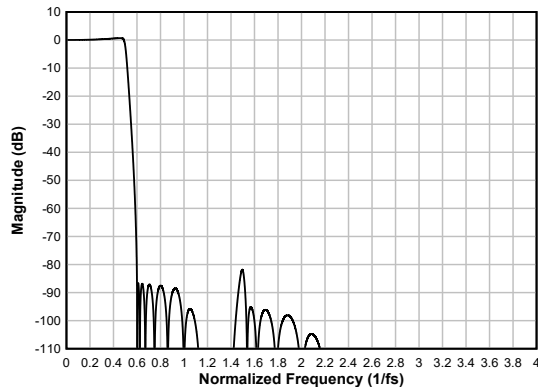


**Table 6-33. Ultra Low-latency Decimation Filter Specifications**

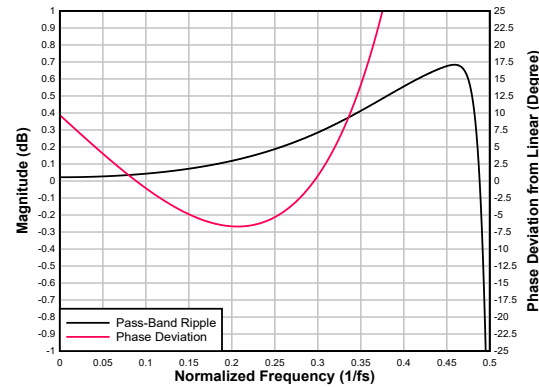
PARAMETER	TEST CONDITIONS	MIN	TYP	MAX	UNIT
Pass-band ripple	Frequency range is 0 to $0.492 \times f_S$	-0.67		-0.67	dB
Stop-band attenuation	Frequency range is $0.6 \times f_S$ to $4 \times f_S$	81.8			dB
	Frequency range is $4 \times f_S$ onwards	115			
Group delay or latency	Frequency range is 0 to $0.325 \times f_S$		2.8		$1/f_S$
Group delay deviation	Frequency range is 0 to $0.325 \times f_S$	-0.292		0.765	$1/f_S$
Phase deviation	Frequency range is 0 to $0.325 \times f_S$	-6.7		9.7	Degrees

**6.3.7.1.8.3.2 Sampling Rate: 32kHz or 29.4kHz**

Figure 6-53 shows the magnitude response and Figure 6-54 shows the pass-band ripple and phase deviation for this decimation filter with a sampling rate of 32kHz or 29.4kHz. Table 6-34 lists its specifications.



**Figure 6-53. Ultra Low-latency Decimation Filter Magnitude Response**



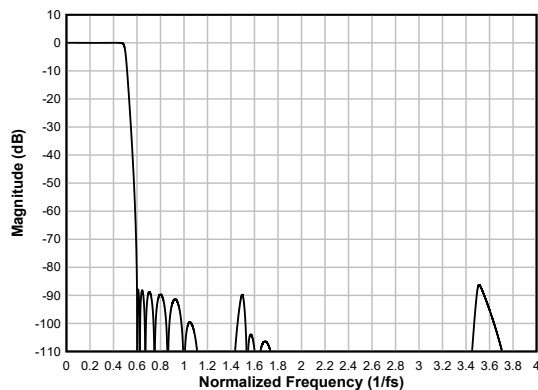
**Figure 6-54. Ultra Low-latency Decimation Filter Pass-Band Ripple and Phase Deviation**

**Table 6-34. Ultra Low-latency Decimation Filter Specifications**

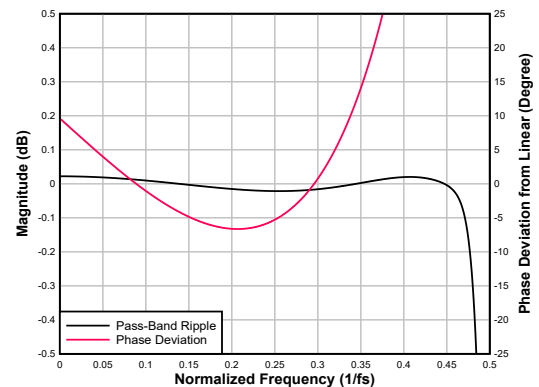
PARAMETER	TEST CONDITIONS	MIN	TYP	MAX	UNIT
Pass-band ripple	Frequency range is 0 to $0.492 \times f_S$	-0.67		-0.67	dB
Stop-band attenuation	Frequency range is $0.6 \times f_S$ to $4 \times f_S$	81.8			dB
	Frequency range is $4 \times f_S$ onwards	115			
Group delay or latency	Frequency range is 0 to $0.325 \times f_S$		2.7		$1/f_S$
Group delay deviation	Frequency range is 0 to $0.325 \times f_S$	-0.292		0.765	$1/f_S$
Phase deviation	Frequency range is 0 to $0.325 \times f_S$	-6.7		9.7	Degrees

### 6.3.7.1.8.3.3 Sampling Rate: 48kHz or 44.1kHz

Figure 6-55 shows the magnitude response and Figure 6-56 shows the pass-band ripple and phase deviation for this decimation filter with a sampling rate of 48kHz or 44.1kHz. Table 6-35 lists its specifications.



**Figure 6-55. Ultra Low-latency Decimation Filter Magnitude Response**



**Figure 6-56. Ultra Low-latency Decimation Filter Pass-Band Ripple and Phase Deviation**

**Table 6-35. Ultra Low-latency Decimation Filter Specifications**

PARAMETER	TEST CONDITIONS	MIN	TYP	MAX	UNIT
Pass-band ripple	Frequency range is 0 to $0.456 \times f_S$	-0.02		-0.02	dB
Stop-band attenuation	Frequency range is $0.6 \times f_S$ to $4 \times f_S$	86.3			dB
	Frequency range is $4 \times f_S$ onwards	96.8			
Group delay or latency	Frequency range is 0 to $0.325 \times f_S$		2.8		$1/f_S$
Group delay deviation	Frequency range is 0 to $0.325 \times f_S$	-0.29		0.761	$1/f_S$

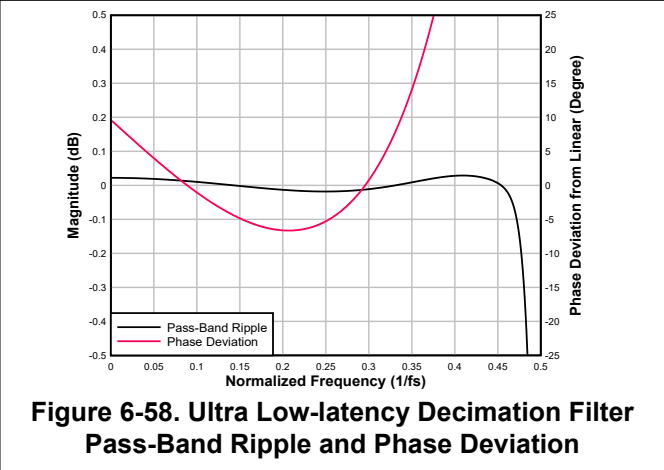
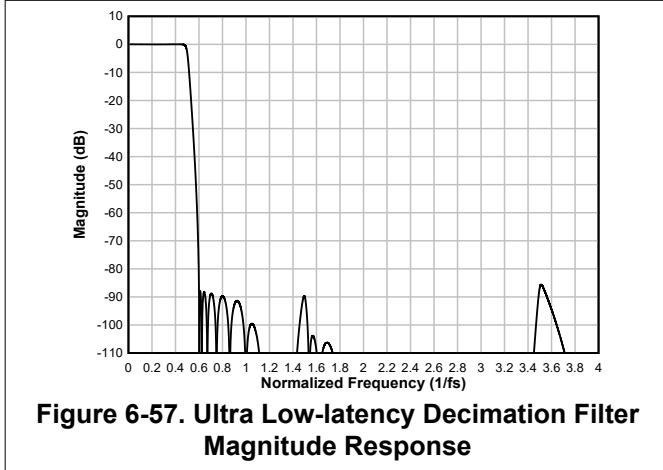


**Table 6-35. Ultra Low-latency Decimation Filter Specifications (continued)**

PARAMETER	TEST CONDITIONS	MIN	TYP	MAX	UNIT
Phase deviation	Frequency range is 0 to $0.325 \times f_S$	-6.6		9.6	Degrees

**6.3.7.1.8.3.4 Sampling Rate: 96kHz or 88.2kHz**

Figure 6-57 shows the magnitude response and Figure 6-58 shows the pass-band ripple and phase deviation for this decimation filter with a sampling rate of 96kHz or 88.2kHz. Table 6-36 lists its specifications.

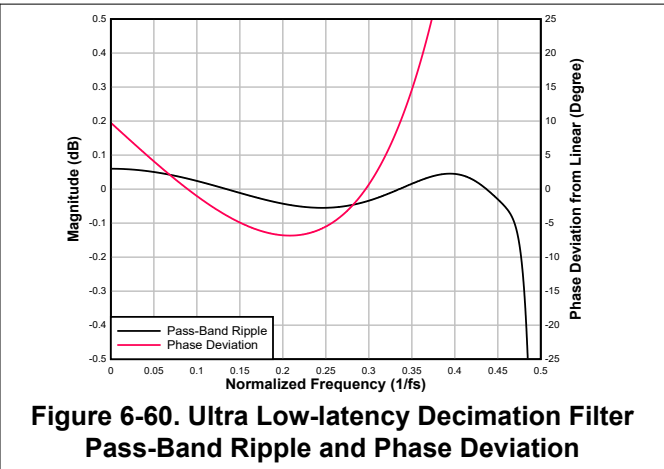
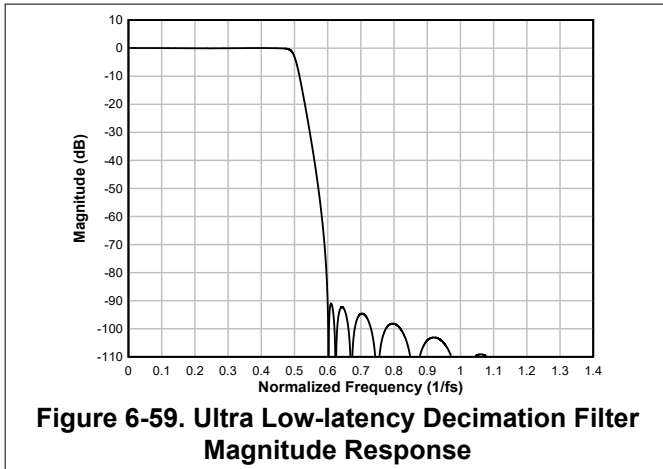


**Table 6-36. Ultra Low-latency Decimation Filter Specifications**

PARAMETER	TEST CONDITIONS	MIN	TYP	MAX	UNIT
Pass-band ripple	Frequency range is 0 to $0.456 \times f_S$	-0.02		0.03	dB
Stop-band attenuation	Frequency range is $0.599 \times f_S$ to $4 \times f_S$	85.6			dB
	Frequency range is $4 \times f_S$ onwards	95.7			
Group delay or latency	Frequency range is 0 to $0.325 \times f_S$		2.7		$1/f_S$
Group delay deviation	Frequency range is 0 to $0.325 \times f_S$	-0.29		0.761	$1/f_S$
Phase deviation	Frequency range is 0 to $0.325 \times f_S$	-6.6		9.6	Degrees

**6.3.7.1.8.3.5 Sampling Rate: 192kHz or 176.4kHz**

Figure 6-59 shows the magnitude response and Figure 6-60 shows the pass-band ripple and phase deviation for this decimation filter with a sampling rate of 192kHz or 176.4kHz. Table 6-37 lists its specifications.

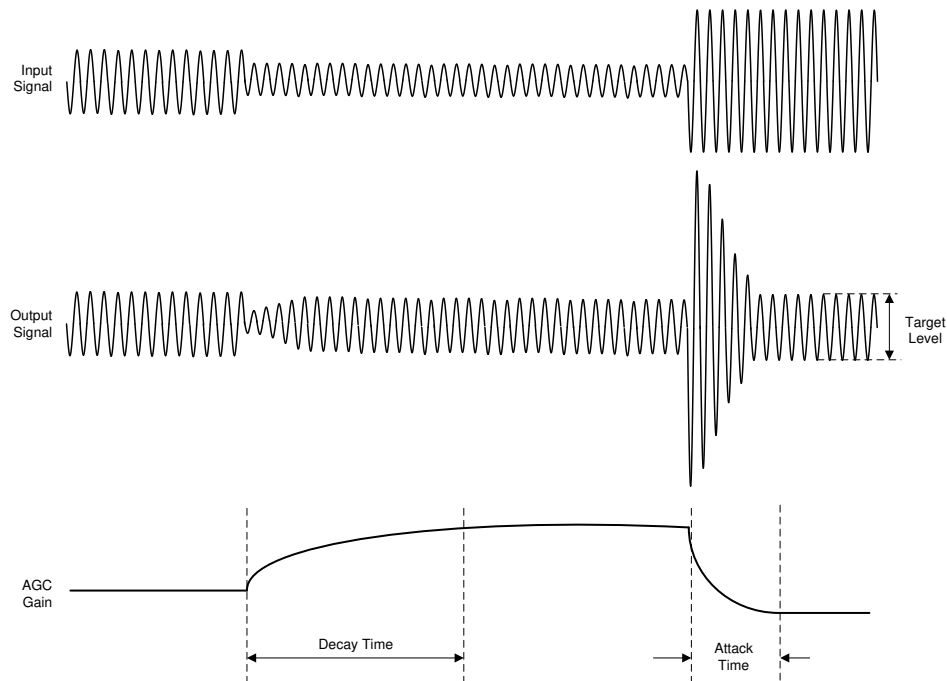


**Table 6-37. Ultra Low-latency Decimation Filter Specifications**

PARAMETER	TEST CONDITIONS	MIN	TYP	MAX	UNIT
Pass-band ripple	Frequency range is 0 to $0.456 \times f_S$	-0.06		0.06	dB
Stop-band attenuation	Frequency range is $0.571 \times f_S$ to $1.35 \times f_S$	90.5			dB
	Frequency range is $1.35 \times f_S$ onwards	86.9			
Group delay or latency	Frequency range is 0 to $0.325 \times f_S$		2.7		$1/f_S$
Group delay deviation	Frequency range is 0 to $0.325 \times f_S$	-0.293		0.794	$1/f_S$
Phase deviation	Frequency range is 0 to $0.325 \times f_S$	-6.8		9.8	Degrees

### 6.3.7.1.9 Automatic Gain Controller (AGC)

The device includes an automatic gain controller (AGC) for ADC recording. As shown in Figure 6-61, the AGC can be used to maintain a nominally constant output level when recording speech. Instead of manually setting the channel gain in AGC mode, the circuitry automatically adjusts the channel gain when the input signal becomes overly loud or very weak, such as when a person speaking into a microphone moves closer to or farther from the microphone. The AGC algorithm has several programmable parameters, including target level, maximum gain allowed, attack and release (or decay) time constants, and noise thresholds that allow the algorithm to be fine-tuned for any particular application. These are part of the programmable coefficients of the device for flexibility and can be configured using the registers in B0\_P27 and B0\_P28.

**Figure 6-61. AGC Characteristics**

The target level represents the nominal approximate output level at which the AGC attempts to hold the ADC output signal level. The TAA5412-Q1 allows programming of different target levels. The target level is recommended to be set with enough margin to prevent clipping when loud sounds occur. For further details on the AGC various configurable parameter and application use, see the [Using the Automatic Gain Controller \(AGC\) in TAx5x1x Family application report](#). TI recommends using the PPC3 GUI for configuring the programmable coefficients settings; for more details see the [TAx5x1x-Q1EVM-PDK Evaluation module user's guide](#) and the [PurePath™ console graphical development suite](#).

### 6.3.7.1.10 Voice Activity Detection (VAD)

The TAA5412-Q1 supports voice activity detection (VAD) mode as part of low power activity detection (LPAD) schemes. In this mode, the TAA5412-Q1 continuously monitors one of the input channels for voice detection.

The device consumes low quiescent current from the AVDD supply in this mode. This feature can be enabled by setting VAD\_EN (P0\_R120\_D[2]) to 1'b1. On detecting voice activity, the TAA5412-Q1 can alert the host through an interrupt or auto wake up and start recording based on the I<sup>2</sup>C programmed configuration. This alert can be configured through the LPAD\_MODE (P1\_R30\_D[7:6]) register bits.

This feature is supported on both the analog and digital microphone interfaces. For lowest power VAD, the digital microphone interface is recommended. The input channel for the VAD can be selected by setting the LPAD\_CH\_SEL (P1\_R30\_D[5:4]) register bits to an appropriate value. See the [How to use the Voice Activity Detection in the TAx511x and TAx521x application report](#) for further details.

#### 6.3.7.1.11 Ultrasonic Activity Detection (UAD)

The TAA5412-Q1 supports ultrasonic activity detection (UAD) mode as part of low power activity detection (LPAD) schemes. In this mode, the TAA5412-Q1 continuously monitors one of the input channels for signals in the ultrasonic frequency band. The device consumes low quiescent current from the AVDD supply in this mode. This feature can be enabled by setting UAD\_EN (P0\_R120\_D[3]) to 1'b1. On detecting ultrasonic activity, the TAA5412-Q1 can alert the host through an interrupt or auto wake up and start recording based on the I<sup>2</sup>C programmed configuration. This alert can be configured through the LPAD\_MODE (P1\_R30\_D[7:6]) register bits.

This feature is supported on both the analog and digital microphone interfaces. For lowest power UAD, the digital microphone interface is recommended. The input channel for the UAD can be selected by setting the LPAD\_CH\_SEL (P1\_R30\_D[5:4]) register bits to an appropriate value. See the [How to use the Ultrasonic Activity Detection in the TAx511x and TAx521x](#) for further details.

#### 6.3.8 Interrupts, Status, and Digital I/O Pin Multiplexing

Certain events in the device may require host processor intervention and can be used to trigger interrupts to the host processor. One such event is an audio serial interface (ASI) bus error. The device powers down the record channels if any faults are detected with the ASI bus error clocks, such as:

- Invalid FSYNC frequency
- Invalid BCLK to FSYNC ratio
- Long pauses of the BCLK or FSYNC clocks

When an ASI bus clock error is detected, the device shuts down all the record channels as quickly as possible. After all ASI bus clock errors are resolved, the device volume ramps back to its previous state to recover the audio. During an ASI bus clock error, the internal interrupt request (IRQ) interrupt signal asserts low if the clock error interrupt mask register bit INT\_MASK0[7] (P1\_R47\_D[7]) is set low. The clock fault is also available for readback in the latched fault status register bit INT\_LTCH0 (P1\_R52), which is a read-only register. Reading the latched fault status register, INT\_LTCH0, clears all latched fault status. The device can be additionally configured to route the internal IRQ interrupt signal on the GPIO1 or GPO1A pins and also can be configured as open-drain outputs so that these pins can be wire-ANDed to the open-drain interrupt outputs of other devices.

The IRQ interrupt signal can either be configured as active low or active high polarity by setting the INT\_POL (P0\_R66\_D[7]) register bit. This signal can also be configured as a single pulse or a series of pulses by programming the INT\_EVENT[1:0] (P0\_R66\_D[6:5]) register bits. If the interrupts are configured as a series of pulses, the events trigger the start of pulses that stop when the latched fault status register is read to determine the cause of the interrupt.

The device also supports read-only live-status registers to determine if the channels are powered up or down and if the device is in sleep mode or not. These status registers are located in the DEV\_STS0 (P0\_R121) and DEV\_STS1 (P0\_R122) register bits.

The device has a multifunctional GPIO1, GPIxA and GPO1A pins that can be configured for a desired specific function. [Table 6-38](#) lists all possible allocations of these multifunctional pins for the various features.

**Table 6-38. Multifunction Pin Assignments**

ROW	PIN FUNCTION	GPIO1	GPIO2A	GPO1A	GPI1A
—	—	GPIO1_CFG	GPIO2A_CFG	GPO1A_CFG	GPI1A_CFG
—	—	P0_R10[7:4]	P0_R13[0]	P0_R12[7:4]	P0_R13[1]
A	Pin disabled	S <sup>(1)</sup>	S (default)	S (default)	S (default)
B	General-purpose output (GPO)	S	S	S	NS
C	Interrupt output (IRQ)	S (default)	S	S	NS
D	Power down for all ADC channels	S	S	NS	S
E	PDM clock output (PDMCLK)	S	S	S	NS
F	MICBIAS on/off input (BIASEN)	S	S	NS	S
G	General-purpose input (GPI)	S	S	NS	S
H	Controller clock input (CCLK)	S	S	S	S
I	ASI daisy-chain input	S	S	NS	S
J	PDM data input 1 (PDMIN1)	S	S	NS	S
K	PDM data input 2 (PDMIN2)	S	S	NS	S
L	ASI DOUT	S	S	S	NS
M	ASI BCLK	S	S	S	S
N	ASI FSYNC	S	S	S	S
O	General Purpose Clock Out	S	S	S	NS

- (1) S means the feature mentioned in this row is *supported* for the respective GPIO1, GPO1A, or GPIxA pin mentioned in this column and NS means the feature mentioned in this row is *not supported* for the respective GPIO1, GPO1A, or GPIxA pin mentioned in this column.

Each GPO1A or GPIO1 pin can be independently set for the desired drive configurations setting using the GPIO1\_DRV[2:0] or GPO1A\_DRV[2:0] register bits. [Table 6-39](#) lists the drive configuration settings.

**Table 6-39. GPIO1 or GPO1A Pins Drive Configuration Settings**

P0_R10_D[2:0] : GPIO1_DRV[2:0]	GPIO OUTPUT DRIVE CONFIGURATION SETTINGS FOR GPIO1
000	The GPIO1 pin is set to high impedance (floated)
001	The GPIO1 pin is set to be driven active low or active high
010 (default)	The GPIO1 pin is set to be driven active low or weak high (on-chip pullup)
011	The GPIO1 pin is set to be driven active low or Hi-Z (floated)
100	The GPIO1 pin is set to be driven weak low (on-chip pulldown) or active high
101	The GPIO1 pin is set to be driven Hi-Z (floated) or active high
110 and 111	Reserved (do not use these settings)

Similarly, the GPO1A pin can be configured using the GPO1A\_DRV(P0\_R12) register bits.

When configured as a general-purpose output (GPO), the GPIO1 or GPO1A pin values can be driven by writing the GPO\_GPI\_VAL (P0\_R14) registers. The GPIO\_MON bits (P0\_R14\_D[3:1]) can be used to readback the status of the GPIO1 or GPIxA pins when configured as a general-purpose input (GPI).

### 6.3.9 Input DC Fault Diagnostics

Each input of the TAA5412-Q1 features highly comprehensive DC fault diagnostics that can be configured to detect fault conditions in the DC-coupled input configuration and trigger an interrupt request to a host processor. Diagnostics are enabled for each channel by configuring DIAG\_CFG0, P1\_R70. For channels with diagnostics enabled, the input pins are scanned automatically by an integrated SAR ADC with a programmable repetition rate. The diagnostic processor averages eight consecutive samples per test to improve noise performance. The DC fault diagnostics is not supported in the AC-coupled input configuration.

The device features various programmable threshold registers, P1\_R71 to P1\_R72, which can be configured by the host processor to define the fault region for a different category of fault condition detection. Additionally, there is also a debounce feature, configured with FAULT\_DBNCE\_SEL, P1\_R74\_D[3:2]. This feature sets the number of consecutive scan counts where the fault condition occurs before the latched status register is tripped, thus reducing false triggers by transient events.

See the [TAX5xxx-Q1 Fault Diagnostic Features application report](#) for more details

### 6.3.10 Power Tune Mode

For low power applications, the TAA5412-Q1 offers options to configure the device in a power tune mode with typical power consumption 18.5mW for 2-Channel recording with a differential input dynamic range of 104dB. This mode can be configured by setting the PWR\_TUNE\_CFG0 (P0\_R78) register to 0xD4 and PLL\_DIS = 1'b1. For power savings, the ADC modulator clock is set to run at 1.536MHz (the output data sample rate is multiples or submultiples of 48kHz) or 1.4112MHz (the output data sample rate is multiples or submultiples of 44.1 kHz) by using ADC\_CLK\_BY2\_MODE (B0\_P78\_D[7]) register bit. For more details refer the [TAA5412-Q1 Power Consumption Matrix Across Various Usage Scenarios application report](#) for the supported settings of device operation in this mode.

## 6.4 Device Functional Modes

### 6.4.1 Sleep Mode or Software Shutdown

In sleep mode or software shutdown mode, the device consumes very low quiescent current from the AVDD supply and, at the same time, allows the I<sup>2</sup>C or SPI communication to wake the device for active operation.

The device can also enter sleep mode when the host device sets the SLEEP\_ENZ (P0\_R2\_D[0]) bit to 1'b0. If the SLEEP\_ENZ bit is asserted low when the device is in active mode, the device ramps down the volume on the record data, powers down the analog and digital blocks, and enters sleep mode. However, the device still continues to retain the last programmed value of the device configuration registers and programmable coefficients.

In sleep mode, do not perform any I<sup>2</sup>C or SPI transactions, except for exiting sleep mode in order to enter active mode. After entering sleep mode, wait at least 10ms before starting I<sup>2</sup>C or SPI transactions to exit sleep mode.

### 6.4.2 Software Reset

A software reset can be done any time by asserting the SW\_RESET bit (P0\_R1\_D[0]), which is a self-clearing bit. This software reset immediately shuts down the device, and restores all device configuration registers and programmable coefficients to their default values.

### 6.4.3 Active Mode

If the host device exits sleep mode by setting the SLEEP\_ENZ bit to 1'b1, the device enters active mode. In active mode, I<sup>2</sup>C or SPI transactions can be done to configure and power-up the device for active operation. After entering active mode, wait at least 2ms before starting any I<sup>2</sup>C or SPI transactions in order to allow the device to complete the internal wake-up sequence.

Read and write operations to the programmable coefficient registers, and to the channel configuration registers must be done 10ms after exiting sleep mode.

After configuring all other registers for the target application and system settings, configure the input channel enable registers, P0\_R118 (CH\_EN). Lastly, configure the device power-up register, P0\_R120 (PWR\_CFG). All the programmable coefficient values must be written before powering up the respective channel.

In active mode, the power-up and power-down status of various blocks is monitored by reading the read-only device status bits located in the P0\_R121 (DEV\_STS0) and P0\_R122 (DEV\_STS1) registers.

## 6.5 Programming

The device contains configuration registers and programmable coefficients that can be set to the desired values for a specific system and application use. These registers are called *device control registers* and are each eight bits in width, mapped using a page scheme.

Each page contains 128 configuration registers. All device configuration registers are stored in page 0, which is the default page setting at power up and after a software reset. All programmable coefficient registers are located in page 0, page 1, and page 3. The current page of the device can be switched to a new desired page by using the PAGE[7:0] bits located in register 0 of every page.

### 6.5.1 Control Serial Interfaces

The device control registers can be accessed using either I<sup>2</sup>C or SPI communication to the device.

By monitoring the SDA\_PICO, SCL\_SCLK, GPO1A (or GPIO1)\_POCI, and ADDRA\_CSZ device pins, which are the multiplexed pins for the I<sup>2</sup>C or SPI Interface, the device automatically detects whether the host device is using I<sup>2</sup>C or SPI communication to configure the device. For a given end application, the host device must always use either the I<sup>2</sup>C or SPI interface, but not both. To configure the device refer to the [Table 6-40](#).

**Table 6-40. I<sup>2</sup>C Address Configuration**

ADDRA pin	Mode	Device Address (7-bit)	Device Address (8-bit)
Short to Ground	I <sup>2</sup> C	0x50	0xA0
Short to AVDD	I <sup>2</sup> C	0x51	0xA2
CSZ input	SPI	NA	NA

#### 6.5.1.1 I<sup>2</sup>C Control Interface

The device supports the I<sup>2</sup>C control protocol as a target device, and is capable of operating in standard mode, fast mode, and fast mode plus. The I<sup>2</sup>C control protocol requires a 7-bit target address. The five most significant bits (MSBs) of the target address are fixed at 5'b10100 and cannot be changed. The two least significant bits (LSBs) are programmable and are controlled by the ADDRA pin. Refer [Table 6-40](#) for the two possible device addresses supported by TAA5412-Q1 in I<sup>2</sup>C mode. If the I2C\_BRDCAST\_EN (P0\_R4\_D[1]) bit is set to 1'b1, then the 7-bit I<sup>2</sup>C target address is fixed to 7'b1010000 in order to allow simultaneous I<sup>2</sup>C broadcast communication to all TAA5412-Q1 devices in the system.

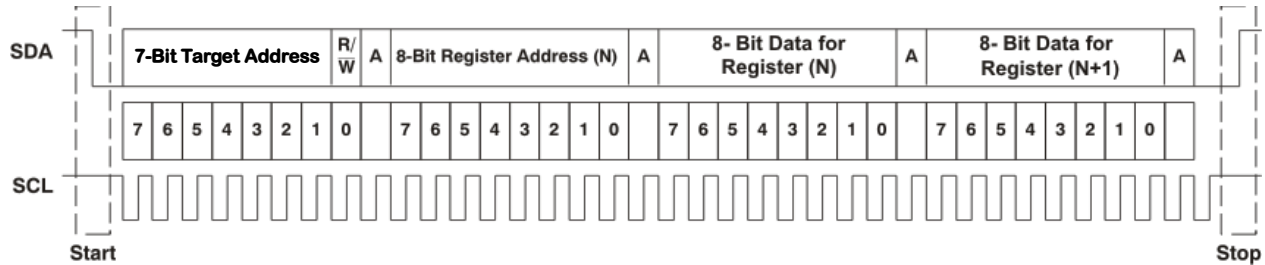
##### 6.5.1.1.1 General I<sup>2</sup>C Operation

The I<sup>2</sup>C bus employs two signals, SDA (data) and SCL (clock), to communicate between integrated circuits in a system using serial data transmission. The address and data 8-bit bytes are transferred MSB first. In addition, each byte transferred on the bus is acknowledged by the receiving device with an acknowledge bit. Each transfer operation begins with the controller device driving a start condition on the bus and ends with the controller device driving a stop condition on the bus. The bus uses transitions on the data pin (SDA) while the clock is at logic high to indicate start and stop conditions. A high-to-low transition on SDA indicates a start, and a low-to-high transition indicates a stop. Normal data-bit transitions must occur within the low time of the clock period.

The controller device drives a start condition followed by the 7-bit target address and the read/write (R/W) bit to open communication with another device and then waits for an acknowledgment condition. The target device holds SDA low during the acknowledge clock period to indicate acknowledgment. When this occurs, the controller device transmits the next byte of the sequence. Each target device is addressed by a unique 7-bit target address plus the R/W bit (1 byte). All compatible devices share the same signals via a bidirectional bus using a wired-AND connection.



There is no limit on the number of bytes that can be transmitted between start and stop conditions. When the last word transfers, the controller device generates a stop condition to release the bus. Figure 6-62 shows a generic data transfer sequence.



**Figure 6-62. Typical I<sup>2</sup>C Sequence**

In the system, use external pullup resistors for the SDA and SCL signals to set the logic high level for the bus. The SDA and SCL voltages must not exceed the device supply voltage, IOVDD.

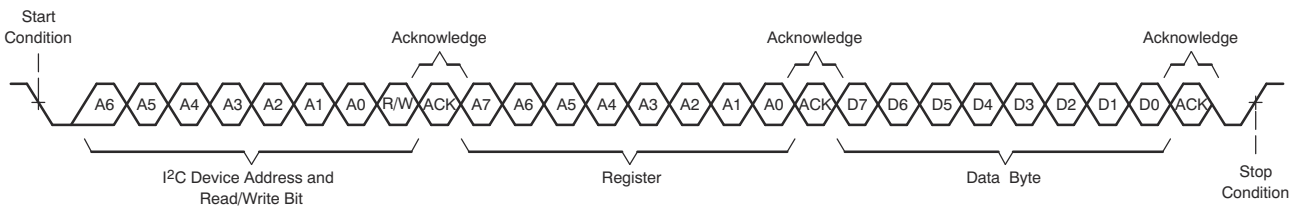
**6.5.1.1.2 I<sup>2</sup>C Single-Byte and Multiple-Byte Transfers**

The device I<sup>2</sup>C interface supports both single-byte and multiple-byte read/write operations for all registers. During multiple-byte read operations, the device responds with data, a byte at a time, starting at the register assigned, as long as the controller device continues to respond with acknowledgements.

The device supports sequential I<sup>2</sup>C addressing. For write transactions, if a register is issued followed by data for that register and all the remaining registers that follow, a sequential I<sup>2</sup>C write transaction takes place. For I<sup>2</sup>C sequential write transactions, the register issued then serves as the starting point, and the amount of data subsequently transmitted, before a stop or start is transmitted, determines how many registers are written.

**6.5.1.1.2.1 I<sup>2</sup>C Single-Byte Write**

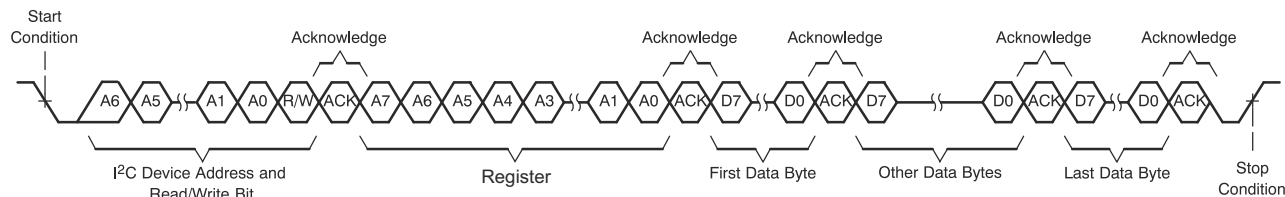
As shown in Figure 6-63, a single-byte data write transfer begins with the controller device transmitting a start condition followed by the I<sup>2</sup>C device address and the read/write bit. The read/write bit determines the direction of the data transfer. For a write-data transfer, the read/write bit must be set to 0. After receiving the correct I<sup>2</sup>C target address and the read/write bit, the device responds with an acknowledge bit (ACK). Next, the controller device transmits the register byte corresponding to the device internal register address being accessed. After receiving the register byte, the device again responds with an acknowledge bit (ACK). Then, the controller device transmits the byte of data to be written to the specified register. When finished, the target device responds with an acknowledge bit (ACK). Finally, the controller device transmits a stop condition to complete the single-byte data write transfer.



**Figure 6-63. I<sup>2</sup>C Single-Byte Write Transfer**

### 6.5.1.1.2.2 I<sup>2</sup>C Multiple-Byte Write

As shown in Figure 6-64, a multiple-byte data write transfer is identical to a single-byte data write transfer except that multiple data bytes are transmitted by the controller device to the target device. After receiving each data byte, the device responds with an acknowledge bit (ACK). Finally, the controller device transmits a stop condition after the last data-byte write transfer.

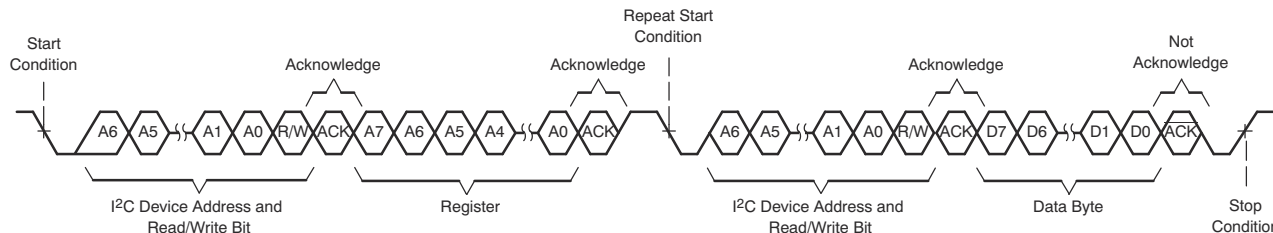


**Figure 6-64. I<sup>2</sup>C Multiple-Byte Write Transfer**

### 6.5.1.1.2.3 I<sup>2</sup>C Single-Byte Read

As shown in Figure 6-65, a single-byte data read transfer begins with the controller device transmitting a start condition followed by the I<sup>2</sup>C target address and the read/write bit. For the data read transfer, both a write followed by a read are done. Initially, a write is done to transfer the address byte of the internal register address to be read. As a result, the read/write bit is set to 0.

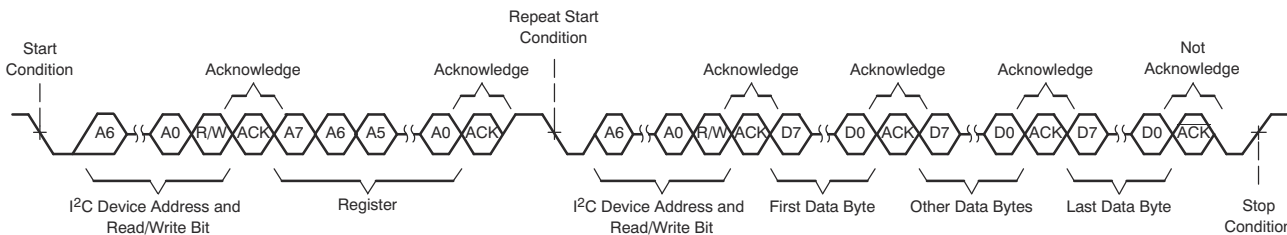
After receiving the target address and the read/write bit, the device responds with an acknowledge bit (ACK). The controller device then sends the internal register address byte, after which the device issues an acknowledge bit (ACK). The controller device transmits another start condition followed by the target address and the read/write bit again. This time, the read/write bit is set to 1, indicating a read transfer. Next, the device transmits the data byte from the register address being read. After receiving the data byte, the controller device transmits a not-acknowledge (NACK) followed by a stop condition to complete the single-byte data read transfer.



**Figure 6-65. I<sup>2</sup>C Single-Byte Read Transfer**

### 6.5.1.1.2.4 I<sup>2</sup>C Multiple-Byte Read

As shown in Figure 6-66, a multiple-byte data read transfer is identical to a single-byte data read transfer except that multiple data bytes are transmitted by the device to the controller device. With the exception of the last data byte, the controller device responds with an acknowledge bit after receiving each data byte. After receiving the last data byte, the controller device transmits a not-acknowledge (NACK) followed by a stop condition to complete the data read transfer.



**Figure 6-66. I<sup>2</sup>C Multiple-Byte Read Transfer**



### 6.5.1.2 SPI Control Interface

The general SPI protocol allows full-duplex, synchronous, serial communication between a host processor (the controller) and peripheral devices. The SPI controller (in this case, the host processor) generates the synchronizing clock (driven on to SCLK) and initiates transmissions by taking the peripheral-select pin CSZ from high to low. The SPI peripheral devices (such as the TAA5412-Q1) depend on a controller device to start and synchronize transmissions. A transmission begins when initiated by an SPI controller. The byte from the SPI controller begins shifting in on the peripheral PICO pin under the control of the controller serial clock (driven onto SCLK). When the byte shifts in on the PICO pin, a byte shifts out on the POCI pin to the controller shift register. [Table 6-41](#)

mentions the pin assignment for SPI mode of control.

**Table 6-41. Pin Assignments for SPI Control**

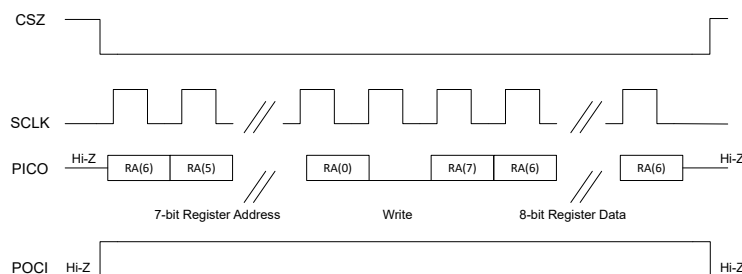
Pin Number	Pin Name	Pin Name in SPI Mode	Description
9	SCL	SCLK	SPI serial bit clock
10	SDA	PICO	SPI peripheral input pin
23 or 11	GPO1A or GPIO1	POCI	SPI peripheral output pin
22	ADDRA	CSZ	SPI chip select pin

The TAA5412-Q1 supports a standard SPI control protocol with a clock polarity setting of 0 (typical microprocessor SPI control bit CPOL = 0) and a clock phase setting of 1 (typical microprocessor SPI control bit CPHA = 1). The CSZ pin can remain low between transmissions; however, the device only interprets the first eight bits transmitted after the falling edge of CSZ as a command byte, and the next eight bits as a data byte only if writing to a register. The device is entirely controlled by registers. Reading and writing these registers is accomplished by an 8-bit command sent to the PICO pin prior to the data for that register. [Table 6-42](#) shows the command structure. The first seven bits specify the address of the register that is being written or read, from 0 to 127 (decimal). The command word ends with an R/W bit, which specifies the direction of data flow on the serial bus.

In the case of a register write, set the R/W bit to 0. A second byte of data is sent to the PICO pin and contains the data to be written to the register. A register read is accomplished in a similar fashion. The 8-bit command word sends the 7-bit register address, followed by the R/W bit equal to 1 to signify a register read. The 8-bit register data is then clocked out of the device on the POCI pin during the second eight SCLK clocks in the frame. The device supports sequential SPI addressing for a multiple-byte data write/read transfer until the CSZ pin is pulled high. A multiple-byte data write or read transfer is identical to a single-byte data write or read transfer, respectively, until all data byte transfers complete. The host device must keep the CSZ pin low during all data byte transfers. [Figure 6-67](#) shows the single-byte write transfer and [Figure 6-68](#) shows the single-byte read transfer.

**Table 6-42. SPI Command Word**

BIT 7	BIT 6	BIT 5	BIT 4	BIT 3	BIT 2	BIT 1	BIT 0
ADDR(6)	ADDR(5)	ADDR(4)	ADDR(3)	ADDR(2)	ADDR(1)	ADDR(0)	R/WZ



**Figure 6-67. SPI Single-Byte Write Transfer**

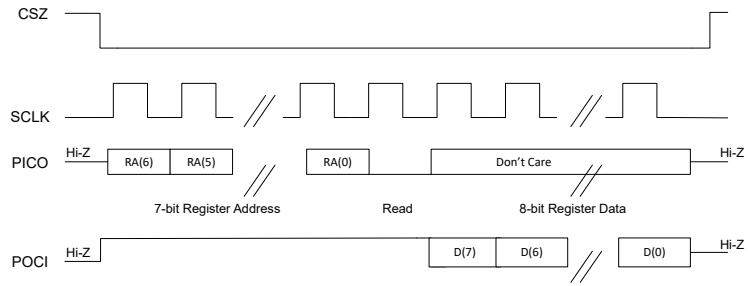


Figure 6-68. SPI Single-Byte Read Transfer

## 7 Register Maps

This section describes the control registers for the device in detail. All these registers are eight bits in width and allocated to device configuration and programmable coefficients settings. These registers are mapped internally using a page scheme that can be controlled using either I<sup>2</sup>C or SPI communication to the device. Each page contains 128 bytes of registers. All device configuration registers are stored in page 0, page 1 and page 3. Page 0 is the default page setting at power up (and after a software reset). The device current page can be switch to a new desired page by using the PAGE[7:0] bits located in register 0 of every page.

Do not read from or write to reserved pages or reserved registers. Write only default values for the reserved bits in the valid registers.

The procedure for register access across pages is:

- Select page *N* (write data *N* to register 0 regardless of the current page number)
- Read or write data from or to valid registers in page *N*
- Select the new page *M* (write data *M* to register 0 regardless of the current page number)
- Read or write data from or to valid registers in page *M*
- Repeat as needed

### 7.1 Device Configuration Registers

This section describes the device configuration registers for Page 0, Page 1 and Page 3 of the device. [Table 7-1](#) lists the access codes for the device registers.

**Table 7-1. Access Type Codes**

Access Type	Code	Description
Read Type		
R	R	Read
R-W	R/W	Read or write
Write Type		
W	W	Write

### 7.1.1 TAA5412-Q1\_B0\_P0 Registers

Table 7-2 lists the memory-mapped registers for the TAA5412-Q1\_B0\_P0 registers. All register offset addresses not listed in Table 7-2 should be considered as reserved locations and the register contents should not be modified.

**Table 7-2. TAA5412-Q1\_B0\_P0 Registers**

Address	Acronym	Register Name	Reset Value	Section
0x0	PAGE_CFG	Device page register	0x00	<a href="#">Section 7.1.1.1</a>
0x1	SW_RESET	Software reset register	0x00	<a href="#">Section 7.1.1.2</a>
0x2	DEV_MISC_CFG	Device miscellaneous configuration register	0x00	<a href="#">Section 7.1.1.3</a>
0x3	AVDD_IOVDD_STS	Supply status Register	0x00	<a href="#">Section 7.1.1.4</a>
0x4	MISC_CFG	Miscellaneous configuration register	0x00	<a href="#">Section 7.1.1.5</a>
0x5	MISC_CFG1	Miscellaneous configuration register 1	0x15	<a href="#">Section 7.1.1.6</a>
0x7	MISC_CFG0	Miscellaneous configuration register 0	0x00	<a href="#">Section 7.1.1.7</a>
0xA	GPIO1_CFG0	GPIO1 configuration register 0	0x32	<a href="#">Section 7.1.1.8</a>
0xC	GPO1A_CFG0	GPO1A configuration register 0	0x00	<a href="#">Section 7.1.1.9</a>
0xD	GPI_CFG	GPI configuration register 0	0x00	<a href="#">Section 7.1.1.10</a>
0xE	GPO_GPI_VAL	GPIO, GPO output value register	0x00	<a href="#">Section 7.1.1.11</a>
0xF	INTF_CFG0	Interface configuration register 0	0x00	<a href="#">Section 7.1.1.12</a>
0x10	INTF_CFG1	Interface configuration register 1	0x52	<a href="#">Section 7.1.1.13</a>
0x11	INTF_CFG2	Interface configuration register 2	0x80	<a href="#">Section 7.1.1.14</a>
0x12	INTF_CFG3	Interface configuration register 3	0x00	<a href="#">Section 7.1.1.15</a>
0x13	INTF_CFG4	Interface configuration register 4	0x00	<a href="#">Section 7.1.1.16</a>
0x14	INTF_CFG5	Interface configuration register 5	0x00	<a href="#">Section 7.1.1.17</a>
0x15	INTF_CFG6	Interface configuration register 6	0x00	<a href="#">Section 7.1.1.18</a>
0x18	ASI_CFG0	ASI configuration register 0	0x40	<a href="#">Section 7.1.1.19</a>
0x19	ASI_CFG1	ASI configuration register 1	0x00	<a href="#">Section 7.1.1.20</a>
0x1A	PASI_CFG0	Primary ASI configuration register 0	0x30	<a href="#">Section 7.1.1.21</a>
0x1B	PASI_TX_CFG0	PASI TX configuration register 0	0x00	<a href="#">Section 7.1.1.22</a>
0x1C	PASI_TX_CFG1	PASI TX configuration register 1	0x00	<a href="#">Section 7.1.1.23</a>
0x1D	PASI_TX_CFG2	PASI TX configuration register 2	0x00	<a href="#">Section 7.1.1.24</a>
0x1E	PASI_TX_CH1_CFG	PASI TX Channel 1 configuration register	0x20	<a href="#">Section 7.1.1.25</a>
0x1F	PASI_TX_CH2_CFG	PASI TX Channel 2 configuration register	0x21	<a href="#">Section 7.1.1.26</a>
0x20	PASI_TX_CH3_CFG	PASI TX Channel 3 configuration register	0x02	<a href="#">Section 7.1.1.27</a>
0x21	PASI_TX_CH4_CFG	PASI TX Channel 4 configuration register	0x03	<a href="#">Section 7.1.1.28</a>
0x22	PASI_TX_CH5_CFG	PASI TX Channel 5 configuration register	0x04	<a href="#">Section 7.1.1.29</a>
0x23	PASI_TX_CH6_CFG	PASI TX Channel 6 configuration register	0x05	<a href="#">Section 7.1.1.30</a>
0x24	PASI_TX_CH7_CFG	PASI TX Channel 7 configuration register	0x06	<a href="#">Section 7.1.1.31</a>
0x25	PASI_TX_CH8_CFG	PASI TX Channel 8 configuration register	0x07	<a href="#">Section 7.1.1.32</a>
0x26	PASI_RX_CFG0	PASI RX configuration register 0	0x00	<a href="#">Section 7.1.1.33</a>
0x32	CLK_CFG0	Clock configuration register 0	0x00	<a href="#">Section 7.1.1.34</a>
0x33	CLK_CFG1	Clock configuration register 1	0x00	<a href="#">Section 7.1.1.35</a>
0x34	CLK_CFG2	Clock configuration register 2	0x40	<a href="#">Section 7.1.1.36</a>
0x35	CNT_CLK_CFG0	Controller mode clock configuration register 0	0x00	<a href="#">Section 7.1.1.37</a>
0x36	CNT_CLK_CFG1	Controller mode clock configuration register 1	0x00	<a href="#">Section 7.1.1.38</a>
0x37	CNT_CLK_CFG2	Controller mode clock configuration register 2	0x20	<a href="#">Section 7.1.1.39</a>
0x38	CNT_CLK_CFG3	Controller mode clock configuration register 3	0x00	<a href="#">Section 7.1.1.40</a>
0x39	CNT_CLK_CFG4	Controller mode clock configuration register 4	0x00	<a href="#">Section 7.1.1.41</a>

**Table 7-2. TAA5412-Q1\_B0\_P0 Registers (continued)**

Address	Acronym	Register Name	Reset Value	Section
0x3A	CNT_CLK_CFG5	Controller mode clock configuration register 5	0x00	<a href="#">Section 7.1.1.42</a>
0x3B	CNT_CLK_CFG6	Controller mode clock configuration register 6	0x00	<a href="#">Section 7.1.1.43</a>
0x3C	CLK_ERR_STS0	Clock error and status register 0	0x00	<a href="#">Section 7.1.1.44</a>
0x3D	CLK_ERR_STS1	Clock error and status register 1	0x00	<a href="#">Section 7.1.1.45</a>
0x3E	CLK_DET_STS0	Clock ratio detection register 0	0x00	<a href="#">Section 7.1.1.46</a>
0x3F	CLK_DET_STS1	Clock ratio detection register 1	0x00	<a href="#">Section 7.1.1.47</a>
0x40	CLK_DET_STS2	Clock ratio detection register 2	0x00	<a href="#">Section 7.1.1.48</a>
0x41	CLK_DET_STS3	Clock ratio detection register 3	0x00	<a href="#">Section 7.1.1.49</a>
0x42	INT_CFG	Interrupt configuration register	0x00	<a href="#">Section 7.1.1.50</a>
0x4B	ADC_DAC_MISC_CFG	ADC overload response configuration register	0x00	<a href="#">Section 7.1.1.51</a>
0x4E	PWR_TUNE_CFG0	Power tune configuration register 0	0x00	<a href="#">Section 7.1.1.52</a>
0x50	ADC_CH1_CFG0	ADC Channel 1 configuration register 0	0x00	<a href="#">Section 7.1.1.53</a>
0x52	ADC_CH1_CFG2	ADC Channel 1 configuration register 2	0xA1	<a href="#">Section 7.1.1.54</a>
0x53	ADC_CH1_CFG3	ADC Channel 1 configuration register 3	0x80	<a href="#">Section 7.1.1.55</a>
0x54	ADC_CH1_CFG4	ADC Channel 1 configuration register 4	0x00	<a href="#">Section 7.1.1.56</a>
0x55	ADC_CH2_CFG0	ADC Channel 2 configuration register 0	0x00	<a href="#">Section 7.1.1.57</a>
0x57	ADC_CH2_CFG2	Channel 2 configuration register 2	0xA1	<a href="#">Section 7.1.1.58</a>
0x58	ADC_CH2_CFG3	ADC Channel 2 configuration register 3	0x80	<a href="#">Section 7.1.1.59</a>
0x59	ADC_CH2_CFG4	ADC Channel 2 configuration register 4	0x00	<a href="#">Section 7.1.1.60</a>
0x5A	ADC_CH3_CFG0	ADC Channel 3 configuration register 0	0x00	<a href="#">Section 7.1.1.61</a>
0x5B	ADC_CH3_CFG2	ADC Channel 3 configuration register 2	0xA1	<a href="#">Section 7.1.1.62</a>
0x5C	ADC_CH3_CFG3	ADC Channel 3 configuration register 3	0x80	<a href="#">Section 7.1.1.63</a>
0x5D	ADC_CH3_CFG4	ADC Channel 3 configuration register 4	0x00	<a href="#">Section 7.1.1.64</a>
0x5E	ADC_CH4_CFG0	ADC Channel 4 configuration register 0	0x00	<a href="#">Section 7.1.1.65</a>
0x5F	ADC_CH4_CFG2	Channel 4 configuration register 2	0xA1	<a href="#">Section 7.1.1.66</a>
0x60	ADC_CH4_CFG3	ADC Channel 4 configuration register 3	0x80	<a href="#">Section 7.1.1.67</a>
0x61	ADC_CH4_CFG4	ADC Channel 4 configuration register 4	0x00	<a href="#">Section 7.1.1.68</a>
0x72	DSP_CFG0	DSP configuration register 0	0x18	<a href="#">Section 7.1.1.69</a>
0x76	CH_EN	Channel enable configuration register	0xCC	<a href="#">Section 7.1.1.70</a>
0x77	DYN_PUPD_CFG	Power up configuration register	0x00	<a href="#">Section 7.1.1.71</a>
0x78	PWR_CFG	Power up configuration register	0x00	<a href="#">Section 7.1.1.72</a>
0x79	DEV_STS0	Device status value register 0	0x00	<a href="#">Section 7.1.1.73</a>
0x7A	DEV_STS1	Device status value register 1	0x80	<a href="#">Section 7.1.1.74</a>
0x7E	I2C_CKSUM	I <sup>2</sup> C checksum register	0x00	<a href="#">Section 7.1.1.75</a>

### 7.1.1.1 PAGE\_CFG Register (Address = 0x0) [Reset = 0x00]

PAGE\_CFG is shown in [Table 7-3](#).

Return to the [Summary Table](#).

The device memory map is divided into pages. This register sets the page.

**Table 7-3. PAGE\_CFG Register Field Descriptions**

Bit	Field	Type	Reset	Description
7-0	PAGE[7:0]	R/W	00000000b	These bits set the device page. 0d = Page 0 1d = Page 1 2d to 254d = Page 2 to page 254 respectively 255d = Page 255

**7.1.1.2 SW\_RESET Register (Address = 0x1) [Reset = 0x00]**

SW\_RESET is shown in [Table 7-4](#).

Return to the [Summary Table](#).

This register is the software reset register. Asserting a software reset places all register values in their default power-on-reset (POR) state.

**Table 7-4. SW\_RESET Register Field Descriptions**

Bit	Field	Type	Reset	Description
7-1	RESERVED	R	0b	Reserved bits; Write only reset value
0	SW_RESET	R/W	0b	Software reset. This bit is self clearing. 0d = Do not reset 1d = Reset all registers to their reset values

**7.1.1.3 DEV\_MISC\_CFG Register (Address = 0x2) [Reset = 0x00]**

DEV\_MISC\_CFG is shown in [Table 7-5](#).

Return to the [Summary Table](#).

This register configures miscellaneous device registers.

**Table 7-5. DEV\_MISC\_CFG Register Field Descriptions**

Bit	Field	Type	Reset	Description
7-6	RESERVED	R	0b	Reserved bits; Write only reset values
5-4	VREF_QCHG[1:0]	R/W	00b	The duration of the quick-charge for the VREF external capacitor is set using an internal series impedance of 200 andx3A9;#. 0d = VREF quick-charge duration of 3.5 ms (typical) 1d = VREF quick-charge duration of 10 ms (typical) 2d = VREF quick-charge duration of 50 ms (typical) 3d = VREF quick-charge duration of 100 ms (typical)
3	SLEEP_EXIT_VREF_EN	R/W	0b	Sleep mode exit configuration 0d = Only DREG Enabled 1d = DREG and VREF enabled
2	RESERVED	R	0b	Reserved bit; Write only reset value
1	IOVDD_IO_MODE	R/W	0b	IOVDD mode configuration. 0d = IOVDD at 3.3V / 1.8V / 1.2V (speed limitation applicable for 1.8V and 1.2V Operation) 1d = IOVDD at 1.8V / 1.2V only (no speed limitation - Strictly don't use this setting for IOVDD 3.3V Operation).
0	SLEEP_ENZ	R/W	0b	Sleep mode setting. 0d = Device is in sleep mode 1d = Device is not in sleep mode

**7.1.1.4 AVDD\_IOVDD\_STS Register (Address = 0x3) [Reset = 0x00]**

AVDD\_IOVDD\_STS is shown in [Table 7-6](#).

Return to the [Summary Table](#).

This register contains status of the supply detection and brown-out.

**Table 7-6. AVDD\_IOVDD\_STS Register Field Descriptions**

Bit	Field	Type	Reset	Description
7	RESERVED	R	0b	Reserved bit; Write only reset value
6	IOVDD_IO_MODE_STS	R	0b	IOVDD mode status flag register. 0d = IOVDD_MODE as per configured 1d = IOVDD 3.3V Operation (IOVDD_IO_MODE forced to 0d)
5-2	RESERVED	R	0b	Reserved bits; Write only reset values
1	RESERVED	R	0b	Reserved bit; Write only reset value
0	RESERVED	R	0b	Reserved bit; Write only reset value

#### 7.1.1.5 MISC\_CFG Register (Address = 0x4) [Reset = 0x00]

MISC\_CFG is shown in [Table 7-7](#).

Return to the [Summary Table](#).

This register configures miscellaneous configuration registers.

**Table 7-7. MISC\_CFG Register Field Descriptions**

Bit	Field	Type	Reset	Description
7	RESERVED	R	0b	Reserved bit; Write only reset value
6	IGNORE_CLK_ERR	R/W	0b	Clock error detection action 0b = Clock error enabled 1b = Clock error disabled
5	RESERVED	R	0b	Reserved bit; Write only reset value
4	RESERVED	R	0b	Reserved bit; Write only reset value
3	RESERVED	R	0b	Reserved bit; Write only reset value
2	RESERVED	R	0b	Reserved bit; Write only reset value
1	I2C_BRDCAST_EN	R/W	0b	I <sup>2</sup> C broadcast addressing setting. 0d = I <sup>2</sup> C broadcast mode disabled 1d = I <sup>2</sup> C broadcast mode enabled; the I <sup>2</sup> C target address is fixed with pin-controlled LSB bits as '0'
0	RESERVED	R	0b	Reserved bit; Write only reset value

#### 7.1.1.6 MISC\_CFG1 Register (Address = 0x5) [Reset = 0x15]

MISC\_CFG1 is shown in [Table 7-8](#).

Return to the [Summary Table](#).

This register configures the miscellaneous configuration register 1.

**Table 7-8. MISC\_CFG1 Register Field Descriptions**

Bit	Field	Type	Reset	Description
7-6	INCAP_QCHG[1:0]	R/W	00b	The duration of the quick-charge for the external AC-coupling capacitor is set using an internal series impedance of 800 and x3A9;#. 0d = INxP, INxM quick-charge duration of 2.5 ms (typical) 1d = INxP, INxM quick-charge duration of 12.5 ms (typical) 2d = INxP, INxM quick-charge duration of 25 ms (typical) 3d = INxP, INxM quick-charge duration of 50 ms (typical)

**Table 7-8. MISC\_CFG1 Register Field Descriptions (continued)**

Bit	Field	Type	Reset	Description
5-4	SHDN_CFG[1:0]	R/W	01b	Shutdown configuration. 0d = DREG is powered down immediately after IOVDD is deasserted 1d = DREG remains active to enable a clean shut down until a time-out (DREG_KA_TIME) is reached; after the time-out period, DREG is forced to power off 2d = DREG remains active until the device cleanly shuts down 3d = Reserved; Don't use
3-2	DREG_KA_TIME[1:0]	R/W	01b	These bits set how long DREG remains active after IOVDD is deasserted. 0d = DREG remains active for 30 ms (typical) 1d = DREG remains active for 25 ms (typical) 2d = DREG remains active for 10 ms (typical) 3d = DREG remains active for 5 ms (typical)
1-0	RESERVED	R	0b	Reserved bits; Write only reset values

**7.1.1.7 MISC\_CFG0 Register (Address = 0x7) [Reset = 0x00]**

MISC\_CFG0 is shown in [Table 7-9](#).

Return to the [Summary Table](#).

This register configures the miscellaneous configuration register 0.

**Table 7-9. MISC\_CFG0 Register Field Descriptions**

Bit	Field	Type	Reset	Description
7	RESERVED	R	0b	Reserved bit; Write only reset value
6	RESERVED	R	0b	Reserved bit; Write only reset value
5	RESERVED	R	0b	Reserved bit; Write only reset value
4	HW_RESET_ON_CLK_S TOP_EN	R/W	0b	Assertion of Hard Reset when clock selected by CLK_SRC_SEL is not available for 2ms config 0d = disable 1d = enable
3-0	RESERVED	R	0b	Reserved bits; Write only reset values

**7.1.1.8 GPIO1\_CFG0 Register (Address = 0xA) [Reset = 0x32]**

GPIO1\_CFG0 is shown in [Table 7-10](#).

Return to the [Summary Table](#).

This register is the GPIO1 configuration register 0.



**Table 7-10. GPIO1\_CFG0 Register Field Descriptions**

Bit	Field	Type	Reset	Description
7-4	GPIO1_CFG[3:0]	R/W	0011b	GPIO1 configuration. 0d = GPIO1 is disabled 1d = GPIO1 is configured as a general-purpose input (GPI) or any other input function 2d = GPIO1 is configured as a general-purpose output (GPO) 3d = GPIO1 is configured as a chip interrupt output (IRQ) 4d = GPIO1 is configured as a PDM clock output (PDMCLK) 5d = GPIO1 is configured as primary ASI DOUT 6d = GPIO1 is configured as primary ASI DOUT2 7d = GPIO1 is configured as secondary ASI DOUT 8d = GPIO1 is configured as secondary ASI DOUT2 9d = GPIO1 is configured as secondary ASI BCLK output 10d = GPIO1 is configured as secondary ASI FSYNC output 11d = GPIO1 is configured as general purpose CLKOUT 12d = GPIO1 is configured as PASI DOUT and SASI DOUT muxed 13d = GPIO1 is configured as DAISY_OUT for DIN Daisy 14d to 15d = Reserved
3	RESERVED	R	0b	Reserved bit; Write only reset value
2-0	GPIO1_DRV[2:0]	R/W	010b	GPIO1 output drive configuration. (Not valid if GPIO1_CFG configured as I <sup>2</sup> S out) 0d = Hi-Z output 1d = Drive active low and active high 2d = Drive active low and weak high 3d = Drive active low and Hi-Z 4d = Drive weak low and active high 5d = Drive Hi-Z and active high 6d to 7d = Reserved; Don't use

### 7.1.1.9 GPO1A\_CFG0 Register (Address = 0xC) [Reset = 0x00]

GPO1A\_CFG0 is shown in [Table 7-11](#).

Return to the [Summary Table](#).

This register is the GPO1A configuration register 0.

**Table 7-11. GPO1A\_CFG0 Register Field Descriptions**

Bit	Field	Type	Reset	Description
7-4	GPO1A_CFG[3:0]	R/W	0000b	GPO1A configuration. (Max frequency is limited to 6MHz. For SPI mode, this pin act as POCI and the below configuration settings are not applicable) (Always buskeeper en is not supported when used as DOUT) 0d = GPO1A is disabled 1d = Reserved 2d = GPO1A is configured as a general-purpose output (GPO) 3d = GPO1A is configured as a chip interrupt output (IRQ) 4d = GPO1A is configured as a PDM clock output (PDMCLK) 5d = GPO1A is configured as primary ASI DOUT 6d = GPO1A is configured as primary ASI DOUT2 7d = GPO1A is configured as secondary ASI DOUT 8d = GPO1A is configured as secondary ASI DOUT2 9d = GPO1A is configured as secondary ASI BCLK output 10d = GPO1A is configured as secondary ASI FSYNC output 11d = GPO1A is configured as general purpose CLKOUT 12d = GPO1A is configured as PASI DOUT and SASI DOUT muxed 13d = GPO1A is configured as DAISY_OUT for DIN Daisy 14d to 15d = Reserved
3	SPI_POCI_CFG	R/W	0b	SPI POCI configuration. 0d = GPO1A pin act as SPI POCI output (Max frequency limited to 6MHz) and GPO1A_CFG and GPO1A_DRV settings are ignored. 0d = GPIO1 pin act as SPI POCI output for high speed use case and GPIO1_CFG and GPIO1_DRV settings are ignored.

**Table 7-11. GPO1A\_CFG0 Register Field Descriptions (continued)**

Bit	Field	Type	Reset	Description
2-0	GPO1A_DRV[2:0]	R/W	000b	GPO1A output drive configuration. (Not valid if GPO1A_CFG configured as I <sup>2</sup> S out) (Max frequency is limited to 6MHz. For SPI mode, this pin act as POC1 and the below configuration settings are not applicable) 0d = Hi-Z output 1d = Drive active low and active high 2d = Drive active low and weak high 3d = Drive active low and Hi-Z 4d = Drive weak low and active high 5d = Drive Hi-Z and active high 6d to 7d = Reserved; Don't use

**7.1.1.10 GPI\_CFG Register (Address = 0xD) [Reset = 0x00]**

GPI\_CFG is shown in [Table 7-12](#).

Return to the [Summary Table](#).

This register is the GPI configuration register 0.

**Table 7-12. GPI\_CFG Register Field Descriptions**

Bit	Field	Type	Reset	Description
7-2	RESERVED	R	0b	Reserved bits; Write only reset values
1	GPI1A_CFG	R/W	0b	GPI1A configuration. 0d = GPI1A is disabled 1d = GPI1A is configured as a general-purpose input (GPI) or any other input function
0	GPI2A_CFG	R/W	0b	GPI2A configuration. 0d = GPI2A is disabled 1d = GPI2A is configured as a general-purpose input (GPI) or any other input function

**7.1.1.11 GPO\_GPI\_VAL Register (Address = 0xE) [Reset = 0x00]**

GPO\_GPI\_VAL is shown in [Table 7-13](#).

Return to the [Summary Table](#).

This register is the GPIO and GPO output value register.

**Table 7-13. GPO\_GPI\_VAL Register Field Descriptions**

Bit	Field	Type	Reset	Description
7	GPIO1_VAL	R/W	0b	GPIO1 output value when configured as a GPO. 0d = Drive the output with a value of 0 1d = Drive the output with a value of 1
6	RESERVED	R	0b	Reserved bit; Write only reset value
5	GPO1A_VAL	R/W	0b	GPO1A output value when configured as a GPO. 0d = Drive the output with a value of 0 1d = Drive the output with a value of 1
4	RESERVED	R	0b	Reserved bit; Write only reset value
3	GPIO1_MON	R	0b	GPIO1 monitor value when configured as a GPI. 0d = Input monitor value 0 1d = Input monitor value 1
2	GPI2A_MON	R	0b	GPI2A monitor value when configured as a GPI. 0d = Input monitor value 0 1d = Input monitor value 1

**Table 7-13. GPO\_GPI\_VAL Register Field Descriptions (continued)**

Bit	Field	Type	Reset	Description
1	GPI1A_MON	R	0b	GPI1A monitor value when configured as a GPI. 0d = Input monitor value 0 1d = Input monitor value 1
0	RESERVED	R	0b	Reserved bit; Write only reset value

#### 7.1.1.12 INTF\_CFG0 Register (Address = 0xF) [Reset = 0x00]

INTF\_CFG0 is shown in [Table 7-14](#).

Return to the [Summary Table](#).

This register is the interface configuration register 0.

**Table 7-14. INTF\_CFG0 Register Field Descriptions**

Bit	Field	Type	Reset	Description
7	RESERVED	R	0b	Reserved bit; Write only reset value
6-5	CCLK_SEL[1:0]	R/W	00b	CCLK select configuration. 0d = CCLK is disabled 1d = GPIO1 2d = GPI2A 3d = GPI1A
4-2	PASI_DIN2_SEL[2:0]	R/W	000b	Primary ASI DIN2 select configuration. 0d = Primary ASI DIN2 is disabled 1d = GPIO1 2d = GPI2A 3d = GPI1A 4d = DOUT 5d = Primary ASI DIN 6d to 7d = Reserved
1	PASI_BCLK_SEL	R/W	0b	Primary ASI BCLK select configuration. 0d = Primary ASI BCLK is BCLK 1d = Primary ASI BCLK is Secondary ASI BCLK
0	PASI_FSYNC_SEL	R/W	0b	Primary ASI FSYNC select configuration. 0d = Primary ASI FSYNC is FSYNC 1d = Primary ASI FSYNC is Secondary ASI FSYNC

#### 7.1.1.13 INTF\_CFG1 Register (Address = 0x10) [Reset = 0x52]

INTF\_CFG1 is shown in [Table 7-15](#).

Return to the [Summary Table](#).

This register is the interface configuration register 1.

**Table 7-15. INTF\_CFG1 Register Field Descriptions**

Bit	Field	Type	Reset	Description
7-4	DOUT_SEL[3:0]	R/W	0101b	DOUT select configuration. 0d = DOUT is disabled 1d = DOUT is configured as input 2d = DOUT is configured as a general-purpose output (GPO) 3d = DOUT is configured as a chip interrupt output (IRQ) 4d = DOUT is configured as a PDM clock output (PDMCLK) 5d = DOUT is configured as primary ASI DOUT 6d = DOUT is configured as primary ASI DOUT2 7d = DOUT is configured as secondary ASI DOUT 8d = DOUT is configured as secondary ASI DOUT2 9d = DOUT is configured as secondary ASI BCLK output 10d = DOUT is configured as secondary ASI FSYNC output 11d = DOUT is configured as general purpose CLKOUT 12d = DOUT is configured as PASI DOUT and SASI DOUT muxed 13d = DOUT is configured as DAISY_OUT for DIN Daisy 14d = DOUT is configured as DIN(LOOPBACK) 15d = Reserved
3	DOUT_VAL	R/W	0b	DOUT output value when configured as a GPO. 0d = Drive the output with a value of 0 1d = Drive the output with a value of 1
2-0	DOUT_DRV[2:0]	R/W	010b	DOUT output drive configuration. 0d = Hi-Z output 1d = Drive active low and active high 2d = Drive active low and weak high 3d = Drive active low and Hi-Z 4d = Drive weak low and active high 5d = Drive Hi-Z and active high 6d to 7d = Reserved; Don't use

**7.1.1.14 INTF\_CFG2 Register (Address = 0x11) [Reset = 0x80]**

INTF\_CFG2 is shown in [Table 7-16](#).

Return to the [Summary Table](#).

This register is the interface configuration register 2.

**Table 7-16. INTF\_CFG2 Register Field Descriptions**

Bit	Field	Type	Reset	Description
7	PASI_DIN_EN	R/W	1b	Primary ASI DIN enable configuration. 0d = Primary ASI DIN is disabled 1d = Primary ASI DIN is enabled
6-4	SASI_FSYNC_SEL[2:0]	R/W	000b	Secondary ASI FSYNC select configuration. 0d = Secondary ASI disabled 1d = GPIO1 2d = GPI2A 3d = GPI1A 4d = Reserved 5d = Primary ASI FSYNC 6d to 7d = Reserved
3-1	SASI_BCLK_SEL[2:0]	R/W	000b	Secondary ASI BCLK select configuration. 0d = Secondary ASI disabled 1d = GPIO1 2d = GPI2A 3d = GPI1A 4d = Reserved 5d = Primary ASI BCLK 6d to 7d = Reserved
0	RESERVED	R	0b	Reserved bit; Write only reset value

### 7.1.1.15 INTF\_CFG3 Register (Address = 0x12) [Reset = 0x00]

INTF\_CFG3 is shown in [Table 7-17](#).

Return to the [Summary Table](#).

This register is the interface configuration register 3.

**Table 7-17. INTF\_CFG3 Register Field Descriptions**

Bit	Field	Type	Reset	Description
7-5	SASI_DIN_SEL[2:0]	R/W	000b	Secondary ASI DIN select configuration. 0d = Secondary ASI DIN is disabled 1d = GPIO1 2d = GPI2A 3d = GPI1A 4d = DOUT 5d = Primary ASI DIN 6d to 7d = Reserved
4-2	SASI_DIN2_SEL[2:0]	R/W	000b	Secondary ASI DIN2 select configuration. 0d = Secondary ASI DIN2 is disabled 1d = GPIO1 2d = GPI2A 3d = GPI1A 4d = DOUT 5d = Primary ASI DIN 6d to 7d = Reserved
1-0	RESERVED	R	0b	Reserved bits; Write only reset values

### 7.1.1.16 INTF\_CFG4 Register (Address = 0x13) [Reset = 0x00]

INTF\_CFG4 is shown in [Table 7-18](#).

Return to the [Summary Table](#).

This register is the interface configuration register 4.

**Table 7-18. INTF\_CFG4 Register Field Descriptions**

Bit	Field	Type	Reset	Description
7	PDM_CH1_SEL	R/W	0b	PDM select configuration for channel 1 of record path. 0d = Channel 1 is analog (ADC) type on the record path 1d = Channel 1 is digital (PDM) type on the record path
6	PDM_CH2_SEL	R/W	0b	PDM select configuration for channel 2 of record path. 0d = Channel 2 is analog (ADC) type on the record path 1d = Channel 2 is digital (PDM) type on the record path
5	PDMDIN1_EDGE	R/W	0b	PDMCLK latching edge used for channel 1 and channel 2 data. 0d = Channel 1 data are latched on the negative edge, channel 2 data are latched on the positive edge 1d = Channel 1 data are latched on the positive edge, channel 2 data are latched on the negative edge
4	PDMDIN2_EDGE	R/W	0b	PDMCLK latching edge used for channel 3 and channel 4 data. 0d = Channel 3 data are latched on the negative edge, channel 4 data are latched on the positive edge 1d = Channel 3 data are latched on the positive edge, channel 4 data are latched on the negative edge
3-2	PDM_DIN1_SEL[1:0]	R/W	00b	PDM data channels 1 and 2 select configuration. 0d = PDM data channels 1 and 2 are disabled 1d = GPIO1 2d = GPI2A 3d = GPI1A

**Table 7-18. INTF\_CFG4 Register Field Descriptions (continued)**

Bit	Field	Type	Reset	Description
1-0	PDM_DIN2_SEL[1:0]	R/W	00b	PDM data channels 3 and 4 select configuration. 0d = PDM data channels 3 and 4 are disabled 1d = GPIO1 2d = GPI2A 3d = GPI1A

**7.1.1.17 INTF\_CFG5 Register (Address = 0x14) [Reset = 0x00]**

INTF\_CFG5 is shown in [Table 7-19](#).

Return to the [Summary Table](#).

This register is the interface configuration register 5.

**Table 7-19. INTF\_CFG5 Register Field Descriptions**

Bit	Field	Type	Reset	Description
7	PDM_DIN_SEL_OVRD	R/W	0b	PDM data channels (1 and 2)/(3 and 4) select configuration override. 0d = No Override 1d = PDM_DIN1/2_SEL if configured as GPI1A will be overridden as DIN
6	DOOUT_WITH_DIN	R/W	0b	DOOUT used as both ASI OUT and ASI IN 0d = DOOUT based on DOOUT_SEL 1d = DOOUT used as both ASI OUT and ASI DIN
5-4	PD_ADC_GPIO[1:0]	R/W	00b	Power down ADC using GPIO select configuration.(ADC powered down if any one of the PD_ADC_GPIO/ADC_PDZ is configured power down) 0d = Power down ADC using GPIO is disabled 1d = Power down ADC using GPIO1 2d = Power down ADC using GPI2A 3d = Power down ADC using GPI1A
3-2	RESERVED	R	0b	Reserved bits; Write only reset values
1	RESERVED	R	0b	Reserved bit; Write only reset value
0	GPA_GPIO	R/W	0b	GPA using GPIO1 configuration. 0d = GPA using GPIO1 is disabled 1d = GPA using GPIO1

**7.1.1.18 INTF\_CFG6 Register (Address = 0x15) [Reset = 0x00]**

INTF\_CFG6 is shown in [Table 7-20](#).

Return to the [Summary Table](#).

This register is the interface configuration register 6.

**Table 7-20. INTF\_CFG6 Register Field Descriptions**

Bit	Field	Type	Reset	Description
7-6	EN_MBIAS_GPIO[1:0]	R/W	00b	Enable MICBIAS using GPIO select configuration. 0d = Enable MICBIAS using GPIO is disabled 1d = Enable MICBIAS using GPIO1 2d = Enable MICBIAS using GPI2A 3d = Enable MICBIAS using GPI1A
5-4	RESERVED	R	0b	Reserved bits; Write only reset values
3-0	RESERVED	R	0b	Reserved bits; Write only reset value

### 7.1.1.19 ASI\_CFG0 Register (Address = 0x18) [Reset = 0x40]

ASI\_CFG0 is shown in [Table 7-21](#).

Return to the [Summary Table](#).

This register is the ASI configuration register 0.

**Table 7-21. ASI\_CFG0 Register Field Descriptions**

Bit	Field	Type	Reset	Description
7	PASI_DIS	R/W	0b	Disable or enable primary ASI (PASI). 0d = Primary ASI enabled 1d = Primary ASI disabled
6	SASI_DIS	R/W	1b	Disable or enable secondary ASI (SASI). 0d = Secondary ASI enabled 1d = Secondary ASI disabled
5	SASI_CFG_GANG	R/W	0b	All configurations of secondary ASI ganged with primary ASI. 0d = Secondary ASI has independent configurations 1d = Secondary ASI configurations same as primary ASI
4-3	DAISY_EN[1:0]	R/W	00b	Daisy chain feature enable (Only 1 ASI with 1 DOUT AND DIN available) 0d = Daisy chain disabled 1d = PASI daisy chain enabled (Secondary ASI not available) 2d = SASI daisy chain enabled (Primary ASI not available) 3d = Reserved; Don't use
2-0	DAISY_IN_SEL[2:0]	R/W	000b	Daisy input select configuration. 0d = Daisy input disabled 1d = GPIO1 2d = GPI2A 3d = GPI1A 4d = Reserved 5d = DIN 6d to 7d = Reserved

### 7.1.1.20 ASI\_CFG1 Register (Address = 0x19) [Reset = 0x00]

ASI\_CFG1 is shown in [Table 7-22](#).

Return to the [Summary Table](#).

This register is the ASI configuration register 1.

**Table 7-22. ASI\_CFG1 Register Field Descriptions**

Bit	Field	Type	Reset	Description
7-6	ASI_DOUT_CFG[1:0]	R/W	00b	ASI data output configuration. 0d = 1 data output for Primary ASI and 1 data output for Secondary ASI 1d = 2 data outputs for Primary ASI 2d = 2 data outputs for Secondary ASI 3d = Reserved; Don't use
5-4	ASI_DIN_CFG[1:0]	R/W	00b	ASI data input configuration. 0d = 1 data input for Primary ASI and 1 data input for Secondary ASI 1d = 2 data inputs for Primary ASI 2d = 2 data inputs for Secondary ASI 3d = Reserved; Don't use
3	DAISY_DIR	R/W	0b	Daisy direction configuration. 0d = ASI DOUT daisy 1d = ASI DIN daisy
2	RESERVED	R	0b	Reserved bit; Write only reset value
1	RESERVED	R	0b	Reserved bit; Write only reset value
0	RESERVED	R	0b	Reserved bit; Write only reset value

### 7.1.1.21 PASI\_CFG0 Register (Address = 0x1A) [Reset = 0x30]

PASI\_CFG0 is shown in [Table 7-23](#).

Return to the [Summary Table](#).

This register is the ASI configuration register 0.

**Table 7-23. PASI\_CFG0 Register Field Descriptions**

Bit	Field	Type	Reset	Description
7-6	PASI_FORMAT[1:0]	R/W	00b	Primary ASI protocol format. 0d = TDM mode 1d = I <sup>2</sup> S mode 2d = LJ (left-justified) mode 3d = Reserved; Don't use
5-4	PASI_WLEN[1:0]	R/W	11b	Primary ASI word or slot length. 0d = 16 bits (Recommended this setting to be used with 10kandx3A9:# input impedance configuration) 1d = 20 bits 2d = 24 bits 3d = 32 bits
3	PASI_FSYNC_POL	R/W	0b	ASI FSYNC polarity (for PASI protocol only). 0d = Default polarity as per standard protocol 1d = Inverted polarity with respect to standard protocol
2	PASI_BCLK_POL	R/W	0b	ASI BCLK polarity (for PASI protocol only). 0d = Default polarity as per standard protocol 1d = Inverted polarity with respect to standard protocol
1	PASI_BUS_ERR	R/W	0b	ASI bus error detection. 0d = Enable bus error detection 1d = Disable bus error detection
0	PASI_BUS_ERR_RCOV	R/W	0b	ASI bus error auto resume. 0d = Enable auto resume after bus error recovery 1d = Disable auto resume after bus error recovery and remain powered down until host configures the device

### 7.1.1.22 PASI\_TX\_CFG0 Register (Address = 0x1B) [Reset = 0x00]

PASI\_TX\_CFG0 is shown in [Table 7-24](#).

Return to the [Summary Table](#).

This register is the PASI TX configuration register 0.

**Table 7-24. PASI\_TX\_CFG0 Register Field Descriptions**

Bit	Field	Type	Reset	Description
7	PASI_TX_EDGE	R/W	0b	Primary ASI data output (on the primary and secondary data pin) transmit edge. 0d = Default edge as per the protocol configuration setting in PASI_BCLK_POL 1d = Inverted following edge (half cycle delay) with respect to the default edge setting
6	PASI_TX_FILL	R/W	0b	Primary ASI data output (on the primary and secondary data pin) for any unused cycles 0d = Always transmit 0 for unused cycles 1d = Always use Hi-Z for unused cycles
5	PASI_TX_LSB	R/W	0b	Primary ASI data output (on the primary and secondary data pin) for LSB transmissions. 0d = Transmit the LSB for a full cycle 1d = Transmit the LSB for the first half cycle and Hi-Z for the second half cycle



**Table 7-24. PASI\_TX\_CFG0 Register Field Descriptions (continued)**

Bit	Field	Type	Reset	Description
4-3	PASI_TX_KEEPER[1:0]	R/W	00b	Primary ASI data output (on the primary and secondary data pin) bus keeper. 0d = Bus keeper is always disabled 1d = Bus keeper is always enabled 2d = Bus keeper is enabled during LSB transmissions only for one cycle 3d = Bus keeper is enabled during LSB transmissions only for one and half cycles
2	PASI_TX_USE_INT_FSYNC	R/W	0b	Primary ASI uses internal FSYNC for output data generation in Controller mode configuration as applicable. 0d = Use external FSYNC for ASI protocol data generation 1d = Use internal FSYNC for ASI protocol data generation
1	PASI_TX_USE_INT_BCLK	R/W	0b	Primary ASI uses internal BCLK for output data generation in Controller mode configuration. 0d = Use external BCLK for ASI protocol data generation 1d = Use internal BCLK for ASI protocol data generation
0	PASI_TDM_PULSE_WIDTH	R/W	0b	Primary ASI fsync pulse width in TDM format. (Valid for Controller mode) 0d = Fsync pulse is 1 bclk period wide 1d = Fsync pulse is 2 bclk period wide

#### 7.1.1.23 PASI\_TX\_CFG1 Register (Address = 0x1C) [Reset = 0x00]

PASI\_TX\_CFG1 is shown in [Table 7-25](#).

Return to the [Summary Table](#).

This register is the PASI TX configuration register 1.

**Table 7-25. PASI\_TX\_CFG1 Register Field Descriptions**

Bit	Field	Type	Reset	Description
7-5	RESERVED	R	0b	Reserved bits; Write only reset values
4-0	PASI_TX_OFFSET[4:0]	R/W	00000b	Primary ASI output data MSB slot 0 offset (on the primary and secondary data pin). 0d = ASI data MSB location has no offset and is as per standard protocol 1d = ASI data MSB location (TDM mode is slot 0 or I <sup>2</sup> S, LJ mode is the left and right slot 0) offset of one BCLK cycle with respect to standard protocol 2d = ASI data MSB location (TDM mode is slot 0 or I <sup>2</sup> S, LJ mode is the left and right slot 0) offset of two BCLK cycles with respect to standard protocol 3d to 30d = ASI data MSB location (TDM mode is slot 0 or I <sup>2</sup> S, LJ mode is the left and right slot 0) offset assigned as per configuration 31d = ASI data MSB location (TDM mode is slot 0 or I <sup>2</sup> S, LJ mode is the left and right slot 0) offset of 31 BCLK cycles with respect to standard protocol

#### 7.1.1.24 PASI\_TX\_CFG2 Register (Address = 0x1D) [Reset = 0x00]

PASI\_TX\_CFG2 is shown in [Table 7-26](#).

Return to the [Summary Table](#).

This register is the PASI TX configuration register 2.

**Table 7-26. PASI\_TX\_CFG2 Register Field Descriptions**

Bit	Field	Type	Reset	Description
7	PASI_TX_CH8_SEL	R/W	0b	Primary ASI output channel 8 select. 0d = Primary ASI channel 8 output is on DOUT 1d = Primary ASI channel 8 output is on DOUT2
6	PASI_TX_CH7_SEL	R/W	0b	Primary ASI output channel 7 select. 0d = Primary ASI channel 7 output is on DOUT 1d = Primary ASI channel 7 output is on DOUT2
5	PASI_TX_CH6_SEL	R/W	0b	Primary ASI output channel 6 select. 0d = Primary ASI channel 6 output is on DOUT 1d = Primary ASI channel 6 output is on DOUT2
4	PASI_TX_CH5_SEL	R/W	0b	Primary ASI output channel 5 select. 0d = Primary ASI channel 5 output is on DOUT 1d = Primary ASI channel 5 output is on DOUT2
3	PASI_TX_CH4_SEL	R/W	0b	Primary ASI output channel 4 select. 0d = Primary ASI channel 4 output is on DOUT 1d = Primary ASI channel 4 output is on DOUT2
2	PASI_TX_CH3_SEL	R/W	0b	Primary ASI output channel 3 select. 0d = Primary ASI channel 3 output is on DOUT 1d = Primary ASI channel 3 output is on DOUT2
1	PASI_TX_CH2_SEL	R/W	0b	Primary ASI output channel 2 select. 0d = Primary ASI channel 2 output is on DOUT 1d = Primary ASI channel 2 output is on DOUT2
0	PASI_TX_CH1_SEL	R/W	0b	Primary ASI output channel 1 select. 0d = Primary ASI channel 1 output is on DOUT 1d = Primary ASI channel 1 output is on DOUT2

**7.1.1.25 PASI\_TX\_CH1\_CFG Register (Address = 0x1E) [Reset = 0x20]**

PASI\_TX\_CH1\_CFG is shown in [Table 7-27](#).

Return to the [Summary Table](#).

This register is the PASI TX Channel 1 configuration register.

**Table 7-27. PASI\_TX\_CH1\_CFG Register Field Descriptions**

Bit	Field	Type	Reset	Description
7-6	RESERVED	R	0b	Reserved bits; Write only reset values
5	PASI_TX_CH1_CFG	R/W	1b	Primary ASI output channel 1 configuration. 0d = Primary ASI channel 1 output is in a tri-state condition 1d = Primary ASI channel 1 output corresponds to ADC/PDM Channel 1 data
4-0	PASI_TX_CH1_SLOT_NUM[4:0]	R/W	00000b	Primary ASI output channel 1 slot assignment. 0d = TDM is slot 0 or I <sup>2</sup> S, LJ is left slot 0 1d = TDM is slot 1 or I <sup>2</sup> S, LJ is left slot 1 2d to 14d = Slot assigned as per configuration 15d = TDM is slot 15 or I <sup>2</sup> S, LJ is left slot 15 16d = TDM is slot 16 or I <sup>2</sup> S, LJ is right slot 0 17d = TDM is slot 17 or I <sup>2</sup> S, LJ is right slot 1 18d to 30d = Slot assigned as per configuration 31d = TDM is slot 31 or I <sup>2</sup> S, LJ is right slot 15

**7.1.1.26 PASI\_TX\_CH2\_CFG Register (Address = 0x1F) [Reset = 0x21]**

PASI\_TX\_CH2\_CFG is shown in [Table 7-28](#).

Return to the [Summary Table](#).

This register is the PASI TX Channel 2 configuration register.

**Table 7-28. PASI\_TX\_CH2\_CFG Register Field Descriptions**

Bit	Field	Type	Reset	Description
7-6	RESERVED	R	0b	Reserved bits; Write only reset values
5	PASI_TX_CH2_CFG	R/W	1b	Primary ASI output channel 2 configuration. 0d = Primary ASI channel 2 output is in a tri-state condition 1d = Primary ASI channel 2 output corresponds to ADC/PDM Channel 2 data
4-0	PASI_TX_CH2_SLOT_NUM[4:0]	R/W	00001b	Primary ASI output channel 2 slot assignment. 0d = TDM is slot 0 or I <sup>2</sup> S, LJ is left slot 0 1d = TDM is slot 1 or I <sup>2</sup> S, LJ is left slot 1 2d to 14d = Slot assigned as per configuration 15d = TDM is slot 15 or I <sup>2</sup> S, LJ is left slot 15 16d = TDM is slot 16 or I <sup>2</sup> S, LJ is right slot 0 17d = TDM is slot 17 or I <sup>2</sup> S, LJ is right slot 1 18d to 30d = Slot assigned as per configuration 31d = TDM is slot 31 or I <sup>2</sup> S, LJ is right slot 15

**7.1.1.27 PASI\_TX\_CH3\_CFG Register (Address = 0x20) [Reset = 0x02]**

PASI\_TX\_CH3\_CFG is shown in [Table 7-29](#).

Return to the [Summary Table](#).

This register is the PASI TX Channel 3 configuration register.

**Table 7-29. PASI\_TX\_CH3\_CFG Register Field Descriptions**

Bit	Field	Type	Reset	Description
7	RESERVED	R	0b	Reserved bit; Write only reset value
6-5	PASI_TX_CH3_CFG[1:0]	R/W	00b	Primary ASI output channel 3 configuration. 0d = Primary ASI channel 3 output is in a tri-state condition 1d = Primary ASI channel 3 output corresponds to PDM Channel 3 data 2d = Primary ASI channel 3 output corresponds to VBAT data 3d = Reserved
4-0	PASI_TX_CH3_SLOT_NUM[4:0]	R/W	00010b	Primary ASI output channel 3 slot assignment. 0d = TDM is slot 0 or I <sup>2</sup> S, LJ is left slot 0 1d = TDM is slot 1 or I <sup>2</sup> S, LJ is left slot 1 2d to 14d = Slot assigned as per configuration 15d = TDM is slot 15 or I <sup>2</sup> S, LJ is left slot 15 16d = TDM is slot 16 or I <sup>2</sup> S, LJ is right slot 0 17d = TDM is slot 17 or I <sup>2</sup> S, LJ is right slot 1 18d to 30d = Slot assigned as per configuration 31d = TDM is slot 31 or I <sup>2</sup> S, LJ is right slot 15

**7.1.1.28 PASI\_TX\_CH4\_CFG Register (Address = 0x21) [Reset = 0x03]**

PASI\_TX\_CH4\_CFG is shown in [Table 7-30](#).

Return to the [Summary Table](#).

This register is the PASI TX Channel 4 configuration register.

**Table 7-30. PASI\_TX\_CH4\_CFG Register Field Descriptions**

Bit	Field	Type	Reset	Description
7	RESERVED	R	0b	Reserved bit; Write only reset value
6-5	PASI_TX_CH4_CFG[1:0]	R/W	00b	Primary ASI output channel 4 configuration. 0d = Primary ASI channel 4 output is in a tri-state condition 1d = Primary ASI channel 4 output corresponds to PDM Channel 4 data 2d = Primary ASI channel 4 output corresponds to TEMP data 3d = Reserved

**Table 7-30. PASI\_TX\_CH4\_CFG Register Field Descriptions (continued)**

Bit	Field	Type	Reset	Description
4-0	PASI_TX_CH4_SLOT_NUM[4:0]	R/W	00011b	Primary ASI output channel 4 slot assignment. 0d = TDM is slot 0 or I <sup>2</sup> S, LJ is left slot 0 1d = TDM is slot 1 or I <sup>2</sup> S, LJ is left slot 1 2d to 14d = Slot assigned as per configuration 15d = TDM is slot 15 or I <sup>2</sup> S, LJ is left slot 15 16d = TDM is slot 16 or I <sup>2</sup> S, LJ is right slot 0 17d = TDM is slot 17 or I <sup>2</sup> S, LJ is right slot 1 18d to 30d = Slot assigned as per configuration 31d = TDM is slot 31 or I <sup>2</sup> S, LJ is right slot 15

**7.1.1.29 PASI\_TX\_CH5\_CFG Register (Address = 0x22) [Reset = 0x04]**

PASI\_TX\_CH5\_CFG is shown in [Table 7-31](#).

Return to the [Summary Table](#).

This register is the PASI TX Channel 5 configuration register.

**Table 7-31. PASI\_TX\_CH5\_CFG Register Field Descriptions**

Bit	Field	Type	Reset	Description
7	RESERVED	R	0b	Reserved bit; Write only reset value
6-5	PASI_TX_CH5_CFG[1:0]	R/W	00b	Primary ASI output channel 5 configuration. 0d = Primary ASI channel 5 output is in a tri-state condition 1d = Primary ASI channel 5 output corresponds to ASI Input Channel 1 loopback data 2d = Primary ASI channel 5 output corresponds to echo reference Channel 1 data 3d = Reserved
4-0	PASI_TX_CH5_SLOT_NUM[4:0]	R/W	00100b	Primary ASI output channel 5 slot assignment. 0d = TDM is slot 0 or I <sup>2</sup> S, LJ is left slot 0 1d = TDM is slot 1 or I <sup>2</sup> S, LJ is left slot 1 2d to 14d = Slot assigned as per configuration 15d = TDM is slot 15 or I <sup>2</sup> S, LJ is left slot 15 16d = TDM is slot 16 or I <sup>2</sup> S, LJ is right slot 0 17d = TDM is slot 17 or I <sup>2</sup> S, LJ is right slot 1 18d to 30d = Slot assigned as per configuration 31d = TDM is slot 31 or I <sup>2</sup> S, LJ is right slot 15

**7.1.1.30 PASI\_TX\_CH6\_CFG Register (Address = 0x23) [Reset = 0x05]**

PASI\_TX\_CH6\_CFG is shown in [Table 7-32](#).

Return to the [Summary Table](#).

This register is the PASI TX Channel 6 configuration register.

**Table 7-32. PASI\_TX\_CH6\_CFG Register Field Descriptions**

Bit	Field	Type	Reset	Description
7	RESERVED	R	0b	Reserved bit; Write only reset value
6-5	PASI_TX_CH6_CFG[1:0]	R/W	00b	Primary ASI output channel 6 configuration. 0d = Primary ASI channel 6 output is in a tri-state condition 1d = Primary ASI channel 6 output corresponds to ASI Input Channel 2 loopback data 2d = Primary ASI channel 6 output corresponds to echo reference Channel 2 data 3d = Reserved

**Table 7-32. PASI\_TX\_CH6\_CFG Register Field Descriptions (continued)**

Bit	Field	Type	Reset	Description
4-0	PASI_TX_CH6_SLOT_NUM[4:0]	R/W	00101b	Primary ASI output channel 6 slot assignment. 0d = TDM is slot 0 or I <sup>2</sup> S, LJ is left slot 0 1d = TDM is slot 1 or I <sup>2</sup> S, LJ is left slot 1 2d to 14d = Slot assigned as per configuration 15d = TDM is slot 15 or I <sup>2</sup> S, LJ is left slot 15 16d = TDM is slot 16 or I <sup>2</sup> S, LJ is right slot 0 17d = TDM is slot 17 or I <sup>2</sup> S, LJ is right slot 1 18d to 30d = Slot assigned as per configuration 31d = TDM is slot 31 or I <sup>2</sup> S, LJ is right slot 15

### 7.1.1.31 PASI\_TX\_CH7\_CFG Register (Address = 0x24) [Reset = 0x06]

PASI\_TX\_CH7\_CFG is shown in [Table 7-33](#).

Return to the [Summary Table](#).

This register is the PASI TX Channel 7 configuration register.

**Table 7-33. PASI\_TX\_CH7\_CFG Register Field Descriptions**

Bit	Field	Type	Reset	Description
7	RESERVED	R	0b	Reserved bit; Write only reset value
6-5	PASI_TX_CH7_CFG[1:0]	R/W	00b	Primary ASI output channel 7 configuration. 0d = Primary ASI channel 7 output is in a tri-state condition 1d = Primary ASI channel 7 output corresponds to {VBAT_WLby2, TEMP_WLby2} 2d = Primary ASI channel 7 output corresponds to {echo_ref_ch1, echo_ref_ch2} 3d = Reserved
4-0	PASI_TX_CH7_SLOT_NUM[4:0]	R/W	00110b	Primary ASI output channel 7 slot assignment. 0d = TDM is slot 0 or I <sup>2</sup> S, LJ is left slot 0 1d = TDM is slot 1 or I <sup>2</sup> S, LJ is left slot 1 2d to 14d = Slot assigned as per configuration 15d = TDM is slot 15 or I <sup>2</sup> S, LJ is left slot 15 16d = TDM is slot 16 or I <sup>2</sup> S, LJ is right slot 0 17d = TDM is slot 17 or I <sup>2</sup> S, LJ is right slot 1 18d to 30d = Slot assigned as per configuration 31d = TDM is slot 31 or I <sup>2</sup> S, LJ is right slot 15

### 7.1.1.32 PASI\_TX\_CH8\_CFG Register (Address = 0x25) [Reset = 0x07]

PASI\_TX\_CH8\_CFG is shown in [Table 7-34](#).

Return to the [Summary Table](#).

This register is the PASI TX Channel 8 configuration register.

**Table 7-34. PASI\_TX\_CH8\_CFG Register Field Descriptions**

Bit	Field	Type	Reset	Description
7-6	RESERVED	R	0b	Reserved bits; Write only reset values
5	PASI_TX_CH8_CFG	R/W	0b	Primary ASI output channel 8 configuration. 0d = Primary ASI channel 8 output is in a tri-state condition 1d = Primary ASI channel 8 output corresponds to ICLA data

**Table 7-34. PASI\_TX\_CH8\_CFG Register Field Descriptions (continued)**

Bit	Field	Type	Reset	Description
4-0	PASI_TX_CH8_SLOT_NUM[4:0]	R/W	00111b	Primary ASI output channel 8 slot assignment. 0d = TDM is slot 0 or I <sup>2</sup> S, LJ is left slot 0 1d = TDM is slot 1 or I <sup>2</sup> S, LJ is left slot 1 2d to 14d = Slot assigned as per configuration 15d = TDM is slot 15 or I <sup>2</sup> S, LJ is left slot 15 16d = TDM is slot 16 or I <sup>2</sup> S, LJ is right slot 0 17d = TDM is slot 17 or I <sup>2</sup> S, LJ is right slot 1 18d to 30d = Slot assigned as per configuration 31d = TDM is slot 31 or I <sup>2</sup> S, LJ is right slot 15

**7.1.1.33 PASI\_RX\_CFG0 Register (Address = 0x26) [Reset = 0x00]**

PASI\_RX\_CFG0 is shown in [Table 7-35](#).

Return to the [Summary Table](#).

This register is the PASI RX configuration register 0.

**Table 7-35. PASI\_RX\_CFG0 Register Field Descriptions**

Bit	Field	Type	Reset	Description
7	PASI_RX_EDGE	R/W	0b	Primary ASI data input (on the primary and secondary data pin) receive edge. 0d = Default edge as per the protocol configuration setting in PASI_BCLK_POL 1d = Inverted following edge (half cycle delay) with respect to the default edge setting
6	PASI_RX_USE_INT_FSYNC	R/W	0b	Primary ASI uses internal FSYNC for input data latching in Controller mode configuration as applicable. 0d = Use external FSYNC for ASI protocol data latching 1d = Use internal FSYNC for ASI protocol data latching
5	PASI_RX_USE_INT_BCLK	R/W	0b	Primary ASI uses internal BCLK for input data latching in Controller mode configuration. 0d = Use external BCLK for ASI protocol data latching 1d = Use internal BCLK for ASI protocol data latching
4-0	PASI_RX_OFFSET[4:0]	R/W	00000b	Primary ASI data input MSB slot 0 offset (on the primary and secondary data pin). 0d = ASI data MSB location has no offset and is as per standard protocol 1d = ASI data MSB location (TDM mode is slot 0 or I <sup>2</sup> S, LJ mode is the left and right slot 0) offset of one BCLK cycle with respect to standard protocol 2d = ASI data MSB location (TDM mode is slot 0 or I <sup>2</sup> S, LJ mode is the left and right slot 0) offset of two BCLK cycles with respect to standard protocol 3d to 30d = ASI data MSB location (TDM mode is slot 0 or I <sup>2</sup> S, LJ mode is the left and right slot 0) offset assigned as per configuration 31d = ASI data MSB location (TDM mode is slot 0 or I <sup>2</sup> S, LJ mode is the left and right slot 0) offset of 31 BCLK cycles with respect to standard protocol

**7.1.1.34 CLK\_CFG0 Register (Address = 0x32) [Reset = 0x00]**

CLK\_CFG0 is shown in [Table 7-36](#).

Return to the [Summary Table](#).

This register is the clock configuration register 0.

**Table 7-36. CLK\_CFG0 Register Field Descriptions**

Bit	Field	Type	Reset	Description
7-2	PASI_SAMP_RATE[5:0]	R/W	000000b	Primary ASI sample rate configuration. -Typical (Allowed Range) 0d = Primary ASI sampling rate auto detected in the device 1d = 768000 (670320-791040) 2d = 614400 (536256-632832) 3d = 512000 (446880-527360) 4d = 438857 (383040-452022) 5d = 384000 (335160-395520) 6d = 341333 (297920-351573) 7d = 307200 (268128-316416) 8d = 256000 (223440-263680) 9d = 219429 (191520-226011) 10d = 192000 (167580-197760) 11d = 170667 (148960-175786) 12d = 153600 (134064-158208) 13d = 128000 (111720-131840) 14d = 109714 (95760-113005) 15d = 96000 (83790-98880) 16d = 85333 (74480-87893) 17d = 76800 (67032-79104) 18d = 64000 (55860-65920) 19d = 54857 (47880-56502) 20d = 48000 (41895-49440) 21d = 42667 (37240-43946) 22d = 38400 (33516-39552) 23d = 32000 (27930-32960) 24d = 27429 (23940-28251) 25d = 24000 (20947-24720) 26d = 21333 (18620-21973) 27d = 19200 (16758-19776) 28d = 16000 (13965-16480) 29d = 13714 (11970-14125) 30d = 12000 (10473-12360) 31d = 10667 (9310-10986) 32d = 9600 (8379-9888) 33d = 8000 (6982-8240) 34d = 6857 (5985-7062) 35d = 6000 (5236-6180) 36d = 5333 (4655-5493) 37d = 4800 (4189-4944) 38d = 4000 (3491-4120) 39d = 3429 (2992-3531) 40d = 3000 (2618-3090) 41d-63d = Reserved
1	PASI_FS_RATE_NO_LIM	R/W	0b	Limit sampling rate to standard audio sample rates only. 0d = Standard audio rates with 1% tolerance supported using auto mode 1d = Standard audio rates with 5% tolerance supported using auto mode
0	CUSTOM_CLK_CFG	R/W	0b	Custom clock configuration enable, all dividers and mux selects need to be manually configured. 0d = Auto clock configuration 1d = Custom clock configuration

**7.1.1.35 CLK\_CFG1 Register (Address = 0x33) [Reset = 0x00]**

CLK\_CFG1 is shown in [Table 7-37](#).

Return to the [Summary Table](#).

This register is the clock configuration register 1.

**Table 7-37. CLK\_CFG1 Register Field Descriptions**

Bit	Field	Type	Reset	Description
7-2	SASI_SAMP_RATE[5:0]	R/W	000000b	Secondary ASI sample rate configuration. -Typical (Range) 0d = Secondary ASI sampling rate auto detected in the device 1d = 768000 (670320-791040) 2d = 614400 (536256-632832) 3d = 512000 (446880-527360) 4d = 438857 (383040-452022) 5d = 384000 (335160-395520) 6d = 341333 (297920-351573) 7d = 307200 (268128-316416) 8d = 256000 (223440-263680) 9d = 219429 (191520-226011) 10d = 192000 (167580-197760) 11d = 170667 (148960-175786) 12d = 153600 (134064-158208) 13d = 128000 (111720-131840) 14d = 109714 (95760-113005) 15d = 96000 (83790-98880) 16d = 85333 (74480-87893) 17d = 76800 (67032-79104) 18d = 64000 (55860-65920) 19d = 54857 (47880-56502) 20d = 48000 (41895-49440) 21d = 42667 (37240-43946) 22d = 38400 (33516-39552) 23d = 32000 (27930-32960) 24d = 27429 (23940-28251) 25d = 24000 (20947-24720) 26d = 21333 (18620-21973) 27d = 19200 (16758-19776) 28d = 16000 (13965-16480) 29d = 13714 (11970-14125) 30d = 12000 (10473-12360) 31d = 10667 (9310-10986) 32d = 9600 (8379-9888) 33d = 8000 (6982-8240) 34d = 6857 (5985-7062) 35d = 6000 (5236-6180) 36d = 5333 (4655-5493) 37d = 4800 (4189-4944) 38d = 4000 (3491-4120) 39d = 3429 (2992-3531) 40d = 3000 (2618-3090) 41d-63d = Reserved
1	SASI_FS_RATE_NO_LIM	R/W	0b	Limit sampling rate to standard audio sample rates only. 0d = Standard audio rates with 1% tolerance supported using auto mode 1d = Standard audio rates with 5% tolerance supported using auto mode
0	RESERVED	R	0b	Reserved bit; Write only reset value

### 7.1.1.36 CLK\_CFG2 Register (Address = 0x34) [Reset = 0x40]

CLK\_CFG2 is shown in [Table 7-38](#).

Return to the [Summary Table](#).

This register is the clock configuration register 2.



**Table 7-38. CLK\_CFG2 Register Field Descriptions**

Bit	Field	Type	Reset	Description
7	PLL_DIS	R/W	0b	Custom/Auto clock mode PLL setting. 0d = PLL is always enabled in custom clk mode/PLL is enabled based on DSP MIPS requirement in auto clock mode 1d = PLL is disabled
6	AUTO_PLL_FR_ALLOW	R/W	1b	Allow the PLL to operate in fractional mode of operation. 0d = PLL fractional mode disabled 1d = PLL fractional mode allowed
5	RESERVED	R	0b	Reserved bit; Write only reset value
4	RESERVED	R	0b	Reserved bit; Write only reset value
3-1	CLK_SRC_SEL[2:0]	R/W	000b	Input clock source select. 0d = Primary ASI BCLK is the input clock source 1d = CCLK synchronized with Primary ASI FSYNC is the input clock source 2d = Secondary ASI BCLK is the input clock source 3d = CCLK synchronized with Secondary ASI FSYNC is the input clock source 4d = Fixed CCLK frequency (used only in controller mode configuration) 5d = Internal oscillator clock is the input clock source (only supported in custom clock configuration) 6d to 7d = Reserved
0	RATIO_CLK_EDGE	R/W	0b	Edge selection for clock source ratio detection. 0d = Use rising edge of clock source to check ratio with primary or secondary FSYNC 1d = Use falling edge of clock source to check ratio with primary or secondary FSYNC

#### 7.1.1.37 CNT\_CLK\_CFG0 Register (Address = 0x35) [Reset = 0x00]

CNT\_CLK\_CFG0 is shown in [Table 7-39](#).

Return to the [Summary Table](#).

This register is the controller mode clock configuration register 0.

**Table 7-39. CNT\_CLK\_CFG0 Register Field Descriptions**

Bit	Field	Type	Reset	Description
7-6	PDM_CLK_CFG[1:0]	R/W	00b	PDM_CLK configuration. 0d = PDM_CLK is 2.8224 MHz or 3.072 MHz 1d = PDM_CLK is 1.4112 MHz or 1.536 MHz 2d = PDM_CLK is 705.6 kHz or 768 kHz 3d = PDM_CLK is 5.6448 MHz or 6.144 MHz
5-0	CCLK_FS_RATIO_MSB[5:0]	R/W	000000b	Most significant bits for selecting the ratio between CCLK and primary/secondary ASI FSYNC with which CCLK is synchronized. 0d = Auto detect the ratio (assumption is CCLK is synchronized with primary/secondary FSYNC) 1d to 16383d = Ratio as per configuration

#### 7.1.1.38 CNT\_CLK\_CFG1 Register (Address = 0x36) [Reset = 0x00]

CNT\_CLK\_CFG1 is shown in [Table 7-40](#).

Return to the [Summary Table](#).

This register is the controller mode clock configuration register 1.

**Table 7-40. CNT\_CLK\_CFG1 Register Field Descriptions**

Bit	Field	Type	Reset	Description
7-0	CCLK_FS_RATIO_LSB[7:0]	R/W	00000000b	Select the ratio between CCLK and primary/secondary ASI FSYNC with which CCLK is synchronized. 0d = Auto detect the ratio (assumption is CCLK is synchronized with primary/secondary FSYNC) 1d to 16383d = Ratio as per configuration

**7.1.1.39 CNT\_CLK\_CFG2 Register (Address = 0x37) [Reset = 0x20]**

CNT\_CLK\_CFG2 is shown in [Table 7-41](#).

Return to the [Summary Table](#).

This register is the controller mode clock configuration register 2.

**Table 7-41. CNT\_CLK\_CFG2 Register Field Descriptions**

Bit	Field	Type	Reset	Description
7-5	CCLK_FREQ_SEL[2:0]	R/W	001b	These bits select the CCLK input frequency (used only in controller mode configuration). 0d = 12 MHz 1d = 12.288 MHz 2d = 13 MHz 3d = 16 MHz 4d = 19.2 MHz 5d = 19.68 MHz 6d = 24 MHz 7d = 24.576 MHz
4	PASI_CNT_CFG	R/W	0b	Primary ASI controller or target configuration 0d = Primary ASI in target configuration 1d = Primary ASI in controller configuration
3	SASI_CNT_CFG	R/W	0b	Secondary ASI controller or target configuration 0d = Secondary ASI in target configuration 1d = Secondary ASI in controller configuration
2	RESERVED	R	0b	Reserved bit; Write only reset value
1	RESERVED	R	0b	Reserved bit; Write only reset value
0	FS_MODE	R/W	0b	Sample rate setting (valid when the device is in controller mode). This is applicable for both PASI and SASI. 0d = sampling rate is a multiple (or submultiple) of 48 kHz 1d = sampling rate is a multiple (or submultiple) of 44.1 kHz

**7.1.1.40 CNT\_CLK\_CFG3 Register (Address = 0x38) [Reset = 0x00]**

CNT\_CLK\_CFG3 is shown in [Table 7-42](#).

Return to the [Summary Table](#).

This register is the controller mode clock configuration register 3.

**Table 7-42. CNT\_CLK\_CFG3 Register Field Descriptions**

Bit	Field	Type	Reset	Description
7	PASI_USE_INT_BCLK_F OR_FSYNC	R/W	0b	Use internal BCLK for FSYNC generation in PASI during controller mode configuration. 0d = Use external BCLK for FSYNC generation 1d = Use internal BCLK for FSYNC generation
6	PASI_INV_BCLK_FOR_F SYNC	R/W	0b	Invert PASI BCLK polarity only for PASI FSYNC generation in controller mode configuration. 0d = Do not invert PASI BCLK polarity for PASI FSYNC generation 1d = Invert PASI BCLK polarity for PASI FSYNC generation

**Table 7-42. CNT\_CLK\_CFG3 Register Field Descriptions (continued)**

Bit	Field	Type	Reset	Description
5-0	PASI_BCLK_FS_RATIO_MSB[5:0]	R/W	000000b	MSB bits for primary ASI BCLK to FSYNC ratio in controller mode.

#### 7.1.1.41 CNT\_CLK\_CFG4 Register (Address = 0x39) [Reset = 0x00]

CNT\_CLK\_CFG4 is shown in [Table 7-43](#).

Return to the [Summary Table](#).

This register is the controller mode clock configuration register 4.

**Table 7-43. CNT\_CLK\_CFG4 Register Field Descriptions**

Bit	Field	Type	Reset	Description
7-0	PASI_BCLK_FS_RATIO_LSB[7:0]	R/W	00000000b	LSB byte for primary ASI BCLK to FSYNC ratio in controller mode.

#### 7.1.1.42 CNT\_CLK\_CFG5 Register (Address = 0x3A) [Reset = 0x00]

CNT\_CLK\_CFG5 is shown in [Table 7-44](#).

Return to the [Summary Table](#).

This register is the controller mode clock configuration register 5.

**Table 7-44. CNT\_CLK\_CFG5 Register Field Descriptions**

Bit	Field	Type	Reset	Description
7	SASI_USE_INT_BCLK_FOR_FSYNC	R/W	0b	Use internal BCLK for FSYNC generation in SASI during controller mode configuration. 0d = Use external BCLK for FSYNC generation 1d = Use internal BCLK for FSYNC generation
6	SASI_INV_BCLK_FOR_FSYNC	R/W	0b	Invert SASI BCLK polarity only for SASI FSYNC generation in controller mode configuration. 0d = Do not invert SASI BCLK polarity for SASI FSYNC generation 1d = Invert SASI BCLK polarity for SASI FSYNC generation
5-0	SASI_BCLK_FS_RATIO_MSB[5:0]	R/W	000000b	MSB bits for secondary ASI BCLK to FSYNC ratio in controller mode.

#### 7.1.1.43 CNT\_CLK\_CFG6 Register (Address = 0x3B) [Reset = 0x00]

CNT\_CLK\_CFG6 is shown in [Table 7-45](#).

Return to the [Summary Table](#).

This register is the controller mode clock configuration register 6.

**Table 7-45. CNT\_CLK\_CFG6 Register Field Descriptions**

Bit	Field	Type	Reset	Description
7-0	SASI_BCLK_FS_RATIO_LSB[7:0]	R/W	00000000b	LSB byte for secondary ASI BCLK to FSYNC ratio in controller mode.

#### 7.1.1.44 CLK\_ERR\_STS0 Register (Address = 0x3C) [Reset = 0x00]

CLK\_ERR\_STS0 is shown in [Table 7-46](#).

Return to the [Summary Table](#).

This register is the clock error and status register 0.

**Table 7-46. CLK\_ERR\_STS0 Register Field Descriptions**

Bit	Field	Type	Reset	Description
7	DSP_CLK_ERR	R	0b	Flag indicating ratio error between FSYNC and selected clock source. 0d = No ratio error 1d = Ratio error between primary or secondary ASI FSYNC and selected clock source
6	RESERVED	R	0b	Reserved bit; Write only reset value
5	RESERVED	R	0b	Reserved bit; Write only reset value
4	SRC_RATIO_ERR	R	0b	Flag indicating that SRC m:n ratio is unsupported. (not valid for custom m/n ratio config). 0d = m:n ratio supported 1d = Unsupported m:n ratio error
3	DEM_RATE_ERR	R	0b	Flag indicating that clock configuration does not allow valid DEM rate. 0d = No DEM clock rate error 1d = DEM clock rate error in selected clock configuration
2	PDM_CLK_ERR	R	0b	Flag indicating that clock configuration does not allow valid PDM clock generation. 0d = No PDM clock generation error 1d = PDM clock generation error in selected clock configuration
1	RESET_ON_CLK_STOP_DET_STS	R	0b	Flag indicating that audio clock source stopped for at least 1ms. 0d = No audio clock source error 1d = Audio clock source stopped for at least 1ms
0	RESERVED	R	0b	Reserved bit; Write only reset value

#### 7.1.1.45 CLK\_ERR\_STS1 Register (Address = 0x3D) [Reset = 0x00]

CLK\_ERR\_STS1 is shown in [Table 7-47](#).

Return to the [Summary Table](#).

This register is the clock error and status register 1.

**Table 7-47. CLK\_ERR\_STS1 Register Field Descriptions**

Bit	Field	Type	Reset	Description
7	PASI_BCLK_FS_RATIO_ERR	R	0b	Flag indicating PASI bclk fsync ratio error. 0d = No PASI bclk fsync ratio error 1d = PASI bclk fsync ratio error in selected clock configuration
6	SASI_BCLK_FS_RATIO_ERR	R	0b	Flag indicating SASI bclk fsync ratio error. 0d = No SASI bclk fsync ratio error 1d = SASI bclk fsync ratio error in selected clock configuration
5	CCLK_FS_RATIO_ERR	R	0b	Flag indicating CCLK fsync ratio error. 0d = No CCLK fsync ratio error 1d = CCLK fsync ratio error
4	PASI_FS_ERR	R	0b	Flag indicating PASI FS rate change or halt error. 0d = No PASI FS error 1d = PASI FS rate change or halt detected
3	SASI_FS_ERR	R	0b	Flag indicating SASI FS rate change or halt error. 0d = No SASI FS error 1d = SASI FS rate change or halt detected
2-0	RESERVED	R	0b	Reserved bits; Write only reset values

**7.1.1.46 CLK\_DET\_STS0 Register (Address = 0x3E) [Reset = 0x00]**

CLK\_DET\_STS0 is shown in [Table 7-48](#).

Return to the [Summary Table](#).

This register is the clock ratio detection register 0.

**Table 7-48. CLK\_DET\_STS0 Register Field Descriptions**

Bit	Field	Type	Reset	Description
7-2	PASI_SAMP_RATE_STS[5:0]	R	000000b	Primary ASI Sample rate detected status. 0d = Reserved 1d = 768000 (670320-791040) 2d = 614400 (536256-632832) 3d = 512000 (446880-527360) 4d = 438857 (383040-452022) 5d = 384000 (335160-395520) 6d = 341333 (297920-351573) 7d = 307200 (268128-316416) 8d = 256000 (223440-263680) 9d = 219429 (191520-226011) 10d = 192000 (167580-197760) 11d = 170667 (148960-175786) 12d = 153600 (134064-158208) 13d = 128000 (111720-131840) 14d = 109714 (95760-113005) 15d = 96000 (83790-98880) 16d = 85333 (74480-87893) 17d = 76800 (67032-79104) 18d = 64000 (55860-65920) 19d = 54857 (47880-56502) 20d = 48000 (41895-49440) 21d = 42667 (37240-43946) 22d = 38400 (33516-39552) 23d = 32000 (27930-32960) 24d = 27429 (23940-28251) 25d = 24000 (20947-24720) 26d = 21333 (18620-21973) 27d = 19200 (16758-19776) 28d = 16000 (13965-16480) 29d = 13714 (11970-14125) 30d = 12000 (10473-12360) 31d = 10667 (9310-10986) 32d = 9600 (8379-9888) 33d = 8000 (6982-8240) 34d = 6857 (5985-7062) 35d = 6000 (5236-6180) 36d = 5333 (4655-5493) 37d = 4800 (4189-4944) 38d = 4000 (3491-4120) 39d = 3429 (2992-3531) 40d = 3000 (2618-3090) 41d-63d = Reserved
1-0	PLL_MODE_STS[1:0]	R	00b	PLL usage status. 0d = PLL used in integer mode 1d = PLL used in fractional mode 2d = PLL not used 3d = Reserved

**7.1.1.47 CLK\_DET\_STS1 Register (Address = 0x3F) [Reset = 0x00]**

CLK\_DET\_STS1 is shown in [Table 7-49](#).

Return to the [Summary Table](#).

This register is the clock ratio detection register 1.

**Table 7-49. CLK\_DET\_STS1 Register Field Descriptions**

Bit	Field	Type	Reset	Description
7-2	SASI_SAMP_RATE_STS[5:0]	R	000000b	Secondary ASI Sample rate detected status. 0d = Reserved 1d = 768000 (670320-791040) 2d = 614400 (536256-632832) 3d = 512000 (446880-527360) 4d = 438857 (383040-452022) 5d = 384000 (335160-395520) 6d = 341333 (297920-351573) 7d = 307200 (268128-316416) 8d = 256000 (223440-263680) 9d = 219429 (191520-226011) 10d = 192000 (167580-197760) 11d = 170667 (148960-175786) 12d = 153600 (134064-158208) 13d = 128000 (111720-131840) 14d = 109714 (95760-113005) 15d = 96000 (83790-98880) 16d = 85333 (74480-87893) 17d = 76800 (67032-79104) 18d = 64000 (55860-65920) 19d = 54857 (47880-56502) 20d = 48000 (41895-49440) 21d = 42667 (37240-43946) 22d = 38400 (33516-39552) 23d = 32000 (27930-32960) 24d = 27429 (23940-28251) 25d = 24000 (20947-24720) 26d = 21333 (18620-21973) 27d = 19200 (16758-19776) 28d = 16000 (13965-16480) 29d = 13714 (11970-14125) 30d = 12000 (10473-12360) 31d = 10667 (9310-10986) 32d = 9600 (8379-9888) 33d = 8000 (6982-8240) 34d = 6857 (5985-7062) 35d = 6000 (5236-6180) 36d = 5333 (4655-5493) 37d = 4800 (4189-4944) 38d = 4000 (3491-4120) 39d = 3429 (2992-3531) 40d = 3000 (2618-3090) 41d-63d = Reserved
1-0	RESERVED	R	0b	Reserved bits; Write only reset values

#### 7.1.1.48 CLK\_DET\_STS2 Register (Address = 0x40) [Reset = 0x00]

CLK\_DET\_STS2 is shown in [Table 7-50](#).

Return to the [Summary Table](#).

This register is the clock ratio detection register 2.

**Table 7-50. CLK\_DET\_STS2 Register Field Descriptions**

Bit	Field	Type	Reset	Description
7-6	RESERVED	R	0b	Reserved bits; Write only reset values
5-0	FS_CLKSRC_RATIO_DETECT_MSB_STS[5:0]	R	000000b	MSB bits for primary ASI or secondary ASI FSYNC to clock source ratio detected.

### 7.1.1.49 CLK\_DET\_STS3 Register (Address = 0x41) [Reset = 0x00]

CLK\_DET\_STS3 is shown in [Table 7-51](#).

Return to the [Summary Table](#).

This register is the clock ratio detection register 3.

**Table 7-51. CLK\_DET\_STS3 Register Field Descriptions**

Bit	Field	Type	Reset	Description
7-0	FS_CLKSRC_RATIO_DE T_LSB_STS[7:0]	R	00000000b	LSB byte for primary ASI or secondary ASI FSYNC to clock source ratio detected.

### 7.1.1.50 INT\_CFG Register (Address = 0x42) [Reset = 0x00]

INT\_CFG is shown in [Table 7-52](#).

Return to the [Summary Table](#).

This register is the interrupt configuration register.

**Table 7-52. INT\_CFG Register Field Descriptions**

Bit	Field	Type	Reset	Description
7	INT_POL	R/W	0b	Interrupt polarity. 0b = Active low (IRQZ) 1b = Active high (IRQ)
6-5	INT_EVENT[1:0]	R/W	00b	Interrupt event configuration. 0d = INT asserts on any unmasked latched interrupts event 1d = INT asserts on any unmasked live interrupts event 2d = INT asserts for 2 ms (typical) for every 4-ms (typical) duration on any unmasked latched interrupts event 3d = INT asserts for 2 ms (typical) one time on each pulse for any unmasked interrupts event
4-3	PD_ON_FLT_CFG[1:0]	R/W	00b	Power down configuration during fault for chx and micbias. 0d = Faults are not considered for power down 1d = Only unmasked faults are considered for power down 2d = All faults are considered for power down 3d = Reserved
2	LTCH_READ_CFG	R/W	0b	Interrupt latch registers readback configuration. 0b = All interrupts can be read through the LTCH registers 1b = Only unmasked interrupts can be read through the LTCH registers
1	PD_ON_FLT_RCV_CFG	R/W	0b	Configuration for Power down ADC channels on fault 0b = Auto recovery, ADC channels are re-powered up when fault goes away 1b = Manual recovery, ADC channels are not re-powered up when fault goes away
0	LTCH_CLR_ON_READ	R/W	0b	Cfgn for clearing LTCH register bits 0 = LTCH reg bits are cleared on reg read only if live status is zero 1 = LTCH reg bits are cleared on reg read irrespective of live status

### 7.1.1.51 ADC\_DAC\_MISC\_CFG Register (Address = 0x4B) [Reset = 0x00]

ADC\_DAC\_MISC\_CFG is shown in [Table 7-53](#).

Return to the [Summary Table](#).

This register is the ADC overload response configuration register. It gives option to mute the ADC channel in overload recovery phase to avoid audible artifacts. Overload recovery phase is protection mechanism for inputs like step input where there is abrupt change in level.

**Table 7-53. ADC\_DAC\_MISC\_CFG Register Field Descriptions**

Bit	Field	Type	Reset	Description
7	RESERVED	R	0b	Reserved bit; Write only reset value
6	RESERVED	R	0b	Reserved bit; Write only reset value
5	RESERVED	R	0b	Reserved bit; Write only reset value
4	ADC_CH1_MUTE_ON_OVRLD	R/W	0b	Mute ADC channel 1 while ADC1 is in Overload Recovery Phase 0b = Disable 1b = Enable
3	ADC_CH2_MUTE_ON_OVRLD	R/W	0b	Mute ADC channel 2 while ADC2 is in Overload Recovery Phase 0b = Disable 1b = Enable
2-0	RESERVED	R	0b	Reserved bits; Write only reset values

**7.1.1.52 PWR\_TUNE\_CFG0 Register (Address = 0x4E) [Reset = 0x00]**

PWR\_TUNE\_CFG0 is shown in [Table 7-54](#).

Return to the [Summary Table](#).

This register is configuration register 0 for power tune configuration.

**Table 7-54. PWR\_TUNE\_CFG0 Register Field Descriptions**

Bit	Field	Type	Reset	Description
7	ADC_CLK_BY2_MODE	R/W	0b	ADC MOD CLK select configuration. 0d = MOD CLK 3.072MHz or 2.8224MHz 1d = MOD CLK 1.536MHz or 1.4112MHz
6	ADC_CIC_ORDER	R/W	0b	ADC CIC order configuration. 0d = 5th order CIC 1d = 4th order CIC
5	ADC_FIR_BYPASS	R/W	0b	ADC FIR bypass configuration. 0d = Bypass disable 1d = Bypass enable
4	ADC_DEM_RATE_OVRD	R/W	0b	ADC DEM rate override configuration. 0d = Default 1d = 2x
3	RESERVED	R	0b	Reserved bit; Write only reset value
2	ADC_LOW_PWR_FILTER	R/W	0b	Low Power filter configuration for ADC 0d = Disable 1d = Enable
1-0	RESERVED	R	0b	Reserved bits; Write only reset values

**7.1.1.53 ADC\_CH1\_CFG0 Register (Address = 0x50) [Reset = 0x00]**

ADC\_CH1\_CFG0 is shown in [Table 7-55](#).

Return to the [Summary Table](#).

This register is configuration register 0 for ADC channel 1.

**Table 7-55. ADC\_CH1\_CFG0 Register Field Descriptions**

Bit	Field	Type	Reset	Description
7-6	ADC_CH1_INSRC[1:0]	R/W	00b	ADC Channel 1 input configuration. 0d = Analog differential input 1d = Analog single-ended input 2d = Reserved 3d = Reserved
5-4	RESERVED	R	0b	Reserved bits; Write only reset values



**Table 7-55. ADC\_CH1\_CFG0 Register Field Descriptions (continued)**

Bit	Field	Type	Reset	Description
3-2	ADC_CH1_CM_TOL[1:0]	R/W	00b	ADC Channel 1 input coupling (applicable for the analog input). 0d = AC-coupled input 1d = DC-coupled input 2d = Reserved 3d = Reserved
1	ADC_CH1_FULLSCALE_VAL	R/W	0b	ADC Channel 1 Full-scale value for VREF=2.75 V (applicable for the analog input). 0d = 10 Vrms differential ( 5 Vrms for single ended operation) 1d = 5 Vrms differential ( 2.5 Vrms for single ended operation)
0	ADC_CH1_BW_MODE	R/W	0b	ADC Channel 1 band-width selection coupling (applicable for the analog input). 0d = audio band-width (24 kHz mode) 1d = wide band-width (96 kHz mode) (Input impedance is 8 times of audio band-width mode)

#### 7.1.1.54 ADC\_CH1\_CFG2 Register (Address = 0x52) [Reset = 0xA1]

ADC\_CH1\_CFG2 is shown in [Table 7-56](#).

Return to the [Summary Table](#).

This register is configuration register 2 for ADC channel 1.

**Table 7-56. ADC\_CH1\_CFG2 Register Field Descriptions**

Bit	Field	Type	Reset	Description
7-0	ADC_CH1_DVOL[7:0]	R/W	10100001b	Channel 1 digital volume control. 0d = Digital volume is muted 1d = Digital volume control is set to -80 dB 2d = Digital volume control is set to -79.5 dB 3d to 160d = Digital volume control is set as per configuration 161d = Digital volume control is set to 0 dB 162d = Digital volume control is set to 0.5 dB 163d to 253d = Digital volume control is set as per configuration 254d = Digital volume control is set to 46.5 dB 255d = Digital volume control is set to 47 dB

#### 7.1.1.55 ADC\_CH1\_CFG3 Register (Address = 0x53) [Reset = 0x80]

ADC\_CH1\_CFG3 is shown in [Table 7-57](#).

Return to the [Summary Table](#).

This register is configuration register 3 for ADC channel 1.

**Table 7-57. ADC\_CH1\_CFG3 Register Field Descriptions**

Bit	Field	Type	Reset	Description
7-4	ADC_CH1_FGAIN[3:0]	R/W	1000b	ADC channel 1 fine gain calibration. 0d = Fine gain is set to -0.8 dB 1d = Fine gain is set to -0.7 dB 2d = Fine gain is set to -0.6 dB 3d to 7d = Fine gain is set as per configuration 8d = Fine gain is set to 0 dB 9d = Fine gain is set to 0.1 dB 10d to 13d = Fine gain is set as per configuration 14d = Fine gain is set to 0.6 dB 15d = Fine gain is set to 0.7 dB
3-0	RESERVED	R	0b	Reserved bits; Write only reset value

### 7.1.1.56 ADC\_CH1\_CFG4 Register (Address = 0x54) [Reset = 0x00]

ADC\_CH1\_CFG4 is shown in [Table 7-58](#).

Return to the [Summary Table](#).

This register is configuration register 4 for ADC channel 1.

**Table 7-58. ADC\_CH1\_CFG4 Register Field Descriptions**

Bit	Field	Type	Reset	Description
7-2	ADC_CH1_PCAL[5:0]	R/W	000000b	ADC channel 1 phase calibration with modulator clock resolution. 0d = No phase calibration 1d = Phase calibration delay is set to one cycle of the modulator clock 2d = Phase calibration delay is set to two cycles of the modulator clock 3d to 62d = Phase calibration delay as per configuration 63d = Phase calibration delay is set to 63 cycles of the modulator clock
1-0	PCAL_ANA_DIG_SEL[1:0]	R/W	00b	PCAL support configuration. 0d = Pcal for both Ana-Dig supported 1d = Pcal for only Ana 2d = Pcal for only Dig 3d = Reserved

### 7.1.1.57 ADC\_CH2\_CFG0 Register (Address = 0x55) [Reset = 0x00]

ADC\_CH2\_CFG0 is shown in [Table 7-59](#).

Return to the [Summary Table](#).

This register is configuration register 0 for ADC channel 2.

**Table 7-59. ADC\_CH2\_CFG0 Register Field Descriptions**

Bit	Field	Type	Reset	Description
7-6	ADC_CH2_INSR[1:0]	R/W	00b	ADC Channel 2 input configuration. 0d = Analog differential input 1d = Analog single-ended input 2d = Reserved 3d = Reserved
5-4	RESERVED	R	0b	Reserved bits; Write only reset values
3-2	ADC_CH2_CM_TOL[1:0]	R/W	00b	ADC Channel 2 input coupling (applicable for the analog input). 0d = AC-coupled input 1d = DC-coupled input 2d = Reserved 3d = Reserved
1	ADC_CH2_FULLSCALE_VAL	R/W	0b	ADC Channel 1 Full-scale value for VREF=2.75 V (applicable for the analog input). 0d = 10 Vrms differential ( 5 Vrms for single ended operation) 1d = 5 Vrms differential ( 2.5 Vrms for single ended operation)
0	ADC_CH2_BW_MODE	R/W	0b	ADC Channel 2 band-width selection. coupling (applicable for the analog input). 0d = audio band-width (24 kHz mode) 1d = wide band-width (96 kHz mode) (Input impedance is 8 times of audio band-width mode)

### 7.1.1.58 ADC\_CH2\_CFG2 Register (Address = 0x57) [Reset = 0xA1]

ADC\_CH2\_CFG2 is shown in [Table 7-60](#).

Return to the [Summary Table](#).

This register is configuration register 2 for channel 2.

**Table 7-60. ADC\_CH2\_CFG2 Register Field Descriptions**

Bit	Field	Type	Reset	Description
7-0	ADC_CH2_DVOL[7:0]	R/W	10100001b	Channel 1 digital volume control. 0d = Digital volume is muted 1d = Digital volume control is set to -80 dB 2d = Digital volume control is set to -79.5 dB 3d to 160d = Digital volume control is set as per configuration 161d = Digital volume control is set to 0 dB 162d = Digital volume control is set to 0.5 dB 163d to 253d = Digital volume control is set as per configuration 254d = Digital volume control is set to 46.5 dB 255d = Digital volume control is set to 47 dB

### 7.1.1.59 ADC\_CH2\_CFG3 Register (Address = 0x58) [Reset = 0x80]

ADC\_CH2\_CFG3 is shown in [Table 7-61](#).

Return to the [Summary Table](#).

This register is configuration register 3 for ADC Channel 2.

**Table 7-61. ADC\_CH2\_CFG3 Register Field Descriptions**

Bit	Field	Type	Reset	Description
7-4	ADC_CH2_FGAIN[3:0]	R/W	1000b	ADC Channel 2 fine gain calibration. 0d = Fine gain is set to -0.8 dB 1d = Fine gain is set to -0.7 dB 2d = Fine gain is set to -0.6 dB 3d to 7d = Fine gain is set as per configuration 8d = Fine gain is set to 0 dB 9d = Fine gain is set to 0.1 dB 10d to 13d = Fine gain is set as per configuration 14d = Fine gain is set to 0.6 dB 15d = Fine gain is set to 0.7 dB
3-0	RESERVED	R	0b	Reserved bits; Write only reset value

### 7.1.1.60 ADC\_CH2\_CFG4 Register (Address = 0x59) [Reset = 0x00]

ADC\_CH2\_CFG4 is shown in [Table 7-62](#).

Return to the [Summary Table](#).

This register is configuration register 4 for ADC Channel 2.

**Table 7-62. ADC\_CH2\_CFG4 Register Field Descriptions**

Bit	Field	Type	Reset	Description
7-2	ADC_CH2_PCAL[5:0]	R/W	000000b	ADC Channel 2 phase calibration with modulator clock resolution. 0d = No phase calibration 1d = Phase calibration delay is set to one cycle of the modulator clock 2d = Phase calibration delay is set to two cycles of the modulator clock 3d to 62d = Phase calibration delay as per configuration 63d = Phase calibration delay is set to 63 cycles of the modulator clock
1-0	RESERVED	R	0b	Reserved bits; Write only reset value

**7.1.1.61 ADC\_CH3\_CFG0 Register (Address = 0x5A) [Reset = 0x00]**

 ADC\_CH3\_CFG0 is shown in [Table 7-63](#).

 Return to the [Summary Table](#).

This register is configuration register 0 for ADC channel 3.

**Table 7-63. ADC\_CH3\_CFG0 Register Field Descriptions**

Bit	Field	Type	Reset	Description
7	ADC_CH3_CLONE	R/W	0b	ADC Channel 3 input configuration. 0d = clone disabled 1d = Channel 3 Digital Filter Input is generated same as Channel 1 Digital Filter Input (Cloned Input)
6-0	RESERVED	R	0b	Reserved bits; Write only reset value

**7.1.1.62 ADC\_CH3\_CFG2 Register (Address = 0x5B) [Reset = 0xA1]**

 ADC\_CH3\_CFG2 is shown in [Table 7-64](#).

 Return to the [Summary Table](#).

This register is configuration register 2 for ADC channel 3.

**Table 7-64. ADC\_CH3\_CFG2 Register Field Descriptions**

Bit	Field	Type	Reset	Description
7-0	ADC_CH3_DVOL[7:0]	R/W	10100001b	Channel 3 digital volume control. 0d = Digital volume is muted 1d = Digital volume control is set to -80 dB 2d = Digital volume control is set to -79.5 dB 3d to 160d = Digital volume control is set as per configuration 161d = Digital volume control is set to 0 dB 162d = Digital volume control is set to 0.5 dB 163d to 253d = Digital volume control is set as per configuration 254d = Digital volume control is set to 46.5 dB 255d = Digital volume control is set to 47 dB

**7.1.1.63 ADC\_CH3\_CFG3 Register (Address = 0x5C) [Reset = 0x80]**

 ADC\_CH3\_CFG3 is shown in [Table 7-65](#).

 Return to the [Summary Table](#).

This register is configuration register 3 for ADC channel 3.

**Table 7-65. ADC\_CH3\_CFG3 Register Field Descriptions**

Bit	Field	Type	Reset	Description
7-4	ADC_CH3_FGAIN[3:0]	R/W	1000b	ADC channel 3 fine gain calibration. 0d = Fine gain is set to -0.8 dB 1d = Fine gain is set to -0.7 dB 2d = Fine gain is set to -0.6 dB 3d to 7d = Fine gain is set as per configuration 8d = Fine gain is set to 0 dB 9d = Fine gain is set to 0.1 dB 10d to 13d = Fine gain is set as per configuration 14d = Fine gain is set to 0.6 dB 15d = Fine gain is set to 0.7 dB
3-0	RESERVED	R	0b	Reserved bits; Write only reset value

### 7.1.1.64 ADC\_CH3\_CFG4 Register (Address = 0x5D) [Reset = 0x00]

ADC\_CH3\_CFG4 is shown in [Table 7-66](#).

Return to the [Summary Table](#).

This register is configuration register 4 for ADC channel 3.

**Table 7-66. ADC\_CH3\_CFG4 Register Field Descriptions**

Bit	Field	Type	Reset	Description
7-2	ADC_CH3_PCAL[5:0]	R/W	000000b	ADC channel 3 phase calibration with modulator clock resolution. 0d = No phase calibration 1d = Phase calibration delay is set to one cycle of the modulator clock 2d = Phase calibration delay is set to two cycles of the modulator clock 3d to 62d = Phase calibration delay as per configuration 63d = Phase calibration delay is set to 63 cycles of the modulator clock
1-0	RESERVED	R	0b	Reserved bits; Write only reset value

### 7.1.1.65 ADC\_CH4\_CFG0 Register (Address = 0x5E) [Reset = 0x00]

ADC\_CH4\_CFG0 is shown in [Table 7-67](#).

Return to the [Summary Table](#).

This register is configuration register 0 for ADC Channel 4.

**Table 7-67. ADC\_CH4\_CFG0 Register Field Descriptions**

Bit	Field	Type	Reset	Description
7	ADC_CH4_CLONE	R/W	0b	ADC Channel 4 input configuration. 0d = clone disabled 1d = Channel 4 Digital Filter Input is generated same as Channel 2 Digital Filter Input (Cloned Input)
6-0	RESERVED	R	0b	Reserved bits; Write only reset value

### 7.1.1.66 ADC\_CH4\_CFG2 Register (Address = 0x5F) [Reset = 0xA1]

ADC\_CH4\_CFG2 is shown in [Table 7-68](#).

Return to the [Summary Table](#).

This register is configuration register 2 for channel 4.

**Table 7-68. ADC\_CH4\_CFG2 Register Field Descriptions**

Bit	Field	Type	Reset	Description
7-0	ADC_CH4_DVOL[7:0]	R/W	10100001b	Channel 4 digital volume control. 0d = Digital volume is muted 1d = Digital volume control is set to -80 dB 2d = Digital volume control is set to -79.5 dB 3d to 160d = Digital volume control is set as per configuration 161d = Digital volume control is set to 0 dB 162d = Digital volume control is set to 0.5 dB 163d to 253d = Digital volume control is set as per configuration 254d = Digital volume control is set to 46.5 dB 255d = Digital volume control is set to 47 dB

### 7.1.1.67 ADC\_CH4\_CFG3 Register (Address = 0x60) [Reset = 0x80]

ADC\_CH4\_CFG3 is shown in [Table 7-69](#).

Return to the [Summary Table](#).

This register is configuration register 3 for ADC Channel 4.

**Table 7-69. ADC\_CH4\_CFG3 Register Field Descriptions**

Bit	Field	Type	Reset	Description
7-4	ADC_CH4_FGAIN[3:0]	R/W	1000b	ADC Channel 4 fine gain calibration. 0d = Fine gain is set to -0.8 dB 1d = Fine gain is set to -0.7 dB 2d = Fine gain is set to -0.6 dB 3d to 7d = Fine gain is set as per configuration 8d = Fine gain is set to 0 dB 9d = Fine gain is set to 0.1 dB 10d to 13d = Fine gain is set as per configuration 14d = Fine gain is set to 0.6 dB 15d = Fine gain is set to 0.7 dB
3-0	RESERVED	R	0b	Reserved bits; Write only reset value

### 7.1.1.68 ADC\_CH4\_CFG4 Register (Address = 0x61) [Reset = 0x00]

ADC\_CH4\_CFG4 is shown in [Table 7-70](#).

Return to the [Summary Table](#).

This register is configuration register 4 for ADC Channel 4.

**Table 7-70. ADC\_CH4\_CFG4 Register Field Descriptions**

Bit	Field	Type	Reset	Description
7-2	ADC_CH4_PCAL[5:0]	R/W	000000b	ADC Channel 4 phase calibration with modulator clock resolution. 0d = No phase calibration 1d = Phase calibration delay is set to one cycle of the modulator clock 2d = Phase calibration delay is set to two cycles of the modulator clock 3d to 62d = Phase calibration delay as per configuration 63d = Phase calibration delay is set to 63 cycles of the modulator clock
1-0	RESERVED	R	0b	Reserved bits; Write only reset value

### 7.1.1.69 DSP\_CFG0 Register (Address = 0x72) [Reset = 0x18]

DSP\_CFG0 is shown in [Table 7-71](#).

Return to the [Summary Table](#).

This register is the digital signal processor (DSP) configuration register 0.

**Table 7-71. DSP\_CFG0 Register Field Descriptions**

Bit	Field	Type	Reset	Description
7-6	ADC_DSP_DECI_FILT[1:0]	R/W	00b	ADC channel decimation filter response. 0d = Linear phase 1d = Low latency 2d = Ultra-low latency 3d = Reserved; Don't use

**Table 7-71. DSP\_CFG0 Register Field Descriptions (continued)**

Bit	Field	Type	Reset	Description
5-4	ADC_DSP_HPF_SEL[1:0]	R/W	01b	ADC channel high-pass filter (HPF) selection. 0d = Programmable first-order IIR filter for a custom HPF with default coefficient values in P10_R120-127 and P11_R8-11 set as the all-pass filter 1d = HPF with a cutoff of $0.00002 \times f_S$ (1 Hz at $f_S = 48$ kHz) is selected 2d = HPF with a cutoff of $0.00025 \times f_S$ (12 Hz at $f_S = 48$ kHz) is selected 3d = HPF with a cutoff of $0.002 \times f_S$ (96 Hz at $f_S = 48$ kHz) is selected
3-2	ADC_DSP_BQ_CFG[1:0]	R/W	10b	Number of biquads per ADC channel configuration. 0d = No biquads per channel; biquads are all disabled 1d = 1 biquad per channel 2d = 2 biquads per channel 3d = 3 biquads per channel
1	ADC_DSP_DISABLE_SOFT_STEP	R/W	0b	ADC Soft-stepping disable during DVOL change, mute, and unmute. 0d = Soft-stepping enabled 1d = Soft-stepping disabled
0	ADC_DSP_DVOL_GANG	R/W	0b	DVOL control ganged across ADC channels. 0d = Each channel has its own DVOL CTRL settings as programmed in the ADC_CHx_DVOL bits 1d = All active channels must use the channel 1 DVOL setting (ADC_CH1_DVOL) irrespective of whether channel 1 is turned on or not

#### 7.1.1.70 CH\_EN Register (Address = 0x76) [Reset = 0xCC]

CH\_EN is shown in [Table 7-72](#).

Return to the [Summary Table](#).

This register is the channel enable configuration register.

**Table 7-72. CH\_EN Register Field Descriptions**

Bit	Field	Type	Reset	Description
7	IN_CH1_EN	R/W	1b	Input channel 1 enable setting. 0d = Input channel 1 is disabled 1d = Input channel 1 is enabled
6	IN_CH2_EN	R/W	1b	Input channel 2 enable setting. 0d = Input channel 2 is disabled 1d = Input channel 2 is enabled
5	IN_CH3_EN	R/W	0b	Input channel 3 enable setting. 0d = Input channel 3 is disabled 1d = Input channel 3 is enabled
4	IN_CH4_EN	R/W	0b	Input channel 4 enable setting. 0d = Input channel 4 is disabled 1d = Input channel 4 is enabled
3	RESERVED	R	0b	Reserved bit; Write only reset value
2	RESERVED	R	0b	Reserved bit; Write only reset value
1	RESERVED	R	0b	Reserved bit; Write only reset value
0	RESERVED	R	0b	Reserved bit; Write only reset value

#### 7.1.1.71 DYN\_PUPD\_CFG Register (Address = 0x77) [Reset = 0x00]

DYN\_PUPD\_CFG is shown in [Table 7-73](#).

Return to the [Summary Table](#).

This register is the power-up configuration register.

**Table 7-73. DYN\_PUPD\_CFG Register Field Descriptions**

Bit	Field	Type	Reset	Description
7	ADC_DYN_PUPD_EN	R/W	0b	Dynamic channel power-up, power-down enable for record path. 0d = Channel power-up, power-down is not supported if any channel recording is on 1d = Channel can be powered up or down individually, even if channel recording is on
6	ADC_DYN_MAXCH_SEL	R/W	0b	Dynamic mode maximum channel select configuration for record path. 0d = Channel 1 and channel 2 are used with dynamic channel power-up, power-down feature enabled 1d = Channel 1 to channel 4 are used with dynamic channel power-up, power-down feature enabled
5	RESERVED	R	0b	Reserved bit; Write only reset value
4	RESERVED	R	0b	Reserved bit; Write only reset value
3	DYN_PUPD_ADC_PDM_DIFF_CLK	R/W	0b	Dynamic power-up power-down with different adc mod clock and pdm clock configuration. 0d = Same ADC MOD CLK and PDM CLK in dynamic pupd 1d = Different ADC MOD CLK and PDM CLK in dynamic pupd
2	RESERVED	R	0b	Reserved bit; Write only reset value
1	ADC_CH_SWAP	R/W	0b	ADC channel swap enable configuration. 1d = No swap 1d = ADC channel 1 and 2 are swapped
0	RESERVED	R	0b	Reserved bit; Write only reset value

#### 7.1.1.72 PWR\_CFG Register (Address = 0x78) [Reset = 0x00]

PWR\_CFG is shown in [Table 7-74](#).

Return to the [Summary Table](#).

This register is the power-up configuration register.

**Table 7-74. PWR\_CFG Register Field Descriptions**

Bit	Field	Type	Reset	Description
7	ADC_PDZ	R/W	0b	Power control for ADC and PDM channels. 0d = Power down all ADC and PDM channels 1d = Power up all enabled ADC and PDM channels
6	RESERVED	R	0b	Reserved bit; Write only reset value
5	MICBIAS_PDZ	R/W	0b	Power control for MICBIAS. 0d = Power down MICBIAS 1d = Power up MICBIAS
4	RESERVED	R	0b	Reserved bit; Write only reset value
3	UAD_EN	R/W	0b	Enable ultrasound activity detection (UAD) algorithm. 0d = UAD is disabled 1d = UAD is enabled
2	VAD_EN	R/W	0b	Enable voice activity detection (VAD) algorithm. 0d = VAD is disabled 1d = VAD is enabled
1	RESERVED	R	0b	Reserved bit; Write only reset value
0	RESERVED	R	0b	Reserved bit; Write only reset value



### 7.1.1.73 DEV\_STS0 Register (Address = 0x79) [Reset = 0x00]

DEV\_STS0 is shown in [Table 7-75](#).

Return to the [Summary Table](#).

This register is the device status value register 0.

**Table 7-75. DEV\_STS0 Register Field Descriptions**

Bit	Field	Type	Reset	Description
7	IN_CH1_STATUS	R	0b	ADC or PDM channel 1 power status. 0d = ADC or PDM channel is powered down 1d = ADC or PDM channel is powered up
6	IN_CH2_STATUS	R	0b	ADC or PDM channel 2 power status. 0d = ADC or PDM channel is powered down 1d = ADC or PDM channel is powered up
5	IN_CH3_STATUS	R	0b	ADC or PDM channel 1 power status. 0d = ADC or PDM channel is powered down 1d = ADC or PDM channel is powered up
4	IN_CH4_STATUS	R	0b	ADC or PDM channel 2 power status. 0d = ADC or PDM channel is powered down 1d = ADC or PDM channel is powered up
3	RESERVED	R	0b	Reserved bit; Write only reset value
2	RESERVED	R	0b	Reserved bit; Write only reset value
1	RESERVED	R	0b	Reserved bit; Write only reset value
0	RESERVED	R	0b	Reserved bit; Write only reset value

### 7.1.1.74 DEV\_STS1 Register (Address = 0x7A) [Reset = 0x80]

DEV\_STS1 is shown in [Table 7-76](#).

Return to the [Summary Table](#).

This register is the device status value register 1.

**Table 7-76. DEV\_STS1 Register Field Descriptions**

Bit	Field	Type	Reset	Description
7-5	MODE_STS[2:0]	R	100b	Device mode status. 0-3d = Reserved 4d = Device is in sleep mode or software shutdown mode 5d = Reserved 6d = Device is in active mode with all record and playback channels turned off 7d = Device is in active mode with at least one record or playback channel turned on
4	PLL_STS	R	0b	PLL status. 0d = PLL is not enabled 1d = PLL is enabled
3	MICBIAS_STS	R	0b	MICBIAS status. 0d = MICBIAS is disabled 1d = MICBIAS is enabled
2	BOOST_STS	R	0b	Boost status. 0d = Boost is disabled 1d = Boost is enabled
1	CHx_PD_FLT_STS	R	0b	Status for PD on INxx Analog inputs faults 0d = No ADC Channel is Powered Down due to fault/s on Analog inputs INxx 1d = Some ADC Channel is Powered Down due to fault/s on Analog inputs INxx

**Table 7-76. DEV\_STS1 Register Field Descriptions (continued)**

Bit	Field	Type	Reset	Description
0	ALL_CHx_PD_FLT_STS	R	0b	Status for PD on Micbias faults 0d = No ADC Channel is Powered Down due to fault/s related to Micbias 1d = All ADC Channels are Powered Down due to fault/s related to Micbias

**7.1.1.75 I2C\_CKSUM Register (Address = 0x7E) [Reset = 0x00]**

I2C\_CKSUM is shown in [Table 7-77](#).

Return to the [Summary Table](#).

This register returns the I<sup>2</sup>C transactions checksum value.

**Table 7-77. I2C\_CKSUM Register Field Descriptions**

Bit	Field	Type	Reset	Description
7-0	I2C_CKSUM[7:0]	R/W	00000000b	These bits return the I <sup>2</sup> C transactions checksum value. Writing to this register resets the checksum to the written value. This register is updated on writes to other registers on all pages.

### 7.1.2 TAA5412-Q1\_B0\_P1 Registers

Table 7-78 lists the memory-mapped registers for the TAA5412-Q1\_B0\_P1 registers. All register offset addresses not listed in Table 7-78 should be considered as reserved locations and the register contents should not be modified.

**Table 7-78. TAA5412-Q1\_B0\_P1 Registers**

Address	Acronym	Register Name	Reset Value	Section
0x0	PAGE_CFG	Device page register	0x00	<a href="#">Section 7.1.2.1</a>
0x3	DSP_CFG0	DSP configuration register 0	0x00	<a href="#">Section 7.1.2.2</a>
0xD	CLK_CFG0	Clock configuration register 0	0x00	<a href="#">Section 7.1.2.3</a>
0xE	CHANNEL_CFG1	ADC channel configuration register	0x00	<a href="#">Section 7.1.2.4</a>
0x17	SRC_CFG0	SRC configuration register 1	0x00	<a href="#">Section 7.1.2.5</a>
0x18	SRC_CFG1	SRC configuration register 2	0x00	<a href="#">Section 7.1.2.6</a>
0x1E	LPAD_CFG1	Low power activity detection configuration register	0x20	<a href="#">Section 7.1.2.7</a>
0x20	LPAD_LPSG_CFG1	Low power activity detection and Low power signal generation common configuration register 1	0x00	<a href="#">Section 7.1.2.8</a>
0x24	AGC_CFG	AGC configuration register 2	0x00	<a href="#">Section 7.1.2.9</a>
0x2C	MIXER_CFG0	MIXER configuration register 0	0x00	<a href="#">Section 7.1.2.10</a>
0x2F	INT_MASK0	Interrupt mask register 0	0xFF	<a href="#">Section 7.1.2.11</a>
0x30	INT_MASK1	Interrupt mask register 1	0x0F	<a href="#">Section 7.1.2.12</a>
0x31	INT_MASK2	Interrupt mask register 2	0x00	<a href="#">Section 7.1.2.13</a>
0x32	INT_MASK4	Interrupt mask register 4	0x00	<a href="#">Section 7.1.2.14</a>
0x33	INT_MASK5	Interrupt mask register 5	0x30	<a href="#">Section 7.1.2.15</a>
0x34	INT_LTCH0	Latched interrupt readback register 0	0x00	<a href="#">Section 7.1.2.16</a>
0x35	CHx_LTCH	Latched summary of diagnostics register	0x00	<a href="#">Section 7.1.2.17</a>
0x36	IN_CH1_LTCH	Channel 1 input DC faults diagnostics latched status register	0x00	<a href="#">Section 7.1.2.18</a>
0x37	IN_CH2_LTCH	Channel 2 input DC faults diagnostics latched status register	0x00	<a href="#">Section 7.1.2.19</a>
0x38	ADC_CHx_OVRD	ADC overload fault detection mask	0x00	<a href="#">Section 7.1.2.20</a>
0x39	OUT_CH2_LTCH	Channel 2 output DC faults diagnostics latched status register	0x00	<a href="#">Section 7.1.2.21</a>
0x3A	INT_LTCH1	Latched interrupt readback register 1	0x00	<a href="#">Section 7.1.2.22</a>
0x3B	INT_LTCH2	Latched interrupt readback register 2	0x00	<a href="#">Section 7.1.2.23</a>
0x3C	INT_LIVE0	Live Interrupt readback register 0	0x00	<a href="#">Section 7.1.2.24</a>
0x3D	CHx_LIVE	Live summary of diagnostics registers	0x00	<a href="#">Section 7.1.2.25</a>
0x3E	IN_CH1_LIVE	Channel 1 input DC faults diagnostics live status register	0x00	<a href="#">Section 7.1.2.26</a>
0x3F	IN_CH2_LIVE	Channel 2 input DC faults diagnostics live status register	0x00	<a href="#">Section 7.1.2.27</a>
0x42	INT_LIVE1	Live interrupt readback register 1	0x00	<a href="#">Section 7.1.2.28</a>
0x43	INT_LIVE2	Live interrupt readback register 2	0x00	<a href="#">Section 7.1.2.29</a>
0x46	DIAG_CFG0	Input diagnostics configuration register 0	0x00	<a href="#">Section 7.1.2.30</a>
0x47	DIAG_CFG1	Input diagnostics configuration register 1	0x37	<a href="#">Section 7.1.2.31</a>
0x48	DIAG_CFG2	Input diagnostics configuration register 2	0x87	<a href="#">Section 7.1.2.32</a>
0x4A	DIAG_CFG4	Input diagnostics configuration register 4	0xB8	<a href="#">Section 7.1.2.33</a>
0x4B	DIAG_CFG5	Input diagnostics configuration register 5	0x00	<a href="#">Section 7.1.2.34</a>
0x4C	DIAG_CFG6	Input diagnostics configuration register 6	0xA2	<a href="#">Section 7.1.2.35</a>
0x4D	DIAG_CFG7	Input diagnostics configuration register 7	0x48	<a href="#">Section 7.1.2.36</a>
0x4E	DIAG_CFG8	Input diagnostics configuration register 8	0xBA	<a href="#">Section 7.1.2.37</a>
0x4F	DIAG_CFG9	Input diagnostics configuration register 9	0x4B	<a href="#">Section 7.1.2.38</a>

**Table 7-78. TAA5412-Q1\_B0\_P1 Registers (continued)**

Address	Acronym	Register Name	Reset Value	Section
0x50	DIAG_CFG10	Input diagnostics configuration register 10	0x88	<a href="#">Section 7.1.2.39</a>
0x51	DIAG_CFG11	Input diagnostics configuration register 11	0x40	<a href="#">Section 7.1.2.40</a>
0x52	DIAG_CFG12	Input diagnostics configuration register 12	0x44	<a href="#">Section 7.1.2.41</a>
0x53	DIAG_CFG13	Input diagnostics configuration register 13	0x00	<a href="#">Section 7.1.2.42</a>
0x54	DIAG_CFG14	Input diagnostics configuration register 14	0x48	<a href="#">Section 7.1.2.43</a>
0x55	DIAGDATA_CFG	Input diagnostics data configuration register	0x00	<a href="#">Section 7.1.2.44</a>
0x56	DIAG_MON_MSB_VBAT	Diagnostics SAR VBATIN monitor data MSB byte	0x00	<a href="#">Section 7.1.2.45</a>
0x57	DIAG_MON_LSB_VBAT	Diagnostics SAR VBATIN monitor data LSB nibble	0x00	<a href="#">Section 7.1.2.46</a>
0x58	DIAG_MON_MSB_MBIAS	Diagnostics SAR MICBIAS monitor data MSB byte	0x00	<a href="#">Section 7.1.2.47</a>
0x59	DIAG_MON_LSB_MBIAS	Diagnostics SAR MICBIAS monitor data LSB nibble	0x01	<a href="#">Section 7.1.2.48</a>
0x5A	DIAG_MON_MSB_IN1P	Diagnostics SAR IN1P monitor data MSB byte	0x00	<a href="#">Section 7.1.2.49</a>
0x5B	DIAG_MON_LSB_IN1P	Diagnostics SAR IN1P monitor data LSB nibble	0x02	<a href="#">Section 7.1.2.50</a>
0x5C	DIAG_MON_MSB_IN1M	Diagnostics SAR IN1M monitor data MSB byte	0x00	<a href="#">Section 7.1.2.51</a>
0x5D	DIAG_MON_LSB_IN1M	Diagnostics SAR IN1M monitor data LSB nibble	0x03	<a href="#">Section 7.1.2.52</a>
0x5E	DIAG_MON_MSB_IN2P	Diagnostics SAR IN2P monitor data MSB byte	0x00	<a href="#">Section 7.1.2.53</a>
0x5F	DIAG_MON_LSB_IN2P	Diagnostics SAR IN2P monitor data LSB nibble	0x04	<a href="#">Section 7.1.2.54</a>
0x60	DIAG_MON_MSB_IN2M	Diagnostics SAR IN2M monitor data MSB byte	0x00	<a href="#">Section 7.1.2.55</a>
0x61	DIAG_MON_LSB_IN2M	Diagnostics SAR IN2M monitor data LSB nibble	0x05	<a href="#">Section 7.1.2.56</a>
0x6A	DIAG_MON_MSB_TEMP	Diagnostics SAR Temperature monitor data MSB byte	0x00	<a href="#">Section 7.1.2.57</a>
0x6B	DIAG_MON_LSB_TEMP	Diagnostics SAR Temperature monitor data LSB nibble	0x0A	<a href="#">Section 7.1.2.58</a>
0x6C	DIAG_MON_MSB_MBIAS_LOAD	Diagnostics SAR MICBIAS LOAD Current monitor data MSB byte	0x00	<a href="#">Section 7.1.2.59</a>
0x6D	DIAG_MON_LSB_MBIAS_LOAD	Diagnostics SAR MICBIAS LOAD Current monitor data LSB nibble	0x0B	<a href="#">Section 7.1.2.60</a>
0x6E	DIAG_MON_MSB_AVDD	Diagnostics SAR AVDD monitor data MSB byte	0x00	<a href="#">Section 7.1.2.61</a>
0x6F	DIAG_MON_LSB_AVDD	Diagnostics SAR AVDD monitor data LSB nibble	0x0C	<a href="#">Section 7.1.2.62</a>
0x70	DIAG_MON_MSB_GPA	Diagnostics SAR GPA monitor data MSB byte	0x00	<a href="#">Section 7.1.2.63</a>
0x71	DIAG_MON_LSB_GPA	Diagnostics SAR GPA monitor data LSB nibble register	0x0D	<a href="#">Section 7.1.2.64</a>
0x72	BOOST_CFG	Boost configuration register	0x00	<a href="#">Section 7.1.2.65</a>
0x73	MICBIAS_CFG	Micbias configuration register	0xA0	<a href="#">Section 7.1.2.66</a>

**7.1.2.1 PAGE\_CFG Register (Address = 0x0) [Reset = 0x00]**

PAGE\_CFG is shown in [Table 7-79](#).

Return to the [Summary Table](#).

The device memory map is divided into pages. This register sets the page.

**Table 7-79. PAGE\_CFG Register Field Descriptions**

Bit	Field	Type	Reset	Description
7-0	PAGE[7:0]	R/W	00000000b	These bits set the device page. 0d = Page 0 1d = Page 1 2d to 254d = Page 2 to page 254 respectively 255d = Page 255

### 7.1.2.2 DSP\_CFG0 Register (Address = 0x3) [Reset = 0x00]

DSP\_CFG0 is shown in [Table 7-80](#).

Return to the [Summary Table](#).

This register is the configuration register for on-the-fly filter updates.

**Table 7-80. DSP\_CFG0 Register Field Descriptions**

Bit	Field	Type	Reset	Description
7	RESERVED	R	0b	Reserved bit; Write only reset value
6	RESERVED	R	0b	Reserved bit; Write only reset value
5	RESERVED	R	0b	Reserved bit; Write only reset value
4	RESERVED	R	0b	Reserved bit; Write only reset value
3	RESERVED	R	0b	Reserved bit; Write only reset value
2	RESERVED	R	0b	Reserved bit; Write only reset value
1	RESERVED	R	0b	Reserved bit; Write only reset value
0	EN_BQ_OTF_CHG	R/W	0b	Enable run-time changes to Biquad settings. 0d = Disable on the fly biquad changes 1d = Enable on the fly biquad changes

### 7.1.2.3 CLK\_CFG0 Register (Address = 0xD) [Reset = 0x00]

CLK\_CFG0 is shown in [Table 7-81](#).

Return to the [Summary Table](#).

This register is the Clock configuration register 0.

**Table 7-81. CLK\_CFG0 Register Field Descriptions**

Bit	Field	Type	Reset	Description
7	CNT_TGT_CFG_OVR_PASI	R/W	0b	ASI controller target Config Override Register 0d = controller-target Config as per PASI_CNT_CFG bit. 1d = Override the standard behavior of the PASI_CNT_CFG. In this case the clock auto detect feature is not available. PASI_CNT_CFG = 0 : BCLK is input but FSYNC is output. PASI_CNT_CFG = 1 : BCLK is output but FSYNC in input.
6	CNT_TGT_CFG_OVR_SASI	R/W	0b	ASI controller target Config Override Register 0d = controller-target Config as per SASI_CNT_CFG bit. 1d = Override the standard behavior of the SASI_CNT_CFG. In this case the clock auto detect feature is not available. SASI_CNT_CFG = 0 : BCLK is input but FSYNC is output. SASI_CNT_CFG = 1 : BCLK is output but FSYNC in input.
5-3	RESERVED	R	0b	Reserved bits; Write only reset value
2	PASI_USE_INT_FSYNC	R/W	0b	For Primary use internal FSYNC in controller mode configuration. 0d = Use external FSYNC 1d = Use internal FSYNC
1	SASI_USE_INT_FSYNC	R/W	0b	For Secondary use internal FSYNC in controller mode configuration. 0d = Use external FSYNC 1d = Use internal FSYNC
0	RESERVED	R	0b	Reserved bit; Write only reset value

### 7.1.2.4 CHANNEL\_CFG1 Register (Address = 0xE) [Reset = 0x00]

CHANNEL\_CFG1 is shown in [Table 7-82](#).

Return to the [Summary Table](#).

This is the ADC channel dynamic power-on or off configuration register.

**Table 7-82. CHANNEL\_CFG1 Register Field Descriptions**

Bit	Field	Type	Reset	Description
7	FORCE_DYN_MODE_CU ST_MAX_CH	R/W	0b	ADC Force dynamic mode custom max channel 0d = In Dynamic, Max channel is based on ADC_DYN_MAXCH_SEL 1d = In Dynamic mode, max channel is custom as DYN_MODE_CUST_MAX_CH
6-3	DYN_MODE_CUST_MAX _CH[3:0]	R/W	0000b	ADC Dynamic mode custom max channel configuration [3]->CH4_EN [2]->CH3_EN [1]->CH2_EN [0]->CH1_EN
2-0	RESERVED	R	0b	Reserved bits; Write only reset values

#### 7.1.2.5 SRC\_CFG0 Register (Address = 0x17) [Reset = 0x00]

SRC\_CFG0 is shown in [Table 7-83](#).

Return to the [Summary Table](#).

This register is configuration register 1 for SRC.

**Table 7-83. SRC\_CFG0 Register Field Descriptions**

Bit	Field	Type	Reset	Description
7	SRC_EN	R/W	0b	SRC enable config 0b = SRC disable 1b = SRC enable
6	DIS_AUTO_SRC_DET	R/W	0b	SRC auto detect config 0b = SRC auto detect enabled 1b = SRC auto detect disabled
5-0	RESERVED	R	0b	Reserved bits; Write only reset value

#### 7.1.2.6 SRC\_CFG1 Register (Address = 0x18) [Reset = 0x00]

SRC\_CFG1 is shown in [Table 7-84](#).

Return to the [Summary Table](#).

This register is configuration register 2 for SRC.

**Table 7-84. SRC\_CFG1 Register Field Descriptions**

Bit	Field	Type	Reset	Description
7	MAIN_FS_CUSTOM_CFG	R/W	0b	Main Fs custom config 0b = Main Fs is auto inferred 1b = Main Fs need to be selected from MAIN_FS_SELECT_CFG
6	MAIN_FS_SELECT_CFG	R/W	0b	Main Fs select config 0b = PASI Fs shall be used as Main Fs 1b = SASI Fs shall be used as Main Fs
5-3	MAIN_AUX_RATIO_M_C USTOM_CFG[2:0]	R/W	000b	Main and Aux Fs Ratio m:n config 0d = m is auto inferred 1d = 1 2d = 2 3d = 3 4d = 4 5d = Reserved 6d = 6 7d = Reserved

**Table 7-84. SRC\_CFG1 Register Field Descriptions (continued)**

Bit	Field	Type	Reset	Description
2-0	MAIN_AUX_RATIO_N_C USTOM_CFG[2:0]	R/W	000b	Main and Aux Fs Ratio m:n config 0d = n is auto inferred 1d = 1 2d = 2 3d = 3 4d = 4 5d = Reserved 6d = 6 7d = Reserved

### 7.1.2.7 LPAD\_CFG1 Register (Address = 0x1E) [Reset = 0x20]

LPAD\_CFG1 is shown in [Table 7-85](#).

Return to the [Summary Table](#).

This register is the voice activity detection or ultrasonic activity detection configuration register 1.

**Table 7-85. LPAD\_CFG1 Register Field Descriptions**

Bit	Field	Type	Reset	Description
7-6	LPAD_MODE[1:0]	R/W	00b	Auto ADC power up / power down configuration selection. 0d = User initiated ADC power-up and ADC power-down 1d = VAD/UAD interrupt based ADC power up and ADC power down 2d = VAD/UAD interrupt based ADC power up but user initiated ADC power down 3d = Reserved
5-4	LPAD_CH_SEL[1:0]	R/W	10b	VAD channel select. 0d = Channel 1 is monitored for VAD/UAD activity 1d = Channel 2 is monitored for VAD/UAD activity 2d = Channel 3 is monitored for VAD/UAD activity 3d = Channel 4 is monitored for VAD/UAD activity
3	LPAD_DOUT_INT_CFG	R/W	0b	DOUT interrupt configuration. 0d = DOUT pin is not enabled for interrupt function 1d = DOUT pin is enabled to support interrupt output when channel data in not being recorded
2	RESERVED	R	0b	Reserved bit; Write only reset value
1	LPAD_PD_DET_EN	R/W	0b	Enable ASI output data during VAD/UAD activity. 0d = VAD/UAD processing is not enabled during ADC recording 1d = VAD/UAD processing is enabled during ADC recording and VAD interrupts are generated as configured
0	RESERVED	R	0b	Reserved bit; Write only reset value

### 7.1.2.8 LPAD\_LPSG\_CFG1 Register (Address = 0x20) [Reset = 0x00]

LPAD\_LPSG\_CFG1 is shown in [Table 7-86](#).

Return to the [Summary Table](#).

This register is configuration register 1 for VAD/UAD/UAG.

**Table 7-86. LPAD\_LPSG\_CFG1 Register Field Descriptions**

Bit	Field	Type	Reset	Description
7-6	LPAD_LPSG_CLK_CFG[1:0]	R/W	00b	Clock select for VAD/UAD/UAG 0d = VAD/UAD/UAG processing using internal oscillator clock 1d = VAD/UAD/UAG processing using external clock on BCLK input 2d = VAD/UAD/UAG processing using external clock on CCLK input 3d = Custom clock configuration based on CNT_CFG, CLK_SRC and CLKGEN_CFG registers in page 0

**Table 7-86. LPAD\_LPSG\_CFG1 Register Field Descriptions (continued)**

Bit	Field	Type	Reset	Description
5-4	LPAD_LPSG_EXT_CLK_CFG[1:0]	R/W	00b	Clock configuration using external clock for VAD/UAD/UAG 0d = External clock is 24.576 MHz 1d = External clock is 6.144 MHz (Not Supported) 2d = External clock is 12.288 MHz 3d = External clock is 18.432 MHz
3	RESERVED	R	0b	Reserved bit; Write only reset value
2	RESERVED	R	0b	Reserved bit; Write only reset value
1-0	RESERVED	R	0b	Reserved bits; Write only reset values

**7.1.2.9 AGC\_CFG Register (Address = 0x24) [Reset = 0x00]**

AGC\_CFG is shown in [Table 7-87](#).

Return to the [Summary Table](#).

This register is configuration register 2 for AGC.

**Table 7-87. AGC\_CFG Register Field Descriptions**

Bit	Field	Type	Reset	Description
7	AGC_CH1_EN	R/W	0b	AGC Channel 1 enable config 0d = disable 1d = enable
6	AGC_CH2_EN	R/W	0b	AGC Channel 2 enable config 0d = disable 1d = enable
5	AGC_CH3_EN	R/W	0b	AGC Channel 3 enable config 0d = disable 1d = enable
4	AGC_CH4_EN	R/W	0b	AGC Channel 4 enable config 0d = disable 1d = enable
3	RESERVED	R	0b	Reserved bit; Write only reset value
2	RESERVED	R	0b	Reserved bit; Write only reset value
1	RESERVED	R	0b	Reserved bit; Write only reset value
0	RESERVED	R	0b	Reserved bit; Write only reset value

**7.1.2.10 MIXER\_CFG0 Register (Address = 0x2C) [Reset = 0x00]**

MIXER\_CFG0 is shown in [Table 7-88](#).

Return to the [Summary Table](#).

This register is the MIXER configuration register 0.

**Table 7-88. MIXER\_CFG0 Register Field Descriptions**

Bit	Field	Type	Reset	Description
7	RESERVED	R	0b	Reserved bit; Write only reset value
6	EN_SIDE_CHAIN_MIXER	R/W	0b	Enable Side Chain Mixer 0b = Disabled 1b = Enabled
5	EN_ADC_CHANNEL_MIXER	R/W	0b	Enable ADC Channel Mixer 0b = Disabled 1b = Enabled



**Table 7-88. MIXER\_CFG0 Register Field Descriptions (continued)**

Bit	Field	Type	Reset	Description
4	EN_LOOPBACK_MIXER	R/W	0b	Enable Loopback Mixer 0b = Disabled 1b = Enabled
3-0	RESERVED	R	0b	Reserved bits; Write only reset value

### 7.1.2.11 INT\_MASK0 Register (Address = 0x2F) [Reset = 0xFF]

INT\_MASK0 is shown in [Table 7-89](#).

Return to the [Summary Table](#).

This register is the interrupt mask register 0.

**Table 7-89. INT\_MASK0 Register Field Descriptions**

Bit	Field	Type	Reset	Description
7	INT_MASK0	R/W	1b	Clock error interrupt mask. 0b = Don't Mask 1b = Mask
6	INT_MASK0	R/W	1b	PLL Lock interrupt mask. 0b = Don't Mask 1b = Mask
5	INT_MASK0	R/W	1b	Boost Over Temperature interrupt mask. 0b = Don't Mask 1b = Mask
4	INT_MASK0	R/W	1b	Boost Over Current interrupt mask. 0b = Don't Mask 1b = Mask
3	INT_MASK0	R/W	1b	Boost MO interrupt mask. 0b = Don't Mask 1b = Mask
2	RESERVED	R	0b	Reserved bit; Write only reset value
1	RESERVED	R	0b	Reserved bit; Write only reset value
0	RESERVED	R	0b	Reserved bit; Write only reset value

### 7.1.2.12 INT\_MASK1 Register (Address = 0x30) [Reset = 0x0F]

INT\_MASK1 is shown in [Table 7-90](#).

Return to the [Summary Table](#).

This register is the interrupt mask register 1.

**Table 7-90. INT\_MASK1 Register Field Descriptions**

Bit	Field	Type	Reset	Description
7	INT_MASK1	R/W	0b	Channel-1(INP1/INM1) Input DC Faults Diagnostic Interrupt Mask. 0b = Don't Mask 1b = Mask
6	INT_MASK1	R/W	0b	Channel-2(INP2/INM2) Input DC Faults Diagnostic Interrupt Mask. 0b = Don't Mask 1b = Mask
5	RESERVED	R	0b	Reserved bit; Write only reset value
4	RESERVED	R	0b	Reserved bit; Write only reset value
3	INT_MASK1	R/W	1b	Input Faults Diagnostic Interrupt Mask for "Short to VBATIN" detect when VBATIN Voltage is less than MICBIAS Voltage. 0b = Don't Mask 1b = Mask

**Table 7-90. INT\_MASK1 Register Field Descriptions (continued)**

Bit	Field	Type	Reset	Description
2	RESERVED	R	0b	Reserved bit; Write only reset value
1	RESERVED	R	0b	Reserved bit; Write only reset value
0	RESERVED	R	0b	Reserved bit; Write only reset value

**7.1.2.13 INT\_MASK2 Register (Address = 0x31) [Reset = 0x00]**

INT\_MASK2 is shown in [Table 7-91](#).

Return to the [Summary Table](#).

This register is the interrupt mask register 2.

**Table 7-91. INT\_MASK2 Register Field Descriptions**

Bit	Field	Type	Reset	Description
7	INT_MASK2	R/W	0b	Input Diagnostics - Open Inputs Fault Interrupt Mask. 0b = Don't Mask 1b = Mask
6	INT_MASK2	R/W	0b	Input Diagnostics - Inputs Shorted Fault Interrupt Mask. 0b = Don't Mask 1b = Mask
5	INT_MASK2	R/W	0b	Input Diagnostics - INP Shorted to GND Fault Interrupt Mask. 0b = Don't Mask 1b = Mask
4	INT_MASK2	R/W	0b	Input Diagnostics - INM Shorted to GND Fault Interrupt Mask. 0b = Don't Mask 1b = Mask
3	INT_MASK2	R/W	0b	Input Diagnostics - INP Shorted to MICBIAS Fault Interrupt Mask. 0b = Don't Mask 1b = Mask
2	INT_MASK2	R/W	0b	Input Diagnostics - INM Shorted to MICBIAS Fault Interrupt Mask. 0b = Don't Mask 1b = Mask
1	INT_MASK2	R/W	0b	Input Diagnostics - INP Shorted to VBATIN Fault Interrupt Mask. 0b = Don't Mask 1b = Mask
0	INT_MASK2	R/W	0b	Input Diagnostics - INM Shorted to VBATIN Fault Interrupt Mask. 0b = Don't Mask 1b = Mask

**7.1.2.14 INT\_MASK4 Register (Address = 0x32) [Reset = 0x00]**

INT\_MASK4 is shown in [Table 7-92](#).

Return to the [Summary Table](#).

This register is the interrupt mask register 4.

**Table 7-92. INT\_MASK4 Register Field Descriptions**

Bit	Field	Type	Reset	Description
7	INT_MASK4	R/W	0b	INP overvoltage fault mask. 0b = Don't Mask 1b = Mask
6	INT_MASK4	R/W	0b	INM overvoltage fault mask. 0b = Don't Mask 1b = Mask
5	RESERVED	R	0b	Reserved bit; Write only reset value

**Table 7-92. INT\_MASK4 Register Field Descriptions (continued)**

Bit	Field	Type	Reset	Description
4	RESERVED	R	0b	Reserved bit; Write only reset value
3	RESERVED	R	0b	Reserved bit; Write only reset value
2	RESERVED	R	0b	Reserved bit; Write only reset value
1	RESERVED	R	0b	Reserved bit; Write only reset value
0	RESERVED	R	0b	Reserved bit; Write only reset value

### 7.1.2.15 INT\_MASK5 Register (Address = 0x33) [Reset = 0x30]

INT\_MASK5 is shown in [Table 7-93](#).

Return to the [Summary Table](#).

This register is the interrupt mask register 5.

**Table 7-93. INT\_MASK5 Register Field Descriptions**

Bit	Field	Type	Reset	Description
7	INT_MASK5	R/W	0b	GPA up threshold fault mask. 0b = Don't Mask 1b = Mask
6	INT_MASK5	R/W	0b	GPA low threshold fault mask. 0b = Don't Mask 1b = Mask
5	INT_MASK5	R/W	1b	VAD power up detect interrupt mask. 0b = Don't Mask 1b = Mask
4	INT_MASK5	R/W	1b	VAD power down detect interrupt mask. 0b = Don't Mask 1b = Mask
3	INT_MASK5	R/W	0b	Micbias short circuit fault mask. 0b = Don't Mask 1b = Mask
2	INT_MASK5	R/W	0b	Micbias High current fault mask. 0b = Don't Mask 1b = Mask
1	INT_MASK5	R/W	0b	Micbias Low current fault mask. 0b = Don't Mask 1b = Mask
0	INT_MASK5	R/W	0b	Micbias Over voltage fault mask. 0b = Don't Mask 1b = Mask

### 7.1.2.16 INT\_LTCH0 Register (Address = 0x34) [Reset = 0x00]

INT\_LTCH0 is shown in [Table 7-94](#).

Return to the [Summary Table](#).

This register is the latched interrupt readback register 0.

**Table 7-94. INT\_LTCH0 Register Field Descriptions**

Bit	Field	Type	Reset	Description
7	INT_LTCH0	R	0b	Interrupt due to clock error (self clearing bit). 0b = No interrupt 1b = Interrupt

**Table 7-94. INT\_LTCH0 Register Field Descriptions (continued)**

Bit	Field	Type	Reset	Description
6	INT_LTCH0	R	0b	Interrupt due to PLL Lock (self clearing bit) 0b = No interrupt 1b = Interrupt
5	INT_LTCH0	R	0b	Interrupt due to Boost Over Temperature (self clearing bit). 0b = No interrupt 1b = Interrupt
4	INT_LTCH0	R	0b	Interrupt due to Boost Over Current.(self clearing bit). 0b = No interrupt 1b = Interrupt
3	INT_LTCH0	R	0b	Interrupt due to Boost MO. (self clearing bit). 0b = No interrupt 1b = Interrupt
2	RESERVED	R	0b	Reserved bit; Write only reset value
1	RESERVED	R	0b	Reserved bit; Write only reset value
0	RESERVED	R	0b	Reserved bit; Write only reset value

**7.1.2.17 CHx\_LTCH Register (Address = 0x35) [Reset = 0x00]**

CHx\_LTCH is shown in [Table 7-95](#).

Return to the [Summary Table](#).

This register is the channel level diagnostics latched status register.

**Table 7-95. CHx\_LTCH Register Field Descriptions**

Bit	Field	Type	Reset	Description
7	STS_CHx_LTCH	R	0b	Status of Input CH1_LTCH (INP1/INM1). 0b = No faults occurred in input channel 1 1b = Fault or Faults have occurred in input channel 1
6	STS_CHx_LTCH	R	0b	Status of Input CH2_LTCH (INP2/INM2). 0b = No faults occurred in input channel 2 1b = Fault or Faults have occurred in input channel 2
5	RESERVED	R	0b	Reserved bit; Write only reset value
4	RESERVED	R	0b	Reserved bit; Write only reset value
3	STS_CHx_LTCH	R	0b	Status on fault due "Short to VBATIN fault detected when VBATIN is less than MICBIAS" 0b = Short to VBATIN fault when VBATIN is less than MICBIAS did NOT occur in any channel 1b = Short to VBATIN fault when VBATIN is less than MICBIAS has occurred in at least one channel
2	RESERVED	R	0b	Reserved bit; Write only reset value
1	RESERVED	R	0b	Reserved bit; Write only reset value
0	RESERVED	R	0b	Reserved bit; Write only reset value

**7.1.2.18 IN\_CH1\_LTCH Register (Address = 0x36) [Reset = 0x00]**

IN\_CH1\_LTCH is shown in [Table 7-96](#).

Return to the [Summary Table](#).

This register is the latched status register for channel 1 input DC faults diagnostics.

**Table 7-96. IN\_CH1\_LTCH Register Field Descriptions**

Bit	Field	Type	Reset	Description
7	IN_CH1_LTCH	R	0b	Input Channel-1(INP1/INM1) Open Inputs (self clearing bit). 0b = No Open Inputs 1b = Open Inputs
6	IN_CH1_LTCH	R	0b	Input Channel-1(INP1/INM1) Inputs Shorted (self clearing bit). 0b = No Input Shorted 1b = Input Shorted each Other
5	IN_CH1_LTCH	R	0b	Input Channel-1 INP Shorted to GND (self clearing bit). 0b = INP not shorted to GND 1b = INP shorted to GND
4	IN_CH1_LTCH	R	0b	Input Channel-1 INM1 Shorted to GND (self clearing bit). 0b = INM not shorted to GND 1b = INM shorted to GND
3	IN_CH1_LTCH	R	0b	Input Channel-1 INP1 Shorted to MICBIAS (self clearing bit). 0b = INP not shorted to MICBIAS 1b = INP shorted to MICBIAS
2	IN_CH1_LTCH	R	0b	Input Channel-1 INM1 Shorted to MICBIAS (self clearing bit). 0b = INM not shorted to MICBIAS 1b = INM shorted to MICBIAS
1	IN_CH1_LTCH	R	0b	Input Channel-1 INP1 Shorted to VBATIN (self clearing bit). 0b = INP not shorted to VBATIN 1b = INP shorted to VBATIN
0	IN_CH1_LTCH	R	0b	Input Channel-1 INM1 Shorted to VBATIN (self clearing bit). 0b = INM not shorted to VBATIN 1b = INM shorted to VBATIN

#### 7.1.2.19 IN\_CH2\_LTCH Register (Address = 0x37) [Reset = 0x00]

IN\_CH2\_LTCH is shown in [Table 7-97](#).

Return to the [Summary Table](#).

This register is the latched status register for channel 2 input DC faults diagnostics.

**Table 7-97. IN\_CH2\_LTCH Register Field Descriptions**

Bit	Field	Type	Reset	Description
7	IN_CH2_LTCH	R	0b	Input Channel-2(INP2/INM2) Open Inputs (self clearing bit). 0b = No Open Inputs 1b = Open Inputs
6	IN_CH2_LTCH	R	0b	Input Channel-2(INP2/INM2) Inputs Shorted (self clearing bit). 0b = No Input Shorted 1b = Input Shorted each Other
5	IN_CH2_LTCH	R	0b	Input Channel-2 INP2 Shorted to GND (self clearing bit). 0b = INP not shorted to GND 1b = INP shorted to GND
4	IN_CH2_LTCH	R	0b	Input Channel-2 INM2 Shorted to GND (self clearing bit). 0b = INM not shorted to GND 1b = INM shorted to GND
3	IN_CH2_LTCH	R	0b	Input Channel-2 INP2 Shorted to MICBIAS (self clearing bit). 0b = INP not shorted to MICBIAS 1b = INP shorted to MICBIAS
2	IN_CH2_LTCH	R	0b	Input Channel-2 INM2 Shorted to MICBIAS (self clearing bit). 0b = INM not shorted to MICBIAS 1b = INM shorted to MICBIAS
1	IN_CH2_LTCH	R	0b	Input Channel-2 INP2 Shorted to VBATIN (self clearing bit). 0b = INP not shorted to VBATIN 1b = INP shorted to VBATIN

**Table 7-97. IN\_CH2\_LTCH Register Field Descriptions (continued)**

Bit	Field	Type	Reset	Description
0	IN_CH2_LTCH	R	0b	Input Channel-2 INM2 Shorted to VBATIN (self clearing bit). 0b = INM not shorted to VBATIN 1b = INM shorted to VBATIN

**7.1.2.20 ADC\_CHx\_OVRLD Register (Address = 0x38) [Reset = 0x00]**

ADC\_CHx\_OVRLD is shown in [Table 7-98](#).

Return to the [Summary Table](#).

This register is the ADC overload fault detection mask register.

**Table 7-98. ADC\_CHx\_OVRLD Register Field Descriptions**

Bit	Field	Type	Reset	Description
7	RESERVED	R	0b	Reserved bit; Write only reset value
6	RESERVED	R	0b	Reserved bit; Write only reset value
5	RESERVED	R	0b	Reserved bit; Write only reset value
4	RESERVED	R	0b	Reserved bit; Write only reset value
3	MASK_ADC_CH1_OVRLD_FLAG	R/W	0b	ADC CH1 OVRLD fault mask. 0b = Don't Mask 1b = Mask
2	MASK_ADC_CH2_OVRLD_FLAG	R/W	0b	ADC CH2 OVRLD fault mask. 0b = Don't Mask 1b = Mask
1-0	RESERVED	R	0b	Reserved bits; Write only reset value

**7.1.2.21 OUT\_CH2\_LTCH Register (Address = 0x39) [Reset = 0x00]**

OUT\_CH2\_LTCH is shown in [Table 7-99](#).

Return to the [Summary Table](#).

This register is the latched status register for channel 2 output DC faults diagnostics.

**Table 7-99. OUT\_CH2\_LTCH Register Field Descriptions**

Bit	Field	Type	Reset	Description
7	RESERVED	R	0b	Reserved bit; Write only reset value
6	RESERVED	R	0b	Reserved bit; Write only reset value
5	RESERVED	R	0b	Reserved bit; Write only reset value
4	RESERVED	R	0b	Reserved bit; Write only reset value
3-2	RESERVED	R	0b	Reserved bits; Write only reset value
1	MASK_AREG_SC_FLAG	R/W	0b	AREG SC fault mask. 0b = Don't Mask 1b = Mask
0	AREG_SC_FLAG_LTCH	R	0b	AREG SC fault (self clearing bit). 0b = No AREG short circuit fault 1b = AREG short circuit fault

**7.1.2.22 INT\_LTCH1 Register (Address = 0x3A) [Reset = 0x00]**

INT\_LTCH1 is shown in [Table 7-100](#).

Return to the [Summary Table](#).

This is the register 1 for latched interrupt readback.

**Table 7-100. INT\_LTCH1 Register Field Descriptions**

Bit	Field	Type	Reset	Description
7	INT_LTCH1	R	0b	Channel-1 INP1 Over Voltage (self clearing bit). 0b = No INP Over Voltage fault 1b = INP Over Voltage fault has occurred
6	INT_LTCH1	R	0b	Channel-1 INM1 Over Voltage (self clearing bit). 0b = No INM Over Voltage fault 1b = INM Over Voltage fault has occurred
5	INT_LTCH1	R	0b	Channel-2 INP2 Over Voltage (self clearing bit). 0b = No INP Over Voltage fault 1b = INP Over Voltage fault has occurred
4	INT_LTCH1	R	0b	Channel-2 INM2 Over Voltage (self clearing bit). 0b = No INM Over Voltage fault 1b = INM Over Voltage fault has occurred
3	INT_LTCH1	R	0b	Interrupt due to Headset Insert Detection (self clearing bit). 0b = No interrupt 1b = Interrupt
2	INT_LTCH1	R	0b	Interrupt due to Headset Remove Detection (self clearing bit). 0b = No interrupt 1b = Interrupt
1	INT_LTCH1	R	0b	Interrupt due to Headset hook(button) (self clearing bit). 0b = No interrupt 1b = Interrupt
0	INT_LTCH1	R	0b	Interrupt due to MIPS overload (self clearing bit) 0b = No interrupt 1b = Interrupt

### 7.1.2.23 INT\_LTCH2 Register (Address = 0x3B) [Reset = 0x00]

INT\_LTCH2 is shown in [Table 7-101](#).

Return to the [Summary Table](#).

This is the register 2 for latched interrupt readback.

**Table 7-101. INT\_LTCH2 Register Field Descriptions**

Bit	Field	Type	Reset	Description
7	INT_LTCH2	R	0b	Interrupt due to GPA up threshold fault (self clearing bit). 0b = No interrupt 1b = Interrupt
6	INT_LTCH2	R	0b	Interrupt due to GPA low threshold fault (self clearing bit) 0b = No interrupt 1b = Interrupt
5	INT_LTCH2	R	0b	Interrupt due to VAD power up detect (self clearing bit). 0b = No interrupt 1b = Interrupt
4	INT_LTCH2	R	0b	Interrupt due to VAD power down detect (self clearing bit). 0b = No interrupt 1b = Interrupt
3	INT_LTCH2	R	0b	Interrupt due to Micbias short circuit condition (self clearing bit) 0b = No interrupt 1b = Interrupt
2	INT_LTCH2	R	0b	Interrupt due to Micbias High current fault (self clearing bit). 0b = No interrupt 1b = Interrupt

**Table 7-101. INT\_LTCH2 Register Field Descriptions (continued)**

Bit	Field	Type	Reset	Description
1	INT_LTCH2	R	0b	Interrupt due to Micbias Low current fault (self clearing bit) 0b = No interrupt 1b = Interrupt
0	INT_LTCH2	R	0b	Interrupt due to Micbias Over voltage fault (self clearing bit). 0b = No interrupt 1b = Interrupt

**7.1.2.24 INT\_LIVE0 Register (Address = 0x3C) [Reset = 0x00]**

INT\_LIVE0 is shown in [Table 7-102](#).

Return to the [Summary Table](#).

This is the register 0 for live interrupt readback.

**Table 7-102. INT\_LIVE0 Register Field Descriptions**

Bit	Field	Type	Reset	Description
7	INT_LIVE0	R	0b	Interrupt due to clock error . 0b = No interrupt 1b = Interrupt
6	INT_LIVE0	R	0b	Interrupt due to PLL Lock 0b = No interrupt 1b = Interrupt
5	INT_LIVE0	R	0b	Interrupt due to Boost Over Temperature . 0b = No interrupt 1b = Interrupt
4	INT_LIVE0	R	0b	Interrupt due to Boost Over Current.. 0b = No interrupt 1b = Interrupt
3	INT_LIVE0	R	0b	Interrupt due to Boost MO. . 0b = No interrupt 1b = Interrupt
2	RESERVED	R	0b	Reserved bit; Write only reset value
1	RESERVED	R	0b	Reserved bit; Write only reset value
0	RESERVED	R	0b	Reserved bit; Write only reset value

**7.1.2.25 CHx\_LIVE Register (Address = 0x3D) [Reset = 0x00]**

CHx\_LIVE is shown in [Table 7-103](#).

Return to the [Summary Table](#).

This register is the channel level diagnostics live status register.

**Table 7-103. CHx\_LIVE Register Field Descriptions**

Bit	Field	Type	Reset	Description
7	STS_CHx_LIVE	R	0b	Status of Input CH1_LIVE (INP1/INM1). 0b = No faults occurred in input channel 1 1b = Fault or Faults have occurred in input channel 1
6	STS_CHx_LIVE	R	0b	Status of Input CH2_LIVE (INP2/INM2). 0b = No faults occurred in input channel 2 1b = Fault or Faults have occurred in input channel 2
5	RESERVED	R	0b	Reserved bit; Write only reset value
4	RESERVED	R	0b	Reserved bit; Write only reset value



**Table 7-103. CHx\_LIVE Register Field Descriptions (continued)**

Bit	Field	Type	Reset	Description
3	STS_CHx_LIVE	R	0b	Status on fault due "Short to VBATIN fault detected when VBATIN is less than MICBIAS" 0b = Short to VBATIN fault when VBATIN is less than MICBIAS did NOT occur in any channel 1b = Short to VBATIN fault when VBATIN is less than MICBIAS has occurred in at least one channel
2	RESERVED	R	0b	Reserved bit; Write only reset value
1	RESERVED	R	0b	Reserved bit; Write only reset value
0	RESERVED	R	0b	Reserved bit; Write only reset value

### 7.1.2.26 IN\_CH1\_LIVE Register (Address = 0x3E) [Reset = 0x00]

IN\_CH1\_LIVE is shown in [Table 7-104](#).

Return to the [Summary Table](#).

This register is the live status register for channel 1 input DC faults diagnostics.

**Table 7-104. IN\_CH1\_LIVE Register Field Descriptions**

Bit	Field	Type	Reset	Description
7	IN_CH1_LIVE	R	0b	Input Channel-1(INP1/INM1) Open Inputs . 0b = No Open Inputs 1b = Open Inputs
6	IN_CH1_LIVE	R	0b	Input Channel-1(INP1/INM1) Inputs Shorted . 0b = No Input Shorted 1b = Input Shorted each Other
5	IN_CH1_LIVE	R	0b	Input Channel-1 INP1 Shorted to GND . 0b = INP not shorted to GND 1b = INP shorted to GND
4	IN_CH1_LIVE	R	0b	Input Channel-1 INM1 Shorted to GND . 0b = INM not shorted to GND 1b = INM shorted to GND
3	IN_CH1_LIVE	R	0b	Input Channel-1 INP1 Shorted to MICBIAS . 0b = INP not shorted to MICBIAS 1b = INP shorted to MICBIAS
2	IN_CH1_LIVE	R	0b	Input Channel-1 INM1 Shorted to MICBIAS . 0b = INM not shorted to MICBIAS 1b = INM shorted to MICBIAS
1	IN_CH1_LIVE	R	0b	Input Channel-1 INP1 Shorted to VBATIN . 0b = INP not shorted to VBATIN 1b = INP shorted to VBATIN
0	IN_CH1_LIVE	R	0b	Input Channel-1 INM1 Shorted to VBATIN . 0b = INM not shorted to VBATIN 1b = INM shorted to VBATIN

### 7.1.2.27 IN\_CH2\_LIVE Register (Address = 0x3F) [Reset = 0x00]

IN\_CH2\_LIVE is shown in [Table 7-105](#).

Return to the [Summary Table](#).

This register is the live status register for channel 2 input DC faults diagnostics.

**Table 7-105. IN\_CH2\_LIVE Register Field Descriptions**

Bit	Field	Type	Reset	Description
7	IN_CH2_LIVE	R	0b	Input Channel-2(INP2/INM2) Open Inputs . 0b = No Open Inputs 1b = Open Inputs
6	IN_CH2_LIVE	R	0b	Input Channel-2(INP2/INM2) Inputs Shorted . 0b = No Input Shorted 1b = Input Shorted each Other
5	IN_CH2_LIVE	R	0b	Input Channel-2 INP2 Shorted to GND . 0b = INP not shorted to GND 1b = INP shorted to GND
4	IN_CH2_LIVE	R	0b	Input Channel-2 INM2 Shorted to GND . 0b = INM not shorted to GND 1b = INM shorted to GND
3	IN_CH2_LIVE	R	0b	Input Channel-2 INP2 Shorted to MICBIAS . 0b = INP not shorted to MICBIAS 1b = INP shorted to MICBIAS
2	IN_CH2_LIVE	R	0b	Input Channel-2 INM2 Shorted to MICBIAS . 0b = INM not shorted to MICBIAS 1b = INM shorted to MICBIAS
1	IN_CH2_LIVE	R	0b	Input Channel-2 INP2 Shorted to VBATIN . 0b = INP not shorted to VBATIN 1b = INP shorted to VBATIN
0	IN_CH2_LIVE	R	0b	Input Channel-2 INM2 Shorted to VBATIN . 0b = INM not shorted to VBATIN 1b = INM shorted to VBATIN

**7.1.2.28 INT\_LIVE1 Register (Address = 0x42) [Reset = 0x00]**

INT\_LIVE1 is shown in [Table 7-106](#).

Return to the [Summary Table](#).

This is the register 1 for live interrupt readback.

**Table 7-106. INT\_LIVE1 Register Field Descriptions**

Bit	Field	Type	Reset	Description
7	INT_LIVE1	R	0b	Channel-1 INP1 Over Voltage . 0b = No INP Over Voltage fault 1b = INP Over Voltage fault has occurred
6	INT_LIVE1	R	0b	Channel-1 INM1 Over Voltage . 0b = No INM Over Voltage fault 1b = INM Over Voltage fault has occurred
5	INT_LIVE1	R	0b	Channel-2 INP2 Over Voltage . 0b = No INP Over Voltage fault 1b = INP Over Voltage fault has occurred
4	INT_LIVE1	R	0b	Channel-2 INM2 Over Voltage . 0b = No INM Over Voltage fault 1b = INM Over Voltage fault has occurred
3	RESERVED	R	0b	Reserved bit; Write only reset value
2	RESERVED	R	0b	Reserved bit; Write only reset value
1	RESERVED	R	0b	Reserved bit; Write only reset value
0	RESERVED	R	0b	Reserved bit; Write only reset value

**7.1.2.29 INT\_LIVE2 Register (Address = 0x43) [Reset = 0x00]**

INT\_LIVE2 is shown in [Table 7-107](#).

Return to the [Summary Table](#).

This is the register 2 for live interrupt readback.

**Table 7-107. INT\_LIVE2 Register Field Descriptions**

Bit	Field	Type	Reset	Description
7	INT_LIVE2	R	0b	Interrupt due to GPA up threshold fault . 0b = No interrupt 1b = Interrupt
6	INT_LIVE2	R	0b	Interrupt due to GPA low threshold fault 0b = No interrupt 1b = Interrupt
5	INT_LIVE2	R	0b	Interrupt due to VAD power up detect . 0b = No interrupt 1b = Interrupt
4	INT_LIVE2	R	0b	Interrupt due to VAD power down detect . 0b = No interrupt 1b = Interrupt
3	INT_LIVE2	R	0b	Interrupt due to Micbias short circuit condition 0b = No interrupt 1b = Interrupt
2	INT_LIVE2	R	0b	Interrupt due to Micbias High current fault . 0b = No interrupt 1b = Interrupt
1	INT_LIVE2	R	0b	Interrupt due to Micbias Low current fault 0b = No interrupt 1b = Interrupt
0	INT_LIVE2	R	0b	Interrupt due to Micbias Over voltage fault . 0b = No interrupt 1b = Interrupt

### 7.1.2.30 DIAG\_CFG0 Register (Address = 0x46) [Reset = 0x00]

DIAG\_CFG0 is shown in [Table 7-108](#).

Return to the [Summary Table](#).

This is the input diagnostics configuration register 0.

**Table 7-108. DIAG\_CFG0 Register Field Descriptions**

Bit	Field	Type	Reset	Description
7	IN_CH1_DIAG_EN	R/W	0b	Channel-1 Input (IN1P and IN1M) Scan for Diagnostics 0b = Diagnostic Disabled 1b = Diagnostic Enabled
6	IN_CH2_DIAG_EN	R/W	0b	Channel-2 Input (IN2P and IN2M) Scan for Diagnostics 0b = Diagnostic Disabled 1b = Diagnostic Enabled
5	INCL_SE_INM	R/W	0b	INxM pin Diagnostics Scan Selection for Single Ended Configuration 0b = INxM pins of single ended channels are excluded for diagnosis 1b = INxM pins of single ended channels are included for diagnosis
4	INCL_AC_COUP	R/W	0b	AC coupled channels pins Scan Selection for Diagnostics 0b = INxP and INxM pins of AC coupled channels are excluded for diagnosis 1b = INxP and INxM pins of AC coupled channels are included for diagnosis
3	RESERVED	R	0b	Reserved bit; Write only reset value
2	RESERVED	R	0b	Reserved bit; Write only reset value
1	RESERVED	R	0b	Reserved bit; Write only reset value

**Table 7-108. DIAG\_CFG0 Register Field Descriptions (continued)**

Bit	Field	Type	Reset	Description
0	RESERVED	R	0b	Reserved bit; Write only reset value

**7.1.2.31 DIAG\_CFG1 Register (Address = 0x47) [Reset = 0x37]**

DIAG\_CFG1 is shown in [Table 7-109](#).

Return to the [Summary Table](#).

This is the input diagnostics configuration register 1.

**Table 7-109. DIAG\_CFG1 Register Field Descriptions**

Bit	Field	Type	Reset	Description
7-4	DIAG_SHT_TERM[3:0]	R/W	0011b	INxP and INxM Terminal Short Detect Threshold 0d = INxP and INxM Terminal Short Detect Threshold Value is 0 mV 1d = INxP and INxM Terminal Short Detect Threshold Value is 30 mV 2d = INxP and INxM Terminal Short Detect Threshold Value is 60 mV 10d to 13d = INxP and INxM Terminal Short Detect Threshold Value is as per configuration 14d = INxP and INxM Terminal Short Detect Threshold Value is 420 mV 15d = INxP and INxM Terminal Short Detect Threshold Value is 450 mV
3-0	DIAG_SHT_VBAT_IN[3:0]	R/W	0111b	Short to VBATIN Detect Threshold 0d = Short to VBATIN Detect Threshold Value is 0 mV 1d = Short to VBATIN Detect Threshold Value is 30 mV 2d = Short to VBATIN Detect Threshold Value is 60 mV 10d to 13d = Short to VBATIN Detect Threshold Value is as per configuration 14d = Short to VBATIN Detect Threshold Value is 420 mV 15d = Short to VBATIN Detect Threshold Value is 450 mV

**7.1.2.32 DIAG\_CFG2 Register (Address = 0x48) [Reset = 0x87]**

DIAG\_CFG2 is shown in [Table 7-110](#).

Return to the [Summary Table](#).

This is the input diagnostics configuration register 2.

**Table 7-110. DIAG\_CFG2 Register Field Descriptions**

Bit	Field	Type	Reset	Description
7-4	DIAG_SHT_GND[3:0]	R/W	1000b	Short to GND Detect Threshold 0d = Short to GND Detect Threshold Value is 0 mV 1d = Short to GND Detect Threshold Value is 60 mV 2d = Short to GND Detect Threshold Value is 120 mV 10d to 13d = Short to GND Detect Threshold Value is as per configuration 14d = Short to GND Detect Threshold Value is 840 mV 15d = Short to GND Detect Threshold Value is 900 mV
3-0	DIAG_SHT_MICBIAS[3:0]	R/W	0111b	Short to MICBIAS Detect Threshold 0d = Short to MICBIAS Detect Threshold Value is 0 mV 1d = Short to MICBIAS Detect Threshold Value is 30 mV 2d = Short to MICBIAS Detect Threshold Value is 60 mV 10d to 13d = Short to MICBIAS Detect Threshold Value is as per configuration 14d = Short to MICBIAS Detect Threshold Value is 420 mV 15d = Short to MICBIAS Detect Threshold Value is 450 mV

### 7.1.2.33 DIAG\_CFG4 Register (Address = 0x4A) [Reset = 0xB8]

DIAG\_CFG4 is shown in [Table 7-111](#).

Return to the [Summary Table](#).

This is the input diagnostics configuration register 4.

**Table 7-111. DIAG\_CFG4 Register Field Descriptions**

Bit	Field	Type	Reset	Description
7-6	RESERVED	R	0b	Reserved bits; Write only reset values
5-4	RESERVED	R	0b	Reserved bits; Write only reset values
3-2	FAULT_DBNCE_SEL[1:0]	R/W	10b	Debounce count for all the faults (except VBATIN short when VBATIN < Micbias) 0b = 16 counts for debounce to filter-out false faults detection 1b = 8 counts for debounce to filter-out false faults detection 2b = 4 counts for debounce to filter-out false faults detection 3b = No debounce count
1	VSHORT_DBNCE	R/W	0b	VBATIN short debounce count 0b = 16 counts for debounce to filter-out false faults detection 1b = 8 counts for debounce to filter-out false faults detection
0	DIAG_2X_THRES	R/W	0b	Diagnostic thresholds range scale 0d = Thresholds same as configured 1d = All the configuration thresholds gets scale by 2 times

### 7.1.2.34 DIAG\_CFG5 Register (Address = 0x4B) [Reset = 0x00]

DIAG\_CFG5 is shown in [Table 7-112](#).

Return to the [Summary Table](#).

This is the input diagnostics configuration register 5.

**Table 7-112. DIAG\_CFG5 Register Field Descriptions**

Bit	Field	Type	Reset	Description
7-6	RESERVED	R	0b	Reserved bits; Write only reset values
5	RESERVED	R	0b	Reserved bit; Write only reset value
4	RESERVED	R	0b	Reserved bit; Write only reset value
3	RESERVED	R	0b	Reserved bit; Write only reset value
2-0	RESERVED	R	0b	Reserved bits; Write only reset values

### 7.1.2.35 DIAG\_CFG6 Register (Address = 0x4C) [Reset = 0xA2]

DIAG\_CFG6 is shown in [Table 7-113](#).

Return to the [Summary Table](#).

This is the input diagnostics configuration register 6.

**Table 7-113. DIAG\_CFG6 Register Field Descriptions**

Bit	Field	Type	Reset	Description
7-0	MBIAS_HIGH_CURR_TH RS[7:0]	R/W	10100010b	Threshold for Micbias High current fault diagnostics Default = ~ 18mA $N_d = ((0.9 \cdot (N \cdot 16) / 4095) - 0.2) \times 48.46154 \text{ (mA)}$

### 7.1.2.36 DIAG\_CFG7 Register (Address = 0x4D) [Reset = 0x48]

DIAG\_CFG7 is shown in [Table 7-114](#).

Return to the [Summary Table](#).

This is the input diagnostics configuration register 7.

**Table 7-114. DIAG\_CFG7 Register Field Descriptions**

Bit	Field	Type	Reset	Description
7-0	MBIAS_LOW_CURR_TH RS[7:0]	R/W	01001000b	Threshold for Micbias Low current fault diagnostics Default = ~ 2.6mA $Nd = ((0.9 \cdot (N \cdot 16) / 4095) - 0.2) \times 48.46154 \text{ (mA)}$

#### 7.1.2.37 DIAG\_CFG8 Register (Address = 0x4E) [Reset = 0xBA]

DIAG\_CFG8 is shown in [Table 7-115](#).

Return to the [Summary Table](#).

This is the input diagnostics configuration register 8.

**Table 7-115. DIAG\_CFG8 Register Field Descriptions**

Bit	Field	Type	Reset	Description
7-0	GPA_UP_THRS_FLT_TH RES[7:0]	R/W	10111010b	General Purpose Analog High Threshold Default = ~ 2.6V $nd = ((0.9 \cdot (N \cdot 16) / 4095) - 0.225) \times 6 \text{ (V)}$

#### 7.1.2.38 DIAG\_CFG9 Register (Address = 0x4F) [Reset = 0x4B]

DIAG\_CFG9 is shown in [Table 7-116](#).

Return to the [Summary Table](#).

This is the input diagnostics configuration register 9.

**Table 7-116. DIAG\_CFG9 Register Field Descriptions**

Bit	Field	Type	Reset	Description
7-0	GPA_LOW_THRS_FLT_T HRES[7:0]	R/W	01001011b	General Purpose Analog Low Threshold Default = ~ 0.2V $nd = ((0.9 \cdot (N \cdot 16) / 4095) - 0.225) \times 6 \text{ (V)}$

#### 7.1.2.39 DIAG\_CFG10 Register (Address = 0x50) [Reset = 0x88]

DIAG\_CFG10 is shown in [Table 7-117](#).

Return to the [Summary Table](#).

This is the input diagnostics configuration register 10.

**Table 7-117. DIAG\_CFG10 Register Field Descriptions**

Bit	Field	Type	Reset	Description
7	PD_MBIAS_SHRT_CKT_FLT	R/W	1b	Power down configuration of Micbias during Short Circuit fault 0b = No change when fault occurs 1b = Micbias is disabled when fault occurs
6	PD_MBIAS_HIGH_CURR_FLT	R/W	0b	Power down configuration of Micbias during High current fault 0b = No change when fault occurs 1b = Micbias is disabled when fault occurs
5	PD_MBIAS_LOW_CURR_FLT	R/W	0b	Power down configuration of Micbias during Low current fault 0b = No change when fault occurs 1b = Micbias is disabled when fault occurs

**Table 7-117. DIAG\_CFG10 Register Field Descriptions (continued)**

Bit	Field	Type	Reset	Description
4	PD_MBIAS_OV_FLT	R/W	0b	Power down configuration of Micbias during high voltage fault 0b = No change when fault occurs 1b = Micbias is disabled when fault occurs
3	PD_MBIAS_OT_FLT	R/W	1b	Power down configuration of Micbias during over temperature fault 0b = No change when fault occurs 1b = Micbias is disabled when fault occurs
2	MAN_RCV_PD_FLT_CHK	R/W	0b	Manual Recovery (self clear bit) 0b = No effect 1b = Recheck fault status and re-powerup channels if they do not have any faults
1	MBIAS_FLT_AUTO_REC_EN	R/W	0b	Micbias PD on faults Auto-Recovery Enable 0d = Auto recovery from Micbias faults disabled 1d = Auto recovery enabled
0	MICBIAS_SHRT_CKT_DET_T_DIS	R/W	0b	Micbias Short Circuit fault detect config 0b = enable 1b = disable

#### 7.1.2.40 DIAG\_CFG11 Register (Address = 0x51) [Reset = 0x40]

DIAG\_CFG11 is shown in [Table 7-118](#).

Return to the [Summary Table](#).

This is the input diagnostics configuration register 11.

**Table 7-118. DIAG\_CFG11 Register Field Descriptions**

Bit	Field	Type	Reset	Description
7-5	SAFE BAND_MBIAS_OV_FLT[2:0]	R/W	010b	Safe band cfgn for Micbias over voltage fault's lower boundary 0 = No safe band 1 = 30mV safe band (1LSb at 9b lvl) 2 = 60mV safe band (2LSb at 9b lvl) 3-7 = N*30mV
4-0	RESERVED	R	0b	Reserved bits; Write only reset values

#### 7.1.2.41 DIAG\_CFG12 Register (Address = 0x52) [Reset = 0x44]

DIAG\_CFG12 is shown in [Table 7-119](#).

Return to the [Summary Table](#).

This is the input diagnostics configuration register 12.

**Table 7-119. DIAG\_CFG12 Register Field Descriptions**

Bit	Field	Type	Reset	Description
7-5	SAFE BAND_INx_MBIAS_FLT[2:0]	R/W	010b	Safe band cfgn for INx Short to Micbias fault's upper boundary 0 = No safe band 1 = 30mV safe band (1LSb at 9b lvl) 2 = 60mV safe band (2LSb at 9b lvl) 3-7 = N*30mV
4-2	SAFE BAND_INx_OV_FLT[2:0]	R/W	001b	Safe band cfgn for INx Overvoltage fault's lower boundary 0 = No safe band 1 = 30mV safe band (1LSb at 9b lvl) 2-7 = N*30mV
1-0	RESERVED	R	0b	Reserved bits; Write only reset values

### 7.1.2.42 DIAG\_CFG13 Register (Address = 0x53) [Reset = 0x00]

DIAG\_CFG13 is shown in [Table 7-120](#).

Return to the [Summary Table](#).

This is the input diagnostics configuration register 13.

**Table 7-120. DIAG\_CFG13 Register Field Descriptions**

Bit	Field	Type	Reset	Description
7	DIAG_FORCE_EN	R/W	0b	Configuration for auto/manual enable for diag vbat, micbias, micbias load, temp 0b = Auto enabled (auto enabled if at least one of the input channel diagnostics is enabled in DIAG_CFG0) 1b = Manual en/disable based on DIAG_CFG13 Register
6	DIAG_EN_MICBIAS_LOAD	R/W	0b	Micbias current/load channel enable for Diagnostics, valid if DIAG_FORCE_EN = 1 0b = Diagnostic Disabled 1b = Diagnostic Enabled
5	DIAG_EN_MICBIAS	R/W	0b	Micbias channel enable for Diagnostics, valid if DIAG_FORCE_EN = 1 0b = Diagnostic Disabled 1b = Diagnostic Enabled
4	DIAG_EN_VBAT	R/W	0b	VBAT channel enable for Diagnostics, valid if DIAG_FORCE_EN = 1 0b = Diagnostic Disabled 1b = Diagnostic Enabled
3	DIAG_EN_TEMP_SENSE	R/W	0b	Temp sense channel enable for Diagnostics, valid if DIAG_FORCE_EN = 1 0b = Diagnostic Disabled 1b = Diagnostic Enabled
2	DIAG_EN_AVDD	R/W	0b	AVDD channel enable for Diagnostics 0b = Diagnostic Disabled 1b = Diagnostic Enabled
1	DIAG_EN_GPA	R/W	0b	GPA channel enable for Diagnostics 0b = Diagnostic Disabled 1b = Diagnostic Enabled
0	RESERVED	R	0b	Reserved bit; Write only reset value

### 7.1.2.43 DIAG\_CFG14 Register (Address = 0x54) [Reset = 0x48]

DIAG\_CFG14 is shown in [Table 7-121](#).

Return to the [Summary Table](#).

This is the input diagnostics configuration register 14.

**Table 7-121. DIAG\_CFG14 Register Field Descriptions**

Bit	Field	Type	Reset	Description
7	RESERVED	R	0b	Reserved bit; Write only reset value
6-5	AVDD_FILT_SEL[1:0]	R/W	10b	AVDD filter select 0d = 3.5MHz 1d = 200kHz 2d = 100kHz 3d = No filter
4	RESERVED	R	0b	Reserved bit; Write only reset value
3-2	VBAT_FILT_SEL[1:0]	R/W	10b	VBAT filter select 0d = 3.5MHz 1d = 200kHz 2d = 100kHz 3d = No filter
1	RESERVED	R	0b	Reserved bit; Write only reset value



**Table 7-121. DIAG\_CFG14 Register Field Descriptions (continued)**

Bit	Field	Type	Reset	Description
0	VBAT_SHRT_FLT	R/W	0b	Cfgn on INx short to VBAT 0 = INx Overvoltage and INx short to VBAT are separate 1 = INx Overvoltage and INx short to VBAT are Ord together as VBAT short fault

#### 7.1.2.44 DIAGDATA\_CFG Register (Address = 0x55) [Reset = 0x00]

DIAGDATA\_CFG is shown in [Table 7-122](#).

Return to the [Summary Table](#).

This register is the input diagnostics data configuration register.

**Table 7-122. DIAGDATA\_CFG Register Field Descriptions**

Bit	Field	Type	Reset	Description
7-4	RESERVED	R	0b	Reserved bits; Write only reset values
3	RESERVED	R	0b	Reserved bit; Write only reset value
2	RESERVED	R	0b	Reserved bit; Write only reset value
1	OVRD_VBAT_TEMP_DATA	R/W	0b	Override VBAT and TEMP data 0b= Override Disabled 1b= Override Enabled
0	HOLD_SAR_DATA	R/W	0b	Hold SAR data update during register readback 0b= Data update is not held, Data register is continuously updated 1b= Data update is held, Data register readback can be done

#### 7.1.2.45 DIAG\_MON\_MSB\_VBAT Register (Address = 0x56) [Reset = 0x00]

DIAG\_MON\_MSB\_VBAT is shown in [Table 7-123](#).

Return to the [Summary Table](#).

This register is the diagnostics SAR VBATIN monitor data MSB byte register.

**Table 7-123. DIAG\_MON\_MSB\_VBAT Register Field Descriptions**

Bit	Field	Type	Reset	Description
7-0	DIAG_MON_MSB_VBAT[7:0]	R	00000000b	Diagnostic SAR Monitor Data MSB Byte

#### 7.1.2.46 DIAG\_MON\_LSB\_VBAT Register (Address = 0x57) [Reset = 0x00]

DIAG\_MON\_LSB\_VBAT is shown in [Table 7-124](#).

Return to the [Summary Table](#).

This register is the diagnostics SAR VBATIN monitor data LSB nibble register.

**Table 7-124. DIAG\_MON\_LSB\_VBAT Register Field Descriptions**

Bit	Field	Type	Reset	Description
7-4	DIAG_MON_LSB_VBAT[3:0]	R	0000b	Diagnostic SAR Monitor Data LSB Nibble
3-0	Channel[3:0]	R	0000b	Channel ID

**7.1.2.47 DIAG\_MON\_MSB\_MBIAS Register (Address = 0x58) [Reset = 0x00]**

DIAG\_MON\_MSB\_MBIAS is shown in [Table 7-125](#).

Return to the [Summary Table](#).

This register is the diagnostics SAR MICBIAS monitor data MSB byte register.

**Table 7-125. DIAG\_MON\_MSB\_MBIAS Register Field Descriptions**

Bit	Field	Type	Reset	Description
7-0	DIAG_MON_MSB_MBIAS[7:0]	R	00000000b	Diagnostic SAR Monitor Data MSB Byte

**7.1.2.48 DIAG\_MON\_LSB\_MBIAS Register (Address = 0x59) [Reset = 0x01]**

DIAG\_MON\_LSB\_MBIAS is shown in [Table 7-126](#).

Return to the [Summary Table](#).

This register is the diagnostics SAR MICBIAS monitor data LSB nibble.

**Table 7-126. DIAG\_MON\_LSB\_MBIAS Register Field Descriptions**

Bit	Field	Type	Reset	Description
7-4	DIAG_MON_LSB_MBIAS[3:0]	R	0000b	Diagnostic SAR Monitor Data LSB Nibble
3-0	Channel[3:0]	R	0001b	Channel ID

**7.1.2.49 DIAG\_MON\_MSB\_IN1P Register (Address = 0x5A) [Reset = 0x00]**

DIAG\_MON\_MSB\_IN1P is shown in [Table 7-127](#).

Return to the [Summary Table](#).

This register is the diagnostics SAR IN1P monitor data MSB byte register.

**Table 7-127. DIAG\_MON\_MSB\_IN1P Register Field Descriptions**

Bit	Field	Type	Reset	Description
7-0	DIAG_MON_MSB_IN_CH1P[7:0]	R	00000000b	Diagnostic SAR Monitor Data MSB Byte

**7.1.2.50 DIAG\_MON\_LSB\_IN1P Register (Address = 0x5B) [Reset = 0x02]**

DIAG\_MON\_LSB\_IN1P is shown in [Table 7-128](#).

Return to the [Summary Table](#).

This register is the diagnostics SAR IN1P monitor data LSB nibble register.

**Table 7-128. DIAG\_MON\_LSB\_IN1P Register Field Descriptions**

Bit	Field	Type	Reset	Description
7-4	DIAG_MON_LSB_IN_CH1P[3:0]	R	0000b	Diagnostic SAR Monitor Data LSB Nibble
3-0	Channel[3:0]	R	0010b	Channel ID

**7.1.2.51 DIAG\_MON\_MSB\_IN1M Register (Address = 0x5C) [Reset = 0x00]**

DIAG\_MON\_MSB\_IN1M is shown in [Table 7-129](#).

Return to the [Summary Table](#).

This register is the diagnostics SAR IN1M monitor data MSB byte register.

**Table 7-129. DIAG\_MON\_MSB\_IN1M Register Field Descriptions**

Bit	Field	Type	Reset	Description
7-0	DIAG_MON_MSB_IN_CH1N[7:0]	R	00000000b	Diagnostic SAR Monitor Data MSB Byte

#### 7.1.2.52 DIAG\_MON\_LSB\_IN1M Register (Address = 0x5D) [Reset = 0x03]

DIAG\_MON\_LSB\_IN1M is shown in [Table 7-130](#).

Return to the [Summary Table](#).

This register is the diagnostics SAR IN1M monitor data LSB nibble register.

**Table 7-130. DIAG\_MON\_LSB\_IN1M Register Field Descriptions**

Bit	Field	Type	Reset	Description
7-4	DIAG_MON_LSB_IN_CH1N[3:0]	R	0000b	Diagnostic SAR Monitor Data LSB Nibble
3-0	Channel[3:0]	R	0011b	Channel ID

#### 7.1.2.53 DIAG\_MON\_MSB\_IN2P Register (Address = 0x5E) [Reset = 0x00]

DIAG\_MON\_MSB\_IN2P is shown in [Table 7-131](#).

Return to the [Summary Table](#).

This register is the diagnostics SAR IN2P monitor data MSB byte register.

**Table 7-131. DIAG\_MON\_MSB\_IN2P Register Field Descriptions**

Bit	Field	Type	Reset	Description
7-0	DIAG_MON_MSB_IN_CH2P[7:0]	R	00000000b	Diagnostic SAR Monitor Data MSB Byte

#### 7.1.2.54 DIAG\_MON\_LSB\_IN2P Register (Address = 0x5F) [Reset = 0x04]

DIAG\_MON\_LSB\_IN2P is shown in [Table 7-132](#).

Return to the [Summary Table](#).

This register is the diagnostics SAR IN2P monitor data LSB nibble register.

**Table 7-132. DIAG\_MON\_LSB\_IN2P Register Field Descriptions**

Bit	Field	Type	Reset	Description
7-4	DIAG_MON_LSB_IN_CH2P[3:0]	R	0000b	Diagnostic SAR Monitor Data LSB Nibble
3-0	Channel[3:0]	R	0100b	Channel ID

#### 7.1.2.55 DIAG\_MON\_MSB\_IN2M Register (Address = 0x60) [Reset = 0x00]

DIAG\_MON\_MSB\_IN2M is shown in [Table 7-133](#).

Return to the [Summary Table](#).

This register is the diagnostics SAR IN2M monitor data MSB byte register.

**Table 7-133. DIAG\_MON\_MSB\_IN2M Register Field Descriptions**

Bit	Field	Type	Reset	Description
7-0	DIAG_MON_MSB_IN_CH 2N[7:0]	R	00000000b	Diagnostic SAR Monitor Data MSB Byte

**7.1.2.56 DIAG\_MON\_LSB\_IN2M Register (Address = 0x61) [Reset = 0x05]**

DIAG\_MON\_LSB\_IN2M is shown in [Table 7-134](#).

Return to the [Summary Table](#).

This register is the diagnostics SAR IN2M monitor data LSB nibble register.

**Table 7-134. DIAG\_MON\_LSB\_IN2M Register Field Descriptions**

Bit	Field	Type	Reset	Description
7-4	DIAG_MON_LSB_IN_CH2 N[3:0]	R	0000b	Diagnostic SAR Monitor Data LSB Nibble
3-0	Channel[3:0]	R	0101b	Channel ID

**7.1.2.57 DIAG\_MON\_MSB\_TEMP Register (Address = 0x6A) [Reset = 0x00]**

DIAG\_MON\_MSB\_TEMP is shown in [Table 7-135](#).

Return to the [Summary Table](#).

This register is the diagnostics SAR Temperature monitor data MSB byte register.

**Table 7-135. DIAG\_MON\_MSB\_TEMP Register Field Descriptions**

Bit	Field	Type	Reset	Description
7-0	DIAG_MON_MSB_TEMP[ 7:0]	R	00000000b	Diagnostic SAR Monitor Data MSB Byte

**7.1.2.58 DIAG\_MON\_LSB\_TEMP Register (Address = 0x6B) [Reset = 0x0A]**

DIAG\_MON\_LSB\_TEMP is shown in [Table 7-136](#).

Return to the [Summary Table](#).

This register is the diagnostics SAR Temperature monitor data LSB nibble register.

**Table 7-136. DIAG\_MON\_LSB\_TEMP Register Field Descriptions**

Bit	Field	Type	Reset	Description
7-4	DIAG_MON_LSB_TEMP[ 3:0]	R	0000b	Diagnostic SAR Monitor Data LSB Nibble
3-0	Channel[3:0]	R	1010b	Channel ID

**7.1.2.59 DIAG\_MON\_MSB\_MBIAS\_LOAD Register (Address = 0x6C) [Reset = 0x00]**

DIAG\_MON\_MSB\_MBIAS\_LOAD is shown in [Table 7-137](#).

Return to the [Summary Table](#).

This register is the diagnostics SAR MICBIAS LOAD Current monitor data MSB byte register.

**Table 7-137. DIAG\_MON\_MSB\_MBIAS\_LOAD Register Field Descriptions**

Bit	Field	Type	Reset	Description
7-0	DIAG_MON_MSB_MBIAS_LOAD[7:0]	R	00000000b	Diagnostic SAR Monitor Data MSB Byte

#### 7.1.2.60 DIAG\_MON\_LSB\_MBIAS\_LOAD Register (Address = 0x6D) [Reset = 0x0B]

DIAG\_MON\_LSB\_MBIAS\_LOAD is shown in [Table 7-138](#).

Return to the [Summary Table](#).

This register is the diagnostic SAR MICBIAS LOAD Current monitor data LSB nibble register.

**Table 7-138. DIAG\_MON\_LSB\_MBIAS\_LOAD Register Field Descriptions**

Bit	Field	Type	Reset	Description
7-4	DIAG_MON_LSB_MBIAS_LOAD[3:0]	R	0000b	Diagnostic SAR Monitor Data LSB Nibble
3-0	Channel[3:0]	R	1011b	Channel ID

#### 7.1.2.61 DIAG\_MON\_MSB\_AVDD Register (Address = 0x6E) [Reset = 0x00]

DIAG\_MON\_MSB\_AVDD is shown in [Table 7-139](#).

Return to the [Summary Table](#).

This register is the diagnostic SAR AVDD monitor data MSB byte register.

**Table 7-139. DIAG\_MON\_MSB\_AVDD Register Field Descriptions**

Bit	Field	Type	Reset	Description
7-0	DIAG_MON_MSB_AVDD[7:0]	R	00000000b	Diagnostic SAR Monitor Data MSB Byte

#### 7.1.2.62 DIAG\_MON\_LSB\_AVDD Register (Address = 0x6F) [Reset = 0x0C]

DIAG\_MON\_LSB\_AVDD is shown in [Table 7-140](#).

Return to the [Summary Table](#).

This register is the diagnostic SAR AVDD monitor data LSB nibble register

**Table 7-140. DIAG\_MON\_LSB\_AVDD Register Field Descriptions**

Bit	Field	Type	Reset	Description
7-4	DIAG_MON_LSB_AVDD[3:0]	R	0000b	Diagnostic SAR Monitor Data LSB Nibble
3-0	Channel[3:0]	R	1100b	Channel ID

#### 7.1.2.63 DIAG\_MON\_MSB\_GPA Register (Address = 0x70) [Reset = 0x00]

DIAG\_MON\_MSB\_GPA is shown in [Table 7-141](#).

Return to the [Summary Table](#).

This register is the diagnostic SAR GPA monitor data MSB byte register.

**Table 7-141. DIAG\_MON\_MSB\_GPA Register Field Descriptions**

Bit	Field	Type	Reset	Description
7-0	DIAG_MON_MSB_GPA[7:0]	R	00000000b	Diagnostic SAR Monitor Data MSB Byte

**7.1.2.64 DIAG\_MON\_LSB\_GPA Register (Address = 0x71) [Reset = 0x0D]**

DIAG\_MON\_LSB\_GPA is shown in [Table 7-142](#).

Return to the [Summary Table](#).

This register is the diagnostic SAR GPA monitor data LSB nibble register.

**Table 7-142. DIAG\_MON\_LSB\_GPA Register Field Descriptions**

Bit	Field	Type	Reset	Description
7-4	DIAG_MON_LSB_GPA[3:0]	R	0000b	Diagnostic SAR Monitor Data LSB Nibble
3-0	Channel[3:0]	R	1101b	Channel ID

**7.1.2.65 BOOST\_CFG Register (Address = 0x72) [Reset = 0x00]**

BOOST\_CFG is shown in [Table 7-143](#).

Return to the [Summary Table](#).

This register is the boost configuration register.

**Table 7-143. BOOST\_CFG Register Field Descriptions**

Bit	Field	Type	Reset	Description
7	BOOST_DIS	R/W	0b	Boost Enable/Disable 0d = Internal Boost enable 1d = Internal Boost disable/bypass
6	RESERVED	R	0b	Reserved bit; Write only reset value
5	RESERVED	R	0b	Reserved bit; Write only reset value
4	RESERVED	R	0b	Reserved bit; Write only reset value
3	RESERVED	R	0b	Reserved bit; Write only reset value
2-0	RESERVED	R	0b	Reserved bits; Write only reset values

**7.1.2.66 MICBIAS\_CFG Register (Address = 0x73) [Reset = 0xA0]**

MICBIAS\_CFG is shown in [Table 7-144](#).

Return to the [Summary Table](#).

This register is the micbias configuration register.

**Table 7-144. MICBIAS\_CFG Register Field Descriptions**

Bit	Field	Type	Reset	Description
7-4	MICBIAS_VAL[3:0]	R/W	1010b	Micbias Value 0d = Microphone Bias output is bypassed to BSTOUT/HVDD 1d = Microphone Bias is set to 3.0 V 2d = Microphone Bias is set to 3.5 V 3d = Microphone Bias is set to 4.0 V 4d = Microphone Bias is set to 4.5 V 5d = Microphone Bias is set to 5 V 6d = Microphone Bias is set to 5.5 V 7d = Microphone Bias is set to 6 V 8d = Microphone Bias is set to 6.5 V 9d = Microphone Bias is set to 7 V 10d = Microphone Bias is set to 7.5 V 11d = Microphone Bias is set to 8 V 12d = Microphone Bias is set to 8.5 V 13d = Microphone Bias is set to 9 V 14d = Microphone Bias is set to 9.5 V 15d = Microphone Bias is set to 10 V
3-0	RESERVED	R	0b	Reserved bits; Write only reset value

### 7.1.3 TAA5412-Q1\_B0\_P3 Registers

Table 7-145 lists the memory-mapped registers for the TAA5412-Q1\_B0\_P3 registers. All register offset addresses not listed in Table 7-145 should be considered as reserved locations and the register contents should not be modified.

**Table 7-145. TAA5412-Q1\_B0\_P3 Registers**

Address	Acronym	Register Name	Reset Value	Section
0x0	PAGE_CFG	Device page register	0x00	<a href="#">Section 7.1.3.1</a>
0x1A	SASI_CFG0	Secondary ASI configuration register 0	0x30	<a href="#">Section 7.1.3.2</a>
0x1B	SASI_TX_CFG0	SASI TX configuration register 0	0x00	<a href="#">Section 7.1.3.3</a>
0x1C	SASI_TX_CFG1	SASI TX configuration register 1	0x00	<a href="#">Section 7.1.3.4</a>
0x1D	SASI_TX_CFG2	SASI TX configuration register 2	0x00	<a href="#">Section 7.1.3.5</a>
0x1E	SASI_TX_CH1_CFG	SASI TX Channel 1 configuration register	0x00	<a href="#">Section 7.1.3.6</a>
0x1F	SASI_TX_CH2_CFG	SASI TX Channel 2 configuration register	0x01	<a href="#">Section 7.1.3.7</a>
0x20	SASI_TX_CH3_CFG	SASI TX Channel 3 configuration register	0x02	<a href="#">Section 7.1.3.8</a>
0x21	SASI_TX_CH4_CFG	SASI TX Channel 4 configuration register	0x03	<a href="#">Section 7.1.3.9</a>
0x22	SASI_TX_CH5_CFG	SASI TX Channel 5 configuration register	0x04	<a href="#">Section 7.1.3.10</a>
0x23	SASI_TX_CH6_CFG	SASI TX Channel 6 configuration register	0x05	<a href="#">Section 7.1.3.11</a>
0x24	SASI_TX_CH7_CFG	SASI TX Channel 7 configuration register	0x06	<a href="#">Section 7.1.3.12</a>
0x32	CLK_CFG12	Clock configuration register 12	0x00	<a href="#">Section 7.1.3.13</a>
0x33	CLK_CFG13	Clock configuration register 13	0x00	<a href="#">Section 7.1.3.14</a>
0x34	CLK_CFG14	Clock configuration register 14	0x10	<a href="#">Section 7.1.3.15</a>
0x35	CLK_CFG15	Clock configuration register 15	0x01	<a href="#">Section 7.1.3.16</a>
0x36	CLK_CFG16	Clock configuration register 16	0x00	<a href="#">Section 7.1.3.17</a>
0x37	CLK_CFG17	Clock configuration register 17	0x00	<a href="#">Section 7.1.3.18</a>
0x38	CLK_CFG18	Clock configuration register 18	0x08	<a href="#">Section 7.1.3.19</a>
0x39	CLK_CFG19	Clock configuration register 19	0x20	<a href="#">Section 7.1.3.20</a>
0x3A	CLK_CFG20	Clock configuration register 20	0x04	<a href="#">Section 7.1.3.21</a>
0x3B	CLK_CFG21	Clock configuration register 21	0x00	<a href="#">Section 7.1.3.22</a>
0x3C	CLK_CFG22	Clock configuration register 22	0x01	<a href="#">Section 7.1.3.23</a>
0x3D	CLK_CFG23	Clock configuration register 23	0x01	<a href="#">Section 7.1.3.24</a>
0x3E	CLK_CFG24	Clock configuration register 24	0x01	<a href="#">Section 7.1.3.25</a>
0x44	CLK_CFG30	Clock configuration register 30	0x00	<a href="#">Section 7.1.3.26</a>
0x45	CLK_CFG31	Clock configuration register 31	0x00	<a href="#">Section 7.1.3.27</a>
0x46	CLKOUT_CFG1	CLKOUT configuration register 1	0x00	<a href="#">Section 7.1.3.28</a>
0x47	CLKOUT_CFG2	CLKOUT configuration register 2	0x01	<a href="#">Section 7.1.3.29</a>
0x48	BSTCLK_CFG1	Boost clock configuration register 1	0x00	<a href="#">Section 7.1.3.30</a>
0x49	SARCLK_CFG1	SAR clock configuration register 1	0x00	<a href="#">Section 7.1.3.31</a>
0x5B	ADC_OVRD_FLAG	ADC overload flag register	0x00	<a href="#">Section 7.1.3.32</a>

#### 7.1.3.1 PAGE\_CFG Register (Address = 0x0) [Reset = 0x00]

PAGE\_CFG is shown in Table 7-146.

Return to the [Summary Table](#).

The device memory map is divided into pages. This register sets the page.



**Table 7-146. PAGE\_CFG Register Field Descriptions**

Bit	Field	Type	Reset	Description
7-0	PAGE[7:0]	R/W	00000000b	These bits set the device page. 0d = Page 0 1d = Page 1 2d to 254d = Page 2 to page 254 respectively 255d = Page 255

### 7.1.3.2 SASI\_CFG0 Register (Address = 0x1A) [Reset = 0x30]

SASI\_CFG0 is shown in [Table 7-147](#).

Return to the [Summary Table](#).

This register is the ASI configuration register 0.

**Table 7-147. SASI\_CFG0 Register Field Descriptions**

Bit	Field	Type	Reset	Description
7-6	SASI_FORMAT[1:0]	R/W	00b	Secondary ASI protocol format. 0d = TDM mode 1d = I <sup>2</sup> S mode 2d = LJ (left-justified) mode 3d = Reserved; Don't use
5-4	SASI_WLEN[1:0]	R/W	11b	Secondary ASI word or slot length. 0d = 16 bits (Recommended this setting to be used with 10kΩ input impedance configuration) 1d = 20 bits 2d = 24 bits 3d = 32 bits
3	SASI_FSYNC_POL	R/W	0b	ASI FSYNC polarity (for SASI protocol only). 0d = Default polarity as per standard protocol 1d = Inverted polarity with respect to standard protocol
2	SASI_BCLK_POL	R/W	0b	ASI BCLK polarity (for SASI protocol only). 0d = Default polarity as per standard protocol 1d = Inverted polarity with respect to standard protocol
1	SASI_BUS_ERR	R/W	0b	ASI bus error detection. 0d = Enable bus error detection 1d = Disable bus error detection
0	SASI_BUS_ERR_RCOV	R/W	0b	ASI bus error auto resume. 0d = Enable auto resume after bus error recovery 1d = Disable auto resume after bus error recovery and remain powered down until host configures the device

### 7.1.3.3 SASI\_TX\_CFG0 Register (Address = 0x1B) [Reset = 0x00]

SASI\_TX\_CFG0 is shown in [Table 7-148](#).

Return to the [Summary Table](#).

This register is the SASI TX configuration register 0.

**Table 7-148. SASI\_TX\_CFG0 Register Field Descriptions**

Bit	Field	Type	Reset	Description
7	SASI_TX_EDGE	R/W	0b	Secondary ASI data output (on the primary and secondary data pin) transmit edge. 0d = Default edge as per the protocol configuration setting in SASI_BCLK_POL 1d = Inverted following edge (half cycle delay) with respect to the default edge setting

**Table 7-148. SASI\_TX\_CFG0 Register Field Descriptions (continued)**

Bit	Field	Type	Reset	Description
6	SASI_TX_FILL	R/W	0b	Secondary ASI data output (on the primary and secondary data pin) for any unused cycles 0d = Always transmit 0 for unused cycles 1d = Always use Hi-Z for unused cycles
5	SASI_TX_LSB	R/W	0b	Secondary ASI data output (on the primary and secondary data pin) for LSB transmissions. 0d = Transmit the LSB for a full cycle 1d = Transmit the LSB for the first half cycle and Hi-Z for the second half cycle
4-3	SASI_TX_KEEPER[1:0]	R/W	00b	Secondary ASI data output (on the primary and secondary data pin) bus keeper. 0d = Bus keeper is always disabled 1d = Bus keeper is always enabled 2d = Bus keeper is enabled during LSB transmissions only for one cycle 3d = Bus keeper is enabled during LSB transmissions only for one and half cycles
2	SASI_TX_USE_INT_FSYNC	R/W	0b	Secondary ASI uses internal FSYNC for output data generation in controller mode configuration as applicable. 0d = Use external FSYNC for ASI protocol data generation 1d = Use internal FSYNC for ASI protocol data generation
1	SASI_TX_USE_INT_BCLK	R/W	0b	Secondary ASI uses internal BCLK for output data generation in controller mode configuration. 0d = Use external BCLK for ASI protocol data generation 1d = Use internal BCLK for ASI protocol data generation
0	SASI_TDM_PULSE_WIDTH	R/W	0b	Secondary ASI fsync pulse width in TDM format. 0d = Fsync pulse is 1 bclk period wide 1d = Fsync pulse is 2 bclk period wide

**7.1.3.4 SASI\_TX\_CFG1 Register (Address = 0x1C) [Reset = 0x00]**

SASI\_TX\_CFG1 is shown in [Table 7-149](#).

Return to the [Summary Table](#).

This register is the SASI TX configuration register 1.

**Table 7-149. SASI\_TX\_CFG1 Register Field Descriptions**

Bit	Field	Type	Reset	Description
7-5	RESERVED	R	0b	Reserved bits; Write only reset value
4-0	SASI_TX_OFFSET[4:0]	R/W	00000b	Secondary ASI output data MSB slot 0 offset (on the primary and secondary data pin). 0d = ASI data MSB location has no offset and is as per standard protocol 1d = ASI data MSB location (TDM mode is slot 0 or I <sup>2</sup> S, LJ mode is the left and right slot 0) offset of one BCLK cycle with respect to standard protocol 2d = ASI data MSB location (TDM mode is slot 0 or I <sup>2</sup> S, LJ mode is the left and right slot 0) offset of two BCLK cycles with respect to standard protocol 3d to 30d = ASI data MSB location (TDM mode is slot 0 or I <sup>2</sup> S, LJ mode is the left and right slot 0) offset assigned as per configuration 31d = ASI data MSB location (TDM mode is slot 0 or I <sup>2</sup> S, LJ mode is the left and right slot 0) offset of 31 BCLK cycles with respect to standard protocol

### 7.1.3.5 SASI\_TX\_CFG2 Register (Address = 0x1D) [Reset = 0x00]

SASI\_TX\_CFG2 is shown in [Table 7-150](#).

Return to the [Summary Table](#).

This register is the SASI TX configuration register 2.

**Table 7-150. SASI\_TX\_CFG2 Register Field Descriptions**

Bit	Field	Type	Reset	Description
7	SASI_TX_CH8_SEL	R/W	0b	Secondary ASI output channel 8 select. 0d = Secondary ASI channel 8 output is on DOUT 1d = Secondary ASI channel 8 output is on DOUT2
6	SASI_TX_CH7_SEL	R/W	0b	Secondary ASI output channel 7 select. 0d = Secondary ASI channel 7 output is on DOUT 1d = Secondary ASI channel 7 output is on DOUT2
5	SASI_TX_CH6_SEL	R/W	0b	Secondary ASI output channel 6 select. 0d = Secondary ASI channel 6 output is on DOUT 1d = Secondary ASI channel 6 output is on DOUT2
4	SASI_TX_CH5_SEL	R/W	0b	Secondary ASI output channel 5 select. 0d = Secondary ASI channel 5 output is on DOUT 1d = Secondary ASI channel 5 output is on DOUT2
3	SASI_TX_CH4_SEL	R/W	0b	Secondary ASI output channel 4 select. 0d = Secondary ASI channel 4 output is on DOUT 1d = Secondary ASI channel 4 output is on DOUT2
2	SASI_TX_CH3_SEL	R/W	0b	Secondary ASI output channel 3 select. 0d = Secondary ASI channel 3 output is on DOUT 1d = Secondary ASI channel 3 output is on DOUT2
1	SASI_TX_CH2_SEL	R/W	0b	Secondary ASI output channel 2 select. 0d = Secondary ASI channel 2 output is on DOUT 1d = Secondary ASI channel 2 output is on DOUT2
0	SASI_TX_CH1_SEL	R/W	0b	Secondary ASI output channel 1 select. 0d = Secondary ASI channel 1 output is on DOUT 1d = Secondary ASI channel 1 output is on DOUT2

### 7.1.3.6 SASI\_TX\_CH1\_CFG Register (Address = 0x1E) [Reset = 0x00]

SASI\_TX\_CH1\_CFG is shown in [Table 7-151](#).

Return to the [Summary Table](#).

This register is the SASI TX Channel 1 configuration register.

**Table 7-151. SASI\_TX\_CH1\_CFG Register Field Descriptions**

Bit	Field	Type	Reset	Description
7-6	RESERVED	R	0b	Reserved bits; Write only reset value
5	SASI_TX_CH1_CFG	R/W	0b	Secondary ASI output channel 1 configuration. 0d = Secondary ASI channel 1 output is in a tri-state condition 1d = Secondary ASI channel 1 output corresponds to ADC Channel 1 data
4-0	SASI_TX_CH1_SLOT_NUM[4:0]	R/W	00000b	Secondary ASI output channel 1 slot assignment. 0d = TDM is slot 0 or I <sup>2</sup> S, LJ is left slot 0 1d = TDM is slot 1 or I <sup>2</sup> S, LJ is left slot 1 2d to 14d = Slot assigned as per configuration 15d = TDM is slot 15 or I <sup>2</sup> S, LJ is left slot 15 16d = TDM is slot 16 or I <sup>2</sup> S, LJ is right slot 0 17d = TDM is slot 17 or I <sup>2</sup> S, LJ is right slot 1 18d to 30d = Slot assigned as per configuration 31d = TDM is slot 31 or I <sup>2</sup> S, LJ is right slot 15

### 7.1.3.7 SASI\_TX\_CH2\_CFG Register (Address = 0x1F) [Reset = 0x01]

SASI\_TX\_CH2\_CFG is shown in [Table 7-152](#).

Return to the [Summary Table](#).

This register is the SASI TX Channel 2 configuration register.

**Table 7-152. SASI\_TX\_CH2\_CFG Register Field Descriptions**

Bit	Field	Type	Reset	Description
7-6	RESERVED	R	0b	Reserved bits; Write only reset value
5	SASI_TX_CH2_CFG	R/W	0b	Secondary ASI output channel 2 configuration. 0d = Secondary ASI channel 2 output is in a tri-state condition 1d = Secondary ASI channel 2 output corresponds to ADC Channel 2 data
4-0	SASI_TX_CH2_SLOT_NUM[4:0]	R/W	00001b	Secondary ASI output channel 2 slot assignment. 0d = TDM is slot 0 or I <sup>2</sup> S, LJ is left slot 0 1d = TDM is slot 1 or I <sup>2</sup> S, LJ is left slot 1 2d to 14d = Slot assigned as per configuration 15d = TDM is slot 15 or I <sup>2</sup> S, LJ is left slot 15 16d = TDM is slot 16 or I <sup>2</sup> S, LJ is right slot 0 17d = TDM is slot 17 or I <sup>2</sup> S, LJ is right slot 1 18d to 30d = Slot assigned as per configuration 31d = TDM is slot 31 or I <sup>2</sup> S, LJ is right slot 15

### 7.1.3.8 SASI\_TX\_CH3\_CFG Register (Address = 0x20) [Reset = 0x02]

SASI\_TX\_CH3\_CFG is shown in [Table 7-153](#).

Return to the [Summary Table](#).

This register is the SASI TX Channel 3 configuration register.

**Table 7-153. SASI\_TX\_CH3\_CFG Register Field Descriptions**

Bit	Field	Type	Reset	Description
7	RESERVED	R	0b	Reserved bit; Write only reset value
6-5	SASI_TX_CH3_CFG[1:0]	R/W	00b	Secondary ASI output channel 3 configuration. 0d = Secondary ASI channel 3 output is in a tri-state condition 1d = Secondary ASI channel 3 output corresponds to ADC Channel 3 data 2d = Secondary ASI channel 3 output corresponds to VBAT data 3d = Reserved
4-0	SASI_TX_CH3_SLOT_NUM[4:0]	R/W	00010b	Secondary ASI output channel 3 slot assignment. 0d = TDM is slot 0 or I <sup>2</sup> S, LJ is left slot 0 1d = TDM is slot 1 or I <sup>2</sup> S, LJ is left slot 1 2d to 14d = Slot assigned as per configuration 15d = TDM is slot 15 or I <sup>2</sup> S, LJ is left slot 15 16d = TDM is slot 16 or I <sup>2</sup> S, LJ is right slot 0 17d = TDM is slot 17 or I <sup>2</sup> S, LJ is right slot 1 18d to 30d = Slot assigned as per configuration 31d = TDM is slot 31 or I <sup>2</sup> S, LJ is right slot 15

### 7.1.3.9 SASI\_TX\_CH4\_CFG Register (Address = 0x21) [Reset = 0x03]

SASI\_TX\_CH4\_CFG is shown in [Table 7-154](#).

Return to the [Summary Table](#).

This register is the SASI TX Channel 4 configuration register.

**Table 7-154. SASI\_TX\_CH4\_CFG Register Field Descriptions**

Bit	Field	Type	Reset	Description
7	RESERVED	R	0b	Reserved bit; Write only reset value
6-5	SASI_TX_CH4_CFG[1:0]	R/W	00b	Secondary ASI output channel 4 configuration. 0d = Secondary ASI channel 4 output is in a tri-state condition 1d = Secondary ASI channel 4 output corresponds to ADC Channel 4 data 2d = Secondary ASI channel 4 output corresponds to TEMP data 3d = Reserved
4-0	SASI_TX_CH4_SLOT_NUM[4:0]	R/W	00011b	Secondary ASI output channel 4 slot assignment. 0d = TDM is slot 0 or I <sup>2</sup> S, LJ is left slot 0 1d = TDM is slot 1 or I <sup>2</sup> S, LJ is left slot 1 2d to 14d = Slot assigned as per configuration 15d = TDM is slot 15 or I <sup>2</sup> S, LJ is left slot 15 16d = TDM is slot 16 or I <sup>2</sup> S, LJ is right slot 0 17d = TDM is slot 17 or I <sup>2</sup> S, LJ is right slot 1 18d to 30d = Slot assigned as per configuration 31d = TDM is slot 31 or I <sup>2</sup> S, LJ is right slot 15

#### 7.1.3.10 SASI\_TX\_CH5\_CFG Register (Address = 0x22) [Reset = 0x04]

SASI\_TX\_CH5\_CFG is shown in [Table 7-155](#).

Return to the [Summary Table](#).

This register is the SASI TX Channel 5 configuration register.

**Table 7-155. SASI\_TX\_CH5\_CFG Register Field Descriptions**

Bit	Field	Type	Reset	Description
7	RESERVED	R	0b	Reserved bit; Write only reset value
6-5	SASI_TX_CH5_CFG[1:0]	R/W	00b	Secondary ASI output channel 5 configuration. 0d = Secondary ASI channel 5 output is in a tri-state condition 1d = Secondary ASI channel 5 output corresponds to ASI Input Channel 1 loopback data 2d = Secondary ASI channel 5 output corresponds to echo reference channel 1 data 3d = Reserved
4-0	SASI_TX_CH5_SLOT_NUM[4:0]	R/W	00100b	Secondary ASI output channel 5 slot assignment. 0d = TDM is slot 0 or I <sup>2</sup> S, LJ is left slot 0 1d = TDM is slot 1 or I <sup>2</sup> S, LJ is left slot 1 2d to 14d = Slot assigned as per configuration 15d = TDM is slot 15 or I <sup>2</sup> S, LJ is left slot 15 16d = TDM is slot 16 or I <sup>2</sup> S, LJ is right slot 0 17d = TDM is slot 17 or I <sup>2</sup> S, LJ is right slot 1 18d to 30d = Slot assigned as per configuration 31d = TDM is slot 31 or I <sup>2</sup> S, LJ is right slot 15

#### 7.1.3.11 SASI\_TX\_CH6\_CFG Register (Address = 0x23) [Reset = 0x05]

SASI\_TX\_CH6\_CFG is shown in [Table 7-156](#).

Return to the [Summary Table](#).

This register is the SASI TX Channel 6 configuration register.

**Table 7-156. SASI\_TX\_CH6\_CFG Register Field Descriptions**

Bit	Field	Type	Reset	Description
7	RESERVED	R	0b	Reserved bit; Write only reset value

**Table 7-156. SASI\_TX\_CH6\_CFG Register Field Descriptions (continued)**

Bit	Field	Type	Reset	Description
6-5	SASI_TX_CH6_CFG[1:0]	R/W	00b	Secondary ASI output channel 6 configuration. 0d = Secondary ASI channel 6 output is in a tri-state condition 1d = Secondary ASI channel 6 output corresponds to ASI Input Channel 2 loopback data 2d = Secondary ASI channel 6 output corresponds to echo reference channel 2 data 3d = Reserved
4-0	SASI_TX_CH6_SLOT_NUM[4:0]	R/W	00101b	Secondary ASI output channel 6 slot assignment. 0d = TDM is slot 0 or I <sup>2</sup> S, LJ is left slot 0 1d = TDM is slot 1 or I <sup>2</sup> S, LJ is left slot 1 2d to 14d = Slot assigned as per configuration 15d = TDM is slot 15 or I <sup>2</sup> S, LJ is left slot 15 16d = TDM is slot 16 or I <sup>2</sup> S, LJ is right slot 0 17d = TDM is slot 17 or I <sup>2</sup> S, LJ is right slot 1 18d to 30d = Slot assigned as per configuration 31d = TDM is slot 31 or I <sup>2</sup> S, LJ is right slot 15

**7.1.3.12 SASI\_TX\_CH7\_CFG Register (Address = 0x24) [Reset = 0x06]**

SASI\_TX\_CH7\_CFG is shown in [Table 7-157](#).

Return to the [Summary Table](#).

This register is the SASI TX Channel 7 configuration register.

**Table 7-157. SASI\_TX\_CH7\_CFG Register Field Descriptions**

Bit	Field	Type	Reset	Description
7	RESERVED	R	0b	Reserved bit; Write only reset value
6-5	SASI_TX_CH7_CFG[1:0]	R/W	00b	Secondary ASI output channel 7 configuration. 0d = Secondary ASI channel 7 output is in a tri-state condition 1d = Secondary ASI channel 7 output corresponds to {VBAT_WLby2, TEMP_WLby2} 2d = Secondary ASI channel 7 output corresponds to {echo_ref_ch1_wlby2, echo_ref_ch2_wlby2} 3d = Reserved
4-0	SASI_TX_CH7_SLOT_NUM[4:0]	R/W	00110b	Secondary ASI output channel 7 slot assignment. 0d = TDM is slot 0 or I <sup>2</sup> S, LJ is left slot 0 1d = TDM is slot 1 or I <sup>2</sup> S, LJ is left slot 1 2d to 14d = Slot assigned as per configuration 15d = TDM is slot 15 or I <sup>2</sup> S, LJ is left slot 15 16d = TDM is slot 16 or I <sup>2</sup> S, LJ is right slot 0 17d = TDM is slot 17 or I <sup>2</sup> S, LJ is right slot 1 18d to 30d = Slot assigned as per configuration 31d = TDM is slot 31 or I <sup>2</sup> S, LJ is right slot 15

**7.1.3.13 CLK\_CFG12 Register (Address = 0x32) [Reset = 0x00]**

CLK\_CFG12 is shown in [Table 7-158](#).

Return to the [Summary Table](#).

This register is the clock configuration register 12.

**Table 7-158. CLK\_CFG12 Register Field Descriptions**

Bit	Field	Type	Reset	Description
7-6	PDIV_CLKSRC_SEL[1:0]	R/W	00b	Source clock selection for PLL PDIV Divider. 0d = PLL_PDIV_IN_CLK is Primary ASI BCLK 1d = PLL_PDIV_IN_CLK is Secondary ASI BCLK 2d = PLL_PDIV_IN_CLK is CCLK 3d = PLL_PDIV_IN_CLK is internal Oscillator Clock (only supported in custom clock configuration)
5-3	PASI_BCLK_DIV_CLK_SEL[2:0]	R/W	000b	Primary ASI BCLK divider clock source selection. 0d = Primary ASI BCLK divider clock source is PLL output 1d = Reserved 2d = Primary ASI BCLK divider clock source is secondary ASI BCLK 3d = Primary ASI BCLK divider clock source is CCLK 4d = Primary ASI BCLK divider clock source is internal oscillator clock (only supported in custom clock configuration) 5d = Primary ASI BCLK divider clock source is DSP clock 6d to 7d = Reserved
2-0	RESERVED	R	0b	Reserved bits; Write only reset value

#### 7.1.3.14 CLK\_CFG13 Register (Address = 0x33) [Reset = 0x00]

CLK\_CFG13 is shown in [Table 7-159](#).

Return to the [Summary Table](#).

This register is the clock configuration register 13.

**Table 7-159. CLK\_CFG13 Register Field Descriptions**

Bit	Field	Type	Reset	Description
7	RESERVED	R	0b	Reserved bit; Write only reset value
6-4	SASI_BCLK_DIV_CLK_SEL[2:0]	R/W	000b	Secondary ASI BCLK divider clock source selection. 0d = Secondary ASI BCLK divider clock source is PLL output 1d = Secondary ASI BCLK divider clock source is primary ASI BCLK 2d = Reserved 3d = Secondary ASI BCLK divider clock source is CCLK 4d = Secondary ASI BCLK divider clock source is internal oscillator clock (only supported in custom clock configuration) 5d = Secondary ASI BCLK divider clock source is DSP clock 6d to 7d = Reserved
3-0	RESERVED	R	0b	Reserved bits; Write only reset value

#### 7.1.3.15 CLK\_CFG14 Register (Address = 0x34) [Reset = 0x10]

CLK\_CFG14 is shown in [Table 7-160](#).

Return to the [Summary Table](#).

This register is the clock configuration register 14.

**Table 7-160. CLK\_CFG14 Register Field Descriptions**

Bit	Field	Type	Reset	Description
7-6	DIG_NM_DIV_CLK_SRC_SEL[1:0]	R/W	00b	Source clock selection for DIG NMDIV CLK clock. 0d = DIG NM divider input clock is Primary ASI BCLK 1d = DIG NM divider input clock is Secondary ASI BCLK 2d = DIG NM divider input clock is CCLK 3d = DIG NM divider input clock is internal oscillator clock (only supported in custom clock configuration)

**Table 7-160. CLK\_CFG14 Register Field Descriptions (continued)**

Bit	Field	Type	Reset	Description
5-4	ANA_NM_DIV_CLK_SRC_SEL[1:0]	R/W	01b	Source clock selection for NMDIV CLK clock. 0d = NM divider input clock is PLL Output 1d = NM divider input clock is PLL Output 2d = NM divider input clock is DIG NM Divider Clock Source 3d = NM divider input clock is Primary ASI BCLK (Low Jitter Path)
3-2	RESERVED	R	0b	Reserved bits; Write only reset values
1-0	RESERVED	R	0b	Reserved bits; Write only reset values

**7.1.3.16 CLK\_CFG15 Register (Address = 0x35) [Reset = 0x01]**

CLK\_CFG15 is shown in [Table 7-161](#).

Return to the [Summary Table](#).

This register is the clock configuration register 15.

**Table 7-161. CLK\_CFG15 Register Field Descriptions**

Bit	Field	Type	Reset	Description
7-0	PLL_PDIV[7:0]	R/W	00000001b	PLL pre-scaler P-divider value (Don't care when auto detection is enabled) 0d = PLL PDIV value is 256 1d = PLL PDIV value is 1 2d = PLL PDIV value is 2 3d to 254d = PLL PDIV value is as per configuration 255d = PLL PDIV value is 255

**7.1.3.17 CLK\_CFG16 Register (Address = 0x36) [Reset = 0x00]**

CLK\_CFG16 is shown in [Table 7-162](#).

Return to the [Summary Table](#).

This register is the clock configuration register 16.

**Table 7-162. CLK\_CFG16 Register Field Descriptions**

Bit	Field	Type	Reset	Description
7	PLL_JMUL_MSB	R/W	0b	PLL integer portion J-multiplier value MSB bit. (Don't care when auto detection is enabled)
6	PLL_DIV_CLK_DIG_BY_2	R/W	0b	PLL DIV clock divide by 2 configuration 0d = No divide/2 inside PLL 1d = PLL does a divide/2
5-0	PLL_DMUL_MSB[5:0]	R/W	000000b	PLL fractional portion D-multiplier value MSB bits. (Don't care when auto detection is enabled)

**7.1.3.18 CLK\_CFG17 Register (Address = 0x37) [Reset = 0x00]**

CLK\_CFG17 is shown in [Table 7-163](#).

Return to the [Summary Table](#).

This register is the clock configuration register 17.



**Table 7-163. CLK\_CFG17 Register Field Descriptions**

Bit	Field	Type	Reset	Description
7-0	PLL_DMUL_LSB[7:0]	R/W	00000000b	PLL fractional portion D-multiplier value LSB byte. Above D-multiplier value MSB bits (PLL_DMUL_MSB) along with this LSB byte (PLL_DMUL_LSB) is concatenated to determine final D-multiplier value. (Don't care when auto detection is enabled) 0d = PLL DMUL value is 0 1d = PLL DMUL value is 1 2d = PLL DMUL value is 2 3d to 9998d = PLL JMUL value is as per configuration 9999d = PLL JMUL value is 9999 10000d to 16383d = Reserved; Don't use

### 7.1.3.19 CLK\_CFG18 Register (Address = 0x38) [Reset = 0x08]

CLK\_CFG18 is shown in [Table 7-164](#).

Return to the [Summary Table](#).

This register is the clock configuration register 18.

**Table 7-164. CLK\_CFG18 Register Field Descriptions**

Bit	Field	Type	Reset	Description
7-0	PLL_JMUL_LSB[7:0]	R/W	00001000b	PLL integer portion J-multiplier value LSB byte. Above J-multiplier value MSB bit (PLL_JMUL_MSB) along with this LSB byte (PLL_JMUL_LSB) is concatenated to determine final J-multiplier value. (Don't care when auto detection is enabled) 0d = Reserved; Don't use 1d = PLL JMUL value is 1 2d = PLL JMUL value is 2 3d to 510d = PLL JMUL value is as per configuration 511d = PLL JMUL value is 511

### 7.1.3.20 CLK\_CFG19 Register (Address = 0x39) [Reset = 0x20]

CLK\_CFG19 is shown in [Table 7-165](#).

Return to the [Summary Table](#).

This register is the clock configuration register 19.

**Table 7-165. CLK\_CFG19 Register Field Descriptions**

Bit	Field	Type	Reset	Description
7-5	NDIV[2:0]	R/W	001b	NDIV divider value. (Don't care when auto detection is enabled) 0d = NDIV value is 8 1d = NDIV value is 1 2d = NDIV value is 2 3d to 6d = NDIV value is as per configuration 7d = NDIV value is 7
4-2	PDM_DIV[2:0]	R/W	000b	PDM divider value. (Don't care when auto detection is enabled) 0d = PDM_DIV value is 1 1d = PDM_DIV value is 2 2d = PDM_DIV value is 4 3d = PDM_DIV value is 8 4d = PDM_DIV value is 16 5d-7d Reserved
1-0	RESERVED	R	0b	Reserved bits; Write only reset values

### 7.1.3.21 CLK\_CFG20 Register (Address = 0x3A) [Reset = 0x04]

CLK\_CFG20 is shown in [Table 7-166](#).

Return to the [Summary Table](#).

This register is the clock configuration register 20.

**Table 7-166. CLK\_CFG20 Register Field Descriptions**

Bit	Field	Type	Reset	Description
7-2	MDIV[5:0]	R/W	000001b	MDIV divider value. (Don't care when auto detection is enabled) 0d = MDIV value is 64 1d = MDIV value is 1 2d = MDIV value is 2 3d to 62d = MDIV value is as per configuration 63d = MDIV value is 63
1-0	DIG_ADC_MODCLK_DIV[1:0]	R/W	00b	ADC modulator clock divider value. (Don't care when auto detection is enabled) 0d = DIG_ADC_MODCLK_DIV value is 1 1d = DIG_ADC_MODCLK_DIV value is 2 2d = DIG_ADC_MODCLK_DIV value is 4 3d = Reserved

### 7.1.3.22 CLK\_CFG21 Register (Address = 0x3B) [Reset = 0x00]

CLK\_CFG21 is shown in [Table 7-167](#).

Return to the [Summary Table](#).

This register is the clock configuration register 21.

**Table 7-167. CLK\_CFG21 Register Field Descriptions**

Bit	Field	Type	Reset	Description
7-6	RESERVED	R	0b	Reserved bits; Write only reset values
5-4	RESERVED	R	0b	Reserved bits; Write only reset values
3	RESERVED	R	0b	Reserved bit; Write only reset value
2	PASI_BDIV_MSB	R/W	0b	Primary ASI BCLK divider value MSB bit. (Don't care when auto detection is enabled)
1	SASI_BDIV_MSB	R/W	0b	Secondary ASI BCLK divider value MSB bit. (Don't care when auto detection is enabled)
0	RESERVED	R	0b	Reserved bit; Write only reset value

### 7.1.3.23 CLK\_CFG22 Register (Address = 0x3C) [Reset = 0x01]

CLK\_CFG22 is shown in [Table 7-168](#).

Return to the [Summary Table](#).

This register is the clock configuration register 22.

**Table 7-168. CLK\_CFG22 Register Field Descriptions**

Bit	Field	Type	Reset	Description
7-0	PASI_BDIV_LSB[7:0]	R/W	00000001b	Secondary ASI BCLK divider value. (Don't care when auto detection is enabled) 0d = SASI BCLK divider value is 512 1d = SASI BCLK divider value is 1 2d = SASI BCLK divider value is 2 3d to 62d = SASI BCLK divider value is as per configuration 63d = SASI BCLK divider value is 511

### 7.1.3.24 CLK\_CFG23 Register (Address = 0x3D) [Reset = 0x01]

CLK\_CFG23 is shown in [Table 7-169](#).

Return to the [Summary Table](#).

This register is the clock configuration register 23.

**Table 7-169. CLK\_CFG23 Register Field Descriptions**

Bit	Field	Type	Reset	Description
7-0	SASI_BDIV_LSB[7:0]	R/W	00000001b	Secondary ASI BCLK divider value. (Don't care when auto detection is enabled) 0d = SASI BCLK divider value is 512 1d = SASI BCLK divider value is 1 2d = SASI BCLK divider value is 2 3d to 62d = SASI BCLK divider value is as per configuration 63d = SASI BCLK divider value is 511

### 7.1.3.25 CLK\_CFG24 Register (Address = 0x3E) [Reset = 0x01]

CLK\_CFG24 is shown in [Table 7-170](#).

Return to the [Summary Table](#).

This register is the clock configuration register 24.

**Table 7-170. CLK\_CFG24 Register Field Descriptions**

Bit	Field	Type	Reset	Description
7-6	RESERVED	R	0b	Reserved bits; Write only reset value
5-0	ANA_NM_DIV[5:0]	R/W	000001b	Analog N-M DIV divider value. (Don't care when auto detection is enabled) 0d = ANA_NM_DIV value is 64 1d = ANA_NM_DIV value is 1 2d = ANA_NM_DIV value is 2 3d to 62d = ANA_NM_DIV value is as per configuration 63d = NDIV value is 63

### 7.1.3.26 CLK\_CFG30 Register (Address = 0x44) [Reset = 0x00]

CLK\_CFG30 is shown in [Table 7-171](#).

Return to the [Summary Table](#).

This register is the clock configuration register 30.

**Table 7-171. CLK\_CFG30 Register Field Descriptions**

Bit	Field	Type	Reset	Description
7-3	RESERVED	R	0b	Reserved bits; Write only reset value
2	NDIV_EN	R/W	0b	NDIV divider enable 0d = divider disabled 1d = divider enabled
1	MDIV_EN	R/W	0b	MDIV divider enable 0d = divider disabled 1d = divider enabled
0	PDM_DIV_EN	R/W	0b	PDM divider enable 0d = divider disabled 1d = divider enabled

### 7.1.3.27 CLK\_CFG31 Register (Address = 0x45) [Reset = 0x00]

CLK\_CFG31 is shown in [Table 7-172](#).

Return to the [Summary Table](#).

This register is the clock configuration register 31.

**Table 7-172. CLK\_CFG31 Register Field Descriptions**

Bit	Field	Type	Reset	Description
7	RESERVED	R	0b	Reserved bit; Write only reset value
6	DIG_ADC_MODCLK_DIV_EN	R/W	0b	ADC MODCLK divider enable 0d = divider disabled 1d = divider enabled
5	RESERVED	R	0b	Reserved bit; Write only reset value
4	RESERVED	R	0b	Reserved bit; Write only reset value
3	PASI_BDIV_EN	R/W	0b	PASI BDIV divider enable 0d = divider disabled 1d = divider enabled
2	SASI_BDIV_EN	R/W	0b	SASI BDIV divider enable 0d = divider disabled 1d = divider enabled
1	PASI_FSYNC_DIV_EN	R/W	0b	PASI FSYNC DIV divider enable 0d = divider disabled 1d = divider enabled
0	SASI_FSYNC_DIV_EN	R/W	0b	SASI FSYNC DIV divider enable 0d = divider disabled 1d = divider enabled

### 7.1.3.28 CLKOUT\_CFG1 Register (Address = 0x46) [Reset = 0x00]

CLKOUT\_CFG1 is shown in [Table 7-173](#).

Return to the [Summary Table](#).

This register is the CLKOUT configuration register 1.

**Table 7-173. CLKOUT\_CFG1 Register Field Descriptions**

Bit	Field	Type	Reset	Description
7-3	RESERVED	R	0b	Reserved bits; Write only reset value
2-0	CLKOUT_CLK_SEL[2:0]	R/W	000b	General Purpose CLKOUT divider clock source selection. 0d = Source clock is PLL output 1d = Source clock is primary ASI BCLK 2d = Source clock is secondary ASI BCLK 3d = Source clock is CCLK 4d = Source clock is internal oscillator clock 5d = Source clock is DSP clock 6d to 7d = Reserved

### 7.1.3.29 CLKOUT\_CFG2 Register (Address = 0x47) [Reset = 0x01]

CLKOUT\_CFG2 is shown in [Table 7-174](#).

Return to the [Summary Table](#).

This register is the CLKOUT configuration register 2.

**Table 7-174. CLKOUT\_CFG2 Register Field Descriptions**

Bit	Field	Type	Reset	Description
7	CLKOUT_DIV_EN	R/W	0b	CLKOUT divider enable. 0d = CLKOUT divider disabled 1d = CLKOUT divider enabled
6-0	CLKOUT_DIV[6:0]	R/W	0000001b	CLKOUT DIV divider value. 0d = CLKOUT_DIV value is 128 1d = CLKOUT_DIV value is 1 2d = CLKOUT_DIV value is 2 3d to 126d = CLKOUT_DIV value is as per configuration 127d = CLKOUT_DIV value is 127

### 7.1.3.30 BSTCLK\_CFG1 Register (Address = 0x48) [Reset = 0x00]

BSTCLK\_CFG1 is shown in [Table 7-175](#).

Return to the [Summary Table](#).

This register is the Boost clock configuration register 1

**Table 7-175. BSTCLK\_CFG1 Register Field Descriptions**

Bit	Field	Type	Reset	Description
7	RESERVED	R	0b	Reserved bit; Write only reset value
6	BST_CLK_FREQ_SEL	R/W	0b	Boost clock frequency mode 0d = Boost clock frequency is ~6MHz 1d = Boost clock frequency is ~3MHz
5	BST_CLK_SRC_AUTO_D IS	R/W	0b	Boost divider source clock auto selection disable 0d = Boost divider source clock auto-selection based on clock detection scheme 1d = Boost divider source clock auto-selection disabled and selected based on BST_CLK_SRC_SEL
4	BST_CLK_SRC_MANUAL _SEL	R/W	0b	Boost clock source manual selection (don't care in auto mode) 0d = Boost clock generated based on Audio clock available for ADC/DAC 1d = Boost clock generated based on internal oscillator clock (only supported in custom clock configuration)
3	BST_CLK_EN_AUTO_DI S	R/W	0b	Boost divider source clock auto selection disable 0d = Boost divider auto-enabled 1d = Boost divider enabled/disabled based on manual control using BST_CLK_MANUAL_EN
2	BST_CLK_MANUAL_EN	R/W	0b	Boost divider manual enable (don't care in auto mode) 0d = Boost divider disabled 1d = Boost divider enabled
1-0	BST_CLK_MANUAL_DIV[ 1:0]	R/W	00b	Boost divider value (don't care in auto mode) 0d = Boost divider value is 1 1d = Boost divider value is 2 2d = Boost divider value is 4 3d = Boost divider value is 8

### 7.1.3.31 SARCLK\_CFG1 Register (Address = 0x49) [Reset = 0x00]

SARCLK\_CFG1 is shown in [Table 7-176](#).

Return to the [Summary Table](#).

This register is the SAR clock configuration register 1

**Table 7-176. SARCLK\_CFG1 Register Field Descriptions**

Bit	Field	Type	Reset	Description
7-6	SAR_CLK_FREQ_SEL[1:0]	R/W	00b	SAR clock frequency mode 0d = SAR clock frequency is ~6MHz 1d = SAR clock frequency is ~3MHz 2d = SAR clock frequency is ~1.5MHz 3d = SAR clock frequency is ~12MHz (valid only when SAR clock is generated directly using internal oscillator clock in custom clock configuration)
5	SAR_CLK_SRC_AUTO_DIS	R/W	0b	SAR divider source clock auto selection disable 0d = SAR divider source clock auto-selection based on clock detection scheme 1d = SAR divider source clock auto-selection disabled and selected based on BST_CLK_SRC_SEL
4	SAR_CLK_SRC_MANUAL_SEL	R/W	0b	SAR clock source manual selection (don't care in auto mode) 0d = SAR clock generated based on Audio clock available for ADC/DAC 1d = SAR clock generated based on internal oscillator clock (only supported in custom clock configuration)
3	SAR_CLK_EN_AUTO_DISABLE	R/W	0b	SAR divider source clock auto selection disable 0d = SAR divider auto-enabled 1d = SAR divider enabled/disabled based on manual control using BST_CLK_EN
2	SAR_CLK_MANUAL_EN	R/W	0b	SAR divider manual enable (don't care in auto mode) 0d = SAR divider disabled 1d = SAR divider enabled
1-0	SAR_CLK_MANUAL_DIV[1:0]	R/W	00b	SAR divider value (don't care in auto mode) 0d = SAR divider value is 1 1d = SAR divider value is 2 2d = SAR divider value is 4 3d = SAR divider value is 8

**7.1.3.32 ADC\_OVRD\_FLAG Register (Address = 0x5B) [Reset = 0x00]**

ADC\_OVRD\_FLAG is shown in [Table 7-177](#).

Return to the [Summary Table](#).

This is the ADC overload flag status register.

**Table 7-177. ADC\_OVRD\_FLAG Register Field Descriptions**

Bit	Field	Type	Reset	Description
7	ADC_CH1_OVRD_LTCH	R	0b	ADC CH1 OVRD fault (self clearing bit). 0b = No ADC CH1 OVRD fault 1b = ADC CH1 OVRD fault
6	ADC_CH2_OVRD_LTCH	R	0b	ADC CH2 OVRD fault (self clearing bit). 0b = No ADC CH2 OVRD fault 1b = ADC CH2 OVRD fault
5	ADC_CH1_OVRD_LIVE	R	0b	ADC CH1 OVRD fault (self clearing bit). 0b = No ADC CH1 OVRD fault 1b = ADC CH1 OVRD fault
4	ADC_CH2_OVRD_LIVE	R	0b	ADC CH2 OVRD fault (self clearing bit). 0b = No ADC CH2 OVRD fault 1b = ADC CH2 OVRD fault
3-0	RESERVED	R	0b	Reserved bits; Write only reset value

**7.2 Programmable Coefficient Registers**

The register pages in this section consists of the programmable coefficients of the device. TI recommends using the PPC3 GUI for configuring the programmable coefficients settings; for more details see the [TAX5x1x-Q1EVM-](#)

[PDK Evaluation module user's guide](#) and the [PurePath™ console graphical development suite](#). To optimize the coefficients register transaction time for the register pages in this section, the device also supports (by default) auto-incremented pages for the I<sup>2</sup>C and SPI burst writes and reads. After a transaction of register address 0x7F, the device auto increments to the next page at register 0x08 to transact the next coefficient value. These programmable coefficients are 32-bit, two's complement numbers. For a successful coefficient register transaction, the host device must write and read all four bytes starting with the most significant byte (BYT1) for a target coefficient register transaction. When using SPI for a coefficient register read transaction, the device transmits the first byte as a dummy read byte; therefore, the host must read five bytes, including the first dummy read byte and the last four bytes corresponding to the coefficient register value starting with the most significant byte (BYT1).

### 7.2.1 Programmable Coefficient Registers: Page 8

This register page shown in [Table 7-178](#) consists of the programmable coefficients for the ADC biquad 1 to biquad 6 filters.

**Table 7-178. Page 8 Programmable Coefficient Registers**

ADDRESS	REGISTER	RESET	DESCRIPTION
0x00	PAGE[7:0]	0x00	Device Page Register
0x08	ADC_BQ1_N0_BYT1[7:0]	0x7F	Programmable ADC biquad 1, N0 coefficient byte[31:24]
0x09	ADC_BQ1_N0_BYT2[7:0]	0xFF	Programmable ADC biquad 1, N0 coefficient byte[23:16]
0x0A	ADC_BQ1_N0_BYT3[7:0]	0xFF	Programmable ADC biquad 1, N0 coefficient byte[15:8]
0x0B	ADC_BQ1_N0_BYT4[7:0]	0xFF	Programmable ADC biquad 1, N0 coefficient byte[7:0]
0x0C	ADC_BQ1_N1_BYT1[7:0]	0x00	Programmable ADC biquad 1, N1 coefficient byte[31:24]
0x0D	ADC_BQ1_N1_BYT2[7:0]	0x00	Programmable ADC biquad 1, N1 coefficient byte[23:16]
0x0E	ADC_BQ1_N1_BYT3[7:0]	0x00	Programmable ADC biquad 1, N1 coefficient byte[15:8]
0x0F	ADC_BQ1_N1_BYT4[7:0]	0x00	Programmable ADC biquad 1, N1 coefficient byte[7:0]
0x10	ADC_BQ1_N2_BYT1[7:0]	0x00	Programmable ADC biquad 1, N2 coefficient byte[31:24]
0x11	ADC_BQ1_N2_BYT2[7:0]	0x00	Programmable ADC biquad 1, N2 coefficient byte[23:16]
0x12	ADC_BQ1_N2_BYT3[7:0]	0x00	Programmable ADC biquad 1, N2 coefficient byte[15:8]
0x13	ADC_BQ1_N2_BYT4[7:0]	0x00	Programmable ADC biquad 1, N2 coefficient byte[7:0]
0x14	ADC_BQ1_D1_BYT1[7:0]	0x00	Programmable ADC biquad 1, D1 coefficient byte[31:24]
0x15	ADC_BQ1_D1_BYT2[7:0]	0x00	Programmable ADC biquad 1, D1 coefficient byte[23:16]
0x16	ADC_BQ1_D1_BYT3[7:0]	0x00	Programmable ADC biquad 1, D1 coefficient byte[15:8]
0x17	ADC_BQ1_D1_BYT4[7:0]	0x00	Programmable ADC biquad 1, D1 coefficient byte[7:0]
0x18	ADC_BQ1_D2_BYT1[7:0]	0x00	Programmable ADC biquad 1, D2 coefficient byte[31:24]
0x19	ADC_BQ1_D2_BYT2[7:0]	0x00	Programmable ADC biquad 1, D2 coefficient byte[23:16]
0x1A	ADC_BQ1_D2_BYT3[7:0]	0x00	Programmable ADC biquad 1, D2 coefficient byte[15:8]
0x1B	ADC_BQ1_D2_BYT4[7:0]	0x00	Programmable ADC biquad 1, D2 coefficient byte[7:0]
0x1C	ADC_BQ2_N0_BYT1[7:0]	0x7F	Programmable ADC biquad 2, N0 coefficient byte[31:24]
0x1D	ADC_BQ2_N0_BYT2[7:0]	0xFF	Programmable ADC biquad 2, N0 coefficient byte[23:16]
0x1E	ADC_BQ2_N0_BYT3[7:0]	0xFF	Programmable ADC biquad 2, N0 coefficient byte[15:8]
0x1F	ADC_BQ2_N0_BYT4[7:0]	0xFF	Programmable ADC biquad 2, N0 coefficient byte[7:0]
0x20	ADC_BQ2_N1_BYT1[7:0]	0x00	Programmable ADC biquad 2, N1 coefficient byte[31:24]
0x21	ADC_BQ2_N1_BYT2[7:0]	0x00	Programmable ADC biquad 2, N1 coefficient byte[23:16]
0x22	ADC_BQ2_N1_BYT3[7:0]	0x00	Programmable ADC biquad 2, N1 coefficient byte[15:8]
0x23	ADC_BQ2_N1_BYT4[7:0]	0x00	Programmable ADC biquad 2, N1 coefficient byte[7:0]
0x24	ADC_BQ2_N2_BYT1[7:0]	0x00	Programmable ADC biquad 2, N2 coefficient byte[31:24]
0x25	ADC_BQ2_N2_BYT2[7:0]	0x00	Programmable ADC biquad 2, N2 coefficient byte[23:16]
0x26	ADC_BQ2_N2_BYT3[7:0]	0x00	Programmable ADC biquad 2, N2 coefficient byte[15:8]



**Table 7-178. Page 8 Programmable Coefficient Registers (continued)**

0x27	ADC_BQ2_N2_BYT4[7:0]	0x00	Programmable ADC biquad 2, N2 coefficient byte[7:0]
0x28	ADC_BQ2_D1_BYT1[7:0]	0x00	Programmable ADC biquad 2, D1 coefficient byte[31:24]
0x29	ADC_BQ2_D1_BYT2[7:0]	0x00	Programmable ADC biquad 2, D1 coefficient byte[23:16]
0x2A	ADC_BQ2_D1_BYT3[7:0]	0x00	Programmable ADC biquad 2, D1 coefficient byte[15:8]
0x2B	ADC_BQ2_D1_BYT4[7:0]	0x00	Programmable ADC biquad 2, D1 coefficient byte[7:0]
0x2C	ADC_BQ2_D2_BYT1[7:0]	0x00	Programmable ADC biquad 2, D2 coefficient byte[31:24]
0x2D	ADC_BQ2_D2_BYT2[7:0]	0x00	Programmable ADC biquad 2, D2 coefficient byte[23:16]
0x2E	ADC_BQ2_D2_BYT3[7:0]	0x00	Programmable ADC biquad 2, D2 coefficient byte[15:8]
0x2F	ADC_BQ2_D2_BYT4[7:0]	0x00	Programmable ADC biquad 2, D2 coefficient byte[7:0]
0x30	ADC_BQ3_N0_BYT1[7:0]	0x7F	Programmable ADC biquad 3, N0 coefficient byte[31:24]
0x31	ADC_BQ3_N0_BYT2[7:0]	0xFF	Programmable ADC biquad 3, N0 coefficient byte[23:16]
0x32	ADC_BQ3_N0_BYT3[7:0]	0xFF	Programmable ADC biquad 3, N0 coefficient byte[15:8]
0x33	ADC_BQ3_N0_BYT4[7:0]	0xFF	Programmable ADC biquad 3, N0 coefficient byte[7:0]
0x34	ADC_BQ3_N1_BYT1[7:0]	0x00	Programmable ADC biquad 3, N1 coefficient byte[31:24]
0x35	ADC_BQ3_N1_BYT2[7:0]	0x00	Programmable ADC biquad 3, N1 coefficient byte[23:16]
0x36	ADC_BQ3_N1_BYT3[7:0]	0x00	Programmable ADC biquad 3, N1 coefficient byte[15:8]
0x37	ADC_BQ3_N1_BYT4[7:0]	0x00	Programmable ADC biquad 3, N1 coefficient byte[7:0]
0x38	ADC_BQ3_N2_BYT1[7:0]	0x00	Programmable ADC biquad 3, N2 coefficient byte[31:24]
0x39	ADC_BQ3_N2_BYT2[7:0]	0x00	Programmable ADC biquad 3, N2 coefficient byte[23:16]
0x3A	ADC_BQ3_N2_BYT3[7:0]	0x00	Programmable ADC biquad 3, N2 coefficient byte[15:8]
0x3B	ADC_BQ3_N2_BYT4[7:0]	0x00	Programmable ADC biquad 3, N2 coefficient byte[7:0]
0x3C	ADC_BQ3_D1_BYT1[7:0]	0x00	Programmable ADC biquad 3, D1 coefficient byte[31:24]
0x3D	ADC_BQ3_D1_BYT2[7:0]	0x00	Programmable ADC biquad 3, D1 coefficient byte[23:16]
0x3E	ADC_BQ3_D1_BYT3[7:0]	0x00	Programmable ADC biquad 3, D1 coefficient byte[15:8]
0x3F	ADC_BQ3_D1_BYT4[7:0]	0x00	Programmable ADC biquad 3, D1 coefficient byte[7:0]
0x40	ADC_BQ3_D2_BYT1[7:0]	0x00	Programmable ADC biquad 3, D2 coefficient byte[31:24]
0x41	ADC_BQ3_D2_BYT2[7:0]	0x00	Programmable ADC biquad 3, D2 coefficient byte[23:16]
0x42	ADC_BQ3_D2_BYT3[7:0]	0x00	Programmable ADC biquad 3, D2 coefficient byte[15:8]
0x43	ADC_BQ3_D2_BYT4[7:0]	0x00	Programmable ADC biquad 3, D2 coefficient byte[7:0]
0x44	ADC_BQ4_N0_BYT1[7:0]	0x7F	Programmable ADC biquad 4, N0 coefficient byte[31:24]
0x45	ADC_BQ4_N0_BYT2[7:0]	0xFF	Programmable ADC biquad 4, N0 coefficient byte[23:16]
0x46	ADC_BQ4_N0_BYT3[7:0]	0xFF	Programmable ADC biquad 4, N0 coefficient byte[15:8]
0x47	ADC_BQ4_N0_BYT4[7:0]	0xFF	Programmable ADC biquad 4, N0 coefficient byte[7:0]
0x48	ADC_BQ4_N1_BYT1[7:0]	0x00	Programmable ADC biquad 4, N1 coefficient byte[31:24]
0x49	ADC_BQ4_N1_BYT2[7:0]	0x00	Programmable ADC biquad 4, N1 coefficient byte[23:16]
0x4A	ADC_BQ4_N1_BYT3[7:0]	0x00	Programmable ADC biquad 4, N1 coefficient byte[15:8]
0x4B	ADC_BQ4_N1_BYT4[7:0]	0x00	Programmable ADC biquad 4, N1 coefficient byte[7:0]
0x4C	ADC_BQ4_N2_BYT1[7:0]	0x00	Programmable ADC biquad 4, N2 coefficient byte[31:24]
0x4D	ADC_BQ4_N2_BYT2[7:0]	0x00	Programmable ADC biquad 4, N2 coefficient byte[23:16]
0x4E	ADC_BQ4_N2_BYT3[7:0]	0x00	Programmable ADC biquad 4, N2 coefficient byte[15:8]
0x4F	ADC_BQ4_N2_BYT4[7:0]	0x00	Programmable ADC biquad 4, N2 coefficient byte[7:0]
0x50	ADC_BQ4_D1_BYT1[7:0]	0x00	Programmable ADC biquad 4, D1 coefficient byte[31:24]
0x51	ADC_BQ4_D1_BYT2[7:0]	0x00	Programmable ADC biquad 4, D1 coefficient byte[23:16]
0x52	ADC_BQ4_D1_BYT3[7:0]	0x00	Programmable ADC biquad 4, D1 coefficient byte[15:8]
0x53	ADC_BQ4_D1_BYT4[7:0]	0x00	Programmable ADC biquad 4, D1 coefficient byte[7:0]
0x54	ADC_BQ4_D2_BYT1[7:0]	0x00	Programmable ADC biquad 4, D2 coefficient byte[31:24]



**Table 7-178. Page 8 Programmable Coefficient Registers (continued)**

0x55	ADC_BQ4_D2_BYT2[7:0]	0x00	Programmable ADC biquad 4, D2 coefficient byte[23:16]
0x56	ADC_BQ4_D2_BYT3[7:0]	0x00	Programmable ADC biquad 4, D2 coefficient byte[15:8]
0x57	ADC_BQ4_D2_BYT4[7:0]	0x00	Programmable ADC biquad 4, D2 coefficient byte[7:0]
0x58	ADC_BQ5_N0_BYT1[7:0]	0x7F	Programmable ADC biquad 5, N0 coefficient byte[31:24]
0x59	ADC_BQ5_N0_BYT2[7:0]	0xFF	Programmable ADC biquad 5, N0 coefficient byte[23:16]
0x5A	ADC_BQ5_N0_BYT3[7:0]	0xFF	Programmable ADC biquad 5, N0 coefficient byte[15:8]
0x5B	ADC_BQ5_N0_BYT4[7:0]	0xFF	Programmable ADC biquad 5, N0 coefficient byte[7:0]
0x5C	ADC_BQ5_N1_BYT1[7:0]	0x00	Programmable ADC biquad 5, N1 coefficient byte[31:24]
0x5D	ADC_BQ5_N1_BYT2[7:0]	0x00	Programmable ADC biquad 5, N1 coefficient byte[23:16]
0x5E	ADC_BQ5_N1_BYT3[7:0]	0x00	Programmable ADC biquad 5, N1 coefficient byte[15:8]
0x5F	ADC_BQ5_N1_BYT4[7:0]	0x00	Programmable ADC biquad 5, N1 coefficient byte[7:0]
0x60	ADC_BQ5_N2_BYT1[7:0]	0x00	Programmable ADC biquad 5, N2 coefficient byte[31:24]
0x61	ADC_BQ5_N2_BYT2[7:0]	0x00	Programmable ADC biquad 5, N2 coefficient byte[23:16]
0x62	ADC_BQ5_N2_BYT3[7:0]	0x00	Programmable ADC biquad 5, N2 coefficient byte[15:8]
0x63	ADC_BQ5_N2_BYT4[7:0]	0x00	Programmable ADC biquad 5, N2 coefficient byte[7:0]
0x64	ADC_BQ5_D1_BYT1[7:0]	0x00	Programmable ADC biquad 5, D1 coefficient byte[31:24]
0x65	ADC_BQ5_D1_BYT2[7:0]	0x00	Programmable ADC biquad 5, D1 coefficient byte[23:16]
0x66	ADC_BQ5_D1_BYT3[7:0]	0x00	Programmable ADC biquad 5, D1 coefficient byte[15:8]
0x67	ADC_BQ5_D1_BYT4[7:0]	0x00	Programmable ADC biquad 5, D1 coefficient byte[7:0]
0x68	ADC_BQ5_D2_BYT1[7:0]	0x00	Programmable ADC biquad 5, D2 coefficient byte[31:24]
0x69	ADC_BQ5_D2_BYT2[7:0]	0x00	Programmable ADC biquad 5, D2 coefficient byte[23:16]
0x6A	ADC_BQ5_D2_BYT3[7:0]	0x00	Programmable ADC biquad 5, D2 coefficient byte[15:8]
0x6B	ADC_BQ5_D2_BYT4[7:0]	0x00	Programmable ADC biquad 5, D2 coefficient byte[7:0]
0x6C	ADC_BQ6_N0_BYT1[7:0]	0x7F	Programmable ADC biquad 6, N0 coefficient byte[31:24]
0x6D	ADC_BQ6_N0_BYT2[7:0]	0xFF	Programmable ADC biquad 6, N0 coefficient byte[23:16]
0x6E	ADC_BQ6_N0_BYT3[7:0]	0xFF	Programmable ADC biquad 6, N0 coefficient byte[15:8]
0x6F	ADC_BQ6_N0_BYT4[7:0]	0xFF	Programmable ADC biquad 6, N0 coefficient byte[7:0]
0x70	ADC_BQ6_N1_BYT1[7:0]	0x00	Programmable ADC biquad 6, N1 coefficient byte[31:24]
0x71	ADC_BQ6_N1_BYT2[7:0]	0x00	Programmable ADC biquad 6, N1 coefficient byte[23:16]
0x72	ADC_BQ6_N1_BYT3[7:0]	0x00	Programmable ADC biquad 6, N1 coefficient byte[15:8]
0x73	ADC_BQ6_N1_BYT4[7:0]	0x00	Programmable ADC biquad 6, N1 coefficient byte[7:0]
0x74	ADC_BQ6_N2_BYT1[7:0]	0x00	Programmable ADC biquad 6, N2 coefficient byte[31:24]
0x75	ADC_BQ6_N2_BYT2[7:0]	0x00	Programmable ADC biquad 6, N2 coefficient byte[23:16]
0x76	ADC_BQ6_N2_BYT3[7:0]	0x00	Programmable ADC biquad 6, N2 coefficient byte[15:8]
0x77	ADC_BQ6_N2_BYT4[7:0]	0x00	Programmable ADC biquad 6, N2 coefficient byte[7:0]
0x78	ADC_BQ6_D1_BYT1[7:0]	0x00	Programmable ADC biquad 6, D1 coefficient byte[31:24]
0x79	ADC_BQ6_D1_BYT2[7:0]	0x00	Programmable ADC biquad 6, D1 coefficient byte[23:16]
0x7A	ADC_BQ6_D1_BYT3[7:0]	0x00	Programmable ADC biquad 6, D1 coefficient byte[15:8]
0x7B	ADC_BQ6_D1_BYT4[7:0]	0x00	Programmable ADC biquad 6, D1 coefficient byte[7:0]
0x7C	ADC_BQ6_D2_BYT1[7:0]	0x00	Programmable ADC biquad 6, D2 coefficient byte[31:24]
0x7D	ADC_BQ6_D2_BYT2[7:0]	0x00	Programmable ADC biquad 6, D2 coefficient byte[23:16]
0x7E	ADC_BQ6_D2_BYT3[7:0]	0x00	Programmable ADC biquad 6, D2 coefficient byte[15:8]
0x7F	ADC_BQ6_D2_BYT4[7:0]	0x00	Programmable ADC biquad 6, D2 coefficient byte[7:0]

## 7.2.2 Programmable Coefficient Registers: Page 9

This register page shown in [Table 7-179](#) consists of the programmable coefficients for the ADC biquad 7 to biquad 12 filters.

**Table 7-179. Page 9 Programmable Coefficient Registers**

ADDRESS	REGISTER	RESET	DESCRIPTION
0x00	PAGE[7:0]	0x00	Device Page Register
0x08	ADC_BQ7_N0_BYT1[7:0]	0x7F	Programmable ADC biquad 7, N0 coefficient byte[31:24]
0x09	ADC_BQ7_N0_BYT2[7:0]	0xFF	Programmable ADC biquad 7, N0 coefficient byte[23:16]
0x0A	ADC_BQ7_N0_BYT3[7:0]	0xFF	Programmable ADC biquad 7, N0 coefficient byte[15:8]
0x0B	ADC_BQ7_N0_BYT4[7:0]	0xFF	Programmable ADC biquad 7, N0 coefficient byte[7:0]
0x0C	ADC_BQ7_N1_BYT1[7:0]	0x00	Programmable ADC biquad 7, N1 coefficient byte[31:24]
0x0D	ADC_BQ7_N1_BYT2[7:0]	0x00	Programmable ADC biquad 7, N1 coefficient byte[23:16]
0x0E	ADC_BQ7_N1_BYT3[7:0]	0x00	Programmable ADC biquad 7, N1 coefficient byte[15:8]
0x0F	ADC_BQ7_N1_BYT4[7:0]	0x00	Programmable ADC biquad 7, N1 coefficient byte[7:0]
0x10	ADC_BQ7_N2_BYT1[7:0]	0x00	Programmable ADC biquad 7, N2 coefficient byte[31:24]
0x11	ADC_BQ7_N2_BYT2[7:0]	0x00	Programmable ADC biquad 7, N2 coefficient byte[23:16]
0x12	ADC_BQ7_N2_BYT3[7:0]	0x00	Programmable ADC biquad 7, N2 coefficient byte[15:8]
0x13	ADC_BQ7_N2_BYT4[7:0]	0x00	Programmable ADC biquad 7, N2 coefficient byte[7:0]
0x14	ADC_BQ7_D1_BYT1[7:0]	0x00	Programmable ADC biquad 7, D1 coefficient byte[31:24]
0x15	ADC_BQ7_D1_BYT2[7:0]	0x00	Programmable ADC biquad 7, D1 coefficient byte[23:16]
0x16	ADC_BQ7_D1_BYT3[7:0]	0x00	Programmable ADC biquad 7, D1 coefficient byte[15:8]
0x17	ADC_BQ7_D1_BYT4[7:0]	0x00	Programmable ADC biquad 7, D1 coefficient byte[7:0]
0x18	ADC_BQ7_D2_BYT1[7:0]	0x00	Programmable ADC biquad 7, D2 coefficient byte[31:24]
0x19	ADC_BQ7_D2_BYT2[7:0]	0x00	Programmable ADC biquad 7, D2 coefficient byte[23:16]
0x1A	ADC_BQ7_D2_BYT3[7:0]	0x00	Programmable ADC biquad 7, D2 coefficient byte[15:8]
0x1B	ADC_BQ7_D2_BYT4[7:0]	0x00	Programmable ADC biquad 7, D2 coefficient byte[7:0]
0x1C	ADC_BQ8_N0_BYT1[7:0]	0x7F	Programmable ADC biquad 8, N0 coefficient byte[31:24]
0x1D	ADC_BQ8_N0_BYT2[7:0]	0xFF	Programmable ADC biquad 8, N0 coefficient byte[23:16]
0x1E	ADC_BQ8_N0_BYT3[7:0]	0xFF	Programmable ADC biquad 8, N0 coefficient byte[15:8]
0x1F	ADC_BQ8_N0_BYT4[7:0]	0xFF	Programmable ADC biquad 8, N0 coefficient byte[7:0]
0x20	ADC_BQ8_N1_BYT1[7:0]	0x00	Programmable ADC biquad 8, N1 coefficient byte[31:24]
0x21	ADC_BQ8_N1_BYT2[7:0]	0x00	Programmable ADC biquad 8, N1 coefficient byte[23:16]
0x22	ADC_BQ8_N1_BYT3[7:0]	0x00	Programmable ADC biquad 8, N1 coefficient byte[15:8]
0x23	ADC_BQ8_N1_BYT4[7:0]	0x00	Programmable ADC biquad 8, N1 coefficient byte[7:0]
0x24	ADC_BQ8_N2_BYT1[7:0]	0x00	Programmable ADC biquad 8, N2 coefficient byte[31:24]
0x25	ADC_BQ8_N2_BYT2[7:0]	0x00	Programmable ADC biquad 8, N2 coefficient byte[23:16]
0x26	ADC_BQ8_N2_BYT3[7:0]	0x00	Programmable ADC biquad 8, N2 coefficient byte[15:8]
0x27	ADC_BQ8_N2_BYT4[7:0]	0x00	Programmable ADC biquad 8, N2 coefficient byte[7:0]
0x28	ADC_BQ8_D1_BYT1[7:0]	0x00	Programmable ADC biquad 8, D1 coefficient byte[31:24]
0x29	ADC_BQ8_D1_BYT2[7:0]	0x00	Programmable ADC biquad 8, D1 coefficient byte[23:16]
0x2A	ADC_BQ8_D1_BYT3[7:0]	0x00	Programmable ADC biquad 8, D1 coefficient byte[15:8]
0x2B	ADC_BQ8_D1_BYT4[7:0]	0x00	Programmable ADC biquad 8, D1 coefficient byte[7:0]
0x2C	ADC_BQ8_D2_BYT1[7:0]	0x00	Programmable ADC biquad 8, D2 coefficient byte[31:24]
0x2D	ADC_BQ8_D2_BYT2[7:0]	0x00	Programmable ADC biquad 8, D2 coefficient byte[23:16]
0x2E	ADC_BQ8_D2_BYT3[7:0]	0x00	Programmable ADC biquad 8, D2 coefficient byte[15:8]
0x2F	ADC_BQ8_D2_BYT4[7:0]	0x00	Programmable ADC biquad 8, D2 coefficient byte[7:0]
0x30	ADC_BQ9_N0_BYT1[7:0]	0x7F	Programmable ADC biquad 9, N0 coefficient byte[31:24]

**Table 7-179. Page 9 Programmable Coefficient Registers (continued)**

0x31	ADC_BQ9_N0_BYT2[7:0]	0xFF	Programmable ADC biquad 9, N0 coefficient byte[23:16]
0x32	ADC_BQ9_N0_BYT3[7:0]	0xFF	Programmable ADC biquad 9, N0 coefficient byte[15:8]
0x33	ADC_BQ9_N0_BYT4[7:0]	0xFF	Programmable ADC biquad 9, N0 coefficient byte[7:0]
0x34	ADC_BQ9_N1_BYT1[7:0]	0x00	Programmable ADC biquad 9, N1 coefficient byte[31:24]
0x35	ADC_BQ9_N1_BYT2[7:0]	0x00	Programmable ADC biquad 9, N1 coefficient byte[23:16]
0x36	ADC_BQ9_N1_BYT3[7:0]	0x00	Programmable ADC biquad 9, N1 coefficient byte[15:8]
0x37	ADC_BQ9_N1_BYT4[7:0]	0x00	Programmable ADC biquad 9, N1 coefficient byte[7:0]
0x38	ADC_BQ9_N2_BYT1[7:0]	0x00	Programmable ADC biquad 9, N2 coefficient byte[31:24]
0x39	ADC_BQ9_N2_BYT2[7:0]	0x00	Programmable ADC biquad 9, N2 coefficient byte[23:16]
0x3A	ADC_BQ9_N2_BYT3[7:0]	0x00	Programmable ADC biquad 9, N2 coefficient byte[15:8]
0x3B	ADC_BQ9_N2_BYT4[7:0]	0x00	Programmable ADC biquad 9, N2 coefficient byte[7:0]
0x3C	ADC_BQ9_D1_BYT1[7:0]	0x00	Programmable ADC biquad 9, D1 coefficient byte[31:24]
0x3D	ADC_BQ9_D1_BYT2[7:0]	0x00	Programmable ADC biquad 9, D1 coefficient byte[23:16]
0x3E	ADC_BQ9_D1_BYT3[7:0]	0x00	Programmable ADC biquad 9, D1 coefficient byte[15:8]
0x3F	ADC_BQ9_D1_BYT4[7:0]	0x00	Programmable ADC biquad 9, D1 coefficient byte[7:0]
0x40	ADC_BQ9_D2_BYT1[7:0]	0x00	Programmable ADC biquad 9, D2 coefficient byte[31:24]
0x41	ADC_BQ9_D2_BYT2[7:0]	0x00	Programmable ADC biquad 9, D2 coefficient byte[23:16]
0x42	ADC_BQ9_D2_BYT3[7:0]	0x00	Programmable ADC biquad 9, D2 coefficient byte[15:8]
0x43	ADC_BQ9_D2_BYT4[7:0]	0x00	Programmable ADC biquad 9, D2 coefficient byte[7:0]
0x44	ADC_BQ10_N0_BYT1[7:0]	0x7F	Programmable ADC biquad 10, N0 coefficient byte[31:24]
0x45	ADC_BQ10_N0_BYT2[7:0]	0xFF	Programmable ADC biquad 10, N0 coefficient byte[23:16]
0x46	ADC_BQ10_N0_BYT3[7:0]	0xFF	Programmable ADC biquad 10, N0 coefficient byte[15:8]
0x47	ADC_BQ10_N0_BYT4[7:0]	0xFF	Programmable ADC biquad 10, N0 coefficient byte[7:0]
0x48	ADC_BQ10_N1_BYT1[7:0]	0x00	Programmable ADC biquad 10, N1 coefficient byte[31:24]
0x49	ADC_BQ10_N1_BYT2[7:0]	0x00	Programmable ADC biquad 10, N1 coefficient byte[23:16]
0x4A	ADC_BQ10_N1_BYT3[7:0]	0x00	Programmable ADC biquad 10, N1 coefficient byte[15:8]
0x4B	ADC_BQ10_N1_BYT4[7:0]	0x00	Programmable ADC biquad 10, N1 coefficient byte[7:0]
0x4C	ADC_BQ10_N2_BYT1[7:0]	0x00	Programmable ADC biquad 10, N2 coefficient byte[31:24]
0x4D	ADC_BQ10_N2_BYT2[7:0]	0x00	Programmable ADC biquad 10, N2 coefficient byte[23:16]
0x4E	ADC_BQ10_N2_BYT3[7:0]	0x00	Programmable ADC biquad 10, N2 coefficient byte[15:8]
0x4F	ADC_BQ10_N2_BYT4[7:0]	0x00	Programmable ADC biquad 10, N2 coefficient byte[7:0]
0x50	ADC_BQ10_D1_BYT1[7:0]	0x00	Programmable ADC biquad 10, D1 coefficient byte[31:24]
0x51	ADC_BQ10_D1_BYT2[7:0]	0x00	Programmable ADC biquad 10, D1 coefficient byte[23:16]
0x52	ADC_BQ10_D1_BYT3[7:0]	0x00	Programmable ADC biquad 10, D1 coefficient byte[15:8]
0x53	ADC_BQ10_D1_BYT4[7:0]	0x00	Programmable ADC biquad 10, D1 coefficient byte[7:0]
0x54	ADC_BQ10_D2_BYT1[7:0]	0x00	Programmable ADC biquad 10, D2 coefficient byte[31:24]
0x55	ADC_BQ10_D2_BYT2[7:0]	0x00	Programmable ADC biquad 10, D2 coefficient byte[23:16]
0x56	ADC_BQ10_D2_BYT3[7:0]	0x00	Programmable ADC biquad 10, D2 coefficient byte[15:8]
0x57	ADC_BQ10_D2_BYT4[7:0]	0x00	Programmable ADC biquad 10, D2 coefficient byte[7:0]
0x58	ADC_BQ11_N0_BYT1[7:0]	0x7F	Programmable ADC biquad 11, N0 coefficient byte[31:24]
0x59	ADC_BQ11_N0_BYT2[7:0]	0xFF	Programmable ADC biquad 11, N0 coefficient byte[23:16]
0x5A	ADC_BQ11_N0_BYT3[7:0]	0xFF	Programmable ADC biquad 11, N0 coefficient byte[15:8]
0x5B	ADC_BQ11_N0_BYT4[7:0]	0xFF	Programmable ADC biquad 11, N0 coefficient byte[7:0]
0x5C	ADC_BQ11_N1_BYT1[7:0]	0x00	Programmable ADC biquad 11, N1 coefficient byte[31:24]
0x5D	ADC_BQ11_N1_BYT2[7:0]	0x00	Programmable ADC biquad 11, N1 coefficient byte[23:16]
0x5E	ADC_BQ11_N1_BYT3[7:0]	0x00	Programmable ADC biquad 11, N1 coefficient byte[15:8]

**Table 7-179. Page 9 Programmable Coefficient Registers (continued)**

0x5F	ADC_BQ11_N1_BYT4[7:0]	0x00	Programmable ADC biquad 11, N1 coefficient byte[7:0]
0x60	ADC_BQ11_N2_BYT1[7:0]	0x00	Programmable ADC biquad 11, N2 coefficient byte[31:24]
0x61	ADC_BQ11_N2_BYT2[7:0]	0x00	Programmable ADC biquad 11, N2 coefficient byte[23:16]
0x62	ADC_BQ11_N2_BYT3[7:0]	0x00	Programmable ADC biquad 11, N2 coefficient byte[15:8]
0x63	ADC_BQ11_N2_BYT4[7:0]	0x00	Programmable ADC biquad 11, N2 coefficient byte[7:0]
0x64	ADC_BQ11_D1_BYT1[7:0]	0x00	Programmable ADC biquad 11, D1 coefficient byte[31:24]
0x65	ADC_BQ11_D1_BYT2[7:0]	0x00	Programmable ADC biquad 11, D1 coefficient byte[23:16]
0x66	ADC_BQ11_D1_BYT3[7:0]	0x00	Programmable ADC biquad 11, D1 coefficient byte[15:8]
0x67	ADC_BQ11_D1_BYT4[7:0]	0x00	Programmable ADC biquad 11, D1 coefficient byte[7:0]
0x68	ADC_BQ11_D2_BYT1[7:0]	0x00	Programmable ADC biquad 11, D2 coefficient byte[31:24]
0x69	ADC_BQ11_D2_BYT2[7:0]	0x00	Programmable ADC biquad 11, D2 coefficient byte[23:16]
0x6A	ADC_BQ11_D2_BYT3[7:0]	0x00	Programmable ADC biquad 11, D2 coefficient byte[15:8]
0x6B	ADC_BQ11_D2_BYT4[7:0]	0x00	Programmable ADC biquad 11, D2 coefficient byte[7:0]
0x6C	ADC_BQ12_N0_BYT1[7:0]	0x7F	Programmable ADC biquad 12, N0 coefficient byte[31:24]
0x6D	ADC_BQ12_N0_BYT2[7:0]	0xFF	Programmable ADC biquad 12, N0 coefficient byte[23:16]
0x6E	ADC_BQ12_N0_BYT3[7:0]	0xFF	Programmable ADC biquad 12, N0 coefficient byte[15:8]
0x6F	ADC_BQ12_N0_BYT4[7:0]	0xFF	Programmable ADC biquad 12, N0 coefficient byte[7:0]
0x70	ADC_BQ12_N1_BYT1[7:0]	0x00	Programmable ADC biquad 12, N1 coefficient byte[31:24]
0x71	ADC_BQ12_N1_BYT2[7:0]	0x00	Programmable ADC biquad 12, N1 coefficient byte[23:16]
0x72	ADC_BQ12_N1_BYT3[7:0]	0x00	Programmable ADC biquad 12, N1 coefficient byte[15:8]
0x73	ADC_BQ12_N1_BYT4[7:0]	0x00	Programmable ADC biquad 12, N1 coefficient byte[7:0]
0x74	ADC_BQ12_N2_BYT1[7:0]	0x00	Programmable ADC biquad 12, N2 coefficient byte[31:24]
0x75	ADC_BQ12_N2_BYT2[7:0]	0x00	Programmable ADC biquad 12, N2 coefficient byte[23:16]
0x76	ADC_BQ12_N2_BYT3[7:0]	0x00	Programmable ADC biquad 12, N2 coefficient byte[15:8]
0x77	ADC_BQ12_N2_BYT4[7:0]	0x00	Programmable ADC biquad 12, N2 coefficient byte[7:0]
0x78	ADC_BQ12_D1_BYT1[7:0]	0x00	Programmable ADC biquad 12, D1 coefficient byte[31:24]
0x79	ADC_BQ12_D1_BYT2[7:0]	0x00	Programmable ADC biquad 12, D1 coefficient byte[23:16]
0x7A	ADC_BQ12_D1_BYT3[7:0]	0x00	Programmable ADC biquad 12, D1 coefficient byte[15:8]
0x7B	ADC_BQ12_D1_BYT4[7:0]	0x00	Programmable ADC biquad 12, D1 coefficient byte[7:0]
0x7C	ADC_BQ12_D2_BYT1[7:0]	0x00	Programmable ADC biquad 12, D2 coefficient byte[31:24]
0x7D	ADC_BQ12_D2_BYT2[7:0]	0x00	Programmable ADC biquad 12, D2 coefficient byte[23:16]
0x7E	ADC_BQ12_D2_BYT3[7:0]	0x00	Programmable ADC biquad 12, D2 coefficient byte[15:8]
0x7F	ADC_BQ12_D2_BYT4[7:0]	0x00	Programmable ADC biquad 12, D2 coefficient byte[7:0]

**7.2.3 Programmable Coefficient Registers: Page 10**

This register page shown in [Table 7-180](#) consists of the programmable coefficients for the mixer 1 to 4 and and first-order IIR filter. All channel mixer coefficients are 32-bit, two's complement numbers using a 1.31 number format. The value of 0x7FFFFFFF is equivalent to +1 (0-dB gain), the value 0x00000000 is equivalent to mute (zero data) and all values in between set the mixer attenuation computed accordingly ( $hex2dec(value)/2^{31}$ ). If the MSB is set to '1' then the attenuation remains the same but the signal phase is inverted.

**Table 7-180. Page 10 Programmable Coefficient Registers**

ADDRESS	REGISTER	RESET	DESCRIPTION
0x00	PAGE[7:0]	0x00	Device Page Register
0x08	ADC_MIX1_CH1_BYT1[7:0]	0x7F	Digital mixer 1, ADC channel 1 coefficient byte[31:24]
0x09	ADC_MIX1_CH1_BYT2[7:0]	0xFF	Digital mixer 1, ADC channel 1 coefficient byte[23:16]
0x0A	ADC_MIX1_CH1_BYT3[7:0]	0xFF	Digital mixer 1, ADC channel 1 coefficient byte[15:8]

**Table 7-180. Page 10 Programmable Coefficient Registers (continued)**

0x0B	ADC_MIX1_CH1_BYT4[7:0]	0xFF	Digital mixer 1, ADC channel 1 coefficient byte[7:0]
0x0C	ADC_MIX1_CH2_BYT1[7:0]	0x00	Digital mixer 1, ADC channel 2 coefficient byte[31:24]
0x0D	ADC_MIX1_CH2_BYT2[7:0]	0x00	Digital mixer 1, ADC channel 2 coefficient byte[23:16]
0x0E	ADC_MIX1_CH2_BYT3[7:0]	0x00	Digital mixer 1, ADC channel 2 coefficient byte[15:8]
0x0F	ADC_MIX1_CH2_BYT4[7:0]	0x00	Digital mixer 1, ADC channel 2 coefficient byte[7:0]
0x10	ADC_MIX1_CH3_BYT1[7:0]	0x00	Digital mixer 1, ADC channel 3 coefficient byte[31:24]
0x11	ADC_MIX1_CH3_BYT2[7:0]	0x00	Digital mixer 1, ADC channel 3 coefficient byte[23:16]
0x12	ADC_MIX1_CH3_BYT3[7:0]	0x00	Digital mixer 1, ADC channel 3 coefficient byte[15:8]
0x13	ADC_MIX1_CH3_BYT4[7:0]	0x00	Digital mixer 1, ADC channel 3 coefficient byte[7:0]
0x14	ADC_MIX1_CH4_BYT1[7:0]	0x00	Digital mixer 1, ADC channel 4 coefficient byte[31:24]
0x15	ADC_MIX1_CH4_BYT2[7:0]	0x00	Digital mixer 1, ADC channel 4 coefficient byte[23:16]
0x16	ADC_MIX1_CH4_BYT3[7:0]	0x00	Digital mixer 1, ADC channel 4 coefficient byte[15:8]
0x17	ADC_MIX1_CH4_BYT4[7:0]	0x00	Digital mixer 1, ADC channel 4 coefficient byte[7:0]
0x18	ADC_MIX2_CH1_BYT1[7:0]	0x00	Digital mixer 2, ADC channel 1 coefficient byte[31:24]
0x19	ADC_MIX2_CH1_BYT2[7:0]	0x00	Digital mixer 2, ADC channel 1 coefficient byte[23:16]
0x1A	ADC_MIX2_CH1_BYT3[7:0]	0x00	Digital mixer 2, ADC channel 1 coefficient byte[15:8]
0x1B	ADC_MIX2_CH1_BYT4[7:0]	0x00	Digital mixer 2, ADC channel 1 coefficient byte[7:0]
0x1C	ADC_MIX2_CH2_BYT1[7:0]	0x7F	Digital mixer 2, ADC channel 2 coefficient byte[31:24]
0x1D	ADC_MIX2_CH2_BYT2[7:0]	0xFF	Digital mixer 2, ADC channel 2 coefficient byte[23:16]
0x1E	ADC_MIX2_CH2_BYT3[7:0]	0xFF	Digital mixer 2, ADC channel 2 coefficient byte[15:8]
0x1F	ADC_MIX2_CH2_BYT4[7:0]	0xFF	Digital mixer 2, ADC channel 2 coefficient byte[7:0]
0x20	ADC_MIX2_CH3_BYT1[7:0]	0x00	Digital mixer 2, ADC channel 3 coefficient byte[31:24]
0x21	ADC_MIX2_CH3_BYT2[7:0]	0x00	Digital mixer 2, ADC channel 3 coefficient byte[23:16]
0x22	ADC_MIX2_CH3_BYT3[7:0]	0x00	Digital mixer 2, ADC channel 3 coefficient byte[15:8]
0x23	ADC_MIX2_CH3_BYT4[7:0]	0x00	Digital mixer 2, ADC channel 3 coefficient byte[7:0]
0x24	ADC_MIX2_CH4_BYT1[7:0]	0x00	Digital mixer 2, ADC channel 4 coefficient byte[31:24]
0x25	ADC_MIX2_CH4_BYT2[7:0]	0x00	Digital mixer 2, ADC channel 4 coefficient byte[23:16]
0x26	ADC_MIX2_CH4_BYT3[7:0]	0x00	Digital mixer 2, ADC channel 4 coefficient byte[15:8]
0x27	ADC_MIX2_CH4_BYT4[7:0]	0x00	Digital mixer 2, ADC channel 4 coefficient byte[7:0]
0x28	ADC_MIX3_CH1_BYT1[7:0]	0x00	Digital mixer 3, ADC channel 1 coefficient byte[31:24]
0x29	ADC_MIX3_CH1_BYT2[7:0]	0x00	Digital mixer 3, ADC channel 1 coefficient byte[23:16]
0x2A	ADC_MIX3_CH1_BYT3[7:0]	0x00	Digital mixer 3, ADC channel 1 coefficient byte[15:8]
0x2B	ADC_MIX3_CH1_BYT4[7:0]	0x00	Digital mixer 3, ADC channel 1 coefficient byte[7:0]
0x2C	ADC_MIX3_CH2_BYT1[7:0]	0x00	Digital mixer 3, ADC channel 2 coefficient byte[31:24]
0x2D	ADC_MIX3_CH2_BYT2[7:0]	0x00	Digital mixer 3, ADC channel 2 coefficient byte[23:16]
0x2E	ADC_MIX3_CH2_BYT3[7:0]	0x00	Digital mixer 3, ADC channel 2 coefficient byte[15:8]
0x2F	ADC_MIX3_CH2_BYT4[7:0]	0x00	Digital mixer 3, ADC channel 2 coefficient byte[7:0]
0x30	ADC_MIX3_CH3_BYT1[7:0]	0x7F	Digital mixer 3, ADC channel 3 coefficient byte[31:24]
0x31	ADC_MIX3_CH3_BYT2[7:0]	0xFF	Digital mixer 3, ADC channel 3 coefficient byte[23:16]
0x32	ADC_MIX3_CH3_BYT3[7:0]	0xFF	Digital mixer 3, ADC channel 3 coefficient byte[15:8]
0x33	ADC_MIX3_CH3_BYT4[7:0]	0xFF	Digital mixer 3, ADC channel 3 coefficient byte[7:0]
0x34	ADC_MIX3_CH4_BYT1[7:0]	0x00	Digital mixer 3, ADC channel 4 coefficient byte[31:24]
0x35	ADC_MIX3_CH4_BYT2[7:0]	0x00	Digital mixer 3, ADC channel 4 coefficient byte[23:16]
0x36	ADC_MIX3_CH4_BYT3[7:0]	0x00	Digital mixer 3, ADC channel 4 coefficient byte[15:8]
0x37	ADC_MIX3_CH4_BYT4[7:0]	0x00	Digital mixer 3, ADC channel 4 coefficient byte[7:0]
0x38	ADC_MIX4_CH1_BYT1[7:0]	0x00	Digital mixer 4, ADC channel 1 coefficient byte[31:24]



**Table 7-180. Page 10 Programmable Coefficient Registers (continued)**

0x39	ADC_MIX4_CH1_BYT2[7:0]	0x00	Digital mixer 4, ADC channel 1 coefficient byte[23:16]
0x3A	ADC_MIX4_CH1_BYT3[7:0]	0x00	Digital mixer 4, ADC channel 1 coefficient byte[15:8]
0x3B	ADC_MIX4_CH1_BYT4[7:0]	0x00	Digital mixer 4, ADC channel 1 coefficient byte[7:0]
0x3C	ADC_MIX4_CH2_BYT1[7:0]	0x00	Digital mixer 4, ADC channel 2 coefficient byte[31:24]
0x3D	ADC_MIX4_CH2_BYT2[7:0]	0x00	Digital mixer 4, ADC channel 2 coefficient byte[23:16]
0x3E	ADC_MIX4_CH2_BYT3[7:0]	0x00	Digital mixer 4, ADC channel 2 coefficient byte[15:8]
0x3F	ADC_MIX4_CH2_BYT4[7:0]	0x00	Digital mixer 4, ADC channel 2 coefficient byte[7:0]
0x40	ADC_MIX4_CH3_BYT1[7:0]	0x00	Digital mixer 4, ADC channel 3 coefficient byte[31:24]
0x41	ADC_MIX4_CH3_BYT2[7:0]	0x00	Digital mixer 4, ADC channel 3 coefficient byte[23:16]
0x42	ADC_MIX4_CH3_BYT3[7:0]	0x00	Digital mixer 4, ADC channel 3 coefficient byte[15:8]
0x43	ADC_MIX4_CH3_BYT4[7:0]	0x00	Digital mixer 4, ADC channel 3 coefficient byte[7:0]
0x44	ADC_MIX4_CH4_BYT1[7:0]	0x7F	Digital mixer 4, ADC channel 4 coefficient byte[31:24]
0x45	ADC_MIX4_CH4_BYT2[7:0]	0xFF	Digital mixer 4, ADC channel 4 coefficient byte[23:16]
0x46	ADC_MIX4_CH4_BYT3[7:0]	0xFF	Digital mixer 4, ADC channel 4 coefficient byte[15:8]
0x47	ADC_MIX4_CH4_BYT4[7:0]	0xFF	Digital mixer 4, ADC channel 4 coefficient byte[7:0]
0x78	ADC_IIR_N0_BYT1[7:0]	0x7F	Programmable ADC first-order IIR, N0 coefficient byte[31:24]
0x79	ADC_IIR_N0_BYT2[7:0]	0xFF	Programmable ADC first-order IIR, N0 coefficient byte[23:16]
0x7A	ADC_IIR_N0_BYT3[7:0]	0xFF	Programmable ADC first-order IIR, N0 coefficient byte[15:8]
0x7B	ADC_IIR_N0_BYT4[7:0]	0xFF	Programmable ADC first-order IIR, N0 coefficient byte[7:0]
0x7C	ADC_IIR_N1_BYT1[7:0]	0x00	Programmable ADC first-order IIR, N1 coefficient byte[31:24]
0x7D	ADC_IIR_N1_BYT2[7:0]	0x00	Programmable ADC first-order IIR, N1 coefficient byte[23:16]
0x7E	ADC_IIR_N1_BYT3[7:0]	0x00	Programmable ADC first-order IIR, N1 coefficient byte[15:8]
0x7F	ADC_IIR_N1_BYT4[7:0]	0x00	Programmable ADC first-order IIR, N1 coefficient byte[7:0]

**7.2.4 Programmable Coefficient Registers: Page 11**

This register page shown in [Table 7-181](#) consists of the programmable coefficients for the ADC first-order IIR filter, ADC digital volume control and fine gain control for channels 1 to 4, ADC Auxiliary mixer and UAD filters.

**Table 7-181. Page 11 Programmable Coefficient Registers**

ADDRESS	REGISTER	RESET	DESCRIPTION
0x00	PAGE[7:0]	0x00	Device Page Register
0x08	ADC_IIR_D1_BYT1[7:0]	0x00	Programmable ADC first-order IIR, D1 coefficient byte[31:24]
0x09	ADC_IIR_D1_BYT2[7:0]	0x00	Programmable ADC first-order IIR, D1 coefficient byte[23:16]
0x0A	ADC_IIR_D1_BYT3[7:0]	0x00	Programmable ADC first-order IIR, D1 coefficient byte[15:8]
0x0B	ADC_IIR_D1_BYT4[7:0]	0x00	Programmable ADC first-order IIR, D1 coefficient byte[7:0]
0x0C	DEV_BQ_BUF_SWAP_FLAG_BYT1[7:0]	0x00	Device Biquad Buffer Swap Flag coefficient byte[31:24]
0x0D	DEV_BQ_BUF_SWAP_FLAG_BYT2[7:0]	0x00	Device Biquad Buffer Swap Flag coefficient byte[23:16]
0x0E	DEV_BQ_BUF_SWAP_FLAG_BYT3[7:0]	0x00	Device Biquad Buffer Swap Flag coefficient byte[15:8]
0x0F	DEV_BQ_BUF_SWAP_FLAG_BYT4[7:0]	0x00	Device Biquad Buffer Swap Flag coefficient byte[7:0]
0x0C	ADC_VOL_CH1_BYT1[7:0]	0x00	Digital volume control, ADC channel 1 coefficient byte[31:24]
0x0D	ADC_VOL_CH1_BYT2[7:0]	0x80	Digital volume control, ADC channel 1 coefficient byte[23:16]
0x0E	ADC_VOL_CH1_BYT3[7:0]	0x00	Digital volume control, ADC channel 1 coefficient byte[15:8]
0x0F	ADC_VOL_CH1_BYT4[7:0]	0x00	Digital volume control, ADC channel 1 coefficient byte[7:0]
0x10	ADC_VOL_CH2_BYT1[7:0]	0x00	Digital volume control, ADC channel 2 coefficient byte[31:24]

**Table 7-181. Page 11 Programmable Coefficient Registers (continued)**

0x11	ADC_VOL_CH2_BYT2[7:0]	0x80	Digital volume control, ADC channel 2 coefficient byte[23:16]
0x12	ADC_VOL_CH2_BYT3[7:0]	0x00	Digital volume control, ADC channel 2 coefficient byte[15:8]
0x13	ADC_VOL_CH2_BYT4[7:0]	0x00	Digital volume control, ADC channel 2 coefficient byte[7:0]
0x14	ADC_VOL_CH3_BYT1[7:0]	0x00	Digital volume control, ADC channel 3 coefficient byte[31:24]
0x15	ADC_VOL_CH3_BYT2[7:0]	0x80	Digital volume control, ADC channel 3 coefficient byte[23:16]
0x16	ADC_VOL_CH3_BYT3[7:0]	0x00	Digital volume control, ADC channel 3 coefficient byte[15:8]
0x17	ADC_VOL_CH3_BYT4[7:0]	0x00	Digital volume control, ADC channel 3 coefficient byte[7:0]
0x18	ADC_VOL_CH4_BYT1[7:0]	0x00	Digital volume control, ADC channel 4 coefficient byte[31:24]
0x19	ADC_VOL_CH4_BYT2[7:0]	0x80	Digital volume control, ADC channel 4 coefficient byte[23:16]
0x1A	ADC_VOL_CH4_BYT3[7:0]	0x00	Digital volume control, ADC channel 4 coefficient byte[15:8]
0x1F	ADC_VOL_CH4_BYT4[7:0]	0x00	Digital volume control, ADC channel 4 coefficient byte[7:0]
0x20	ADC_SF2_CH1_BYT1[7:0]	0x40	Digital SF2 (fine gain) control, ADC channel 1 coefficient byte[31:24]
0x21	ADC_SF2_CH1_BYT2[7:0]	0x00	Digital SF2 (fine gain) control, ADC channel 1 coefficient byte[23:16]
0x22	ADC_SF2_CH1_BYT3[7:0]	0x00	Digital SF2 (fine gain) control, ADC channel 1 coefficient byte[15:8]
0x23	ADC_SF2_CH1_BYT4[7:0]	0x00	Digital SF2 (fine gain) control, ADC channel 1 coefficient byte[7:0]
0x24	ADC_SF2_CH2_BYT1[7:0]	0x40	Digital SF2 (fine gain) control, ADC channel 2 coefficient byte[31:24]
0x25	ADC_SF2_CH2_BYT2[7:0]	0x00	Digital SF2 (fine gain) control, ADC channel 2 coefficient byte[23:16]
0x26	ADC_SF2_CH2_BYT3[7:0]	0x00	Digital SF2 (fine gain) control, ADC channel 2 coefficient byte[15:8]
0x27	ADC_SF2_CH2_BYT4[7:0]	0x00	Digital SF2 (fine gain) control, ADC channel 2 coefficient byte[7:0]
0x28	ADC_SF2_CH3_BYT1[7:0]	0x40	Digital SF2 (fine gain) control, ADC channel 3 coefficient byte[31:24]
0x29	ADC_SF2_CH3_BYT2[7:0]	0x00	Digital SF2 (fine gain) control, ADC channel 3 coefficient byte[23:16]
0x2A	ADC_SF2_CH3_BYT3[7:0]	0x00	Digital SF2 (fine gain) control, ADC channel 3 coefficient byte[15:8]
0x2B	ADC_SF2_CH3_BYT4[7:0]	0x00	Digital SF2 (fine gain) control, ADC channel 3 coefficient byte[7:0]
0x2C	ADC_SF2_CH4_BYT1[7:0]	0x40	Digital SF2 (fine gain) control, ADC channel 4 coefficient byte[31:24]
0x2D	ADC_SF2_CH4_BYT2[7:0]	0x00	Digital SF2 (fine gain) control, ADC channel 4 coefficient byte[23:16]
0x2E	ADC_SF2_CH4_BYT3[7:0]	0x00	Digital SF2 (fine gain) control, ADC channel 4 coefficient byte[15:8]
0x2F	ADC_SF2_CH4_BYT4[7:0]	0x00	Digital SF2 (fine gain) control, ADC channel 4 coefficient byte[7:0]
0x30	ADC_AUX_MIX_CH1_BYT1[7:0]	0x00	ADC Auxiliary Mixer CH1 coefficient byte[31:24]
0x31	ADC_AUX_MIX_CH1_BYT2[7:0]	0x00	ADC Auxiliary Mixer CH1 coefficient byte[23:16]
0x32	ADC_AUX_MIX_CH1_BYT3[7:0]	0x00	ADC Auxiliary Mixer CH1 coefficient byte[15:8]
0x33	ADC_AUX_MIX_CH1_BYT4[7:0]	0x00	ADC Auxiliary Mixer CH1 coefficient byte[7:0]
0x34	ADC_AUX_MIX_CH2_BYT1[7:0]	0x00	ADC Auxiliary Mixer CH2 coefficient byte[31:24]

**Table 7-181. Page 11 Programmable Coefficient Registers (continued)**

0x35	ADC_AUX_MIX_CH2_BYT2[7:0]	0x00	ADC Auxiliary Mixer CH2 coefficient byte[23:16]
0x36	ADC_AUX_MIX_CH2_BYT3[7:0]	0x00	ADC Auxiliary Mixer CH2 coefficient byte[15:8]
0x37	ADC_AUX_MIX_CH2_BYT4[7:0]	0x00	ADC Auxiliary Mixer CH2 coefficient byte[7:0]
0x68	ADC_UAD_BPF_B0_BYT1[7:0]	0x07	UAD BQ B0 Coefficient [31:24]
0x69	ADC_UAD_BPF_B0_BYT2[7:0]	0xDF	UAD BQ B0 Coefficient [23:16]
0x6A	ADC_UAD_BPF_B0_BYT3[7:0]	0x9E	UAD BQ B0 Coefficient[15:8]
0x6B	ADC_UAD_BPF_B0_BYT4[7:0]	0x1D	UAD BQ B0 Coefficient[7:0]
0x6C	ADC_UAD_BPF_B1_BYT1[7:0]	0x00	UAD BQ B1 Coefficient [31:24]
0x6D	ADC_UAD_BPF_B1_BYT2[7:0]	0x00	UAD BQ B1 Coefficient [23:16]
0x6E	ADC_UAD_BPF_B1_BYT3[7:0]	0x00	UAD BQ B1 Coefficient[15:8]
0x6F	ADC_UAD_BPF_B1_BYT4[7:0]	0x00	UAD BQ B1 Coefficient [7:0]
0x70	ADC_UAD_BPF_B2_BYT1[7:0]	0xF8	UAD BQ B2 Coefficient [31:24]
0x71	ADC_UAD_BPF_B2_BYT2[7:0]	0x20	UAD BQ B2 Coefficient [23:16]
0x72	ADC_UAD_BPF_B2_BYT3[7:0]	0x61	UAD BQ B2 Coefficient[15:8]
0x73	ADC_UAD_BPF_B2_BYT4[7:0]	0xE2	UAD BQ B2 Coefficient[7:0]
0x74	ADC_UAD_BPF_A1_BYT1[7:0]	0x3C	UAD BQ A1 Coefficient [31:24]
0x75	ADC_UAD_BPF_A1_BYT2[7:0]	0x31	UAD BQ A1 Coefficient [23:16]
0x76	ADC_UAD_BPF_A1_BYT3[7:0]	0x2E	UAD BQ A1 Coefficient[15:8]
0x77	ADC_UAD_BPF_A1_BYT4[7:0]	0xF5	UAD BQ A1 Coefficient[7:0]
0x78	ADC_UAD_BPF_A2_BYT1[7:0]	0x70	UAD BQ A2 Coefficient [31:24]
0x79	ADC_UAD_BPF_A2_BYT2[7:0]	0x40	UAD BQ A2 Coefficient [23:16]
0x7A	ADC_UAD_BPF_A2_BYT3[7:0]	0xC3	UAD BQ A2 Coefficient[15:8]
0x7B	ADC_UAD_BPF_A2_BYT4[7:0]	0xC5	UAD BQ A2 Coefficient[7:0]

**7.2.5 Programmable Coefficient Registers: Page 19**

This register page shown in [Table 7-182](#) consists of the programmable coefficients for the ADC MSA for channels 1 to 4.

**Table 7-182. Page 19 Programmable Coefficient Registers**

ADDRESS	REGISTER	RESET	DESCRIPTION
0x00	PAGE[7:0]	0x00	Device Page Register
0x58	ADC_CH1_SF1_BYT1[7:0]	0x04	ADC CH1 MSA coefficient byte[31:24]
0x59	ADC_CH1_SF1_BYT2[7:0]	0x00	ADC CH1 MSA coefficient byte[23:16]
0x5A	ADC_CH1_SF1_BYT3[7:0]	0x00	ADC CH1 MSA coefficient byte[15:8]
0x5B	ADC_CH1_SF1_BYT4[7:0]	0x00	ADC CH1 MSA coefficient byte[7:0]
0x5C	ADC_CH2_SF1_BYT1[7:0]	0x04	ADC CH2 MSA coefficient byte[31:24]
0x5D	ADC_CH2_SF1_BYT2[7:0]	0x00	ADC CH2 MSA coefficient byte[23:16]
0x5E	ADC_CH2_SF1_BYT3[7:0]	0x00	ADC CH2 MSA coefficient byte[15:8]
0x5F	ADC_CH2_SF1_BYT4[7:0]	0x00	ADC CH2 MSA coefficient byte[7:0]
0x60	ADC_CH3_SF1_BYT1[7:0]	0x04	ADC CH3 MSA coefficient byte[31:24]
0x61	ADC_CH3_SF1_BYT2[7:0]	0x00	ADC CH3 MSA coefficient byte[23:16]
0x62	ADC_CH3_SF1_BYT3[7:0]	0x00	ADC CH3 MSA coefficient byte[15:8]
0x63	ADC_CH3_SF1_BYT4[7:0]	0x00	ADC CH3 MSA coefficient byte[7:0]
0x64	ADC_CH4_SF1_BYT1[7:0]	0x04	ADC CH4 MSA coefficient byte[31:24]
0x65	ADC_CH4_SF1_BYT2[7:0]	0x00	ADC CH4 MSA coefficient byte[23:16]



**Table 7-182. Page 19 Programmable Coefficient Registers (continued)**

0x66	ADC_CH4_SF1_BYT3[7:0]	0x00	ADC CH4 MSA coefficient byte[15:8]
0x67	ADC_CH4_SF1_BYT4[7:0]	0x00	ADC CH4 MSA coefficient byte[7:0]

### 7.2.6 Programmable Coefficient Registers: Page 27

This register page shown in [Table 7-183](#) consists of the programmable coefficients for the ADC AGC.

**Table 7-183. Page 27 Programmable Coefficient Registers**

ADDRESS	REGISTER	RESET	DESCRIPTION
0x00	PAGE[7:0]	0x00	Device Page Register
0x5C	AGC_NOISE_FLOOR_BYT1[7:0]	0xFF	AGC Noise Floor coefficient byte[31:24]
0x5D	AGC_NOISE_FLOOR_BYT2[7:0]	0xFE	AGC Noise Floor coefficient byte[23:16]
0x5E	AGC_NOISE_FLOOR_BYTT3[7:0]	0xB0	AGC Noise Floor coefficient byte[15:8]
0x5F	AGC_NOISE_FLOOR_BYTT4[7:0]	0x00	AGC Noise Floor coefficient byte[7:0]
0x60	AGC_TARGET_LEVEL_BYT1[7:0]	0xFF	AGC Target Level coefficient byte[31:24]
0x61	AGC_TARGET_LEVEL_BYT2[7:0]	0xFF	AGC Target Level coefficient byte[23:16]
0x62	AGC_TARGET_LEVEL_BYTT3[7:0]	0x78	AGC Target Level coefficient byte[15:8]
0x63	AGC_TARGET_LEVEL_BYTT4[7:0]	0x00	AGC Target Level coefficient byte[7:0]
0x64	AGC_NOISE_COUNT_MAX_BYT1[7:0]	0x00	AGC Noise Floor Hold Count coefficient byte[31:24]
0x65	AGC_NOISE_COUNT_MAX_BYT2[7:0]	0x00	AGC Noise Floor Hold Count coefficient byte[23:16]
0x66	AGC_NOISE_COUNT_MAX_BYTT3[7:0]	0x04	AGC Noise Floor Hold Count coefficient byte[15:8]
0x67	AGC_NOISE_COUNT_MAX_BYTT4[7:0]	0xB0	AGC Noise Floor Hold Count coefficient byte[7:0]
0x68	AGC_MAX_GAIN_BYT1[7:0]	0x00	AGC Maximum Gain coefficient byte[31:24]
0x69	AGC_MAX_GAIN_BYT2[7:0]	0x00	AGC Maximum Gain coefficient byte[23:16]
0x6A	AGC_MAX_GAIN_BYTT3[7:0]	0x60	AGC Maximum Gain coefficient byte[15:8]
0x6B	AGC_MAX_GAIN_BYTT4[7:0]	0x00	AGC Maximum Gain coefficient byte[7:0]
0x6C	AGC_MIN_GAIN_BYT1[7:0]	0xFF	AGC Minimum Gain coefficient byte[31:24]
0x6D	AGC_MIN_GAIN_BYT2[7:0]	0xFF	AGC Minimum Gain coefficient byte[23:16]
0x6E	AGC_MIN_GAIN_BYTT3[7:0]	0x88	AGC Minimum Gain coefficient byte[15:8]
0x6F	AGC_MIN_GAIN_BYTT4[7:0]	0x00	AGC Minimum Gain coefficient byte[7:0]
0x70	AGC_NOISE_HYS_BYT1[7:0]	0x00	AGC Noise Gate Hysteresis coefficient byte[31:24]
0x71	AGC_NOISE_HYS_BYT2[7:0]	0x00	AGC Noise Gate Hysteresis coefficient byte[23:16]
0x72	AGC_NOISE_HYS_BYTT3[7:0]	0x18	AGC Noise Gate Hysteresis coefficient byte[15:8]
0x73	AGC_NOISE_HYS_BYTT4[7:0]	0x00	AGC Noise Gate Hysteresis coefficient byte[7:0]
0x74	AGC_ATTACK_HOLD_COUNT_BYT1[7:0]	0x00	AGC Attack Hold Count coefficient byte[31:24]
0x75	AGC_ATTACK_HOLD_COUNT_BYT2[7:0]	0x00	AGC Attack Hold Count coefficient byte[23:16]
0x76	AGC_ATTACK_HOLD_COUNT_BYTT3[7:0]	0x00	AGC Attack Hold Count coefficient byte[15:8]

**Table 7-183. Page 27 Programmable Coefficient Registers (continued)**

0x77	AGC_ATTACK_HOLD_COUNT_BYTT4[7:0]	0x01	AGC Attack Hold Count coefficient byte[7:0]
0x78	AGC_RELEASE_HOLD_COUNT_BYT1[7:0]	0x00	AGC Release Hold Count coefficient byte[31:24]
0x79	AGC_RELEASE_HOLD_COUNT_BYT2[7:0]	0x00	AGC Release Hold Count coefficient byte[23:16]
0x7A	AGC_RELEASE_HOLD_COUNT_BYTT3[7:0]	0x04	AGC Release Hold Count coefficient byte[15:8]
0x7B	AGC_RELEASE_HOLD_COUNT_BYTT4[7:0]	0xB0	AGC Release Hold Count coefficient byte[7:0]
0x7C	AGC_RELEASE_HYST_BYT1[7:0]	0x00	AGC Release Hysteresis coefficient byte[31:24]
0x7D	AGC_RELEASE_HYST_BYT2[7:0]	0x00	AGC Release Hysteresis coefficient byte[23:16]
0x7E	AGC_RELEASE_HYST_BYTT3[7:0]	0x08	AGC Release Hysteresis coefficient byte[15:8]
0x7F	AGC_RELEASE_HYST_BYTT4[7:0]	0x00	AGC Release Hysteresis coefficient byte[7:0]

**7.2.7 Programmable Coefficient Registers: Page 28**

This register page shown in [Section 7.2.7](#) consists of the programmable coefficients for the AGC.

**Table 7-184. Page 28 Programmable Coefficient Registers**

ADDRESS	REGISTER	RESET	DESCRIPTION
0x00	PAGE[7:0]	0x00	Device Page Register
0x08	AGC_ATTACK_RATE_BYT1[7:0]	0x50	AGC Attack Rate coefficient byte[31:24]
0x09	AGC_ATTACK_RATE_BYT2[7:0]	0xFC	AGC Attack Rate coefficient byte[23:16]
0x0A	AGC_ATTACK_RATE_BYTT3[7:0]	0x64	AGC Attack Rate coefficient byte[15:8]
0x0B	AGC_ATTACK_RATE_BYTT4[7:0]	0x5C	AGC Attack Rate coefficient byte[7:0]
0x0C	AGC_RELEASE_RATE_BYT1[7:0]	0x7F	AGC Release Rate coefficient byte[31:24]
0x0D	AGC_RELEASE_RATE_BYT2[7:0]	0xC4	AGC Release Rate coefficient byte[23:16]
0x0E	AGC_RELEASE_RATE_BYTT3[7:0]	0x0E	AGC Release Rate coefficient byte[15:8]
0x0F	AGC_RELEASE_RATE_BYTT4[7:0]	0x57	AGC Release Rate coefficient byte[7:0]

## 8 Application and Implementation

---

### Note

Information in the following applications sections is not part of the TI component specification, and TI does not warrant its accuracy or completeness. TI's customers are responsible for determining suitability of components for their purposes, as well as validating and testing their design implementation to confirm system functionality.

---

### 8.1 Application Information

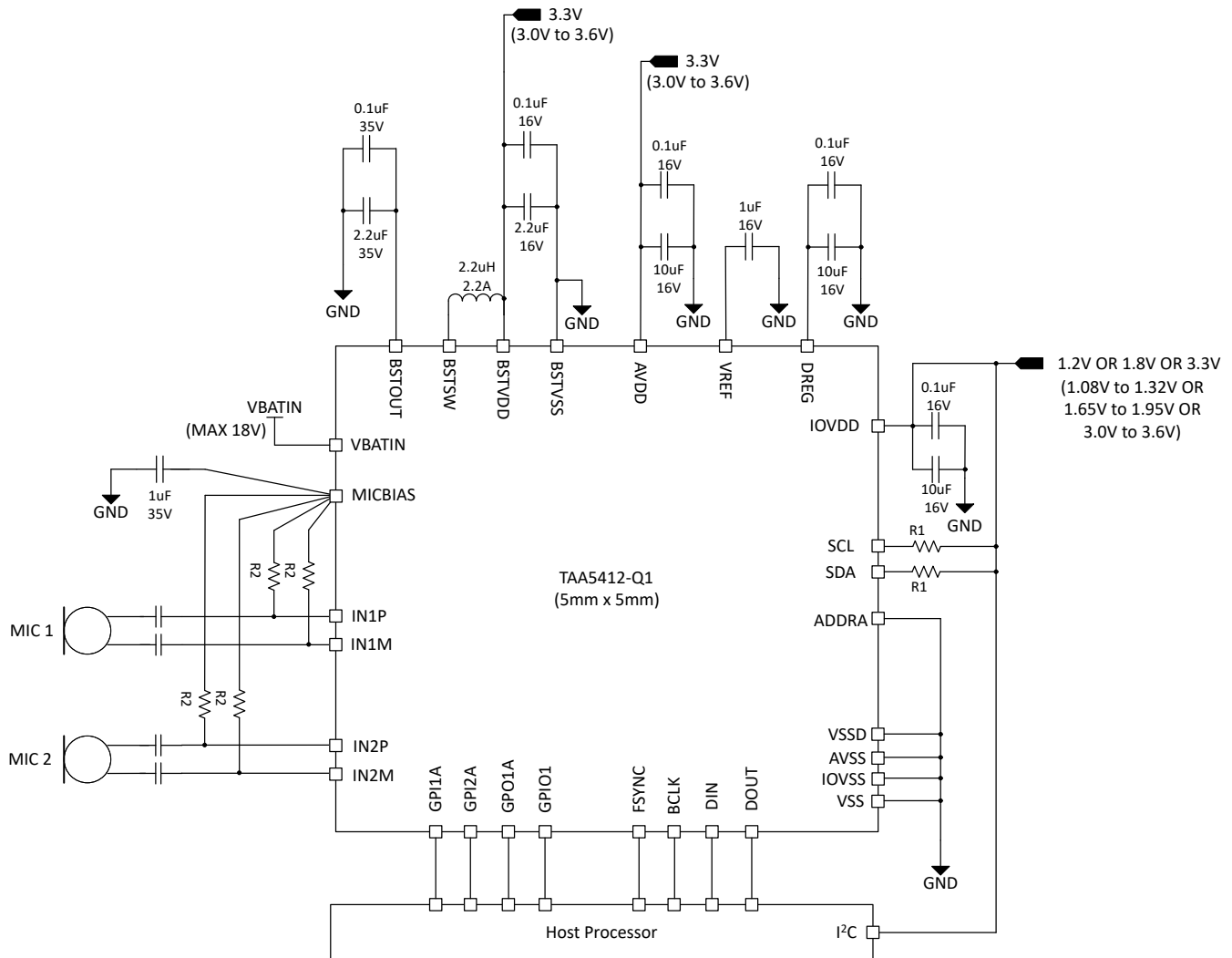
The TAA5412-Q1 is a stereo, high-performance audio ADC that supports sample rates of up to 768kHz. The device supports up to a total of 4 microphones for simultaneous recording which can be selected from up to 2 analog microphones or 4 digital pulse density modulation (PDM) microphones.

Communication to the TAA5412-Q1 for configuration of the control registers is supported using an I<sup>2</sup>C or SPI. The device supports a highly flexible, audio serial interface (TDM, I<sup>2</sup>S, and LJ) to transmit audio data seamlessly in the system across devices.

### 8.2 Typical Application

#### 8.2.1 Application

[Figure 8-1](#) shows a typical configuration of the TAA5412-Q1 for an application using two analog ECM microphones for simultaneous recording with an I<sup>2</sup>C control interface and a time-division multiplexing (TDM) audio data target interface. For best distortion performance, use input AC-coupling capacitors with a low-voltage coefficient.



**Figure 8-1. Stereo Microphone Block Diagram**

## 8.2.2 Design Requirements

Table 8-1 lists the design parameters for this application.

**Table 8-1. Design Parameters**

PARAMETER	VALUE
AVDD	3.3V
BSTVDD	3.3V
IOVDD	1.2V or 1.8V or 3.3V
AVDD supply current consumption	8.7mA, with AVDD = 3.3V (PLL on, stereo recording, $f_s = 16\text{kHz}$ )
BSTVDD supply current consumption	16.6mA, with BSTVDD = 3.3V
IOVDD supply current consumption	0.3mA, with IOVDD = 3.3V
Maximum MICBIAS current	30mA

## 8.2.3 Detailed Design Procedure

This section describes the necessary steps to configure the TAA5412-Q1 for this specific application. The following steps provide a sequence of items that must be executed in the time between powering the device up and reading data from the device or transitioning from one mode to another mode of operation.

1. Apply power to the device:
  - a. Power up the IOVDD, BSTVDD and AVDD power supplies
  - b. Wait for at least 2ms to allow the device to initialize the internal registers.
  - c. The device now goes into sleep mode (low-power mode < 10µA)
2. Transition from sleep mode to active mode whenever required for the operation:
  - a. Wake up the device by writing to P0\_R2 to disable sleep mode
  - b. Wait for at least 2ms to allow the device to complete the internal wake-up sequence
  - c. Override the default configuration registers or programmable coefficients value as required (this step is optional)
  - d. Enable all desired input channels by writing to P0\_R118
  - e. Enable all desired audio serial interface input/output channels by writing to P0\_R30 to P0\_R37
  - f. Power-up the ADC, and MICBIAS by writing to P0\_R120
  - g. Apply FSYNC and BCLK with the desired output sample rates and the BCLK to FSYNC ratio

This specific step can be done at any point in the sequence after step a.

See the [Section 6.3.2](#) section for supported sample rates and the BCLK to FSYNC ratio.

- h. The device recording data is now sent to the host processor using the TDM audio serial data bus
3. Transition from active mode to sleep mode (again) as required in the system for low-power operation:
  - a. Enter sleep mode by writing to P0\_R2 to enable sleep mode
  - b. Wait at least 10ms (when FSYNC = 48kHz) for the volume to ramp down and for all blocks to power down
  - c. Read P0\_R122 to check the device shutdown and sleep mode status
  - d. If the device P0\_R122\_D[7:5] status bit is 3'b100 then stop FSYNC and BCLK in the system
  - e. The device now goes into sleep mode (low-power mode < 10µA) and retains all register values
4. Transition from sleep mode to active mode (again) as required for the recording operation:
  - a. Wake up the device by writing to P0\_R2 to disable sleep mode
  - b. Wait at least 2ms to allow the device to complete the internal wake-up sequence
  - c. Apply FSYNC and BCLK with the desired output sample rates and the BCLK to FSYNC ratio
  - d. The device recording data is now sent to the host processor using the TDM audio serial data bus
5. Repeat the steps as required for different device configurations and modes of operation

### 8.2.4 Application Performance Plots

At  $T_A = 25^\circ\text{C}$ ,  $AVDD = 3.3\text{V}$ ,  $IOVDD = 3.3\text{V}$ ,  $f_{IN} = 1\text{kHz}$  sinusoidal signal,  $f_S = 48\text{kHz}$ , 32-bit audio data,  $BCLK = 256 \times f_S$ , TDM target mode, PLL on, channel gain = 0dB, linear phase decimation filters, AC-coupled differential input with  $V_{CM} = 7.2\text{V}$ , Microphone Bias programmed voltage = 8V and other default configurations; measured filter free with an audio precision with a 20Hz to 20kHz un-weighted bandwidth, unless otherwise noted

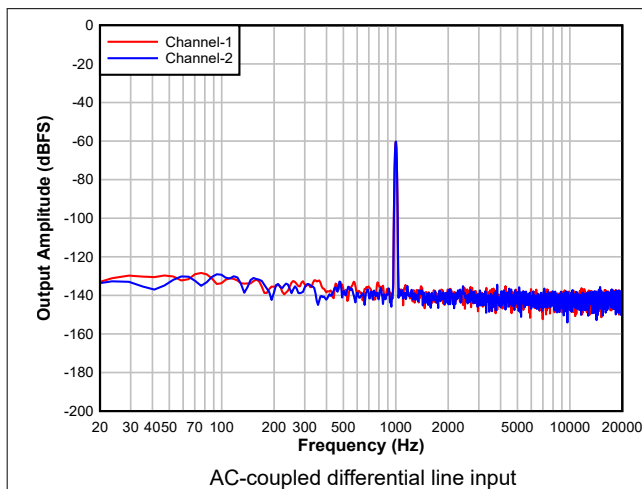


Figure 8-2. ADC FFT with -60dBFS Input

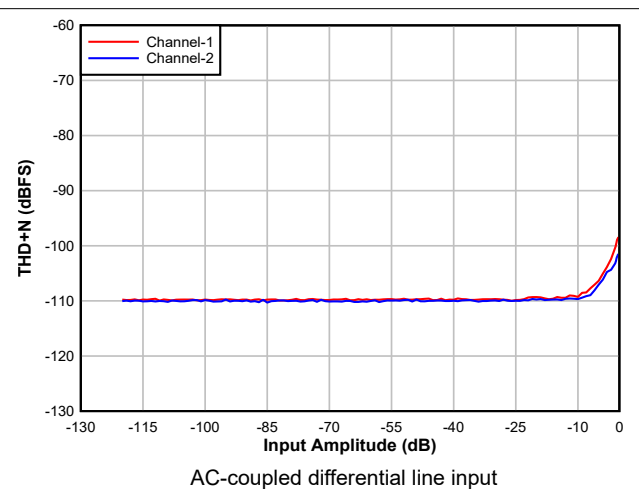
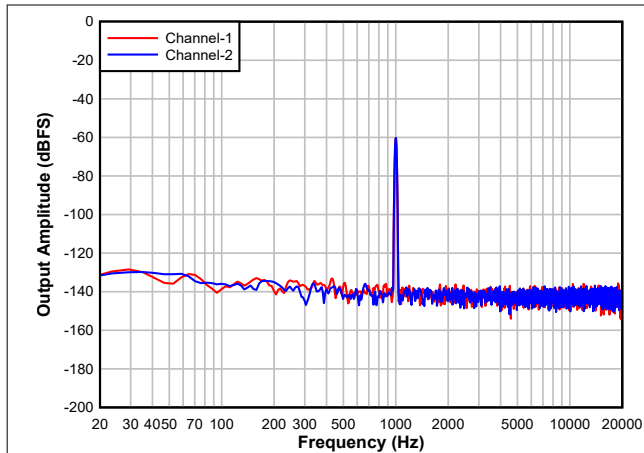
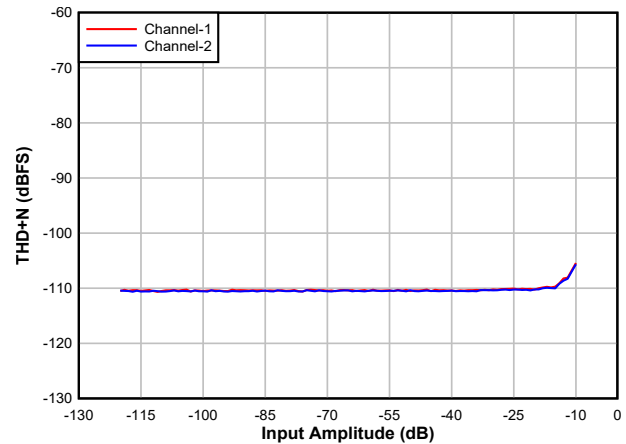


Figure 8-3. ADC THD+N Level vs Input



DC-coupled differential line input, with DC common-mode  
1NxP = 6V and INxM = 2V

**Figure 8-4. ADC FFT with -60dBFS Input**



DC-coupled differential line input, with DC common-mode  
1NxP = 6V and INxM = 2V

**Figure 8-5. ADC THD+N Level vs Input**

### 8.2.5 Example Device Register Configuration Scripts for EVM Setup

This section provides a typical EVM I<sup>2</sup>C register control script for various applications.

#### Stereo differential analog AC-coupled input recording

```
# Key: w a0 XX YY ==> write to I2C address 0xa0, to register 0xxx, data 0xyy
# # ==> comment delimiter
#
# The following list gives an example sequence of items that must be executed in the time
# between powering the device up and reading data from the device. Note that there are
# other valid sequences depending on which features are used.
#
# Differential 2-channel ADC: INP1/INM1 - Ch1, INP2/INM2 - Ch2
# FSYNC = 48 kHz (Output Data Sample Rate), BCLK = 12.288 MHz (BCLK/FSYNC = 256)
# AVDD = 3.3 V; IOVDD = 3.3 V; BSTVDD = 3.3 V
#####
#
# Page 0 Register Writes
w a0 00 00
w a0 01 01 #SW Reset
d 01

#Page 1 Register Writes
w a0 00 01
w a0 73 B0 #MICBIAS set to 8V

# Page 0 Register Writes
w a0 00 00
w a0 02 09 #Exit Sleep Mode with DREG and VREF Enabled

w a0 1a 30 #TDM protocol with 32-bit word length

w a0 50 00 #ADC Channel 1 configured for AC-coupled differential input with 10Vrms swing and
audio bandwidth
w a0 55 00 #ADC Channel 2 configured for AC-coupled differential input with 10Vrms swing and
audio bandwidth

w a0 76 c0 #Input Channels 1, 2 enabled;

w a0 78 a0 #ADC, MICBIAS Powered Up

# Apply FSYNC = 48 kHz and BCLK = 12.288 MHz and
# Start recording data by host on ASI bus with TDM protocol 32-bits channel wordlength
```

## Stereo differential analog DC-coupled input recording

```
# Key: w a0 XX YY ==> write to I2C address 0xa0, to register 0xxx, data 0xyy
# # ==> comment delimiter
#
# The following list gives an example sequence of items that must be executed in the time
# between powering the device up and reading data from the device. Note that there are
# other valid sequences depending on which features are used.
#
# Differential 2-channel ADC: INP1/INM1 - Ch1, INP2/INM2 - Ch2
# FSYNC = 48 kHz (Output Data Sample Rate), BCLK = 12.288 MHz (BCLK/FSYNC = 256)
# AVDD = 3.3 V; IOVDD = 3.3 V; BSTVDD = 3.3 V
#####
#
# Page 0 Register Writes
w a0 00 00
w a0 01 01 #SW Reset
d 01

#Page 1 Register Writes
w a0 00 01
w a0 73 B0 #MICBIAS set to 8V

# Page 0 Register Writes
w a0 00 00
w a0 02 09 #Exit Sleep Mode with DREG and VREF Enabled

w a0 1a 30 #TDM protocol with 32-bit word length

w a0 50 08 #ADC Channel 1 configured for DC-coupled differential input with 10Vrms swing and
audio bandwidth
w a0 55 08 #ADC Channel 2 configured for DC-coupled differential input with 10Vrms swing and
audio bandwidth

w a0 76 c0 #Input Channels 1, 2 enabled;

w a0 78 a0 #ADC, MICBIAS Powered Up

# Apply FSYNC = 48 kHz and BCLK = 12.288 MHz and
# Start recording data by host on ASI bus with TDM protocol 32-bits channel wordlength
```

## Four-channel PDM microphone recording

```
# Key: w a0 XX YY ==> write to I2C address 0xa0, to register 0xxx, data 0xyy
# # ==> comment delimiter
#
# The following list gives an example sequence of items that must be executed in the time
# between powering the device up and reading data from the device. Note that there are
# other valid sequences depending on which features are used.
#
#
# GPIO1 - PDMCLK @ 3.072MHz
# PDM Ch1/2 on GPIO2
# PDM Ch3/4 on GPI1
# FSYNC = 48 kHz (Output Data Sample Rate), BCLK = 12.288 MHz (BCLK/FSYNC = 256)
# AVDD = 3.3 V; IOVDD = 3.3 V
#####
#
#
# Page 0 Register Writes
w a0 00 00
w a0 01 01 #SW Reset

# Page 0 Register Writes
w a0 00 00
w a0 02 09 #Exit Sleep Mode with DREG and VREF Enabled

w a0 0a 41 #Configure GPIO1 as PDMCLK, with active high/active low drive
w a0 35 00 #PDMCLK frequency = 3.072 MHz

w a0 0d 03 #Configure GPI1A and GPI2A as GPI input
```

```

w a0 13 cb    #Configure Channel1 and Channel2 as PDM; PDM1/2 data in on GPI2A; PDM3/4 data in on
GPI1A
w a0 1a 30    #TDM protocol with 32-bit word length
w a0 1e 20    #Channel1 data on TDM slot 0
w a0 1f 21    #Channel2 data on TDM slot 1
w a0 20 22    #Channel3 data on TDM slot 2
w a0 21 23    #Channel4 data on TDM slot 3

w a0 76 f0    #Enable input channels 1-4
w a0 78 80    #Power up ADC path

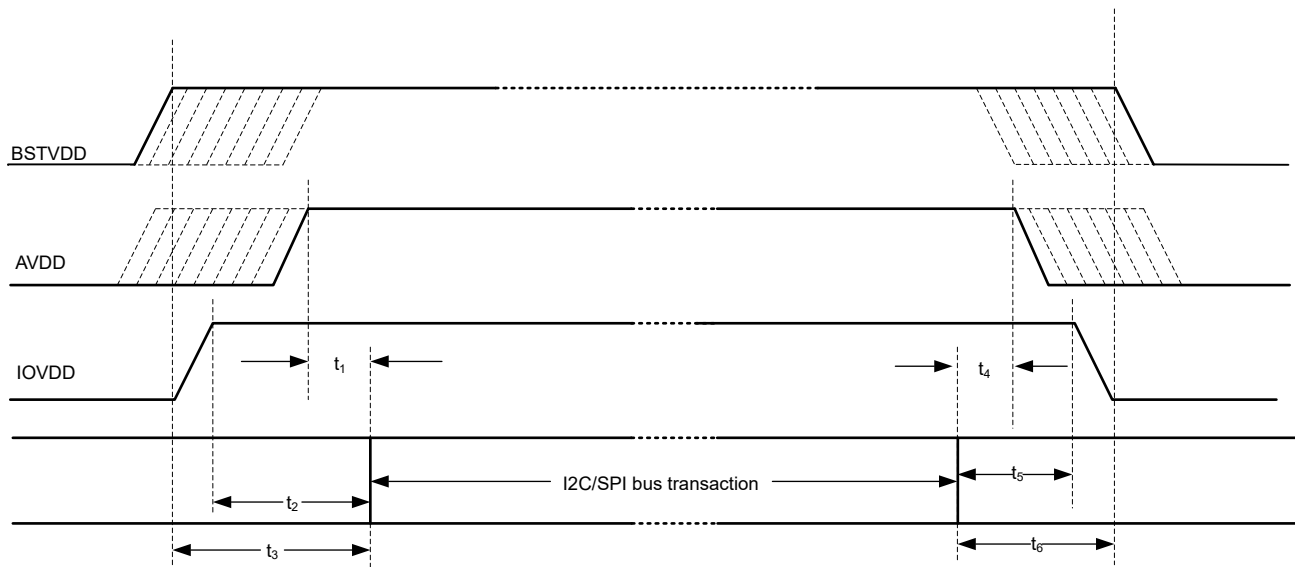
# Provide BCLK, FSYNC corresponding to 48kSPS, and record with 32-bit TDM bus

```

### 8.3 Power Supply Recommendations

The power-supply sequence between the IOVDD, BSTVDD and AVDD rails can be applied in any order. However, after all supplies are stable, then only initiate the I<sup>2</sup>C or SPI transactions to initialize the device.

For the supply power-up requirement,  $t_1$ ,  $t_2$  and  $t_3$  must be at least 2ms to allow the device to initialize the internal registers. See the [Section 6.4](#) section for details on how the device operates in various modes after the device power supplies are settled to the recommended operating voltage levels. For the supply power-down requirement,  $t_4$ ,  $t_5$  and  $t_6$  must be at least 10ms. This timing (as shown in [Figure 8-6](#)) allows the device to ramp down the volume on the record data, power down the analog and digital blocks, and put the device into shutdown mode. The device can also be immediately put into shutdown mode by ramping down power supplies, but doing so causes an abrupt shutdown.



**Figure 8-6. Power-Supply Sequencing Requirement Timing Diagram**

Make sure that the supply ramp rate is slower than  $0.1\text{V}/\mu\text{s}$  and that the wait time between a power-down and a power-up event is at least 100ms. For supply ramp rate slower than  $0.1\text{V}/\text{ms}$ , host device must apply a software reset as first transaction before doing any device configuration. Make sure all digital input pins are at valid input levels and not toggling during supply sequencing.

The TAA5412-Q1 supports a single AVDD supply operation by integrating an on-chip digital regulator, DREG, and an analog regulator, AREG. Ensure IOVDD\_IO\_MODE (P0\_R2\_D[1]) registers are set correctly for IOVDD 1.8V and 1.2V operation as described in [Section 8.3.1](#).



### 8.3.1 IOVDD\_IO\_MODE for 1.8V and 1.2V Operation

After the supplies are stable, the default register configuration of the device has a speed limitation on the maximum clock speed that can be supported for IOVDD = 1.8V or 1.2V at first power up of device with default configurations except for the first write operation. Whenever using IOVDD 1.8V and 1.2V operation, the first operation by user should always be to write the IOVDD\_IO\_MODE (P0\_R2\_D[1]) setting to 1'b1 after power-up or reset, and then there are no speed limitations in subsequent operation of device. This setting is not needed or applicable when using IOVDD 3.3V operation.

## 8.4 Layout

### 8.4.1 Layout Guidelines

Each system design and printed circuit board (PCB) layout is unique. The layout must be carefully reviewed in the context of a specific PCB design. However, the following guidelines can optimize the device performance:

- Connect the thermal pad to ground. Use a via pattern to connect the device thermal pad, which is the area directly under the device, to the ground planes. This connection helps dissipate heat from the device.
- Star connect all ground pins to the board ground plane. Use the same ground between VSS and AVSS to avoid any potential voltage difference between them.
- The decoupling capacitors for the power supplies and the boost converter inductor must be placed close to the device pins.
- The supply decoupling capacitors used must be of a ceramic type with low ESR.
- Route the analog differential audio signals differentially on the PCB for better noise immunity. Avoid crossing digital and analog signals to prevent undesirable crosstalk.
- Avoid running high-frequency clock and control signals near INxx pins where possible.
- The device internal voltage references must be filtered using external capacitors. Place the filter capacitors near the VREF pin for good performance.
- Directly tap the MICBIAS pin to avoid common impedance when routing the biasing or supply traces for multiple microphones to avoid coupling across microphones.
- Provide a direct connection from the VREF and MICBIAS external capacitor ground terminal to VSS.
- Place the MICBIAS capacitor (with low equivalent series resistance) close to the device with minimal trace impedance.
- Use MICBIAS and BSTOUT capacitors with a high voltage rating (> 25V) to support higher voltage MICBIAS operation.
- An external circuit must be used to suppress or filter the amount of high-frequency electromagnetic interference (EMI) noise found in the microphone input path resulting from long cables (if used) in the system.
- Use ground planes to provide the lowest impedance for power and signal current between the device and the decoupling capacitors. Treat the area directly under the device as a central ground area for the device, and all device grounds must be connected directly to that area.

### 8.4.2 Layout Example

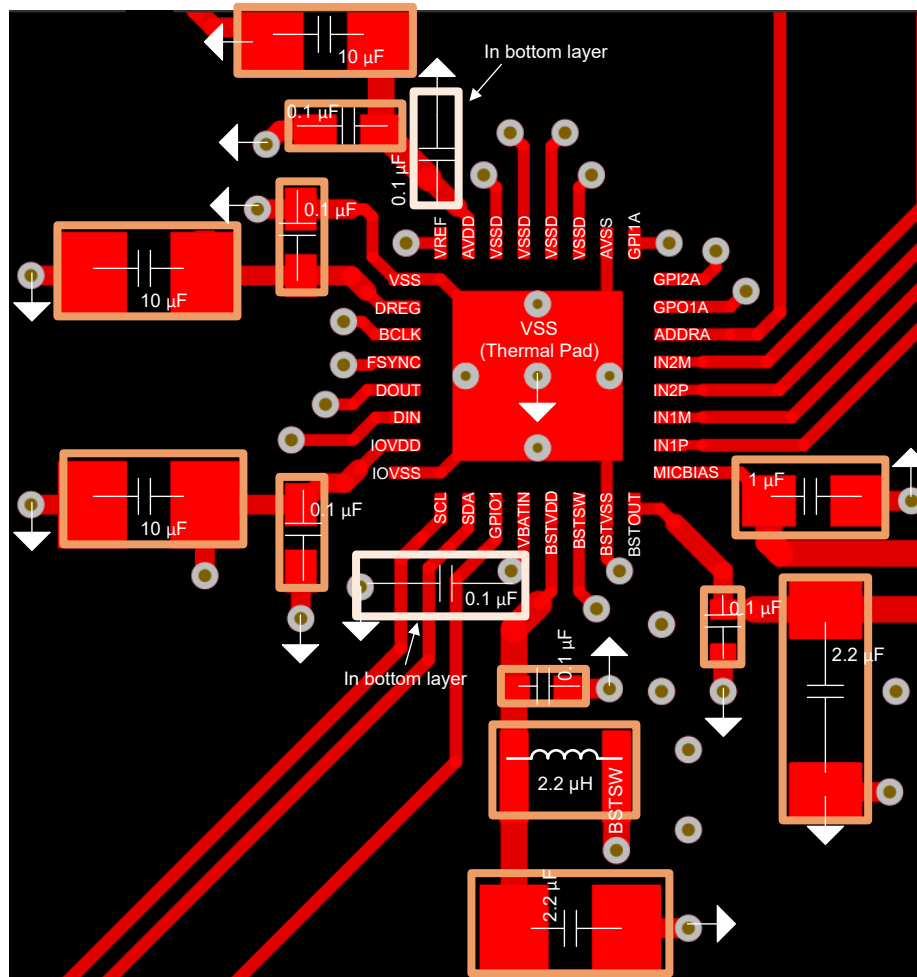


Figure 8-7.

## 9 Revision History

NOTE: Page numbers for previous revisions may differ from page numbers in the current version.

### Changes from Revision \* (January 2024) to Revision A (January 2025)

Page

- Updated device status to production data..... 1

## 10 Device and Documentation Support

TI offers an extensive line of development tools. Tools and software to evaluate the performance of the device, generate code, and develop solutions are listed below.

### 10.1 Documentation Support

#### 10.1.1 Related Documentation

For related documentation see the following:

- Texas Instruments, [TAx5x1xQ15B5EVM-K Evaluation Module User's Guide](#)
- Texas Instruments, [TAx5xxx-Q1 Fault Diagnostic Features application report](#)
- Texas Instruments, [Clocking Configuration of Device and Flexible Clocking For TAx5x1x Family application report](#)
- Texas Instruments, [Clock Error Configuration, Detection, and Modes Supported in TAx5x1x Family application report](#)
- Texas Instruments, [Analog Input Configurations, Mixing and Muxing of TAx5x1x-Q1 Devices application report](#)
- Texas Instruments, [TAC5x1x and TAC5x1x-Q1 Programmable Biquad Filters - Configuration and Applications application report](#)
- Texas Instruments, [TAA5412-Q1 Power Consumption Matrix Across Various Usage Scenarios application report](#)
- Texas Instruments, [Multiple TAC5x1x Devices With a Shared TDM and I2C/SPI Bus application report](#)

### 10.2 Receiving Notification of Documentation Updates

To receive notification of documentation updates, navigate to the device product folder on [ti.com](#). Click on *Notifications* to register and receive a weekly digest of any product information that has changed. For change details, review the revision history included in any revised document.

### 10.3 Support Resources

TI E2E™ [support forums](#) are an engineer's go-to source for fast, verified answers and design help — straight from the experts. Search existing answers or ask your own question to get the quick design help you need.

Linked content is provided "AS IS" by the respective contributors. They do not constitute TI specifications and do not necessarily reflect TI's views; see TI's [Terms of Use](#).

### 10.4 Trademarks

TI E2E™ is a trademark of Texas Instruments.  
All trademarks are the property of their respective owners.

### 10.5 Electrostatic Discharge Caution



This integrated circuit can be damaged by ESD. Texas Instruments recommends that all integrated circuits be handled with appropriate precautions. Failure to observe proper handling and installation procedures can cause damage.

ESD damage can range from subtle performance degradation to complete device failure. Precision integrated circuits may be more susceptible to damage because very small parametric changes could cause the device not to meet its published specifications.

### 10.6 Glossary

[TI Glossary](#) This glossary lists and explains terms, acronyms, and definitions.

## 11 Mechanical, Packaging, and Orderable Information

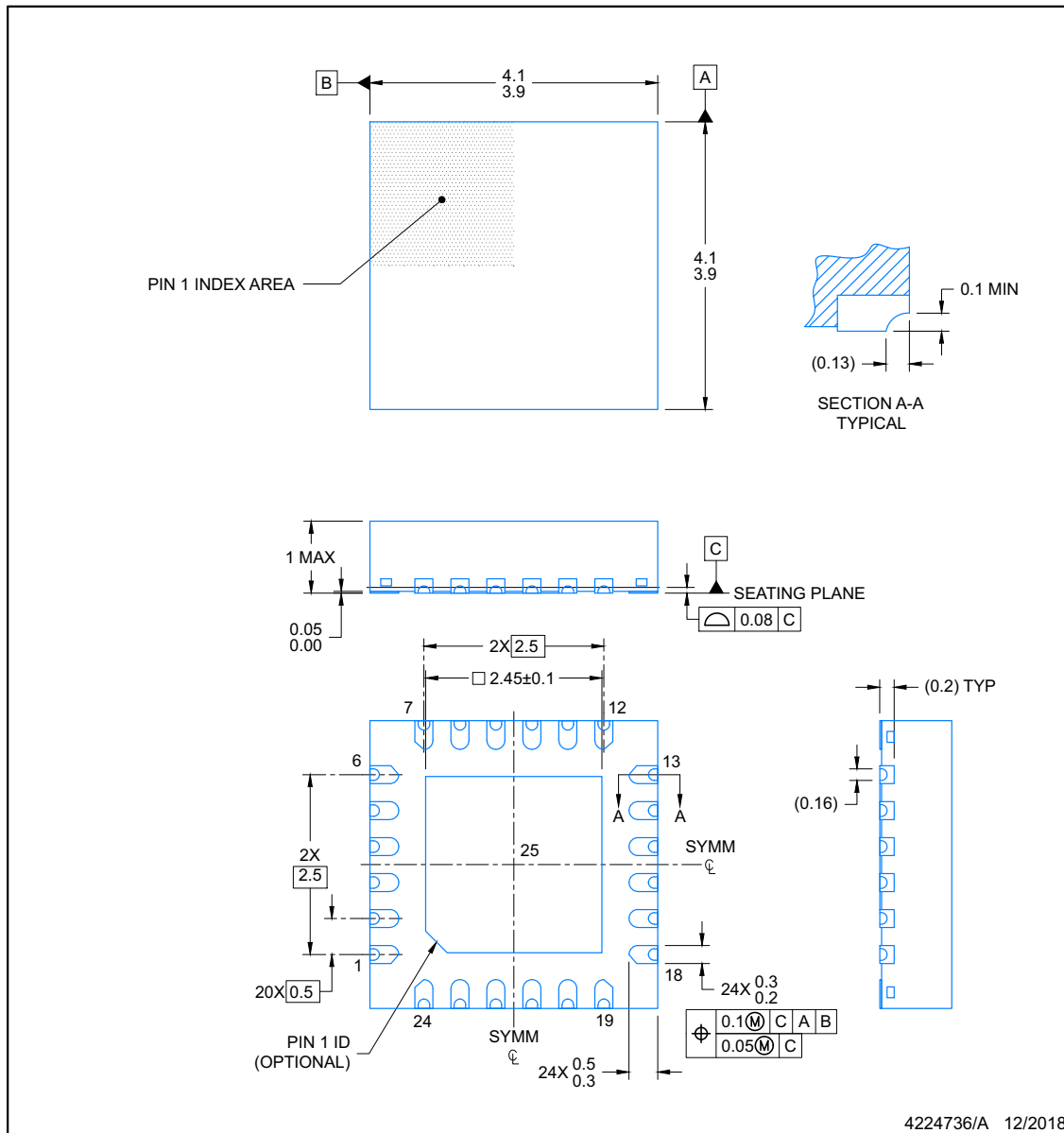
The following pages include mechanical, packaging, and orderable information. This information is the most current data available for the designated devices. This data is subject to change without notice and revision of this document. For browser-based versions of this data sheet, refer to the left-hand navigation.

# PACKAGE OUTLINE

## VQFN - 1 mm max height

### RGE0024N

PLASTIC QUAD FLATPACK-NO LEAD



4224736/A 12/2018

**NOTES:**

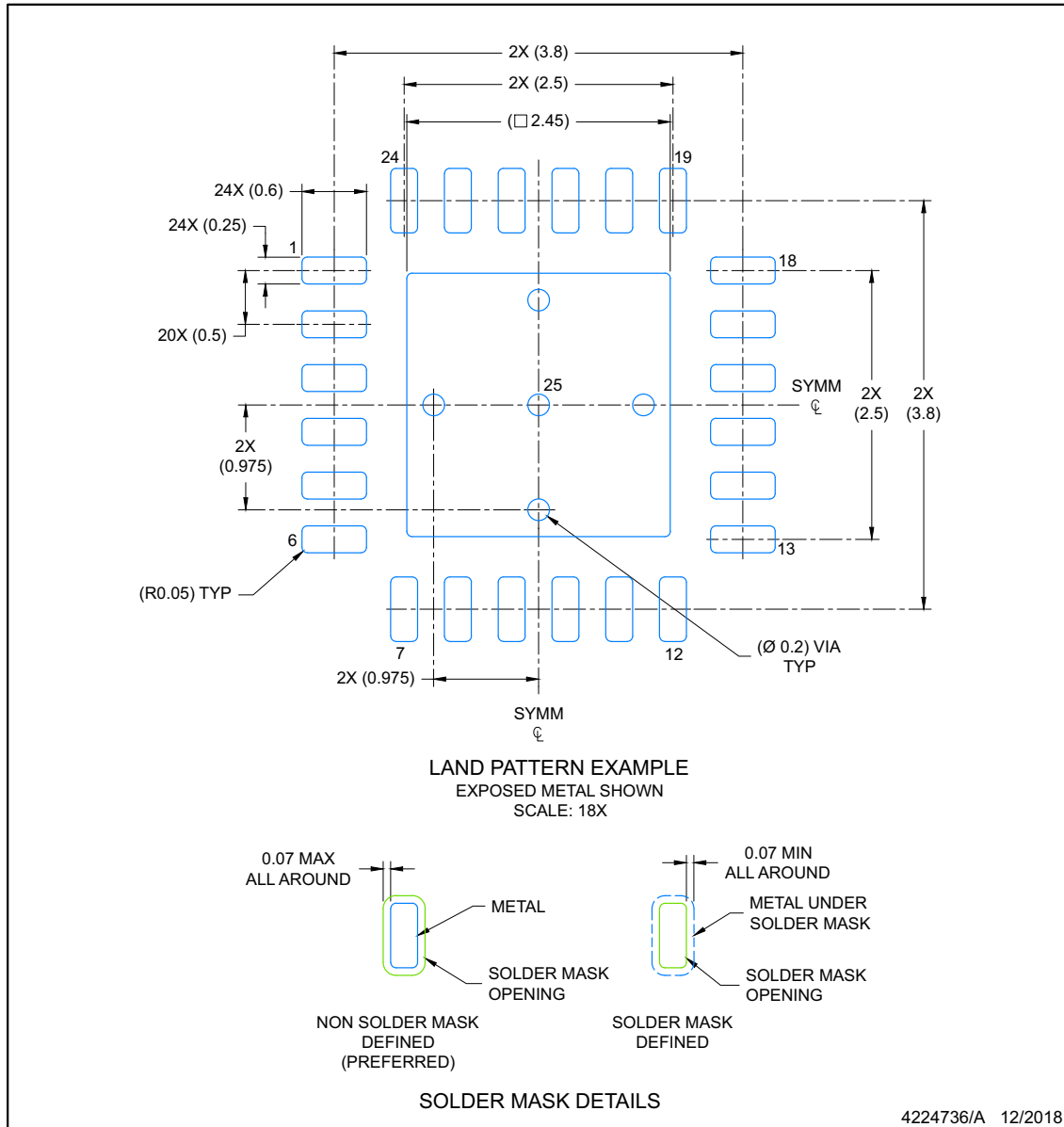
1. All linear dimensions are in millimeters. Any dimensions in parenthesis are for reference only. Dimensioning and tolerancing per ASME Y14.5M.
2. This drawing is subject to change without notice.
3. The package thermal pad must be soldered to the printed circuit board for optimal thermal and mechanical performance.

## EXAMPLE BOARD LAYOUT

### RGE0024N

### VQFN - 1 mm max height

PLASTIC QUAD FLATPACK-NO LEAD



NOTES: (continued)

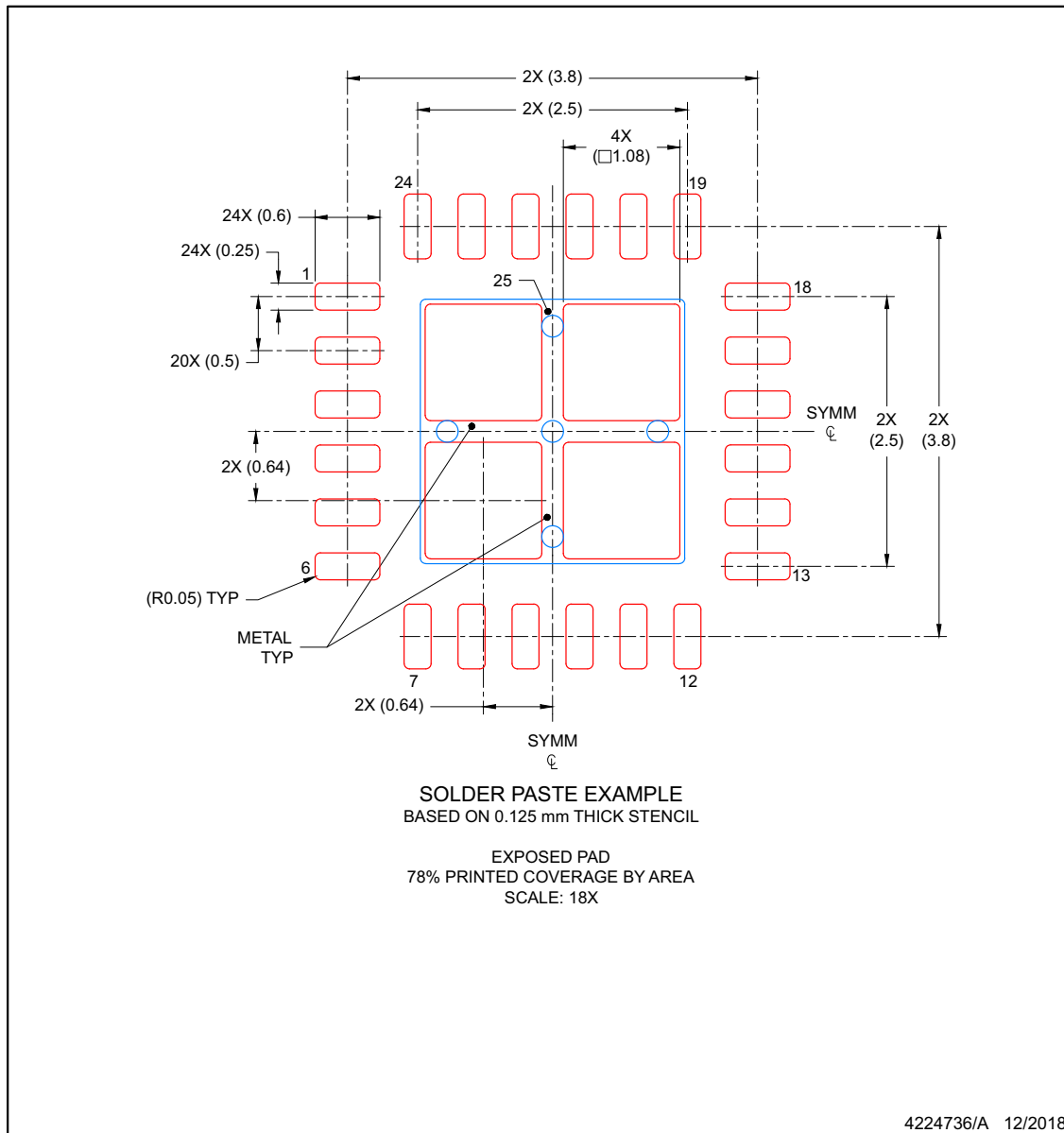
- This package is designed to be soldered to a thermal pad on the board. For more information, see Texas Instruments literature number SLUA271 ([www.ti.com/lit/sl原因271](http://www.ti.com/lit/sl原因271)).
- Vias are optional depending on application, refer to device data sheet. If any vias are implemented, refer to their locations shown on this view. It is recommended that vias under paste be filled, plugged or tented.

## EXAMPLE STENCIL DESIGN

### RGE0024N

### VQFN - 1 mm max height

PLASTIC QUAD FLATPACK-NO LEAD



NOTES: (continued)

6. Laser cutting apertures with trapezoidal walls and rounded corners may offer better paste release. IPC-7525 may have alternate design recommendations.

**PACKAGING INFORMATION**

Orderable Device	Status (1)	Package Type	Package Drawing	Pins	Package Qty	Eco Plan (2)	Lead finish/ Ball material (6)	MSL Peak Temp (3)	Op Temp (°C)	Device Marking (4/5)	Samples
TAA5412WQRTVRQ1	ACTIVE	WQFN	RTV	32	3000	RoHS & Green	NIPDAU	Level-2-260C-1 YEAR	-40 to 125	TAA5412 Q1	<a href="#">Samples</a>
XA5412QRGERQ1	ACTIVE	VQFN	RGE	24	3000	TBD	Call TI	Call TI	-40 to 125		<a href="#">Samples</a>
XA5412WQRTVRQ1	ACTIVE	WQFN	RTV	32	3000	TBD	Call TI	Call TI	-40 to 125		<a href="#">Samples</a>

(1) The marketing status values are defined as follows:

**ACTIVE:** Product device recommended for new designs.

**LIFEBUY:** TI has announced that the device will be discontinued, and a lifetime-buy period is in effect.

**NRND:** Not recommended for new designs. Device is in production to support existing customers, but TI does not recommend using this part in a new design.

**PREVIEW:** Device has been announced but is not in production. Samples may or may not be available.

**OBSOLETE:** TI has discontinued the production of the device.

(2) **RoHS:** TI defines "RoHS" to mean semiconductor products that are compliant with the current EU RoHS requirements for all 10 RoHS substances, including the requirement that RoHS substance do not exceed 0.1% by weight in homogeneous materials. Where designed to be soldered at high temperatures, "RoHS" products are suitable for use in specified lead-free processes. TI may reference these types of products as "Pb-Free".

**RoHS Exempt:** TI defines "RoHS Exempt" to mean products that contain lead but are compliant with EU RoHS pursuant to a specific EU RoHS exemption.

**Green:** TI defines "Green" to mean the content of Chlorine (Cl) and Bromine (Br) based flame retardants meet JS709B low halogen requirements of <=1000ppm threshold. Antimony trioxide based flame retardants must also meet the <=1000ppm threshold requirement.

(3) MSL, Peak Temp. - The Moisture Sensitivity Level rating according to the JEDEC industry standard classifications, and peak solder temperature.

(4) There may be additional marking, which relates to the logo, the lot trace code information, or the environmental category on the device.

(5) Multiple Device Markings will be inside parentheses. Only one Device Marking contained in parentheses and separated by a "~" will appear on a device. If a line is indented then it is a continuation of the previous line and the two combined represent the entire Device Marking for that device.

(6) Lead finish/Ball material - Orderable Devices may have multiple material finish options. Finish options are separated by a vertical ruled line. Lead finish/Ball material values may wrap to two lines if the finish value exceeds the maximum column width.

**Important Information and Disclaimer:**The information provided on this page represents TI's knowledge and belief as of the date that it is provided. TI bases its knowledge and belief on information provided by third parties, and makes no representation or warranty as to the accuracy of such information. Efforts are underway to better integrate information from third parties. TI has taken and continues to take reasonable steps to provide representative and accurate information but may not have conducted destructive testing or chemical analysis on incoming materials and chemicals. TI and TI suppliers consider certain information to be proprietary, and thus CAS numbers and other limited information may not be available for release.

In no event shall TI's liability arising out of such information exceed the total purchase price of the TI part(s) at issue in this document sold by TI to Customer on an annual basis.



**TAPE AND REEL INFORMATION**

**QUADRANT ASSIGNMENTS FOR PIN 1 ORIENTATION IN TAPE**


\*All dimensions are nominal

Device	Package Type	Package Drawing	Pins	SPQ	Reel Diameter (mm)	Reel Width W1 (mm)	A0 (mm)	B0 (mm)	K0 (mm)	P1 (mm)	W (mm)	Pin1 Quadrant
TAA5412WQRTVRQ1	WQFN	RTV	32	3000	330.0	12.4	5.3	5.3	1.1	8.0	12.0	Q2

**TAPE AND REEL BOX DIMENSIONS**


\*All dimensions are nominal

Device	Package Type	Package Drawing	Pins	SPQ	Length (mm)	Width (mm)	Height (mm)
TAA5412WQRTVRQ1	WQFN	RTV	32	3000	367.0	367.0	35.0

## GENERIC PACKAGE VIEW

RGE 24

VQFN - 1 mm max height

PLASTIC QUAD FLATPACK - NO LEAD

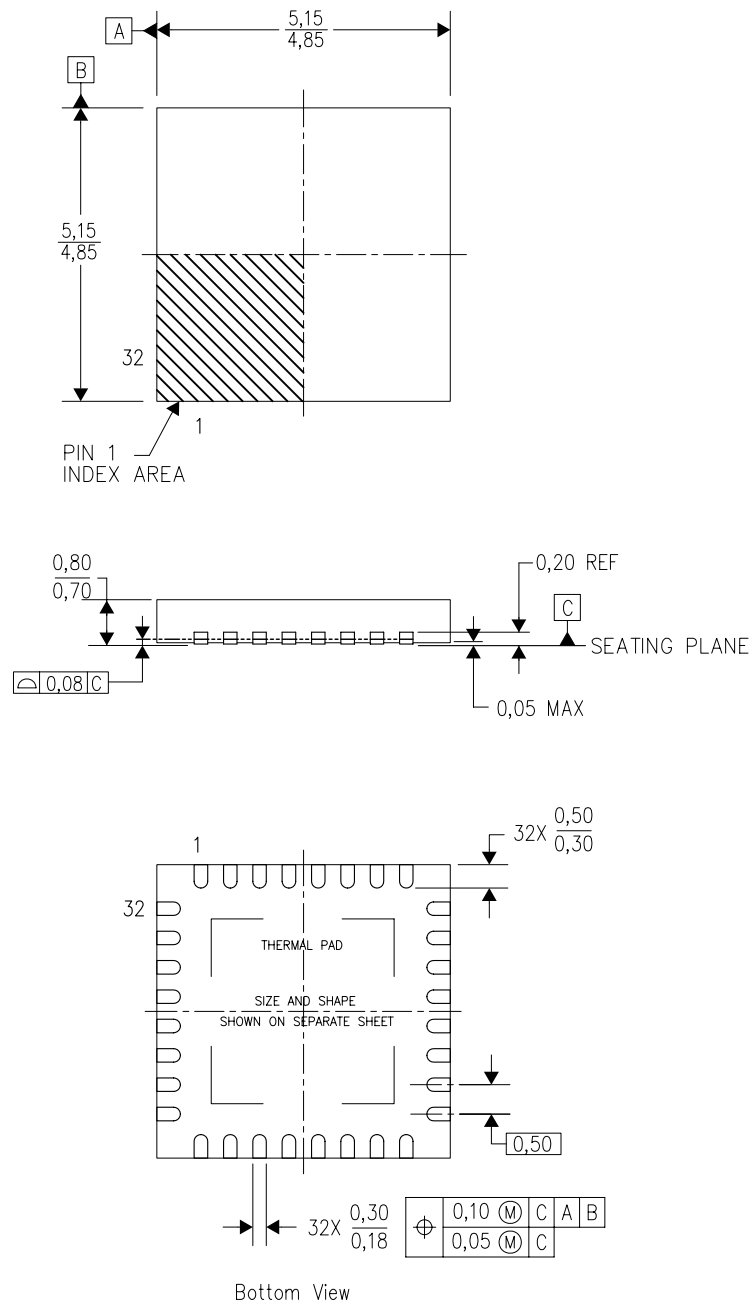


Images above are just a representation of the package family, actual package may vary.  
Refer to the product data sheet for package details.

4204104/H

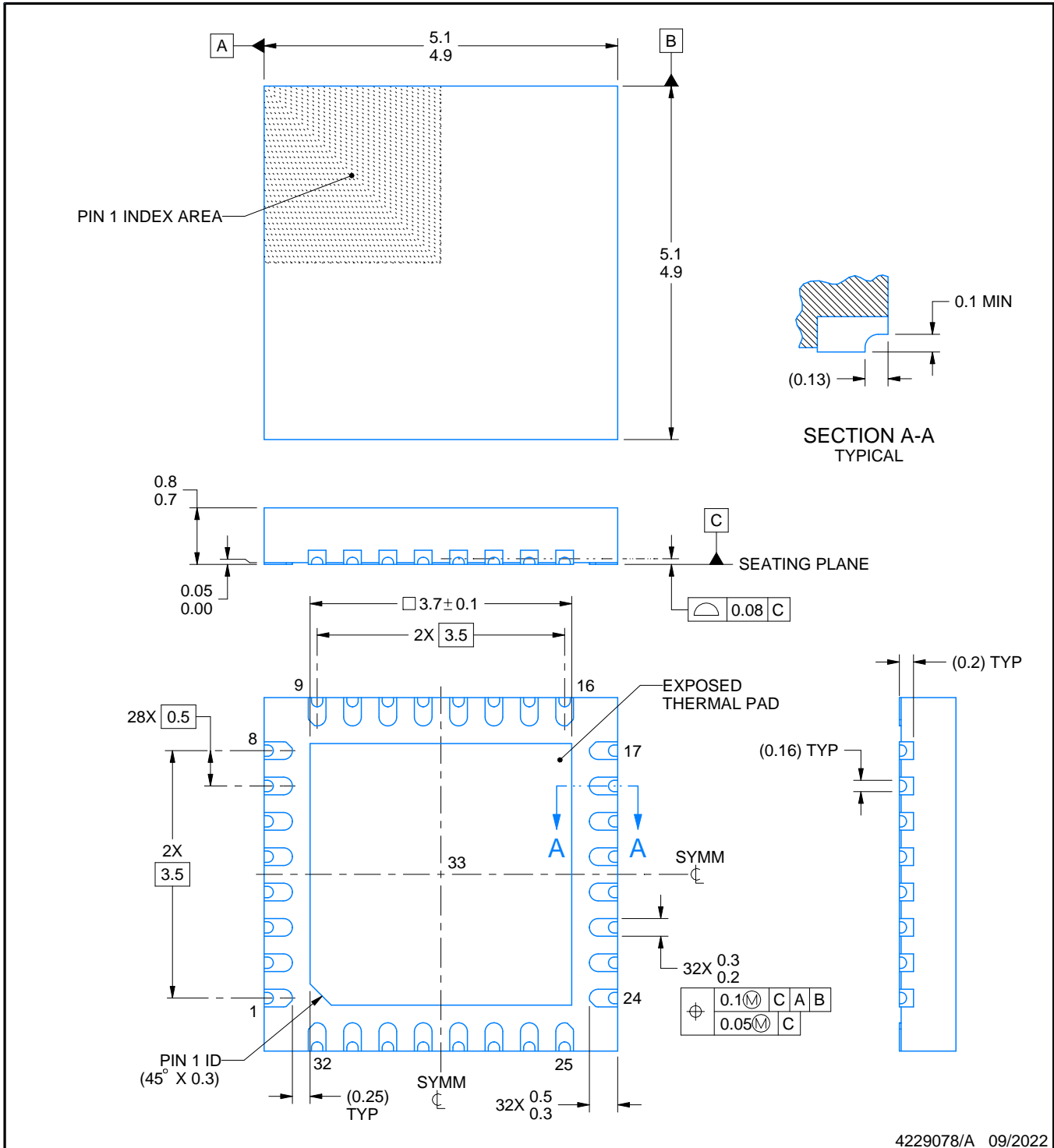
RTV (S-PWQFN-N32)

PLASTIC QUAD FLATPACK NO-LEAD



4206245/C 10/11

- NOTES:
- All linear dimensions are in millimeters. Dimensioning and tolerancing per ASME Y14.5-1994.
  - This drawing is subject to change without notice.
  - Quad Flatpack, No-Leads (QFN) package configuration.
  - The package thermal pad must be soldered to the board for thermal and mechanical performance.
  - See the additional figure in the Product Data Sheet for details regarding the exposed thermal pad features and dimensions.
  - Falls within JEDEC MO-220.



NOTES:

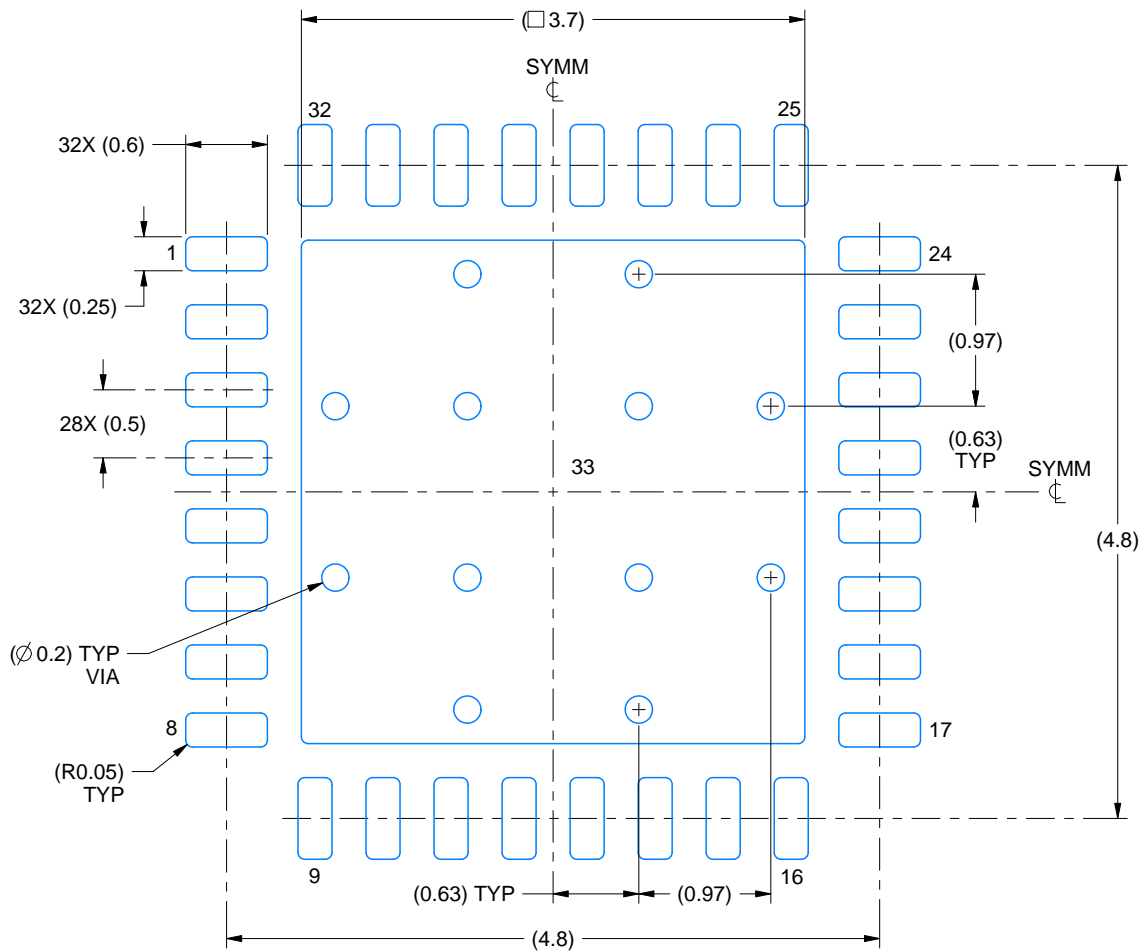
1. All linear dimensions are in millimeters. Any dimensions in parenthesis are for reference only. Dimensioning and tolerancing per ASME Y14.5M.
2. This drawing is subject to change without notice.
3. The package thermal pad must be soldered to the printed circuit board for thermal and mechanical performance.

# EXAMPLE BOARD LAYOUT

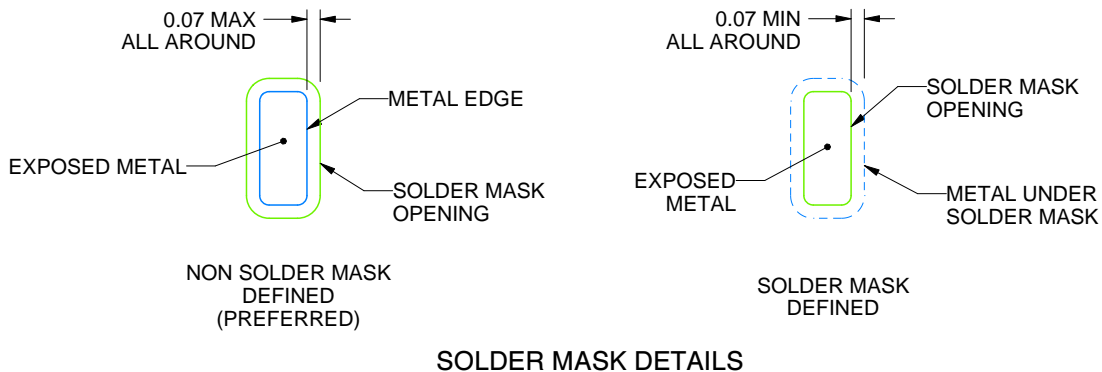
RTV0032L

WQFN - 0.8 mm max height

PLASTIC QUAD FLATPACK - NO LEAD



LAND PATTERN EXAMPLE  
EXPOSED METAL SHOWN  
SCALE:18X



4229078/A 09/2022

NOTES: (continued)

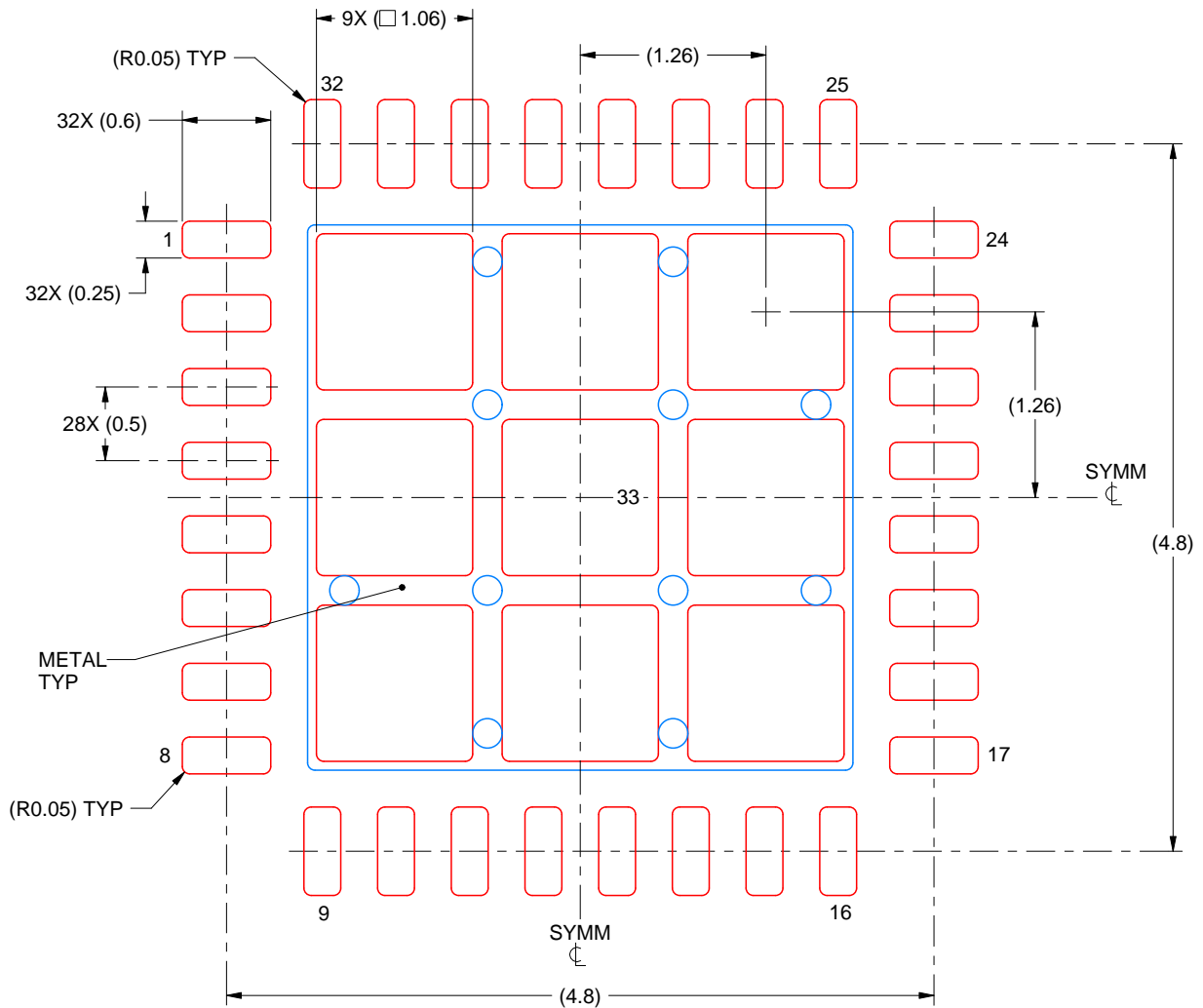
- This package is designed to be soldered to a thermal pad on the board. For more information, see Texas Instruments literature number SLUA271 ([www.ti.com/lit/slua271](http://www.ti.com/lit/slua271)).
- Vias are optional depending on application, refer to device data sheet. If any vias are implemented, refer to their locations shown on this view. It is recommended that vias under paste be filled, plugged or tented.

# EXAMPLE STENCIL DESIGN

RTV0032L

WQFN - 0.8 mm max height

PLASTIC QUAD FLATPACK - NO LEAD



**SOLDER PASTE EXAMPLE**  
 BASED ON 0.125 mm THICK STENCIL

EXPOSED PAD 33:  
 74% PRINTED SOLDER COVERAGE BY AREA UNDER PACKAGE  
 SCALE:20X

4229078/A 09/2022

NOTES: (continued)

6. Laser cutting apertures with trapezoidal walls and rounded corners may offer better paste release. IPC-7525 may have alternate design recommendations.

## IMPORTANT NOTICE AND DISCLAIMER

TI PROVIDES TECHNICAL AND RELIABILITY DATA (INCLUDING DATA SHEETS), DESIGN RESOURCES (INCLUDING REFERENCE DESIGNS), APPLICATION OR OTHER DESIGN ADVICE, WEB TOOLS, SAFETY INFORMATION, AND OTHER RESOURCES "AS IS" AND WITH ALL FAULTS, AND DISCLAIMS ALL WARRANTIES, EXPRESS AND IMPLIED, INCLUDING WITHOUT LIMITATION ANY IMPLIED WARRANTIES OF MERCHANTABILITY, FITNESS FOR A PARTICULAR PURPOSE OR NON-INFRINGEMENT OF THIRD PARTY INTELLECTUAL PROPERTY RIGHTS.

These resources are intended for skilled developers designing with TI products. You are solely responsible for (1) selecting the appropriate TI products for your application, (2) designing, validating and testing your application, and (3) ensuring your application meets applicable standards, and any other safety, security, regulatory or other requirements.

These resources are subject to change without notice. TI grants you permission to use these resources only for development of an application that uses the TI products described in the resource. Other reproduction and display of these resources is prohibited. No license is granted to any other TI intellectual property right or to any third party intellectual property right. TI disclaims responsibility for, and you will fully indemnify TI and its representatives against, any claims, damages, costs, losses, and liabilities arising out of your use of these resources.

TI's products are provided subject to [TI's Terms of Sale](#) or other applicable terms available either on [ti.com](https://www.ti.com) or provided in conjunction with such TI products. TI's provision of these resources does not expand or otherwise alter TI's applicable warranties or warranty disclaimers for TI products.

TI objects to and rejects any additional or different terms you may have proposed.

Mailing Address: Texas Instruments, Post Office Box 655303, Dallas, Texas 75265

Copyright © 2025, Texas Instruments Incorporated