

# TAD5212 High-performance stereo audio DAC with 120dB dynamic range, and headphone/line driver

## 1 Features

- Stereo differential or Quad single-ended high-performance audio DAC
  - Performance:
    - DAC to differential line-out dynamic range: 120dB
    - DAC to differential headphone-out dynamic range: 118dB
    - THD+N: –104 dB
  - Line-out/headphone output voltage:
    - Differential,  $2V_{RMS}$  full-scale
    - Pseudo-differential,  $1V_{RMS}$  full-scale
    - Single-ended,  $1V_{RMS}$  full-scale
- Key features
  - Analog input to output bypass path
  - 4-Channel PDM digital microphone record path
  - Input and output mix/mux options
  - Voice activity detection
  - Ultrasonic activity detection
  - Ultrasonic signal or tone generator
  - Battery and thermal foldback protection
  - Signal distortion limiter
  - Low and Ultra-low latency filter options
  - Programmable HPF and Biquad filters
  - I<sup>2</sup>C & SPI Control Interface
  - Audio Serial Interface
    - Format: TDM, I<sup>2</sup>S or Left-justified (LJ)
    - Word length: 16, 20, 24 or 32 Bits
    - Bus controller and target modes
    - Daisy chain in TDM Mode
  - Programmable PLL for flexible clocking
  - Auto clock and sample rate detection
  - Low Power Modes
    - 11mW for 2-Ch Playback (1.8V supply)
  - Single Supply Operation AVDD: 1.8V or 3.3V
  - I/O Supply Operation: 1.2V or 1.8V or 3.3V
  - Temperature grade 1:  $-40^{\circ}\text{C} \leq T_A \leq +125^{\circ}\text{C}$

## 2 Applications

- [Soundbar](#)
- [Portable Audio and Video](#)
- [Smart Speakers](#)
- [AV Receivers](#)
- [Professional Audio Mixer/Control Surface](#)

## 3 Description

The TAD5212 is a high performance audio DAC with  $2V_{RMS}$  differential output, 120dB dynamic range stereo channels or  $1V_{RMS}$  single-ended output, 111dB dynamic range quad channels. The TAD5212 supports both differential and single-ended inputs and outputs. The DAC outputs can be configured for either line-output or headphone loads. The DAC can drive up to 62.5mW into a  $16\Omega$  headphone load. The TAD5212 integrates programmable channel gain, digital volume control, a low-jitter phase-locked loop (PLL), a programmable high-pass filter (HPF), programmable EQ and biquad filters, low-latency and ultra-low latency filter modes, and allows for sample rates up to 768kHz for both the DAC and PDM microphone signal-chains. The TAD5212 supports analog input to output bypass option and also recording up to four-channel digital microphones with the PDM interface. Data from Analog-In and Digital-In can be mixed inside the device as well. The TAD5212 supports time-division multiplexing (TDM), I<sup>2</sup>S, or left-justified (LJ) audio formats, and can be controlled with I<sup>2</sup>C or SPI. These integrated high-performance features, along with a single supply operation, make TAD5212 an excellent choice for space-constrained audio applications.

### Device Information

PART NUMBER	PACKAGE <sup>(1)</sup>	PACKAGE SIZE (NOM) <sup>(2)</sup>
TAD5212	VQFN (24)	4mm x 4mm with 0.5mm pitch

(1) For all available packages, see the orderable addendum at the end of the data sheet.

(2) The package size (length × width) is a nominal value and includes pins, where applicable.

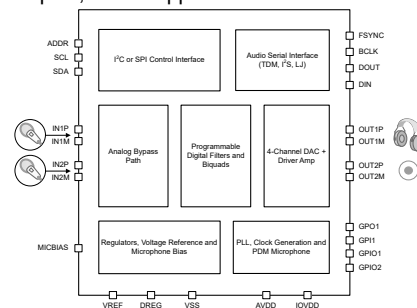

**Simplified Block Diagram**



## Table of Contents

<b>1 Features</b> .....	1	6.1 Overview.....	20
<b>2 Applications</b> .....	1	6.2 Functional Block Diagram.....	21
<b>3 Description</b> .....	1	6.3 Feature Description.....	21
<b>4 Pin Configuration and Functions</b> .....	3	6.4 Device Functional Modes.....	75
<b>5 Specifications</b> .....	5	6.5 Programming.....	76
5.1 Absolute Maximum Ratings.....	5	<b>7 Register Maps</b> .....	82
5.2 ESD Ratings.....	5	7.1 Device Configuration Registers.....	82
5.3 Recommended Operating Conditions.....	5	7.2 Programmable Coefficient Registers.....	180
5.4 Thermal Information.....	6	<b>8 Application and Implementation</b> .....	212
5.5 Electrical Characteristics.....	6	8.1 Application Information.....	212
5.6 Timing Requirements: I <sup>2</sup> C Interface.....	12	8.2 Typical Application.....	212
5.7 Switching Characteristics: I <sup>2</sup> C Interface.....	13	8.3 Power Supply Recommendations.....	215
5.8 Timing Requirements: SPI Interface.....	13	8.4 Layout.....	216
5.9 Switching Characteristics: SPI Interface.....	13	<b>9 Device and Documentation Support</b> .....	218
5.10 Timing Requirements: TDM, I <sup>2</sup> S or LJ Interface.....	13	9.1 Documentation Support.....	218
5.11 Switching Characteristics: TDM, I <sup>2</sup> S or LJ Interface.....	14	9.2 Receiving Notification of Documentation Updates.....	218
5.12 Timing Requirements: PDM Digital Microphone Interface.....	15	9.3 Support Resources.....	218
5.13 Switching Characteristics: PDM Digital Microphone Interface.....	15	9.4 Trademarks.....	218
5.14 Timing Diagrams.....	15	9.5 Electrostatic Discharge Caution.....	219
5.15 Typical Characteristics.....	17	9.6 Glossary.....	219
<b>6 Detailed Description</b> .....	20	<b>10 Revision History</b> .....	219
		<b>11 Mechanical, Packaging, and Orderable   Information</b> .....	219

## 4 Pin Configuration and Functions

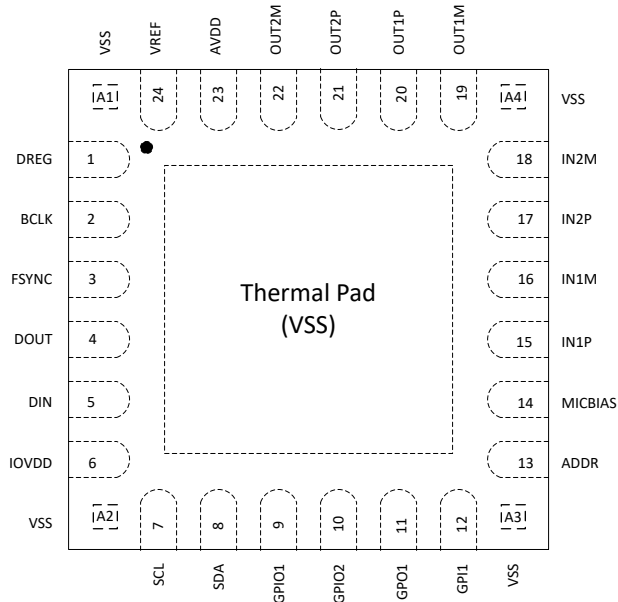

Notes:-  
Not to Scale

**Figure 4-1. 24-Pin QFN Package with Exposed Thermal Pad and Corner Pins, Top View**

**Table 4-1. Pin Functions**

PIN		TYPE <sup>(1)</sup>	DESCRIPTION
NAME	NO.		
VSS	A1	Ground	Ground pin. Short directly to board ground plane.
DREG	1	Digital Supply	Digital on-chip regulator output voltage for digital supply (1.55V, nominal)
BCLK	2	Digital I/O	Audio serial data interface bus bit clock
FSYNC	3	Digital I/O	Audio serial data interface bus frame synchronization signal
DOUT	4	Digital I/O	Audio serial data interface bus output
DIN	5	Digital Input	Audio serial data interface bus input
IOVDD	6	Digital Supply	Digital I/O power supply (1.2V or 1.8V or 3.3V, nominal)
VSS	A2	Ground	Ground pin. Short directly to board ground plane.
SCL	7	Digital Input	Clock for I <sup>2</sup> C control interface
SDA	8	Digital Input	Data for I <sup>2</sup> C control interface
GPIO1	9	Digital I/O	General-purpose digital input/output 1 (multipurpose functions such as daisy-chain input, audio data output, PLL input clock source, interrupt, and so forth)
GPIO2	10	Digital I/O	General-purpose digital input/output 2 (multipurpose functions such as daisy-chain input, audio data output, PLL input clock source, interrupt, and so forth)
GPO1	11	Digital Output	General-purpose digital output 1 (multipurpose functions such as audio data output, interrupt, and so forth)
GPI1	12	Digital Input	General-purpose digital input 1 (multipurpose functions such as daisy-chain input, PLL input clock source, and so forth)

**Table 4-1. Pin Functions (continued)**

PIN		TYPE <sup>(1)</sup>	DESCRIPTION
NAME	NO.		
VSS	A3	Ground	Ground pin. Short directly to board ground plane.
ADDR	13	Analog Input	I <sup>2</sup> C address pin
MICBIAS	14	Analog	Microphone bias output (Programmable output up to 3V)
IN1P	15	Analog Input	Analog input 1P pin (Analog Bypass Path)
IN1M	16	Analog Input	Analog input 1M pin (Analog Bypass Path)
IN2P	17	Analog Input	Analog input 2P pin (Analog Bypass Path)
IN2M	18	Analog Input	Analog input 2M pin (Analog Bypass Path)
VSS	A4	Ground	Ground pin. Short directly to board ground plane.
OUT1M	19	Analog Output	Analog output 1M pin
OUT1P	20	Analog Output	Analog output 1P pin
OUT2P	21	Analog Output	Analog output 2P pin
OUT2M	22	Analog Output	Analog output 2M pin
AVDD	23	Analog Supply	Analog power (1.8V or 3.3V, nominal)
VREF	24	Analog	Analog reference voltage filter output
VSS	Thermal Pad	Ground	Thermal pad shorted to internal device ground. Short directly to board ground plane.

(1) I = Input, O = Output, I/O = Input or Output, G = Ground, P = Power.

## 5 Specifications

### 5.1 Absolute Maximum Ratings

over the operating ambient temperature range (unless otherwise noted)<sup>(1)</sup>

		MIN	MAX	UNIT
Supply voltage	AVDD to VSS (thermal pad)	-0.3	3.9	V
Supply voltage	IOVDD to VSS (thermal pad)	-0.3	3.9	V
Ground voltage differences	VSS to VSS (thermal pad)	-0.3	0.3	V
Analog input voltage	Analog input pins voltage to VSS (thermal pad)	-0.3	5.656	V
Digital input voltage	Digital input pins voltage to VSS (thermal pad)	-0.3	IOVDD + 0.3	V
Temperature	Functional ambient, T <sub>A</sub>	-55	125	°C
	Operating ambient, T <sub>A</sub>	-40	125	
	Junction, T <sub>J</sub>	-40	150	
	Storage, T <sub>stg</sub>	-65	150	

- (1) Operation outside the Absolute Maximum Ratings may cause permanent device damage. Absolute Maximum Ratings do not imply functional operation of the device at these or any other conditions beyond those listed under Recommended Operating Conditions. If used outside the Recommended Operating Conditions but within the Absolute Maximum Ratings, the device may not be fully functional, and this may affect device reliability, functionality, performance, and shorten the device lifetime.

### 5.2 ESD Ratings

			VALUE	UNIT
V <sub>(ESD)</sub>	Electrostatic discharge	Human-body model (HBM), per ANSI/ESDA/JEDEC JS-001 <sup>(1)</sup>	±2000	V
V <sub>(ESD)</sub>	Electrostatic discharge	Charged-device model (CDM), per ANSI/ESDA/JEDEC JS-002 <sup>(2)</sup>	±500	

- (1) JEDEC document JEP155 states that 500V HBM allows safe manufacturing with a standard ESD control process.  
(2) JEDEC document JEP157 states that 250V CDM allows safe manufacturing with a standard ESD control process.

### 5.3 Recommended Operating Conditions

over the operating ambient temperature range (unless otherwise noted)

		MIN	NOM	MAX	UNIT
<b>POWER</b>					
AVDD <sup>(1)</sup>	Analog supply voltage to VSS (thermal pad) - AVDD 3.3V operation	3.0	3.3	3.6	V
	Analog supply voltage to VSS (thermal pad) - AVDD 1.8V operation <sup>(2)</sup>	1.65	1.8	1.95	V
IOVDD	IO supply voltage to VSS (thermal pad) - IOVDD 3.3V operation	3.0	3.3	3.6	V
	IO supply voltage to VSS (thermal pad) - IOVDD 1.8V operation <sup>(3)</sup>	1.65	1.8	1.95	
	IO supply voltage to VSS (thermal pad) - IOVDD 1.2V operation <sup>(3)</sup>	1.08	1.2	1.32	V
<b>INPUTS</b>					
INxx	Analog input pins voltage to VSS (thermal pad) for line-in bypass path	0		AVDD	V
	Digital input pins voltage to VSS (thermal pad)	0		IOVDD	V
ADDR	ADDR pin w.r.t VSS (thermal pad)	0		AVDD	V
<b>TEMPERATURE</b>					
T <sub>A</sub>	Operating ambient temperature	-40		125	°C

over the operating ambient temperature range (unless otherwise noted)

		MIN	NOM	MAX	UNIT
<b>OTHERS</b>					
CCLK	GPIOx or GPIx controller mode clock frequency (CCLK)			36.864 <sup>(4)</sup>	MHz
C <sub>b</sub>	SCL and SDA bus capacitance for I <sup>2</sup> C interface supports standard-mode and fast-mode			400	pF
	SCL and SDA bus capacitance for I <sup>2</sup> C interface supports fast-mode plus			550	
C <sub>L</sub>	Digital output load capacitance		20	50	pF

- (1) VSS and VSS (thermal pad); all ground pins must be tied together and must not differ in voltage by more than 0.2V.
- (2) Set the AVDD\_MODE bit correctly for AVDD 1.8V Operation. Refer Section 8.3 for more details.
- (3) Set the IOVDD\_IO\_MODE bit correctly for IOVDD 1.8V and 1.2V Operation. Refer Section 8.3 for more details.
- (4) CCLK input rise time (V<sub>IL</sub> to V<sub>IH</sub>) and fall time (V<sub>IH</sub> to V<sub>IL</sub>) must be less than 5ns. For better audio noise performance, CCLK input must be used with low jitter.

## 5.4 Thermal Information

THERMAL METRIC <sup>(1)</sup>		TAD5212	UNIT
		RGE (VQFN)	
		24 PINS	
R <sub>θJA</sub>	Junction-to-ambient thermal resistance	38.4	°C/W
R <sub>θJC(top)</sub>	Junction-to-case (top) thermal resistance	26.3	°C/W
R <sub>θJB</sub>	Junction-to-board thermal resistance	15.9	°C/W
ψ <sub>JT</sub>	Junction-to-top characterization parameter	0.5	°C/W
ψ <sub>JB</sub>	Junction-to-board characterization parameter	15.8	°C/W
R <sub>θJC(bot)</sub>	Junction-to-case (bottom) thermal resistance	13.8	°C/W

- (1) For more information about traditional and new thermal metrics, see the [Semiconductor and IC Package Thermal Metrics](#) application report.

## 5.5 Electrical Characteristics

At T<sub>A</sub> = 25°C, AVDD = 3.3V, IOVDD = 3.3V, f<sub>IN</sub> = 1kHz sinusoidal signal, f<sub>S</sub> = 48kHz, 32-bit audio data, BCLK = 256 × f<sub>S</sub>, TDM target mode, PLL on, channel gain = 0dB, linear phase interpolation filters, 1200Ω/600Ω line-out load in differential/single-ended configuration or 32Ω/16Ω receiver/headphone load as applicable, MICBIAS programmed to VREF, and other default configurations; measured filter free with an Audio Precision with a 20Hz to 20kHz un-weighted bandwidth, unless otherwise noted

PARAMETER	TEST CONDITIONS	MIN	NOM	MAX	UNIT
<b>DAC Performance for Line Output/Head Phone Playback</b>					
Full Scale Output Voltage	Differential output between OUTxP and OUTxM, AVDD = 3.3V		2		V <sub>RMS</sub>
	Differential output between OUTxP and OUTxM, AVDD = 1.8V		1		
	Single-ended output, AVDD = 3.3V		1		
	Single-ended output, AVDD = 1.8V		0.5		
	Pseudo-differential output between OUTxP and OUTxM, AVDD = 3.3V		1		
	Pseudo-differential output between OUTxP and OUTxM, AVDD = 1.8V		0.5		

At  $T_A = 25^\circ\text{C}$ ,  $AVDD = 3.3\text{V}$ ,  $IOVDD = 3.3\text{V}$ ,  $f_{IN} = 1\text{kHz}$  sinusoidal signal,  $f_S = 48\text{kHz}$ , 32-bit audio data,  $BCLK = 256 \times f_S$ , TDM target mode, PLL on, channel gain = 0dB, linear phase interpolation filters,  $1200\Omega/600\Omega$  line-out load in differential/single-ended configuration or  $32\Omega/16\Omega$  receiver/headphone load as applicable, MICBIAS programmed to VREF, and other default configurations; measured filter free with an Audio Precision with a 20Hz to 20kHz un-weighted bandwidth, unless otherwise noted

PARAMETER		TEST CONDITIONS	MIN	NOM	MAX	UNIT
SNR	Signal-to-noise ratio, A-weighted <sup>(1) (2)</sup>	Differential output, 0dBFS signal, AVDD=3.3V		120		dB
		Single-ended output, 0dBFS signal, AVDD=3.3V		111		
		Pseudo-differential output, 0dBFS signal, AVDD=3.3V		112		
		Differential output, 0dBFS signal, AVDD=1.8V		115		
		Single-ended output, 0dBFS signal, AVDD=1.8V		105		
		Pseudo-differential output, 0dBFS signal, AVDD=1.8V		106		
		Differential output, 0dBFS signal, AVDD=3.3V, Power Tune Mode <sup>(3)</sup>		117		
		Single-ended output, 0dBFS signal, AVDD=3.3V, Power Tune Mode <sup>(3)</sup>		104		
		Pseudo-differential output, 0dBFS signal, AVDD=3.3V, Power Tune Mode <sup>(3)</sup>		109		
		Differential output, 0dBFS signal, AVDD=1.8V, Power Tune Mode <sup>(3)</sup>		112		
		Single-ended output, 0dBFS signal, AVDD=1.8V, Power Tune Mode <sup>(3)</sup>		100		
		Pseudo-differential output, 0dBFS Signal, AVDD=1.8V, Power Tune Mode <sup>(3)</sup>		104		
SNR	Signal-to-noise ratio, A-weighted <sup>(1) (2)</sup>	Differential-output, Receiver load, 0dBFS signal, AVDD=3.3V		118		dB
		Single-ended output, Headphone load, 0dBFS signal, AVDD=3.3V		110		
		Pseudo-differential output, Receiver load, 0dBFS signal, AVDD=3.3V		112		
		Differential-output, Receiver load, 0dBFS signal, AVDD=1.8V		114		
		Single-ended output, Headphone load, 0dBFS signal, AVDD=1.8V		105		
		Pseudo-differential output, Receiver load, 0dBFS signal, AVDD=1.8V		106		

**TAD5212**

SLASFC1A – DECEMBER 2023 – REVISED JANUARY 2025

At  $T_A = 25^\circ\text{C}$ ,  $AVDD = 3.3\text{V}$ ,  $IOVDD = 3.3\text{V}$ ,  $f_{IN} = 1\text{kHz}$  sinusoidal signal,  $f_S = 48\text{kHz}$ , 32-bit audio data,  $BCLK = 256 \times f_S$ , TDM target mode, PLL on, channel gain = 0dB, linear phase interpolation filters, 1200Ω/600Ω line-out load in differential/single-ended configuration or 32Ω/16Ω receiver/headphone load as applicable, MICBIAS programmed to VREF, and other default configurations; measured filter free with an Audio Precision with a 20Hz to 20kHz un-weighted bandwidth, unless otherwise noted

PARAMETER		TEST CONDITIONS	MIN	NOM	MAX	UNIT
DR	Dynamic range, A-weighted <sup>(2)</sup>	Differential output, -60dBFS signal, AVDD=3.3V		120		dB
		Single-ended output, -60dBFS signal, AVDD=3.3V		111		
		Pseudo-differential output, -60dBFS signal, AVDD=3.3V		112		
		Differential output, -60dBFS signal, AVDD=1.8V		115		
		Single-ended output, -60dBFS Signal, AVDD=1.8V		105		
		Pseudo-differential output, -60dBFS signal, AVDD=1.8V		107		
		Differential output, -60dBFS signal, AVDD=3.3V, Power Tune Mode <sup>(3)</sup>		115		
		Single-ended output, -60dBFS signal, AVDD=3.3V, Power Tune Mode <sup>(3)</sup>		104		
		Pseudo-differential output, -60dBFS signal, AVDD=3.3V, Power Tune Mode <sup>(3)</sup>		109		
		Differential output, -60dBFS signal, AVDD=1.8V, Power Tune Mode <sup>(3)</sup>		111		
		Single-ended output, -60dBFS signal, AVDD=1.8V, Power Tune Mode <sup>(3)</sup>		100		
		Pseudo-differential output, -60dBFS signal, AVDD=1.8V, Power Tune Mode		104		
DR	Dynamic range, A-weighted <sup>(2)</sup>	Differential-output, Receiver load, -60dBFS signal, AVDD=3.3V		118		dB
		Single-ended output, Headphone load, -60dBFS signal, AVDD=3.3V		111		
		Pseudo-differential output, Receiver load, -60dBFS signal, AVDD=3.3V		112		
		Differential-output, Receiver load, -60dBFS signal, AVDD=1.8V		114		
		Single-ended output, Headphone load, -60dBFS signal, AVDD=1.8V		105		
		Pseudo-differential output, Receiver load, -60dBFS signal, AVDD=1.8V		107		
THD+N	Total harmonic distortion <sup>(2)</sup>	Differential output, -1dBFS signal, AVDD= 3.3V		-104		dB
		Differential output, -1dBFS signal, AVDD= 1.8V		-95		
		Single-ended output, 0dBFS signal, Headphone load, AVDD=3.3V		-94		
	Headphone load range	Single-ended	4	16	600	Ω
	Line-out load range	Single-ended	600			Ω
	Headphone/Line-out Cap load	Single-ended	0		2	nF
<b>Analog Bypass to Line Out/Head Phone Amplifier</b>						
	Input impedance	Input pins INxP or INxM, 4.4kΩ Input Impedance Mode		4.4		kΩ
		Input pins INxP or INxM, 20kΩ Input Impedance Mode		20		
	Single Ended Full Scale Output	AVDD = 3.3V		1		Vrms



At  $T_A = 25^\circ\text{C}$ ,  $AVDD = 3.3\text{V}$ ,  $IOVDD = 3.3\text{V}$ ,  $f_{IN} = 1\text{kHz}$  sinusoidal signal,  $f_S = 48\text{kHz}$ , 32-bit audio data,  $BCLK = 256 \times f_S$ , TDM target mode, PLL on, channel gain = 0dB, linear phase interpolation filters, 1200Ω/600Ω line-out load in differential/single-ended configuration or 32Ω/16Ω receiver/headphone load as applicable, MICBIAS programmed to VREF, and other default configurations; measured filter free with an Audio Precision with a 20Hz to 20kHz un-weighted bandwidth, unless otherwise noted

PARAMETER		TEST CONDITIONS	MIN	NOM	MAX	UNIT
	Differential Full Scale Output	AVDD = 3.3V		2		V <sub>rms</sub>
		AVDD = 1.8V		1		V <sub>rms</sub>
	Gain Error	AC-Coupled Input, -6dBFS input		±0.1		dB
	Noise, A-Weighted	Idle Channel, AC Coupled Input Shorted to Ground, Differential output		3.5		μV <sub>RMS</sub>
	Noise, A-Weighted	Idle Channel, AC Coupled Input Shorted to Ground, Single-ended output		19.7		μV <sub>RMS</sub>
SNR	Signal-to-noise ratio, A-weighted <sup>(1)</sup> <sup>(2)</sup>	Idle Channel, AC-Coupled Input Shorted to Ground, Differential output		115		dB
SNR	Signal-to-noise ratio, A-weighted <sup>(1)</sup> <sup>(2)</sup>	Idle Channel, AC-Coupled Input Shorted to Ground, Single-ended output		95		dB
THD+N	Total harmonic distortion <sup>(2)</sup>	IN1 differential AC-coupled Input and -1dBFS AC signal input, 0dB channel gain		-102		dB

**DAC Channel OTHER PARAMETERS**

	Output Offset	0 Input, Differential line-output		±0.5		mV
	Output Common Mode	Common Mode Level for OUTxP and OUTxM, AVDD = 1.8V (Register Configurable)		0.9		V
		Common Mode Level for OUTxP and OUTxM AVDD = 3.3V (Register Configurable)		1.65		
	Common Mode Error	DC Error in Common Mode Voltage		±20		mV
	Output Signal Bandwidth	Up to 192KSPS FS Rate		0.46		FS
		>192KSPS		90		kHz
	Input data sample rate	Programmable	4		768	kHz
	Input data sample word length	Programmable	16		32	Bits
	Digital high-pass filter cutoff frequency	First-order IIR filter with programmable coefficients, -3dB point (default setting)		1		Hz
	Interchannel isolation	Differential output, -1dBFS input signal on nonmeasurement channel		-134		dB
	Gain Error	Differential output, -6dBFS Input signal		±0.1		dB
	Interchannel gain mismatch	Differential output, -6dBFS Input signal		±0.1		dB
	Interchannel phase mismatch	Differential output, -6dBFS Input signal		±0.01		Degrees
PSRR	Power-supply rejection ratio	100mV <sub>pp</sub> , 1kHz sinusoidal signal on AVDD, differential output, 0dB channel gain		120		dB
	Mute Attenuation			-130		dB
P <sub>out</sub>	Output Power Delivery	Single-ended/Pseudo-differential headphone R <sub>L</sub> =16Ω, THD+N<0.1%		62.5		mW

**MICROPHONE BIAS**

	MICBIAS noise	Bandwidth = 20Hz to 20kHz, A-weighted, 1μF capacitor between MICBIAS and VSS (thermal pad)		2		μV <sub>RMS</sub>
	MICBIAS voltage	Bypass to AVDD		AVDD		V
		AVDD = 1.8V		1.375		V
		AVDD = 3.3V		2.75		V

**TAD5212**

SLASFC1A – DECEMBER 2023 – REVISED JANUARY 2025

At  $T_A = 25^\circ\text{C}$ ,  $AVDD = 3.3\text{V}$ ,  $IOVDD = 3.3\text{V}$ ,  $f_{IN} = 1\text{kHz}$  sinusoidal signal,  $f_S = 48\text{kHz}$ , 32-bit audio data,  $BCLK = 256 \times f_S$ , TDM target mode, PLL on, channel gain = 0dB, linear phase interpolation filters,  $1200\Omega/600\Omega$  line-out load in differential/single-ended configuration or  $32\Omega/16\Omega$  receiver/headphone load as applicable, MICBIAS programmed to VREF, and other default configurations; measured filter free with an Audio Precision with a 20Hz to 20kHz un-weighted bandwidth, unless otherwise noted

PARAMETER		TEST CONDITIONS	MIN	NOM	MAX	UNIT
<b>DIGITAL I/O</b>						
$V_{IL}$	Low-level digital input logic voltage threshold	All digital pins except SDA and SCL, IOVDD 1.8V or 1.2V operation	-0.3		$0.35 \times \text{IOVDD}$	V
		All digital pins except SDA and SCL, IOVDD 3.3V operation	-0.3		0.8	
$V_{IH}$	High-level digital input logic voltage threshold	All digital pins except SDA and SCL, IOVDD 1.8V or 1.2V operation	$0.65 \times \text{IOVDD}$		$\text{IOVDD} + 0.3$	V
		All digital pins except SDA and SCL, IOVDD 3.3V operation	2		$\text{IOVDD} + 0.3$	
$V_{OL}$	Low-level digital output voltage	All digital pins except SDA and SCL, $I_{OL} = -2\text{mA}$ , IOVDD 1.8V or 1.2V operation			0.45	V
		All digital pins except SDA and SCL, $I_{OL} = -2\text{mA}$ , IOVDD 3.3V operation			0.4	
$V_{OH}$	High-level digital output voltage	All digital pins except SDA and SCL, $I_{OH} = 2\text{mA}$ , IOVDD 1.8V or 1.2V operation	$\text{IOVDD} - 0.45$			V
		All digital pins except SDA and SCL, $I_{OH} = 2\text{mA}$ , IOVDD 3.3V operation	2.4			
$V_{IL(I2C)}$	Low-level digital input logic voltage threshold	SDA and SCL	-0.5		$0.3 \times \text{IOVDD}$	V
$V_{IH(I2C)}$	High-level digital input logic voltage threshold	SDA and SCL	$0.7 \times \text{IOVDD}$		$\text{IOVDD} + 0.5$	V
$V_{OL1(I2C)}$	Low-level digital output voltage	SDA, $I_{OL(I2C)} = -3\text{mA}$ , IOVDD 3.3V operation			0.4	V
$V_{OL2(I2C)}$	Low-level digital output voltage	SDA, $I_{OL(I2C)} = -2\text{mA}$ , IOVDD 1.8V or 1.2V operation			$0.2 \times \text{IOVDD}$	V
$I_{OL(I2C)}$	Low-level digital output current	SDA, $V_{OL(I2C)} = 0.4\text{V}$ , standard-mode or fast-mode	3			mA
		SDA, $V_{OL(I2C)} = 0.4\text{V}$ , fast-mode plus	20			
$I_{IL}$	Input logic-low leakage for digital inputs	All digital pins, input = 0V	-5	0.1	5	$\mu\text{A}$
$I_{IH}$	Input logic-high leakage for digital inputs	All digital pins, input = IOVDD	-5	0.1	5	$\mu\text{A}$
$C_{IN}$	Input capacitance for digital inputs	All digital pins		5		pF
$R_{PD}$	Pulldown resistance for digital I/O pins when asserted on			20		k $\Omega$
<b>TYPICAL SUPPLY CURRENT CONSUMPTION</b>						
$I_{AVDD}$	Current consumption in sleep mode (software shutdown mode)	All device external clocks stopped		9		$\mu\text{A}$
$I_{IOVDD}$				1		
$I_{AVDD}$	Current consumption with MICBIAS ON, 5mA load, no recording/playback	$f_S = 48\text{kHz}$ , $BCLK = 256 \times f_S$		1.5		mA
$I_{IOVDD}$				0.02		
$I_{AVDD}$	Current consumption with DAC to Headphone 2-channel operation, MICBIAS off, PLL on	$f_S = 16\text{kHz}$ , $BCLK = 512 \times f_S$		18.8		mA
$I_{IOVDD}$				0.02		

At  $T_A = 25^\circ\text{C}$ ,  $AVDD = 3.3\text{V}$ ,  $IOVDD = 3.3\text{V}$ ,  $f_{IN} = 1\text{kHz}$  sinusoidal signal,  $f_S = 48\text{kHz}$ , 32-bit audio data,  $BCLK = 256 \times f_S$ , TDM target mode, PLL on, channel gain = 0dB, linear phase interpolation filters,  $1200\Omega/600\Omega$  line-out load in differential/single-ended configuration or  $32\Omega/16\Omega$  receiver/headphone load as applicable, MICBIAS programmed to VREF, and other default configurations; measured filter free with an Audio Precision with a 20Hz to 20kHz un-weighted bandwidth, unless otherwise noted

PARAMETER		TEST CONDITIONS	MIN	NOM	MAX	UNIT
$I_{AVDD}$	Current consumption with DAC to Headphone 2-channel operation, MICBIAS off, PLL off	$f_S = 48\text{kHz}$ , $BCLK = 512 \times f_S$	16			mA
$I_{IOVDD}$			0.04			
$I_{AVDD}$	Power Tune Mode <sup>(3)</sup> : Current consumption with DAC to Lineout 2-channel single-ended operation, MICBIAS off, PLL off, $AVDD=1.8\text{V}$	$f_S = 48\text{kHz}$ , $BCLK = 128 \times f_S$	5.6			mA
$I_{AVDD}$	Power Tune Mode <sup>(3)</sup> : Current consumption with DAC to Lineout 2-channel operation, MICBIAS off, PLL on	$f_S = 48\text{kHz}$ , $BCLK = 512 \times f_S$	9.2			mA
$I_{IOVDD}$			0.04			

- (1) Ratio of output level with 1kHz full-scale sine-wave input, to the output level with no generator input signal and input shorted to ground, measured with an A-weighted filter over a 20Hz to 20kHz bandwidth using an audio analyzer.
- (2) All performance measurements done with 20kHz low-pass filter and, where noted, an A-weighted filter. Failure to use such a filter can result in higher THD+N and lower SNR and dynamic range readings than shown in the Electrical Characteristics. The low-pass filter removes out-of-band noise, which, although not audible, can affect dynamic specification values.
- (3)  $PWR\_TUNE\_CFG0 = 0xD4$ ,  $PWR\_TUNE\_CFG1 = 0x96$  and  $PLL\_DIS = 1'b1$  for Power Tune Mode

## 5.6 Timing Requirements: I<sup>2</sup>C Interface

At  $T_A = 25^\circ\text{C}$ , IOVDD = 3.3V or 1.8V or 1.2V (unless otherwise noted); see Figure 5-1 for timing diagram. Set the IOVDD\_IO\_MODE bit correctly for IOVDD 1.8V and 1.2V Operation. Refer Section 8.3 for more details.

		MIN	NOM	MAX	UNIT
<b>STANDARD-MODE</b>					
f <sub>SCL</sub>	SCL clock frequency	0		100	kHz
t <sub>HD,STA</sub>	Hold time (repeated) START condition. After this period, the first clock pulse is generated.	4			μs
t <sub>LOW</sub>	Low period of the SCL clock	4.7			μs
t <sub>HIGH</sub>	High period of the SCL clock	4			μs
t <sub>SU,STA</sub>	Setup time for a repeated START condition	4.7			μs
t <sub>HD,DAT</sub>	Data hold time	0		3.45	μs
t <sub>SU,DAT</sub>	Data setup time	250			ns
t <sub>r</sub>	SDA and SCL rise time			1000	ns
t <sub>f</sub>	SDA and SCL fall time			300	ns
t <sub>SU,STO</sub>	Setup time for STOP condition	4			μs
t <sub>BUF</sub>	Bus free time between a STOP and START condition	4.7			μs
<b>FAST-MODE</b>					
f <sub>SCL</sub>	SCL clock frequency	0		400	kHz
t <sub>HD,STA</sub>	Hold time (repeated) START condition. After this period, the first clock pulse is generated.	0.6			μs
t <sub>LOW</sub>	Low period of the SCL clock	1.3			μs
t <sub>HIGH</sub>	High period of the SCL clock	0.6			μs
t <sub>SU,STA</sub>	Setup time for a repeated START condition	0.6			μs
t <sub>HD,DAT</sub>	Data hold time	0		0.9	μs
t <sub>SU,DAT</sub>	Data setup time	100			ns
t <sub>r</sub>	SDA and SCL rise time	20		300	ns
t <sub>f</sub>	SDA and SCL fall time		$20 \times$ (IOVDD / 5.5 V)	300	ns
t <sub>SU,STO</sub>	Setup time for STOP condition	0.6			μs
t <sub>BUF</sub>	Bus free time between a STOP and START condition	1.3			μs
<b>FAST-MODE PLUS</b>					
f <sub>SCL</sub>	SCL clock frequency	0		1000	kHz
t <sub>HD,STA</sub>	Hold time (repeated) START condition. After this period, the first clock pulse is generated.	0.26			μs
t <sub>LOW</sub>	Low period of the SCL clock	0.5			μs
t <sub>HIGH</sub>	High period of the SCL clock	0.26			μs
t <sub>SU,STA</sub>	Setup time for a repeated START condition	0.26			μs
t <sub>HD,DAT</sub>	Data hold time	0			μs
t <sub>SU,DAT</sub>	Data setup time	50			ns
t <sub>r</sub>	SDA and SCL Rise Time			120	ns
t <sub>f</sub>	SDA and SCL Fall Time		$20 \times$ (IOVDD / 5.5 V)	120	ns
t <sub>SU,STO</sub>	Setup time for STOP condition	0.26			μs
t <sub>BUF</sub>	Bus free time between a STOP and START condition	0.5			μs

### 5.7 Switching Characteristics: I<sup>2</sup>C Interface

At T<sub>A</sub> = 25°C, IOVDD = 3.3V or 1.8V or 1.2V (unless otherwise noted); see Figure 5-1 for timing diagram. Set the IOVDD\_IO\_MODE bit correctly for IOVDD 1.8V and 1.2V Operation. Refer Section 8.3 for more details.

PARAMETER		TEST CONDITIONS	MIN	TYP	MAX	UNIT
t <sub>d</sub> (SDA)	SCL to SDA delay	Standard-mode	200		1250	ns
		Fast-mode	200		850	ns
		Fast-mode plus			400	ns

### 5.8 Timing Requirements: SPI Interface

At T<sub>A</sub> = 25°C, IOVDD = 3.3V or 1.8V or 1.2V and 20pF load on all outputs (unless otherwise noted); see Figure 5-2 for timing diagram. Set the IOVDD\_IO\_MODE bit correctly for IOVDD 1.8V and 1.2V Operation. Refer Section 8.3 for more details.

PARAMETER		TEST CONDITIONS	MIN	NOM	MAX	UNIT
t <sub>(SCLK)</sub>	SCLK period		40			ns
t <sub>H</sub> (SCLK)	SCLK high pulse duration		18			ns
t <sub>L</sub> (SCLK)	SCLK low pulse duration		18			ns
t <sub>LEAD</sub>	Enable lead time		16			ns
t <sub>TRAIL</sub>	Enable trail time		16			ns
t <sub>DSEQ</sub>	Sequential transfer delay		20			ns
t <sub>SU</sub> (PICO)	PICO data setup time		8			ns
t <sub>HLD</sub> (PICO)	PICO data hold time		8			ns
t <sub>r</sub> (SCLK)	SCLK rise time	10% - 90% rise time			6	ns
t <sub>f</sub> (SCLK)	SCLK fall time	90% - 10% fall time			6	ns

### 5.9 Switching Characteristics: SPI Interface

At T<sub>A</sub> = 25°C, IOVDD = 3.3V or 1.8V or 1.2V and 20pF load on all outputs (unless otherwise noted); see Figure 5-2 for timing diagram. Set the IOVDD\_IO\_MODE bit correctly for IOVDD 1.8V and 1.2V Operation. Refer Section 8.3 for more details.

PARAMETER		TEST CONDITIONS	MIN	TYP	MAX	UNIT
t <sub>a</sub> (POCI)	POCI access time	IOVDD = 1.2V			18	ns
		IOVDD = 1.8V			18	ns
		IOVDD = 3.3V			14	ns
t <sub>d</sub> (POCI)	SCLK to POCI delay	50% of SCLK to 50% of POCI, IOVDD = 1.2V			19	ns
		50% of SCLK to 50% of POCI, IOVDD = 1.8V			19	ns
		50% of SCLK to 50% of POCI, IOVDD = 3.3V			15	ns
t <sub>dis</sub> (POCI)	POCI disable time	IOVDD = 1.2V			18	ns
		IOVDD = 1.8V			18	ns
		IOVDD = 3.3V			14	ns

### 5.10 Timing Requirements: TDM, I<sup>2</sup>S or LJ Interface

At T<sub>A</sub> = 25°C, IOVDD = 3.3V or 1.8V or 1.2V and 20pF load on all outputs (unless otherwise noted); see Figure 5-3 for timing diagram. Set the IOVDD\_IO\_MODE bit correctly for IOVDD 1.8V and 1.2V Operation. Refer Section 8.3 for more details.

PARAMETER		TEST CONDITIONS	MIN	NOM	MAX	UNIT
t <sub>(BCLK)</sub>	BCLK period		40			ns
t <sub>H</sub> (BCLK)	BCLK high pulse duration <sup>(1)</sup>		18			ns
t <sub>L</sub> (BCLK)	BCLK low pulse duration <sup>(1)</sup>		18			ns
t <sub>SU</sub> (FSYNC)	FSYNC setup time		8			ns
t <sub>HLD</sub> (FSYNC)	FSYNC hold time		8			ns
t <sub>SU</sub> (DIN)	DIN setup time		8			ns

At  $T_A = 25^\circ\text{C}$ , IOVDD = 3.3V or 1.8V or 1.2V and 20pF load on all outputs (unless otherwise noted); see Figure 5-3 for timing diagram. Set the IOVDD\_IO\_MODE bit correctly for IOVDD 1.8V and 1.2V Operation. Refer Section 8.3 for more details.

		MIN	NOM	MAX	UNIT
$t_{\text{HLD(DIN)}}$	DIN hold time	8			ns
$t_{\text{r(BCLK)}}$	BCLK rise time	10% - 90% rise time			10 ns
$t_{\text{f(BCLK)}}$	BCLK fall time	90% - 10% fall time			10 ns

- (1) To meet the timing specifications, the BCLK minimum high or low pulse duration must be higher than 25ns, if the DOUT data line is latched on the opposite BCLK edge polarity from the one used by the device to transmit the DOUT data.

### 5.11 Switching Characteristics: TDM, I<sup>2</sup>S or LJ Interface

At  $T_A = 25^\circ\text{C}$ , IOVDD = 3.3V or 1.8V or 1.2V and 20pF load on all outputs (unless otherwise noted); see Figure 5-3 for timing diagram. Set the IOVDD\_IO\_MODE bit correctly for IOVDD 1.8V and 1.2V Operation. Refer Section 8.3 for more details.

PARAMETER		TEST CONDITIONS	MIN	TYP	MAX	UNIT
$t_{\text{d(DOUT-BCLK)}}$	BCLK to DOUT delay	50% of BCLK to 50% of DOUT, IOVDD = 1.2V	18			ns
		50% of BCLK to 50% of DOUT, IOVDD = 1.8V	18			
		50% of BCLK to 50% of DOUT, IOVDD = 3.3V	14			
$t_{\text{d(DOUT-FSYNC)}}$	FSYNC to DOUT delay in TDM or LJ mode (for MSB data with TX_OFFSET = 0)	50% of FSYNC to 50% of DOUT, IOVDD = 1.2V	18			ns
		50% of FSYNC to 50% of DOUT, IOVDD = 1.8V	18			
		50% of FSYNC to 50% of DOUT, IOVDD = 3.3V	14			
$f_{\text{(BCLK)}}$	BCLK output clock frequency; controller mode <sup>(1)</sup>			24.576	MHz	
$t_{\text{H(BCLK)}}$	BCLK high pulse duration; controller mode	IOVDD = 1.2V	14			ns
		IOVDD = 1.8V	14			
		IOVDD = 3.3V	14			
$t_{\text{L(BCLK)}}$	BCLK low pulse duration; controller mode	IOVDD = 1.2V	14			ns
		IOVDD = 1.8V	14			
		IOVDD = 3.3V	14			
$t_{\text{d(FSYNC)}}$	BCLK to FSYNC delay; controller mode	50% of BCLK to 50% of FSYNC, IOVDD = 1.2V	18			ns
		50% of BCLK to 50% of FSYNC, IOVDD = 1.8V	18			
		50% of BCLK to 50% of FSYNC, IOVDD = 3.3V	14			
$t_{\text{r(BCLK)}}$	BCLK rise time; controller mode	10% - 90% rise time, IOVDD = 1.2V	10			ns
		10% - 90% rise time, IOVDD = 1.8V	10			
		10% - 90% rise time, IOVDD = 3.3V	10			
$t_{\text{f(BCLK)}}$	BCLK fall time; controller mode	90% - 10% fall time, IOVDD = 1.2V	8			ns
		90% - 10% fall time, IOVDD = 1.8V	8			
		90% - 10% fall time, IOVDD = 3.3V	8			

- (1) To meet the timing specifications, the BCLK output clock frequency must be lower than 18.5 MHz, if the DOUT data line is latched on the opposite BCLK edge polarity from the one used by the device to transmit DOUT data.

### 5.12 Timing Requirements: PDM Digital Microphone Interface

At TA = 25°C, IOVDD = 3.3V or 1.8V or 1.2V and 20pF load on all outputs (unless otherwise noted); see Figure 5-4 for timing diagram. Set the IOVDD\_IO\_MODE bit correctly for IOVDD 1.8V and 1.2V Operation. Refer Section 8.3 for more details.

		MIN	NOM	MAX	UNIT
$t_{SU}(PDM\text{DIN}x)$	PDM $\text{DIN}x$ setup time	30			ns
$t_{HLD}(PDM\text{DIN}x)$	PDM $\text{DIN}x$ hold time	0			ns

### 5.13 Switching Characteristics: PDM Digital Microphone Interface

At TA = 25°C, IOVDD = 3.3V or 1.8V or 1.2V and 20pF load on all outputs (unless otherwise noted); see Figure 5-4 for timing diagram. Set the IOVDD\_IO\_MODE bit correctly for IOVDD 1.8V and 1.2V Operation. Refer Section 8.3 for more details

PARAMETER	TEST CONDITIONS	MIN	TYP	MAX	UNIT
$f_{(PDM\text{CLK})}$	PDMCLK clock frequency	0.768		6.144	MHz
$t_{H}(PDM\text{CLK})$	PDMCLK high pulse duration	72			ns
$t_{L}(PDM\text{CLK})$	PDMCLK low pulse duration	72			ns
$t_{r}(PDM\text{CLK})$	PDMCLK rise time	10% - 90% rise time		18	ns
$t_{f}(PDM\text{CLK})$	PDMCLK fall time	90% - 10% fall time		18	ns

### 5.14 Timing Diagrams

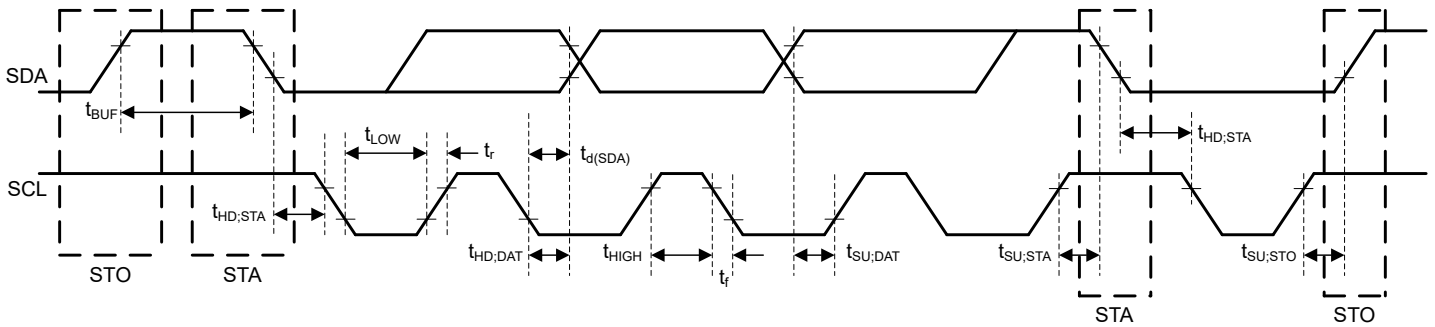

Figure 5-1. I<sup>2</sup>C Interface Timing Diagram

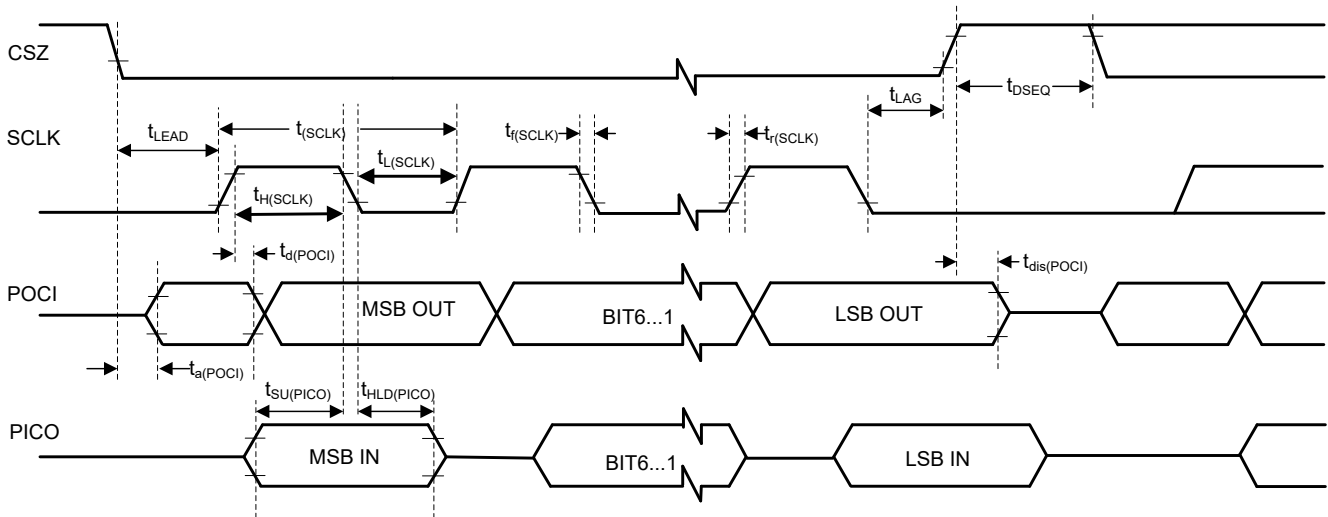
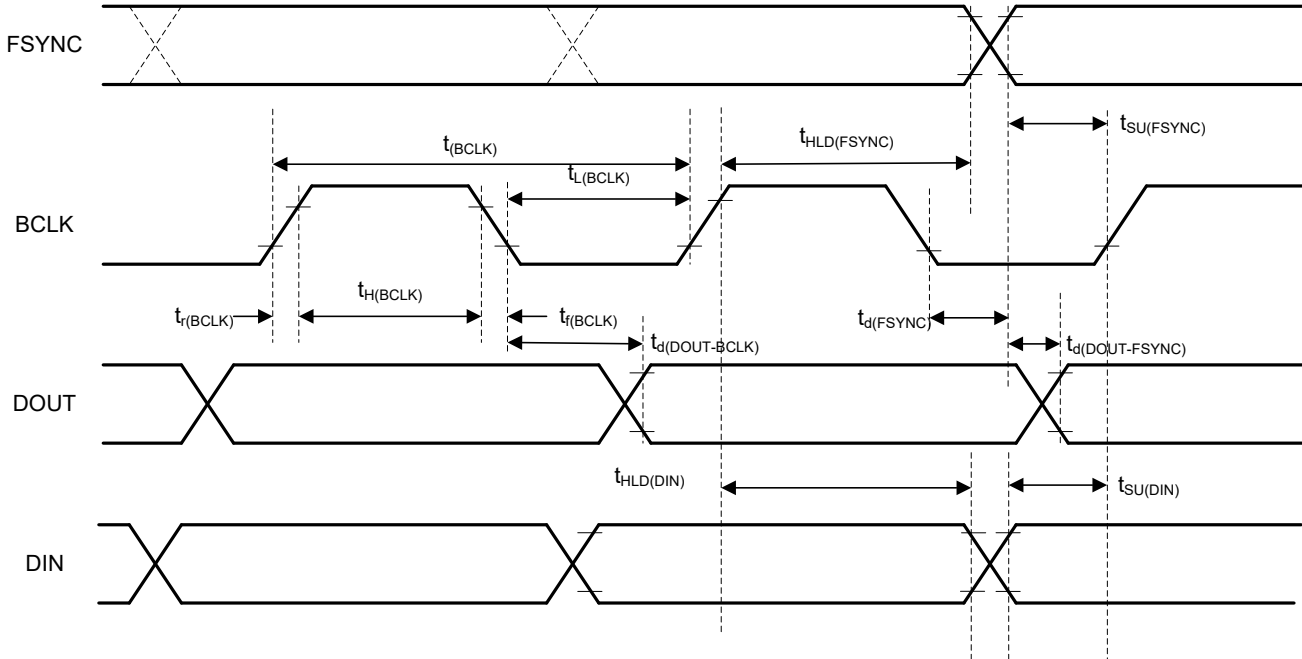
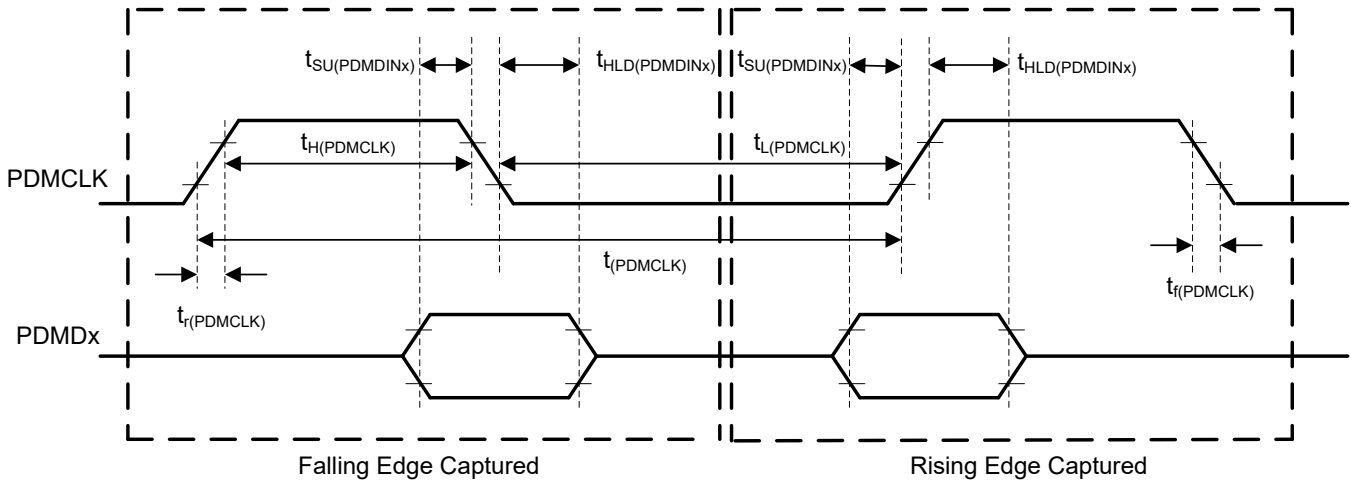

Figure 5-2. SPI Interface Timing Diagram



**Figure 5-3. TDM (With BCLK\_POL = 1), I²S, and LJ Interface Timing Diagram**

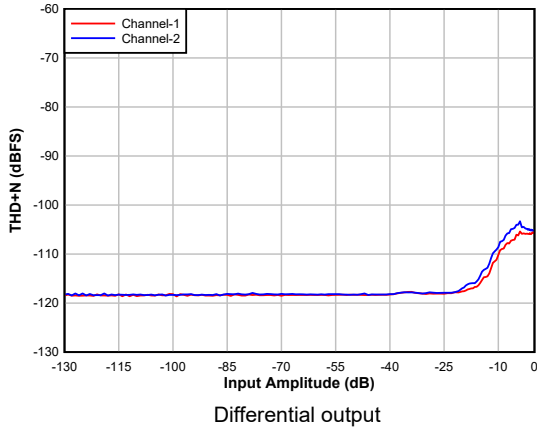

**Figure 5-4. PDM Digital Microphone Interface Timing Diagram**



### 5.15 Typical Characteristics

At  $T_A = 25^\circ\text{C}$ ,  $AV_{DD} = 3.3\text{ V}$ ,  $IOV_{DD} = 3.3\text{ V}$ ,  $f_{IN} = 1\text{ kHz}$  sinusoidal signal,  $f_S = 48\text{ kHz}$ , 32-bit audio data,  $BCLK = 256 \times f_S$ , TDM target mode, PLL on, channel gain = 0dB, linear phase interpolation filters, 1200Ω/600Ω line-out load in differential/single-ended configuration or 32Ω/16Ω receiver/headphone load as applicable, and other default configurations; measured filter free with an Audio Precision with a 20Hz to 20kHz un-weighted bandwidth, unless otherwise noted



**Figure 5-5. DAC THD+N Level vs Input**

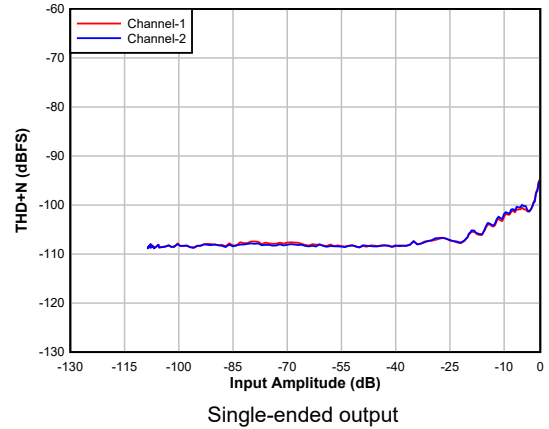

**Figure 5-6. DAC THD+N Level vs Input**

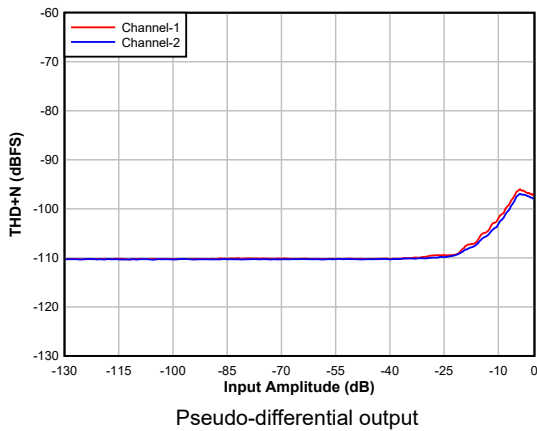

**Figure 5-7. DAC THD+N Level vs Input**

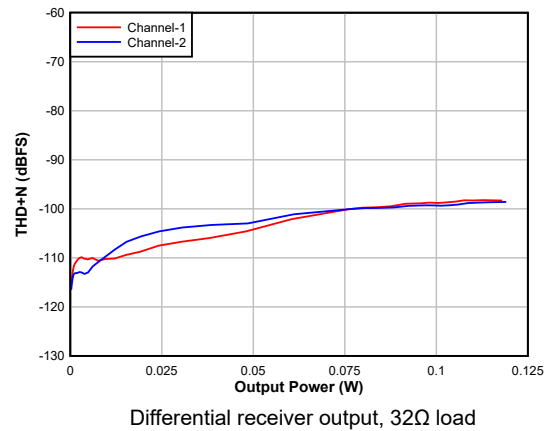

**Figure 5-8. DAC THD+N Level vs output power**

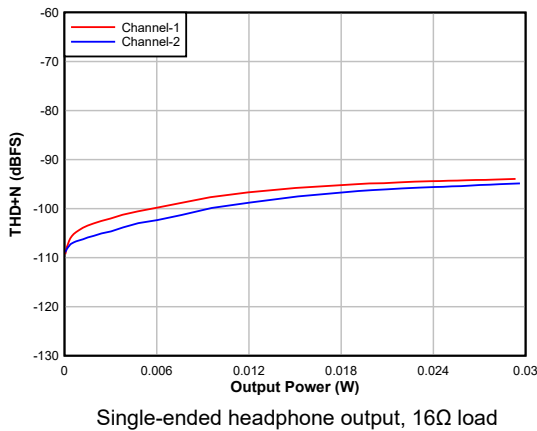

**Figure 5-9. DAC THD+N Level vs output power**

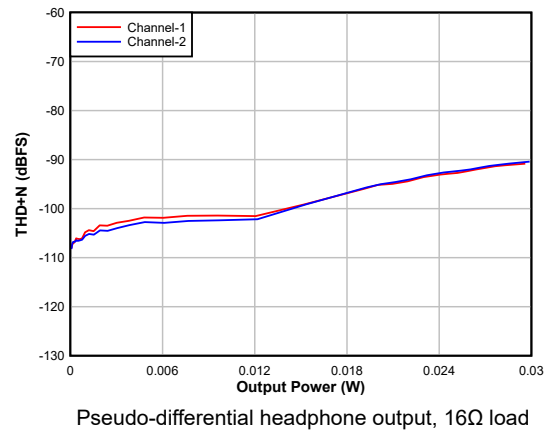

**Figure 5-10. DAC THD+N Level vs output power**

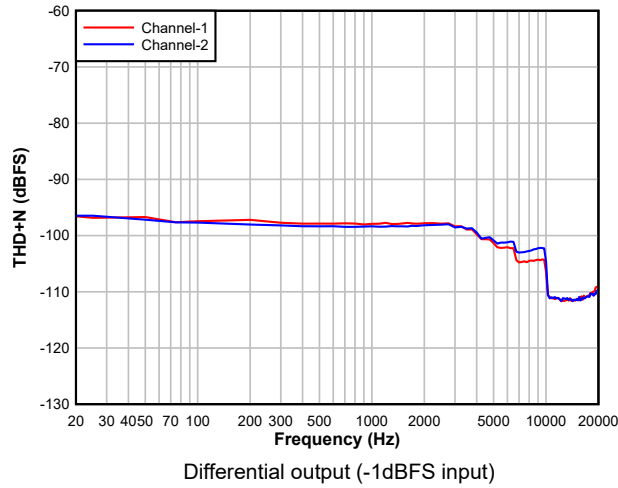

**Figure 5-11. DAC THD+N Level vs Frequency**

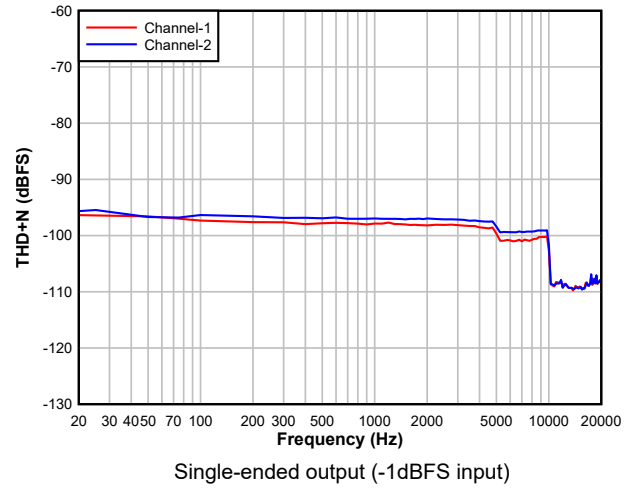

**Figure 5-12. DAC THD+N Level vs Frequency**

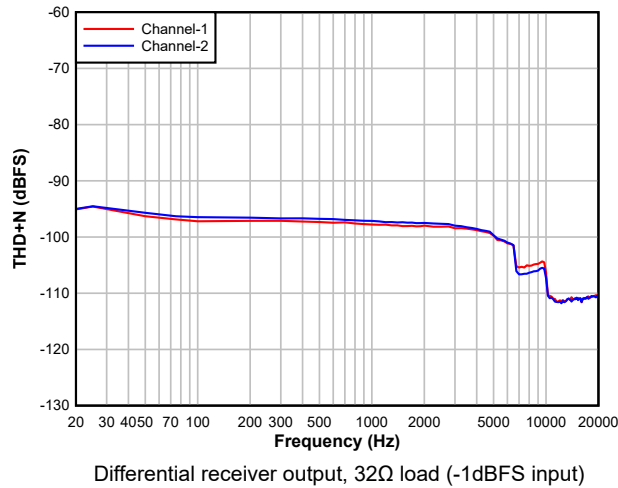

**Figure 5-13. DAC THD+N Level vs Frequency**

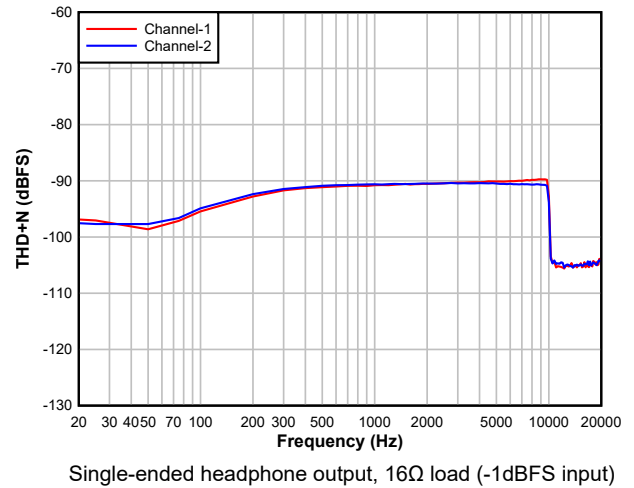

**Figure 5-14. DAC THD+N Level vs Frequency**

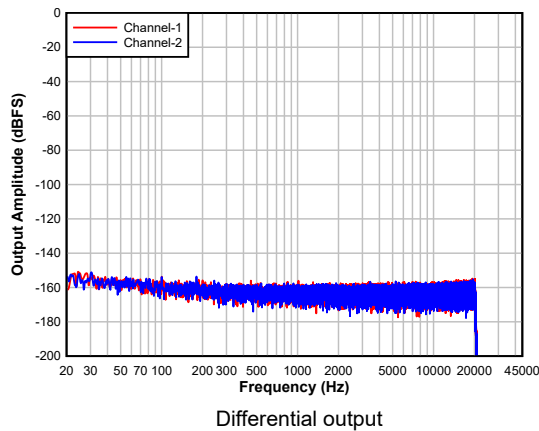

**Figure 5-15. DAC FFT with Idle Channel Input**

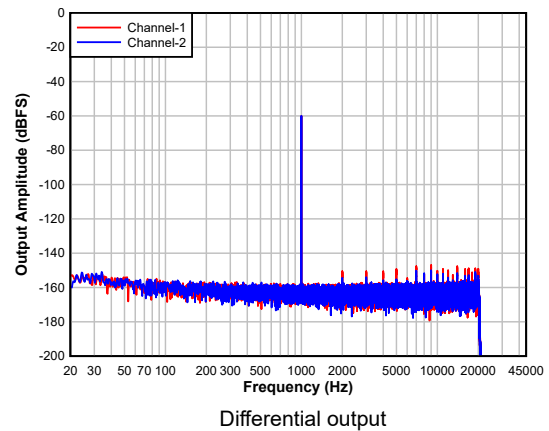

**Figure 5-16. DAC FFT with -60dBFS Input**

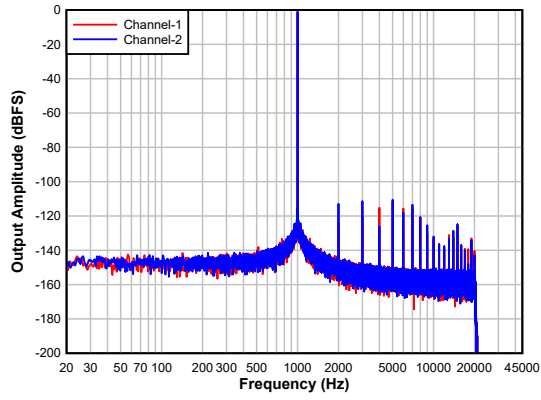

**Figure 5-17. DAC FFT with -1dBFS Input**

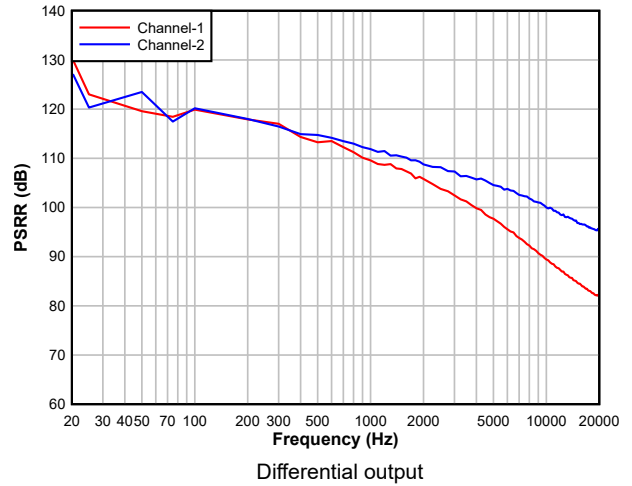

**Figure 5-18. DAC PSRR vs Frequency**

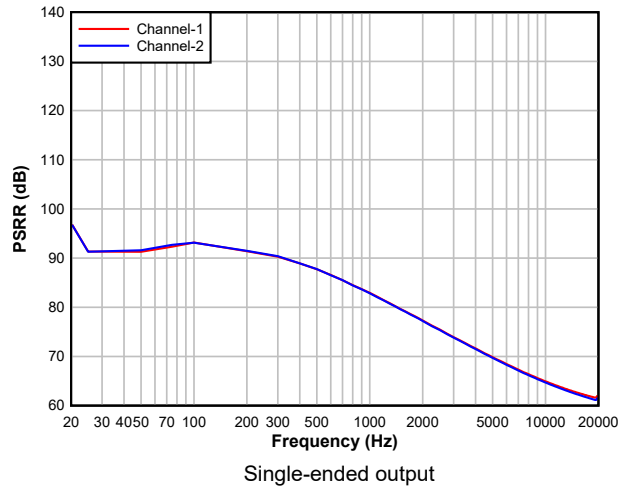

**Figure 5-19. DAC PSRR vs Frequency**

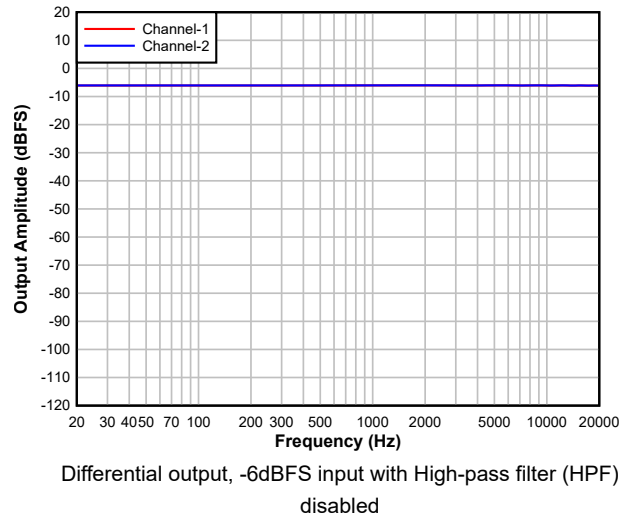

Differential output, -6dBFS input with High-pass filter (HPF) disabled

**Figure 5-20. DAC Frequency Response**

## 6 Detailed Description

### 6.1 Overview

The TAD5212 is from a scalable family of audio converter devices. As part of the extended family of devices, the TAD5212 consists of a high-performance, low-power, flexible stereo differential and quad single-ended audio digital-to-analog converter (DAC) with extensive feature integration. This device is intended for broad market applications such as home theater and entertainment speakers, AV receivers, portable audio devices, professional audio, and multimedia applications. This device integrates a host of features that reduce cost, board space, and power consumption in space-constrained system designs. Package, performance, and device-compatible configuration registers make this device well suited for scalable system designs.

The TAD5212 consists of the following blocks:

- 4-channel, multibit, high-performance delta-sigma ( $\Delta\Sigma$ ) DACs
- Configurable single-ended, differential or pseudo-differential audio outputs
- Advanced thermal foldback and protection
- Advanced battery guard and distortion limiter
- Low-noise programmable microphone bias output
- Up to 4 pulse density modulation (PDM) digital microphone interface with a high-performance decimation filter
- Programmable decimation and interpolation filters with linear-phase, low-latency and ultra low-latency response options
- Programmable channel gain, volume control, and biquad filters for each record and playback channel
- Programmable phase and gain calibration with fine resolution for each record channel
- Programmable high-pass filter (HPF) and digital channel mixer for record and playback channels
- Automatic gain controller (AGC) for PDM record channels and Dynamic range controller (DRC) for DAC playback channels
- Dual I<sup>2</sup>S or TDM interface with independent sample rate (synchronous)
- Synchronous sample rate converter (SRC)
- Integrated low-jitter, phase-locked loop (PLL) supporting a wide range of system clocks
- Integrated digital and analog voltage regulators to support single-supply operation

Communication to the TAD5212 for configuring the control registers is supported using an I<sup>2</sup>C and SPI interface. The device supports a highly flexible audio serial interface [time-division multiplexing (TDM), I<sup>2</sup>S, or left-justified (LJ)] to transmit audio data seamlessly in the system across devices.

The TAD5212 can support multiple devices by sharing the common TDM bus across devices. Moreover, the device includes a daisy-chain feature as well. These features relax the shared TDM bus timing requirements and board design complexities when operating multiple devices for applications requiring high audio data bandwidth.

[Table 6-1](#) lists the reference abbreviations used throughout this document to registers that control the device.

**Table 6-1. Abbreviations for Register References**

REFERENCE	ABBREVIATION	DESCRIPTION	EXAMPLE
Page y, register z, bit k	Py_Rz_D[k]	Single data bit. The value of a single bit in a register.	Page 1, register 36, bit 0 = P1_R36_D[0]
Page y, register z, bits k-m	Py_Rz_D[k:m]	Range of data bits. A range of data bits (inclusive).	Page 1, register 36, bits 3-0 = P1_R36_D[3:0]
Page y, register z	Py_Rz	One entire register. All eight bits in the register as a unit.	Page 1, register 36 = P1_R36
Page y, registers z-n	Py_Rz-Rn	Range of registers. A range of registers in the same page.	Page 1, registers 36, 37, 38 = P1_R36-R38

## 6.2 Functional Block Diagram

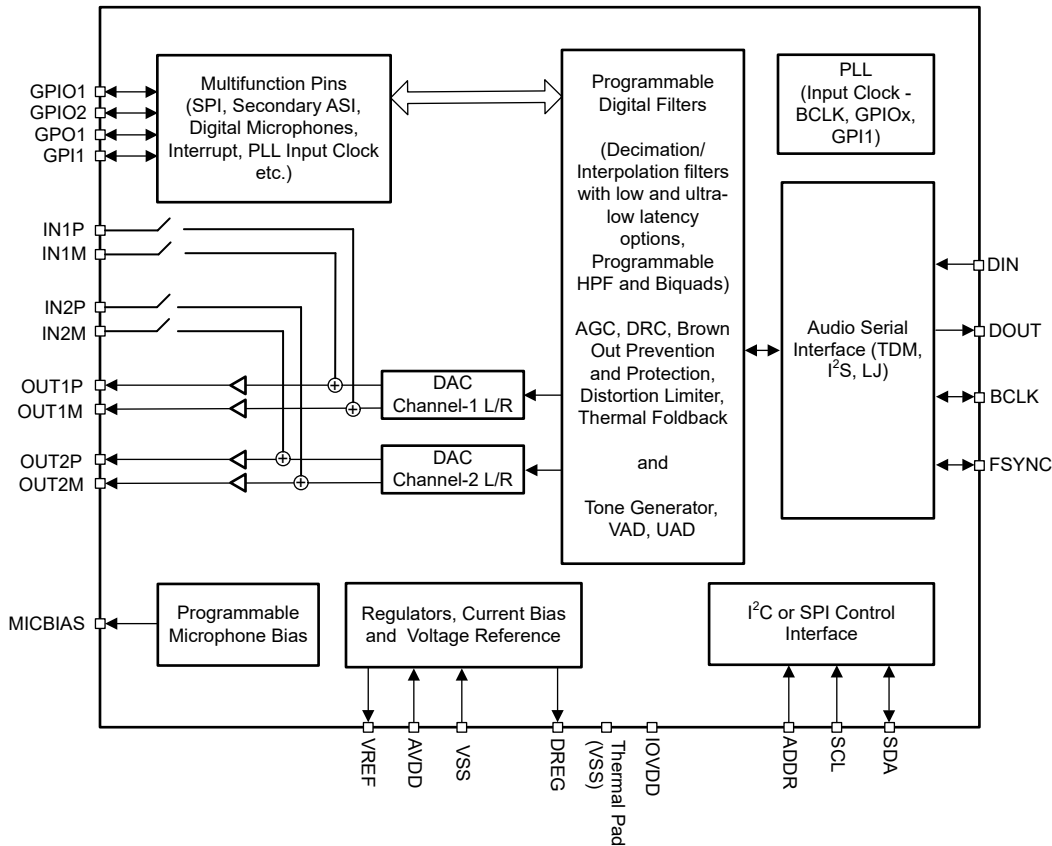

## 6.3 Feature Description

### 6.3.1 Serial Interfaces

This device has two serial interfaces: control and audio data. The control serial interface is used for device configuration. The audio data serial interface is used for transmitting audio data to the host device.

#### 6.3.1.1 Control Serial Interfaces

The device contains configuration registers and programmable coefficients that can be set to the desired values for a specific system and application use. All these registers can be accessed using either I<sup>2</sup>C or SPI communication to the device. For more information, see the [Section 7](#) section.

#### 6.3.1.2 Audio Serial Interfaces

Digital audio data flows between the host processor and the TAD5212 on the digital audio serial interface (ASI), or audio bus. This highly flexible ASI bus includes a TDM mode for multichannel operation, support for I<sup>2</sup>S or left-justified protocols format, programmable data length options, very flexible controller-target configurability for bus clock lines and the ability to communicate with multiple devices within a system directly.

The TAD5212 supports up to two ASI Interfaces. Secondary ASI Clock and Data Pins can be configured by setting GPIO's. Frame Sync of two ASI's must be synchronous. See the [TAX5X1X Synchronous Sample Rate Conversion application report](#) for more details on Secondary ASI.

The bus protocol TDM, I<sup>2</sup>S, or left-justified (LJ) format can be selected for primary ASI by using the PASI\_FORMAT[1:0], P0\_R26\_D[7:6] register bits. As shown in [Table 6-2](#) and [Table 6-3](#), these modes are all most significant byte (MSB)-first, pulse code modulation (PCM) data format, with the output channel data word-length programmable as 16, 20, 24, or 32 bits by configuring the PASI\_WLEN[1:0], P0\_R26\_D[5:4] register bits.

**Table 6-2. Primary Audio Serial Interface Format**

P0_R26_D[7:6] : PASI_FORMAT[1:0]	PRIMARY AUDIO SERIAL INTERFACE FORMAT
00 (default)	Time division multiplexing (TDM) mode
01	Inter IC sound (I <sup>2</sup> S) mode
10	Left-justified (LJ) mode
11	Reserved (do not use this setting)

**Table 6-3. Primary Audio Serial Interface Data Word-Length**

P0_R26_D[5:4] : PASI_WLEN[1:0]	PRIMARY AUDIO OUTPUT CHANNEL DATA WORD-LENGTH
00	Data word-length set to 16 bits
01	Data word-length set to 20 bits
10	Data word-length set to 24 bits
11 (default)	Data word-length set to 32 bits

The frame sync pin, FSYNC, is used in this audio bus protocol to define the beginning of a frame and has the same frequency as the output data sample rates. The bit clock pin, BCLK, is used to clock out the digital audio data across the serial bus. The number of bit-clock cycles in a frame must accommodate multiple device active output channels with the programmed data word length.

A frame consists of multiple time-division channel slots (up to 32) to allow all input/output channel audio data transmissions to complete on the audio bus by a device or multiple devices sharing the same audio bus. The device supports up to eight input channels and eight output channels that can be configured on primary ASI bus to place their audio data on bus slot 0 to slot 31. [Table 6-4](#) lists the output channel-1 slot configuration settings. In I<sup>2</sup>S and LJ mode, the slots are divided into two sets, left-channel slots and right-channel slots, as described in the [Section 6.3.1.2.2](#) and [Section 6.3.1.2.3](#).

**Table 6-4. Output Channel-1 Slot Assignment Settings**

P0_R30_D[4:0] : PASI_TX_CH1_SLOT[4:0]	OUTPUT CHANNEL 1 SLOT ASSIGNMENT
0 0000 = 0d (default)	Slot 0 for TDM or left slot 0 for I <sup>2</sup> S, LJ.
0 0001 = 1d	Slot 1 for TDM or left slot 1 for LJ.
...	...
0 1111 = 15d	Slot 15 for TDM or left slot 15 for LJ.
1 0000 = 32d	Slot 16 for TDM or right slot 0 for I <sup>2</sup> S, LJ.
...	...
1 1110 = 30d	Slot 30 for TDM or right slot 14 for LJ.
1 1111 = 31d	Slot 31 for TDM or right slot 15 for LJ.

Similarly, the slot assignment setting for output channel 2 to channel 8 can be done using the PASI\_TX\_CH2\_SLOT\_NUM (P0\_R31\_D[4:0]) to PASI\_TX\_CH8\_SLOT\_NUM (P0\_R37) registers and for input channel 1 to channel 8 by using the PASI\_RX\_CH1\_SLOT\_NUM (P0\_R40\_D[4:0]) to PAS\_RX\_CH8\_SLOT\_NUM (P0\_R47\_D[4:0]) registers, respectively.

The slot word length is the same as the primary ASI channel word length set for the device. The output channel data word length must be set to the same value for all TAD5212 devices if all devices share the same ASI bus in a system. The maximum number of slots possible for the ASI bus in a system is limited by the available bus

bandwidth, which depends upon the BCLK frequency, output data sample rate used, and the channel data word length configured.

The device also includes a feature that offsets the start of the slot data transfer with respect to the frame sync by up to 31 cycles of the bit clock. Offset can be configured independently for input and output data paths. [Table 6-5](#) and [Table 6-6](#) lists the programmable offset configuration settings for transmission and receive paths respectively.

**Table 6-5. Programmable Offset Settings for the ASI Slot Start for transmission**

P0_R28_D[4:0] : PASI_TX_OFFSET[4:0]	PROGRAMMABLE OFFSET SETTING FOR SLOT DATA TRANSMISSION START
0 0000 = 0d (default)	The device follows the standard protocol timing without any offset.
0 0001 = 1d	Slot start is offset by one BCLK cycle, as compared to standard protocol timing. For I <sup>2</sup> S or LJ, the left and right slot start is offset by one BCLK cycle, as compared to standard protocol timing.
.....	.....
1 1110 = 30d	Slot start is offset by 30 BCLK cycles, as compared to standard protocol timing. For I <sup>2</sup> S or LJ, the left and right slot start is offset by 30 BCLK cycles, as compared to standard protocol timing.
1 1111 = 31d	Slot start is offset by 31 BCLK cycles, as compared to standard protocol timing. For I <sup>2</sup> S or LJ, the left and right slot start is offset by 31 BCLK cycles, as compared to standard protocol timing.

**Table 6-6. Programmable Offset Settings for the ASI Slot Start for Receive**

P0_R38_D[4:0] : PASI_RX_OFFSET[4:0]	PROGRAMMABLE OFFSET SETTING FOR SLOT DATA RECEIVE START
0 0000 = 0d (default)	The device follows the standard protocol timing without any offset.
0 0001 = 1d	Slot start is offset by one BCLK cycle, as compared to standard protocol timing. For I <sup>2</sup> S or LJ, the left and right slot start is offset by one BCLK cycle, as compared to standard protocol timing.
.....	.....
1 1110 = 30d	Slot start is offset by 30 BCLK cycles, as compared to standard protocol timing. For I <sup>2</sup> S or LJ, the left and right slot start is offset by 30 BCLK cycles, as compared to standard protocol timing.
1 1111 = 31d	Slot start is offset by 31 BCLK cycles, as compared to standard protocol timing. For I <sup>2</sup> S or LJ, the left and right slot start is offset by 31 BCLK cycles, as compared to standard protocol timing.

The device also features the ability to invert the polarity of the frame sync pin, FSYNC, used to transfer the audio data as compared to the default FSYNC polarity used in standard protocol timing. This feature can be set using the PASI\_FSYNC\_POL (P0\_R26\_D[3]) register bit. Similarly, the device can invert the polarity of the bit clock pin, BCLK, which can be set using the PASI\_BCLK\_POL (P0\_R26\_D[2]) register bit.

In addition, the word clock and bit clock can be independently configured in either Controller or Target mode, for flexible connectivity to a wide variety of processors. The word clock is used to define the beginning of a frame, and may be programmed as either a pulse or a square-wave signal. The frequency of this clock corresponds to the maximum of the selected DAC channels sampling frequencies.

#### 6.3.1.2.1 Time Division Multiplexed Audio (TDM) Interface

In TDM mode, also known as DSP mode, the rising edge of FSYNC starts the data transfer with the slot 0 data first. Immediately after the slot 0 data transmission, the remaining slot data are transmitted in order. FSYNC and each data bit (except the MSB of slot 0 when TX\_OFFSET equals 0) is transmitted on the rising edge of BCLK. [Figure 6-1](#) to [Figure 6-4](#) illustrate the protocol timing for TDM operation with various configurations for transmit DOUT line. The same protocol is applicable for the receive DIN line as well.



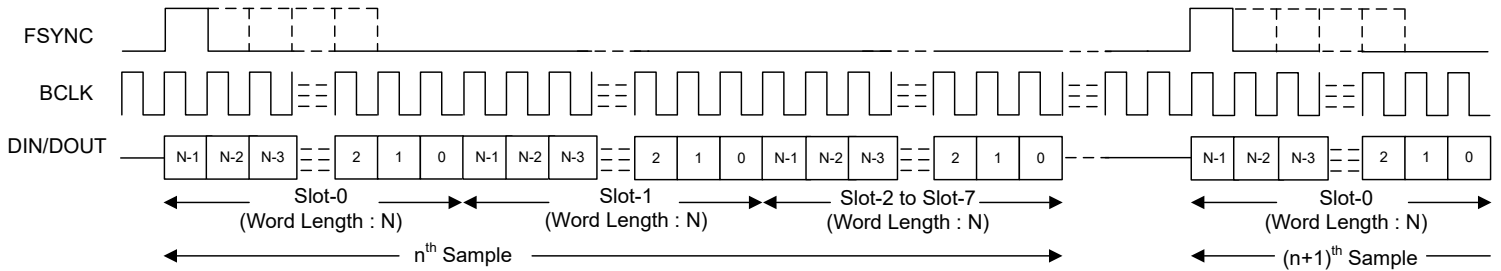

Figure 6-1. TDM Mode Standard Protocol Timing ( $PASI\_TX\_OFFSET = 0$ )

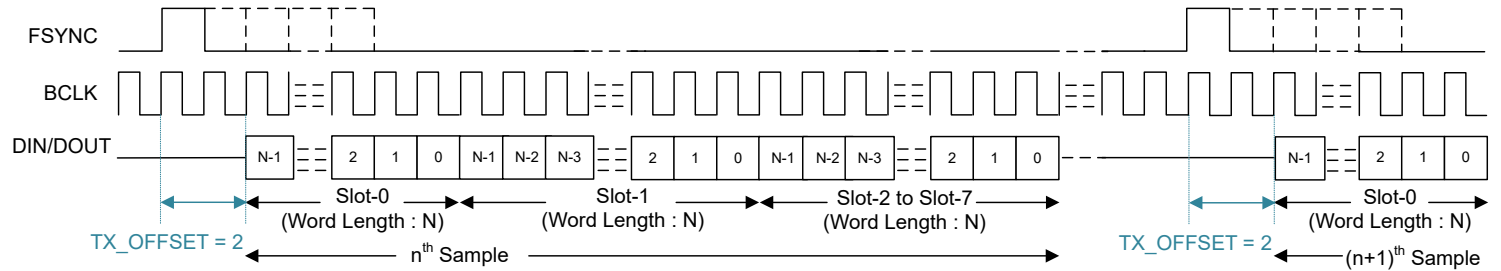

Figure 6-2. TDM Mode Protocol Timing ( $PASI\_TX\_OFFSET = 2$ )

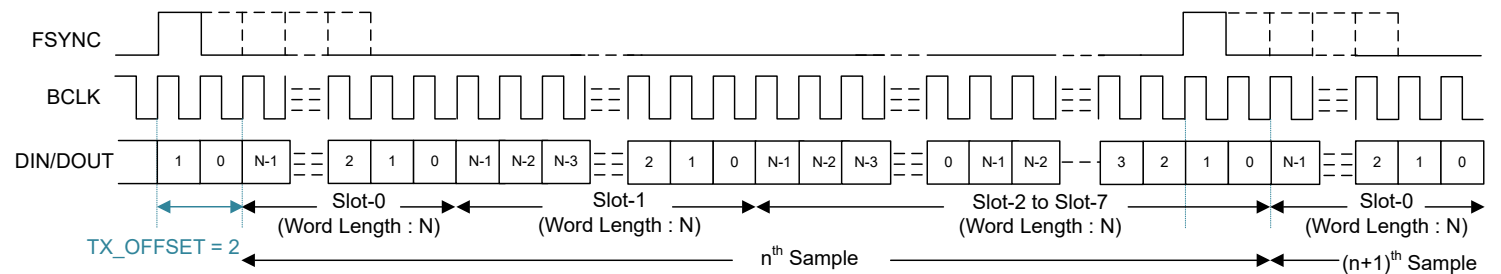

Figure 6-3. TDM Mode Protocol Timing (No Idle BCLK Cycles,  $PASI\_TX\_OFFSET = 2$ )

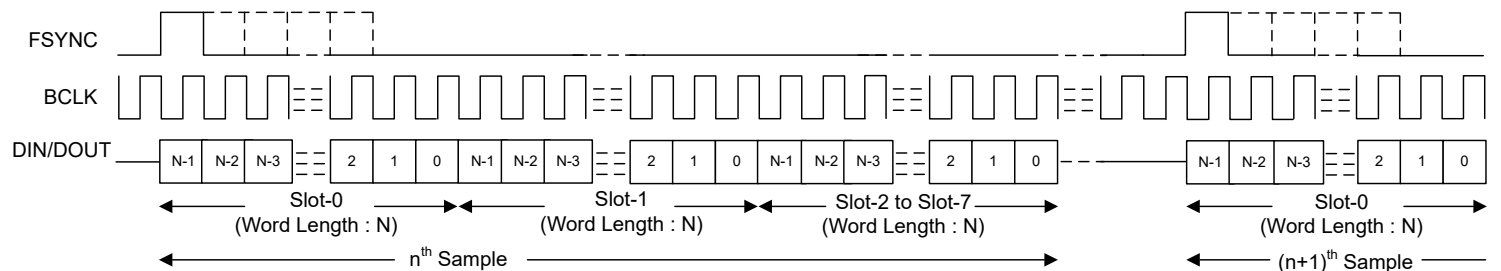

Figure 6-4. TDM Mode Protocol Timing ( $PASI\_TX\_OFFSET = 0$  and  $PASI\_BCLK\_POL = 1$ )

For proper operation of the audio bus in TDM mode, the number of bit clocks per frame must be greater than or equal to the number of active output channels times the programmed word length of the output channel data. The device supports FSYNC as a pulse with a 1-cycle-wide bit clock but also supports multiples as well. For a higher BCLK frequency operation, using TDM mode with a  $PASI\_TX\_OFFSET$  value higher than 0 is recommended.

### 6.3.1.2.2 Inter IC Sound ( $I^2S$ ) Interface

The standard  $I^2S$  protocol is defined for only two channels: left and right. The device extends the same protocol timing for multichannel operation. In  $I^2S$  mode, the MSB of the left slot 0 is transmitted on the falling edge of BCLK in the second cycle after the falling edge of FSYNC. Immediately after the left slot 0 data transmission, the remaining left slot data are transmitted in order. The MSB of the right slot 0 is transmitted on the falling edge of

BCLK in the second cycle after the *rising* edge of FSYNC. Immediately after the right slot 0 data transmission, the remaining right slot data are transmitted in order. FSYNC and each data bit is transmitted on the falling edge of BCLK. Figure 6-5 to Figure 6-8 illustrate the protocol timing for I<sup>2</sup>S operation with various configurations for the transmit DOUT line. The same protocol is applicable for the receive DIN line as well.

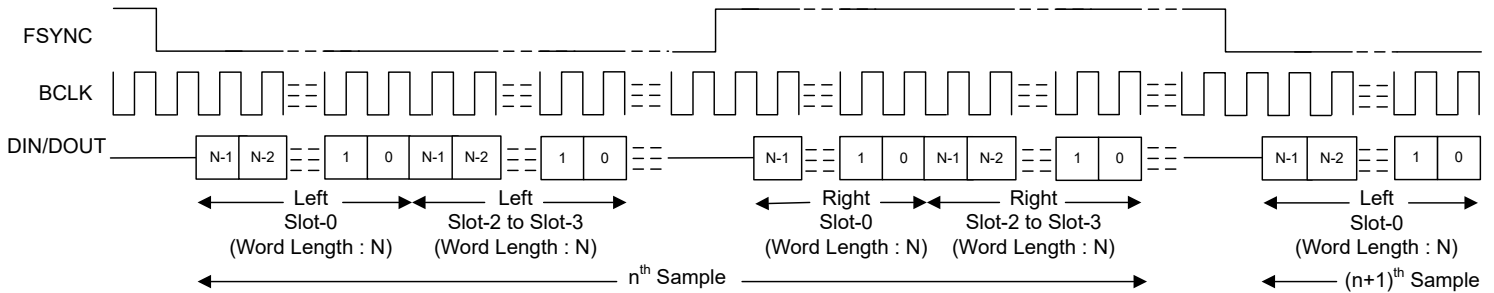

Figure 6-5. I<sup>2</sup>S Mode Standard Protocol Timing (PASI\_TX\_OFFSET = 0)

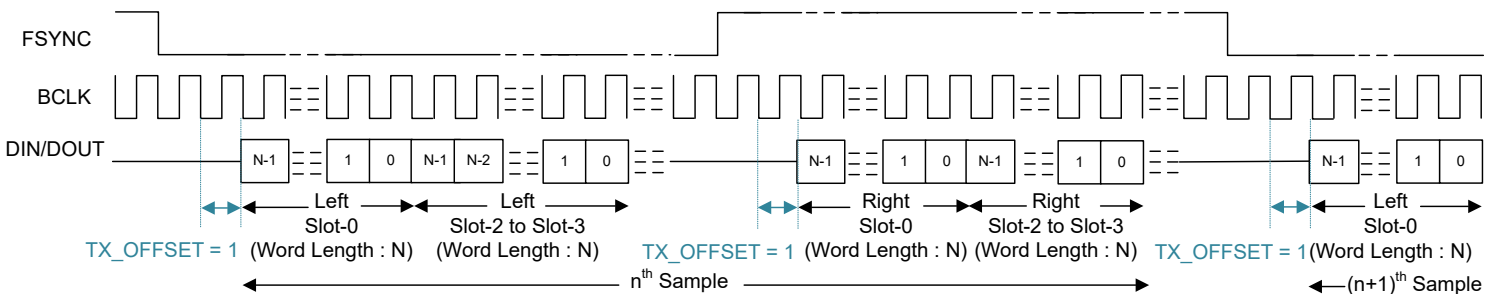

Figure 6-6. I<sup>2</sup>S Protocol Timing (PASI\_TX\_OFFSET = 1)

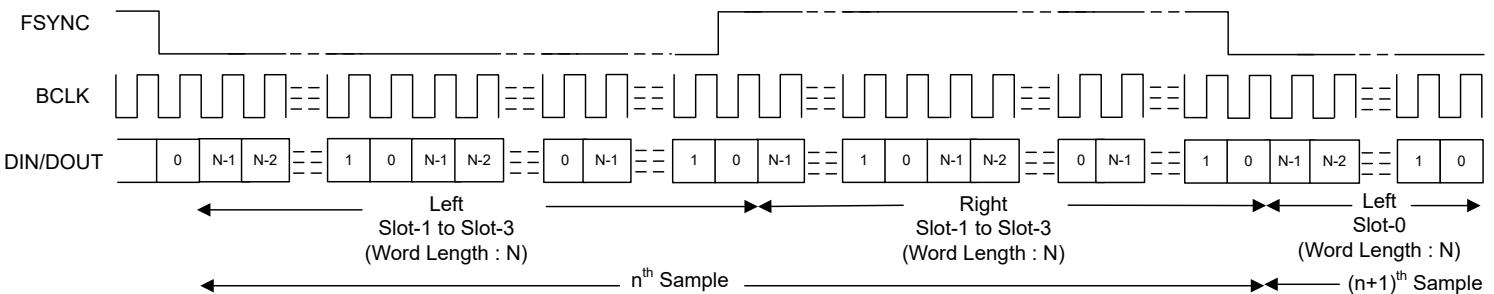

Figure 6-7. I<sup>2</sup>S Protocol Timing (No Idle BCLK Cycles, PASI\_TX\_OFFSET = 0)

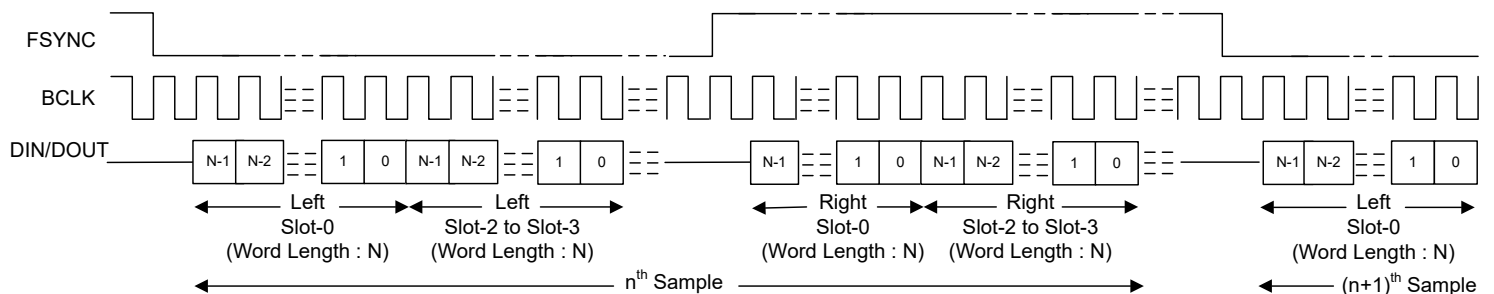

Figure 6-8. I<sup>2</sup>S Protocol Timing (PASI\_TX\_OFFSET = 0 and PASI\_BCLK\_POL = 1)

For proper operation of the audio bus in I<sup>2</sup>S mode, the number of bit clocks per frame must be greater than or equal to the number of active output channels (including left and right slots) times the programmed word length of the output channel data. The device FSYNC low pulse must be several BCLK cycles wide that is greater than

or equal to the number of active left slots times the data word length configured. Similarly, the FSYNC high pulse must be several BCLK cycles wide that is greater than or equal to the number of active right slots times the data word length configured.

### 6.3.1.2.3 Left-Justified (LJ) Interface

The standard LJ protocol is defined for only two channels: left and right. The device extends the same protocol timing for multichannel operation. In LJ mode, the MSB of the left slot 0 is transmitted in the same BCLK cycle after the *rising* edge of FSYNC. Each subsequent data bit is transmitted on the falling edge of BCLK. Immediately after the left slot 0 data transmission, the remaining left slot data are transmitted in order. The MSB of the right slot 0 is transmitted in the same BCLK cycle after the *falling* edge of FSYNC. Each subsequent data bit is transmitted on the falling edge of BCLK. Immediately after the right slot 0 data transmission, the remaining right slot data are transmitted in order. FSYNC is transmitted on the falling edge of BCLK. [Figure 6-9](#) to [Figure 6-12](#) illustrate the protocol timing for LJ operation with various configurations for the transmit DOUT line. The same protocol is applicable for the receive DIN line as well.

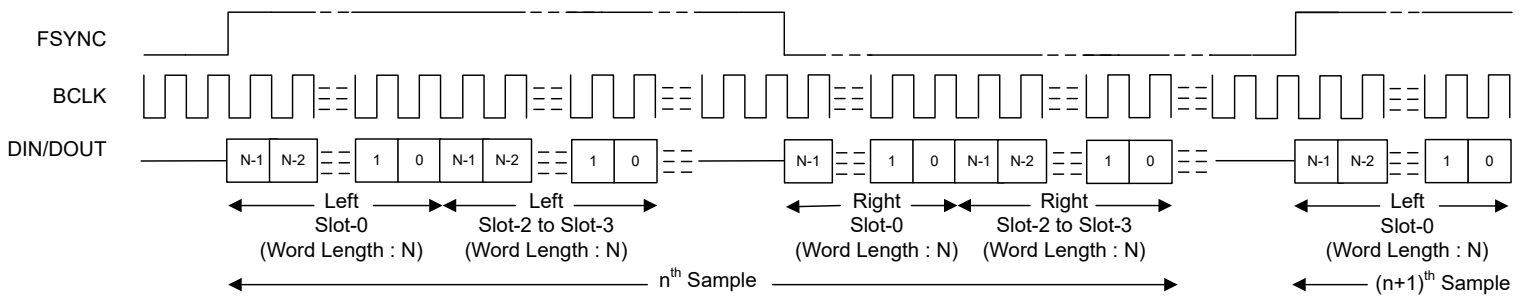

**Figure 6-9. LJ Mode Standard Protocol Timing (TX\_OFFSET = 0)**

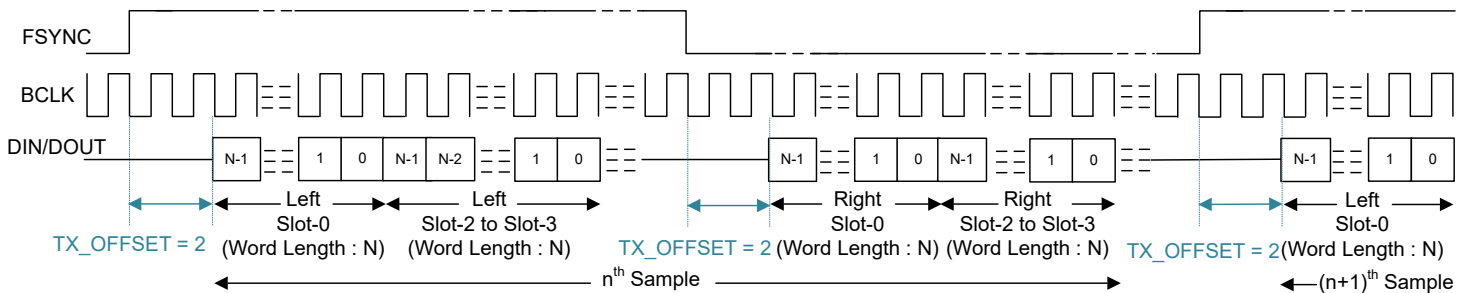

**Figure 6-10. LJ Protocol Timing (TX\_OFFSET = 2)**

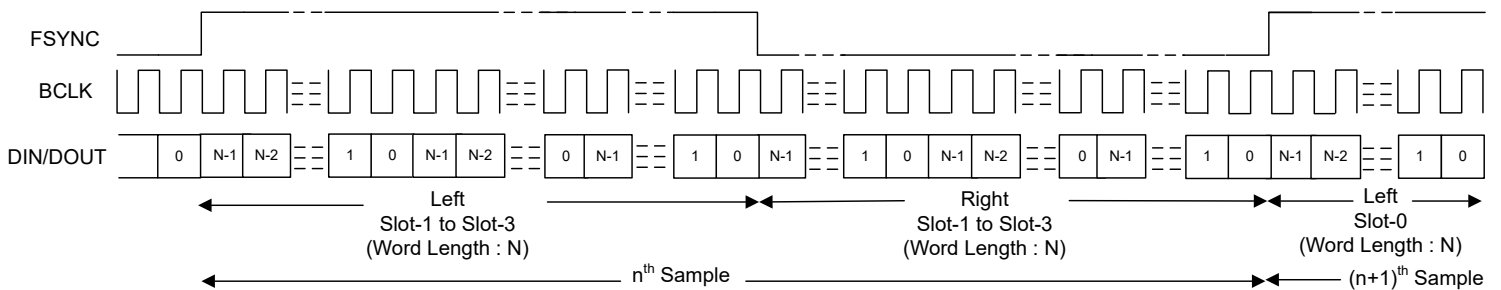

**Figure 6-11. LJ Protocol Timing (No Idle BCLK Cycles, TX\_OFFSET = 0)**

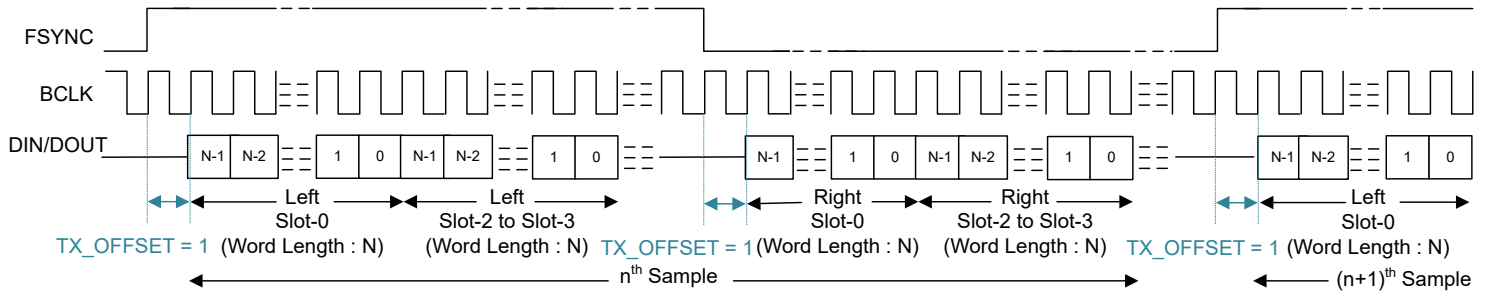
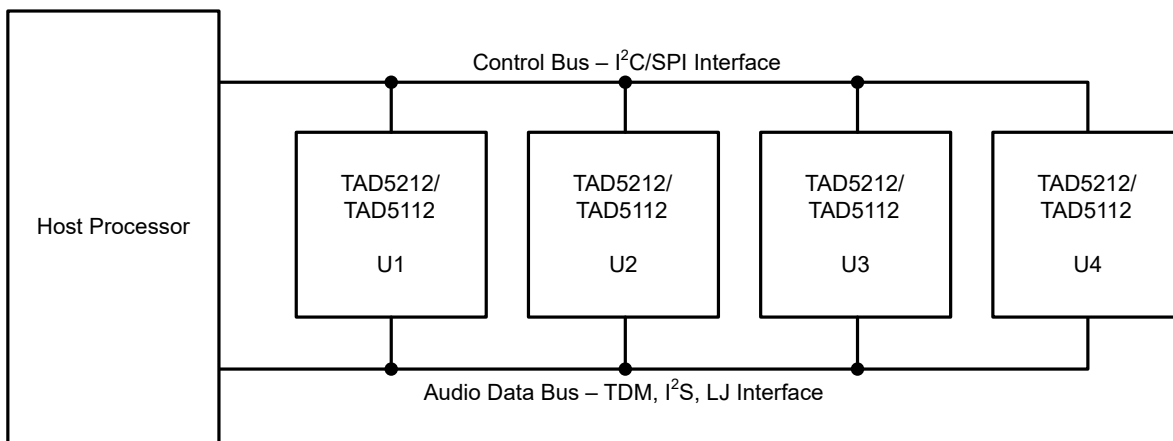

**Figure 6-12. LJ Protocol Timing (TX\_OFFSET = 1 and BCLK\_POL = 1)**

For proper operation of the audio bus in LJ mode, the number of bit clocks per frame must be greater than or equal to the number of active output channels (including left and right slots) times the programmed word length of the output channel data. The device FSYNC high pulse must be several BCLK cycles wide that is greater than or equal to the number of active left slots times the data word length configured. Similarly, the FSYNC low pulse must be several BCLK cycles wide that is greater than or equal to the number of active right slots times the data word length configured. For a higher BCLK frequency operation, using LJ mode with a TX\_OFFSET value higher than 0 is recommended.

### 6.3.1.3 Using Multiple Devices With Shared Buses

The device has many supported features and flexible options that can be used in the system to seamlessly connect multiple TAD5212 devices by sharing a single common I<sup>2</sup>C or SPI control bus and an audio serial interface bus. This architecture enables multiple applications to be applied to a system that require a microphone or speaker array for beam-forming operation, audio conferencing, noise cancellation, and so forth. [Figure 6-13](#) shows a diagram of multiple TAD5212 devices in a configuration where the control and audio data buses are shared.



**Figure 6-13. Multiple TAD5212 Devices With Shared Control and Audio Data Buses**

The TAD5212 consists of the following features to enable seamless connection and interaction of multiple devices using a shared bus:

- Supports up to four pin-programmable I<sup>2</sup>C target addresses
- I<sup>2</sup>C broadcast simultaneously writes to (or triggers) all TAD5212 devices
- Supports up to 32 configuration input/output channel slots for the audio serial interface
- Tri-state feature (with enable and disable) for the unused audio data slots of the device
- Supports a bus-holder feature (with enable and disable) to keep the last driven value on the audio bus
- The GPIOx, GPI1 or GPO1 pin can be configured as a secondary input/output data lane or as a secondary audio serial interface
- The GPIOx, GPI1 or GPO1 pin can be used in a daisy-chain configuration of multiple TAD5212 devices

- Supports one BCLK cycle data latching timing to relax the timing requirement for the high-speed interface
- Programmable controller and target options for both primary and secondary audio serial interface
- Ability to synchronize the multiple devices for the simultaneous sampling requirement across devices
- Inter Channel Gain Alignment (ICGA) feature to align the DAC Channel gain across devices.

See the [Multiple TAC5x1x Devices With a Shared TDM and I<sup>2</sup>C/SPI Bus application report](#) for further details.

### 6.3.2 Phase-Locked Loop (PLL) and Clock Generation

The device has a smart auto-configuration block to generate all necessary internal clocks required for the DAC modulators and the digital filter engine used for signal processing. This configuration is done by monitoring the frequency of the FSYNC and BCLK signal on the audio buses.

The device supports the various data sample rates (of the FSYNC signal frequency) and the BCLK to FSYNC ratio to configure all clock dividers, including the PLL configuration, internally without host programming. [Table 6-7](#) and [Table 6-8](#) list the supported FSYNC and BCLK frequencies.

**Table 6-7. Supported FSYNC (Multiples or Submultiples of 48 kHz) and BCLK Frequencies**

BCLK TO FSYNC RATIO	BCLK (MHz)								
	FSYNC (8 kHz)	FSYNC (16 kHz)	FSYNC (24 kHz)	FSYNC (32 kHz)	FSYNC (48 kHz)	FSYNC (96 kHz)	FSYNC (192 kHz)	FSYNC (384 kHz)	FSYNC (768 kHz)
16	Reserved	0.256	0.384	0.512	0.768	1.536	3.072	6.144	12.288
24	Reserved	0.384	0.576	0.768	1.152	2.304	4.608	9.216	18.432
32	0.256	0.512	0.768	1.024	1.536	3.072	6.144	12.288	24.576
48	0.384	0.768	1.152	1.536	2.304	4.608	9.216	18.432	Reserved
64	0.512	1.024	1.536	2.048	3.072	6.144	12.288	24.576	Reserved
96	0.768	1.536	2.304	3.072	4.608	9.216	18.432	Reserved	Reserved
128	1.024	2.048	3.072	4.096	6.144	12.288	24.576	Reserved	Reserved
192	1.536	3.072	4.608	6.144	9.216	18.432	Reserved	Reserved	Reserved
256	2.048	4.096	6.144	8.192	12.288	24.576	Reserved	Reserved	Reserved
384	3.072	6.144	9.216	12.288	18.432	Reserved	Reserved	Reserved	Reserved
512	4.096	8.192	12.288	16.384	24.576	Reserved	Reserved	Reserved	Reserved
1024	8.192	16.384	24.576	Reserved	Reserved	Reserved	Reserved	Reserved	Reserved
2048	16.384	Reserved	Reserved	Reserved	Reserved	Reserved	Reserved	Reserved	Reserved

**Table 6-8. Supported FSYNC (Multiples or Submultiples of 44.1 kHz) and BCLK Frequencies**

BCLK TO FSYNC RATIO	BCLK (MHz)								
	FSYNC (7.35 kHz)	FSYNC (14.7 kHz)	FSYNC (22.05 kHz)	FSYNC (29.4 kHz)	FSYNC (44.1 kHz)	FSYNC (88.2 kHz)	FSYNC (176.4 kHz)	FSYNC (352.8 kHz)	FSYNC (705.6 kHz)
16	Reserved	Reserved	0.3528	0.4704	0.7056	1.4112	2.8224	5.6448	11.2896
24	Reserved	0.3528	0.5292	0.7056	1.0584	2.1168	4.2336	8.4672	16.9344
32	Reserved	0.4704	0.7056	0.9408	1.4112	2.8224	5.6448	11.2896	22.5792
48	0.3528	0.7056	1.0584	1.4112	2.1168	4.2336	8.4672	16.9344	Reserved
64	0.4704	0.9408	1.4112	1.8816	2.8224	5.6448	11.2896	22.5792	Reserved
96	0.7056	1.4112	2.1168	2.8224	4.2336	8.4672	16.9344	Reserved	Reserved
128	0.9408	1.8816	2.8224	3.7632	5.6448	11.2896	22.5792	Reserved	Reserved
192	1.4112	2.8224	4.2336	5.6448	8.4672	16.9344	Reserved	Reserved	Reserved
256	1.8816	3.7632	5.6448	7.5264	11.2896	22.5792	Reserved	Reserved	Reserved
384	2.8224	5.6448	8.4672	11.2896	16.9344	Reserved	Reserved	Reserved	Reserved
512	3.7632	7.5264	11.2896	15.0528	22.5792	Reserved	Reserved	Reserved	Reserved
1024	7.5264	15.0528	22.5792	Reserved	Reserved	Reserved	Reserved	Reserved	Reserved
2048	15.0528	Reserved	Reserved	Reserved	Reserved	Reserved	Reserved	Reserved	Reserved

The TAD5212 also supports non-Audio sample rates beyond those listed in prior tables. Refer to [Clocking Configuration of Device and Flexible Clocking For TA5x1x Family application report](#) for more details. .

The TAD5212 sample rate can be configured using registers CLK\_CFG0 (P0\_R50) and CLK\_CFG1 (P0\_R51) for primary and secondary ASI respectively. CLK\_DET\_STS0 (P0\_R62) and CLK\_DET\_STS1 (P0\_R63) registers also capture the device auto detect result for the FSYNC frequency in auto detection mode for

the primary and secondary ASI respectively. The registers CLK\_DET\_STS2 (P0\_R64) and CLK\_DET\_STS3 (P0\_R65) capture the BCLK to FSYNC ratio detected by the device in the auto detection mode for the selected ASI which is chosen to be the PLL reference through the CLK\_SRC\_SEL (P0\_R52\_D[3:1]) registers. If the device finds any unsupported combinations of FSYNC frequency and BCLK to FSYNC ratios, the device generates an ASI clock-error interrupt and shuts down various blocks of the device accordingly.

The TAD5212 also supports enabling channels while PDM or DAC channels are already in operation. This requires a pre-configuration before power to describe the maximum number of channels that can be enabled while in operation to ensure proper clock generation and use. This can be configured by using register DYN\_PUPD\_CFG (P0\_R119). ADC\_DYN\_PUPD\_EN (P0\_R119\_D[7]) and DAC\_DYN\_PUPD\_EN (P0\_R119\_D[5]) bits can be used to independently enable PDM or DAC Channels' dynamic power up. Number of maximum channels supported for dynamic power-up and power-down can be configured using ADC\_DYN\_MAXCH\_SEL (P0\_R119\_D[6]) and DAC\_DYN\_MAXCH\_SEL (P0\_R119\_D[4]) bits.

The device uses an integrated, low-jitter, phase-locked loop (PLL) to generate internal clocks required for the modulators and digital filter engine, as well as other control blocks. The device also supports an option to use BCLK, GPIOx, or the GPI1 pin (as CCLK) as the audio clock source without using the PLL to reduce power consumption. However, the DAC performance may degrade based on jitter from the external clock source, and some processing features may not be supported if the external audio clock source frequency is not high enough. Therefore, TI recommends using the PLL for high-performance applications. More details and information on how to configure and use the device in low-power mode without using the PLL are discussed in the [TAD5x1x Power Consumption Matrix Across Various Usage Scenarios application report](#).

The device also supports an audio bus controller mode operation using the GPIOx or GPI1 pin (as CCLK) as the reference input clock source and supports various flexible options and a wide variety of system clocks. More details and information on controller mode configuration and operation are discussed in the [Clocking Configuration of Device and Flexible Clocking For TAx5x1x Family application report](#).

The audio bus clock error detection and auto-detect feature automatically generates all internal clocks, but can be disabled using the IGNORE\_CLK\_ERR (P0\_R4\_D[6]) and CUSTOM\_CLK\_CFG (P0\_R50\_D[0]) register bits, respectively. In the system, this disable feature can be used to support custom clock frequencies that are not covered by the auto detect scheme. For such application use cases, care must be taken to ensure that the multiple clock dividers are all configured appropriately. TI recommends using the PPC3 GUI for device configuration settings; for more details see the [TAC5212EVM-PDK Evaluation module user's guide](#) and the [PurePath™ console graphical development suite](#). The [Clocking Configuration of Device and Flexible Clocking For TAx5x1x Family application report](#) also covers various aspects of the custom clock configurations. Refer [Clock Error Configuration, Detection, and Modes Supported in TAx5x1x Family application report](#) for more details about the clock detection module of the device.

When the PLL is turned off, the digital volume control and other features using programmable coefficients like biquads, mixer, AGC etc., except the high pass filter (HPF) are not applicable.

### 6.3.3 Output Channel Configurations

The device consists of two pairs of analog output pins (OUTxP and OUTxM) that can be configured as differential inputs or single-ended outputs for playback channels. The device supports simultaneous playback of up to four channels of single-ended outputs or up to two channel differential output using the high-performance multichannel DAC. [Table 6-9](#) shows the input source selection for the playback channels.

**Table 6-9. Input Source Selection for the Playback Channel**

P0_R100_D[7:5] : OUT1x_SRC[2:0]	OUT1P/OUT1M Input Source Selection
000	Output driver disabled
001 (default)	DAC signal chain
010	Analog bypass signal chain
011	Mixing of DAC and Analog bypass signal chains
100	OUT1P for DAC and OUT1M for Analog bypass signal chain
101	OUT1P for Analog bypass and OUT1M for DAC signal chain.

**Table 6-9. Input Source Selection for the Playback Channel (continued)**

P0_R100_D[7:5] : OUT1x_SRC[2:0]	OUT1P/OUT1M Input Source Selection
11x	Reserved. Do not use this setting.

Similarly, the input source selection setting for output channel 2 can be configured using the OUT2x\_SRC[2:0] (P0\_R107\_D[7:5]) register bits.

The TAD5212 supports up to 2-channel differential output, up to 2-channel pseudo-differential output, and up to 4-channel single-ended output. Each of the output channels can be independently configured for differential or single-ended output.

Table 6-10 shows the configuration modes for the output pins.

**Table 6-10. Output Pin Configuration for the Playback Channel**

P0_R100_D[4:2] : OUT1x_CFG[2:0]	OUT1P/OUT1M Pin Configuration
000 (default)	OUT1P/OUT1M as a differential pair
001	OUT1P and OUT1M as independent single-ended outputs
010	Mono single-ended output on OUT1P only
011	Mono single-ended output on OUT1M only
100	Pseudo-differential output with OUT1P as signal and OUT1M as VCOM
101	Pseudo differential output with OUT1P as signal, OUT1M as VCOM and OUT2M as VCOM sense (external common mode sense).
110	Pseudo-differential output with OUT1M as signal and OUT1P as VCOM
111	Reserved. Do not use this setting.

Similarly, the output pin configuration for output channel 2 can be done using the OUT2x\_CFG[2:0] (P0\_R107\_D[4:2]) register bits.

See Figure 6-14 to Figure 6-17 for the various typical output configuration diagrams.

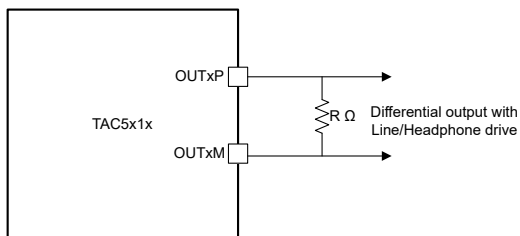

**Figure 6-14. Differential Output Connection**  
(OUT1x\_CFG[2:0] = 3'b000)

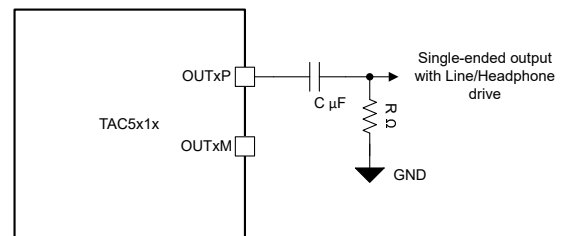

**Figure 6-15. Mono Single-ended Output Connection on OUT1P**  
(OUT1x\_CFG[2:0] = 3'b010)

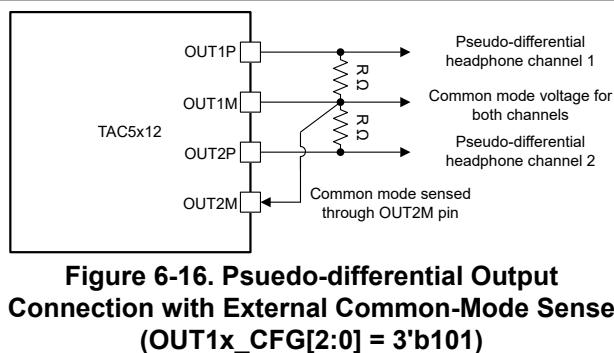

**Figure 6-16. Pseudo-differential Output Connection with External Common-Mode Sense**  
(OUT1x\_CFG[2:0] = 3'b101)

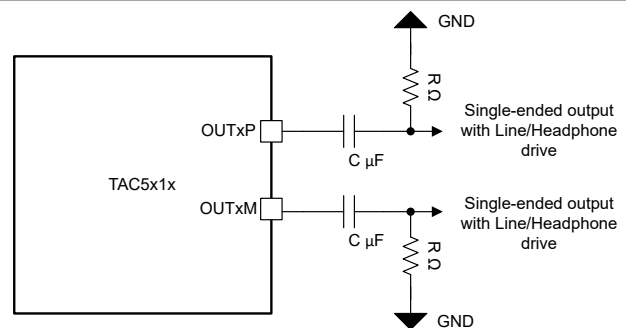

**Figure 6-17. Stereo Single-ended Output Connection**  
(OUT1x\_CFG[2:0] = 3'b001)



The TAD5212 can support a variety of loads including headphone, lineout, and receiver amplifiers. Load drive configurations are available for each pin independently. OUT1P\_DRIVE[1:0] (P0\_R101\_D[7:6]) configures the load drive capability for the OUT1P pin. Similarly, OUT1M\_DRIVE[1:0], OUT2P\_DRIVE[1:0], OUT2M\_DRIVE[1:0] control the output drive for OUT1M, OUT2P and OUT2M respectively.

### 6.3.4 Reference Voltage

All audio data converters require a DC reference voltage. The TAD5212 achieves low-noise performance by internally generating a low-noise reference voltage. This reference voltage is generated using a band-gap circuit with high PSRR performance. This audio converter reference voltage must be filtered externally using a minimum 1µF capacitor connected from the VREF pin to analog ground (VSS).

The value of this reference voltage can be configured using the P0\_R77\_D[1:0] register bits and must be set to an appropriate value based on the desired full-scale input for the device (analog bypass path) and the AVDD supply voltage available in the system. The default VREF value is set to 2.75V, which in turn supports a 2V<sub>RMS</sub> differential full-scale input to the device. The required minimum AVDD voltage for this mode is 3V. [Table 6-11](#) lists the various VREF settings supported along with required AVDD range and the supported full-scale input signal for that configuration.

**Table 6-11. VREF Programmable Settings**

P0_R77_D[1:0] : VREF[1:0]	VREF OUTPUT VOLTAGE	DIFFERENTIAL FULL-SCALE INPUT SUPPORTED	SINGLE-ENDED FULL-SCALE INPUT SUPPORTED	AVDD OPERATION MODE
00 (default)	2.75V	2 V <sub>RMS</sub>	1 V <sub>RMS</sub>	AVDD 3.3V Operation
01	2.5V	1.818 V <sub>RMS</sub>	0.909 V <sub>RMS</sub>	AVDD 3.3V Operation
10	1.375V	1 V <sub>RMS</sub>	0.5 V <sub>RMS</sub>	AVDD 1.8V Operation
11	Reserved	Reserved	Reserved	Reserved

To achieve low-power consumption, this audio reference block is powered down as described in the [Section 6.4](#). When exiting sleep mode, the audio reference block is powered up using the internal fast-charge scheme and the VREF pin settles to its steady-state voltage after the settling time (a function of the decoupling capacitor on the VREF pin). This time is approximately equal to 3.5ms when using a 1µF decoupling capacitor. If a higher-value decoupling capacitor is used on the VREF pin, the fast-charge setting must be reconfigured using the VREF\_QCHG (P0\_R2\_D[4:3]) register bits, which support options of 3.5ms (default), 10ms, 50ms, or 100ms.

### 6.3.5 Programmable Microphone Bias

The device integrates a built-in, low-noise microphone bias pin that can be used in the system for biasing electret-condenser microphones or providing the supply to the MEMS analog or digital microphone. The integrated bias amplifier supports up to 10 mA of load current that can be used for multiple microphones and is designed to provide a combination of high PSRR, low noise, and programmable bias voltages to allow the biasing to be fine tuned for specific microphone combinations.

When using this MICBIAS pin for biasing or supplying to multiple microphones, avoid any common impedance on the board layout for the MICBIAS connection to minimize coupling across microphones. [Table 6-12](#) shows the available microphone bias programmable options.

**Table 6-12. MICBIAS Programmable Settings**

P0_R77_D[3:2] : MICBIAS_VAL[1:0]	P0_R77_D[1:0] : VREF_FSCALE[1:0]	MICBIAS OUTPUT VOLTAGE
00 (default)	00 (default)	2.75 V (same as the VREF output)
	01	2.5 V (same as the VREF output)
	10	1.375 V (same as the VREF output)
	11	Reserved (do not use these settings)
01	00 (default)	1.375 V (0.5 times the VREF output)
	01	1.250 V (0.5 times the VREF output)
	10 or 11	Reserved (do not use these settings)

**Table 6-12. MICBIAS Programmable Settings (continued)**

P0_R77_D[3:2] : MICBIAS_VAL[1:0]	P0_R77_D[1:0] : VREF_FSCALE[1:0]	MICBIAS OUTPUT VOLTAGE
10	XX	Reserved (do not use these settings)
11	XX	Same as AVDD

The microphone bias output can be powered on or powered off (default) by configuring the MICBIAS\_PDZ, P0\_R120\_D5 register bit. Additionally, the device provides an option to configure the GPIO1 or GPIO pin to directly control the microphone bias output powering on or off. This feature is useful to control the microphone directly without engaging the host for I<sup>2</sup>C or SPI communication. The MICBIAS\_PDZ, P0\_R120\_D5 register bit value is ignored if the GPIO1 or GPIO pin is configured to set the microphone bias on or off.

### 6.3.6 Digital PDM Microphone Record Channel

The TAD5212 supports interface to digital pulse-density-modulation (PDM) microphones and uses high-order and high-performance decimation filters to generate pulse code modulation (PCM) output data that can be transmitted on the audio serial interface to the host. The device supports simultaneous recording on up to four digital microphone channels.

The GPIOx, GPI1 and GPO1 pins can be configured for the PDM data lines (PDMx) and PDM Clock (PDMCLK) functions as per the Interrupts, Status, and Digital I/O Pin Multiplexing section for the digital PDM microphone recording.

The device internally generates PDMCLK with a programmable frequency of either 6.144MHz, 3.072MHz, 1.536MHz, or 768kHz (for output data sample rates in multiples or submultiples of 48kHz) or 5.6448MHz, 2.8224MHz, 1.4112MHz, or 705.6kHz (for output data sample rates in multiples or submultiples of 44.1kHz) using the PDM\_CLK\_CFG[1:0] (P0\_R53\_D[7:6]) register bits. PDMCLK can be routed on the GPIOx and GPO1 pins using the respective configuration registers: GPIO1\_CFG (P0\_R10[7:4]), GPIO2\_CFG (P0\_R11[7:4]) and GPO1\_CFG (P0\_R12[7:4]). This clock can be connected to the external digital microphone device. [Figure 6-18](#) shows a connection diagram of the digital PDM microphones.

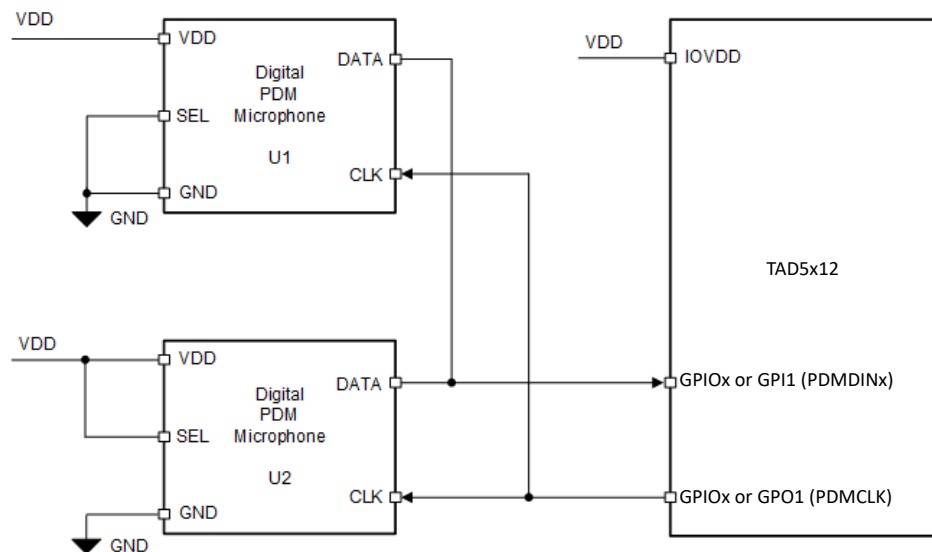
**Figure 6-18. Digital PDM Microphones Connection Diagram for the TAD5212**

The single-bit output of the external digital microphone device can be connected to the GPI1 or GPIOx pin. The device supports two PDM data lines: PDMx1 and PDMx2 set through the registers PDM\_DIN1\_SEL (P0\_R19\_D[3:2]) and PDM\_DIN2\_SEL (P0\_R19\_D[1:0]). When using GPI1, make sure that the GPI1 function is enabled using the GPI1\_CFG (P0\_R13[1]). This single data line can be shared by two digital microphones to place their data on the opposite edge of PDMCLK. Internally, the device latches the steady value of the data on either the rising or falling edge of PDMCLK based on the configuration register bits set in PDMx1\_EDGE

(P0\_R19\_D[4]) and PDMDIN2\_EDGE (P0\_R19\_D[5]). [Figure 6-19](#) shows the digital PDM microphone interface timing diagram.

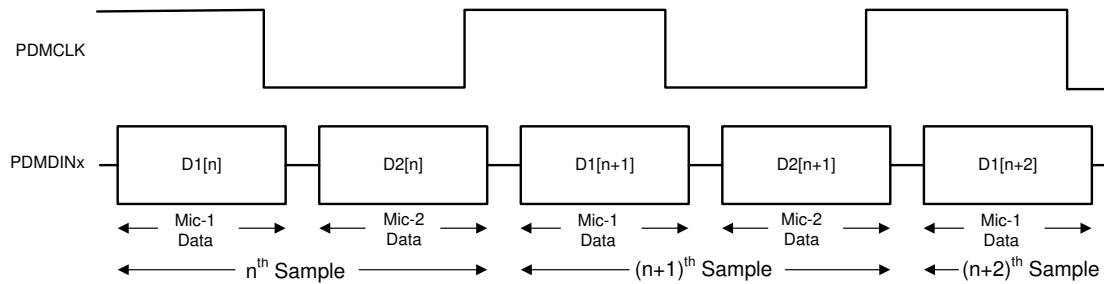

**Figure 6-19. Digital PDM Microphone Protocol Timing Diagram**

Use the PDM\_CH1\_SEL[1:0] (P0\_R19\_D[7]) and PDM\_CH2\_SEL[1:0] (P0\_R19\_D[6]) register bits to enable the digital microphone for channel 1 to channel 2 respectively.

### **6.3.7 Signal-Chain Processing**

The TAD5212 signal chain is comprised of very-low-noise, high-performance, and low-power analog blocks and highly flexible and programmable digital processing blocks. The high performance and flexibility combined with a compact package makes the TAD5212 optimized for a variety of end-equipments and applications that require multichannel audio playback. [Section 6.3.7.1](#) describe key components in DAC signal chain further.

### 6.3.7.1 DAC Signal-Chain

Figure 6-20 shows the key components of the playback signal chain.

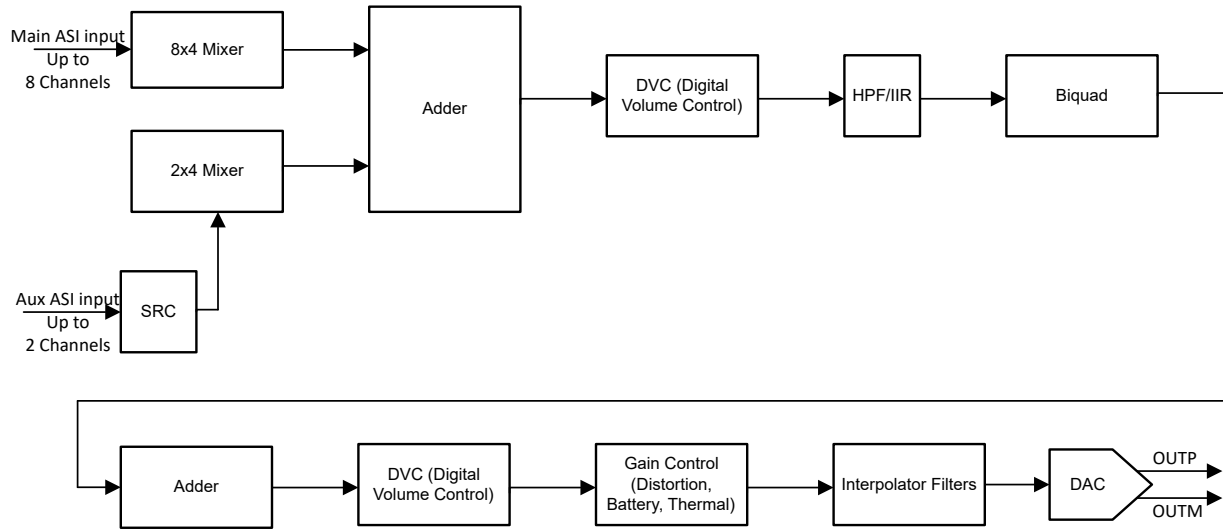

**Figure 6-20. DAC Signal-Chain Processing Flowchart**

The DAC signal chain offers a highly flexible low noise playback path for low noise and high-fidelity audio applications. This low-noise and low-distortion, multibit, delta-sigma DAC enables the TAD5212 to achieve 120dB dynamic range in a very low power. Moreover, the DAC architecture has inherent antialias filtering with a high rejection of out-of-band frequency noise around multiple modulator frequency components. Therefore, the device prevents noise from aliasing into the audio band. Further on in the signal chain, an integrated, high-performance multistage digital interpolation filter sharply cuts off any out-of-band frequency noise with high stop-band attenuation.

The signal chain also consists of various highly programmable digital processing blocks such as biquad filters, phase calibration, gain calibration, high-pass filter, digital summer or mixer, synchronous sample rate converter, distortion limiter, thermal foldback, brownout prevention and volume control. The details on these processing blocks are discussed further in this section. The device also supports up to four channel single-ended output modes and an analog bypass option from analog input to DAC output.

The output channels for playback can be enabled or disabled by using the CH\_EN (P0\_R118) register, and the input channels for the audio serial interface can be enabled or disabled by using the PASI\_RX\_CHx\_CFG or SASI\_RX\_CHx\_CFG bits. The device supports simultaneous power-up and power-down of all active channels for simultaneous playback. However, based on the application needs, if some channels must be powered-up or powered-down dynamically when the other channel playback is on, then that use case is supported by setting the DYN\_PUPD\_CFG (P0\_R119) register.

The device supports multiple data mixing options where up to 8 Input Channels from Main ASI, 2 Input Channels from Aux ASI, ADC loopback data, and tone generator can be mixed with flexible gain options for each path before playback on DAC output. By default, these mixers are disabled and channels are configured for only one channel of data. Mixers can be configured by setting ASI\_DIN\_Mixers programmable coefficient registers described in Register Map B0\_P17.

The device supports an output signal bandwidth of up to 90kHz, which allows the high-frequency non-audio signal to be played by using a 216kHz (or higher) sample rate. Wideband mode can be enabled or disabled by using the DAC\_CHx\_BW\_Mode bit (P0\_R101\_D[0], P0\_R108\_D[0]).

For sample rates of 48kHz or lower, the device supports all features and various programmable processing blocks. However, for sample rates higher than 48kHz, there are limitations in the number of simultaneous channel recordings and playback supported and the number of biquad filters and such. See the [TAC5212 Sampling Rates and Programmable Processing Blocks Supported application report](#) for further details.

The following section describes the key blocks of the DAC signal chain. More details on various other blocks of the DAC signal chain are available in application notes listed in [Section 9.1.1](#).

#### 6.3.7.1.1 Programmable Channel Gain and Digital Volume Control

The device has an independent programmable channel gain setting for each output channel that can be set to the appropriate value based on the maximum input signal expected in the system. This can be done by configuring OUT1x\_LVL\_CTRL and OUT2x\_LVL\_CTRL bits. Coarse gain configuration from -12dB to +12dB is available with these controls in steps of 6dB.

The device has a programmable digital volume control with a range from -100dB to 27dB in steps of 0.5dB with the option to mute the channel recording. The digital volume control value can be changed dynamically while the DAC channel is powered-up and playing. During volume control changes, the soft ramp-up or ramp-down volume feature is used internally to avoid any audible artifacts. Soft-stepping can be entirely disabled using the DAC\_DSP\_DISABLE\_SOFT\_STEP (P0\_R115\_D[1]) register bit.

The digital volume control setting is independently available for each of the 4 single-ended output channels. In the case of 2-Channel Differential DAC, only settings for DAC\_CH1A and DAC\_CH2A are applicable. The device also supports an option to gang up the volume control setting for all channels together using the channel 1A digital volume control setting, regardless if channel 1A is powered up or powered down. This gang-up can be enabled using the DAC\_DSP\_DVOL\_GANG (P0\_R115\_D[0]) register bit.

[Table 6-13](#) shows the programmable options available for the digital volume control.

**Table 6-13. Digital Volume Control (DVC) Programmable Settings**

P0_R103_D[7:0] : DAC_CH1A_DVOL[7:0]	DVC SETTING FOR OUTPUT CHANNEL 1A
0000 0000 = 0d	Output channel 1 DVC is set to mute
0000 0001 = 1d	Output channel 1 DVC is set to -100dB
0000 0010 = 2d	Output channel 1 DVC is set to -99.5dB
0000 0011 = 3d	Output channel 1 DVC is set to -99dB
...	...
1100 1000 = 200d	Output channel 1 DVC is set to -0.5dB
1100 1001 = 201d (default)	Output channel 1 DVC is set to 0dB
1100 1010 = 202d	Output channel 1 DVC is set to 0.5dB
...	...
1111 1101 = 253d	Output channel 1 DVC is set to 26dB
1111 1110 = 254d	Output channel 1 DVC is set to 26.5dB
1111 1111 = 255d	Output channel 1 DVC is set to 27dB

Similarly, the digital volume control setting for output channels 1B, 2A, and 2B can be configured using the CH1B\_DVOL (P0\_R103) to CH2B\_DVOL (P0\_R112) register bits, respectively.

The internal digital processing engine soft ramps up the volume from a muted level to the programmed volume level when the channel is powered up, and the internal digital processing engine soft ramps down the volume from a programmed volume to mute when the channel is powered down. This soft-stepping of volume is done to prevent abruptly powering up and powering down the playback channel which can cause audible artifacts. This feature can also be entirely disabled using the DAC\_DSP\_DISABLE\_SOFT\_STEP (P0\_R115\_D[1]) register bit.

#### 6.3.7.1.2 Programmable Channel Gain Calibration

Along with the digital volume control, this device also provides programmable channel gain calibration. The gain of each channel can be finely calibrated or adjusted in steps of 0.1dB for a range of -0.8dB to 0.7dB gain error. This adjustment is useful when trying to match the gain across channels resulting from transducer sensitivity and load impedance mismatch. This feature, in combination with the regular digital volume control, allows the gains across all channels to be matched for a wide gain error range with a resolution of 0.1dB. [Table 6-14](#) shows the programmable options available for the channel gain calibration.

**Table 6-14. DAC Channel Gain Calibration Programmable Settings**

P0_R104_D[7:4] : DAC_CH1A_FGAIN[3:0]	CHANNEL GAIN CALIBRATION SETTING FOR INPUT CHANNEL 1A
0000 = 0d	Input channel 1 gain calibration is set to -0.8 dB
0001 = 1d	Input channel 1 gain calibration is set to -0.7 dB
...	...
1000 = 8d (default)	Input channel 1 gain calibration is set to 0 dB
...	...
1110 = 14d	Input channel 1 gain calibration is set to 0.6 dB
1111 = 15d	Input channel 1 gain calibration is set to 0.7 dB

Similarly, the channel gain calibration setting for input channel 1B, 2A and 2B can be configured using the DAC\_CH1B\_CFG1 (P0\_R106), DAC\_CH2A\_CFG1 (P0\_R111), and DAC\_CH2B\_CFG1 (P0\_R113) register bits, respectively.

**6.3.7.1.3 Programmable Digital High-Pass Filter**

To remove the DC offset component and attenuate the undesired low-frequency noise content in the record data, the device supports a programmable high-pass filter (HPF). The HPF is not a channel-independent filter setting but is globally applicable for all DAC channels. This HPF is constructed using the first-order infinite impulse response (IIR) filter, and is efficient enough to filter out possible DC components of the signal. Table 6-15 shows the predefined -3dB cutoff frequencies available that can be set by using the DAC\_DSP\_HPFS\_SEL[1:0] register bits of P0\_R115. Additionally, to achieve a custom -3dB cutoff frequency for a specific application, the device also allows the first-order IIR filter coefficients to be programmed when the DAC\_DSP\_HPFS\_SEL[1:0] register bits are set to 2'b00. Figure 6-21 illustrates a frequency response plot for the HPF filter.

**Table 6-15. HPF Programmable Settings**

P0_R115_D[5:4] : DAC_DSP_HPFS_SEL[1:0]	-3dB CUTOFF FREQUENCY SETTING	-3dB CUTOFF FREQUENCY AT 16kHz SAMPLE RATE	-3dB CUTOFF FREQUENCY AT 48-kHz SAMPLE RATE
00	Programmable 1st-order IIR filter	Programmable 1st-order IIR filter	Programmable 1st-order IIR filter
01 (default)	$0.00002 \times f_s$	0.25 Hz	1 Hz
10	$0.00025 \times f_s$	4 Hz	12 Hz
11	$0.002 \times f_s$	32 Hz	96 Hz

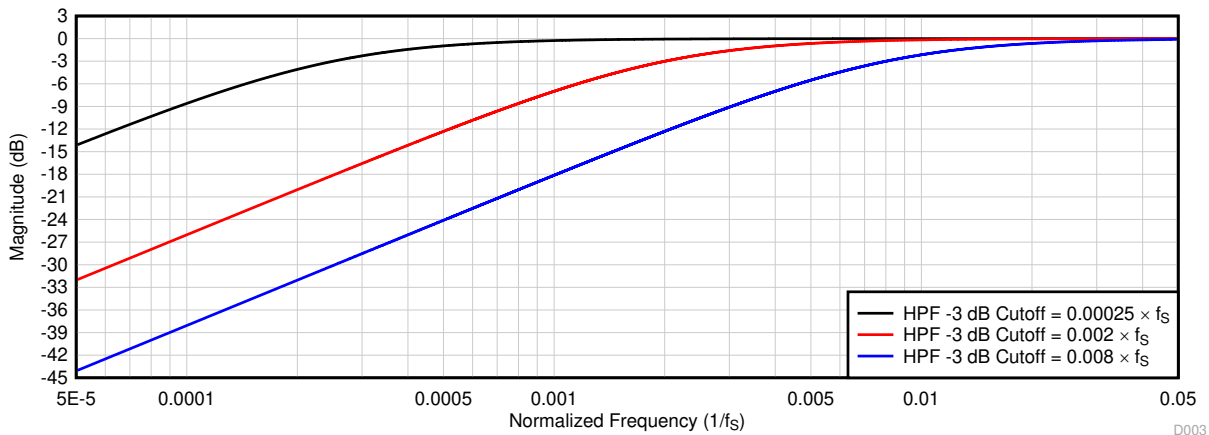

**Figure 6-21. HPF Filter Frequency Response Plot**

Equation 1 gives the transfer function for the first-order programmable IIR filter:

$$H(z) = \frac{N_0 + N_1 z^{-1}}{2^{31} - D_1 z^{-1}} \quad (1)$$

The frequency response for this first-order programmable IIR filter with default coefficients is flat at a gain of 0dB (all-pass filter). The host device can override the frequency response by programming the IIR coefficients in [Table 6-16](#) to achieve the desired frequency response for high-pass filtering or any other desired filtering. If DAC\_DSP\_HP\_SEL[1:0] are set to 2'b00, the host device must write these coefficients values for the desired frequency response before powering-up any DAC channel for playback. [Table 6-16](#) shows the filter coefficients for the first-order IIR filter.

**Table 6-16. 1st-Order IIR Filter Coefficients**

FILTER	FILTER COEFFICIENT	DEFAULT COEFFICIENT VALUE	COEFFICIENT REGISTER MAPPING
Programmable 1st-order IIR filter (can be allocated to HPF or any other desired filter)	N <sub>0</sub>	0x7FFFFFFF	P17_R120-R124
	N <sub>1</sub>	0x00000000	P17_R125-R128
	D <sub>1</sub>	0x00000000	P18_R8-R11

#### 6.3.7.1.4 Programmable Digital Biquad Filters

The device supports up to 12 programmable digital biquad filters available for DAC signal chain limited to 3/channel. These highly efficient filters achieve the desired frequency response. The TAD5212 also supports on the fly programmable Biquad filters for two channel playback use case. In digital signal processing, a digital biquad filter is a second-order, recursive linear filter with two poles and two zeros. [Equation 4](#) gives the transfer function of each biquad filter:

$$H(z) = \frac{N_0 + 2N_1 z^{-1} + N_2 z^{-2}}{2^{31} - 2D_1 z^{-1} - D_2 z^{-2}} \quad (2)$$

The frequency response for the biquad filter section with default coefficients is flat at a gain of 0dB (all-pass filter). The host device can override the frequency response by programming the biquad coefficients to achieve the desired frequency response for a low-pass, high-pass, or any other desired frequency shaping. The programmable coefficients for the biquads are located in the programmable coefficient registers in B0\_P15 and B0\_P16. If biquad filtering is required, then the host device must write these coefficients values before powering up any ADC channels for recording or DAC channels for playback. In two channel use case, the TAD5212 also supports on the fly programmable filters. In this case, the device uses two banks of filters for one channel with a switch bit to perform the switch from one filter bank to the other. As described in [Table 6-17](#), these biquad filters can be allocated for each output channel based on the DAC\_DSP\_BQ\_CFG[1:0] register setting of P0\_R115. By setting DAC\_DSP\_BQ\_CFG[1:0] to 2'b00, the biquad filtering for all playback channels are disabled and the host device can choose this setting if no additional filtering is required for the system application. See the [TAC5x1x and TAC5x1x-Q1 Programmable Biquad Filters - Configuration and Applications application report](#) for further details.

**Table 6-17. Biquad Filter Allocation to the Record Output Channel**

PROGRAMMABLE BIQUAD FILTER	PLAYBACK OUTPUT CHANNEL ALLOCATION USING P0_R115_D[3:2] REGISTER SETTING		
	DAC_DSP_BQ_CFG[1:0] = 2'b01 (1 Biquad per Channel)	DAC_DSP_BQ_CFG[1:0] = 2'b10 (Default) (2 Biquads per Channel)	DAC_DSP_BQ_CFG[1:0] = 2'b11 (3 Biquads per Channel)
Biquad filter 1	Allocated to output channel 1	Allocated to output channel 1	Allocated to output channel 1
Biquad filter 2	Allocated to output channel 2	Allocated to output channel 2	Allocated to output channel 2
Biquad filter 3	Allocated to output channel 3	Allocated to output channel 3	Allocated to output channel 3
Biquad filter 4	Allocated to output channel 4	Allocated to output channel 4	Allocated to output channel 4
Biquad filter 5	Not used	Allocated to output channel 1	Allocated to output channel 1
Biquad filter 6	Not used	Allocated to output channel 2	Allocated to output channel 2



**Table 6-17. Biquad Filter Allocation to the Record Output Channel (continued)**

PROGRAMMABLE BIQUAD FILTER	PLAYBACK OUTPUT CHANNEL ALLOCATION USING P0_R115_D[3:2] REGISTER SETTING		
	DAC_DSP_BQ_CFG[1:0] = 2'b01 (1 Biquad per Channel)	DAC_DSP_BQ_CFG[1:0] = 2'b10 (Default) (2 Biquads per Channel)	DAC_DSP_BQ_CFG[1:0] = 2'b11 (3 Biquads per Channel)
Biquad filter 7	Not used	Allocated to output channel 3	Allocated to output channel 3
Biquad filter 8	Not used	Allocated to output channel 4	Allocated to output channel 4
Biquad filter 9	Not used	Not used	Allocated to output channel 1
Biquad filter 10	Not used	Not used	Allocated to output channel 2
Biquad filter 11	Not used	Not used	Allocated to output channel 3
Biquad filter 12	Not used	Not used	Allocated to output channel 4

Table 6-18 shows the biquad filter coefficients mapping to the register space.

**Table 6-18. Biquad Filter Coefficients Register Mapping**

PROGRAMMABLE BIQUAD FILTER	BIQUAD FILTER COEFFICIENTS REGISTER MAPPING	PROGRAMMABLE BIQUAD FILTER	BIQUAD FILTER COEFFICIENTS REGISTER MAPPING
Biquad filter 1	P16_R8-R27	Biquad filter 7	P17_R8-R27
Biquad filter 2	P16_R28-R47	Biquad filter 8	P17_R28-R47
Biquad filter 3	P16_R48-R67	Biquad filter 9	P17_R48-R67
Biquad filter 4	P16_R68-R87	Biquad filter 10	P17_R68-R87
Biquad filter 5	P16_R88-R107	Biquad filter 11	P17_R88-R107
Biquad filter 6	P16_R108-R127	Biquad filter 12	P17_R108-R127

### 6.3.7.1.5 Configurable Digital Interpolation Filters

The device playback channel includes a high dynamic range, built-in digital interpolation filter to process the input data stream to generate digital data stream for multibit delta-sigma ( $\Delta\Sigma$ ) modulator. The interpolation filter can be chosen from four different types, depending on the required frequency response, group delay, power consumption, and phase linearity requirements for the target application. The selection of the interpolation filter option can be done by configuring the DAC\_DSP\_INTX\_FILT (P0\_R115\_D[7:6]) register bits. Low power filter can be configured by setting DAC\_LOW\_PWR\_FILT (P0\_R79\_D[2]) bit. Table 6-19 shows the configuration register setting for the decimation filter mode selection for the record channel.

**Table 6-19. Interpolation Filter Mode Selection for the Playback Channel**

P0_R79_D[2] : DAC_LOW_PWR_FILT	P0_R115_D[7:6] : DAC_DSP_INTX_FILT[1:0]	INTERPOLATION FILTER MODE SELECTION
0	00 (default)	Linear phase filters are used for the interpolation
0	01	Low latency filters are used for the interpolation
0	10	Ultra-low latency filters are used for the interpolation
0	11	Reserved (do not use this setting)
1	XX	Low power filters are used for the interpolation

#### 6.3.7.1.5.1 Linear-phase filters

The linear-phase interpolation filters are the default filters set by the device and can be used for all applications that require a perfect linear phase with zero-phase deviation within the pass-band specification of the filter. The filter performance specifications and various plots for all supported output sampling rates are listed in this section.

##### 6.3.7.1.5.1.1 Sampling Rate: 8kHz or 7.35kHz

Figure 6-22 and Figure 6-23 respectively show the magnitude response and the pass-band ripple for this interpolation filter with a sampling rate of 8kHz or 7.35kHz, and Table 6-20 lists its specifications.

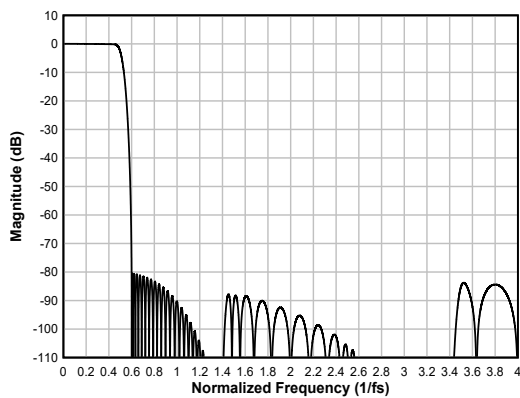

**Figure 6-22. Linear-phase Interpolation Filter Magnitude Response**

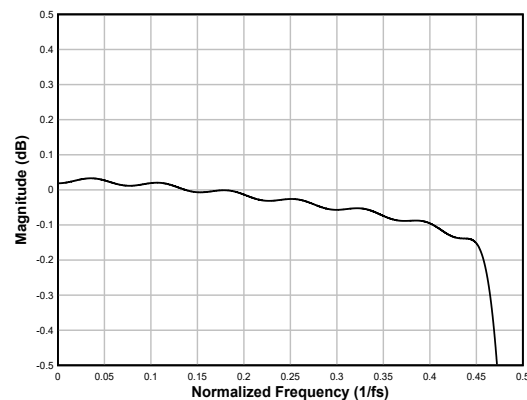

**Figure 6-23. Linear-phase Interpolation Filter Pass-Band Ripple**

**Table 6-20. Linear-phase Interpolation Filter Specifications**

PARAMETER	TEST CONDITIONS	MIN	TYP	MAX	UNIT
Pass-band ripple	Frequency range is 0 to $0.455 \times f_s$	-0.17		0.03	dB
Stop-band attenuation	Frequency range is $0.6 \times f_s$ to $4 \times f_s$	80.4			dB
	Frequency range is $4 \times f_s$ to $7.431 \times f_s$	86.9			
Group delay or latency	Frequency range is 0 to $0.455 \times f_s$		16		$1/f_s$

**6.3.7.1.5.1.2 Sampling Rate: 16kHz or 14.7kHz**

Figure 6-24 and Figure 6-25 respectively show the magnitude response and the pass-band ripple for this interpolation filter with a sampling rate of 16kHz or 14.7kHz, and Table 6-21 lists its specifications.

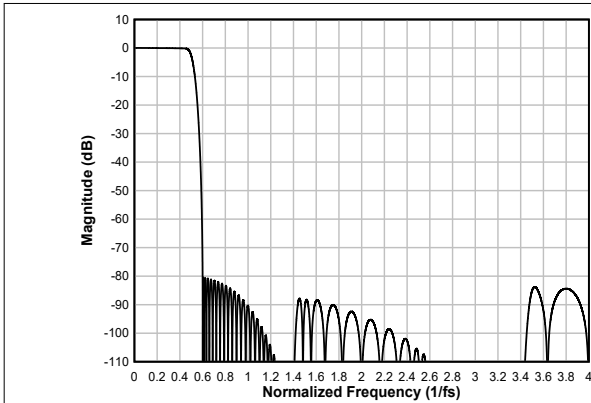

**Figure 6-24. Linear-phase Interpolation Filter Magnitude Response**

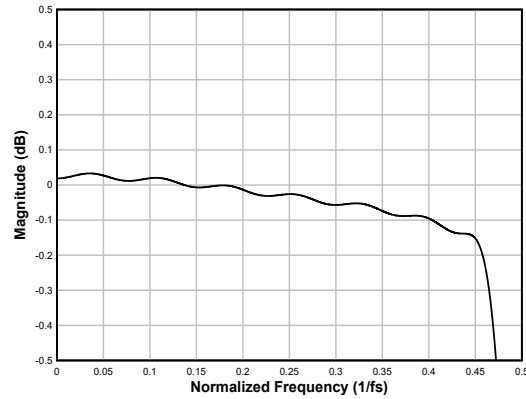

**Figure 6-25. Linear-phase Interpolation Filter Pass-Band Ripple**

**Table 6-21. Linear-phase Interpolation Filter Specifications**

PARAMETER	TEST CONDITIONS	MIN	TYP	MAX	UNIT
Pass-band ripple	Frequency range is 0 to $0.455 \times f_s$	-0.17		0.03	dB
Stop-band attenuation	Frequency range is $0.6 \times f_s$ to $4 \times f_s$	80.4			dB
	Frequency range is $4 \times f_s$ to $7.431 \times f_s$	86.9			
Group delay or latency	Frequency range is 0 to $0.455 \times f_s$		16		$1/f_s$

**6.3.7.1.5.1.3 Sampling Rate: 24kHz or 22.05kHz**

Figure 6-26 and Figure 6-27 respectively show the magnitude response and the pass-band ripple for this interpolation filter with a sampling rate of 24kHz or 22.05kHz, and Table 6-22 lists its specifications.

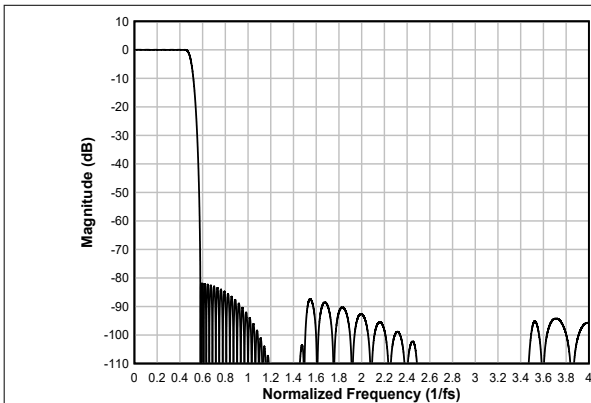

**Figure 6-26. Linear-phase Interpolation Filter Magnitude Response**

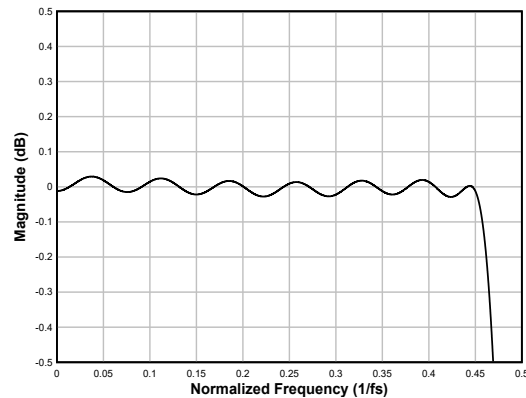

**Figure 6-27. Linear-phase Interpolation Filter Pass-Band Ripple**

**Table 6-22. Linear-phase Interpolation Filter Specifications**

PARAMETER	TEST CONDITIONS	MIN	TYP	MAX	UNIT
Pass-band ripple	Frequency range is 0 to $0.455 \times f_s$	-0.05		0.03	dB
Stop-band attenuation	Frequency range is $0.58 \times f_s$ to $4 \times f_s$	81.9			dB
	Frequency range is $4 \times f_s$ to $8 \times f_s$	87.7			

**Table 6-22. Linear-phase Interpolation Filter Specifications (continued)**

PARAMETER	TEST CONDITIONS	MIN	TYP	MAX	UNIT
Group delay or latency	Frequency range is 0 to $0.455 \times f_S$		17.6		$1/f_S$

**6.3.7.1.5.1.4 Sampling Rate: 32kHz or 29.4kHz**

Figure 6-28 and Figure 6-29 respectively show the magnitude response and the pass-band ripple for this interpolation filter with a sampling rate of 32kHz or 29.4kHz, and Table 6-23 lists its specifications.

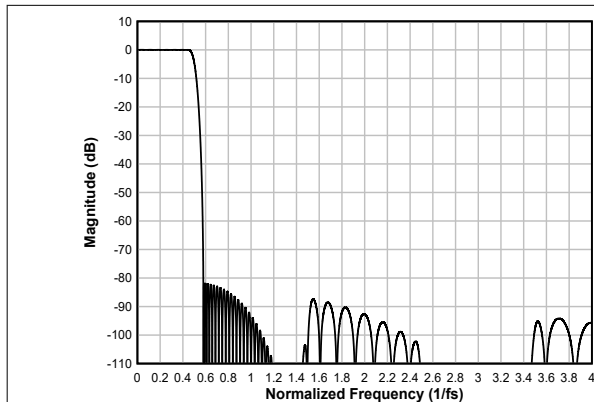
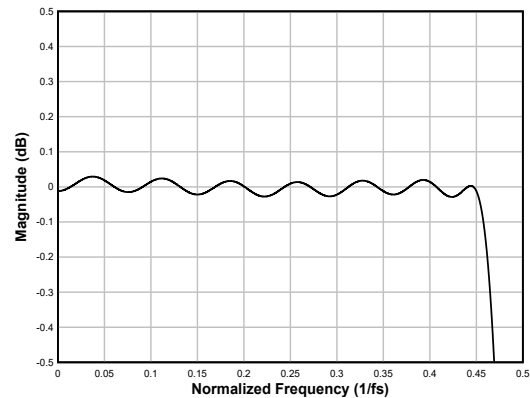
**Figure 6-28. Linear-phase Interpolation Filter Magnitude Response****Figure 6-29. Linear-phase Interpolation Filter Pass-Band Ripple****Table 6-23. Linear-phase Interpolation Filter Specifications**

PARAMETER	TEST CONDITIONS	MIN	TYP	MAX	UNIT
Pass-band ripple	Frequency range is 0 to $0.455 \times f_S$	-0.05		0.03	dB
Stop-band attenuation	Frequency range is $0.58 \times f_S$ to $4 \times f_S$	81.9			
	Frequency range is $4 \times f_S$ to $8 \times f_S$	87.6			
Group delay or latency	Frequency range is 0 to $0.455 \times f_S$		17.6		$1/f_S$

**6.3.7.1.5.1.5 Sampling Rate: 48kHz or 44.1kHz**

Figure 6-30 and Figure 6-31 respectively show the magnitude response and the pass-band ripple for this interpolation filter with a sampling rate of 48kHz or 44.1kHz, and Table 6-24 lists its specifications.

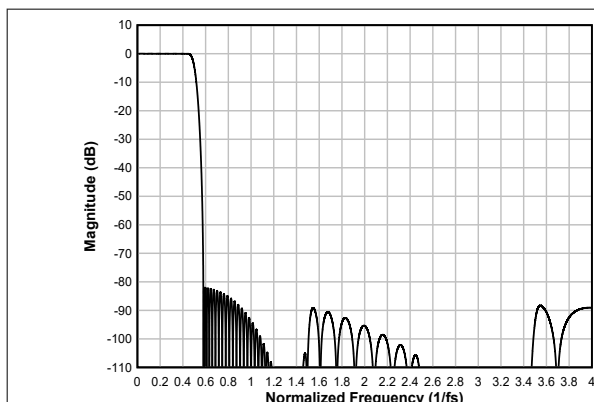
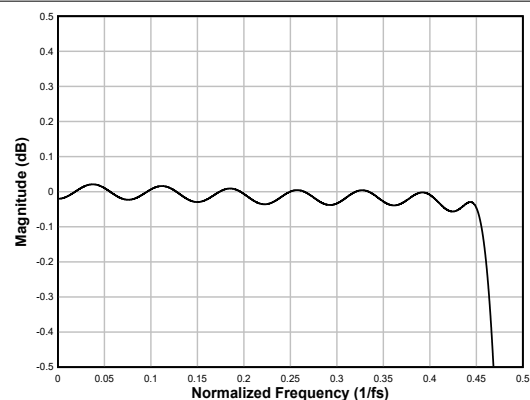
**Figure 6-30. Linear-phase Interpolation Filter Magnitude Response****Figure 6-31. Linear-phase Interpolation Filter Pass-Band Ripple**

**Table 6-24. Linear-phase Interpolation Filter Specifications**

PARAMETER	TEST CONDITIONS	MIN	TYP	MAX	UNIT
Pass-band ripple	Frequency range is 0 to $0.455 \times f_S$	-0.09		0.02	dB
Stop-band attenuation	Frequency range is $0.58 \times f_S$ to $4 \times f_S$	82			dB
	Frequency range is $4 \times f_S$ to $7.423 \times f_S$	89.1			
Group delay or latency	Frequency range is 0 to $0.455 \times f_S$		17.3		$1/f_S$

**6.3.7.1.5.1.6 Sampling Rate: 96kHz or 88.2kHz**

Figure 6-32 and Figure 6-33 respectively show the magnitude response and the pass-band ripple for this interpolation filter with a sampling rate of 96kHz or 88.2kHz, and Table 6-25 lists its specifications.

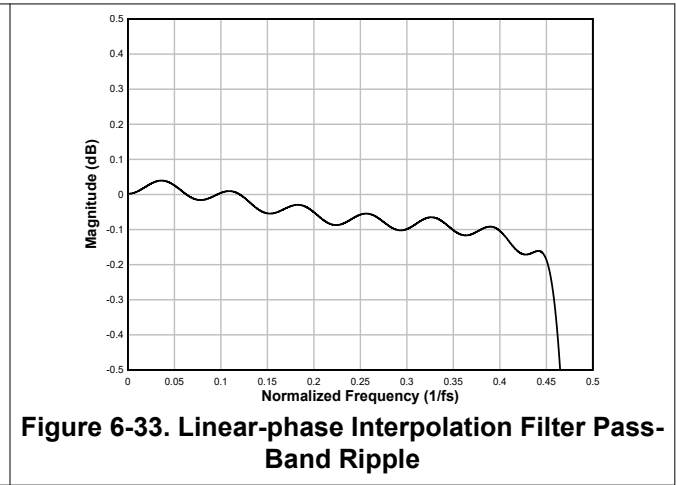
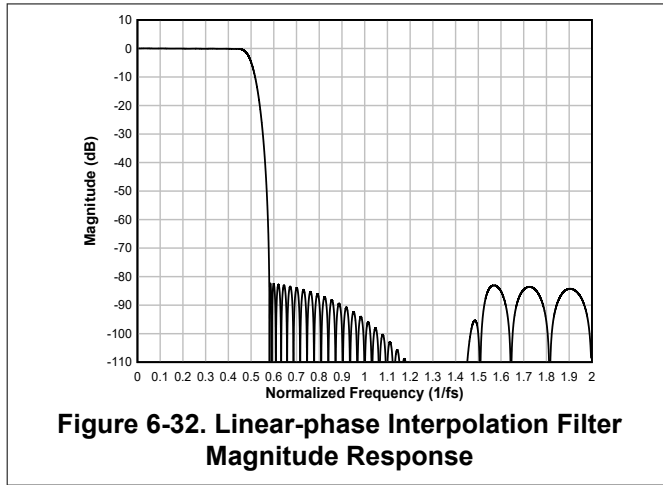
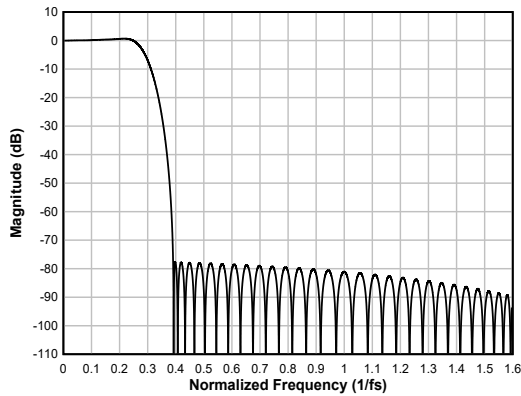

**Table 6-25. Linear-phase Interpolation Filter Specifications**

PARAMETER	TEST CONDITIONS	MIN	TYP	MAX	UNIT
Pass-band ripple	Frequency range is 0 to $0.455 \times f_S$	-0.23		0.04	dB
Stop-band attenuation	Frequency range is $0.58 \times f_S$ to $2 \times f_S$	82.4			dB
	Frequency range is $2 \times f_S$ to $3.422 \times f_S$	85.1			
Group delay or latency	Frequency range is 0 to $0.455 \times f_S$		16.7		$1/f_S$

**6.3.7.1.5.1.7 Sampling Rate: 192kHz or 176.4kHz**

Figure 6-34 and Figure 6-35 respectively show the magnitude response and the pass-band ripple for this interpolation filter with a sampling rate of 192kHz or 176.4kHz, and Table 6-26 lists its specifications.



**Figure 6-34. Linear-phase Interpolation Filter Magnitude Response**

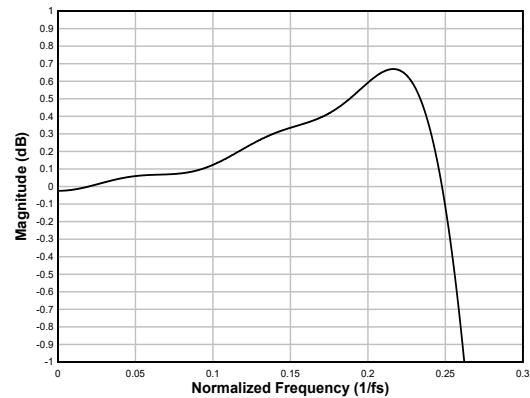

**Figure 6-35. Linear-phase Interpolation Filter Pass-Band Ripple**

**Table 6-26. Linear-phase Interpolation Filter Specifications**

PARAMETER	TEST CONDITIONS	MIN	TYP	MAX	UNIT
Pass-band ripple	Frequency range is 0 to $0.258 \times f_S$	-0.67		0.67	dB
Stop-band attenuation	Frequency range is $0.391 \times f_S$ to $1 \times f_S$	77.7			dB
	Frequency range is $1 \times f_S$ to $1.612 \times f_S$	81.1			
Group delay or latency	Frequency range is 0 to $0.258 \times f_S$		10.7		$1/f_S$

#### 6.3.7.1.5.1.8 Sampling Rate: 384kHz or 352.8kHz

Figure 6-36 and Figure 6-37 respectively show the magnitude response and the pass-band ripple for this interpolation filter with a sampling rate of 384kHz or 352.8kHz, and Table 6-27 lists its specifications.

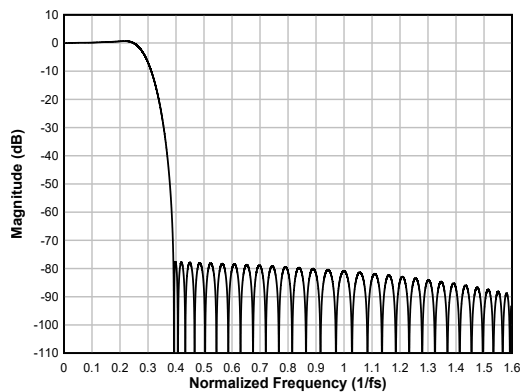

**Figure 6-36. Linear-phase Interpolation Filter Magnitude Response**

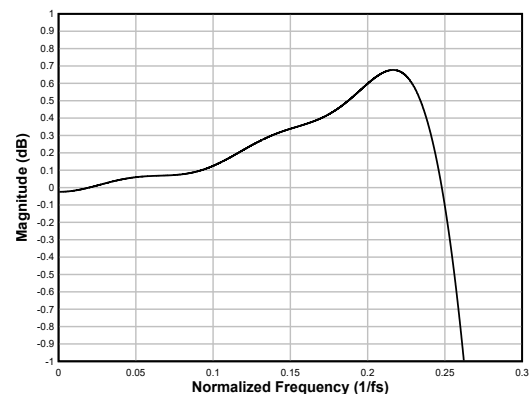

**Figure 6-37. Linear-phase Interpolation Filter Pass-Band Ripple**

**Table 6-27. Linear-phase Interpolation Filter Specifications**

PARAMETER	TEST CONDITIONS	MIN	TYP	MAX	UNIT
Pass-band ripple	Frequency range is 0 to $0.258 \times f_S$	-0.67		0.67	dB
Stop-band attenuation	Frequency range is $0.391 \times f_S$ to $1 \times f_S$	77.7			dB
	Frequency range is $1 \times f_S$ to $1.612 \times f_S$	81.1			
Group delay or latency	Frequency range is 0 to $0.258 \times f_S$		10.7		$1/f_S$

**6.3.7.1.5.1.9 Sampling Rate 768kHz or 705.6kHz**

Figure 6-38 and Figure 6-39 respectively show the magnitude response and the pass-band ripple for this interpolation filter with a sampling rate of 768kHz or 705.6kHz, and Table 6-28 lists its specifications.

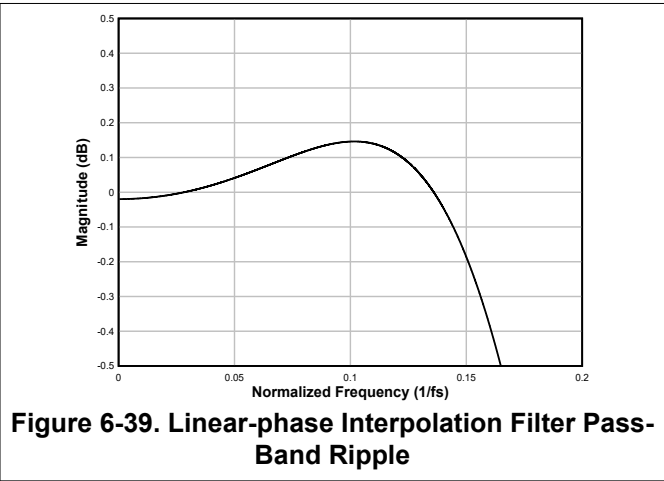
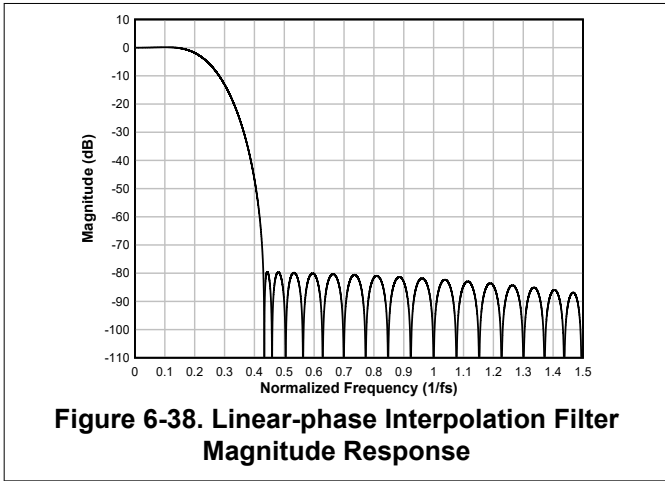

**Table 6-28. Linear-phase Interpolation Filter Specifications**

PARAMETER	TEST CONDITIONS	MIN	TYP	MAX	UNIT
Pass-band ripple	Frequency range is 0 to $0.153 \times f_s$	-0.15		0.15	dB
Stop-band attenuation	Frequency range is $0.43 \times f_s$ to $1 \times f_s$	79.1			dB
	Frequency range is $1 \times f_s$ onwards	82.2			
Group delay or latency	Frequency range is 0 to $0.113 \times f_s$		5.9		$1/f_s$

### 6.3.7.1.5.2 Low-latency Filters

For applications where low latency with minimal phase deviation (within the audio band) is critical, the low-latency interpolation filters on the TAD5212 can be used. The device supports these filters with a group delay of approximately seven samples with an almost linear phase response within the  $0.376 \times f_S$  frequency band. This section provides the filter performance specifications and various plots for all supported output sampling rates for the low-latency filters.

#### 6.3.7.1.5.2.1 Sampling Rate: 24kHz or 22.05kHz

Figure 6-40 shows the magnitude response and Figure 6-41 shows the pass-band ripple and phase deviation for this interpolation filter with a sampling rate of 24kHz or 22.05kHz. Table 6-29 lists its specifications.

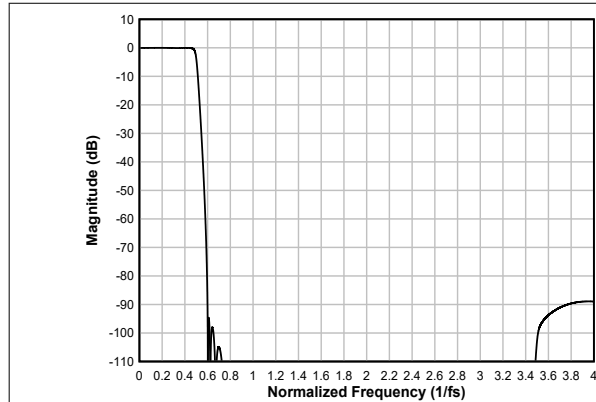

**Figure 6-40. Low-latency Interpolation Filter Magnitude Response**

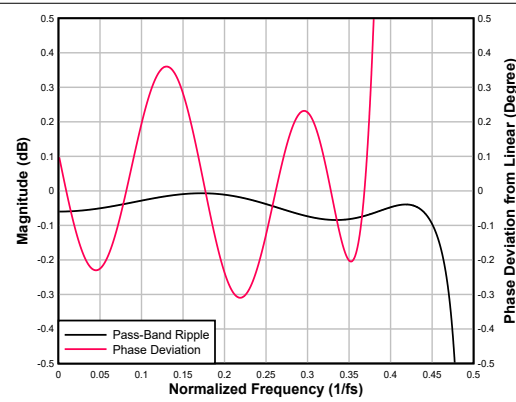

**Figure 6-41. Low-latency Interpolation Filter Pass-Band Ripple and Phase Deviation**

**Table 6-29. Low-latency Interpolation Filter Specifications**

PARAMETER	TEST CONDITIONS	MIN	TYP	MAX	UNIT
Pass-band ripple	Frequency range is 0 to $0.455 \times f_S$	-0.12		-0.01	dB
Stop-band attenuation	Frequency range is $0.599 \times f_S$ to $4 \times f_S$	88.9			dB
	Frequency range is $4 \times f_S$ to $7.414 \times f_S$	89			
Group delay or latency	Frequency range is 0 to $0.376 \times f_S$		7.19		$1/f_S$
Group delay deviation	Frequency range is 0 to $0.376 \times f_S$	-0.088		0.088	$1/f_S$
Phase deviation	Frequency range is 0 to $0.376 \times f_S$	-0.31		0.36	Degrees

#### 6.3.7.1.5.2.2 Sampling Rate: 32kHz or 29.4kHz

Figure 6-42 shows the magnitude response and Figure 6-43 shows the pass-band ripple and phase deviation for this interpolation filter with a sampling rate of 32kHz or 29.4kHz. Table 6-30 lists its specifications.



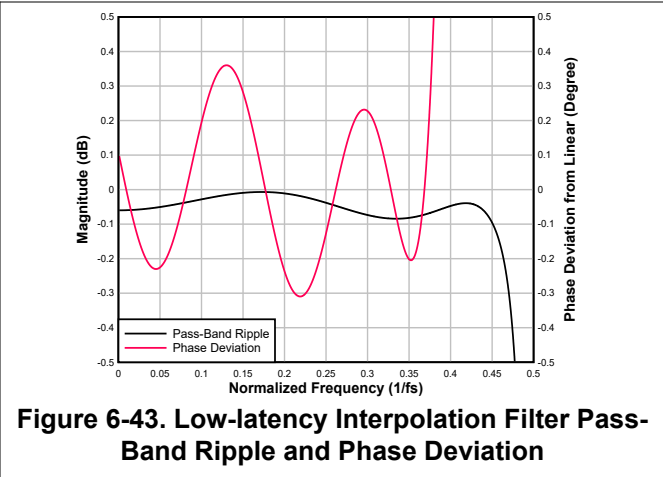
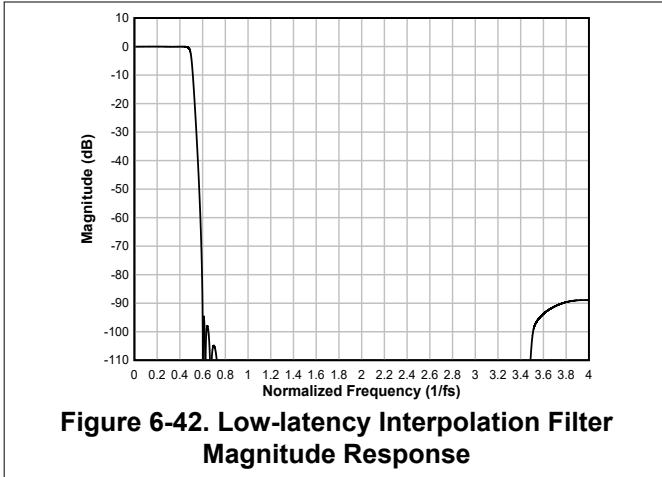
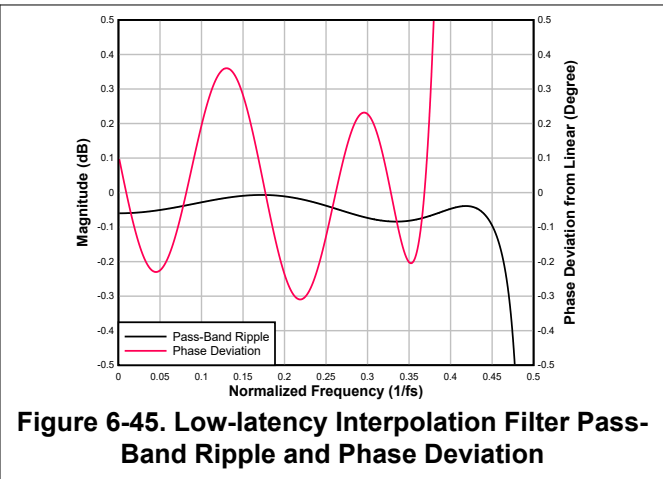
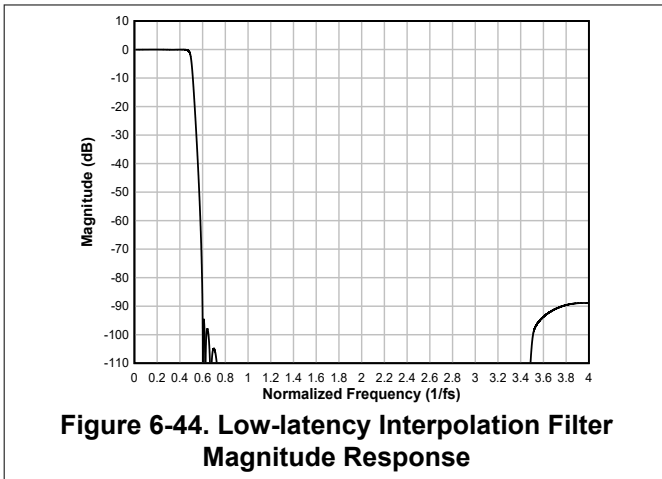

**Table 6-30. Low-latency Interpolation Filter Specifications**

PARAMETER	TEST CONDITIONS	MIN	TYP	MAX	UNIT
Pass-band ripple	Frequency range is 0 to $0.455 \times f_S$	-0.12		-0.01	dB
Stop-band attenuation	Frequency range is $0.599 \times f_S$ to $4 \times f_S$	88.9			dB
	Frequency range is $4 \times f_S$ to $7.414 \times f_S$	89			
Group delay or latency	Frequency range is 0 to $0.376 \times f_S$		7.19		$1/f_S$
Group delay deviation	Frequency range is 0 to $0.376 \times f_S$	-0.088		0.088	$1/f_S$
Phase deviation	Frequency range is 0 to $0.376 \times f_S$	-0.31		0.36	Degrees

**6.3.7.1.5.2.3 Sampling Rate: 48kHz or 44.1kHz**

Figure 6-44 shows the magnitude response and Figure 6-45 shows the pass-band ripple and phase deviation for this interpolation filter with a sampling rate of 48kHz or 44.1kHz. Table 6-31 lists its specifications.



**Table 6-31. Low-latency Interpolation Filter Specifications**

PARAMETER	TEST CONDITIONS	MIN	TYP	MAX	UNIT
Pass-band ripple	Frequency range is 0 to $0.455 \times f_S$	-0.12		-0.01	dB
Stop-band attenuation	Frequency range is $0.599 \times f_S$ to $4 \times f_S$	88.9			dB
	Frequency range is $4 \times f_S$ to $7.414 \times f_S$	89			
Group delay or latency	Frequency range is 0 to $0.376 \times f_S$		7.19		$1/f_S$
Group delay deviation	Frequency range is 0 to $0.376 \times f_S$	-0.088		0.088	$1/f_S$

**Table 6-31. Low-latency Interpolation Filter Specifications (continued)**

PARAMETER	TEST CONDITIONS	MIN	TYP	MAX	UNIT
Phase deviation	Frequency range is 0 to $0.376 \times f_S$	-0.31		0.36	Degrees

**6.3.7.1.5.2.4 Sampling Rate: 96kHz or 88.2kHz**

Figure 6-46 shows the magnitude response and Figure 6-47 shows the pass-band ripple and phase deviation for this interpolation filter with a sampling rate of 96kHz or 88.2kHz. Table 6-32 lists its specifications.

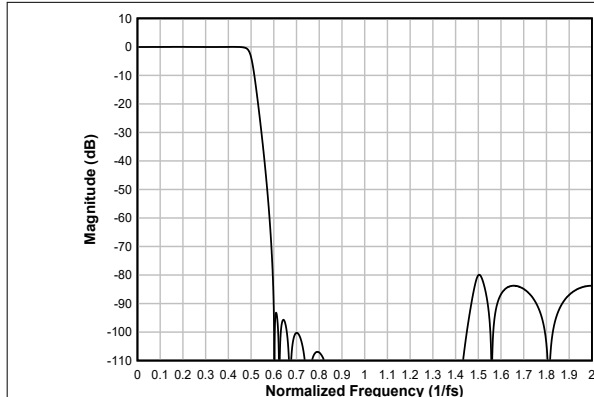
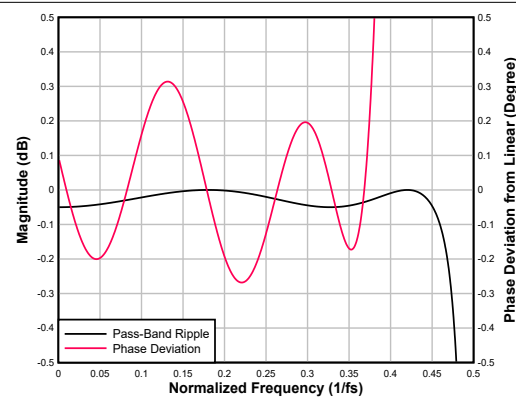
**Figure 6-46. Low-latency Interpolation Filter Magnitude Response****Figure 6-47. Low-latency Interpolation Filter Pass-Band Ripple and Phase Deviation****Table 6-32. Low-latency Interpolation Filter Specifications**

PARAMETER	TEST CONDITIONS	MIN	TYP	MAX	UNIT
Pass-band ripple	Frequency range is 0 to $0.456 \times f_S$	-0.07		0	dB
Stop-band attenuation	Frequency range is $0.595 \times f_S$ to $2 \times f_S$	79.9			dB
	Frequency range is $2 \times f_S$ to $3.405 \times f_S$	79.9			
Group delay or latency	Frequency range is 0 to $0.376 \times f_S$		6.39		$1/f_S$
Group delay deviation	Frequency range is 0 to $0.376 \times f_S$	-0.078		0.022	$1/f_S$
Phase deviation	Frequency range is 0 to $0.376 \times f_S$	-0.268		0.022	Degrees

**6.3.7.1.5.2.5 Sampling Rate: 192kHz or 176.4kHz**

Figure 6-48 shows the magnitude response and Figure 6-49 shows the pass-band ripple and phase deviation for this interpolation filter with a sampling rate of 192kHz or 176.4kHz. Table 6-33 lists its specifications.

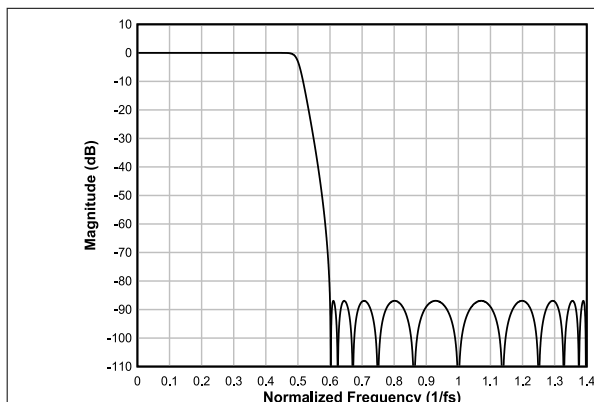
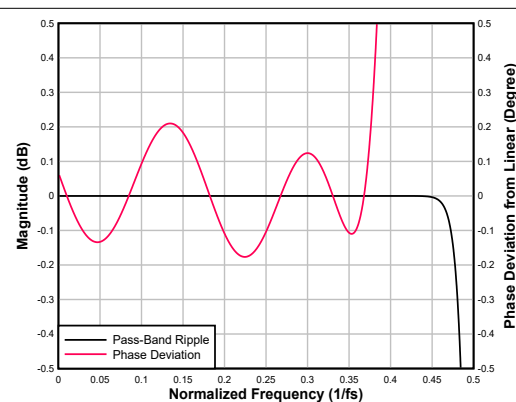
**Figure 6-48. Low-latency Interpolation Filter Magnitude Response****Figure 6-49. Low-latency Interpolation Filter Pass-Band Ripple and Phase Deviation**

**Table 6-33. Low-latency Interpolation Filter Specifications**

PARAMETER	TEST CONDITIONS	MIN	TYP	MAX	UNIT
Pass-band ripple	Frequency range is 0 to $0.452 \times f_S$	-0.005		0	dB
Stop-band attenuation	Frequency range is $0.6 \times f_S$ to $1 \times f_S$	86.9			dB
	Frequency range is $1 \times f_S$ to $1.401 \times f_S$	86.9			
Group delay or latency	Frequency range is 0 to $0.376 \times f_S$		5.41		$1/f_S$
Group delay deviation	Frequency range is 0 to $0.376 \times f_S$	-0.055		0.055	$1/f_S$
Phase deviation	Frequency range is 0 to $0.376 \times f_S$	-0.177		0.21	Degrees

### 6.3.7.1.5.3 Ultra-Low-Latency Filters

For applications where ultra-low latency (within the audio band) is critical, the ultra-low-latency interpolation filters on the TAD5212 can be used. The device supports these filters with a group delay of approximately four samples with an almost linear phase response within the  $0.325 \times f_S$  frequency band. This section provides the filter performance specifications and various plots for all supported output sampling rates for the ultra-low-latency filters.

### 6.3.7.1.5.3.1 Sampling Rate: 24 kHz or 22.05 kHz

Figure 6-50 shows the magnitude response and Figure 6-51 shows the pass-band ripple and phase deviation for an interpolation filter with a sampling rate of 24 kHz or 22.05 kHz. Table 6-34 lists its specifications.

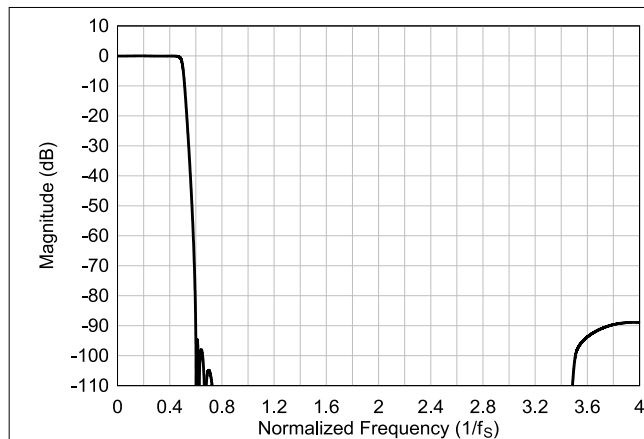

**Figure 6-50. Ultra-Low-Latency interpolation Filter Magnitude Response**

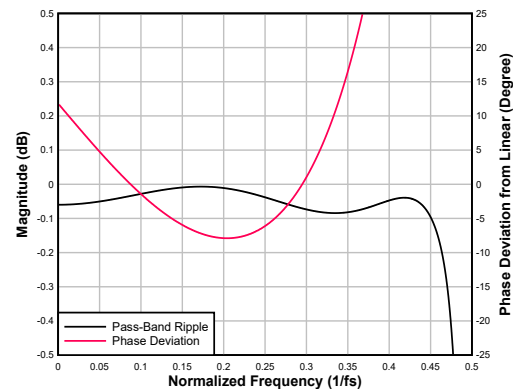

**Figure 6-51. Ultra-Low-Latency interpolation Filter Pass-Band Ripple and Phase Deviation**

**Table 6-34. Ultra-Low-Latency interpolation Filter Specifications**

PARAMETER	TEST CONDITIONS	MIN	TYP	MAX	UNIT
Pass-band ripple	Frequency range is 0 to $0.42 \times f_s$	-0.005		0.01	dB
Stop-band attenuation	Frequency range is $0.6 \times f_s$ to $4 \times f_s$	88.9			dB
	Frequency range is $4 \times f_s$ to $7.41 \times f_s$	88.9			
Group delay or latency	Frequency range is 0 to $0.325 \times f_s$		3.2		$1/f_s$
Group delay deviation	Frequency range is 0 to $0.325 \times f_s$	-0.888		0.363	$1/f_s$
Phase deviation	Frequency range is 0 to $0.325 \times f_s$	-7.9		11.7	Degrees

### 6.3.7.1.5.3.2 Sampling Rate: 32 kHz or 29.4 kHz

Figure 6-52 shows the magnitude response and Figure 6-53 shows the pass-band ripple and phase deviation for an interpolation filter with a sampling rate of 32 kHz or 29.4 kHz. Table 6-35 lists its specifications.

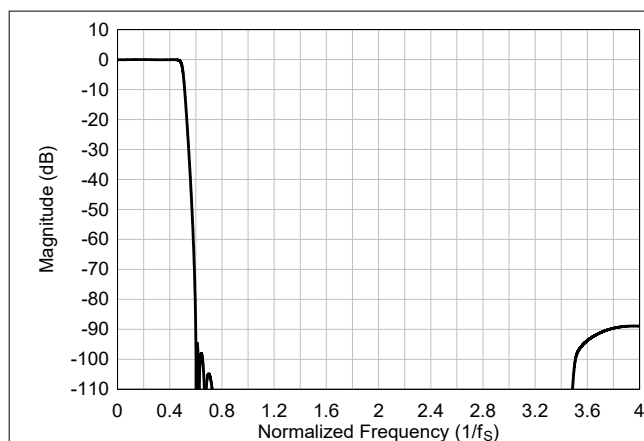

**Figure 6-52. Ultra-Low-Latency interpolation Filter Magnitude Response**

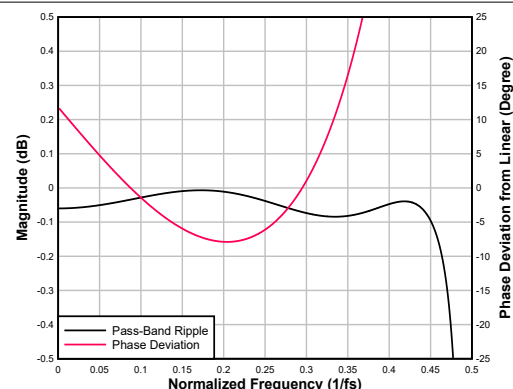

**Figure 6-53. Ultra-Low-Latency interpolation Filter Pass-Band Ripple and Phase Deviation**

**Table 6-35. Ultra-Low-Latency interpolation Filter Specifications**

PARAMETER	TEST CONDITIONS	MIN	TYP	MAX	UNIT
Pass-band ripple	Frequency range is 0 to $0.42 \times f_S$	-0.005		0.01	dB
Stop-band attenuation	Frequency range is $0.6 \times f_S$ to $4 \times f_S$	88.9			dB
	Frequency range is $4 \times f_S$ to $7.41 \times f_S$	88.9			
Group delay or latency	Frequency range is 0 to $0.325 \times f_S$		3.2		$1/f_S$
Group delay deviation	Frequency range is 0 to $0.325 \times f_S$	-0.888		0.363	$1/f_S$
Phase deviation	Frequency range is 0 to $0.325 \times f_S$	-7.9		11.7	Degrees

**6.3.7.1.5.3.3 Sampling Rate: 48 kHz or 44.1 kHz**

Figure 6-54 shows the magnitude response and Figure 6-55 shows the pass-band ripple and phase deviation for an interpolation filter with a sampling rate of 48 kHz or 44.1 kHz. Table 6-36 lists its specifications.

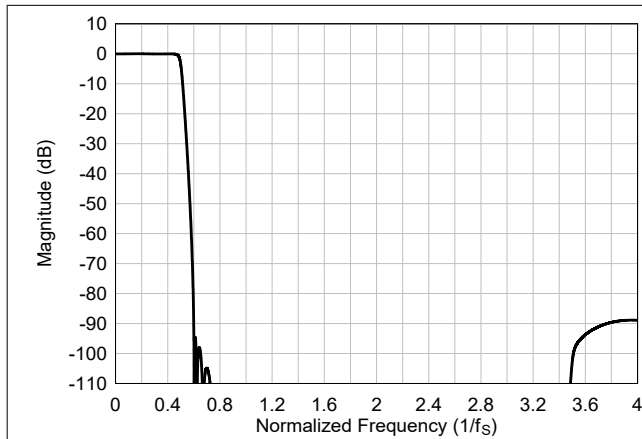

**Figure 6-54. Ultra-Low-Latency interpolation Filter Magnitude Response**

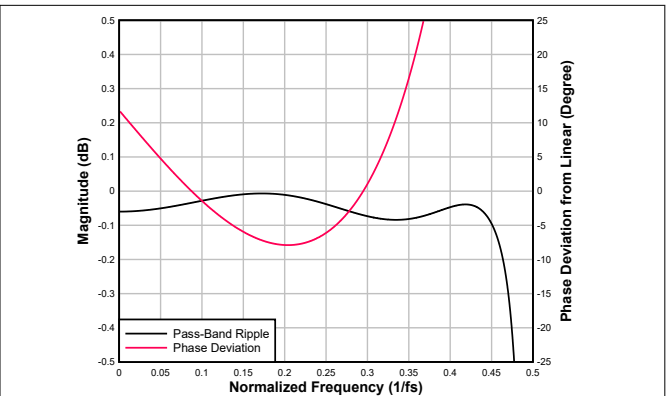

**Figure 6-55. Ultra-Low-Latency interpolation Filter Pass-Band Ripple and Phase Deviation**

**Table 6-36. Ultra-Low-Latency interpolation Filter Specifications**

PARAMETER	TEST CONDITIONS	MIN	TYP	MAX	UNIT
Pass-band ripple	Frequency range is 0 to $0.42 \times f_S$	-0.005		0.01	dB
Stop-band attenuation	Frequency range is $0.6 \times f_S$ to $4 \times f_S$	88.9			dB
	Frequency range is $4 \times f_S$ to $7.41 \times f_S$	88.9			
Group delay or latency	Frequency range is 0 to $0.325 \times f_S$		3.2		$1/f_S$
Group delay deviation	Frequency range is 0 to $0.325 \times f_S$	-0.888		0.363	$1/f_S$
Phase deviation	Frequency range is 0 to $0.325 \times f_S$	-7.9		11.7	Degrees

**6.3.7.1.5.3.4 Sampling Rate: 96 kHz or 88.2 kHz**

Figure 6-56 shows the magnitude response and Figure 6-57 shows the pass-band ripple and phase deviation for a interpolation filter with a sampling rate of 96 kHz or 88.2 kHz. Table 6-37 lists its specifications.

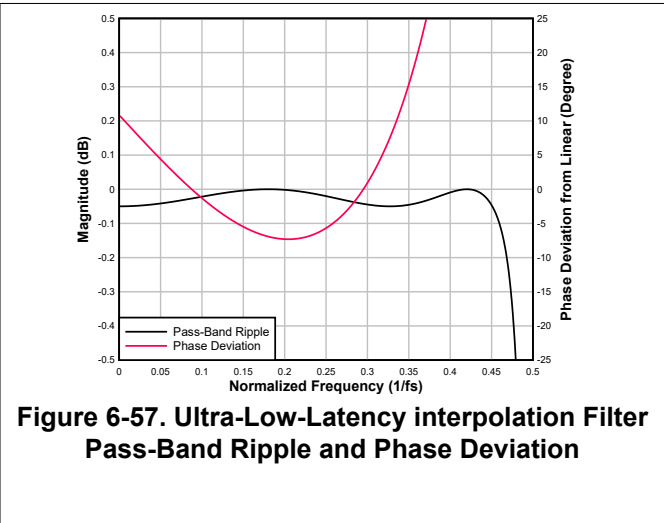
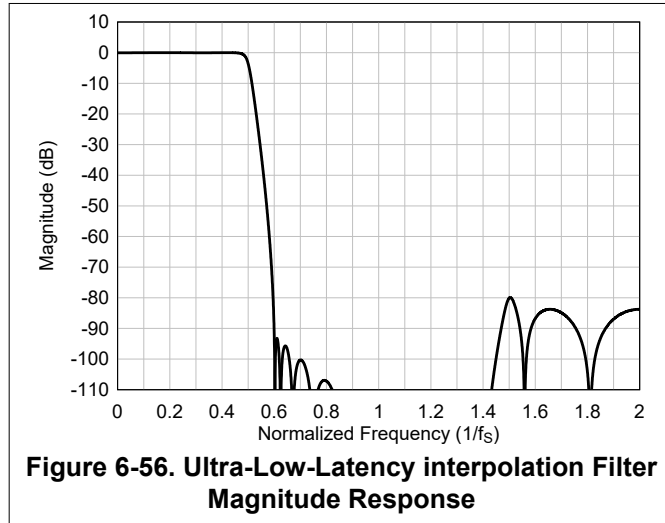
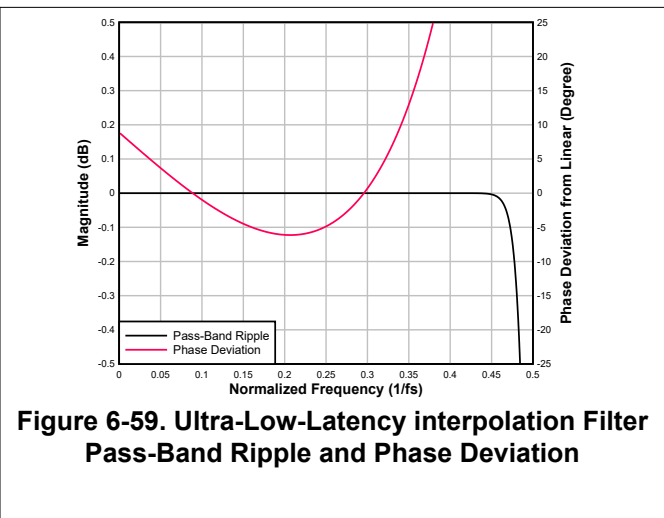
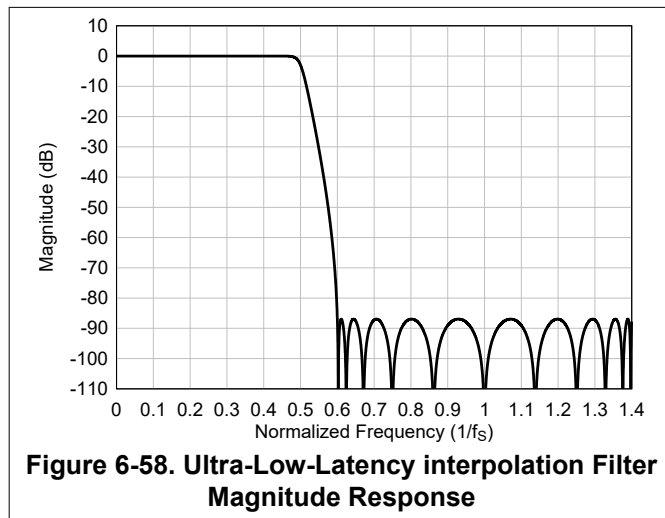

**Table 6-37. Ultra-Low-Latency interpolation Filter Specifications**

PARAMETER	TEST CONDITIONS	MIN	TYP	MAX	UNIT
Pass-band ripple	Frequency range is 0 to $0.45 \times f_s$	-0.05		0.001	dB
Stop-band attenuation	Frequency range is $0.6 \times f_s$ to $2 \times f_s$	80.6			
	Frequency range is $2 \times f_s$ to $3.4 \times f_s$	80.6			
Group delay or latency	Frequency range is 0 to $0.325 \times f_s$		2.5		$1/f_s$
Group delay deviation	Frequency range is 0 to $0.325 \times f_s$	-0.826		0.333	$1/f_s$
Phase deviation	Frequency range is 0 to $0.325 \times f_s$	-0.86		1.30	Degrees

**6.3.7.1.5.3.5 Sampling Rate 192 kHz or 176.4 kHz**

Figure 6-58 shows the magnitude response and Figure 6-59 shows the pass-band ripple and phase deviation for a interpolation filter with a sampling rate of 192 kHz or 176.4 kHz. Table 6-38 lists its specifications.



**Table 6-38. Ultra-Low-Latency Interpolation Filter Specifications 192**

PARAMETER	TEST CONDITIONS	MIN	TYP	MAX	UNIT
Pass-band ripple	Frequency range is 0 to $0.463 \times f_S$	-0.001		0.001	dB
Stop-band attenuation	Frequency range is $0.6 \times f_S$ to $1 \times f_S$	86.9			dB
	Frequency range is $1 \times f_S$ to $1.4 \times f_S$	86.9			
Group delay or latency	Frequency range is 0 to $0.325 \times f_S$		1.7		$1/f_S$
Group delay deviation	Frequency range is 0 to $0.325 \times f_S$	-0.702		0.268	$1/f_S$
Phase deviation	Frequency range is 0 to $0.325 \times f_S$	-0.12		0.18	Degrees

### 6.3.7.1.6 Programmable Digital Mixer

The device supports a fully programmable mixer feature that can mix the various input channels with their custom programmable scale factor to generate the final output channels. The 8x4 Mixer is for the 8 Main ASI inputs and 4 outputs. The 2x4 Mixer is for the 2 AUX ASI inputs and 4 outputs. The 4 outputs are RDAC, RDAC2, LDAC and LDAC2.

Tables below shows the coefficients for the programmable 8x4 Mixer and the programmable 2x4 Mixer.

**Table 6-39. Programmable 8x4 Mixer**

Register Name	DAC Register co-efficient Mapping	Reset Value
ASI_CH1_RDAC_MIX(15:0)	B0_P17(R8-R9)	0x0000
ASI_CH1_LDAC_MIX(15:0)	B0_P17(R10-R11)	0x4000
ASI_CH1_RDAC2_MIX(15:0)	B0_P17(R12-R13)	0x0000
ASI_CH1_LDAC2_MIX(15:0)	B0_P17(R14-R15)	0x0000

Similarly the programmable mixer setting for main input channel can be done using ASI\_CH2\_(RDAC/LDAC/RDAC2/LDAC2) to ASI\_CH8\_(RDAC/LDAC/RDAC2/LDAC2) register bits.

**Table 6-40. Programmable 2x4 Mixer**

Register Name	DAC Register co-efficient Mapping	Reset Value
ASI_AUX_CH1_RDAC_MIX(15:0)	B0_P17(R72-R73)	0x0000
ASI_AUX_CH1_LDAC_MIX(15:0)	B0_P17(R74-R75)	0x4000
ASI_AUX_CH1_RDAC2_MIX(15:0)	B0_P17(R76-R77)	0x0000
ASI_AUX_CH1_LDAC2_MIX(15:0)	B0_P17(R78-R79)	0x4000

Similarly the programmable mixer setting for input channel can be done using the ASI\_AUX\_CH2\_(RDAC/LDAC/RDAC2/LDAC2) and ASI\_AUX\_CH2\_(RDAC/LDAC/RDAC2/LDAC2) register bits.

TI recommends using the PPC3 GUI for configuring the programmable coefficients settings; for more details see the [Using the TAx5x1x Programmable Digital Channel Mixer application report](#) and the [PurePath™ console graphical development suite](#).

### 6.3.7.2 PDM Recording Signal-Chain

The figure below shows the key components of the PDM record path signal chain.

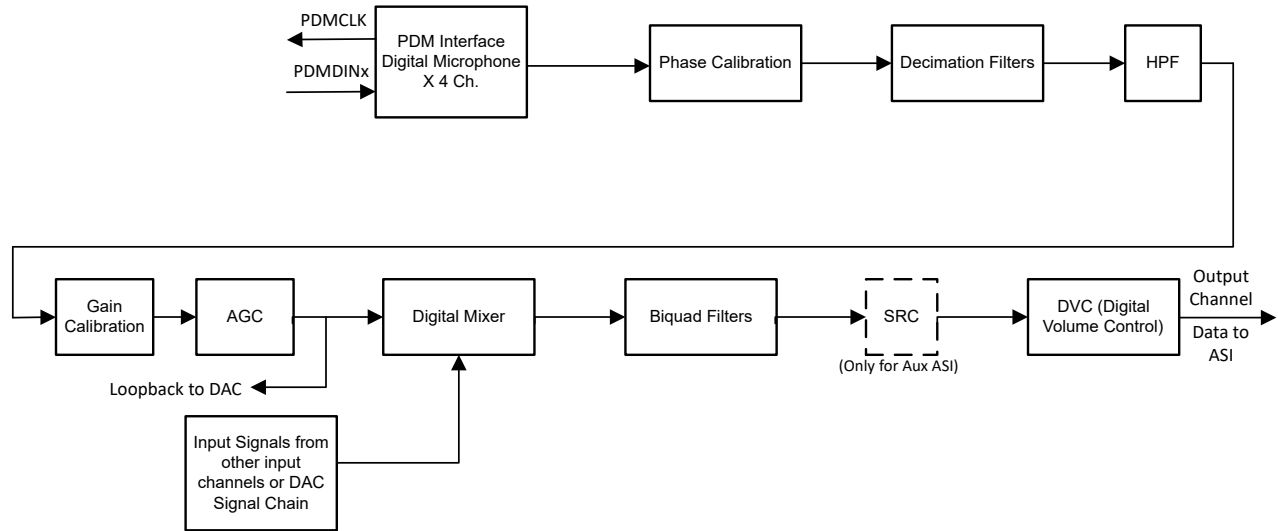

**Figure 6-60. PDM Recording Signal-Chain Processing Flowchart**

The device supports up to four digital PDM microphone recording channels. The architecture has an integrated, high-performance multistage digital decimation filter sharply cuts off any out-of-band frequency noise with high stop-band attenuation.

The device also has an integrated programmable biquad filter that allows for custom low-pass, high-pass, or any other desired frequency shaping. The signal chain also consists of various highly programmable digital processing blocks such as phase calibration, gain calibration, high-pass filter, digital summer or mixer, biquad filters, synchronous sample rate converter, and volume control. The details of these processing blocks are discussed further in this section.

The desired input channels for recording can be enabled or disabled by using the CH\_EN (P0\_R118) register, and the output channels for the audio serial interface can be enabled or disabled by using the ASI\_TX\_CHx\_CFG registers. In general, the device supports simultaneous power-up and power-down of all active channels for simultaneous recording. However, based on the application's needs, if some channels must be powered up or powered down dynamically when the other channel recording is on, then that use case is supported by setting the DYN\_PUPD\_CFG (P0\_R119) register.

For sample rates of 48kHz or lower, the device supports all features and various programmable processing blocks. However, for sample rates higher than 48kHz, there are limitations in the number of simultaneous channel recordings and playback supported and the number of biquad filters and such. See the [TAC5212 Sampling Rates and Programmable Processing Blocks Supported application report](#) for further details.

#### 6.3.7.2.1 Programmable Channel Gain and Digital Volume Control

The device has a programmable digital volume control with a range from –80dB to 47dB in steps of 0.5dB with the option to mute the channel recording. The digital volume control value can be changed dynamically while the record channel is powered up and recorded. During volume control changes, the soft ramp-up or ramp-down volume feature is used internally to avoid any audible artifacts. Soft-stepping can be entirely disabled using the ADC\_DSP\_DISABLE\_SOFT\_STEP (P0\_R114\_D[1]) register bit.

The digital volume control setting is independently available for each digital microphone record channel. However, the device also supports an option to gang up the volume control setting for all channels together using the channel 1 digital volume control setting, regardless if channel 1 is powered up or powered down. This gang-up can be enabled using the ADC\_DSP\_DVOL\_GANG (P0\_R114\_D[0]) register bit.

The table below shows the programmable options available for the digital volume control.



**Table 6-41. Digital Volume Control (DVC) Programmable Settings**

P0_R82_D[7:0] : ADC_CH1_DVOL[7:0]	DVC SETTING FOR OUTPUT CHANNEL 1
0000 0000 = 0d	Output channel 1 DVC is set to mute
0000 0001 = 1d	Output channel 1 DVC is set to -80dB
0000 0010 = 2d	Output channel 1 DVC is set to -79.5dB
0000 0011 = 3d	Output channel 1 DVC is set to -79dB
...	...
1010 0000 = 160d	Output channel 1 DVC is set to -0.5dB
1010 0001 = 161d (default)	Output channel 1 DVC is set to 0dB
1010 0010 = 162d	Output channel 1 DVC is set to 0.5dB
...	...
1111 1101 = 253d	Output channel 1 DVC is set to 46dB
1111 1110 = 254d	Output channel 1 DVC is set to 46.5dB
1111 1111 = 255d	Output channel 1 DVC is set to 47dB

Similarly, the digital volume control setting for output channel 2 to channel 4 can be configured using the CH2\_DVOL (P0\_R87) to CH4\_DVOL (P0\_R95) register bits, respectively.

The internal digital processing engine soft ramps up the volume from a muted level to the programmed volume level when the channel is powered up, and the internal digital processing engine soft ramps down the volume from a programmed volume to mute when the channel is powered down. This soft-stepping of volume is done to prevent abruptly powering up and powering down the record channel. This feature can also be entirely disabled using the ADC\_DSP\_DISABLE\_SOFT\_STEP (P0\_R114\_D[1]) register bit.

The programmable channel digital volume control feature is not applicable if the PLL is turned off. For setting channel attenuation, user can configure this by using the programmable high pass filter coefficients as described in programmable coefficient registers in B0\_P11.

#### 6.3.7.2.2 Programmable Channel Gain Calibration

Along with the digital volume control, this device also provides programmable channel gain calibration. The gain of each channel can be finely calibrated or adjusted in steps of 0.1dB for a range of -0.8dB to 0.7dB gain error. This adjustment is useful when trying to match the gain across channels resulting from external components and microphone sensitivity. This feature, in combination with the regular digital volume control, allows the gains across all channels to be matched for a wide gain error range with a resolution of 0.1dB. [Table 6-42](#) shows the programmable options available for the channel gain calibration.

**Table 6-42. Channel Gain Calibration Programmable Settings**

P0_R83_D[7:4] : ADC_CH1_FGAIN[3:0]	CHANNEL GAIN CALIBRATION SETTING FOR INPUT CHANNEL 1
0000 = 0d	Input channel 1 gain calibration is set to -0.8dB
0001 = 1d	Input channel 1 gain calibration is set to -0.7dB
...	...
1000 = 8d (default)	Input channel 1 gain calibration is set to 0dB
...	...
1110 = 14d	Input channel 1 gain calibration is set to 0.6dB
1111 = 15d	Input channel 1 gain calibration is set to 0.7dB

Similarly, the channel gain calibration setting for input channel 2 to channel 4 can be configured using the ADC\_CH2\_CFG3 (P0\_R88) to ADC\_CH4\_CFG3 (P0\_R96) register bits, respectively.

#### 6.3.7.2.3 Programmable Channel Phase Calibration

In addition to the gain calibration, the phase delay in each record channel can be finely calibrated or adjusted in steps of one modulator clock cycle for a cycle range of 1 to 63 for the phase error. The modulator clock for

the digital microphones is the clock set by PDM\_CLK, and is 3.072MHz (the output data sample rate is multiples or submultiples of 48kHz) or 2.8224MHz (the output data sample rate is multiples or submultiples of 44.1 kHz) in default configurations. User can configure the PDM\_CLK using the PDM\_CLK\_CFG[1:0] (P0\_R53\_D[7:6]) register bits. The programmable channel phase calibration feature is very useful for many applications that must match the phase with fine resolution between each channel, including any phase mismatch across channels resulting from external components or microphones. The table below shows the available programmable options for channel phase calibration when operating with default modulator clocks.

**Table 6-43. Channel Phase Calibration Programmable Settings**

P0_R84_D[7:2] : ADC_CH1_PCAL[5:0]	CHANNEL PHASE CALIBRATION SETTINGS FOR INPUT CHANNEL 1
00 0000 = 0d (default)	No phase calibration
00 0001 = 1d	Phase calibration delay is set to one cycle of the modulator clock
...	...
11 1111 = 63d	Phase calibration delay is set to 63 cycles of the modulator clock

Similarly, the channel phase calibration setting for input channel 2 to channel 4 can be configured using the ADC\_CH2\_PCAL (P0\_R89\_D[7:2]) to ADC\_CH4\_PCAL (P0\_R97\_D[7:2]) register bits, respectively.

#### 6.3.7.2.4 Programmable Digital High-Pass Filter

To remove the DC offset component and attenuate the undesired low-frequency noise content in the record data, the device supports a programmable high-pass filter (HPF). The HPF is not a channel-independent filter setting but is globally applicable for all record channels. This HPF is constructed using the first-order infinite impulse response (IIR) filter and is efficient enough to filter out possible DC components of the signal. [Table 6-44](#) shows the predefined –3dB cutoff frequencies available that can be set by using the ADC\_DSP\_HP\_SEL[1:0] register bits of P0\_R114\_D[5:4]. Additionally, to achieve a custom –3dB cutoff frequency for a specific application, the device also allows the first-order IIR filter coefficients to be programmed when the HPF\_SEL[1:0] register bits are set to 2'b00. [Figure 6-61](#) illustrates the frequency response plot for the HPF filter.

**Table 6-44. HPF Programmable Settings**

P0_R114_D[5:4] : ADC_DSP_HP_SEL L[1:0]	-3dB CUTOFF FREQUENCY SETTING	-3dB CUTOFF FREQUENCY AT 16kHz SAMPLE RATE	-3dB CUTOFF FREQUENCY AT 48-kHz SAMPLE RATE
00	Programmable 1st-order IIR filter	Programmable 1st-order IIR filter	Programmable 1st-order IIR filter
01 (default)	$0.00002 \times f_s$	0.25 Hz	1 Hz
10	$0.00025 \times f_s$	4 Hz	12 Hz
11	$0.002 \times f_s$	32 Hz	96 Hz

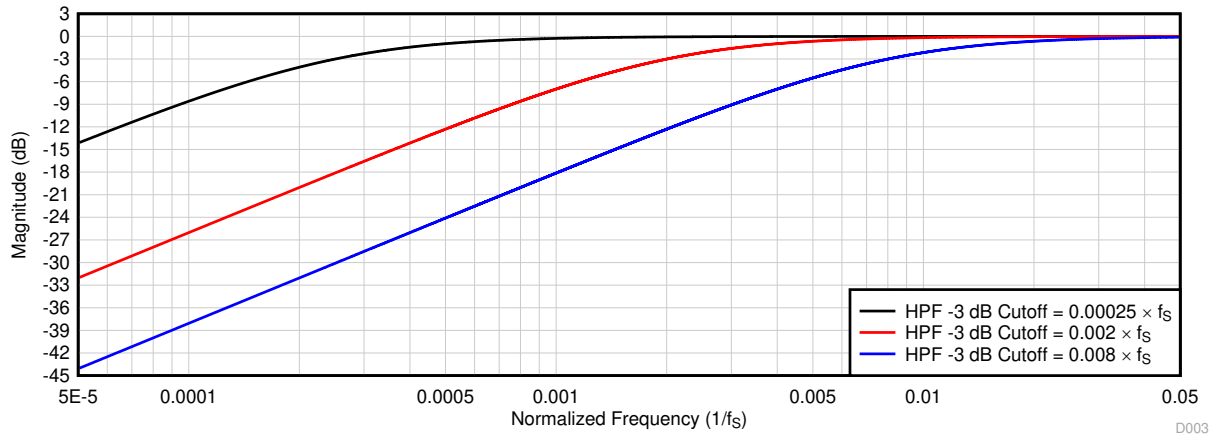

**Figure 6-61. HPF Filter Frequency Response Plot**

Equation 3 gives the transfer function for the first-order programmable IIR filter:

$$H(z) = \frac{N_0 + N_1 z^{-1}}{2^{31} - D_1 z^{-1}} \quad (3)$$

The frequency response for this first-order programmable IIR filter with default coefficients is flat at a gain of 0 dB (all-pass filter). The host device can override the frequency response by programming the IIR coefficients in Table 6-45 to achieve the desired frequency response for high-pass filtering or any other desired filtering. If ADC\_DSP\_HPF\_SEL[1:0] is set to 2'b00, the host device must write these coefficient values for the desired frequency response before powering-up any record channel for recording. Table 6-45 shows the filter coefficients for the first-order IIR filter.

**Table 6-45. 1st-Order IIR Filter Coefficients**

FILTER	FILTER COEFFICIENT	DEFAULT COEFFICIENT VALUE	COEFFICIENT REGISTER MAPPING
Programmable 1st-order IIR filter (can be allocated to HPF or any other desired filter)	N <sub>0</sub>	0x7FFFFFFF	P10_R120-R123
	N <sub>1</sub>	0x00000000	P10_R124-R127
	D <sub>1</sub>	0x00000000	P11_R8-R11

#### 6.3.7.2.5 Programmable Digital Biquad Filters

The device supports up to 12 programmable digital biquad filters available for record signal chain limited to 3/channel. These highly efficient filters achieve the desired frequency response. The TAD5212 also supports on-the-fly programmable Biquad filters for two-channel record use cases. In digital signal processing, a digital biquad filter is a second-order, recursive linear filter with two poles and two zeros. Equation 4 gives the transfer function of each biquad filter:

$$H(z) = \frac{N_0 + 2N_1 z^{-1} + N_2 z^{-2}}{2^{31} - 2D_1 z^{-1} - D_2 z^{-2}} \quad (4)$$

The frequency response for the biquad filter section with default coefficients is flat at a gain of 0dB (all-pass filter). The host device can override the frequency response by programming the biquad coefficients to achieve the desired frequency response for low-pass, high-pass, or any other desired frequency shaping. The programmable coefficients for the biquads are located in the B0\_P8 and B0\_P9. If biquad filtering is required, then the host device must write these coefficient values before powering up any record channels for recording. In two-channel use case, the TAD5212 also supports on-the-fly programmable filters. In this case, the device uses two banks of filters for one channel with a switch bit to perform the switch from one filter bank to the

other. As described in [Table 6-46](#), these biquad filters can be allocated for each output channel based on the ADC\_DSP\_BQ\_CFG[1:0] register setting of P0\_R114\_D[3:2]. By setting ADC\_DSP\_BQ\_CFG[1:0] to 2'b00, the biquad filtering for all record channels is disabled and the host device can choose this setting if no additional filtering is required for the system application. See the [TAC5x1x and TAC5x1x-Q1 Programmable Biquad Filters - Configuration and Applications application report](#) for further details.

**Table 6-46. Biquad Filter Allocation to the Record Output Channel**

PROGRAMMABLE BIQUAD FILTER	RECORD OUTPUT CHANNEL ALLOCATION USING P0_R114_D[3:2] REGISTER SETTING		
	ADC_DSP_BQ_CFG[1:0] = 2'b01 (1 Biquad per Channel)	ADC_DSP_BQ_CFG[1:0] = 2'b10 (Default) (2 Biquads per Channel)	ADC_DSP_BQ_CFG[1:0] = 2'b11 (3 Biquads per Channel)
Biquad filter 1	Allocated to output channel 1	Allocated to output channel 1	Allocated to output channel 1
Biquad filter 2	Allocated to output channel 2	Allocated to output channel 2	Allocated to output channel 2
Biquad filter 3	Allocated to output channel 3	Allocated to output channel 3	Allocated to output channel 3
Biquad filter 4	Allocated to output channel 4	Allocated to output channel 4	Allocated to output channel 4
Biquad filter 5	Not used	Allocated to output channel 1	Allocated to output channel 1
Biquad filter 6	Not used	Allocated to output channel 2	Allocated to output channel 2
Biquad filter 7	Not used	Allocated to output channel 3	Allocated to output channel 3
Biquad filter 8	Not used	Allocated to output channel 4	Allocated to output channel 4
Biquad filter 9	Not used	Not used	Allocated to output channel 1
Biquad filter 10	Not used	Not used	Allocated to output channel 2
Biquad filter 11	Not used	Not used	Allocated to output channel 3
Biquad filter 12	Not used	Not used	Allocated to output channel 4

[Table 6-47](#) shows the biquad filter coefficients mapping to the register space.

**Table 6-47. Biquad Filter Coefficients Register Mapping**

PROGRAMMABLE BIQUAD FILTER	BIQUAD FILTER COEFFICIENTS REGISTER MAPPING	PROGRAMMABLE BIQUAD FILTER	BIQUAD FILTER COEFFICIENTS REGISTER MAPPING
Biquad filter 1	P8_R8-R27	Biquad filter 7	P9_R8-R27
Biquad filter 2	P8_R28-R47	Biquad filter 8	P9_R28-R47
Biquad filter 3	P8_R48-R67	Biquad filter 9	P9_R48-R67
Biquad filter 4	P8_R68-R87	Biquad filter 10	P9_R68-R87
Biquad filter 5	P8_R88-R107	Biquad filter 11	P9_R88-R107
Biquad filter 6	P8_R108-R127	Biquad filter 12	P9_R108-R127

### 6.3.7.2.6 Configurable Digital Decimation Filters

The device record channel includes a high dynamic range and a built-in digital decimation filter for processing the oversampled PDM stream from the digital microphone. The decimation filter can be chosen from four different types, depending on the required frequency response, group delay, power consumption, and phase linearity requirements for the target application. The selection of the decimation filter option can be done by configuring the ADC\_DSP\_DECI\_FILT (P0\_R114\_D[7:6]) register bits. Low power filter can be configured by setting ADC\_LOW\_PWR\_FILT (P0\_R78\_D[2]) bit. Table below shows the configuration register setting for the decimation filter mode selection for the record channel. This makes them suitable for a wide variety of audio applications.

**Table 6-48. Decimation Filter Mode Selection for the Record Channel**

P0_R78_D[2] : ADC_LOW_PWR_FILT	P0_R114_D[7:6] : ADC_DSP_DECI_FILT[1:0]	DECIMATION FILTER MODE SELECTION
0	00 (default)	Linear phase filters are used for the decimation
0	01	Low latency filters are used for the decimation
0	10	Ultra-low latency filters are used for the decimation
0	11	Reserved (do not use this setting)
1	x	Low power filters are used for the decimation

The following sections describe the filter response for the different latency options and samples rates.

#### 6.3.7.2.6.1 Linear-phase filters

The linear-phase decimation filters are the default filters set by the device and can be used for all applications that require a perfect linear phase with zero-phase deviation within the pass-band specification of the filter. The filter performance specifications and various plots for all supported output sampling rates are listed in this section.

##### 6.3.7.2.6.1.1 Sampling Rate: 8kHz or 7.35kHz

Figure 6-62 and Figure 6-63 respectively show the magnitude response and the pass-band ripple for this decimation filter with a sampling rate of 8kHz or 7.35kHz, Table 6-49 and lists its specifications.

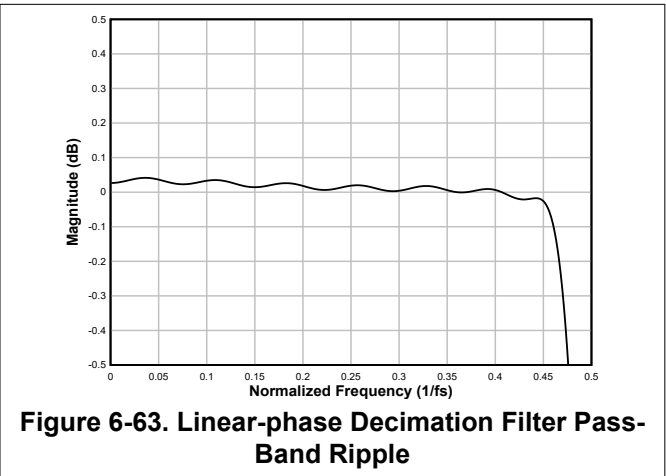
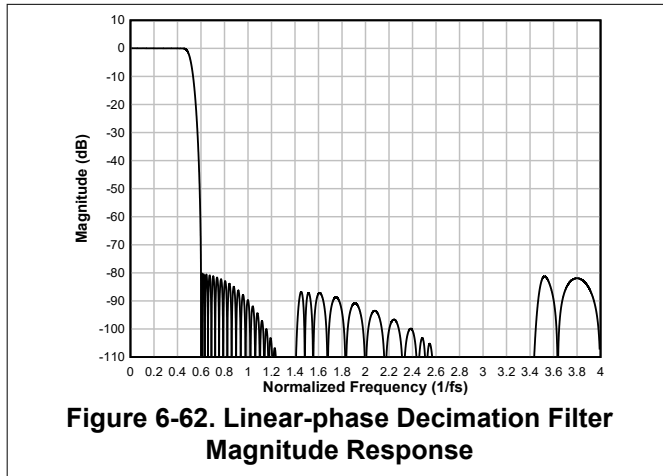

**Table 6-49. Linear-phase Decimation Filter Specifications**

PARAMETER	TEST CONDITIONS	MIN	TYP	MAX	UNIT
Pass-band ripple	Frequency range is 0 to $0.454 \times f_s$	-0.04		0.04	dB
Stop-band attenuation	Frequency range is $0.6 \times f_s$ to $4 \times f_s$	80.2			dB
	Frequency range is $4 \times f_s$ onwards	84.7			
Group delay or latency	Frequency range is 0 to $0.454 \times f_s$		16.1		$1/f_s$

### 6.3.7.2.6.1.2 Sampling Rate: 16kHz or 14.7kHz

Figure 6-64 and Figure 6-65 respectively show the magnitude response and the pass-band ripple for this decimation filter with a sampling rate of 16kHz or 14.7kHz, and Table 6-50 lists its specifications.

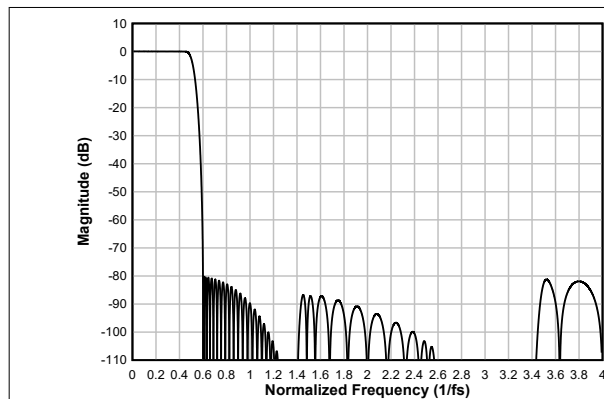

Figure 6-64. Linear-phase Decimation Filter Magnitude Response

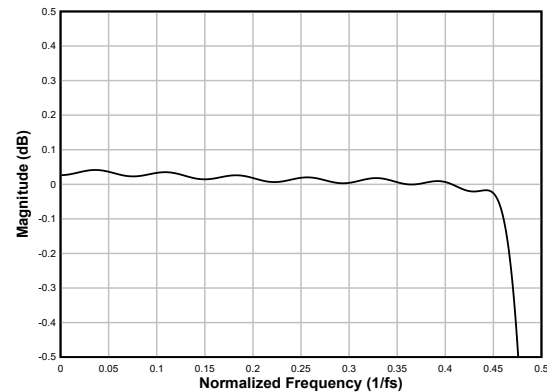

Figure 6-65. Linear-phase Decimation Filter Pass-Band Ripple

Table 6-50. Linear-phase Decimation Filter Specifications

PARAMETER	TEST CONDITIONS	MIN	TYP	MAX	UNIT
Pass-band ripple	Frequency range is 0 to $0.454 \times f_s$	-0.04		0.04	dB
Stop-band attenuation	Frequency range is $0.6 \times f_s$ to $4 \times f_s$	80.2			dB
	Frequency range is $4 \times f_s$ onwards	84.7			
Group delay or latency	Frequency range is 0 to $0.454 \times f_s$		16.1		$1/f_s$

### 6.3.7.2.6.1.3 Sampling Rate: 24kHz or 22.05kHz

Figure 6-66 and Figure 6-67 respectively show the magnitude response and the pass-band ripple for this decimation filter with a sampling rate of 24kHz or 22.05kHz, and Table 6-51 lists its specifications.

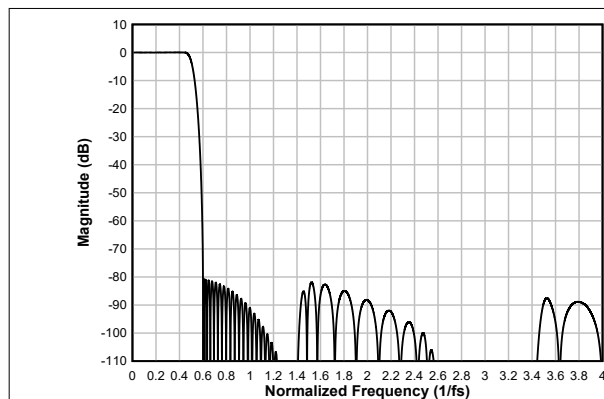

Figure 6-66. Linear-phase Decimation Filter Magnitude Response

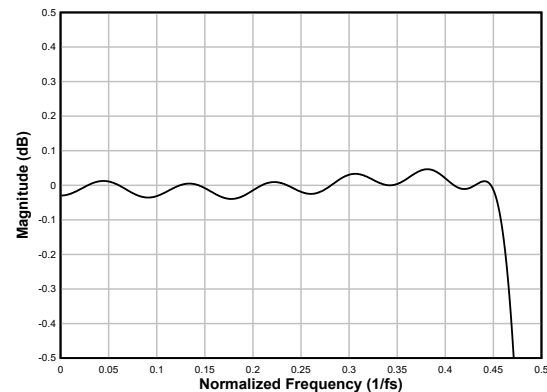

Figure 6-67. Linear-phase Decimation Filter Pass-Band Ripple

Table 6-51. Linear-phase Decimation Filter Specifications

PARAMETER	TEST CONDITIONS	MIN	TYP	MAX	UNIT
Pass-band ripple	Frequency range is 0 to $0.455 \times f_s$	-0.05		0.05	dB
Stop-band attenuation	Frequency range is $0.6 \times f_s$ to $4 \times f_s$	80.6			dB
	Frequency range is $4 \times f_s$ onwards	93			

**Table 6-51. Linear-phase Decimation Filter Specifications (continued)**

PARAMETER	TEST CONDITIONS	MIN	TYP	MAX	UNIT
Group delay or latency	Frequency range is 0 to $0.455 \times f_s$		14.7		$1/f_s$

**6.3.7.2.6.1.4 Sampling Rate: 32kHz or 29.4kHz**

Figure 6-68 and Figure 6-69 respectively show the magnitude response and the pass-band ripple for this decimation filter with a sampling rate of 32kHz or 29.4kHz, and Table 6-52 lists its specifications.

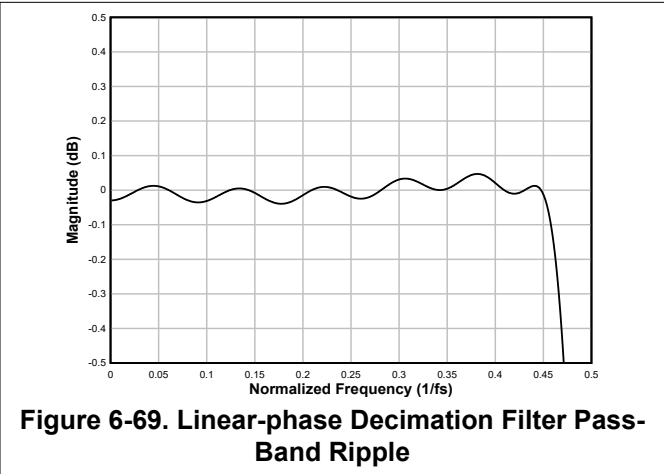
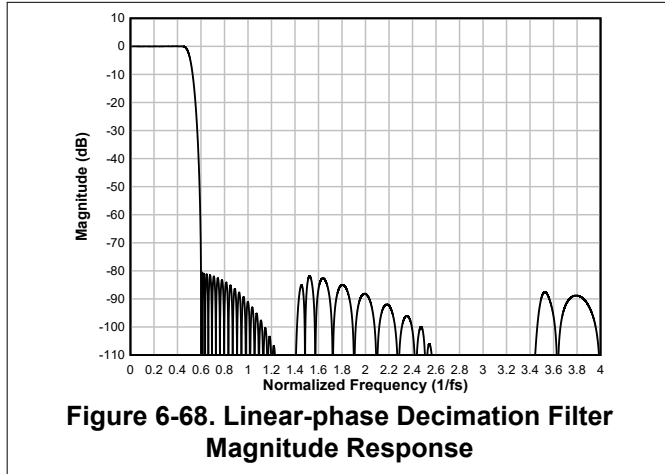
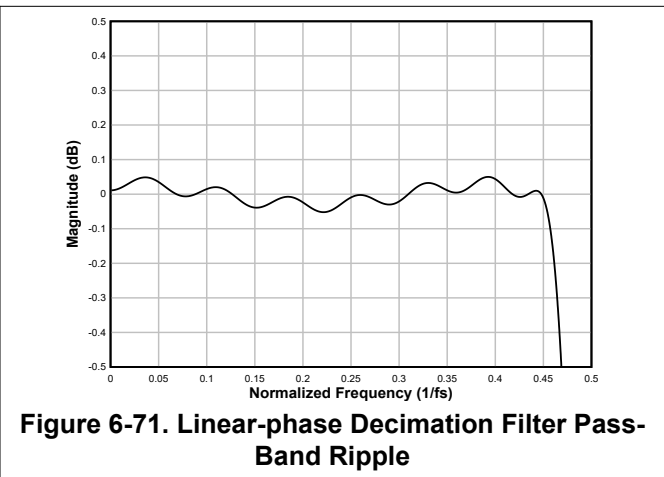
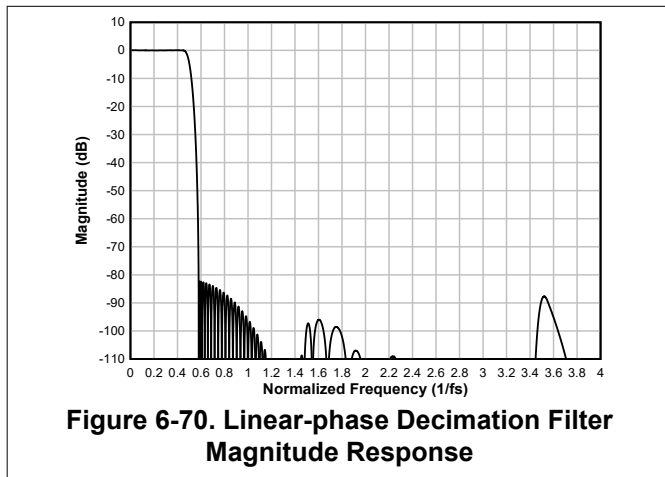

**Table 6-52. Linear-phase Decimation Filter Specifications**

PARAMETER	TEST CONDITIONS	MIN	TYP	MAX	UNIT
Pass-band ripple	Frequency range is 0 to $0.455 \times f_s$	-0.05		0.05	dB
Stop-band attenuation	Frequency range is $0.6 \times f_s$ to $4 \times f_s$	80.6			dB
	Frequency range is $4 \times f_s$ onwards	92.9			
Group delay or latency	Frequency range is 0 to $0.455 \times f_s$		14.7		$1/f_s$

**6.3.7.2.6.1.5 Sampling Rate: 48kHz or 44.1kHz**

Figure 6-70 and Figure 6-71 respectively show the magnitude response and the pass-band ripple for this decimation filter with a sampling rate of 48kHz or 44.1kHz, and Table 6-53 lists its specifications.

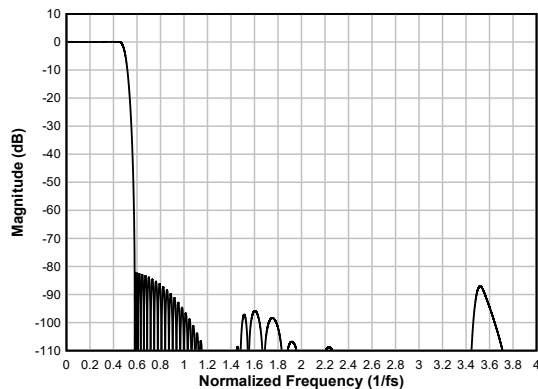
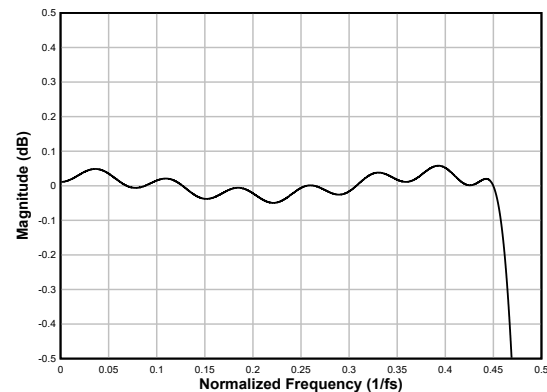

**Table 6-53. Linear-phase Decimation Filter Specifications**

PARAMETER	TEST CONDITIONS	MIN	TYP	MAX	UNIT
Pass-band ripple	Frequency range is 0 to $0.454 \times f_S$	-0.05		0.05	dB
Stop-band attenuation	Frequency range is $0.58 \times f_S$ to $4 \times f_S$	82.2			dB
	Frequency range is $4 \times f_S$ onwards	98			
Group delay or latency	Frequency range is 0 to $0.454 \times f_S$		17		$1/f_S$

**6.3.7.2.6.1.6 Sampling Rate: 96kHz or 88.2kHz**

Figure 6-72 and Figure 6-73 respectively show the magnitude response and the pass-band ripple for this decimation filter with a sampling rate of 96kHz or 88.2kHz, and Table 6-54 lists its specifications.

**Figure 6-72. Linear-phase Decimation Filter Magnitude Response****Figure 6-73. Linear-phase Decimation Filter Pass-Band Ripple****Table 6-54. Linear-phase Decimation Filter Specifications**

PARAMETER	TEST CONDITIONS	MIN	TYP	MAX	UNIT
Pass-band ripple	Frequency range is 0 to $0.455 \times f_S$	-0.05		0.06	dB
Stop-band attenuation	Frequency range is $0.58 \times f_S$ to $4 \times f_S$	82.2			dB
	Frequency range is $4 \times f_S$ onwards	87			
Group delay or latency	Frequency range is 0 to $0.455 \times f_S$		16.9		$1/f_S$

**6.3.7.2.6.1.7 Sampling Rate: 192kHz or 176.4kHz**

Figure 6-74 and Figure 6-75 respectively show the magnitude response and the pass-band ripple for this decimation filter with a sampling rate of 192kHz or 176.4kHz, and Table 6-55 lists its specifications.



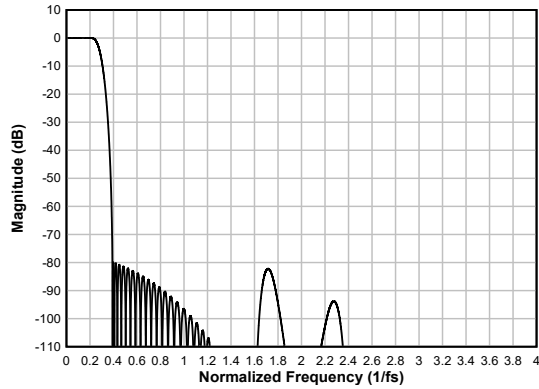

**Figure 6-74. Linear-phase Decimation Filter Magnitude Response**

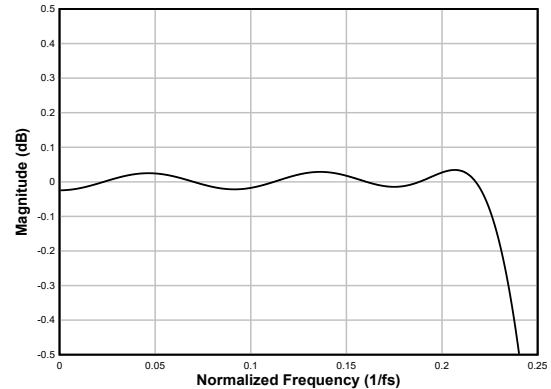

**Figure 6-75. Linear-phase Decimation Filter Pass-Band Ripple**

**Table 6-55. Linear-phase Decimation Filter Specifications**

PARAMETER	TEST CONDITIONS	MIN	TYP	MAX	UNIT
Pass-band ripple	Frequency range is 0 to $0.223 \times f_S$	-0.04		0.04	dB
Stop-band attenuation	Frequency range is $0.391 \times f_S$ to $4 \times f_S$	80			
	Frequency range is $4 \times f_S$ onwards	82.2			
Group delay or latency	Frequency range is 0 to $0.223 \times f_S$		11.6		$1/f_S$

**Sampling Rate: 384kHz or 352.8kHz**

Figure 6-76 and Figure 6-77 respectively show the magnitude response and the pass-band ripple for this decimation filter with a sampling rate of 384kHz or 352.8kHz, and Table 6-56 lists its specifications

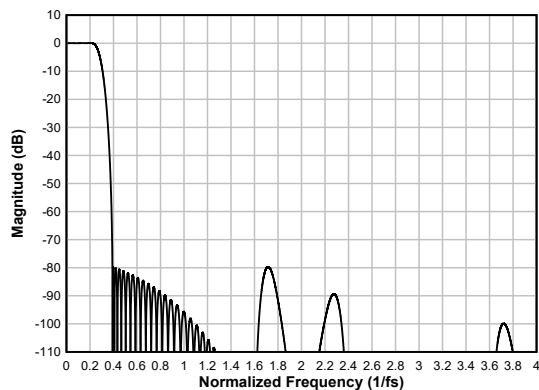

**Figure 6-76. Linear-phase Decimation Filter Magnitude Response**

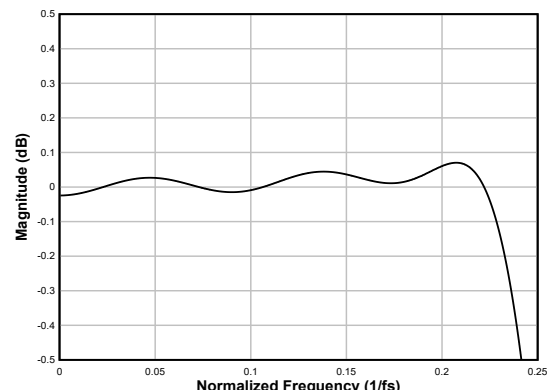

**Figure 6-77. Linear-phase Decimation Filter Pass-Band Ripple**

**Table 6-56. Linear-phase Decimation Filter Specifications**

PARAMETER	TEST CONDITIONS	MIN	TYP	MAX	UNIT
Pass-band ripple	Frequency range is 0 to $0.227 \times f_S$	-0.07		0.07	dB
Stop-band attenuation	Frequency range is $0.391 \times f_S$ to $4 \times f_S$	80			
	Frequency range is $4 \times f_S$ onwards	88.1			
Group delay or latency	Frequency range is 0 to $0.227 \times f_S$		11.4		$1/f_S$

### Sampling Rate: 768kHz or 705.6 kHz

Figure 6-78 and Figure 6-79 respectively show the magnitude response and the pass-band ripple for this decimation filter with a sampling rate of 768kHz or 705.6kHz, and Table 6-57 lists its specifications

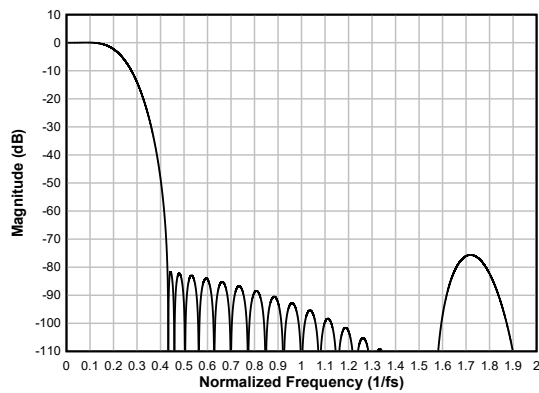

**Figure 6-78. Linear-phase Decimation Filter Magnitude Response**

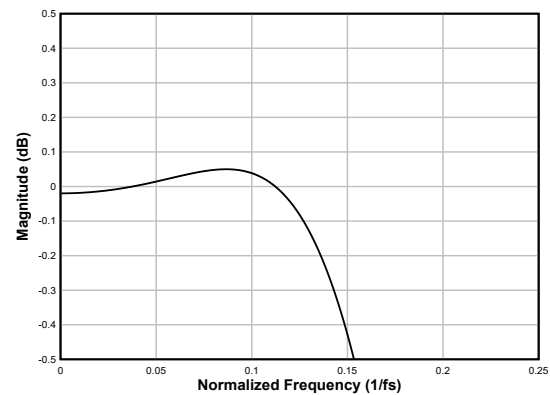

**Figure 6-79. Linear-phase Decimation Filter Pass-Band Ripple**

**Table 6-57. Linear-phase Decimation Filter Specifications**

PARAMETER	TEST CONDITIONS	MIN	TYP	MAX	UNIT
Pass-band ripple	Frequency range is 0 to $0.121 \times f_S$	-0.05		0.05	dB
Stop-band attenuation	Frequency range is $0.433 \times f_S$ to $4 \times f_S$	82.6			dB
	Frequency range is $4 \times f_S$ onwards	83.6			
Group delay or latency	Frequency range is 0 to $0.258 \times f_S$		6.4		$1/f_S$

#### 6.3.7.2.6.2 Low-latency Filters

For applications where low latency with minimal phase deviation (within the audio band) is critical, the low-latency decimation filters on the TAD5212 can be used. The device supports these filters with a group delay of approximately seven samples with an almost linear phase response within the  $0.376 \times f_S$  frequency band. This section provides the filter performance specifications and various plots for all supported output sampling rates for the low-latency filters.

##### 6.3.7.2.6.2.1 Sampling Rate: 24kHz or 22.05kHz

Figure 6-80 shows the magnitude response and Figure 6-81 shows the pass-band ripple and phase deviation for this decimation filter with a sampling rate of 24kHz or 22.05kHz. Table 6-58 lists its specifications.

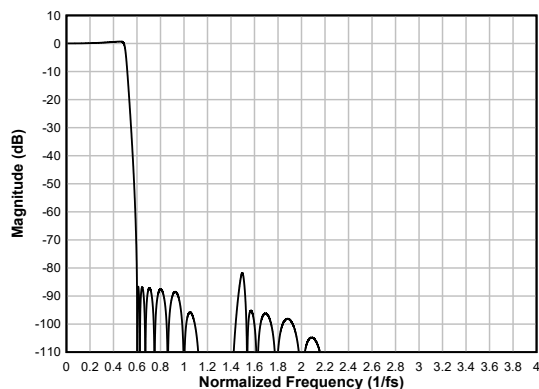

**Figure 6-80. Low-latency Decimation Filter Magnitude Response**

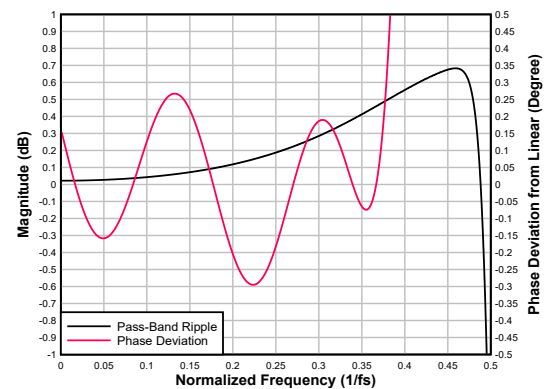

**Figure 6-81. Low-latency Decimation Filter Pass-Band Ripple and Phase Deviation**

**Table 6-58. Low-latency Decimation Filter Specifications**

PARAMETER	TEST CONDITIONS	MIN	TYP	MAX	UNIT
Pass-band ripple	Frequency range is 0 to $0.492 \times f_S$	-0.67		0.67	dB
Stop-band attenuation	Frequency range is $0.6 \times f_S$ to $4 \times f_S$	81.8			dB
	Frequency range is $4 \times f_S$ onwards	115			
Group delay or latency	Frequency range is 0 to $0.376 \times f_S$		6.5		$1/f_S$
Group delay deviation	Frequency range is 0 to $0.376 \times f_S$	-0.092		0.029	$1/f_S$
Phase deviation	Frequency range is 0 to $0.376 \times f_S$	-0.3		0.27	Degrees

**6.3.7.2.6.2 Sampling Rate: 32kHz or 29.4kHz**

Figure 6-82 shows the magnitude response and Figure 6-83 shows the pass-band ripple and phase deviation for this decimation filter with a sampling rate of 32kHz or 29.4kHz. Table 6-59 lists its specifications.

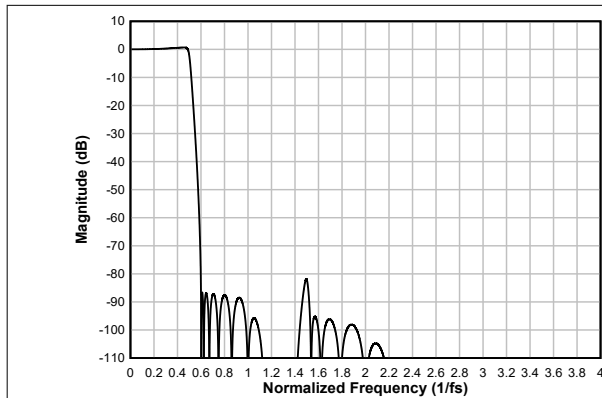

**Figure 6-82. Low-latency Decimation Filter Magnitude Response**

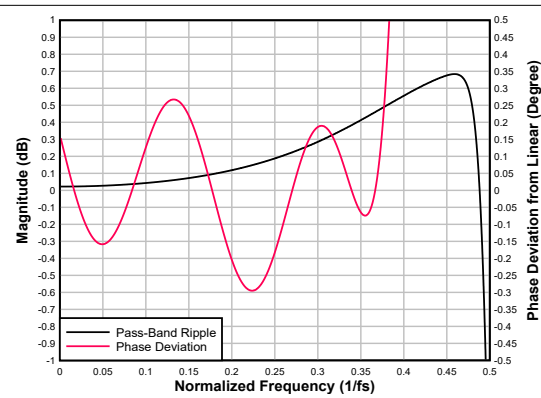

**Figure 6-83. Low-latency Decimation Filter Pass-Band Ripple and Phase Deviation**

**Table 6-59. Low-latency Decimation Filter Specifications**

PARAMETER	TEST CONDITIONS	MIN	TYP	MAX	UNIT
Pass-band ripple	Frequency range is 0 to $0.492 \times f_S$	-0.67		0.67	dB
Stop-band attenuation	Frequency range is $0.6 \times f_S$ to $4 \times f_S$	81.8			dB
	Frequency range is $4 \times f_S$ onwards	115			
Group delay or latency	Frequency range is 0 to $0.376 \times f_S$		6.5		$1/f_S$
Group delay deviation	Frequency range is 0 to $0.376 \times f_S$	-0.092		0.029	$1/f_S$
Phase deviation	Frequency range is 0 to $0.376 \times f_S$	-0.3		0.27	Degrees

**6.3.7.2.6.2.3 Sampling Rate: 48kHz or 44.1kHz**

Figure 6-84 shows the magnitude response and Figure 6-85 shows the pass-band ripple and phase deviation for this decimation filter with a sampling rate of 48kHz or 44.1kHz. Table 6-60 lists its specifications.

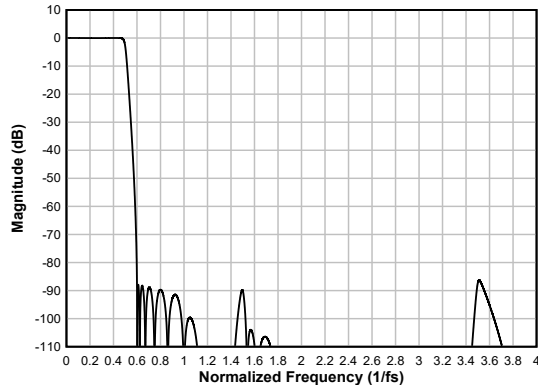

**Figure 6-84. Low-latency Decimation Filter Magnitude Response**

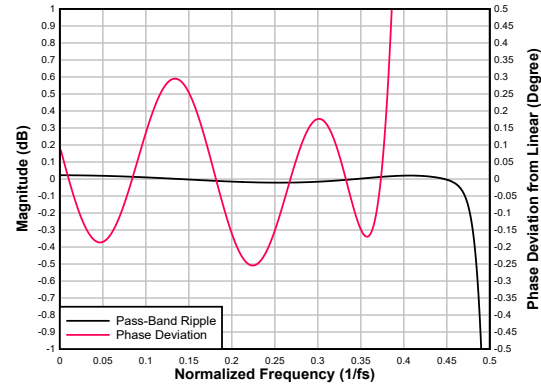

**Figure 6-85. Low-latency Decimation Filter Pass-Band Ripple and Phase Deviation**

**Table 6-60. Low-latency Decimation Filter Specifications**

PARAMETER	TEST CONDITIONS	MIN	TYP	MAX	UNIT
Pass-band ripple	Frequency range is 0 to $0.456 \times f_S$	-0.02		0.02	dB
Stop-band attenuation	Frequency range is $0.6 \times f_S$ to $4 \times f_S$	86.3			
	Frequency range is $4 \times f_S$ onwards	96.8			
Group delay or latency	Frequency range is 0 to $0.376 \times f_S$		6.6		$1/f_S$
Group delay deviation	Frequency range is 0 to $0.376 \times f_S$	-0.086		0.027	$1/f_S$
Phase deviation	Frequency range is 0 to $0.376 \times f_S$	-0.25		0.3	Degrees

**6.3.7.2.6.2.4 Sampling Rate: 96kHz or 88.2kHz**

Figure 6-86 shows the magnitude response and Figure 6-87 shows the pass-band ripple and phase deviation for this decimation filter with a sampling rate of 96kHz or 88.2kHz. Table 6-61 lists its specifications.

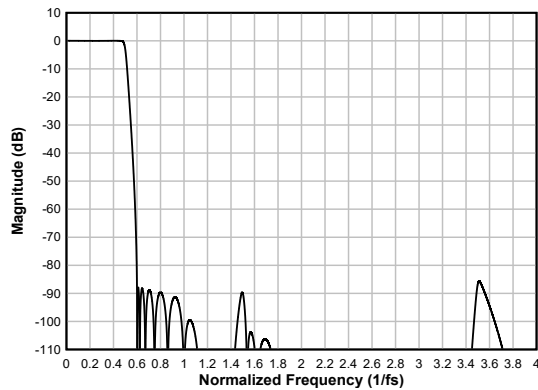

**Figure 6-86. Low-latency Decimation Filter Magnitude Response**

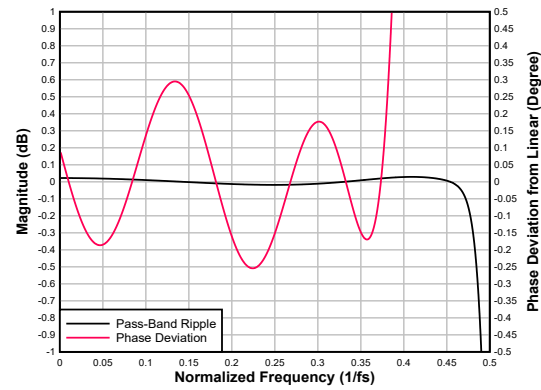

**Figure 6-87. Low-latency Decimation Filter Pass-Band Ripple and Phase Deviation**

**Table 6-61. Low-latency Decimation Filter Specifications**

PARAMETER	TEST CONDITIONS	MIN	TYP	MAX	UNIT
Pass-band ripple	Frequency range is 0 to $0.599 \times f_S$	-0.02		0.03	dB
Stop-band attenuation	Frequency range is $0.599 \times f_S$ to $4 \times f_S$	85.6			
	Frequency range is $4 \times f_S$ onwards	95.7			
Group delay or latency	Frequency range is 0 to $0.376 \times f_S$		6.6		$1/f_S$
Group delay deviation	Frequency range is 0 to $0.376 \times f_S$	-0.086		0.022	$1/f_S$

**Table 6-61. Low-latency Decimation Filter Specifications (continued)**

PARAMETER	TEST CONDITIONS	MIN	TYP	MAX	UNIT
Phase deviation	Frequency range is 0 to $0.376 \times f_S$	-0.25		0.30	Degrees

**6.3.7.2.6.2.5 Sampling Rate: 192kHz or 176.4kHz**

Figure 6-88 shows the magnitude response and Figure 6-89 shows the pass-band ripple and phase deviation for this decimation filter with a sampling rate of 192kHz or 176.4kHz. Table 6-62 lists its specifications.

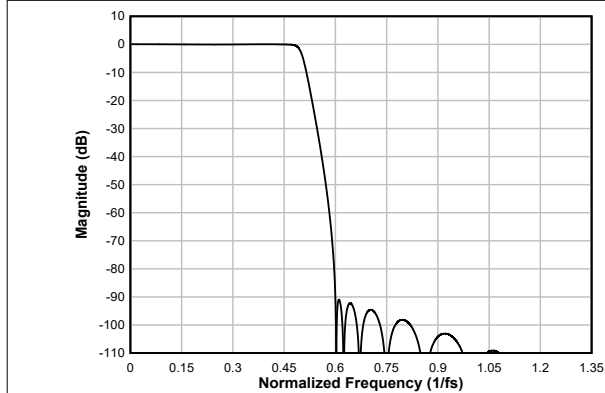

**Figure 6-88. Low-latency Decimation Filter Magnitude Response**

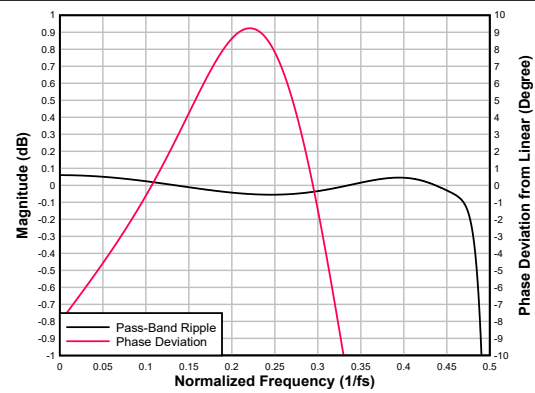

**Figure 6-89. Low-latency Decimation Filter Pass-Band Ripple and Phase Deviation**

**Table 6-62. Low-latency Decimation Filter Specifications**

PARAMETER	TEST CONDITIONS	MIN	TYP	MAX	UNIT
Pass-band ripple	Frequency range is 0 to $0.456 \times f_S$	-0.06		0.06	dB
Stop-band attenuation	Frequency range is $0.571 \times f_S$ to $1.35 \times f_S$	90.5			dB
	Frequency range is $1 \times f_S$ onwards	86.9			
Group delay or latency	Frequency range is 0 to $0.327 \times f_S$		6.8		$1/f_S$
Group delay deviation	Frequency range is 0 to $0.327 \times f_S$	-0.296		0.829	$1/f_S$
Phase deviation	Frequency range is 0 to $0.327 \times f_S$	-9.24		9.24	Degrees

**6.3.7.2.6.3 Ultra Low-latency Filters**

For applications where ultra low latency with minimal phase deviation (within the audio band) is critical, the ultra low-latency decimation filters on the TAD5212 can be used. The device supports these filters with a group delay of approximately four samples with a fair phase response within the  $0.325 \times f_S$  frequency band. This section provides the filter performance specifications and various plots for all supported output sampling rates for the ultra low-latency filters.

**6.3.7.2.6.3.1 Sampling Rate: 24kHz or 22.05kHz**

Figure 6-90 shows the magnitude response and Figure 6-91 shows the pass-band ripple and phase deviation for this decimation filter with a sampling rate of 24kHz or 22.05kHz. Table 6-63 lists its specifications.

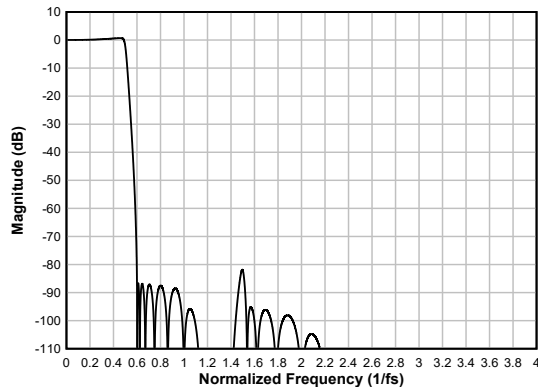

**Figure 6-90. Ultra Low-latency Decimation Filter Magnitude Response**

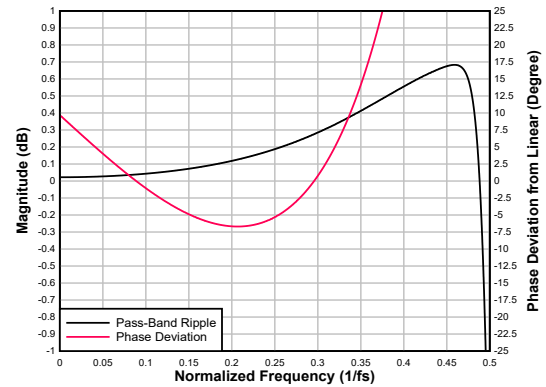

**Figure 6-91. Ultra Low-latency Decimation Filter Pass-Band Ripple and Phase Deviation**

**Table 6-63. Ultra Low-latency Decimation Filter Specifications**

PARAMETER	TEST CONDITIONS	MIN	TYP	MAX	UNIT
Pass-band ripple	Frequency range is 0 to $0.492 \times f_S$	-0.67		-0.67	dB
Stop-band attenuation	Frequency range is $0.6 \times f_S$ to $4 \times f_S$	81.8			dB
	Frequency range is $4 \times f_S$ onwards	115			
Group delay or latency	Frequency range is 0 to $0.325 \times f_S$		2.8		$1/f_S$
Group delay deviation	Frequency range is 0 to $0.325 \times f_S$	-0.292		0.765	$1/f_S$
Phase deviation	Frequency range is 0 to $0.325 \times f_S$	-6.7		9.7	Degrees

#### 6.3.7.2.6.3.2 Sampling Rate: 32kHz or 29.4kHz

Figure 6-92 shows the magnitude response and Figure 6-93 shows the pass-band ripple and phase deviation for this decimation filter with a sampling rate of 32kHz or 29.4kHz. Table 6-64 lists its specifications.

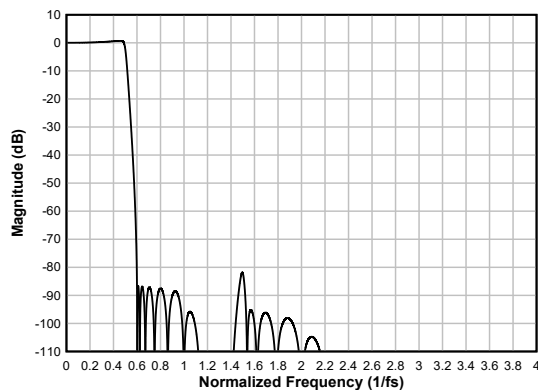

**Figure 6-92. Ultra Low-latency Decimation Filter Magnitude Response**

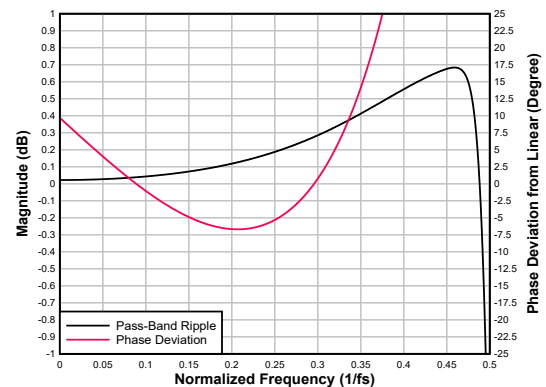

**Figure 6-93. Ultra Low-latency Decimation Filter Pass-Band Ripple and Phase Deviation**

**Table 6-64. Ultra Low-latency Decimation Filter Specifications**

PARAMETER	TEST CONDITIONS	MIN	TYP	MAX	UNIT
Pass-band ripple	Frequency range is 0 to $0.492 \times f_S$	-0.67		-0.67	dB
Stop-band attenuation	Frequency range is $0.6 \times f_S$ to $4 \times f_S$	81.8			dB
	Frequency range is $4 \times f_S$ onwards	115			
Group delay or latency	Frequency range is 0 to $0.325 \times f_S$		2.7		$1/f_S$
Group delay deviation	Frequency range is 0 to $0.325 \times f_S$	-0.292		0.765	$1/f_S$

**Table 6-64. Ultra Low-latency Decimation Filter Specifications (continued)**

PARAMETER	TEST CONDITIONS	MIN	TYP	MAX	UNIT
Phase deviation	Frequency range is 0 to $0.325 \times f_S$	-6.7		9.7	Degrees

**6.3.7.2.6.3.3 Sampling Rate: 48kHz or 44.1kHz**

Figure 6-94 shows the magnitude response and Figure 6-95 shows the pass-band ripple and phase deviation for this decimation filter with a sampling rate of 48kHz or 44.1kHz. Table 6-65 lists its specifications.

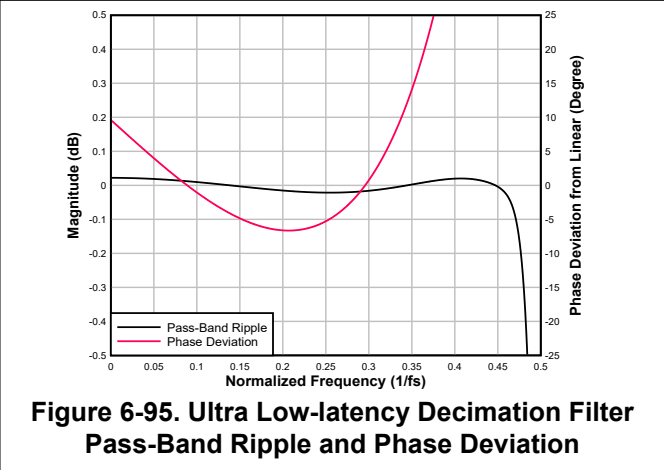
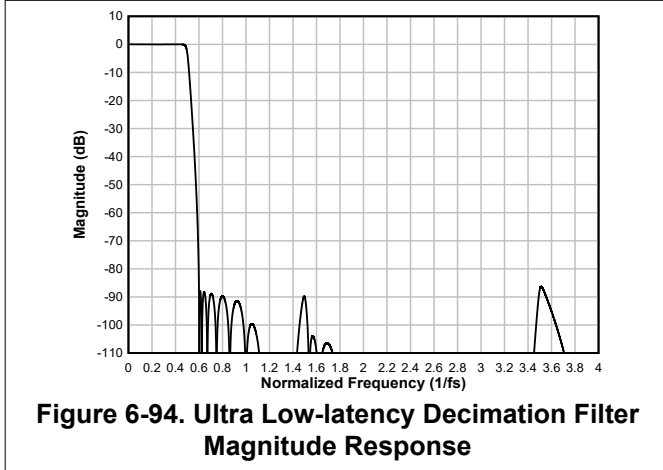
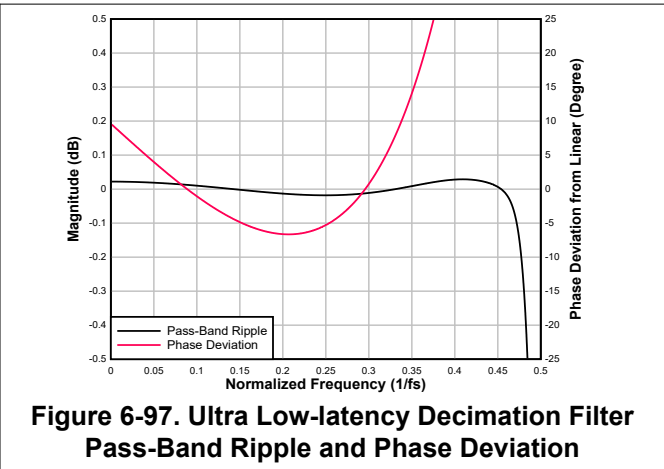
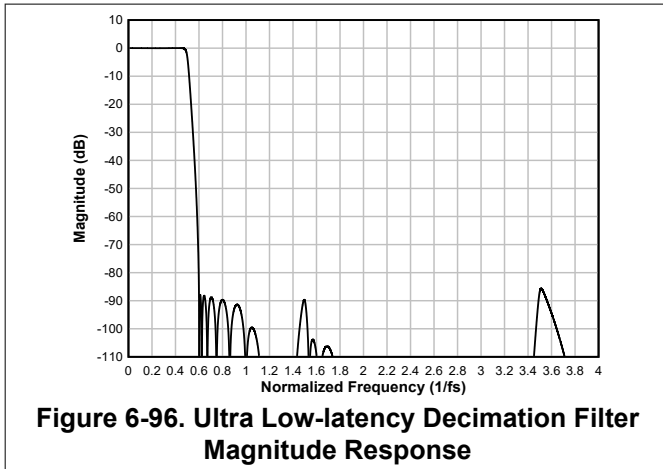

**Table 6-65. Ultra Low-latency Decimation Filter Specifications**

PARAMETER	TEST CONDITIONS	MIN	TYP	MAX	UNIT
Pass-band ripple	Frequency range is 0 to $0.456 \times f_S$	-0.02		-0.02	dB
Stop-band attenuation	Frequency range is $0.6 \times f_S$ to $4 \times f_S$	86.3			dB
	Frequency range is $4 \times f_S$ onwards	96.8			
Group delay or latency	Frequency range is 0 to $0.325 \times f_S$		2.8		$1/f_S$
Group delay deviation	Frequency range is 0 to $0.325 \times f_S$	-0.29		0.761	$1/f_S$
Phase deviation	Frequency range is 0 to $0.325 \times f_S$	-6.6		9.6	Degrees

**6.3.7.2.6.3.4 Sampling Rate: 96kHz or 88.2kHz**

Figure 6-96 shows the magnitude response and Figure 6-97 shows the pass-band ripple and phase deviation for this decimation filter with a sampling rate of 96kHz or 88.2kHz. Table 6-66 lists its specifications.

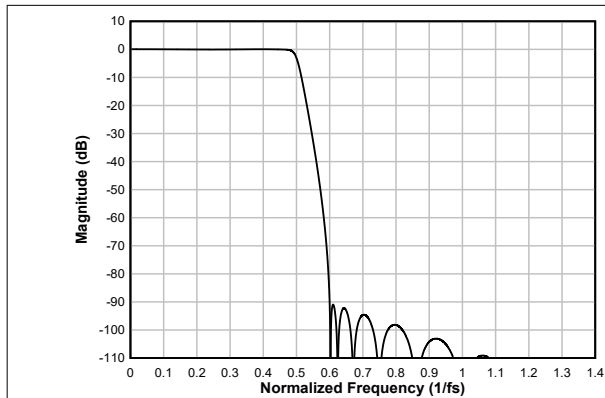
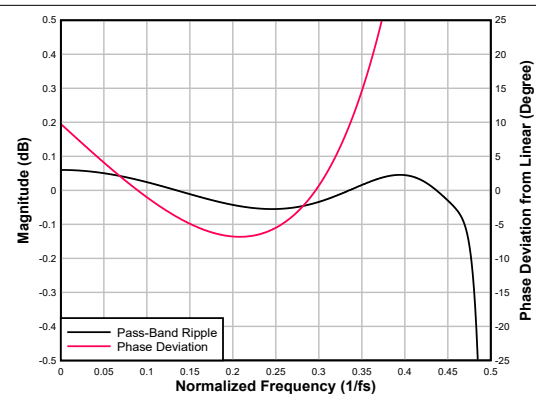

**Table 6-66. Ultra Low-latency Decimation Filter Specifications**

PARAMETER	TEST CONDITIONS	MIN	TYP	MAX	UNIT
Pass-band ripple	Frequency range is 0 to $0.456 \times f_S$	-0.02		0.03	dB
Stop-band attenuation	Frequency range is $0.599 \times f_S$ to $4 \times f_S$	85.6			dB
	Frequency range is $4 \times f_S$ onwards	95.7			
Group delay or latency	Frequency range is 0 to $0.325 \times f_S$		2.7		$1/f_S$
Group delay deviation	Frequency range is 0 to $0.325 \times f_S$	-0.29		0.761	$1/f_S$
Phase deviation	Frequency range is 0 to $0.325 \times f_S$	-6.6		9.6	Degrees

**6.3.7.2.6.3.5 Sampling Rate: 192kHz or 176.4kHz**

Figure 6-98 shows the magnitude response and Figure 6-99 shows the pass-band ripple and phase deviation for this decimation filter with a sampling rate of 192kHz or 176.4kHz. Table 6-67 lists its specifications.

**Figure 6-98. Ultra Low-latency Decimation Filter Magnitude Response****Figure 6-99. Ultra Low-latency Decimation Filter Pass-Band Ripple and Phase Deviation****Table 6-67. Ultra Low-latency Decimation Filter Specifications**

PARAMETER	TEST CONDITIONS	MIN	TYP	MAX	UNIT
Pass-band ripple	Frequency range is 0 to $0.456 \times f_S$	-0.06		0.06	dB
Stop-band attenuation	Frequency range is $0.571 \times f_S$ to $1.35 \times f_S$	90.5			dB
	Frequency range is $1.35 \times f_S$ onwards	86.9			
Group delay or latency	Frequency range is 0 to $0.325 \times f_S$		2.7		$1/f_S$
Group delay deviation	Frequency range is 0 to $0.325 \times f_S$	-0.293		0.794	$1/f_S$
Phase deviation	Frequency range is 0 to $0.325 \times f_S$	-6.8		9.8	Degrees



### 6.3.7.2.7 Automatic Gain Controller (AGC)

The device includes an automatic gain controller (AGC) for ADC recording. As shown in Figure 6-100, the AGC can be used to maintain a nominally constant output level when recording speech. Instead of manually setting the channel gain in AGC mode, the circuitry automatically adjusts the channel gain when the input signal becomes overly loud or very weak, such as when a person speaking into a microphone moves closer to or farther from the microphone. The AGC algorithm has several programmable parameters, including target level, maximum gain allowed, attack and release (or decay) time constants, and noise thresholds that allow the algorithm to be fine-tuned for any particular application. These are part of the programmable coefficients of the device for flexibility and can be configured using the programmable coefficient registers in B0\_P27 and B0\_P28.

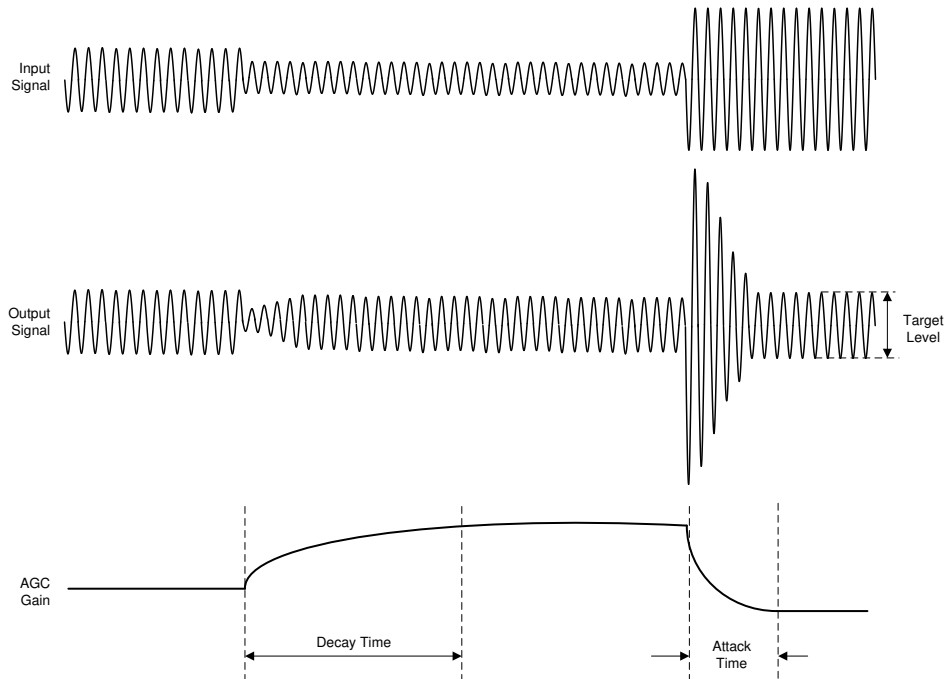

**Figure 6-100. AGC Characteristics**

The target level (AGC\_LVL) represents the nominal approximate output level at which the AGC attempts to hold the ADC output signal level. The TAD5212 allows programming of different target levels. The target level is recommended to be set with enough margin to prevent clipping when loud sounds occur. For further details on the AGC various configurable parameter and application use, see [Using the Automatic Gain Controller \(AGC\) in TAx5x1x Family application report](#). TI recommends using the PPC3 GUI for configuring the programmable coefficients settings; for more details see the [TAC5212EVM-PDK Evaluation module user's guide](#) and the [PurePath™ console graphical development suite](#).

### 6.3.7.2.8 Voice Activity Detection (VAD)

The TAD5212 supports voice activity detection (VAD) mode as part of low power activity detection (LPAD) schemes. In this mode, the TAD5212 continuously monitors one of the input channels for voice detection. The device consumes low quiescent current from the AVDD supply in this mode. This feature can be enabled by setting VAD\_EN (P0\_R120\_D[2]) to 1'b1. On detecting voice activity, the TAD5212 can alert the host through an interrupt or auto wake up and start recording based on the I<sup>2</sup>C programmed configuration. This alert can be configured through the LPAD\_MODE (P1\_R30\_D[7:6]) register bits.

The input channel for the VAD can be selected by setting the LPAD\_CH\_SEL (P1\_R30\_D[5:4]) register bits to an appropriate value. See the [How to use the Voice Activity Detection in the TAx511x and TAx521x application report](#) for further details.

### 6.3.7.2.9 Ultrasonic Activity Detection (UAD)

The TAD5212 supports ultrasonic activity detection (UAD) mode as part of low power activity detection (LPAD) schemes. In this mode, the TAD5212 continuously monitors one of the input channels for signals in the ultrasonic frequency band. The device consumes low quiescent current from the AVDD supply in this mode. This feature can be enabled by setting UAD\_EN (P0\_R120\_D[3]) to 1'b1. On detecting ultrasonic activity, the TAD5212 can alert the host through an interrupt or auto wake up and start recording based on the I<sup>2</sup>C programmed configuration. This alert can be configured through the LPAD\_MODE (P1\_R30\_D[7:6]) register bits.

The input channel for the UAD can be selected by setting the LPAD\_CH\_SEL (P1\_R30\_D[5:4]) register bits to an appropriate value. See the [How to use the Ultrasonic Activity Detection in the TAx511x and TAx521x](#) for further details.

### 6.3.8 Interrupts, Status, and Digital I/O Pin Multiplexing

Certain events in the device may require host processor intervention and can be used to trigger interrupts to the host processor. One such event is an audio serial interface (ASI) bus error. The device powers down the record channels if any faults are detected with the ASI bus error clocks, such as:

- Invalid FSYNC frequency
- Invalid BCLK to FSYNC ratio
- Long pauses of the BCLK or FSYNC clocks

When an ASI bus clock error is detected, the device shuts down all the record and playback channels as quickly as possible. After all ASI bus clock errors are resolved, the device volume ramps back to its previous state to recover the audio. During an ASI bus clock error, the internal interrupt request (IRQ) interrupt signal asserts low if the clock error interrupt mask register bit INT\_MASK0[7] (P1\_R47\_D[7]) is set low. The clock fault is also available for readback in the latched fault status register bit INT\_LTCH0 (P1\_R52), which is a read-only register. Reading the latched fault status register, INT\_LTCH0, clears all latched fault status. The device can be additionally configured to route the internal IRQ interrupt signal on the GPIOx or GPO1 pins and also can be configured as open-drain outputs so that these pins can be wire-ANDed to the open-drain interrupt outputs of other devices.

The IRQ interrupt signal can either be configured as active low or active high polarity by setting the INT\_POL (P0\_R66\_D[7]) register bit. This signal can also be configured as a single pulse or a series of pulses by programming the INT\_EVENT[1:0] (P0\_R66\_D[6:5]) register bits. If the interrupts are configured as a series of pulses, the events trigger the start of pulses that stop when the latched fault status register is read to determine the cause of the interrupt.

The device also supports read-only live-status registers to determine if the channels are powered up or down and if the device is in sleep mode or not. These status registers are located in the DEV\_STS0 (P0\_R121) and DEV\_STS1 (P0\_R122) register bits.

The device has a multifunctional GPIOx, GPI1, GPO1 pin that can be configured for a desired specific function. [Table 6-68](#) lists all possible allocations of these multifunctional pins for the various features.

**Table 6-68. Multifunction Pin Assignments**

ROW	PIN FUNCTION	GPIO1	GPIO2	GPO1	GPI1
—	—	GPIO1_CFG	GPIO2_CFG	GPO1_CFG	GPI1_CFG
—	—	P0_R10[7:4]	P0_R11[7:4]	P0_R12[7:4]	P0_R13[1]
A	Pin disabled	S <sup>(1)</sup>	S (default)	S (default)	S (default)
B	General-purpose output (GPO)	S	S	S	NS <sup>(2)</sup>
C	Interrupt output (IRQ)	S (default)	S	S	NS
D	Power down for all record channels	S	S	NS	S
E	Power down for all DAC channels	S	S	NS	S
F	PDM clock output (PDMCLK)	S	S	S	NS
G	PDM data input 1 (PDMIN1)	S	S	NS	S
H	PDM data input 2 (PDMIN2)	S	S	NS	S
I	MICBIAS on/off input (BIASEN)	S	S	NS	S
J	General-purpose input (GPI)	S	S	NS	S
K	Controller clock input (CCLK)	S	S	S	S
L	ASI daisy-chain input	S	S	NS	S
M	ASI DOUT	S	S	S	NS
N	ASI BCLK	S	S	S	S
O	ASI FSYNC	S	S	S	S
P	General Purpose Clock Out	S	S	S	NS
Q	ASI daisy-chain output	S	S	S	NS

(1) S means the feature mentioned in this row is *supported* for the respective GPIOx, GPO1, or GPI1 pin mentioned in this column.

(2) NS means the feature mentioned in this row is *not supported* for the respective GPIOx, GPO1, or GPI1 pin mentioned in this column.

Each GPO1 or GPIOx pin can be independently set for the desired drive configurations setting using the GPIOx\_DRV[2:0] or GPO1\_DRV[2:0] register bits in P0\_R10\_D[2:0], P0\_R11\_D[2:0] and P0\_R12\_D[2:0] respectively. [Table 6-69](#) lists the drive configuration settings.

**Table 6-69. GPIO or GPOx Pins Drive Configuration Settings**

P0_R10_D[2:0] : GPIO1_DRV[2:0]	GPIO OUTPUT DRIVE CONFIGURATION SETTINGS FOR GPIO1
000	The GPIO1 pin is set to high impedance (floated)
001	The GPIO1 pin is set to be driven active low or active high
010 (default)	The GPIO1 pin is set to be driven active low or weak high (on-chip pullup)
011	The GPIO1 pin is set to be driven active low or Hi-Z (floated)
100	The GPIO1 pin is set to be driven weak low (on-chip pulldown) or active high
101	The GPIO1 pin is set to be driven Hi-Z (floated) or active high
110 and 111	Reserved (do not use these settings)

When configured as a general-purpose output (GPO), the GPIOx or GPO1 pin values can be driven by writing the GPO\_GPI\_VAL (P0\_R14) registers. The GPIO\_MON bits (P0\_R14\_D[3:1]) can be used to readback the status of the GPIOx or GPI1 pin when configured as a general-purpose input (GPI).

### 6.3.9 Power Tune Mode

For low power applications, the TAD5212 offers options to configure the device in a power tune mode with typical power consumption 11mW for 2-Ch playback for a 1.8V supply. This mode can be configured by setting the PWR\_TUNE\_CFG0 (P0\_R78) register to 0xD4 and PWR\_TUNE\_CFG1 (P0\_R79) register to 0x96. For power savings, the DAC modulator clocks are set to run at 1.536MHz (the input and output data sample rates are multiples or submultiples of 48kHz) or 1.4112MHz (the input and output data sample rates are multiples or submultiples of 44.1kHz). For more details refer the [TAD5x1x Power Consumption Matrix Across Various Usage Scenarios application report](#) for the supported settings in this mode.

## 6.4 Device Functional Modes

### 6.4.1 Sleep Mode or Software Shutdown

In sleep mode or software shutdown mode, the device consumes very low quiescent current from the AVDD supply and, at the same time, allows the I<sup>2</sup>C or SPI communication to wake the device for active operation.

The device can also enter sleep mode when the host device sets the SLEEP\_ENZ (P0\_R2\_D[0]) bit to 1'b0. If the SLEEP\_ENZ bit is asserted low when the device is in active mode, the device ramps down the volume on the record and playback data, powers down the analog and digital blocks, and enters sleep mode. However, the device still continues to retain the last programmed value of the device configuration registers and programmable coefficients.

In sleep mode, do not perform any I<sup>2</sup>C or SPI transactions, except for exiting sleep mode in order to enter active mode. After entering sleep mode, wait at least 10ms before starting I<sup>2</sup>C or SPI transactions to exit sleep mode.

### 6.4.2 Active Mode

If the host device exits sleep mode by setting the SLEEP\_ENZ bit to 1'b1, the device enters active mode. In active mode, I<sup>2</sup>C or SPI transactions can be done to configure and power-up the device for active operation. After entering active mode, wait at least 2ms before starting any I<sup>2</sup>C or SPI transactions in order to allow the device to complete the internal wake-up sequence.

Read and write operations to the programmable coefficient registers (Section 7.2), and to the channel configuration registers must be done 10ms after exiting sleep mode.

After configuring all other registers for the target application and system settings, configure the input channel enable registers, P0\_R118 (CH\_EN). Lastly, configure the device power-up register, P0\_R120 (PWR\_CFG). All the programmable coefficient values must be written before powering up the respective channel.

In active mode, the power-up and power-down status of various blocks is monitored by reading the read-only device status bits located in the P0\_R121 (DEV\_STS0) and P0\_R122 (DEV\_STS1) registers.

### 6.4.3 Software Reset

A software reset can be done any time by asserting the SW\_RESET bit (P0\_R1\_D[0]), which is a self-clearing bit. This software reset immediately shuts down the device, and restores all device configuration registers and programmable coefficients to their default values.

## 6.5 Programming

The device contains configuration registers and programmable coefficients that can be set to the desired values for a specific system and application use. These registers are called *device control registers* and are each eight bits in width, mapped using a page scheme.

Each page contains 128 configuration registers. All device configuration registers are stored in page 0, which is the default page setting at power up and after a software reset. All programmable coefficient registers are located in page 0, page 1, and page 3. The current page of the device can be switched to a new desired page by using the PAGE[7:0] bits located in register 0 of every page.

### 6.5.1 Control Serial Interfaces

The device control registers can be accessed using either I<sup>2</sup>C or SPI communication to the device.

By monitoring the SDA\_PICO, SCL\_SCLK, GPO1\_POCL, and GPI1\_CSZ device pins, which are the multiplexed pins for the I<sup>2</sup>C or SPI Interface, the device automatically detects whether the host device is using I<sup>2</sup>C or SPI communication to configure the device. For a given end application, the host device must always use either the I<sup>2</sup>C or SPI interface, but not both, to configure the device refer to the Table 6-70.

**Table 6-70. I<sup>2</sup>C and SPI Address Configuration**

ADDR Setting	Mode	Device Address (7-bit)	Device Address (8-bit)
Short to Ground	I <sup>2</sup> C	0x50	0xA0
Pull down 4.7KOhm to ground	I <sup>2</sup> C	0x51	0xA2

**Table 6-70. I<sup>2</sup>C and SPI Address Configuration (continued)**

ADDR Setting	Mode	Device Address (7-bit)	Device Address (8-bit)
Pull up 22KOhm to AVDD	I <sup>2</sup> C	0x52	0xA4
Pull up 4.7KOhm to AVDD	I <sup>2</sup> C	0x53	0xA6
Short to AVDD	SPI	NA	NA

### 6.5.1.1 I<sup>2</sup>C Control Interface

The device supports the I<sup>2</sup>C control protocol as a target device, and is capable of operating in standard mode, fast mode, and fast mode plus. The I<sup>2</sup>C control protocol requires a 7-bit target address. The five most significant bits (MSBs) of the target address are fixed at 5'b10100 and cannot be changed. The two least significant bits (LSBs) are programmable and are controlled by the ADDR pin. Refer [Table 6-70](#) for the four possible device addresses supported by TAD5212 in I<sup>2</sup>C mode. If the I2C\_BRDCAST\_EN (P0\_R4\_D[1]) bit is set to 1'b1, then the 7-bit I<sup>2</sup>C target address is fixed to 7'b1010000 in order to allow simultaneous I<sup>2</sup>C broadcast communication to all TAD5212 devices in the system.

#### 6.5.1.1.1 General I<sup>2</sup>C Operation

The I<sup>2</sup>C bus employs two signals, SDA (data) and SCL (clock), to communicate between integrated circuits in a system using serial data transmission. The address and data 8-bit bytes are transferred MSB first. In addition, each byte transferred on the bus is acknowledged by the receiving device with an acknowledge bit. Each transfer operation begins with the controller device driving a start condition on the bus and ends with the controller device driving a stop condition on the bus. The bus uses transitions on the data pin (SDA) while the clock is at logic high to indicate start and stop conditions. A high-to-low transition on SDA indicates a start, and a low-to-high transition indicates a stop. Normal data-bit transitions must occur within the low time of the clock period.

The controller device drives a start condition followed by the 7-bit target address and the read/write (R/W) bit to open communication with another device and then waits for an acknowledgment condition. The target device holds SDA low during the acknowledge clock period to indicate acknowledgment. When this occurs, the controller device transmits the next byte of the sequence. Each target device is addressed by a unique 7-bit target address plus the R/W bit (1 byte). All compatible devices share the same signals via a bidirectional bus using a wired-AND connection.

There is no limit on the number of bytes that can be transmitted between start and stop conditions. When the last word transfers, the controller device generates a stop condition to release the bus. Figure 6-101 shows a generic data transfer sequence.

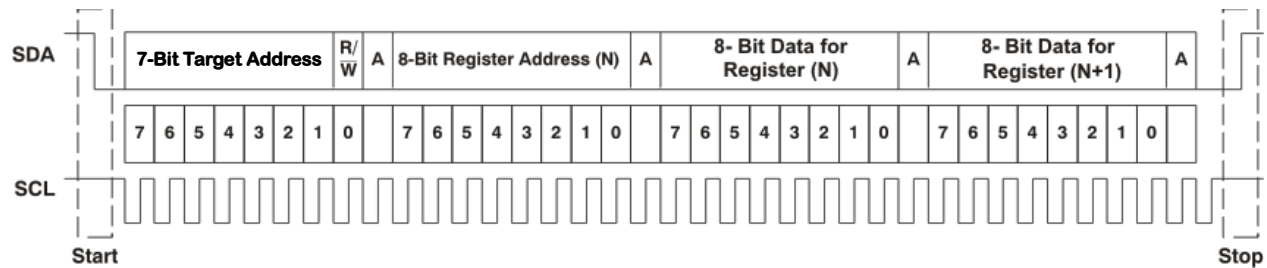

**Figure 6-101. Typical I<sup>2</sup>C Sequence**

In the system, use external pullup resistors for the SDA and SCL signals to set the logic high level for the bus. The SDA and SCL voltages must not exceed the device supply voltage, IOVDD.

#### 6.5.1.1.2 I<sup>2</sup>C Single-Byte and Multiple-Byte Transfers

The device I<sup>2</sup>C interface supports both single-byte and multiple-byte read/write operations for all registers. During multiple-byte read operations, the device responds with data, a byte at a time, starting at the register assigned, as long as the controller device continues to respond with acknowledgements.

The device supports sequential I<sup>2</sup>C addressing. For write transactions, if a register is issued followed by data for that register and all the remaining registers that follow, a sequential I<sup>2</sup>C write transaction takes place. For I<sup>2</sup>C sequential write transactions, the register issued then serves as the starting point, and the amount of data subsequently transmitted, before a stop or start is transmitted, determines how many registers are written.

##### 6.5.1.1.2.1 I<sup>2</sup>C Single-Byte Write

As shown in Figure 6-102, a single-byte data write transfer begins with the controller device transmitting a start condition followed by the I<sup>2</sup>C device address and the read/write bit. The read/write bit determines the direction of the data transfer. For a write-data transfer, the read/write bit must be set to 0. After receiving the correct I<sup>2</sup>C target address and the read/write bit, the device responds with an acknowledge bit (ACK). Next, the controller device transmits the register byte corresponding to the device internal register address being accessed. After receiving the register byte, the device again responds with an acknowledge bit (ACK). Then, the controller device transmits the byte of data to be written to the specified register. When finished, the target device responds with an acknowledge bit (ACK). Finally, the controller device transmits a stop condition to complete the single-byte data write transfer.

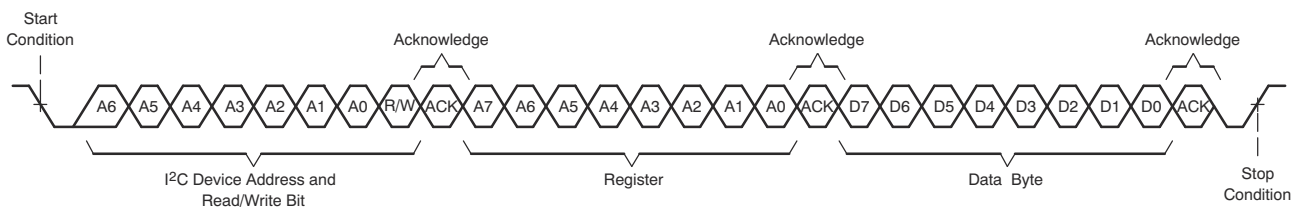

**Figure 6-102. I<sup>2</sup>C Single-Byte Write Transfer**

### 6.5.1.1.2.2 I<sup>2</sup>C Multiple-Byte Write

As shown in Figure 6-103, a multiple-byte data write transfer is identical to a single-byte data write transfer except that multiple data bytes are transmitted by the controller device to the target device. After receiving each data byte, the device responds with an acknowledge bit (ACK). Finally, the controller device transmits a stop condition after the last data-byte write transfer.

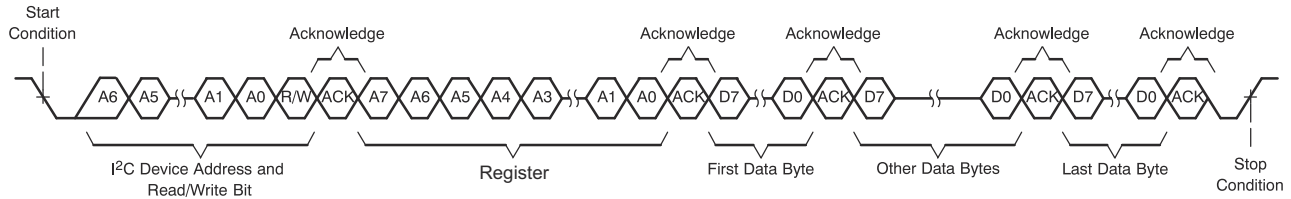
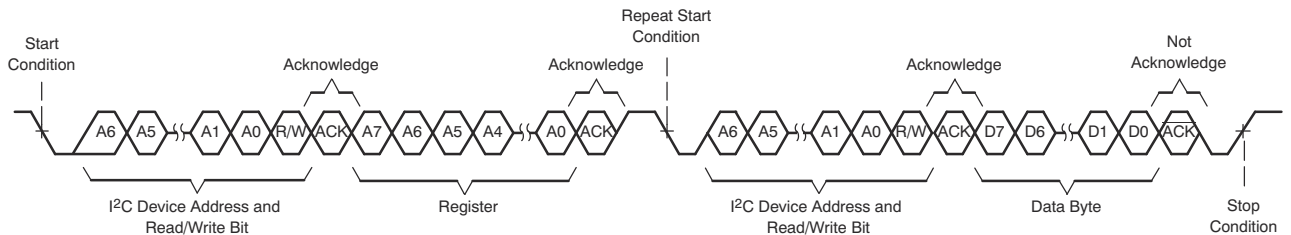

**Figure 6-103. I<sup>2</sup>C Multiple-Byte Write Transfer**

### 6.5.1.1.2.3 I<sup>2</sup>C Single-Byte Read

As shown in Figure 6-104, a single-byte data read transfer begins with the controller device transmitting a start condition followed by the I<sup>2</sup>C target address and the read/write bit. For the data read transfer, both a write followed by a read are done. Initially, a write is done to transfer the address byte of the internal register address to be read. As a result, the read/write bit is set to 0.

After receiving the target address and the read/write bit, the device responds with an acknowledge bit (ACK). The controller device then sends the internal register address byte, after which the device issues an acknowledge bit (ACK). The controller device transmits another start condition followed by the target address and the read/write bit again. This time, the read/write bit is set to 1, indicating a read transfer. Next, the device transmits the data byte from the register address being read. After receiving the data byte, the controller device transmits a not-acknowledge (NACK) followed by a stop condition to complete the single-byte data read transfer.



**Figure 6-104. I<sup>2</sup>C Single-Byte Read Transfer**

### 6.5.1.1.2.4 I<sup>2</sup>C Multiple-Byte Read

As shown in Figure 6-105, a multiple-byte data read transfer is identical to a single-byte data read transfer except that multiple data bytes are transmitted by the device to the controller device. With the exception of the last data byte, the controller device responds with an acknowledge bit after receiving each data byte. After receiving the last data byte, the controller device transmits a not-acknowledge (NACK) followed by a stop condition to complete the data read transfer.

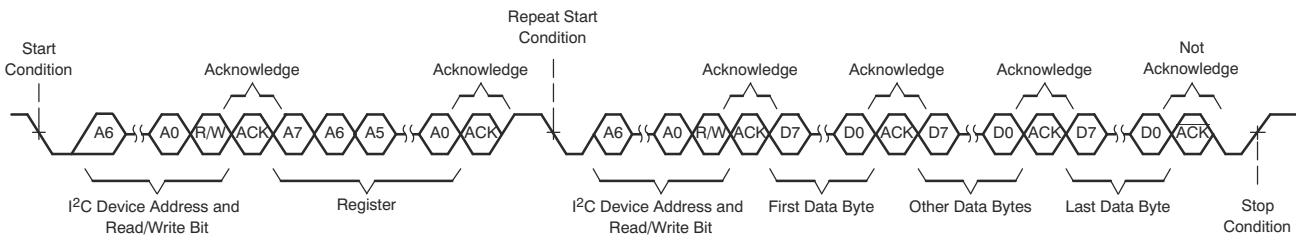

**Figure 6-105. I<sup>2</sup>C Multiple-Byte Read Transfer**

### 6.5.1.2 SPI Control Interface

The general SPI protocol allows full-duplex, synchronous, serial communication between a host processor (the controller) and peripheral devices. The SPI controller (in this case, the host processor) generates the synchronizing clock (driven on to SCLK) and initiates transmissions by taking the peripheral-select pin CSZ from high to low. The SPI peripheral devices (such as the TAD5212) depend on a controller device to start and synchronize transmissions. A transmission begins when initiated by an SPI controller. The byte from the SPI controller begins shifting in on the peripheral PICO pin under the control of the controller serial clock (driven onto SCLK). When the byte shifts in on the PICO pin, a byte shifts out on the POCI pin to the controller shift register.

Refer to [Table 6-71](#) to configure the device for SPI control. [Table 6-71](#) mentions the pin assignment for SPI mode of control.

**Table 6-71. Pin Assignments for SPI Control**

Pin Number	Pin Name	Pin Name in SPI Mode	Description
7	SCL	SCLK	SPI serial bit clock
8	SDA	PICO	SPI peripheral input pin
11	GP01	POCI	SPI peripheral output pin
12	GPI1	CSZ	SPI chip select pin

The TAD5212 supports a standard SPI control protocol with a clock polarity setting of 0 (typical microprocessor SPI control bit CPOL = 0) and a clock phase setting of 1 (typical microprocessor SPI control bit CPHA = 1). The CSZ pin can remain low between transmissions; however, the device only interprets the first eight bits transmitted after the falling edge of CSZ as a command byte, and the next eight bits as a data byte only if writing to a register. The device is entirely controlled by registers. Reading and writing these registers is accomplished by an 8-bit command sent to the PICO pin prior to the data for that register. [Table 6-72](#) shows the command structure. The first seven bits specify the address of the register that is being written or read, from 0 to 127 (decimal). The command word ends with an R/W bit, which specifies the direction of data flow on the serial bus.

In the case of a register write, set the R/W bit to 0. A second byte of data is sent to the PICO pin and contains the data to be written to the register. A register read is accomplished in a similar fashion. The 8-bit command word sends the 7-bit register address, followed by the R/W bit equal to 1 to signify a register read. The 8-bit register data is then clocked out of the device on the POCI pin during the second eight SCLK clocks in the frame. The device supports sequential SPI addressing for a multiple-byte data write/read transfer until the CSZ pin is pulled high. A multiple-byte data write or read transfer is identical to a single-byte data write or read transfer, respectively, until all data byte transfers complete. The host device must keep the CSZ pin low during all data byte transfers. [Figure 6-106](#) shows the single-byte write transfer and [Figure 6-107](#) shows the single-byte read transfer.

**Table 6-72. SPI Command Word**

BIT 7	BIT 6	BIT 5	BIT 4	BIT 3	BIT 2	BIT 1	BIT 0
ADDR(6)	ADDR(5)	ADDR(4)	ADDR(3)	ADDR(2)	ADDR(1)	ADDR(0)	R/WZ

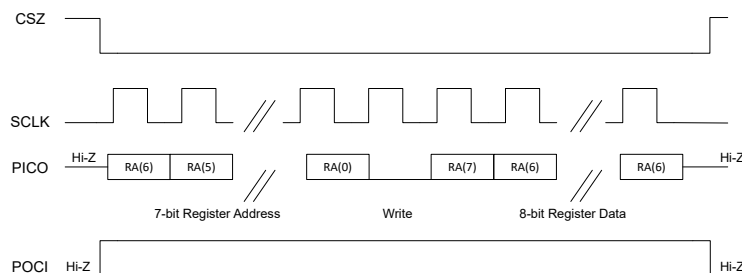

**Figure 6-106. SPI Single-Byte Write Transfer**



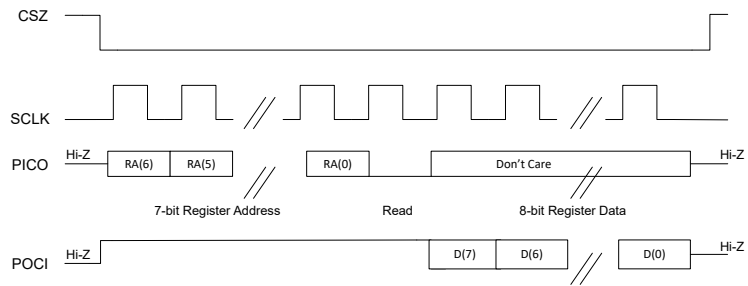

**Figure 6-107. SPI Single-Byte Read Transfer**

## 7 Register Maps

This section describes the control registers for the device in detail. All these registers are eight bits in width and allocated to device configuration and programmable coefficients settings. These registers are mapped internally using a page scheme that can be controlled using either I<sup>2</sup>C or SPI communication to the device. Each page contains 128 bytes of registers. All device configuration registers are stored in page 0, page 1 and page 3. Page 0 is the default page setting at power up (and after a software reset). The device current page can be switch to a new desired page by using the PAGE[7:0] bits located in register 0 of every page.

Do not read from or write to reserved pages or reserved registers. Write only default values for the reserved bits in the valid registers.

The procedure for register access across pages is:

- Select page *N* (write data *N* to register 0 regardless of the current page number)
- Read or write data from or to valid registers in page *N*
- Select the new page *M* (write data *M* to register 0 regardless of the current page number)
- Read or write data from or to valid registers in page *M*
- Repeat as needed

### 7.1 Device Configuration Registers

This section describes the device configuration registers for Page 0, Page 1 and Page 3 of the device. [Table 7-1](#) lists the access codes for the device registers.

**Table 7-1. Access Type Codes**

Access Type	Code	Description
Read Type		
R	R	Read
R-W	R/W	Read or write
Write Type		
W	W	Write

### 7.1.1 TAD5212\_B0\_P0 Registers

Table 7-2 lists the memory-mapped registers for the TAD5212\_B0\_P0 registers. All register offset addresses not listed in Table 7-2 should be considered as reserved locations and the register contents should not be modified.

**Table 7-2. TAD5212\_B0\_P0 Registers**

Address	Acronym	Register Name	Reset Value	Section
0x0	PAGE_CFG	Device page register	0x00	<a href="#">Section 7.1.1.1</a>
0x1	SW_RESET	Software reset register	0x00	<a href="#">Section 7.1.1.2</a>
0x2	DEV_MISC_CFG	Device miscellaneous configuration register	0x00	<a href="#">Section 7.1.1.3</a>
0x3	AVDD_IOVDD_STS	Supply status Register	0x00	<a href="#">Section 7.1.1.4</a>
0x4	MISC_CFG	Miscellaneous configuration register	0x00	<a href="#">Section 7.1.1.5</a>
0x5	MISC_CFG1	Miscellaneous configuration register 1	0x15	<a href="#">Section 7.1.1.6</a>
0x6	DAC_CFG_A0	DAC de-pop configuration register	0x35	<a href="#">Section 7.1.1.7</a>
0x7	MISC_CFG0	Miscellaneous configuration register 0	0x00	<a href="#">Section 7.1.1.8</a>
0xA	GPIO1_CFG0	GPIO1 configuration register 0	0x32	<a href="#">Section 7.1.1.9</a>
0xB	GPIO2_CFG0	GPIO2 configuration register 0	0x00	<a href="#">Section 7.1.1.10</a>
0xC	GPO1_CFG0	GPO1 configuration register 0	0x00	<a href="#">Section 7.1.1.11</a>
0xD	GPI_CFG	GPI1 configuration register 0	0x00	<a href="#">Section 7.1.1.12</a>
0xE	GPO_GPI_VAL	GPIO, GPO output value register	0x00	<a href="#">Section 7.1.1.13</a>
0xF	INTF_CFG0	Interface configuration register 0	0x00	<a href="#">Section 7.1.1.14</a>
0x10	INTF_CFG1	Interface configuration register 1	0x52	<a href="#">Section 7.1.1.15</a>
0x11	INTF_CFG2	Interface configuration register 2	0x80	<a href="#">Section 7.1.1.16</a>
0x12	INTF_CFG3	Interface configuration register 3	0x00	<a href="#">Section 7.1.1.17</a>
0x13	INTF_CFG4	Interface configuration register 4	0x00	<a href="#">Section 7.1.1.18</a>
0x14	INTF_CFG5	Interface configuration register 5	0x00	<a href="#">Section 7.1.1.19</a>
0x15	INTF_CFG6	Interface configuration register 6	0x00	<a href="#">Section 7.1.1.20</a>
0x18	ASI_CFG0	ASI configuration register 0	0x40	<a href="#">Section 7.1.1.21</a>
0x19	ASI_CFG1	ASI configuration register 1	0x00	<a href="#">Section 7.1.1.22</a>
0x1A	PASI_CFG0	Primary ASI configuration register 0	0x30	<a href="#">Section 7.1.1.23</a>
0x1B	PASI_TX_CFG0	PASI TX configuration register 0	0x00	<a href="#">Section 7.1.1.24</a>
0x1C	PASI_TX_CFG1	PASI TX configuration register 1	0x00	<a href="#">Section 7.1.1.25</a>
0x1D	PASI_TX_CFG2	PASI TX configuration register 2	0x00	<a href="#">Section 7.1.1.26</a>
0x1E	PASI_TX_CH1_CFG	PASI TX Channel 1 configuration register	0x20	<a href="#">Section 7.1.1.27</a>
0x1F	PASI_TX_CH2_CFG	PASI TX Channel 2 configuration register	0x21	<a href="#">Section 7.1.1.28</a>
0x20	PASI_TX_CH3_CFG	PASI TX Channel 3 configuration register	0x02	<a href="#">Section 7.1.1.29</a>
0x21	PASI_TX_CH4_CFG	PASI TX Channel 4 configuration register	0x03	<a href="#">Section 7.1.1.30</a>
0x22	PASI_TX_CH5_CFG	PASI TX Channel 5 configuration register	0x04	<a href="#">Section 7.1.1.31</a>
0x23	PASI_TX_CH6_CFG	PASI TX Channel 6 configuration register	0x05	<a href="#">Section 7.1.1.32</a>
0x24	PASI_TX_CH7_CFG	PASI TX Channel 7 configuration register	0x06	<a href="#">Section 7.1.1.33</a>
0x25	PASI_TX_CH8_CFG	PASI TX Channel 8 configuration register	0x07	<a href="#">Section 7.1.1.34</a>
0x26	PASI_RX_CFG0	PASI RX configuration register 0	0x00	<a href="#">Section 7.1.1.35</a>
0x27	PASI_RX_CFG1	PASI RX configuration register 1	0x00	<a href="#">Section 7.1.1.36</a>
0x28	PASI_RX_CH1_CFG	PASI RX Channel 1 configuration register	0x20	<a href="#">Section 7.1.1.37</a>
0x29	PASI_RX_CH2_CFG	PASI RX Channel 2 configuration register	0x21	<a href="#">Section 7.1.1.38</a>
0x2A	PASI_RX_CH3_CFG	PASI RX Channel 3 configuration register	0x02	<a href="#">Section 7.1.1.39</a>
0x2B	PASI_RX_CH4_CFG	PASI RX Channel 4 configuration register	0x03	<a href="#">Section 7.1.1.40</a>
0x2C	PASI_RX_CH5_CFG	PASI RX Channel 5 configuration register	0x04	<a href="#">Section 7.1.1.41</a>
0x2D	PASI_RX_CH6_CFG	PASI RX Channel 6 configuration register	0x05	<a href="#">Section 7.1.1.42</a>

**Table 7-2. TAD5212\_B0\_P0 Registers (continued)**

Address	Acronym	Register Name	Reset Value	Section
0x2E	PASI_RX_CH7_CFG	PASI RX Channel 7 configuration register	0x06	<a href="#">Section 7.1.1.43</a>
0x2F	PASI_RX_CH8_CFG	PASI RX Channel 8 configuration register	0x07	<a href="#">Section 7.1.1.44</a>
0x32	CLK_CFG0	Clock configuration register 0	0x00	<a href="#">Section 7.1.1.45</a>
0x33	CLK_CFG1	Clock configuration register 1	0x00	<a href="#">Section 7.1.1.46</a>
0x34	CLK_CFG2	Clock configuration register 2	0x40	<a href="#">Section 7.1.1.47</a>
0x35	CNT_CLK_CFG0	Controller mode clock configuration register 0	0x00	<a href="#">Section 7.1.1.48</a>
0x36	CNT_CLK_CFG1	Controller mode clock configuration register 1	0x00	<a href="#">Section 7.1.1.49</a>
0x37	CNT_CLK_CFG2	Controller mode clock configuration register 2	0x20	<a href="#">Section 7.1.1.50</a>
0x38	CNT_CLK_CFG3	Controller mode clock configuration register 3	0x00	<a href="#">Section 7.1.1.51</a>
0x39	CNT_CLK_CFG4	Controller mode clock configuration register 4	0x00	<a href="#">Section 7.1.1.52</a>
0x3A	CNT_CLK_CFG5	Controller mode clock configuration register 5	0x00	<a href="#">Section 7.1.1.53</a>
0x3B	CNT_CLK_CFG6	Controller mode clock configuration register 6	0x00	<a href="#">Section 7.1.1.54</a>
0x3C	CLK_ERR_STS0	Clock error and status register 0	0x00	<a href="#">Section 7.1.1.55</a>
0x3D	CLK_ERR_STS1	Clock error and status register 1	0x00	<a href="#">Section 7.1.1.56</a>
0x3E	CLK_DET_STS0	Clock ratio detection register 0	0x00	<a href="#">Section 7.1.1.57</a>
0x3F	CLK_DET_STS1	Clock ratio detection register 1	0x00	<a href="#">Section 7.1.1.58</a>
0x40	CLK_DET_STS2	Clock ratio detection register 2	0x00	<a href="#">Section 7.1.1.59</a>
0x41	CLK_DET_STS3	Clock ratio detection register 3	0x00	<a href="#">Section 7.1.1.60</a>
0x42	INT_CFG	Interrupt configuration register	0x00	<a href="#">Section 7.1.1.61</a>
0x43	DAC_FLT_CFG	Interrupt configuration register	0x54	<a href="#">Section 7.1.1.62</a>
0x4D	VREF_MICBIAS_CFG	VREF and MICBIAS configuration register	0x00	<a href="#">Section 7.1.1.63</a>
0x4E	PWR_TUNE_CFG0	Power tune configuration register 0	0x00	<a href="#">Section 7.1.1.64</a>
0x4F	PWR_TUNE_CFG1	Power tune configuration register 1	0x00	<a href="#">Section 7.1.1.65</a>
0x52	ADC_CH1_CFG2	ADC Channel 1 configuration register 2	0xA1	<a href="#">Section 7.1.1.66</a>
0x53	ADC_CH1_CFG3	ADC Channel 1 configuration register 3	0x80	<a href="#">Section 7.1.1.67</a>
0x54	ADC_CH1_CFG4	ADC Channel 1 configuration register 4	0x00	<a href="#">Section 7.1.1.68</a>
0x57	ADC_CH2_CFG2	Channel 2 configuration register 2	0xA1	<a href="#">Section 7.1.1.69</a>
0x58	ADC_CH2_CFG3	ADC Channel 2 configuration register 3	0x80	<a href="#">Section 7.1.1.70</a>
0x59	ADC_CH2_CFG4	ADC Channel 2 configuration register 4	0x00	<a href="#">Section 7.1.1.71</a>
0x5A	ADC_CH3_CFG0	ADC Channel 3 configuration register 0	0x00	<a href="#">Section 7.1.1.72</a>
0x5B	ADC_CH3_CFG2	ADC Channel 3 configuration register 2	0xA1	<a href="#">Section 7.1.1.73</a>
0x5C	ADC_CH3_CFG3	ADC Channel 3 configuration register 3	0x80	<a href="#">Section 7.1.1.74</a>
0x5D	ADC_CH3_CFG4	ADC Channel 3 configuration register 4	0x00	<a href="#">Section 7.1.1.75</a>
0x5E	ADC_CH4_CFG0	ADC Channel 4 configuration register 0	0x00	<a href="#">Section 7.1.1.76</a>
0x5F	ADC_CH4_CFG2	Channel 4 configuration register 2	0xA1	<a href="#">Section 7.1.1.77</a>
0x60	ADC_CH4_CFG3	ADC Channel 4 configuration register 3	0x80	<a href="#">Section 7.1.1.78</a>
0x61	ADC_CH4_CFG4	ADC Channel 4 configuration register 4	0x00	<a href="#">Section 7.1.1.79</a>
0x64	OUT1x_CFG0	Channel OUT1x configuration register 0	0x20	<a href="#">Section 7.1.1.80</a>
0x65	OUT1x_CFG1	Channel OUT1x configuration register 1	0x20	<a href="#">Section 7.1.1.81</a>
0x66	OUT1x_CFG2	Channel OUT2x configuration register 2	0x20	<a href="#">Section 7.1.1.82</a>
0x67	DAC_CH1A_CFG0	DAC Channel 1A configuration register 0	0xC9	<a href="#">Section 7.1.1.83</a>
0x68	DAC_CH1A_CFG1	DAC Channel 1A configuration register 1	0x80	<a href="#">Section 7.1.1.84</a>
0x69	DAC_CH1B_CFG0	DAC Channel 1B configuration register 0	0xC9	<a href="#">Section 7.1.1.85</a>
0x6A	DAC_CH1B_CFG1	DAC Channel 1B configuration register 1	0x80	<a href="#">Section 7.1.1.86</a>
0x6B	OUT2x_CFG0	Channel OUT2x configuration register 0	0x20	<a href="#">Section 7.1.1.87</a>

**Table 7-2. TAD5212\_B0\_P0 Registers (continued)**

Address	Acronym	Register Name	Reset Value	Section
0x6C	OUT2x_CFG1	Channel OUT2x configuration register 1	0x20	<a href="#">Section 7.1.1.88</a>
0x6D	OUT2x_CFG2	Channel OUT2x configuration register 2	0x20	<a href="#">Section 7.1.1.89</a>
0x6E	DAC_CH2A_CFG0	DAC Channel 2A configuration register 0	0xC9	<a href="#">Section 7.1.1.90</a>
0x6F	DAC_CH2A_CFG1	DAC Channel 2A configuration register 1	0x80	<a href="#">Section 7.1.1.91</a>
0x70	DAC_CH2B_CFG0	DAC Channel 2B configuration register 0	0xC9	<a href="#">Section 7.1.1.92</a>
0x71	DAC_CH2B_CFG1	DAC Channel 2B configuration register 1	0x80	<a href="#">Section 7.1.1.93</a>
0x72	DSP_CFG0	DSP configuration register 0	0x18	<a href="#">Section 7.1.1.94</a>
0x73	DSP_CFG1	DSP configuration register 0	0x18	<a href="#">Section 7.1.1.95</a>
0x76	CH_EN	Channel enable configuration register	0xCC	<a href="#">Section 7.1.1.96</a>
0x77	DYN_PUPD_CFG	Power up configuration register	0x00	<a href="#">Section 7.1.1.97</a>
0x78	PWR_CFG	Power up configuration register	0x00	<a href="#">Section 7.1.1.98</a>
0x79	DEV_STS0	Device status value register 0	0x00	<a href="#">Section 7.1.1.99</a>
0x7A	DEV_STS1	Device status value register 1	0x80	<a href="#">Section 7.1.1.100</a>
0x7E	I2C_CKSUM	I <sup>2</sup> C checksum register	0x00	<a href="#">Section 7.1.1.101</a>

#### 7.1.1.1 PAGE\_CFG Register (Address = 0x0) [Reset = 0x00]

PAGE\_CFG is shown in [Table 7-3](#).

Return to the [Summary Table](#).

The device memory map is divided into pages. This register sets the page.

**Table 7-3. PAGE\_CFG Register Field Descriptions**

Bit	Field	Type	Reset	Description
7-0	PAGE[7:0]	R/W	00000000b	These bits set the device page. 0d = Page 0 1d = Page 1 2d to 254d = Page 2 to page 254 respectively 255d = Page 255

#### 7.1.1.2 SW\_RESET Register (Address = 0x1) [Reset = 0x00]

SW\_RESET is shown in [Table 7-4](#).

Return to the [Summary Table](#).

This register is the software reset register. Asserting a software reset places all register values in their default power-on-reset (POR) state.

**Table 7-4. SW\_RESET Register Field Descriptions**

Bit	Field	Type	Reset	Description
7-1	RESERVED	R	0b	Reserved bits; Write only reset value
0	SW_RESET	R/W	0b	Software reset. This bit is self clearing. 0d = Do not reset 1d = Reset all registers to their reset values

#### 7.1.1.3 DEV\_MISC\_CFG Register (Address = 0x2) [Reset = 0x00]

DEV\_MISC\_CFG is shown in [Table 7-5](#).

Return to the [Summary Table](#).

This register configures miscellaneous device registers.

**Table 7-5. DEV\_MISC\_CFG Register Field Descriptions**

Bit	Field	Type	Reset	Description
7-6	RESERVED	R	0b	Reserved bits; Write only reset values
5-4	VREF_QCHG[1:0]	R/W	00b	The duration of the quick-charge for the VREF external capacitor is set using an internal series impedance of 200Ω. 0d = VREF quick-charge duration of 3.5 ms (typical) 1d = VREF quick-charge duration of 10 ms (typical) 2d = VREF quick-charge duration of 50 ms (typical) 3d = VREF quick-charge duration of 100 ms (typical)
3	SLEEP_EXIT_VREF_EN	R/W	0b	Sleep mode exit configuration 0d = Only DREG Enabled 1d = DREG and VREF enabled
2	AVDD_MODE	R/W	0b	AVDD mode configuration. 0d = Internal AREG regulator is used (Should be used for AVDD 3.3V Operation) 1d = AVDD 1.8V used directly for AREG (Strictly use this setting for AVDD 1.8V Operation)
1	IOVDD_IO_MODE	R/W	0b	IOVDD mode configuration. 0d = IOVDD at 3.3V / 1.8V / 1.2V (speed limitation applicable for 1.8V and 1.2V Operation) 1d = IOVDD at 1.8V / 1.2V only (no speed limitation - Strictly don't use this setting for IOVDD 3.3V Operation).
0	SLEEP_ENZ	R/W	0b	Sleep mode setting. 0d = Device is in sleep mode 1d = Device is not in sleep mode

#### 7.1.1.4 AVDD\_IOVDD\_STS Register (Address = 0x3) [Reset = 0x00]

AVDD\_IOVDD\_STS is shown in [Table 7-6](#).

Return to the [Summary Table](#).

This register contains status of the supply detection and brown-out.

**Table 7-6. AVDD\_IOVDD\_STS Register Field Descriptions**

Bit	Field	Type	Reset	Description
7	AVDD_MODE_STS	R	0b	AVDD mode status flag register. 0d = AVDD_MODE as per configured 1d = AVDD 3.3V Operation (AVDD_MODE forced to 0d)
6	IOVDD_IO_MODE_STS	R	0b	IOVDD mode status flag register. 0d = IOVDD_MODE as per configured 1d = IOVDD 3.3V Operation (IOVDD_IO_MODE forced to 0d)
5-2	RESERVED	R	0b	Reserved bits; Write only reset values
1	BRWNOUT_SHDN_STS	R	0b	Brownout shutdown status 0d = No brownout shutdown 1d = Brownout shutdown
0	BRWNOUT_SHDN_EXIT_SLEEP	R/W	0b	Brownout shutdown sleep exit config 0d = Stay in sleep mode 1d = Exit sleep mode

#### 7.1.1.5 MISC\_CFG Register (Address = 0x4) [Reset = 0x00]

MISC\_CFG is shown in [Table 7-7](#).

Return to the [Summary Table](#).

This register configures miscellaneous configuration registers.

**Table 7-7. MISC\_CFG Register Field Descriptions**

Bit	Field	Type	Reset	Description
7	RESERVED	R	0b	Reserved bit; Write only reset value
6	IGNORE_CLK_ERR	R/W	0b	Clock error detection action 0b = Clock error enabled 1b = Clock error disabled
5	RESERVED	R	0b	Reserved bit; Write only reset value
4	RESERVED	R	0b	Reserved bit; Write only reset value
3	RESERVED	R	0b	Reserved bit; Write only reset value
2	RESERVED	R	0b	Reserved bit; Write only reset value
1	I2C_BRDCAST_EN	R/W	0b	I <sup>2</sup> C broadcast addressing setting. 0d = I <sup>2</sup> C broadcast mode disabled 1d = I <sup>2</sup> C broadcast mode enabled; the I <sup>2</sup> C target address is fixed with pin-controlled LSB bits as '0'
0	RESERVED	R	0b	Reserved bit; Write only reset value

#### 7.1.1.6 MISC\_CFG1 Register (Address = 0x5) [Reset = 0x15]

MISC\_CFG1 is shown in [Table 7-8](#).

Return to the [Summary Table](#).

This register configures the miscellaneous configuration register 1.

**Table 7-8. MISC\_CFG1 Register Field Descriptions**

Bit	Field	Type	Reset	Description
7-6	INCAP_QCHG[1:0]	R/W	00b	The duration of the quick-charge for the external AC-coupling capacitor is set using an internal series impedance of 800Ω. 0d = INxP, INxM quick-charge duration of 2.5 ms (typical) 1d = INxP, INxM quick-charge duration of 12.5 ms (typical) 2d = INxP, INxM quick-charge duration of 25 ms (typical) 3d = INxP, INxM quick-charge duration of 50 ms (typical)
5-4	SHDN_CFG[1:0]	R/W	01b	Shutdown configuration. 0d = DREG is powered down immediately after IOVDD is deasserted 1d = DREG remains active to enable a clean shut down until a time-out (DREG_KA_TIME) is reached; after the time-out period, DREG is forced to power off 2d = DREG remains active until the device cleanly shuts down 3d = Reserved; Don't use
3-2	DREG_KA_TIME[1:0]	R/W	01b	These bits set how long DREG remains active after IOVDD is deasserted. 0d = DREG remains active for 30 ms (typical) 1d = DREG remains active for 25 ms (typical) 2d = DREG remains active for 10 ms (typical) 3d = DREG remains active for 5 ms (typical)
1-0	RESERVED	R	0b	Reserved bits; Write only reset values

#### 7.1.1.7 DAC\_CFG\_A0 Register (Address = 0x6) [Reset = 0x35]

DAC\_CFG\_A0 is shown in [Table 7-9](#).

Return to the [Summary Table](#).

This register configures the device DAC de-pop.

**Table 7-9. DAC\_CFG\_A0 Register Field Descriptions**

Bit	Field	Type	Reset	Description
7-6	RSERIES_DE_POP_INT[1:0]	R/W	00b	HP Amp series resistor select config. 0d = 1K 1d = 0.5K 2d = 0.33K 3d = 0.25k
5-4	RSERIES_DE_POP_MID[1:0]	R/W	11b	HP Amp series resistor select config. 0d = 1K 1d = 0.5K 2d = 0.33K 3d = 0.25k
3-0	PWR_UP_TIME_DE_PO P[3:0]	R/W	0101b	HP Amp external cap charging time config. 0d = 2ms 1d = 4ms 2d = 8ms 3d = 16ms 4d = 50ms 5d = 100ms 6d = 250ms 7d = 500ms 8d = 1s 9d = 5s 10d-15d = Reserved

**7.1.1.8 MISC\_CFG0 Register (Address = 0x7) [Reset = 0x00]**

MISC\_CFG0 is shown in [Table 7-10](#).

Return to the [Summary Table](#).

This register configures the miscellaneous configuration register 0.

**Table 7-10. MISC\_CFG0 Register Field Descriptions**

Bit	Field	Type	Reset	Description
7	DAC_ST_W_CAP_DIS	R/W	0b	DAC start with dc blocking capacitor discharge sequence. 0d = disable 1d = enable
6	DAC_DLYD_PWRUP	R/W	0b	DAC power up delayed config. 0d = disable 1d = enable (Delay power-up by based on DAC_DLYD_PWRUP_TIME config)
5	DAC_DLYD_PWRUP_TIME	R/W	0b	DAC power up delayed time config. 0d = 64-128ms 1d = 256-512ms
4	HW_RESET_ON_CLK_S TOP_EN	R/W	0b	Assertion of Hard Reset when clock selected by CLK_SRC_SEL is not available for 2ms config 0d = disable 1d = enable
3-0	RESERVED	R	0b	Reserved bits; Write only reset values

**7.1.1.9 GPIO1\_CFG0 Register (Address = 0xA) [Reset = 0x32]**

GPIO1\_CFG0 is shown in [Table 7-11](#).

Return to the [Summary Table](#).

This register is the GPIO1 configuration register 0.



**Table 7-11. GPIO1\_CFG0 Register Field Descriptions**

Bit	Field	Type	Reset	Description
7-4	GPIO1_CFG[3:0]	R/W	0011b	GPIO1 configuration. 0d = GPIO1 is disabled 1d = GPIO1 is configured as a general-purpose input (GPI) or any other input function 2d = GPIO1 is configured as a general-purpose output (GPO) 3d = GPIO1 is configured as a chip interrupt output (IRQ) 4d = GPIO1 is configured as a PDM clock output (PDMCLK) 5d = GPIO1 is configured as primary ASI DOUT 6d = GPIO1 is configured as primary ASI DOUT2 7d = GPIO1 is configured as secondary ASI DOUT 8d = GPIO1 is configured as secondary ASI DOUT2 9d = GPIO1 is configured as secondary ASI BCLK output 10d = GPIO1 is configured as secondary ASI FSYNC output 11d = GPIO1 is configured as general purpose CLKOUT 12d = GPIO1 is configured as PASI DOUT and SASI DOUT muxed 13d = GPIO1 is configured as DAISY_OUT for DIN Daisy 14d to 15d = Reserved
3	RESERVED	R	0b	Reserved bit; Write only reset value
2-0	GPIO1_DRV[2:0]	R/W	010b	GPIO1 output drive configuration. (Not valid if GPIO1_CFG configured as I <sup>2</sup> S out) 0d = Hi-Z output 1d = Drive active low and active high 2d = Drive active low and weak high 3d = Drive active low and Hi-Z 4d = Drive weak low and active high 5d = Drive Hi-Z and active high 6d to 7d = Reserved; Don't use

**7.1.1.10 GPIO2\_CFG0 Register (Address = 0xB) [Reset = 0x00]**

GPIO2\_CFG0 is shown in [Table 7-12](#).

Return to the [Summary Table](#).

This register is the GPIO2 configuration register 0.

**Table 7-12. GPIO2\_CFG0 Register Field Descriptions**

Bit	Field	Type	Reset	Description
7-4	GPIO2_CFG[3:0]	R/W	0000b	GPIO2 configuration. 0d = GPIO2 is disabled 1d = GPIO2 is configured as a general-purpose input (GPI) or any other input function 2d = GPIO2 is configured as a general-purpose output (GPO) 3d = GPIO2 is configured as a chip interrupt output (IRQ) 4d = GPIO2 is configured as a PDM clock output (PDMCLK) 5d = GPIO2 is configured as primary ASI DOUT 6d = GPIO2 is configured as primary ASI DOUT2 7d = GPIO2 is configured as secondary ASI DOUT 8d = GPIO2 is configured as secondary ASI DOUT2 9d = GPIO2 is configured as secondary ASI BCLK output 10d = GPIO2 is configured as secondary ASI FSYNC output 11d = GPIO2 is configured as general purpose CLKOUT 12d = GPIO2 is configured as PASI DOUT and SASI DOUT muxed 13d = GPIO2 is configured as DAISY_OUT for DIN Daisy 14d to 15d = Reserved
3	RESERVED	R	0b	Reserved bit; Write only reset value

**Table 7-12. GPIO2\_CFG0 Register Field Descriptions (continued)**

Bit	Field	Type	Reset	Description
2-0	GPIO2_DRV[2:0]	R/W	000b	GPIO2 output drive configuration. (Not valid if GPIO2_CFG configured as I <sup>2</sup> S out) 0d = Hi-Z output 1d = Drive active low and active high 2d = Drive active low and weak high 3d = Drive active low and Hi-Z 4d = Drive weak low and active high 5d = Drive Hi-Z and active high 6d to 7d = Reserved; Don't use

**7.1.1.11 GPO1\_CFG0 Register (Address = 0xC) [Reset = 0x00]**

GPO1\_CFG0 is shown in [Table 7-13](#).

Return to the [Summary Table](#).

This register is the GPO1 configuration register 0.

**Table 7-13. GPO1\_CFG0 Register Field Descriptions**

Bit	Field	Type	Reset	Description
7-4	GPO1_CFG[3:0]	R/W	0000b	GPO1 configuration. (For SPI mode, this pin act as POCI and the below configuration settings are not applicable) (Always buskeeper en is not supported when used as DOUT) 0d = GPO1 is disabled 1d = Reserved 2d = GPO1 is configured as a general-purpose output (GPO) 3d = GPO1 is configured as a chip interrupt output (IRQ) 4d = GPO1 is configured as a PDM clock output (PDMCLK) 5d = GPO1 is configured as primary ASI DOUT 6d = GPO1 is configured as primary ASI DOUT2 7d = GPO1 is configured as secondary ASI DOUT 8d = GPO1 is configured as secondary ASI DOUT2 9d = GPO1 is configured as secondary ASI BCLK output 10d = GPO1 is configured as secondary ASI FSYNC output 11d = GPO1 is configured as general purpose CLKOUT 12d = GPO1 is configured as PASI DOUT and SASI DOUT muxed 13d = GPO1 is configured as DAISY_OUT for DIN Daisy 14d to 15d = Reserved
3	RESERVED	R	0b	Reserved bit; Write only reset value
2-0	GPO1_DRV[2:0]	R/W	000b	GPO1 output drive configuration. (Not valid if GPO1_CFG configured as I <sup>2</sup> S out) (For SPI mode, this pin act as CSZ and the below configuration settings are not applicable) 0d = Hi-Z output 1d = Drive active low and active high 2d = Drive active low and weak high 3d = Drive active low and Hi-Z 4d = Drive weak low and active high 5d = Drive Hi-Z and active high 6d to 7d = Reserved; Don't use

**7.1.1.12 GPI\_CFG Register (Address = 0xD) [Reset = 0x00]**

GPI\_CFG is shown in [Table 7-14](#).

Return to the [Summary Table](#).

This register is the GPI1 configuration register 0.

**Table 7-14. GPI\_CFG Register Field Descriptions**

Bit	Field	Type	Reset	Description
7-2	RESERVED	R	0b	Reserved bits; Write only reset values
1	GPI1_CFG	R/W	0b	GPI1 configuration. (For SPI mode, this pin act as CSZ and the below configuration settings are not applicable) 0d = GPI1 is disabled 1d = GPI1 is configured as a general-purpose input (GPI) or any other input function
0	RESERVED	R	0b	Reserved bit; Write only reset value

#### 7.1.1.13 GPO\_GPI\_VAL Register (Address = 0xE) [Reset = 0x00]

GPO\_GPI\_VAL is shown in [Table 7-15](#).

Return to the [Summary Table](#).

This register is the GPIO and GPO output value register.

**Table 7-15. GPO\_GPI\_VAL Register Field Descriptions**

Bit	Field	Type	Reset	Description
7	GPIO1_VAL	R/W	0b	GPIO1 output value when configured as a GPO. 0d = Drive the output with a value of 0 1d = Drive the output with a value of 1
6	GPIO2_VAL	R/W	0b	GPIO2 output value when configured as a GPO. 0d = Drive the output with a value of 0 1d = Drive the output with a value of 1
5	GPO1_VAL	R/W	0b	GPO1 output value when configured as a GPO. 0d = Drive the output with a value of 0 1d = Drive the output with a value of 1
4	RESERVED	R	0b	Reserved bit; Write only reset value
3	GPIO1_MON	R	0b	GPIO1 monitor value when configured as a GPI. 0d = Input monitor value 0 1d = Input monitor value 1
2	GPIO2_MON	R	0b	GPIO2 monitor value when configured as a GPI. 0d = Input monitor value 0 1d = Input monitor value 1
1	GPI1_MON	R	0b	GPI1 monitor value when configured as a GPI. 0d = Input monitor value 0 1d = Input monitor value 1
0	RESERVED	R	0b	Reserved bit; Write only reset value

#### 7.1.1.14 INTF\_CFG0 Register (Address = 0xF) [Reset = 0x00]

INTF\_CFG0 is shown in [Table 7-16](#).

Return to the [Summary Table](#).

This register is the interface configuration register 0.

**Table 7-16. INTF\_CFG0 Register Field Descriptions**

Bit	Field	Type	Reset	Description
7	RESERVED	R	0b	Reserved bit; Write only reset value
6-5	CCLK_SEL[1:0]	R/W	00b	CCLK select configuration. 0d = CCLK is disabled 1d = GPIO1 2d = GPIO2 3d = GPI1

**Table 7-16. INTF\_CFG0 Register Field Descriptions (continued)**

Bit	Field	Type	Reset	Description
4-2	PASI_DIN2_SEL[2:0]	R/W	000b	Primary ASI DIN2 select configuration. 0d = Primary ASI DIN2 is disabled 1d = GPIO1 2d = GPIO2 3d = GPI1 4d = DOUT 5d = Primary ASI DIN 6d to 7d = Reserved
1	PASI_BCLK_SEL	R/W	0b	Primary ASI BCLK select configuration. 0d = Primary ASI BCLK is BCLK 1d = Primary ASI BCLK is Secondary ASI BCLK
0	PASI_FSYNC_SEL	R/W	0b	Primary ASI FSYNC select configuration. 0d = Primary ASI FSYNC is FSYNC 1d = Primary ASI FSYNC is Secondary ASI FSYNC

**7.1.1.15 INTF\_CFG1 Register (Address = 0x10) [Reset = 0x52]**

INTF\_CFG1 is shown in [Table 7-17](#).

Return to the [Summary Table](#).

This register is the interface configuration register 1.

**Table 7-17. INTF\_CFG1 Register Field Descriptions**

Bit	Field	Type	Reset	Description
7-4	DOUT_SEL[3:0]	R/W	0101b	DOUT select configuration. 0d = DOUT is disabled 1d = DOUT is configured as input 2d = DOUT is configured as a general-purpose output (GPO) 3d = DOUT is configured as a chip interrupt output (IRQ) 4d = DOUT is configured as a PDM clock output (PDMCLK) 5d = DOUT is configured as primary ASI DOUT 6d = DOUT is configured as primary ASI DOUT2 7d = DOUT is configured as secondary ASI DOUT 8d = DOUT is configured as secondary ASI DOUT2 9d = DOUT is configured as secondary ASI BCLK output 10d = DOUT is configured as secondary ASI FSYNC output 11d = DOUT is configured as general purpose CLKOUT 12d = DOUT is configured as PASI DOUT and SASI DOUT muxed 13d = DOUT is configured as DAISY_OUT for DIN Daisy 14d = DOUT is configured as DIN (LOOPBACK) 15d = Reserved
3	DOUT_VAL	R/W	0b	DOUT output value when configured as a GPO. 0d = Drive the output with a value of 0 1d = Drive the output with a value of 1
2-0	DOUT_DRV[2:0]	R/W	010b	DOUT output drive configuration. 0d = Hi-Z output 1d = Drive active low and active high 2d = Drive active low and weak high 3d = Drive active low and Hi-Z 4d = Drive weak low and active high 5d = Drive Hi-Z and active high 6d to 7d = Reserved; Don't use

**7.1.1.16 INTF\_CFG2 Register (Address = 0x11) [Reset = 0x80]**

INTF\_CFG2 is shown in [Table 7-18](#).

Return to the [Summary Table](#).

This register is the interface configuration register 2.

**Table 7-18. INTF\_CFG2 Register Field Descriptions**

Bit	Field	Type	Reset	Description
7	PASI_DIN_EN	R/W	1b	Primary ASI DIN enable configuration. 0d = Primary ASI DIN is disabled 1d = Primary ASI DIN is enabled
6-4	SASI_FSYNC_SEL[2:0]	R/W	000b	Secondary ASI FSYNC select configuration. 0d = Secondary ASI disabled 1d = GPIO1 2d = GPIO2 3d = GPI1 4d = Reserved 5d = Primary ASI FSYNC 6d to 7d = Reserved
3-1	SASI_BCLK_SEL[2:0]	R/W	000b	Secondary ASI BCLK select configuration. 0d = Secondary ASI disabled 1d = GPIO1 2d = GPIO2 3d = GPI1 4d = Reserved 5d = Primary ASI BCLK 6d to 7d = Reserved
0	RESERVED	R	0b	Reserved bit; Write only reset value

#### 7.1.1.17 INTF\_CFG3 Register (Address = 0x12) [Reset = 0x00]

INTF\_CFG3 is shown in [Table 7-19](#).

Return to the [Summary Table](#).

This register is the interface configuration register 3.

**Table 7-19. INTF\_CFG3 Register Field Descriptions**

Bit	Field	Type	Reset	Description
7-5	SASI_DIN_SEL[2:0]	R/W	000b	Secondary ASI DIN select configuration. 0d = Secondary ASI DIN is disabled 1d = GPIO1 2d = GPIO2 3d = GPI1 4d = DOUT 5d = Primary ASI DIN 6d to 7d = Reserved
4-2	SASI_DIN2_SEL[2:0]	R/W	000b	Secondary ASI DIN2 select configuration. 0d = Secondary ASI DIN2 is disabled 1d = GPIO1 2d = GPIO2 3d = GPI1 4d = DOUT 5d = Primary ASI DIN 6d to 7d = Reserved
1-0	RESERVED	R	0b	Reserved bits; Write only reset values

#### 7.1.1.18 INTF\_CFG4 Register (Address = 0x13) [Reset = 0x00]

INTF\_CFG4 is shown in [Table 7-20](#).

Return to the [Summary Table](#).

This register is the interface configuration register 4.

**Table 7-20. INTF\_CFG4 Register Field Descriptions**

Bit	Field	Type	Reset	Description
7	PDM_CH1_SEL	R/W	0b	PDM select configuration for channel 1 of record path. 0d = Reserved 1d = Channel 1 is digital (PDM) type on the record path
6	PDM_CH2_SEL	R/W	0b	PDM select configuration for channel 2 of record path. 0d = Reserved 1d = Channel 2 is digital (PDM) type on the record path
5	PDMDIN1_EDGE	R/W	0b	PDMCLK latching edge used for channel 1 and channel 2 data. 0d = Channel 1 data are latched on the negative edge, channel 2 data are latched on the positive edge 1d = Channel 1 data are latched on the positive edge, channel 2 data are latched on the negative edge
4	PDMDIN2_EDGE	R/W	0b	PDMCLK latching edge used for channel 3 and channel 4 data. 0d = Channel 3 data are latched on the negative edge, channel 4 data are latched on the positive edge 1d = Channel 3 data are latched on the positive edge, channel 4 data are latched on the negative edge
3-2	PDM_DIN1_SEL[1:0]	R/W	00b	PDM data channels 1 and 2 select configuration. 0d = PDM data channels 1 and 2 are disabled 1d = GPIO1 2d = GPIO2 3d = GPI1
1-0	PDM_DIN2_SEL[1:0]	R/W	00b	PDM data channels 3 and 4 select configuration. 0d = PDM data channels 3 and 4 are disabled 1d = GPIO1 2d = GPIO2 3d = GPI1

**7.1.1.19 INTF\_CFG5 Register (Address = 0x14) [Reset = 0x00]**

INTF\_CFG5 is shown in [Table 7-21](#).

Return to the [Summary Table](#).

This register is the interface configuration register 5.

**Table 7-21. INTF\_CFG5 Register Field Descriptions**

Bit	Field	Type	Reset	Description
7	PDM_DIN_SEL_OVRD	R/W	0b	PDM data channels (1 and 2)/(3 and 4) select configuration override. 0d = No Override 1d = PDM_DIN1/2_SEL if configured as GPI1 will be overridden as DIN
6	DOOUT_WITH_DIN	R/W	0b	DOOUT used as both ASI OUT and ASI IN 0d = DOOUT based on DOOUT_SEL 1d = DOOUT used as both ASI OUT and ASI DIN
5-4	PD_ADC_GPIO[1:0]	R/W	00b	Power down ADC using GPIO select configuration.(ADC powered down if any one of the PD_ADC_GPIO/ADC_PDZ is configured power down) 0d = Power down ADC using GPIO is disabled 1d = Power down ADC using GPIO1 2d = Power down ADC using GPIO2 3d = Power down ADC using GPI1
3-2	PD_DAC_GPIO[1:0]	R/W	00b	Power down DAC using GPIO select configuration.(DAC powered down if any one of the PD_DAC_GPIO/DAC_PDZ is configured power down) 0d = Power down DAC using GPIO is disabled 1d = Power down DAC using GPIO1 2d = Power down DAC using GPIO2 3d = Power down DAC using GPI1

**Table 7-21. INTF\_CFG5 Register Field Descriptions (continued)**

Bit	Field	Type	Reset	Description
1	PLIM_GPIO	R/W	0b	PLIM using GPIO1 configuration. 0d = PLIM using GPIO1 is disabled 1d = PLIM using GPIO1
0	GPA_GPIO	R/W	0b	GPA using GPIO1 configuration. 0d = GPA using GPIO1 is disabled 1d = GPA using GPIO1

#### 7.1.1.20 INTF\_CFG6 Register (Address = 0x15) [Reset = 0x00]

INTF\_CFG6 is shown in [Table 7-22](#).

Return to the [Summary Table](#).

This register is the interface configuration register 6.

**Table 7-22. INTF\_CFG6 Register Field Descriptions**

Bit	Field	Type	Reset	Description
7-6	EN_MBIAS_GPIO[1:0]	R/W	00b	Enable MICBIAS using GPIO select configuration. 0d = Enable MICBIAS using GPIO is disabled 1d = Enable MICBIAS using GPIO1 2d = Enable MICBIAS using GPIO2 3d = Enable MICBIAS using GPI1
5-4	RESERVED	R	0b	Reserved bits; Write only reset values
3-0	RESERVED	R	0b	Reserved bits; Write only reset value

#### 7.1.1.21 ASI\_CFG0 Register (Address = 0x18) [Reset = 0x40]

ASI\_CFG0 is shown in [Table 7-23](#).

Return to the [Summary Table](#).

This register is the ASI configuration register 0.

**Table 7-23. ASI\_CFG0 Register Field Descriptions**

Bit	Field	Type	Reset	Description
7	PASI_DIS	R/W	0b	Disable or enable primary ASI (PASI). 0d = Primary ASI enabled 1d = Primary ASI disabled
6	SASI_DIS	R/W	1b	Disable or enable secondary ASI (SASI). 0d = Secondary ASI enabled 1d = Secondary ASI disabled
5	SASI_CFG_GANG	R/W	0b	All configurations of secondary ASI ganged with primary ASI. 0d = Secondary ASI has independent configurations 1d = Secondary ASI configurations same as primary ASI
4-3	DAISY_EN[1:0]	R/W	00b	Daisy chain feature enable (Only 1 ASI with 1 DOUT AND DIN available) 0d = Daisy chain disabled 1d = PASI daisy chain enabled (Secondary ASI not available) 2d = SASI daisy chain enabled (Primary ASI not available) 3d = Reserved; Don't use

**Table 7-23. ASI\_CFG0 Register Field Descriptions (continued)**

Bit	Field	Type	Reset	Description
2-0	DAISY_IN_SEL[2:0]	R/W	000b	Daisy input select configuration. 0d = Daisy input disabled 1d = GPIO1 2d = GPIO2 3d = GPI1 4d = Reserved 5d = DIN 6d to 7d = Reserved

**7.1.1.22 ASI\_CFG1 Register (Address = 0x19) [Reset = 0x00]**

ASI\_CFG1 is shown in [Table 7-24](#).

Return to the [Summary Table](#).

This register is the ASI configuration register 1.

**Table 7-24. ASI\_CFG1 Register Field Descriptions**

Bit	Field	Type	Reset	Description
7-6	ASI_DOUT_CFG[1:0]	R/W	00b	ASI data output configuration. 0d = 1 data output for Primary ASI and 1 data output for Secondary ASI 1d = 2 data outputs for Primary ASI 2d = 2 data outputs for Secondary ASI 3d = Reserved; Don't use
5-4	ASI_DIN_CFG[1:0]	R/W	00b	ASI data input configuration. 0d = 1 data input for Primary ASI and 1 data input for Secondary ASI 1d = 2 data inputs for Primary ASI 2d = 2 data inputs for Secondary ASI 3d = Reserved; Don't use
3	DAISY_DIR	R/W	0b	Daisy direction configuration. 0d = ASI DOUT daisy 1d = ASI DIN daisy
2	RESERVED	R	0b	Reserved bit; Write only reset value
1	RESERVED	R	0b	Reserved bit; Write only reset value
0	RESERVED	R	0b	Reserved bit; Write only reset value

**7.1.1.23 PASI\_CFG0 Register (Address = 0x1A) [Reset = 0x30]**

PASI\_CFG0 is shown in [Table 7-25](#).

Return to the [Summary Table](#).

This register is the ASI configuration register 0.

**Table 7-25. PASI\_CFG0 Register Field Descriptions**

Bit	Field	Type	Reset	Description
7-6	PASI_FORMAT[1:0]	R/W	00b	Primary ASI protocol format. 0d = TDM mode 1d = I <sup>2</sup> S mode 2d = LJ (left-justified) mode 3d = Reserved; Don't use
5-4	PASI_WLEN[1:0]	R/W	11b	Primary ASI word or slot length. 0d = 16 bits (Recommended this setting to be used with 10kΩ input impedance configuration) 1d = 20 bits 2d = 24 bits 3d = 32 bits



**Table 7-25. PASI\_CFG0 Register Field Descriptions (continued)**

Bit	Field	Type	Reset	Description
3	PASI_FSYNC_POL	R/W	0b	ASI FSYNC polarity (for PASI protocol only). 0d = Default polarity as per standard protocol 1d = Inverted polarity with respect to standard protocol
2	PASI_BCLK_POL	R/W	0b	ASI BCLK polarity (for PASI protocol only). 0d = Default polarity as per standard protocol 1d = Inverted polarity with respect to standard protocol
1	PASI_BUS_ERR	R/W	0b	ASI bus error detection. 0d = Enable bus error detection 1d = Disable bus error detection
0	PASI_BUS_ERR_RCOV	R/W	0b	ASI bus error auto resume. 0d = Enable auto resume after bus error recovery 1d = Disable auto resume after bus error recovery and remain powered down until host configures the device

#### 7.1.1.24 PASI\_TX\_CFG0 Register (Address = 0x1B) [Reset = 0x00]

PASI\_TX\_CFG0 is shown in [Table 7-26](#).

Return to the [Summary Table](#).

This register is the PASI TX configuration register 0.

**Table 7-26. PASI\_TX\_CFG0 Register Field Descriptions**

Bit	Field	Type	Reset	Description
7	PASI_TX_EDGE	R/W	0b	Primary ASI data output (on the primary and secondary data pin) transmit edge. 0d = Default edge as per the protocol configuration setting in PASI_BCLK_POL 1d = Inverted following edge (half cycle delay) with respect to the default edge setting
6	PASI_TX_FILL	R/W	0b	Primary ASI data output (on the primary and secondary data pin) for any unused cycles 0d = Always transmit 0 for unused cycles 1d = Always use Hi-Z for unused cycles
5	PASI_TX_LSB	R/W	0b	Primary ASI data output (on the primary and secondary data pin) for LSB transmissions. 0d = Transmit the LSB for a full cycle 1d = Transmit the LSB for the first half cycle and Hi-Z for the second half cycle
4-3	PASI_TX_KEEPER[1:0]	R/W	00b	Primary ASI data output (on the primary and secondary data pin) bus keeper. 0d = Bus keeper is always disabled 1d = Bus keeper is always enabled 2d = Bus keeper is enabled during LSB transmissions only for one cycle 3d = Bus keeper is enabled during LSB transmissions only for one and half cycles
2	PASI_TX_USE_INT_FSYNC	R/W	0b	Primary ASI uses internal FSYNC for output data generation in Controller mode configuration as applicable. 0d = Use external FSYNC for ASI protocol data generation 1d = Use internal FSYNC for ASI protocol data generation
1	PASI_TX_USE_INT_BCLK	R/W	0b	Primary ASI uses internal BCLK for output data generation in Controller mode configuration. 0d = Use external BCLK for ASI protocol data generation 1d = Use internal BCLK for ASI protocol data generation

**Table 7-26. PASI\_TX\_CFG0 Register Field Descriptions (continued)**

Bit	Field	Type	Reset	Description
0	PASI_TDM_PULSE_WIDT H	R/W	0b	Primary ASI fsync pulse width in TDM format. (Valid for Controller mode) 0d = Fsync pulse is 1 bclk period wide 1d = Fsync pulse is 2 bclk period wide

**7.1.1.25 PASI\_TX\_CFG1 Register (Address = 0x1C) [Reset = 0x00]**

PASI\_TX\_CFG1 is shown in [Table 7-27](#).

Return to the [Summary Table](#).

This register is the PASI TX configuration register 1.

**Table 7-27. PASI\_TX\_CFG1 Register Field Descriptions**

Bit	Field	Type	Reset	Description
7-5	RESERVED	R	0b	Reserved bits; Write only reset values
4-0	PASI_TX_OFFSET[4:0]	R/W	00000b	Primary ASI output data MSB slot 0 offset (on the primary and secondary data pin). 0d = ASI data MSB location has no offset and is as per standard protocol 1d = ASI data MSB location (TDM mode is slot 0 or I <sup>2</sup> S, LJ mode is the left and right slot 0) offset of one BCLK cycle with respect to standard protocol 2d = ASI data MSB location (TDM mode is slot 0 or I <sup>2</sup> S, LJ mode is the left and right slot 0) offset of two BCLK cycles with respect to standard protocol 3d to 30d = ASI data MSB location (TDM mode is slot 0 or I <sup>2</sup> S, LJ mode is the left and right slot 0) offset assigned as per configuration 31d = ASI data MSB location (TDM mode is slot 0 or I <sup>2</sup> S, LJ mode is the left and right slot 0) offset of 31 BCLK cycles with respect to standard protocol

**7.1.1.26 PASI\_TX\_CFG2 Register (Address = 0x1D) [Reset = 0x00]**

PASI\_TX\_CFG2 is shown in [Table 7-28](#).

Return to the [Summary Table](#).

This register is the PASI TX configuration register 2.

**Table 7-28. PASI\_TX\_CFG2 Register Field Descriptions**

Bit	Field	Type	Reset	Description
7	PASI_TX_CH8_SEL	R/W	0b	Primary ASI output channel 8 select. 0d = Primary ASI channel 8 output is on DOUT 1d = Primary ASI channel 8 output is on DOUT2
6	PASI_TX_CH7_SEL	R/W	0b	Primary ASI output channel 7 select. 0d = Primary ASI channel 7 output is on DOUT 1d = Primary ASI channel 7 output is on DOUT2
5	PASI_TX_CH6_SEL	R/W	0b	Primary ASI output channel 6 select. 0d = Primary ASI channel 6 output is on DOUT 1d = Primary ASI channel 6 output is on DOUT2
4	PASI_TX_CH5_SEL	R/W	0b	Primary ASI output channel 5 select. 0d = Primary ASI channel 5 output is on DOUT 1d = Primary ASI channel 5 output is on DOUT2
3	PASI_TX_CH4_SEL	R/W	0b	Primary ASI output channel 4 select. 0d = Primary ASI channel 4 output is on DOUT 1d = Primary ASI channel 4 output is on DOUT2

**Table 7-28. PASI\_TX\_CFG2 Register Field Descriptions (continued)**

Bit	Field	Type	Reset	Description
2	PASI_TX_CH3_SEL	R/W	0b	Primary ASI output channel 3 select. 0d = Primary ASI channel 3 output is on DOUT 1d = Primary ASI channel 3 output is on DOUT2
1	PASI_TX_CH2_SEL	R/W	0b	Primary ASI output channel 2 select. 0d = Primary ASI channel 2 output is on DOUT 1d = Primary ASI channel 2 output is on DOUT2
0	PASI_TX_CH1_SEL	R/W	0b	Primary ASI output channel 1 select. 0d = Primary ASI channel 1 output is on DOUT 1d = Primary ASI channel 1 output is on DOUT2

#### 7.1.1.27 PASI\_TX\_CH1\_CFG Register (Address = 0x1E) [Reset = 0x20]

PASI\_TX\_CH1\_CFG is shown in [Table 7-29](#).

Return to the [Summary Table](#).

This register is the PASI TX Channel 1 configuration register.

**Table 7-29. PASI\_TX\_CH1\_CFG Register Field Descriptions**

Bit	Field	Type	Reset	Description
7-6	RESERVED	R	0b	Reserved bits; Write only reset values
5	PASI_TX_CH1_CFG	R/W	1b	Primary ASI output channel 1 configuration. 0d = Primary ASI channel 1 output is in a tri-state condition 1d = Primary ASI channel 1 output corresponds to PDM Channel 1 data
4-0	PASI_TX_CH1_SLOT_NUM[4:0]	R/W	00000b	Primary ASI output channel 1 slot assignment. 0d = TDM is slot 0 or I <sup>2</sup> S, LJ is left slot 0 1d = TDM is slot 1 or I <sup>2</sup> S, LJ is left slot 1 2d to 14d = Slot assigned as per configuration 15d = TDM is slot 15 or I <sup>2</sup> S, LJ is left slot 15 16d = TDM is slot 16 or I <sup>2</sup> S, LJ is right slot 0 17d = TDM is slot 17 or I <sup>2</sup> S, LJ is right slot 1 18d to 30d = Slot assigned as per configuration 31d = TDM is slot 31 or I <sup>2</sup> S, LJ is right slot 15

#### 7.1.1.28 PASI\_TX\_CH2\_CFG Register (Address = 0x1F) [Reset = 0x21]

PASI\_TX\_CH2\_CFG is shown in [Table 7-30](#).

Return to the [Summary Table](#).

This register is the PASI TX Channel 2 configuration register.

**Table 7-30. PASI\_TX\_CH2\_CFG Register Field Descriptions**

Bit	Field	Type	Reset	Description
7-6	RESERVED	R	0b	Reserved bits; Write only reset values
5	PASI_TX_CH2_CFG	R/W	1b	Primary ASI output channel 2 configuration. 0d = Primary ASI channel 2 output is in a tri-state condition 1d = Primary ASI channel 2 output corresponds to PDM Channel 2 data

**Table 7-30. PASI\_TX\_CH2\_CFG Register Field Descriptions (continued)**

Bit	Field	Type	Reset	Description
4-0	PASI_TX_CH2_SLOT_NUM[4:0]	R/W	00001b	Primary ASI output channel 2 slot assignment. 0d = TDM is slot 0 or I <sup>2</sup> S, LJ is left slot 0 1d = TDM is slot 1 or I <sup>2</sup> S, LJ is left slot 1 2d to 14d = Slot assigned as per configuration 15d = TDM is slot 15 or I <sup>2</sup> S, LJ is left slot 15 16d = TDM is slot 16 or I <sup>2</sup> S, LJ is right slot 0 17d = TDM is slot 17 or I <sup>2</sup> S, LJ is right slot 1 18d to 30d = Slot assigned as per configuration 31d = TDM is slot 31 or I <sup>2</sup> S, LJ is right slot 15

**7.1.1.29 PASI\_TX\_CH3\_CFG Register (Address = 0x20) [Reset = 0x02]**

PASI\_TX\_CH3\_CFG is shown in [Table 7-31](#).

Return to the [Summary Table](#).

This register is the PASI TX Channel 3 configuration register.

**Table 7-31. PASI\_TX\_CH3\_CFG Register Field Descriptions**

Bit	Field	Type	Reset	Description
7	RESERVED	R	0b	Reserved bit; Write only reset value
6-5	PASI_TX_CH3_CFG[1:0]	R/W	00b	Primary ASI output channel 3 configuration. 0d = Primary ASI channel 3 output is in a tri-state condition 1d = Primary ASI channel 3 output corresponds to PDM Channel 3 data 2d = Reserved 3d = Reserved
4-0	PASI_TX_CH3_SLOT_NUM[4:0]	R/W	00010b	Primary ASI output channel 3 slot assignment. 0d = TDM is slot 0 or I <sup>2</sup> S, LJ is left slot 0 1d = TDM is slot 1 or I <sup>2</sup> S, LJ is left slot 1 2d to 14d = Slot assigned as per configuration 15d = TDM is slot 15 or I <sup>2</sup> S, LJ is left slot 15 16d = TDM is slot 16 or I <sup>2</sup> S, LJ is right slot 0 17d = TDM is slot 17 or I <sup>2</sup> S, LJ is right slot 1 18d to 30d = Slot assigned as per configuration 31d = TDM is slot 31 or I <sup>2</sup> S, LJ is right slot 15

**7.1.1.30 PASI\_TX\_CH4\_CFG Register (Address = 0x21) [Reset = 0x03]**

PASI\_TX\_CH4\_CFG is shown in [Table 7-32](#).

Return to the [Summary Table](#).

This register is the PASI TX Channel 4 configuration register.

**Table 7-32. PASI\_TX\_CH4\_CFG Register Field Descriptions**

Bit	Field	Type	Reset	Description
7	RESERVED	R	0b	Reserved bit; Write only reset value
6-5	PASI_TX_CH4_CFG[1:0]	R/W	00b	Primary ASI output channel 4 configuration. 0d = Primary ASI channel 4 output is in a tri-state condition 1d = Primary ASI channel 4 output corresponds to PDM Channel 4 data 2d = Primary ASI channel 4 output corresponds to TEMP data 3d = Reserved

**Table 7-32. PASI\_TX\_CH4\_CFG Register Field Descriptions (continued)**

Bit	Field	Type	Reset	Description
4-0	PASI_TX_CH4_SLOT_NUM[4:0]	R/W	00011b	Primary ASI output channel 4 slot assignment. 0d = TDM is slot 0 or I <sup>2</sup> S, LJ is left slot 0 1d = TDM is slot 1 or I <sup>2</sup> S, LJ is left slot 1 2d to 14d = Slot assigned as per configuration 15d = TDM is slot 15 or I <sup>2</sup> S, LJ is left slot 15 16d = TDM is slot 16 or I <sup>2</sup> S, LJ is right slot 0 17d = TDM is slot 17 or I <sup>2</sup> S, LJ is right slot 1 18d to 30d = Slot assigned as per configuration 31d = TDM is slot 31 or I <sup>2</sup> S, LJ is right slot 15

### 7.1.1.31 PASI\_TX\_CH5\_CFG Register (Address = 0x22) [Reset = 0x04]

PASI\_TX\_CH5\_CFG is shown in [Table 7-33](#).

Return to the [Summary Table](#).

This register is the PASI TX Channel 5 configuration register.

**Table 7-33. PASI\_TX\_CH5\_CFG Register Field Descriptions**

Bit	Field	Type	Reset	Description
7	RESERVED	R	0b	Reserved bit; Write only reset value
6-5	PASI_TX_CH5_CFG[1:0]	R/W	00b	Primary ASI output channel 5 configuration. 0d = Primary ASI channel 5 output is in a tri-state condition 1d = Primary ASI channel 5 output corresponds to ASI Input Channel 1 loopback data 2d = Primary ASI channel 5 output corresponds to echo reference Channel 1 data 3d = Reserved
4-0	PASI_TX_CH5_SLOT_NUM[4:0]	R/W	00100b	Primary ASI output channel 5 slot assignment. 0d = TDM is slot 0 or I <sup>2</sup> S, LJ is left slot 0 1d = TDM is slot 1 or I <sup>2</sup> S, LJ is left slot 1 2d to 14d = Slot assigned as per configuration 15d = TDM is slot 15 or I <sup>2</sup> S, LJ is left slot 15 16d = TDM is slot 16 or I <sup>2</sup> S, LJ is right slot 0 17d = TDM is slot 17 or I <sup>2</sup> S, LJ is right slot 1 18d to 30d = Slot assigned as per configuration 31d = TDM is slot 31 or I <sup>2</sup> S, LJ is right slot 15

### 7.1.1.32 PASI\_TX\_CH6\_CFG Register (Address = 0x23) [Reset = 0x05]

PASI\_TX\_CH6\_CFG is shown in [Table 7-34](#).

Return to the [Summary Table](#).

This register is the PASI TX Channel 6 configuration register.

**Table 7-34. PASI\_TX\_CH6\_CFG Register Field Descriptions**

Bit	Field	Type	Reset	Description
7	RESERVED	R	0b	Reserved bit; Write only reset value
6-5	PASI_TX_CH6_CFG[1:0]	R/W	00b	Primary ASI output channel 6 configuration. 0d = Primary ASI channel 6 output is in a tri-state condition 1d = Primary ASI channel 6 output corresponds to ASI Input Channel 2 loopback data 2d = Primary ASI channel 6 output corresponds to echo reference Channel 2 data 3d = Reserved

**Table 7-34. PASI\_TX\_CH6\_CFG Register Field Descriptions (continued)**

Bit	Field	Type	Reset	Description
4-0	PASI_TX_CH6_SLOT_NUM[4:0]	R/W	00101b	Primary ASI output channel 6 slot assignment. 0d = TDM is slot 0 or I <sup>2</sup> S, LJ is left slot 0 1d = TDM is slot 1 or I <sup>2</sup> S, LJ is left slot 1 2d to 14d = Slot assigned as per configuration 15d = TDM is slot 15 or I <sup>2</sup> S, LJ is left slot 15 16d = TDM is slot 16 or I <sup>2</sup> S, LJ is right slot 0 17d = TDM is slot 17 or I <sup>2</sup> S, LJ is right slot 1 18d to 30d = Slot assigned as per configuration 31d = TDM is slot 31 or I <sup>2</sup> S, LJ is right slot 15

**7.1.1.33 PASI\_TX\_CH7\_CFG Register (Address = 0x24) [Reset = 0x06]**

PASI\_TX\_CH7\_CFG is shown in [Table 7-35](#).

Return to the [Summary Table](#).

This register is the PASI TX Channel 7 configuration register.

**Table 7-35. PASI\_TX\_CH7\_CFG Register Field Descriptions**

Bit	Field	Type	Reset	Description
7	RESERVED	R	0b	Reserved bit; Write only reset value
6-5	PASI_TX_CH7_CFG[1:0]	R/W	00b	Primary ASI output channel 7 configuration. 0d = Primary ASI channel 7 output is in a tri-state condition 1d = Reserved 2d = Primary ASI channel 7 output corresponds to {echo_ref_ch1, echo_ref_ch2} 3d = Reserved
4-0	PASI_TX_CH7_SLOT_NUM[4:0]	R/W	00110b	Primary ASI output channel 7 slot assignment. 0d = TDM is slot 0 or I <sup>2</sup> S, LJ is left slot 0 1d = TDM is slot 1 or I <sup>2</sup> S, LJ is left slot 1 2d to 14d = Slot assigned as per configuration 15d = TDM is slot 15 or I <sup>2</sup> S, LJ is left slot 15 16d = TDM is slot 16 or I <sup>2</sup> S, LJ is right slot 0 17d = TDM is slot 17 or I <sup>2</sup> S, LJ is right slot 1 18d to 30d = Slot assigned as per configuration 31d = TDM is slot 31 or I <sup>2</sup> S, LJ is right slot 15

**7.1.1.34 PASI\_TX\_CH8\_CFG Register (Address = 0x25) [Reset = 0x07]**

PASI\_TX\_CH8\_CFG is shown in [Table 7-36](#).

Return to the [Summary Table](#).

This register is the PASI TX Channel 8 configuration register.

**Table 7-36. PASI\_TX\_CH8\_CFG Register Field Descriptions**

Bit	Field	Type	Reset	Description
7-6	RESERVED	R	0b	Reserved bits; Write only reset values
5	PASI_TX_CH8_CFG	R/W	0b	Primary ASI output channel 8 configuration. 0d = Primary ASI channel 8 output is in a tri-state condition 1d = Primary ASI channel 8 output corresponds to ICLA data

**Table 7-36. PASI\_TX\_CH8\_CFG Register Field Descriptions (continued)**

Bit	Field	Type	Reset	Description
4-0	PASI_TX_CH8_SLOT_NUM[4:0]	R/W	00111b	Primary ASI output channel 8 slot assignment. 0d = TDM is slot 0 or I <sup>2</sup> S, LJ is left slot 0 1d = TDM is slot 1 or I <sup>2</sup> S, LJ is left slot 1 2d to 14d = Slot assigned as per configuration 15d = TDM is slot 15 or I <sup>2</sup> S, LJ is left slot 15 16d = TDM is slot 16 or I <sup>2</sup> S, LJ is right slot 0 17d = TDM is slot 17 or I <sup>2</sup> S, LJ is right slot 1 18d to 30d = Slot assigned as per configuration 31d = TDM is slot 31 or I <sup>2</sup> S, LJ is right slot 15

### 7.1.1.35 PASI\_RX\_CFG0 Register (Address = 0x26) [Reset = 0x00]

PASI\_RX\_CFG0 is shown in [Table 7-37](#).

Return to the [Summary Table](#).

This register is the PASI RX configuration register 0.

**Table 7-37. PASI\_RX\_CFG0 Register Field Descriptions**

Bit	Field	Type	Reset	Description
7	PASI_RX_EDGE	R/W	0b	Primary ASI data input (on the primary and secondary data pin) receive edge. 0d = Default edge as per the protocol configuration setting in PASI_BCLK_POL 1d = Inverted following edge (half cycle delay) with respect to the default edge setting
6	PASI_RX_USE_INT_FSYNC	R/W	0b	Primary ASI uses internal FSYNC for input data latching in Controller mode configuration as applicable. 0d = Use external FSYNC for ASI protocol data latching 1d = Use internal FSYNC for ASI protocol data latching
5	PASI_RX_USE_INT_BCLK	R/W	0b	Primary ASI uses internal BCLK for input data latching in Controller mode configuration. 0d = Use external BCLK for ASI protocol data latching 1d = Use internal BCLK for ASI protocol data latching
4-0	PASI_RX_OFFSET[4:0]	R/W	00000b	Primary ASI data input MSB slot 0 offset (on the primary and secondary data pin). 0d = ASI data MSB location has no offset and is as per standard protocol 1d = ASI data MSB location (TDM mode is slot 0 or I <sup>2</sup> S, LJ mode is the left and right slot 0) offset of one BCLK cycle with respect to standard protocol 2d = ASI data MSB location (TDM mode is slot 0 or I <sup>2</sup> S, LJ mode is the left and right slot 0) offset of two BCLK cycles with respect to standard protocol 3d to 30d = ASI data MSB location (TDM mode is slot 0 or I <sup>2</sup> S, LJ mode is the left and right slot 0) offset assigned as per configuration 31d = ASI data MSB location (TDM mode is slot 0 or I <sup>2</sup> S, LJ mode is the left and right slot 0) offset of 31 BCLK cycles with respect to standard protocol

### 7.1.1.36 PASI\_RX\_CFG1 Register (Address = 0x27) [Reset = 0x00]

PASI\_RX\_CFG1 is shown in [Table 7-38](#).

Return to the [Summary Table](#).

This register is the PASI RX configuration register 1.

**Table 7-38. PASI\_RX\_CFG1 Register Field Descriptions**

Bit	Field	Type	Reset	Description
7	PASI_RX_CH8_SEL	R/W	0b	Primary ASI input channel 8 select. 0d = Primary ASI channel 8 input is on DIN 1d = Primary ASI channel 8 input is on DIN2
6	PASI_RX_CH7_SEL	R/W	0b	Primary ASI input channel 7 select. 0d = Primary ASI channel 7 input is on DIN 1d = Primary ASI channel 7 input is on DIN2
5	PASI_RX_CH6_SEL	R/W	0b	Primary ASI input channel 6 select. 0d = Primary ASI channel 6 input is on DIN 1d = Primary ASI channel 6 input is on DIN2
4	PASI_RX_CH5_SEL	R/W	0b	Primary ASI input channel 5 select. 0d = Primary ASI channel 5 input is on DIN 1d = Primary ASI channel 5 input is on DIN2
3	PASI_RX_CH4_SEL	R/W	0b	Primary ASI input channel 4 select. 0d = Primary ASI channel 4 input is on DIN 1d = Primary ASI channel 4 input is on DIN2
2	PASI_RX_CH3_SEL	R/W	0b	Primary ASI input channel 3 select. 0d = Primary ASI channel 3 input is on DIN 1d = Primary ASI channel 3 input is on DIN2
1	PASI_RX_CH2_SEL	R/W	0b	Primary ASI input channel 2 select. 0d = Primary ASI channel 2 input is on DIN 1d = Primary ASI channel 2 input is on DIN2
0	PASI_RX_CH1_SEL	R/W	0b	Primary ASI input channel 1 select. 0d = Primary ASI channel 1 input is on DIN 1d = Primary ASI channel 1 input is on DIN2

**7.1.1.37 PASI\_RX\_CH1\_CFG Register (Address = 0x28) [Reset = 0x20]**

PASI\_RX\_CH1\_CFG is shown in [Table 7-39](#).

Return to the [Summary Table](#).

This register is the PASI RX Channel 1 configuration register.

**Table 7-39. PASI\_RX\_CH1\_CFG Register Field Descriptions**

Bit	Field	Type	Reset	Description
7-6	RESERVED	R	0b	Reserved bits; Write only reset values
5	PASI_RX_CH1_CFG	R/W	1b	Primary ASI input channel 1 configuration. 0d = Primary ASI channel 1 input is disabled 1d = Primary ASI channel 1 input corresponds to DAC Channel 1 data
4-0	PASI_RX_CH1_SLOT_NUM[4:0]	R/W	00000b	Primary ASI input channel 1 slot assignment. 0d = TDM is slot 0 or I <sup>2</sup> S, LJ is left slot 0 1d = TDM is slot 1 or I <sup>2</sup> S, LJ is left slot 1 2d to 14d = Slot assigned as per configuration 15d = TDM is slot 15 or I <sup>2</sup> S, LJ is left slot 15 16d = TDM is slot 16 or I <sup>2</sup> S, LJ is right slot 0 17d = TDM is slot 17 or I <sup>2</sup> S, LJ is right slot 1 18d to 30d = Slot assigned as per configuration 31d = TDM is slot 31 or I <sup>2</sup> S, LJ is right slot 15

**7.1.1.38 PASI\_RX\_CH2\_CFG Register (Address = 0x29) [Reset = 0x21]**

PASI\_RX\_CH2\_CFG is shown in [Table 7-40](#).

Return to the [Summary Table](#).

This register is the PASI RX Channel 2 configuration register.



**Table 7-40. PASI\_RX\_CH2\_CFG Register Field Descriptions**

Bit	Field	Type	Reset	Description
7-6	RESERVED	R	0b	Reserved bits; Write only reset values
5	PASI_RX_CH2_CFG	R/W	1b	Primary ASI input channel 2 configuration. 0d = Primary ASI channel 2 input is disabled 1d = Primary ASI channel 2 input corresponds to DAC Channel 2 data
4-0	PASI_RX_CH2_SLOT_NUM[4:0]	R/W	00001b	Primary ASI input channel 2 slot assignment. 0d = TDM is slot 0 or I <sup>2</sup> S, LJ is left slot 0 1d = TDM is slot 1 or I <sup>2</sup> S, LJ is left slot 1 2d to 14d = Slot assigned as per configuration 15d = TDM is slot 15 or I <sup>2</sup> S, LJ is left slot 15 16d = TDM is slot 16 or I <sup>2</sup> S, LJ is right slot 0 17d = TDM is slot 17 or I <sup>2</sup> S, LJ is right slot 1 18d to 30d = Slot assigned as per configuration 31d = TDM is slot 31 or I <sup>2</sup> S, LJ is right slot 15

#### 7.1.1.39 PASI\_RX\_CH3\_CFG Register (Address = 0x2A) [Reset = 0x02]

PASI\_RX\_CH3\_CFG is shown in [Table 7-41](#).

Return to the [Summary Table](#).

This register is the PASI RX Channel 3 configuration register.

**Table 7-41. PASI\_RX\_CH3\_CFG Register Field Descriptions**

Bit	Field	Type	Reset	Description
7-6	RESERVED	R	0b	Reserved bits; Write only reset values
5	PASI_RX_CH3_CFG	R/W	0b	Primary ASI input channel 3 configuration. 0d = Primary ASI channel 3 input is disabled 1d = Primary ASI channel 3 input corresponds to DAC Channel 3 data
4-0	PASI_RX_CH3_SLOT_NUM[4:0]	R/W	00010b	Primary ASI input channel 3 slot assignment. 0d = TDM is slot 0 or I <sup>2</sup> S, LJ is left slot 0 1d = TDM is slot 1 or I <sup>2</sup> S, LJ is left slot 1 2d to 14d = Slot assigned as per configuration 15d = TDM is slot 15 or I <sup>2</sup> S, LJ is left slot 15 16d = TDM is slot 16 or I <sup>2</sup> S, LJ is right slot 0 17d = TDM is slot 17 or I <sup>2</sup> S, LJ is right slot 1 18d to 30d = Slot assigned as per configuration 31d = TDM is slot 31 or I <sup>2</sup> S, LJ is right slot 15

#### 7.1.1.40 PASI\_RX\_CH4\_CFG Register (Address = 0x2B) [Reset = 0x03]

PASI\_RX\_CH4\_CFG is shown in [Table 7-42](#).

Return to the [Summary Table](#).

This register is the PASI RX Channel 4 configuration register.

**Table 7-42. PASI\_RX\_CH4\_CFG Register Field Descriptions**

Bit	Field	Type	Reset	Description
7-6	RESERVED	R	0b	Reserved bits; Write only reset values
5	PASI_RX_CH4_CFG	R/W	0b	Primary ASI input channel 4 configuration. 0d = Primary ASI channel 4 input is disabled 1d = Primary ASI channel 4 input corresponds to DAC Channel 4 data

**Table 7-42. PASI\_RX\_CH4\_CFG Register Field Descriptions (continued)**

Bit	Field	Type	Reset	Description
4-0	PASI_RX_CH4_SLOT_NUM[4:0]	R/W	00011b	Primary ASI input channel 4 slot assignment. 0d = TDM is slot 0 or I <sup>2</sup> S, LJ is left slot 0 1d = TDM is slot 1 or I <sup>2</sup> S, LJ is left slot 1 2d to 14d = Slot assigned as per configuration 15d = TDM is slot 15 or I <sup>2</sup> S, LJ is left slot 15 16d = TDM is slot 16 or I <sup>2</sup> S, LJ is right slot 0 17d = TDM is slot 17 or I <sup>2</sup> S, LJ is right slot 1 18d to 30d = Slot assigned as per configuration 31d = TDM is slot 31 or I <sup>2</sup> S, LJ is right slot 15

**7.1.1.41 PASI\_RX\_CH5\_CFG Register (Address = 0x2C) [Reset = 0x04]**

PASI\_RX\_CH5\_CFG is shown in [Table 7-43](#).

Return to the [Summary Table](#).

This register is the PASI RX Channel 5 configuration register.

**Table 7-43. PASI\_RX\_CH5\_CFG Register Field Descriptions**

Bit	Field	Type	Reset	Description
7	RESERVED	R	0b	Reserved bit; Write only reset value
6-5	PASI_RX_CH5_CFG[1:0]	R/W	00b	Primary ASI input channel 5 configuration. 0d = Primary ASI channel 5 input is disabled 1d = Primary ASI channel 5 input corresponds to DAC Channel 5 data 2d = Primary ASI channel 5 input corresponds to ADC Channel 1 output loopback 3d = Reserved
4-0	PASI_RX_CH5_SLOT_NUM[4:0]	R/W	00100b	Primary ASI input channel 5 slot assignment. 0d = TDM is slot 0 or I <sup>2</sup> S, LJ is left slot 0 1d = TDM is slot 1 or I <sup>2</sup> S, LJ is left slot 1 2d to 14d = Slot assigned as per configuration 15d = TDM is slot 15 or I <sup>2</sup> S, LJ is left slot 15 16d = TDM is slot 16 or I <sup>2</sup> S, LJ is right slot 0 17d = TDM is slot 17 or I <sup>2</sup> S, LJ is right slot 1 18d to 30d = Slot assigned as per configuration 31d = TDM is slot 31 or I <sup>2</sup> S, LJ is right slot 15

**7.1.1.42 PASI\_RX\_CH6\_CFG Register (Address = 0x2D) [Reset = 0x05]**

PASI\_RX\_CH6\_CFG is shown in [Table 7-44](#).

Return to the [Summary Table](#).

This register is the PASI RX Channel 6 configuration register.

**Table 7-44. PASI\_RX\_CH6\_CFG Register Field Descriptions**

Bit	Field	Type	Reset	Description
7	RESERVED	R	0b	Reserved bit; Write only reset value
6-5	PASI_RX_CH6_CFG[1:0]	R/W	00b	Primary ASI input channel 6 configuration. 0d = Primary ASI channel 6 input is disabled 1d = Primary ASI channel 6 input corresponds to DAC Channel 6 data 2d = Primary ASI channel 6 input corresponds to ADC Channel 2 output loopback 3d = Primary ASI channel 6 input corresponds to ICLA device 1 data

**Table 7-44. PASI\_RX\_CH6\_CFG Register Field Descriptions (continued)**

Bit	Field	Type	Reset	Description
4-0	PASI_RX_CH6_SLOT_NUM[4:0]	R/W	00101b	Primary ASI input channel 6 slot assignment. 0d = TDM is slot 0 or I <sup>2</sup> S, LJ is left slot 0 1d = TDM is slot 1 or I <sup>2</sup> S, LJ is left slot 1 2d to 14d = Slot assigned as per configuration 15d = TDM is slot 15 or I <sup>2</sup> S, LJ is left slot 15 16d = TDM is slot 16 or I <sup>2</sup> S, LJ is right slot 0 17d = TDM is slot 17 or I <sup>2</sup> S, LJ is right slot 1 18d to 30d = Slot assigned as per configuration 31d = TDM is slot 31 or I <sup>2</sup> S, LJ is right slot 15

#### 7.1.1.43 PASI\_RX\_CH7\_CFG Register (Address = 0x2E) [Reset = 0x06]

PASI\_RX\_CH7\_CFG is shown in [Table 7-45](#).

Return to the [Summary Table](#).

This register is the PASI RX Channel 7 configuration register.

**Table 7-45. PASI\_RX\_CH7\_CFG Register Field Descriptions**

Bit	Field	Type	Reset	Description
7	RESERVED	R	0b	Reserved bit; Write only reset value
6-5	PASI_RX_CH7_CFG[1:0]	R/W	00b	Primary ASI input channel 7 configuration. 0d = Primary ASI channel 7 input is disabled 1d = Primary ASI channel 7 input corresponds to DAC Channel 7 data 2d = Primary ASI channel 7 input corresponds to ADC Channel 3 output loopback 3d = Primary ASI channel 7 input corresponds to ICLA device 2 data
4-0	PASI_RX_CH7_SLOT_NUM[4:0]	R/W	00110b	Primary ASI input channel 7 slot assignment. 0d = TDM is slot 0 or I <sup>2</sup> S, LJ is left slot 0 1d = TDM is slot 1 or I <sup>2</sup> S, LJ is left slot 1 2d to 14d = Slot assigned as per configuration 15d = TDM is slot 15 or I <sup>2</sup> S, LJ is left slot 15 16d = TDM is slot 16 or I <sup>2</sup> S, LJ is right slot 0 17d = TDM is slot 17 or I <sup>2</sup> S, LJ is right slot 1 18d to 30d = Slot assigned as per configuration 31d = TDM is slot 31 or I <sup>2</sup> S, LJ is right slot 15

#### 7.1.1.44 PASI\_RX\_CH8\_CFG Register (Address = 0x2F) [Reset = 0x07]

PASI\_RX\_CH8\_CFG is shown in [Table 7-46](#).

Return to the [Summary Table](#).

This register is the PASI RX Channel 8 configuration register.

**Table 7-46. PASI\_RX\_CH8\_CFG Register Field Descriptions**

Bit	Field	Type	Reset	Description
7	RESERVED	R	0b	Reserved bit; Write only reset value
6-5	PASI_RX_CH8_CFG[1:0]	R/W	00b	Primary ASI input channel 8 configuration. 0d = Primary ASI channel 8 input is disabled 1d = Primary ASI channel 8 input corresponds to DAC Channel 8 data 2d = Primary ASI channel 8 input corresponds to ADC Channel 4 output loopback 3d = Primary ASI channel 8 input corresponds to ICLA device 3 data

**Table 7-46. PASI\_RX\_CH8\_CFG Register Field Descriptions (continued)**

Bit	Field	Type	Reset	Description
4-0	PASI_RX_CH8_SLOT_NUM[4:0]	R/W	00111b	Primary ASI input channel 8 slot assignment. 0d = TDM is slot 0 or I <sup>2</sup> S, LJ is left slot 0 1d = TDM is slot 1 or I <sup>2</sup> S, LJ is left slot 1 2d to 14d = Slot assigned as per configuration 15d = TDM is slot 15 or I <sup>2</sup> S, LJ is left slot 15 16d = TDM is slot 16 or I <sup>2</sup> S, LJ is right slot 0 17d = TDM is slot 17 or I <sup>2</sup> S, LJ is right slot 1 18d to 30d = Slot assigned as per configuration 31d = TDM is slot 31 or I <sup>2</sup> S, LJ is right slot 15

**7.1.1.45 CLK\_CFG0 Register (Address = 0x32) [Reset = 0x00]**

CLK\_CFG0 is shown in [Table 7-47](#).

Return to the [Summary Table](#).

This register is the clock configuration register 0.

**Table 7-47. CLK\_CFG0 Register Field Descriptions**

Bit	Field	Type	Reset	Description
7-2	PASI_SAMP_RATE[5:0]	R/W	00000b	Primary ASI sample rate configuration. -Typical (Allowed Range) 0d = Primary ASI sampling rate auto detected in the device 1d = 768000 (670320-791040) 2d = 614400 (536256-632832) 3d = 512000 (446880-527360) 4d = 438857 (383040-452022) 5d = 384000 (335160-395520) 6d = 341333 (297920-351573) 7d = 307200 (268128-316416) 8d = 256000 (223440-263680) 9d = 219429 (191520-226011) 10d = 192000 (167580-197760) 11d = 170667 (148960-175786) 12d = 153600 (134064-158208) 13d = 128000 (111720-131840) 14d = 109714 (95760-113005) 15d = 96000 (83790-98880) 16d = 85333 (74480-87893) 17d = 76800 (67032-79104) 18d = 64000 (55860-65920) 19d = 54857 (47880-56502) 20d = 48000 (41895-49440) 21d = 42667 (37240-43946) 22d = 38400 (33516-39552) 23d = 32000 (27930-32960) 24d = 27429 (23940-28251) 25d = 24000 (20947-24720) 26d = 21333 (18620-21973) 27d = 19200 (16758-19776) 28d = 16000 (13965-16480) 29d = 13714 (11970-14125) 30d = 12000 (10473-12360) 31d = 10667 (9310-10986) 32d = 9600 (8379-9888) 33d = 8000 (6982-8240) 34d = 6857 (5985-7062) 35d = 6000 (5236-6180) 36d = 5333 (4655-5493) 37d = 4800 (4189-4944) 38d = 4000 (3491-4120) 39d = 3429 (2992-3531) 40d = 3000 (2618-3090) 41d-63d = Reserved

**Table 7-47. CLK\_CFG0 Register Field Descriptions (continued)**

Bit	Field	Type	Reset	Description
1	PASI_FS_RATE_NO_LIM	R/W	0b	Limit sampling rate to standard audio sample rates only. 0d = Standard audio rates with 1% tolerance supported using auto mode 1d = Standard audio rates with 5% tolerance supported using auto mode
0	CUSTOM_CLK_CFG	R/W	0b	Custom clock configuration enable, all dividers and mux selects need to be manually configured. 0d = Auto clock configuration 1d = Custom clock configuration

**7.1.1.46 CLK\_CFG1 Register (Address = 0x33) [Reset = 0x00]**

CLK\_CFG1 is shown in [Table 7-48](#).

Return to the [Summary Table](#).

This register is the clock configuration register 1.

**Table 7-48. CLK\_CFG1 Register Field Descriptions**

Bit	Field	Type	Reset	Description
7-2	SASI_SAMP_RATE[5:0]	R/W	00000b	Secondary ASI sample rate configuration. -Typical (Range) 0d = Secondary ASI sampling rate auto detected in the device 1d = 768000 (670320-791040) 2d = 614400 (536256-632832) 3d = 512000 (446880-527360) 4d = 438857 (383040-452022) 5d = 384000 (335160-395520) 6d = 341333 (297920-351573) 7d = 307200 (268128-316416) 8d = 256000 (223440-263680) 9d = 219429 (191520-226011) 10d = 192000 (167580-197760) 11d = 170667 (148960-175786) 12d = 153600 (134064-158208) 13d = 128000 (111720-131840) 14d = 109714 (95760-113005) 15d = 96000 (83790-98880) 16d = 85333 (74480-87893) 17d = 76800 (67032-79104) 18d = 64000 (55860-65920) 19d = 54857 (47880-56502) 20d = 48000 (41895-49440) 21d = 42667 (37240-43946) 22d = 38400 (33516-39552) 23d = 32000 (27930-32960) 24d = 27429 (23940-28251) 25d = 24000 (20947-24720) 26d = 21333 (18620-21973) 27d = 19200 (16758-19776) 28d = 16000 (13965-16480) 29d = 13714 (11970-14125) 30d = 12000 (10473-12360) 31d = 10667 (9310-10986) 32d = 9600 (8379-9888) 33d = 8000 (6982-8240) 34d = 6857 (5985-7062) 35d = 6000 (5236-6180) 36d = 5333 (4655-5493) 37d = 4800 (4189-4944) 38d = 4000 (3491-4120) 39d = 3429 (2992-3531) 40d = 3000 (2618-3090) 41d-63d = Reserved

**Table 7-48. CLK\_CFG1 Register Field Descriptions (continued)**

Bit	Field	Type	Reset	Description
1	SASI_FS_RATE_NO_LIM	R/W	0b	Limit sampling rate to standard audio sample rates only. 0d = Standard audio rates with 1% tolerance supported using auto mode 1d = Standard audio rates with 5% tolerance supported using auto mode
0	RESERVED	R	0b	Reserved bit; Write only reset value

**7.1.1.47 CLK\_CFG2 Register (Address = 0x34) [Reset = 0x40]**

CLK\_CFG2 is shown in [Table 7-49](#).

Return to the [Summary Table](#).

This register is the clock configuration register 2.

**Table 7-49. CLK\_CFG2 Register Field Descriptions**

Bit	Field	Type	Reset	Description
7	PLL_DIS	R/W	0b	Custom/Auto clock mode PLL setting. 0d = PLL is always enabled in custom clk mode/PLL is enabled based on DSP MIPS requirement in auto clock mode 1d = PLL is disabled
6	AUTO_PLL_FR_ALLOW	R/W	1b	Allow the PLL to operate in fractional mode of operation. 0d = PLL fractional mode disabled 1d = PLL fractional mode allowed
5	RESERVED	R	0b	Reserved bit; Write only reset value
4	RESERVED	R	0b	Reserved bit; Write only reset value
3-1	CLK_SRC_SEL[2:0]	R/W	000b	Input clock source select. 0d = Primary ASI BCLK is the input clock source 1d = CCLK synchronized with Primary ASI FSYNC is the input clock source 2d = Secondary ASI BCLK is the input clock source 3d = CCLK synchronized with Secondary ASI FSYNC is the input clock source 4d = Fixed CCLK frequency (used only in controller mode configuration) 5d = Internal oscillator clock is the input clock source (only supported in custom clock configuration) 6d to 7d = Reserved
0	RATIO_CLK_EDGE	R/W	0b	Edge selection for clock source ratio detection. 0d = Use rising edge of clock source to check ratio with primary or secondary FSYNC 1d = Use falling edge of clock source to check ratio with primary or secondary FSYNC

**7.1.1.48 CNT\_CLK\_CFG0 Register (Address = 0x35) [Reset = 0x00]**

CNT\_CLK\_CFG0 is shown in [Table 7-50](#).

Return to the [Summary Table](#).

This register is the controller mode clock configuration register 0.

**Table 7-50. CNT\_CLK\_CFG0 Register Field Descriptions**

Bit	Field	Type	Reset	Description
7-6	PDM_CLK_CFG[1:0]	R/W	00b	PDM_CLK configuration. 0d = PDM_CLK is 2.8224 MHz or 3.072 MHz 1d = PDM_CLK is 1.4112 MHz or 1.536 MHz 2d = PDM_CLK is 705.6 kHz or 768 kHz 3d = PDM_CLK is 5.6448 MHz or 6.144 MHz
5-0	CCLK_FS_RATIO_MSB[5:0]	R/W	000000b	Most significant bits for selecting the ratio between CCLK and primary/secondary ASI FSYNC with which CCLK is synchronized. 0d = Auto detect the ratio (assumption is CCLK is synchronized with primary/secondary FSYNC) 1d to 16383d = Ratio as per configuration

**7.1.1.49 CNT\_CLK\_CFG1 Register (Address = 0x36) [Reset = 0x00]**

CNT\_CLK\_CFG1 is shown in [Table 7-51](#).

Return to the [Summary Table](#).

This register is the controller mode clock configuration register 1.

**Table 7-51. CNT\_CLK\_CFG1 Register Field Descriptions**

Bit	Field	Type	Reset	Description
7-0	CCLK_FS_RATIO_LSB[7:0]	R/W	00000000b	Select the ratio between CCLK and primary/secondary ASI FSYNC with which CCLK is synchronized. 0d = Auto detect the ratio (assumption is CCLK is synchronized with primary/secondary FSYNC) 1d to 16383d = Ratio as per configuration

**7.1.1.50 CNT\_CLK\_CFG2 Register (Address = 0x37) [Reset = 0x20]**

CNT\_CLK\_CFG2 is shown in [Table 7-52](#).

Return to the [Summary Table](#).

This register is the controller mode clock configuration register 2.

**Table 7-52. CNT\_CLK\_CFG2 Register Field Descriptions**

Bit	Field	Type	Reset	Description
7-5	CCLK_FREQ_SEL[2:0]	R/W	001b	These bits select the CCLK input frequency (used only in controller mode configuration). 0d = 12 MHz 1d = 12.288 MHz 2d = 13 MHz 3d = 16 MHz 4d = 19.2 MHz 5d = 19.68 MHz 6d = 24 MHz 7d = 24.576 MHz
4	PASI_CNT_CFG	R/W	0b	Primary ASI controller or target configuration 0d = Primary ASI in target configuration 1d = Primary ASI in controller configuration
3	SASI_CNT_CFG	R/W	0b	Secondary ASI controller or target configuration 0d = Secondary ASI in target configuration 1d = Secondary ASI in controller configuration
2	RESERVED	R	0b	Reserved bit; Write only reset value
1	RESERVED	R	0b	Reserved bit; Write only reset value

**Table 7-52. CNT\_CLK\_CFG2 Register Field Descriptions (continued)**

Bit	Field	Type	Reset	Description
0	FS_MODE	R/W	0b	Sample rate setting (valid when the device is in controller mode). This is applicable for both PASI and SASI. 0d = sampling rate is a multiple (or submultiple) of 48 kHz 1d = sampling rate is a multiple (or submultiple) of 44.1 kHz

**7.1.1.51 CNT\_CLK\_CFG3 Register (Address = 0x38) [Reset = 0x00]**

CNT\_CLK\_CFG3 is shown in [Table 7-53](#).

Return to the [Summary Table](#).

This register is the controller mode clock configuration register 3.

**Table 7-53. CNT\_CLK\_CFG3 Register Field Descriptions**

Bit	Field	Type	Reset	Description
7	PASI_USE_INT_BCLK_F OR_FSYNC	R/W	0b	Use internal BCLK for FSYNC generation in PASI during controller mode configuration. 0d = Use external BCLK for FSYNC generation 1d = Use internal BCLK for FSYNC generation
6	PASI_INV_BCLK_FOR_F SYNC	R/W	0b	Invert PASI BCLK polarity only for PASI FSYNC generation in controller mode configuration. 0d = Do not invert PASI BCLK polarity for PASI FSYNC generation 1d = Invert PASI BCLK polarity for PASI FSYNC generation
5-0	PASI_BCLK_FS_RATIO_ MSB[5:0]	R/W	000000b	MSB bits for primary ASI BCLK to FSYNC ratio in controller mode.

**7.1.1.52 CNT\_CLK\_CFG4 Register (Address = 0x39) [Reset = 0x00]**

CNT\_CLK\_CFG4 is shown in [Table 7-54](#).

Return to the [Summary Table](#).

This register is the controller mode clock configuration register 4.

**Table 7-54. CNT\_CLK\_CFG4 Register Field Descriptions**

Bit	Field	Type	Reset	Description
7-0	PASI_BCLK_FS_RATIO_L SB[7:0]	R/W	00000000b	LSB byte for primary ASI BCLK to FSYNC ratio in controller mode.

**7.1.1.53 CNT\_CLK\_CFG5 Register (Address = 0x3A) [Reset = 0x00]**

CNT\_CLK\_CFG5 is shown in [Table 7-55](#).

Return to the [Summary Table](#).

This register is the controller mode clock configuration register 5.

**Table 7-55. CNT\_CLK\_CFG5 Register Field Descriptions**

Bit	Field	Type	Reset	Description
7	SASI_USE_INT_BCLK_F OR_FSYNC	R/W	0b	Use internal BCLK for FSYNC generation in SASI during controller mode configuration. 0d = Use external BCLK for FSYNC generation 1d = Use internal BCLK for FSYNC generation
6	SASI_INV_BCLK_FOR_F SYNC	R/W	0b	Invert SASI BCLK polarity only for SASI FSYNC generation in controller mode configuration. 0d = Do not invert SASI BCLK polarity for SASI FSYNC generation 1d = Invert SASI BCLK polarity for SASI FSYNC generation



**Table 7-55. CNT\_CLK\_CFG5 Register Field Descriptions (continued)**

Bit	Field	Type	Reset	Description
5-0	SASI_BCLK_FS_RATIO_MSB[5:0]	R/W	000000b	MSB bits for secondary ASI BCLK to FSYNC ratio in controller mode.

#### 7.1.1.54 CNT\_CLK\_CFG6 Register (Address = 0x3B) [Reset = 0x00]

CNT\_CLK\_CFG6 is shown in [Table 7-56](#).

Return to the [Summary Table](#).

This register is the controller mode clock configuration register 6.

**Table 7-56. CNT\_CLK\_CFG6 Register Field Descriptions**

Bit	Field	Type	Reset	Description
7-0	SASI_BCLK_FS_RATIO_LSB[7:0]	R/W	00000000b	LSB byte for secondary ASI BCLK to FSYNC ratio in controller mode.

#### 7.1.1.55 CLK\_ERR\_STS0 Register (Address = 0x3C) [Reset = 0x00]

CLK\_ERR\_STS0 is shown in [Table 7-57](#).

Return to the [Summary Table](#).

This register is the clock error and status register 0.

**Table 7-57. CLK\_ERR\_STS0 Register Field Descriptions**

Bit	Field	Type	Reset	Description
7	DSP_CLK_ERR	R	0b	Flag indicating ratio error between FSYNC and selected clock source. 0d = No ratio error 1d = Ratio error between primary or secondary ASI FSYNC and selected clock source
6	RESERVED	R	0b	Reserved bit; Write only reset value
5	RESERVED	R	0b	Reserved bit; Write only reset value
4	SRC_RATIO_ERR	R	0b	Flag indicating that SRC m:n ratio is unsupported. (not valid for custom m/n ratio config). 0d = m:n ratio supported 1d = Unsupported m:n ratio error
3	DEM_RATE_ERR	R	0b	Flag indicating that clock configuration does not allow valid DEM rate. 0d = No DEM clock rate error 1d = DEM clock rate error in selected clock configuration
2	PDM_CLK_ERR	R	0b	Flag indicating that clock configuration does not allow valid PDM clock generation. 0d = No PDM clock generation error 1d = PDM clock generation error in selected clock configuration
1	RESET_ON_CLK_STOP_DET_STS	R	0b	Flag indicating that audio clock source stopped for at least 1ms. 0d = No audio clock source error 1d = Audio clock source stopped for at least 1ms
0	RESERVED	R	0b	Reserved bit; Write only reset value

#### 7.1.1.56 CLK\_ERR\_STS1 Register (Address = 0x3D) [Reset = 0x00]

CLK\_ERR\_STS1 is shown in [Table 7-58](#).

Return to the [Summary Table](#).

This register is the clock error and status register 1.

**Table 7-58. CLK\_ERR\_STS1 Register Field Descriptions**

Bit	Field	Type	Reset	Description
7	PASI_BCLK_FS_RATIO_ERR	R	0b	Flag indicating PASI bclk fsync ratio error. 0d = No PASI bclk fsync ratio error 1d = PASI bclk fsync ratio error in selected clock configuration
6	SASI_BCLK_FS_RATIO_ERR	R	0b	Flag indicating SASI bclk fsync ratio error. 0d = No SASI bclk fsync ratio error 1d = SASI bclk fsync ratio error in selected clock configuration
5	CCLK_FS_RATIO_ERR	R	0b	Flag indicating CCLK fsync ratio error. 0d = No CCLK fsync ratio error 1d = CCLK fsync ratio error
4	PASI_FS_ERR	R	0b	Flag indicating PASI FS rate change or halt error. 0d = No PASI FS error 1d = PASI FS rate change or halt detected
3	SASI_FS_ERR	R	0b	Flag indicating SASI FS rate change or halt error. 0d = No SASI FS error 1d = SASI FS rate change or halt detected
2-0	RESERVED	R	0b	Reserved bits; Write only reset values

#### 7.1.1.57 CLK\_DET\_STS0 Register (Address = 0x3E) [Reset = 0x00]

CLK\_DET\_STS0 is shown in [Table 7-59](#).

Return to the [Summary Table](#).

This register is the clock ratio detection register 0.

**Table 7-59. CLK\_DET\_STS0 Register Field Descriptions**

Bit	Field	Type	Reset	Description
7-2	PASI_SAMP_RATE_STS[5:0]	R	000000b	Primary ASI Sample rate detected status. 0d = Reserved 1d = 768000 (670320-791040) 2d = 614400 (536256-632832) 3d = 512000 (446880-527360) 4d = 438857 (383040-452022) 5d = 384000 (335160-395520) 6d = 341333 (297920-351573) 7d = 307200 (268128-316416) 8d = 256000 (223440-263680) 9d = 219429 (191520-226011) 10d = 192000 (167580-197760) 11d = 170667 (148960-175786) 12d = 153600 (134064-158208) 13d = 128000 (111720-131840) 14d = 109714 (95760-113005) 15d = 96000 (83790-98880) 16d = 85333 (74480-87893) 17d = 76800 (67032-79104) 18d = 64000 (55860-65920) 19d = 54857 (47880-56502) 20d = 48000 (41895-49440) 21d = 42667 (37240-43946) 22d = 38400 (33516-39552) 23d = 32000 (27930-32960) 24d = 27429 (23940-28251) 25d = 24000 (20947-24720) 26d = 21333 (18620-21973) 27d = 19200 (16758-19776) 28d = 16000 (13965-16480) 29d = 13714 (11970-14125) 30d = 12000 (10473-12360) 31d = 10667 (9310-10986) 32d = 9600 (8379-9888) 33d = 8000 (6982-8240) 34d = 6857 (5985-7062) 35d = 6000 (5236-6180) 36d = 5333 (4655-5493) 37d = 4800 (4189-4944) 38d = 4000 (3491-4120) 39d = 3429 (2992-3531) 40d = 3000 (2618-3090) 41d-63d = Reserved
1-0	PLL_MODE_STS[1:0]	R	00b	PLL usage status. 0d = PLL used in integer mode 1d = PLL used in fractional mode 2d = PLL not used 3d = Reserved

**7.1.1.58 CLK\_DET\_STS1 Register (Address = 0x3F) [Reset = 0x00]**

CLK\_DET\_STS1 is shown in [Table 7-60](#).

Return to the [Summary Table](#).

This register is the clock ratio detection register 1.

**Table 7-60. CLK\_DET\_STS1 Register Field Descriptions**

Bit	Field	Type	Reset	Description
7-2	SASI_SAMP_RATE_STS[5:0]	R	000000b	Secondary ASI Sample rate detected status. 0d = Reserved 1d = 768000 (670320-791040) 2d = 614400 (536256-632832) 3d = 512000 (446880-527360) 4d = 438857 (383040-452022) 5d = 384000 (335160-395520) 6d = 341333 (297920-351573) 7d = 307200 (268128-316416) 8d = 256000 (223440-263680) 9d = 219429 (191520-226011) 10d = 192000 (167580-197760) 11d = 170667 (148960-175786) 12d = 153600 (134064-158208) 13d = 128000 (111720-131840) 14d = 109714 (95760-113005) 15d = 96000 (83790-98880) 16d = 85333 (74480-87893) 17d = 76800 (67032-79104) 18d = 64000 (55860-65920) 19d = 54857 (47880-56502) 20d = 48000 (41895-49440) 21d = 42667 (37240-43946) 22d = 38400 (33516-39552) 23d = 32000 (27930-32960) 24d = 27429 (23940-28251) 25d = 24000 (20947-24720) 26d = 21333 (18620-21973) 27d = 19200 (16758-19776) 28d = 16000 (13965-16480) 29d = 13714 (11970-14125) 30d = 12000 (10473-12360) 31d = 10667 (9310-10986) 32d = 9600 (8379-9888) 33d = 8000 (6982-8240) 34d = 6857 (5985-7062) 35d = 6000 (5236-6180) 36d = 5333 (4655-5493) 37d = 4800 (4189-4944) 38d = 4000 (3491-4120) 39d = 3429 (2992-3531) 40d = 3000 (2618-3090) 41d-63d = Reserved
1-0	RESERVED	R	0b	Reserved bits; Write only reset values

**7.1.1.59 CLK\_DET\_STS2 Register (Address = 0x40) [Reset = 0x00]**

CLK\_DET\_STS2 is shown in [Table 7-61](#).

Return to the [Summary Table](#).

This register is the clock ratio detection register 2.

**Table 7-61. CLK\_DET\_STS2 Register Field Descriptions**

Bit	Field	Type	Reset	Description
7-6	RESERVED	R	0b	Reserved bits; Write only reset values
5-0	FS_CLKSRC_RATIO_DETECT_MSB_STS[5:0]	R	000000b	MSB bits for primary ASI or secondary ASI FSYNC to clock source ratio detected.

### 7.1.1.60 CLK\_DET\_STS3 Register (Address = 0x41) [Reset = 0x00]

CLK\_DET\_STS3 is shown in [Table 7-62](#).

Return to the [Summary Table](#).

This register is the clock ratio detection register 3.

**Table 7-62. CLK\_DET\_STS3 Register Field Descriptions**

Bit	Field	Type	Reset	Description
7-0	FS_CLKSRC_RATIO_DE T_LSB_STS[7:0]	R	00000000b	LSB byte for primary ASI or secondary ASI FSYNC to clock source ratio detected.

### 7.1.1.61 INT\_CFG Register (Address = 0x42) [Reset = 0x00]

INT\_CFG is shown in [Table 7-63](#).

Return to the [Summary Table](#).

This register is the interrupt configuration register.

**Table 7-63. INT\_CFG Register Field Descriptions**

Bit	Field	Type	Reset	Description
7	INT_POL	R/W	0b	Interrupt polarity. 0b = Active low (IRQZ) 1b = Active high (IRQ)
6-5	INT_EVENT[1:0]	R/W	00b	Interrupt event configuration. 0d = INT asserts on any unmasked latched interrupts event 1d = INT asserts on any unmasked live interrupts event 2d = INT asserts for 2 ms (typical) for every 4-ms (typical) duration on any unmasked latched interrupts event 3d = INT asserts for 2 ms (typical) one time on each pulse for any unmasked interrupts event
4-3	PD_ON_FLT_CFG[1:0]	R/W	00b	Power down configuration during fault for chx and micbias. 0d = Faults are not considered for power down 1d = Only unmasked faults are considered for power down 2d = All faults are considered for power down 3d = Reserved
2	LTCH_READ_CFG	R/W	0b	Interrupt latch registers readback configuration. 0b = All interrupts can be read through the LTCH registers 1b = Only unmasked interrupts can be read through the LTCH registers
1	PD_ON_FLT_RCV_CFG	R/W	0b	Configuration for Power down ADC channels on fault 0b = Auto recovery, ADC channels are re-powered up when fault goes away 1b = Manual recovery, ADC channels are not re-powered up when fault goes away
0	LTCH_CLR_ON_READ	R/W	0b	Cfgn for clearing LTCH register bits 0 = LTCH reg bits are cleared on reg read only if live status is zero 1 = LTCH reg bits are cleared on reg read irrespective of live status

### 7.1.1.62 DAC\_FLT\_CFG Register (Address = 0x43) [Reset = 0x54]

DAC\_FLT\_CFG is shown in [Table 7-64](#).

Return to the [Summary Table](#).

This register is the interrupt configuration register.

**Table 7-64. DAC\_FLT\_CFG Register Field Descriptions**

Bit	Field	Type	Reset	Description
7	RESERVED	R	0b	Reserved bit; Write only reset value
6-5	DAC_PD_ON_FLT_CFG[1:0]	R/W	10b	Power down configuration during fault for DAC . 0d = Faults are not considered for power down 1d = Only unmasked faults are considered for power down 2d = All faults are considered for power down 3d = Reserved
4	DAC_PD_ON_FLT_RCV_CFG	R/W	1b	Configuration for Power down DAC channels on fault 0b = Auto recovery, DAC channels are re-powered up when fault goes away 1b = Manual recovery, DAC channels are not re-powered up when fault goes away
3	OUT_CHX_PD_FLT_STS	R	0b	Status for PD on OUTxx faults 0d = No DAC Channel is Powered Down due to fault/s 1d = Some DAC Channel is Powered Down due to fault/s
2	DAC_DIS_PD_W_PU	R/W	1b	Disable power down on DRVR VG fault while powering up DAC 0b = Power down DAC on DRVR VG fault while power up 1b = Disable power down DAC on DRVR VG fault while power up
1	DAC_FLT_DET_DIS	R/W	0b	DAC vg_fault/sc_fault detect config 0b = enable 1b = disable
0	AREG_SC_FLAG_DET_DIS	R/W	0b	AREG short circuit detect config 0b = enable 1b = disable

**7.1.1.63 VREF\_MICBIAS\_CFG Register (Address = 0x4D) [Reset = 0x00]**

VREF\_MICBIAS\_CFG is shown in [Table 7-65](#).

Return to the [Summary Table](#).

This register is the configuration register for VREF and MICBIAS.

**Table 7-65. VREF\_MICBIAS\_CFG Register Field Descriptions**

Bit	Field	Type	Reset	Description
7-5	RESERVED	R	0b	Reserved bits; Write only reset values
4	MICBIAS_LDO_GAIN	R/W	0b	MICBIAS Output Gain Setting 0d = LDO gain = 1 1d = LDO gain = 1.096
3-2	MICBIAS_VAL[1:0]	R/W	00b	MICBIAS Output Setting 0d = Microphone Bias is set to VREF 1d = Microphone Bias is set to VREF/2 (Valid only for VREF_FSCALE 0 or 1 setting) 2d = Reserved 3d = Microphone Bias output is bypassed to AVDD
1-0	VREF_FSCALE[1:0]	R/W	00b	VREF/Full-Scale Setting (Need to configure this based on AVDD min voltage used) 0d = VREF set to 2.75 V to support 2 V <sub>RMS</sub> for Differential Input or 1 V <sub>RMS</sub> for Single-Ended Input 1d = VREF set to 2.5 V to support 1.818 V <sub>RMS</sub> for Differential Input or 0.909 V <sub>RMS</sub> for Single-Ended Input 2d = VREF set to 1.375 V to support 1 V <sub>RMS</sub> for Differential Input or 0.5 V <sub>RMS</sub> for Single-Ended Input 3d = Reserved

**7.1.1.64 PWR\_TUNE\_CFG0 Register (Address = 0x4E) [Reset = 0x00]**

PWR\_TUNE\_CFG0 is shown in [Table 7-66](#).

Return to the [Summary Table](#).

This register is configuration register 0 for power tune configuration.

**Table 7-66. PWR\_TUNE\_CFG0 Register Field Descriptions**

Bit	Field	Type	Reset	Description
7	ADC_CLK_BY2_MODE	R/W	0b	ADC MOD CLK select configuration. 0d = MOD CLK 3.072MHz or 2.8224MHz 1d = MOD CLK 1.536MHz or 1.4112MHz
6	ADC_CIC_ORDER	R/W	0b	ADC CIC order configuration. 0d = 5th order CIC 1d = 4th order CIC
5	ADC_FIR_BYPASS	R/W	0b	ADC FIR bypass configuration. 0d = Bypass disable 1d = Bypass enable
4	ADC_DEM_RATE_OVRD	R/W	0b	ADC DEM rate override configuration. 0d = Default 1d = 2x
3	RESERVED	R	0b	Reserved bit; Write only reset value
2	ADC_LOW_PWR_FILTER	R/W	0b	Low Power filter configuration for ADC 0d = Disable 1d = Enable
1-0	RESERVED	R	0b	Reserved bits; Write only reset values

#### 7.1.1.65 PWR\_TUNE\_CFG1 Register (Address = 0x4F) [Reset = 0x00]

PWR\_TUNE\_CFG1 is shown in [Table 7-67](#).

Return to the [Summary Table](#).

This register is configuration register for power tune configuration.

**Table 7-67. PWR\_TUNE\_CFG1 Register Field Descriptions**

Bit	Field	Type	Reset	Description
7	DAC_CLK_BY2_MODE	R/W	0b	DAC MOD CLK select configuration. 0d = MOD CLK 3MHz 1d = MOD CLK 1.5MHz
6	RESERVED	R	0b	Reserved bit; Write only reset value
5	RESERVED	R	0b	Reserved bit; Write only reset value
4	DAC_DEM_RATE_OVRD	R/W	0b	DAC DEM rate override configuration. 0d = Default 1d = 2x
3	RESERVED	R	0b	Reserved bit; Write only reset value
2	DAC_LOW_PWR_FILTER	R/W	0b	Low Power Filter configuration for DAC 0d = Disable 1d = Enable
1	DAC_POWER_SCAL	R/W	0b	DAC IREF select configuration. 0d = Vref/R 1d = Vref/2R
0	RESERVED	R	0b	Reserved bit; Write only reset value

#### 7.1.1.66 ADC\_CH1\_CFG2 Register (Address = 0x52) [Reset = 0xA1]

ADC\_CH1\_CFG2 is shown in [Table 7-68](#).

Return to the [Summary Table](#).

This register is configuration register 2 for ADC channel 1.

**Table 7-68. ADC\_CH1\_CFG2 Register Field Descriptions**

Bit	Field	Type	Reset	Description
7-0	ADC_CH1_DVOL[7:0]	R/W	10100001b	Channel 1 digital volume control. 0d = Digital volume is muted 1d = Digital volume control is set to -80 dB 2d = Digital volume control is set to -79.5 dB 3d to 160d = Digital volume control is set as per configuration 161d = Digital volume control is set to 0 dB 162d = Digital volume control is set to 0.5 dB 163d to 253d = Digital volume control is set as per configuration 254d = Digital volume control is set to 46.5 dB 255d = Digital volume control is set to 47 dB

#### 7.1.1.67 ADC\_CH1\_CFG3 Register (Address = 0x53) [Reset = 0x80]

ADC\_CH1\_CFG3 is shown in [Table 7-69](#).

Return to the [Summary Table](#).

This register is configuration register 3 for ADC channel 1.

**Table 7-69. ADC\_CH1\_CFG3 Register Field Descriptions**

Bit	Field	Type	Reset	Description
7-4	ADC_CH1_FGAIN[3:0]	R/W	1000b	ADC channel 1 fine gain calibration. 0d = Fine gain is set to -0.8 dB 1d = Fine gain is set to -0.7 dB 2d = Fine gain is set to -0.6 dB 3d to 7d = Fine gain is set as per configuration 8d = Fine gain is set to 0 dB 9d = Fine gain is set to 0.1 dB 10d to 13d = Fine gain is set as per configuration 14d = Fine gain is set to 0.6 dB 15d = Fine gain is set to 0.7 dB
3-0	RESERVED	R	0b	Reserved bits; Write only reset value

#### 7.1.1.68 ADC\_CH1\_CFG4 Register (Address = 0x54) [Reset = 0x00]

ADC\_CH1\_CFG4 is shown in [Table 7-70](#).

Return to the [Summary Table](#).

This register is configuration register 4 for ADC channel 1.

**Table 7-70. ADC\_CH1\_CFG4 Register Field Descriptions**

Bit	Field	Type	Reset	Description
7-2	ADC_CH1_PCAL[5:0]	R/W	000000b	ADC channel 1 phase calibration with modulator clock resolution. 0d = No phase calibration 1d = Phase calibration delay is set to one cycle of the modulator clock 2d = Phase calibration delay is set to two cycles of the modulator clock 3d to 62d = Phase calibration delay as per configuration 63d = Phase calibration delay is set to 63 cycles of the modulator clock
1-0	PCAL_ANA_DIG_SEL[1:0] ]	R/W	00b	PCAL support configuration. 0d = Pcal for both Ana-Dig supported 1d = Pcal for only Ana 2d = Pcal for only Dig 3d = Reserved



### 7.1.1.69 ADC\_CH2\_CFG2 Register (Address = 0x57) [Reset = 0xA1]

ADC\_CH2\_CFG2 is shown in [Table 7-71](#).

Return to the [Summary Table](#).

This register is configuration register 2 for channel 2.

**Table 7-71. ADC\_CH2\_CFG2 Register Field Descriptions**

Bit	Field	Type	Reset	Description
7-0	ADC_CH2_DVOL[7:0]	R/W	10100001b	Channel 1 digital volume control. 0d = Digital volume is muted 1d = Digital volume control is set to -80 dB 2d = Digital volume control is set to -79.5 dB 3d to 160d = Digital volume control is set as per configuration 161d = Digital volume control is set to 0 dB 162d = Digital volume control is set to 0.5 dB 163d to 253d = Digital volume control is set as per configuration 254d = Digital volume control is set to 46.5 dB 255d = Digital volume control is set to 47 dB

### 7.1.1.70 ADC\_CH2\_CFG3 Register (Address = 0x58) [Reset = 0x80]

ADC\_CH2\_CFG3 is shown in [Table 7-72](#).

Return to the [Summary Table](#).

This register is configuration register 3 for ADC Channel 2.

**Table 7-72. ADC\_CH2\_CFG3 Register Field Descriptions**

Bit	Field	Type	Reset	Description
7-4	ADC_CH2_FGAIN[3:0]	R/W	1000b	ADC Channel 2 fine gain calibration. 0d = Fine gain is set to -0.8 dB 1d = Fine gain is set to -0.7 dB 2d = Fine gain is set to -0.6 dB 3d to 7d = Fine gain is set as per configuration 8d = Fine gain is set to 0 dB 9d = Fine gain is set to 0.1 dB 10d to 13d = Fine gain is set as per configuration 14d = Fine gain is set to 0.6 dB 15d = Fine gain is set to 0.7 dB
3-0	RESERVED	R	0b	Reserved bits; Write only reset value

### 7.1.1.71 ADC\_CH2\_CFG4 Register (Address = 0x59) [Reset = 0x00]

ADC\_CH2\_CFG4 is shown in [Table 7-73](#).

Return to the [Summary Table](#).

This register is configuration register 4 for ADC Channel 2.

**Table 7-73. ADC\_CH2\_CFG4 Register Field Descriptions**

Bit	Field	Type	Reset	Description
7-2	ADC_CH2_PCAL[5:0]	R/W	000000b	ADC Channel 2 phase calibration with modulator clock resolution. 0d = No phase calibration 1d = Phase calibration delay is set to one cycle of the modulator clock 2d = Phase calibration delay is set to two cycles of the modulator clock 3d to 62d = Phase calibration delay as per configuration 63d = Phase calibration delay is set to 63 cycles of the modulator clock

**Table 7-73. ADC\_CH2\_CFG4 Register Field Descriptions (continued)**

Bit	Field	Type	Reset	Description
1-0	RESERVED	R	0b	Reserved bits; Write only reset value

**7.1.1.72 ADC\_CH3\_CFG0 Register (Address = 0x5A) [Reset = 0x00]**

ADC\_CH3\_CFG0 is shown in [Table 7-74](#).

Return to the [Summary Table](#).

This register is configuration register 0 for ADC channel 3.

**Table 7-74. ADC\_CH3\_CFG0 Register Field Descriptions**

Bit	Field	Type	Reset	Description
7	ADC_CH3_CLONE	R/W	0b	ADC Channel 3 input configuration. 0d = clone disabled 1d = Channel 3 Digital Filter Input is generated same as Channel 1 Digital Filter Input (Cloned Input)
6-0	RESERVED	R	0b	Reserved bits; Write only reset value

**7.1.1.73 ADC\_CH3\_CFG2 Register (Address = 0x5B) [Reset = 0xA1]**

ADC\_CH3\_CFG2 is shown in [Table 7-75](#).

Return to the [Summary Table](#).

This register is configuration register 2 for ADC channel 3.

**Table 7-75. ADC\_CH3\_CFG2 Register Field Descriptions**

Bit	Field	Type	Reset	Description
7-0	ADC_CH3_DVOL[7:0]	R/W	10100001b	Channel 3 digital volume control. 0d = Digital volume is muted 1d = Digital volume control is set to -80 dB 2d = Digital volume control is set to -79.5 dB 3d to 160d = Digital volume control is set as per configuration 161d = Digital volume control is set to 0 dB 162d = Digital volume control is set to 0.5 dB 163d to 253d = Digital volume control is set as per configuration 254d = Digital volume control is set to 46.5 dB 255d = Digital volume control is set to 47 dB

**7.1.1.74 ADC\_CH3\_CFG3 Register (Address = 0x5C) [Reset = 0x80]**

ADC\_CH3\_CFG3 is shown in [Table 7-76](#).

Return to the [Summary Table](#).

This register is configuration register 3 for ADC channel 3.

**Table 7-76. ADC\_CH3\_CFG3 Register Field Descriptions**

Bit	Field	Type	Reset	Description
7-4	ADC_CH3_FGAIN[3:0]	R/W	1000b	ADC channel 3 fine gain calibration. 0d = Fine gain is set to -0.8 dB 1d = Fine gain is set to -0.7 dB 2d = Fine gain is set to -0.6 dB 3d to 7d = Fine gain is set as per configuration 8d = Fine gain is set to 0 dB 9d = Fine gain is set to 0.1 dB 10d to 13d = Fine gain is set as per configuration 14d = Fine gain is set to 0.6 dB 15d = Fine gain is set to 0.7 dB
3-0	RESERVED	R	0b	Reserved bits; Write only reset value

#### 7.1.1.75 ADC\_CH3\_CFG4 Register (Address = 0x5D) [Reset = 0x00]

ADC\_CH3\_CFG4 is shown in [Table 7-77](#).

Return to the [Summary Table](#).

This register is configuration register 4 for ADC channel 3.

**Table 7-77. ADC\_CH3\_CFG4 Register Field Descriptions**

Bit	Field	Type	Reset	Description
7-2	ADC_CH3_PCAL[5:0]	R/W	000000b	ADC channel 3 phase calibration with modulator clock resolution. 0d = No phase calibration 1d = Phase calibration delay is set to one cycle of the modulator clock 2d = Phase calibration delay is set to two cycles of the modulator clock 3d to 62d = Phase calibration delay as per configuration 63d = Phase calibration delay is set to 63 cycles of the modulator clock
1-0	RESERVED	R	0b	Reserved bits; Write only reset value

#### 7.1.1.76 ADC\_CH4\_CFG0 Register (Address = 0x5E) [Reset = 0x00]

ADC\_CH4\_CFG0 is shown in [Table 7-78](#).

Return to the [Summary Table](#).

This register is configuration register 0 for ADC Channel 4.

**Table 7-78. ADC\_CH4\_CFG0 Register Field Descriptions**

Bit	Field	Type	Reset	Description
7	ADC_CH4_CLONE	R/W	0b	ADC Channel 4 input configuration. 0d = clone disabled 1d = Channel 4 Digital Filter Input is generated same as Channel 2 Digital Filter Input (Cloned Input)
6-0	RESERVED	R	0b	Reserved bits; Write only reset value

#### 7.1.1.77 ADC\_CH4\_CFG2 Register (Address = 0x5F) [Reset = 0xA1]

ADC\_CH4\_CFG2 is shown in [Table 7-79](#).

Return to the [Summary Table](#).

This register is configuration register 2 for channel 4.

**Table 7-79. ADC\_CH4\_CFG2 Register Field Descriptions**

Bit	Field	Type	Reset	Description
7-0	ADC_CH4_DVOL[7:0]	R/W	10100001b	Channel 4 digital volume control. 0d = Digital volume is muted 1d = Digital volume control is set to -80 dB 2d = Digital volume control is set to -79.5 dB 3d to 160d = Digital volume control is set as per configuration 161d = Digital volume control is set to 0 dB 162d = Digital volume control is set to 0.5 dB 163d to 253d = Digital volume control is set as per configuration 254d = Digital volume control is set to 46.5 dB 255d = Digital volume control is set to 47 dB

**7.1.1.78 ADC\_CH4\_CFG3 Register (Address = 0x60) [Reset = 0x80]**

ADC\_CH4\_CFG3 is shown in [Table 7-80](#).

Return to the [Summary Table](#).

This register is configuration register 3 for ADC Channel 4.

**Table 7-80. ADC\_CH4\_CFG3 Register Field Descriptions**

Bit	Field	Type	Reset	Description
7-4	ADC_CH4_FGAIN[3:0]	R/W	1000b	ADC Channel 4 fine gain calibration. 0d = Fine gain is set to -0.8 dB 1d = Fine gain is set to -0.7 dB 2d = Fine gain is set to -0.6 dB 3d to 7d = Fine gain is set as per configuration 8d = Fine gain is set to 0 dB 9d = Fine gain is set to 0.1 dB 10d to 13d = Fine gain is set as per configuration 14d = Fine gain is set to 0.6 dB 15d = Fine gain is set to 0.7 dB
3-0	RESERVED	R	0b	Reserved bits; Write only reset value

**7.1.1.79 ADC\_CH4\_CFG4 Register (Address = 0x61) [Reset = 0x00]**

ADC\_CH4\_CFG4 is shown in [Table 7-81](#).

Return to the [Summary Table](#).

This register is configuration register 4 for ADC Channel 4.

**Table 7-81. ADC\_CH4\_CFG4 Register Field Descriptions**

Bit	Field	Type	Reset	Description
7-2	ADC_CH4_PCAL[5:0]	R/W	000000b	ADC Channel 4 phase calibration with modulator clock resolution. 0d = No phase calibration 1d = Phase calibration delay is set to one cycle of the modulator clock 2d = Phase calibration delay is set to two cycles of the modulator clock 3d to 62d = Phase calibration delay as per configuration 63d = Phase calibration delay is set to 63 cycles of the modulator clock
1-0	RESERVED	R	0b	Reserved bits; Write only reset value

**7.1.1.80 OUT1x\_CFG0 Register (Address = 0x64) [Reset = 0x20]**

OUT1x\_CFG0 is shown in [Table 7-82](#).

Return to the [Summary Table](#).

This register is configuration register 0 for Channel OUT1x.

**Table 7-82. OUT1x\_CFG0 Register Field Descriptions**

Bit	Field	Type	Reset	Description
7-5	OUT1x_SRC[2:0]	R/W	001b	OUT1x Source Configuration. 0d = Reserved; Don't use 1d = Input from DAC signal chain 2d = Input from Analog bypass path 3d = Input from both DAC signal chain and Analog bypass path 4d = Independent input from both DAC signal chain and Analog bypass path (DAC -> OUT1P , IN1P -> OUT1M) 5d = Independent input from both DAC signal chain and Analog bypass path (IN1M -> OUT1P, DAC -> OUT1M) 6d-7d = Reserved; Don't use
4-2	OUT1x_CFG[2:0]	R/W	000b	OUT1x DAC / Analog Bypass Routing Configuration. (Don't use if OUT1x_SRC configured 4d or 5d) 0d = Differential (DAC1AP + DAC1BP / IN1M -> OUT1P ; DAC1AM + DAC1BM / IN1P -> OUT1M) 1d = Stereo single-ended (DAC1A / IN1M -> OUT1P ; DAC1B / IN1P -> OUT1M) 2d = Mono single-ended with output at OUT1P only (DAC1A + DAC1B / IN1M-> OUT1P) 3d = Mono single-ended with output at OUT1M only (DAC1A + DAC1B / IN1P -> OUT1M) 4d = Pseudo differential with OUT1M as VCOM (DAC1A, DAC1B / IN1M -> OUT1P, VCOM -> OUT1M) 5d = Pseudo differential with OUT1M as VCOM and OUT2M for external sensing (DAC1A, DAC1B / IN1M -> OUT1P, VCOM -> OUT1M) 6d = Pseudo differential with OUT1P as VCOM (IN1P -> OUT1M, VCOM -> OUT1P) 7d = Reserved; Don't use
1	OUT1x_VCOM	R/W	0b	Channel OUT1x VCOM configuration. 0d = 0.6 * Vref (for 1.375V VREF mode alone as 0.654*Vref) 1d = AVDD by 2
0	RESERVED	R	0b	Reserved bit; Write only reset value

#### 7.1.1.81 OUT1x\_CFG1 Register (Address = 0x65) [Reset = 0x20]

OUT1x\_CFG1 is shown in [Table 7-83](#).

Return to the [Summary Table](#).

This register is configuration register 1 for Channel OUT1x.

**Table 7-83. OUT1x\_CFG1 Register Field Descriptions**

Bit	Field	Type	Reset	Description
7-6	OUT1P_DRIVE[1:0]	R/W	00b	Channel OUT1P drive configuration. 0d = Line out driver with minimum 300Ω single ended impedance 1d = Headphone driver with minimum 16Ω single ended impedance 2d = To drive minimum of 4Ω single ended impedance 3d = For higher DR/SNR for FD receiver loads

**Table 7-83. OUT1x\_CFG1 Register Field Descriptions (continued)**

Bit	Field	Type	Reset	Description
5-3	OUT1P_LVL_CTRL[2:0]	R/W	100b	Channel OUT1P level control configuration. 0d = Reserved; Don't use 1d = Reserved; Don't use 2d = 12 dB (only valid in bypass only mode configured in OUT1x_SRC{B0_P0_R100}) 3d = 6 dB (only valid if ana bypass mode or ana-dig mix mode configured in OUT1x_SRC{B0_P0_R100}) 4d = 0 dB 5d = -6 dB (only valid if ana bypass mode or ana-dig mix mode configured in OUT1x_SRC{B0_P0_R100}) 6d = -12 dB (only valid if ana bypass mode or ana-dig mix mode configured in OUT1x_SRC{B0_P0_R100} and AIN1M_BYP_IMP configured 4.4kΩ ) 7d = Reserved; Don't use
2	AIN1M_BYP_IMP	R/W	0b	AIN1M Analog Bypass input impedance. 0d = 4.4kΩ 1d = 20kΩ
1	AIN1x_BYP_CFG	R/W	0b	IN1x Analog Bypass input config. 0d = FD / Pseudo Diff 1d = SE
0	DAC_CH1_BW_MODE	R/W	0b	DAC Channel 1 band-width selection. 0d = audio band-width (24 kHz mode) 1d = wide band-width (96 kHz mode)

**7.1.1.82 OUT1x\_CFG2 Register (Address = 0x66) [Reset = 0x20]**

OUT1x\_CFG2 is shown in [Table 7-84](#).

Return to the [Summary Table](#).

This register is configuration register 2 for Channel OUT2x.

**Table 7-84. OUT1x\_CFG2 Register Field Descriptions**

Bit	Field	Type	Reset	Description
7-6	OUT1M_DRIVE[1:0]	R/W	00b	Channel OUT1M drive configuration. 0d = Line out driver with minimum 300Ω single ended impedance 1d = Headphone driver with minimum 16Ω single ended impedance 2d = To drive minimum of 4Ω single ended impedance 3d = For higher DR/SNR for FD receiver loads
5-3	OUT1M_LVL_CTRL[2:0]	R/W	100b	Channel OUT1M level control configuration. 0d = Reserved; Don't use 1d = Reserved; Don't use 2d = 12 dB (only valid in bypass only mode configured in OUT1x_SRC{B0_P0_R100}) 3d = 6 dB (only valid if ana bypass mode or ana-dig mix mode configured in OUT1x_SRC{B0_P0_R100}) 4d = 0 dB 5d = -6 dB (only valid if ana bypass mode or ana-dig mix mode configured in OUT1x_SRC{B0_P0_R100}) 6d = -12 dB (only valid if ana bypass mode or ana-dig mix mode configured in OUT1x_SRC{B0_P0_R100} and AIN1M_BYP_IMP configured 4.4kΩ) 7d = Reserved; Don't use
2	AIN1P_BYP_IMP	R/W	0b	AIN1P Analog Bypass input impedance. 0d = 4.4kΩ 1d = 20kΩ
1	RESERVED	R	0b	Reserved bit; Write only reset value

**Table 7-84. OUT1x\_CFG2 Register Field Descriptions (continued)**

Bit	Field	Type	Reset	Description
0	DAC_CH1_CM_TOL	R/W	0b	DAC Channel 1 input coupling (applicable for the analog input). 0d = AC-coupled input 1d = AC-coupled / DC-coupled input

#### 7.1.1.83 DAC\_CH1A\_CFG0 Register (Address = 0x67) [Reset = 0xC9]

DAC\_CH1A\_CFG0 is shown in [Table 7-85](#).

Return to the [Summary Table](#).

This register is configuration register 0 for DAC channel 1A.

**Table 7-85. DAC\_CH1A\_CFG0 Register Field Descriptions**

Bit	Field	Type	Reset	Description
7-0	DAC_CH1A_DVOL[7:0]	R/W	11001001b	Channel 1A digital volume control. 0d = Digital Volume is muted 1d = Digital Volume Control set to -100 dB 2d = Digital Volume Control set to -99.5 dB 3d to 200d = Digital Volume Control set to as per configuration 201d = Digital Volume Control set to 0 dB 202d = Digital Volume Control set to +0.5 dB 203d to 253d = Digital Volume Control set to as per configuration 254d = Digital Volume Control set to +26.5 dB 255d = Digital Volume Control set to +27 dB

#### 7.1.1.84 DAC\_CH1A\_CFG1 Register (Address = 0x68) [Reset = 0x80]

DAC\_CH1A\_CFG1 is shown in [Table 7-86](#).

Return to the [Summary Table](#).

This register is configuration register 1 for DAC channel 1A.

**Table 7-86. DAC\_CH1A\_CFG1 Register Field Descriptions**

Bit	Field	Type	Reset	Description
7-4	DAC_CH1A_FGAIN[3:0]	R/W	1000b	DAC channel 1A fine gain calibration. 0d = Fine gain is set to -0.8 dB 1d = Fine gain is set to -0.7 dB 2d = Fine gain is set to -0.6 dB 3d to 7d = Fine gain is set as per configuration 8d = Fine gain is set to 0 dB 9d = Fine gain is set to 0.1 dB 10d to 13d = Fine gain is set as per configuration 14d = Fine gain is set to 0.6 dB 15d = Fine gain is set to 0.7 dB
3-0	RESERVED	R	0b	Reserved bits; Write only reset value

#### 7.1.1.85 DAC\_CH1B\_CFG0 Register (Address = 0x69) [Reset = 0xC9]

DAC\_CH1B\_CFG0 is shown in [Table 7-87](#).

Return to the [Summary Table](#).

This register is configuration register 0 for DAC channel 1B.

**Table 7-87. DAC\_CH1B\_CFG0 Register Field Descriptions**

Bit	Field	Type	Reset	Description
7-0	DAC_CH1B_DVOL[7:0]	R/W	11001001b	Channel 1B digital volume control. 0d = Digital Volume is muted 1d = Digital Volume Control set to -100 dB 2d = Digital Volume Control set to -99.5 dB 3d to 200d = Digital Volume Control set to as per configuration 201d = Digital Volume Control set to 0 dB 202d = Digital Volume Control set to +0.5 dB 203d to 253d = Digital Volume Control set to as per configuration 254d = Digital Volume Control set to +26.5 dB 255d = Digital Volume Control set to +27 dB

**7.1.1.86 DAC\_CH1B\_CFG1 Register (Address = 0x6A) [Reset = 0x80]**

DAC\_CH1B\_CFG1 is shown in [Table 7-88](#).

Return to the [Summary Table](#).

This register is configuration register 1 for DAC channel 1B.

**Table 7-88. DAC\_CH1B\_CFG1 Register Field Descriptions**

Bit	Field	Type	Reset	Description
7-4	DAC_CH1B_FGAIN[3:0]	R/W	1000b	DAC channel 1B fine gain calibration. 0d = Fine gain is set to -0.8 dB 1d = Fine gain is set to -0.7 dB 2d = Fine gain is set to -0.6 dB 3d to 7d = Fine gain is set as per configuration 8d = Fine gain is set to 0 dB 9d = Fine gain is set to 0.1 dB 10d to 13d = Fine gain is set as per configuration 14d = Fine gain is set to 0.6 dB 15d = Fine gain is set to 0.7 dB
3-0	RESERVED	R	0b	Reserved bits; Write only reset value

**7.1.1.87 OUT2x\_CFG0 Register (Address = 0x6B) [Reset = 0x20]**

OUT2x\_CFG0 is shown in [Table 7-89](#).

Return to the [Summary Table](#).

This register is configuration register 0 for Channel OUT2x.

**Table 7-89. OUT2x\_CFG0 Register Field Descriptions**

Bit	Field	Type	Reset	Description
7-5	OUT2x_SRC[2:0]	R/W	001b	OUT2x Source Configuration. 0d = Reserved; Don't use 1d = Input from DAC signal chain 2d = Input from Analog bypass path 3d = Input from both DAC signal chain and Analog bypass path 4d = Independent input from both DAC signal chain and Analog bypass path (DAC -> OUT2P, IN2P -> OUT2M) 5d = Independent input from both DAC signal chain and Analog bypass path (IN2M -> OUT2P, DAC -> OUT2M) 6d-7d = Reserved; Don't use



**Table 7-89. OUT2x\_CFG0 Register Field Descriptions (continued)**

Bit	Field	Type	Reset	Description
4-2	OUT2x_CFG[2:0]	R/W	000b	OUT2x DAC / Analog Bypass Routing Configuration. (Don't use if OUT1x_SRC configured 4d or 5d) 0d = Differential (DAC2AP + DAC2BP / IN2M -> OUT2P ; DAC2AM + DAC2BM / IN2P -> OUT2M) 1d = Stereo single-ended (DAC2A / IN2M -> OUT2P ; DAC2B / IN2P -> OUT2M) 2d = Mono single-ended with output at OUT2P only (DAC2A + DAC2B / IN2M-> OUT2P) 3d = Mono single-ended with output at OUT2M only (DAC2A + DAC2B / IN2P -> OUT2M) 4d = Pseudo differential with OUT2M as VCOM (DAC2A, DAC2B / IN2M -> OUT2P, VCOM -> OUT2M) 5d =Reserved; Don't use 6d = Pseudo differential with OUT2P as VCOM (IN2P -> OUT2M, VCOM -> OUT2P) 7d = Reserved; Don't use
1	OUT2x_VCOM	R/W	0b	Channel OUT2x VCOM configuration. 0d = 0.6 * Vref (for 1.375V VREF mode alone as 0.654*Vref) 2d = AVDD by 2
0	RESERVED	R	0b	Reserved bit; Write only reset value

### 7.1.1.88 OUT2x\_CFG1 Register (Address = 0x6C) [Reset = 0x20]

OUT2x\_CFG1 is shown in [Table 7-90](#).

Return to the [Summary Table](#).

This register is configuration register 1 for Channel OUT2x.

**Table 7-90. OUT2x\_CFG1 Register Field Descriptions**

Bit	Field	Type	Reset	Description
7-6	OUT2P_DRIVE[1:0]	R/W	00b	Channel OUT2P drive configuration. 0d = Line out driver with minimum 300Ω single ended impedance 1d = Headphone driver with minimum 16Ω single ended impedance 2d = To drive minimum of 4Ω single ended impedance 3d = For higher DR/SNR for FD receiver loads
5-3	OUT2P_LVL_CTRL[2:0]	R/W	100b	Channel OUT2P level control configuration. 0d = Reserved; Don't use 1d = Reserved; Don't use 2d = 12 dB (only valid in bypass only mode configured in OUT2x_SRC{B0_P0_R107}) 3d = 6 dB (only valid if ana bypass mode or ana-dig mix mode configured in OUT2x_SRC{B0_P0_R107}) 4d = 0 dB 5d = -6 dB (only valid if ana bypass mode or ana-dig mix mode configured in OUT2x_SRC{B0_P0_R107}) 6d = -12 dB (only valid if ana bypass mode or ana-dig mix mode configured in OUT2x_SRC{B0_P0_R107} and AIN1M_BYP_IMP configured 4.4kΩ) 7d = Reserved; Don't use
2	AIN2M_BYP_IMP	R/W	0b	AIN2M Analog Bypass input impedance. 0d = 4.4kΩ 1d = 20kΩ
1	AIN2x_BYP_CFG	R/W	0b	IN2x Analog Bypass input config. 0d = FD / Pseudo Diff 1d = SE
0	DAC_CH2_BW_MODE	R/W	0b	DAC Channel 2 band-width selection. 0d = audio band-width (24 kHz mode) 1d = wide band-width (96 kHz mode)

**7.1.1.89 OUT2x\_CFG2 Register (Address = 0x6D) [Reset = 0x20]**

 OUT2x\_CFG2 is shown in [Table 7-91](#).

 Return to the [Summary Table](#).

This register is configuration register 2 for Channel OUT2x.

**Table 7-91. OUT2x\_CFG2 Register Field Descriptions**

Bit	Field	Type	Reset	Description
7-6	OUT2M_DRIVE[1:0]	R/W	00b	Channel OUT2M drive configuration. 0d = Line out driver with minimum 300Ω single ended impedance 1d = Headphone driver with minimum 16Ω single ended impedance 2d = To drive minimum of 4Ω single ended impedance 3d = For higher DR/SNR for FD receiver loads
5-3	OUT2M_LVL_CTRL[2:0]	R/W	100b	Channel OUT2M level control configuration. 0d = Reserved; Don't use 1d = Reserved; Don't use 2d = 12 dB (only valid in bypass only mode configured in OUT2x_SRC{B0_P0_R107}) 3d = 6 dB (only valid if ana bypass mode or ana-dig mix mode configured in OUT2x_SRC{B0_P0_R107}) 4d = 0 dB 5d = -6 dB (only valid if ana bypass mode or ana-dig mix mode configured in OUT2x_SRC{B0_P0_R107}) 6d = -12 dB (only valid if ana bypass mode or ana-dig mix mode configured in OUT2x_SRC{B0_P0_R107} and AIN1M_BY_P_IMP configured 4.4kΩ) 7d = Reserved; Don't use
2	AIN2P_BY_P_IMP	R/W	0b	AIN2P Analog Bypass input impedance. 0d = 4.4kΩ 1d = 20kΩ
1	RESERVED	R	0b	Reserved bit; Write only reset value
0	DAC_CH2_CM_TOL	R/W	0b	DAC Channel 2 input coupling (applicable for the analog input). 0d = AC-coupled input 1d = AC-coupled / DC-coupled input

**7.1.1.90 DAC\_CH2A\_CFG0 Register (Address = 0x6E) [Reset = 0xC9]**

 DAC\_CH2A\_CFG0 is shown in [Table 7-92](#).

 Return to the [Summary Table](#).

This register is configuration register 0 for DAC channel 2A.

**Table 7-92. DAC\_CH2A\_CFG0 Register Field Descriptions**

Bit	Field	Type	Reset	Description
7-0	DAC_CH2A_DVOL[7:0]	R/W	11001001b	Channel 2A digital volume control. 0d = Digital Volume is muted 1d = Digital Volume Control set to -100 dB 2d = Digital Volume Control set to -99.5 dB 3d to 200d = Digital Volume Control set to as per configuration 201d = Digital Volume Control set to 0 dB 202d = Digital Volume Control set to +0.5 dB 203d to 253d = Digital Volume Control set to as per configuration 254d = Digital Volume Control set to +26.5 dB 255d = Digital Volume Control set to +27 dB

**7.1.1.91 DAC\_CH2A\_CFG1 Register (Address = 0x6F) [Reset = 0x80]**

 DAC\_CH2A\_CFG1 is shown in [Table 7-93](#).

Return to the [Summary Table](#).

This register is configuration register 1 for DAC channel 2A.

**Table 7-93. DAC\_CH2A\_CFG1 Register Field Descriptions**

Bit	Field	Type	Reset	Description
7-4	DAC_CH2A_FGAIN[3:0]	R/W	1000b	DAC channel 2A fine gain calibration. 0d = Fine gain is set to -0.8 dB 1d = Fine gain is set to -0.7 dB 2d = Fine gain is set to -0.6 dB 3d to 7d = Fine gain is set as per configuration 8d = Fine gain is set to 0 dB 9d = Fine gain is set to 0.1 dB 10d to 13d = Fine gain is set as per configuration 14d = Fine gain is set to 0.6 dB 15d = Fine gain is set to 0.7 dB
3-0	RESERVED	R	0b	Reserved bits; Write only reset value

### 7.1.1.92 DAC\_CH2B\_CFG0 Register (Address = 0x70) [Reset = 0xC9]

DAC\_CH2B\_CFG0 is shown in [Table 7-94](#).

Return to the [Summary Table](#).

This register is configuration register 0 for DAC channel 2B.

**Table 7-94. DAC\_CH2B\_CFG0 Register Field Descriptions**

Bit	Field	Type	Reset	Description
7-0	DAC_CH2B_DVOL[7:0]	R/W	11001001b	Channel 2B digital volume control. 0d = Digital Volume is muted 1d = Digital Volume Control set to -100 dB 2d = Digital Volume Control set to -99.5 dB 3d to 200d = Digital Volume Control set to as per configuration 201d = Digital Volume Control set to 0 dB 202d = Digital Volume Control set to +0.5 dB 203d to 253d = Digital Volume Control set to as per configuration 254d = Digital Volume Control set to +26.5 dB 255d = Digital Volume Control set to +27 dB

### 7.1.1.93 DAC\_CH2B\_CFG1 Register (Address = 0x71) [Reset = 0x80]

DAC\_CH2B\_CFG1 is shown in [Table 7-95](#).

Return to the [Summary Table](#).

This register is configuration register 1 for DAC channel 2B.

**Table 7-95. DAC\_CH2B\_CFG1 Register Field Descriptions**

Bit	Field	Type	Reset	Description
7-4	DAC_CH2B_FGAIN[3:0]	R/W	1000b	DAC channel 2B fine gain calibration. 0d = Fine gain is set to -0.8 dB 1d = Fine gain is set to -0.7 dB 2d = Fine gain is set to -0.6 dB 3d to 7d = Fine gain is set as per configuration 8d = Fine gain is set to 0 dB 9d = Fine gain is set to 0.1 dB 10d to 13d = Fine gain is set as per configuration 14d = Fine gain is set to 0.6 dB 15d = Fine gain is set to 0.7 dB
3-0	RESERVED	R	0b	Reserved bits; Write only reset value

**7.1.1.94 DSP\_CFG0 Register (Address = 0x72) [Reset = 0x18]**

 DSP\_CFG0 is shown in [Table 7-96](#).

 Return to the [Summary Table](#).

This register is the digital signal processor (DSP) configuration register 0.

**Table 7-96. DSP\_CFG0 Register Field Descriptions**

Bit	Field	Type	Reset	Description
7-6	ADC_DSP_DECI_FILT[1:0] ]	R/W	00b	ADC channel decimation filter response. 0d = Linear phase 1d = Low latency 2d = Ultra-low latency 3d = Reserved; Don't use
5-4	ADC_DSP_HPF_SEL[1:0]	R/W	01b	ADC channel high-pass filter (HPF) selection. 0d = Programmable first-order IIR filter for a custom HPF with default coefficient values in P10_R120-127 and P11_R8-11 set as the all-pass filter 1d = HPF with a cutoff of $0.00002 \times f_S$ (1 Hz at $f_S = 48$ kHz) is selected 2d = HPF with a cutoff of $0.00025 \times f_S$ (12 Hz at $f_S = 48$ kHz) is selected 3d = HPF with a cutoff of $0.002 \times f_S$ (96 Hz at $f_S = 48$ kHz) is selected
3-2	ADC_DSP_BQ_CFG[1:0]	R/W	10b	Number of biquads per ADC channel configuration. 0d = No biquads per channel; biquads are all disabled 1d = 1 biquad per channel 2d = 2 biquads per channel 3d = 3 biquads per channel
1	ADC_DSP_DISABLE_SOFT_STEP	R/W	0b	ADC Soft-stepping disable during DVOL change, mute, and unmute. 0d = Soft-stepping enabled 1d = Soft-stepping disabled
0	ADC_DSP_DVOL_GANG	R/W	0b	DVOL control ganged across ADC channels. 0d = Each channel has its own DVOL CTRL settings as programmed in the ADC_CHx_DVOL bits 1d = All active channels must use the channel 1 DVOL setting (ADC_CH1_DVOL) irrespective of whether channel 1 is turned on or not

**7.1.1.95 DSP\_CFG1 Register (Address = 0x73) [Reset = 0x18]**

 DSP\_CFG1 is shown in [Table 7-97](#).

 Return to the [Summary Table](#).

This register is the digital signal processor (DSP) configuration register 0.

**Table 7-97. DSP\_CFG1 Register Field Descriptions**

Bit	Field	Type	Reset	Description
7-6	DAC_DSP_INTX_FILT[1:0] ]	R/W	00b	DAC channel decimation filter response. 0d = Linear phase 1d = Low latency 2d = Ultra-low latency 3d = Reserved; Don't use
5-4	DAC_DSP_HPF_SEL[1:0]	R/W	01b	DAC channel high-pass filter (HPF) selection. 0d = Programmable first-order IIR filter for a custom HPF with default coefficient values in P17_R120-127 and P18_R8-11 set as the all-pass filter 1d = HPF with a cutoff of $0.00002 \times f_S$ (1 Hz at $f_S = 48$ kHz) is selected 2d = HPF with a cutoff of $0.00025 \times f_S$ (12 Hz at $f_S = 48$ kHz) is selected 3d = HPF with a cutoff of $0.002 \times f_S$ (96 Hz at $f_S = 48$ kHz) is selected

**Table 7-97. DSP\_CFG1 Register Field Descriptions (continued)**

Bit	Field	Type	Reset	Description
3-2	DAC_DSP_BQ_CFG[1:0]	R/W	10b	Number of biquads per DAC channel configuration. 0d = No biquads per channel; biquads are all disabled 1d = 1 biquad per channel 2d = 2 biquads per channel 3d = 3 biquads per channel
1	DAC_DSP_DISABLE_SOFT_STEP	R/W	0b	DAC Soft-stepping disable during DVOL change, mute, and unmute. 0d = Soft-stepping enabled 1d = Soft-stepping disabled
0	DAC_DSP_DVOL_GANG	R/W	0b	DVOL control ganged across DAC channels. 0d = Each DAC channel has its own DVOL CTRL settings as programmed in the DAC_CHx_DVOL bits 1d = All active channels must use the channel 1 DVOL setting (DAC_CH1_DVOL) irrespective of whether channel 1 is turned on or not

#### 7.1.1.96 CH\_EN Register (Address = 0x76) [Reset = 0xCC]

CH\_EN is shown in [Table 7-98](#).

Return to the [Summary Table](#).

This register is the channel enable configuration register.

**Table 7-98. CH\_EN Register Field Descriptions**

Bit	Field	Type	Reset	Description
7	IN_CH1_EN	R/W	1b	Input channel 1 enable setting. 0d = Input channel 1 is disabled 1d = Input channel 1 is enabled
6	IN_CH2_EN	R/W	1b	Input channel 2 enable setting. 0d = Input channel 2 is disabled 1d = Input channel 2 is enabled
5	IN_CH3_EN	R/W	0b	Input channel 3 enable setting. 0d = Input channel 3 is disabled 1d = Input channel 3 is enabled
4	IN_CH4_EN	R/W	0b	Input channel 4 enable setting. 0d = Input channel 4 is disabled 1d = Input channel 4 is enabled
3	OUT_CH1_EN	R/W	1b	Output channel 1 enable setting. 0d = Output channel 1 is disabled 1d = Output channel 1 is enabled
2	OUT_CH2_EN	R/W	1b	Output channel 2 enable setting. 0d = Output channel 2 is disabled 1d = Output channel 2 is enabled
1	OUT_CH3_EN	R/W	0b	Output channel 3 enable setting. 0d = Output channel 3 is disabled 1d = Output channel 3 is enabled
0	OUT_CH4_EN	R/W	0b	Output channel 4 enable setting. 0d = Output channel 4 is disabled 1d = Output channel 4 is enabled

#### 7.1.1.97 DYN\_PUPD\_CFG Register (Address = 0x77) [Reset = 0x00]

DYN\_PUPD\_CFG is shown in [Table 7-99](#).

Return to the [Summary Table](#).

This register is the power-up configuration register.

**Table 7-99. DYN\_PUPD\_CFG Register Field Descriptions**

Bit	Field	Type	Reset	Description
7	ADC_DYN_PUPD_EN	R/W	0b	Dynamic channel power-up, power-down enable for record path. 0d = Channel power-up, power-down is not supported if any channel recording is on 1d = Channel can be powered up or down individually, even if channel recording is on
6	ADC_DYN_MAXCH_SEL	R/W	0b	Dynamic mode maximum channel select configuration for record path. 0d = Channel 1 and channel 2 are used with dynamic channel power-up, power-down feature enabled 1d = Channel 1 to channel 4 are used with dynamic channel power-up, power-down feature enabled
5	DAC_DYN_PUPD_EN	R/W	0b	Dynamic channel power-up, power-down enable for playback path. 0d = Channel power-up, power-down is not supported if any channel playback is on 1d = Channel can be powered up or down individually, even if channel playback is on
4	DAC_DYN_MAXCH_SEL	R/W	0b	Dynamic mode maximum channel select configuration for playback path. 0d = Channel 1 and channel 2 are used with dynamic channel power-up, power-down feature enabled 1d = Channel 1 to channel 4 are used with dynamic channel power-up, power-down feature enabled
3	DYN_PUPD_ADC_PDM_DIFF_CLK	R/W	0b	Dynamic power-up power-down with different adc mod clock and pdm clock configuration. 0d = Same ADC MOD CLK and PDM CLK in dynamic pupd 1d = Different ADC MOD CLK and PDM CLK in dynamic pupd
2	RESERVED	R	0b	Reserved bit; Write only reset value
1	ADC_CH_SWAP	R/W	0b	ADC channel swap enable configuration. 1d = No swap 1d = ADC channel 1 and 2 are swapped
0	DAC_CH_SWAP	R/W	0b	DAC channel swap enable configuration. 1d = No swap 1d = DAC channel 1 and 2 are swapped

**7.1.1.98 PWR\_CFG Register (Address = 0x78) [Reset = 0x00]**

PWR\_CFG is shown in [Table 7-100](#).

Return to the [Summary Table](#).

This register is the power-up configuration register.

**Table 7-100. PWR\_CFG Register Field Descriptions**

Bit	Field	Type	Reset	Description
7	ADC_PDZ	R/W	0b	Power control for ADC and PDM channels. 0d = Power down all ADC and PDM channels 1d = Power up all enabled ADC and PDM channels
6	DAC_PDZ	R/W	0b	Power control for DAC channels. 0d = Power down all DAC channels 1d = Power up all enabled DAC channels
5	MICBIAS_PDZ	R/W	0b	Power control for MICBIAS. 0d = Power down MICBIAS 1d = Power up MICBIAS
4	RESERVED	R	0b	Reserved bit; Write only reset value
3	UAD_EN	R/W	0b	Enable ultrasound activity detection (UAD) algorithm. 0d = UAD is disabled 1d = UAD is enabled

**Table 7-100. PWR\_CFG Register Field Descriptions (continued)**

Bit	Field	Type	Reset	Description
2	VAD_EN	R/W	0b	Enable voice activity detection (VAD) algorithm. 0d = VAD is disabled 1d = VAD is enabled
1	UAG_EN	R/W	0b	Enable ultrasound activity detection (UAG) algorithm. 0d = UAG is disabled 1d = UAG is enabled
0	RESERVED	R	0b	Reserved bit; Write only reset value

### 7.1.1.99 DEV\_STS0 Register (Address = 0x79) [Reset = 0x00]

DEV\_STS0 is shown in [Table 7-101](#).

Return to the [Summary Table](#).

This register is the device status value register 0.

**Table 7-101. DEV\_STS0 Register Field Descriptions**

Bit	Field	Type	Reset	Description
7	IN_CH1_STATUS	R	0b	ADC or PDM channel 1 power status. 0d = ADC or PDM channel is powered down 1d = ADC or PDM channel is powered up
6	IN_CH2_STATUS	R	0b	ADC or PDM channel 2 power status. 0d = ADC or PDM channel is powered down 1d = ADC or PDM channel is powered up
5	IN_CH3_STATUS	R	0b	ADC or PDM channel 1 power status. 0d = ADC or PDM channel is powered down 1d = ADC or PDM channel is powered up
4	IN_CH4_STATUS	R	0b	ADC or PDM channel 2 power status. 0d = ADC or PDM channel is powered down 1d = ADC or PDM channel is powered up
3	OUT_CH1_STATUS	R	0b	DAC channel 1 power status. 0d = DAC channel is powered down 1d = DAC channel is powered up
2	OUT_CH2_STATUS	R	0b	DAC channel 2 power status. 0d = DAC channel is powered down 1d = DAC channel is powered up
1	OUT_CH3_STATUS	R	0b	DAC channel 3 power status. 0d = DAC channel is powered down 1d = DAC channel is powered up
0	OUT_CH4_STATUS	R	0b	DAC channel 4 power status. 0d = DAC channel is powered down 1d = DAC channel is powered up

### 7.1.1.100 DEV\_STS1 Register (Address = 0x7A) [Reset = 0x80]

DEV\_STS1 is shown in [Table 7-102](#).

Return to the [Summary Table](#).

This register is the device status value register 1.

**Table 7-102. DEV\_STS1 Register Field Descriptions**

Bit	Field	Type	Reset	Description
7-5	MODE_STS[2:0]	R	100b	Device mode status. 0-3d = Reserved 4d = Device is in sleep mode or software shutdown mode 5d = Reserved 6d = Device is in active mode with all record and playback channels turned off 7d = Device is in active mode with at least one record or playback channel turned on
4	PLL_STS	R	0b	PLL status. 0d = PLL is not enabled 1d = PLL is enabled
3	MICBIAS_STS	R	0b	MICBIAS status. 0d = MICBIAS is disabled 1d = MICBIAS is enabled
2	RESERVED	R	0b	Reserved bit; Write only reset value
1	RESERVED	R	0b	Reserved bit; Write only reset value
0	RESERVED	R	0b	Reserved bit; Write only reset value

**7.1.1.101 I2C\_CKSUM Register (Address = 0x7E) [Reset = 0x00]**

I2C\_CKSUM is shown in [Table 7-103](#).

Return to the [Summary Table](#).

This register returns the I<sup>2</sup>C transactions checksum value.

**Table 7-103. I2C\_CKSUM Register Field Descriptions**

Bit	Field	Type	Reset	Description
7-0	I2C_CKSUM[7:0]	R/W	00000000b	These bits return the I <sup>2</sup> C transactions checksum value. Writing to this register resets the checksum to the written value. This register is updated on writes to other registers on all pages.



### 7.1.2 TAD5212\_B0\_P1 Registers

Table 7-104 lists the memory-mapped registers for the TAD5212\_B0\_P1 registers. All register offset addresses not listed in Table 7-104 should be considered as reserved locations and the register contents should not be modified.

**Table 7-104. TAD5212\_B0\_P1 Registers**

Address	Acronym	Register Name	Reset Value	Section
0x0	PAGE_CFG	Device page register	0x00	<a href="#">Section 7.1.2.1</a>
0x3	DSP_CFG0	DSP configuration register 0	0x00	<a href="#">Section 7.1.2.2</a>
0xD	CLK_CFG0	Clock configuration register 0	0x00	<a href="#">Section 7.1.2.3</a>
0xE	CHANNEL_CFG1	ADC channel configuration register	0x00	<a href="#">Section 7.1.2.4</a>
0xF	CHANNEL_CFG2	DAC channel configuration register	0x00	<a href="#">Section 7.1.2.5</a>
0x17	SRC_CFG0	SRC configuration register 1	0x00	<a href="#">Section 7.1.2.6</a>
0x18	SRC_CFG1	SRC configuration register 2	0x00	<a href="#">Section 7.1.2.7</a>
0x19	JACK_DET_CFG0	Jack Detection configuration register 0	0x00	<a href="#">Section 7.1.2.8</a>
0x1A	JACK_DET_CFG1	Jack Detection configuration register 1	0x00	<a href="#">Section 7.1.2.9</a>
0x1B	JACK_DET_CFG2	Jack Detection configuration register 2	0x00	<a href="#">Section 7.1.2.10</a>
0x1C	JACK_DET_CFG3	Jack Detection configuration register 3	0x00	<a href="#">Section 7.1.2.11</a>
0x1E	LPAD_CFG1	Low power activity detection configuration register	0x20	<a href="#">Section 7.1.2.12</a>
0x1F	LPSG_CFG1	Low power signal generation configuration register 1	0x80	<a href="#">Section 7.1.2.13</a>
0x20	LPAD_LPSG_CFG1	Low power activity detection and Low power signal generation common configuration register 1	0x00	<a href="#">Section 7.1.2.14</a>
0x23	LIMITER_CFG	Limiter configuration register	0x00	<a href="#">Section 7.1.2.15</a>
0x24	AGC_DRC_CFG	AGC and DRC configuration register	0x00	<a href="#">Section 7.1.2.16</a>
0x2B	PLIM_CFG0	PLIM configuration register 0	0x00	<a href="#">Section 7.1.2.17</a>
0x2C	MIXER_CFG0	MIXER configuration register 0	0x00	<a href="#">Section 7.1.2.18</a>
0x2D	MISC_CFG0	Miscellaneous configuration register 0	0x00	<a href="#">Section 7.1.2.19</a>
0x2E	BRWNOUT	Brownout configuration register	0xBF	<a href="#">Section 7.1.2.20</a>
0x2F	INT_MASK0	Interrupt mask register 0	0xFF	<a href="#">Section 7.1.2.21</a>
0x32	INT_MASK4	Interrupt mask register 4	0x00	<a href="#">Section 7.1.2.22</a>
0x33	INT_MASK5	Interrupt mask register 5	0x30	<a href="#">Section 7.1.2.23</a>
0x34	INT_LTCH0	Latched interrupt readback register 0	0x00	<a href="#">Section 7.1.2.24</a>
0x35	CHx_LTCH	Latched summary of diagnostics register	0x00	<a href="#">Section 7.1.2.25</a>
0x38	OUT_CH1_LTCH	Channel 1 output DC faults diagnostics latched status register	0x00	<a href="#">Section 7.1.2.26</a>
0x39	OUT_CH2_LTCH	Channel 2 output DC faults diagnostics latched status register	0x00	<a href="#">Section 7.1.2.27</a>
0x3A	INT_LTCH1	Latched interrupt readback register 1	0x00	<a href="#">Section 7.1.2.28</a>
0x3B	INT_LTCH2	Latched interrupt readback register 2	0x00	<a href="#">Section 7.1.2.29</a>
0x3C	INT_LIVE0	Live Interrupt readback register 0	0x00	<a href="#">Section 7.1.2.30</a>
0x3D	CHx_LIVE	Live summary of diagnostics registers	0x00	<a href="#">Section 7.1.2.31</a>
0x40	OUT_CH1_LIVE	Channel 1 output DC faults diagnostics live status register	0x00	<a href="#">Section 7.1.2.32</a>
0x41	OUT_CH2_LIVE	Channel 2 output DC faults diagnostics live status register	0x00	<a href="#">Section 7.1.2.33</a>
0x42	INT_LIVE1	Live interrupt readback register 1	0x00	<a href="#">Section 7.1.2.34</a>
0x43	INT_LIVE2	Live interrupt readback register 2	0x00	<a href="#">Section 7.1.2.35</a>
0x4E	DIAG_CFG8	Input diagnostics configuration register 8	0xBA	<a href="#">Section 7.1.2.36</a>
0x4F	DIAG_CFG9	Input diagnostics configuration register 9	0x4B	<a href="#">Section 7.1.2.37</a>
0x53	DIAG_CFG13	Input diagnostics configuration register 13	0x00	<a href="#">Section 7.1.2.38</a>
0x54	DIAG_CFG14	Input diagnostics configuration register 14	0x48	<a href="#">Section 7.1.2.39</a>

**Table 7-104. TAD5212\_B0\_P1 Registers (continued)**

Address	Acronym	Register Name	Reset Value	Section
0x55	DIAGDATA_CFG	Input diagnostics data configuration register	0x00	<a href="#">Section 7.1.2.40</a>
0x58	DIAG_MON_MSB_MBIAS	Diagnostics SAR MICBIAS monitor data MSB byte	0x00	<a href="#">Section 7.1.2.41</a>
0x59	DIAG_MON_LSB_MBIAS	Diagnostics SAR MICBIAS monitor data LSB nibble	0x01	<a href="#">Section 7.1.2.42</a>
0x62	DIAG_MON_MSB_OUT1P	Diagnostics SAR OUT1P monitor data MSB byte	0x00	<a href="#">Section 7.1.2.43</a>
0x63	DIAG_MON_LSB_OUT1P	Diagnostics SAR OUT1P monitor data LSB nibble	0x06	<a href="#">Section 7.1.2.44</a>
0x64	DIAG_MON_MSB_OUT1M	Diagnostics SAR OUT1M monitor data MSB byte	0x00	<a href="#">Section 7.1.2.45</a>
0x65	DIAG_MON_LSB_OUT1M	Diagnostics SAR OUT1M monitor data LSB nibble	0x07	<a href="#">Section 7.1.2.46</a>
0x66	DIAG_MON_MSB_OUT2P	Diagnostics SAR OUT2P monitor data MSB byte	0x00	<a href="#">Section 7.1.2.47</a>
0x67	DIAG_MON_LSB_OUT2P	Diagnostics SAR OUT2P monitor data LSB nibble	0x08	<a href="#">Section 7.1.2.48</a>
0x68	DIAG_MON_MSB_OUT2M	Diagnostics SAR OUT2M monitor data MSB byte	0x00	<a href="#">Section 7.1.2.49</a>
0x69	DIAG_MON_LSB_OUT2M	Diagnostics SAR OUT2M monitor data LSB nibble	0x09	<a href="#">Section 7.1.2.50</a>
0x6A	DIAG_MON_MSB_TEMP	Diagnostics SAR Temperature monitor data MSB byte	0x00	<a href="#">Section 7.1.2.51</a>
0x6B	DIAG_MON_LSB_TEMP	Diagnostics SAR Temperature monitor data LSB nibble	0x0A	<a href="#">Section 7.1.2.52</a>
0x6E	DIAG_MON_MSB_AVDD	Diagnostics SAR AVDD monitor data MSB byte	0x00	<a href="#">Section 7.1.2.53</a>
0x6F	DIAG_MON_LSB_AVDD	Diagnostics SAR AVDD monitor data LSB nibble	0x0C	<a href="#">Section 7.1.2.54</a>
0x70	DIAG_MON_MSB_GPA	Diagnostics SAR GPA monitor data MSB byte	0x00	<a href="#">Section 7.1.2.55</a>
0x71	DIAG_MON_LSB_GPA	Diagnostics SAR GPA monitor data LSB nibble register	0x0D	<a href="#">Section 7.1.2.56</a>

**7.1.2.1 PAGE\_CFG Register (Address = 0x0) [Reset = 0x00]**

PAGE\_CFG is shown in [Table 7-105](#).

Return to the [Summary Table](#).

The device memory map is divided into pages. This register sets the page.

**Table 7-105. PAGE\_CFG Register Field Descriptions**

Bit	Field	Type	Reset	Description
7-0	PAGE[7:0]	R/W	00000000b	These bits set the device page. 0d = Page 0 1d = Page 1 2d to 254d = Page 2 to page 254 respectively 255d = Page 255

**7.1.2.2 DSP\_CFG0 Register (Address = 0x3) [Reset = 0x00]**

DSP\_CFG0 is shown in [Table 7-106](#).

Return to the [Summary Table](#).

This register is the configuration register for on-the-fly filter updates.

**Table 7-106. DSP\_CFG0 Register Field Descriptions**

Bit	Field	Type	Reset	Description
7	RESERVED	R	0b	Reserved bit; Write only reset value
6	RESERVED	R	0b	Reserved bit; Write only reset value
5	RESERVED	R	0b	Reserved bit; Write only reset value
4	RESERVED	R	0b	Reserved bit; Write only reset value
3	RESERVED	R	0b	Reserved bit; Write only reset value
2	RESERVED	R	0b	Reserved bit; Write only reset value
1	RESERVED	R	0b	Reserved bit; Write only reset value

**Table 7-106. DSP\_CFG0 Register Field Descriptions (continued)**

Bit	Field	Type	Reset	Description
0	EN_BQ_OTF_CHG	R/W	0b	Enable run-time changes to Biquad settings. 0d = Disable on the fly biquad changes 1d = Enable on the fly biquad changes

### 7.1.2.3 CLK\_CFG0 Register (Address = 0xD) [Reset = 0x00]

CLK\_CFG0 is shown in [Table 7-107](#).

Return to the [Summary Table](#).

This register is the Clock configuration register 0.

**Table 7-107. CLK\_CFG0 Register Field Descriptions**

Bit	Field	Type	Reset	Description
7	CNT_TGT_CFG_OVR_PASI	R/W	0b	ASI controller target Config Override Register 0d = controller-target Config as per PASI_CNT_CFG bit. 1d = Override the standard behavior of the PASI_CNT_CFG. In this case the clock auto detect feature is not available. PASI_CNT_CFG = 0 : BCLK is input but FSYNC is output. PASI_CNT_CFG = 1 : BCLK is output but FSYNC in input.
6	CNT_TGT_CFG_OVR_SASI	R/W	0b	ASI controller target Config Override Register 0d = controller-target Config as per SASI_CNT_CFG bit. 1d = Override the standard behavior of the SASI_CNT_CFG. In this case the clock auto detect feature is not available. SASI_CNT_CFG = 0 : BCLK is input but FSYNC is output. SASI_CNT_CFG = 1 : BCLK is output but FSYNC in input.
5-3	RESERVED	R	0b	Reserved bits; Write only reset value
2	PASI_USE_INT_FSYNC	R/W	0b	For Primary use internal FSYNC in controller mode configuration. 0d = Use external FSYNC 1d = Use internal FSYNC
1	SASI_USE_INT_FSYNC	R/W	0b	For Secondary use internal FSYNC in controller mode configuration. 0d = Use external FSYNC 1d = Use internal FSYNC
0	RESERVED	R	0b	Reserved bit; Write only reset value

### 7.1.2.4 CHANNEL\_CFG1 Register (Address = 0xE) [Reset = 0x00]

CHANNEL\_CFG1 is shown in [Table 7-108](#).

Return to the [Summary Table](#).

This is the ADC channel dynamic power-on or off configuration register.

**Table 7-108. CHANNEL\_CFG1 Register Field Descriptions**

Bit	Field	Type	Reset	Description
7	FORCE_DYN_MODE_CUST_MAX_CH	R/W	0b	ADC Force dynamic mode custom max channel 0d = In Dynamic, Max channel is based on ADC_DYN_MAXCH_SEL 1d = In Dynamic mode, max channel is custom as DYN_MODE_CUST_MAX_CH
6-3	DYN_MODE_CUST_MAX_CH[3:0]	R/W	0000b	ADC Dynamic mode custom max channel configuration [3]->CH4_EN [2]->CH3_EN [1]->CH2_EN [0]->CH1_EN
2-0	RESERVED	R	0b	Reserved bits; Write only reset values

### 7.1.2.5 CHANNEL\_CFG2 Register (Address = 0xF) [Reset = 0x00]

CHANNEL\_CFG2 is shown in [Table 7-109](#).

Return to the [Summary Table](#).

This is the DAC channel dynamic power-on or off configuration register.

**Table 7-109. CHANNEL\_CFG2 Register Field Descriptions**

Bit	Field	Type	Reset	Description
7	DAC_FORCE_DYN_MODE_CUST_MAX_CH	R/W	0b	DAC Force dynamic mode custom max channel 0d = In Dynamic, Max channel is based on DAC_DYN_MAXCH_SEL 1d = In Dynamic mode, max channel is custom as per DAC_DYN_MODE_CUST_MAX_CH
6-3	DAC_DYN_MODE_CUST_MAX_CH[3:0]	R/W	0000b	DAC Dynamic mode custom max channel configuration ([3]->CH4_EN, [2]->CH3_EN, [1]->CH2_EN, [0]->CH1_EN) [3]->CH4_EN [2]->CH3_EN [1]->CH2_EN [0]->CH1_EN
2-0	RESERVED	R	0b	Reserved bits; Write only reset values

### 7.1.2.6 SRC\_CFG0 Register (Address = 0x17) [Reset = 0x00]

SRC\_CFG0 is shown in [Table 7-110](#).

Return to the [Summary Table](#).

This register is configuration register 1 for SRC.

**Table 7-110. SRC\_CFG0 Register Field Descriptions**

Bit	Field	Type	Reset	Description
7	SRC_EN	R/W	0b	SRC enable config 0b = SRC disable 1b = SRC enable
6	DIS_AUTO_SRC_DET	R/W	0b	SRC auto detect config 0b = SRC auto detect enabled 1b = SRC auto detect disabled
5-0	RESERVED	R	0b	Reserved bits; Write only reset value

### 7.1.2.7 SRC\_CFG1 Register (Address = 0x18) [Reset = 0x00]

SRC\_CFG1 is shown in [Table 7-111](#).

Return to the [Summary Table](#).

This register is configuration register 2 for SRC.

**Table 7-111. SRC\_CFG1 Register Field Descriptions**

Bit	Field	Type	Reset	Description
7	MAIN_FS_CUSTOM_CFG	R/W	0b	Main Fs custom config 0b = Main Fs is auto inferred 1b = Main Fs need to be selected from MAIN_FS_SELECT_CFG
6	MAIN_FS_SELECT_CFG	R/W	0b	Main Fs select config 0b = PASI Fs shall be used as Main Fs 1b = SASI Fs shall be used as Main Fs

**Table 7-111. SRC\_CFG1 Register Field Descriptions (continued)**

Bit	Field	Type	Reset	Description
5-3	MAIN_AUX_RATIO_M_C USTOM_CFG[2:0]	R/W	000b	Main and Aux Fs Ratio m:n config 0d = m is auto inferred 1d = 1 2d = 2 3d = 3 4d = 4 5d = Reserved 6d = 6 7d = Reserved
2-0	MAIN_AUX_RATIO_N_C USTOM_CFG[2:0]	R/W	000b	Main and Aux Fs Ratio m:n config 0d = n is auto inferred 1d = 1 2d = 2 3d = 3 4d = 4 5d = Reserved 6d = 6 7d = Reserved

### 7.1.2.8 JACK\_DET\_CFG0 Register (Address = 0x19) [Reset = 0x00]

JACK\_DET\_CFG0 is shown in [Table 7-112](#).

Return to the [Summary Table](#).

This register is the Jack Detection configuration register 0.

**Table 7-112. JACK\_DET\_CFG0 Register Field Descriptions**

Bit	Field	Type	Reset	Description
7-6	JACK_DET_MONITOR_F REQ[1:0]	R/W	00b	Headset Detection Pulse Frequency 0d = 0.5 Hz 1d = 1 Hz 2d = 7.5 Hz 3d = 15 Hz
5	JACK_DET_PULSE_WID TH	R/W	0b	Detector Pulse High Width 0d = 4ms (MICBIAS PIN Cap = 1 uF) 1d = 32ms (MICBIAS PIN Cap = 10 uF)
4	RESERVED	R	0b	Reserved bit; Write only reset value
3	RESERVED	R	0b	Reserved bit; Write only reset value
2-1	HPDET_CLOCK_SEL[1:0]	R/W	00b	Headphone Detection Clock Time period Select 0d = 1ms 1d = 2ms 2d = 4ms 3d = Reserved
0	RESERVED	R	0b	Reserved bit; Write only reset value

### 7.1.2.9 JACK\_DET\_CFG1 Register (Address = 0x1A) [Reset = 0x00]

JACK\_DET\_CFG1 is shown in [Table 7-113](#).

Return to the [Summary Table](#).

This register is the Jack Detection configuration register 1.

**Table 7-113. JACK\_DET\_CFG1 Register Field Descriptions**

Bit	Field	Type	Reset	Description
7	RESERVED	R	0b	Reserved bit; Write only reset value

**Table 7-113. JACK\_DET\_CFG1 Register Field Descriptions (continued)**

Bit	Field	Type	Reset	Description
6	JACK_DET_COMP_CTRL 2	R/W	0b	Hook Press Threshold Control in Fixed External Resistance case, controls the choice of Lowest Microphone impedance to be supported or Highest Hook button Impedance to be supported 0d = Minimum Microphone resistance supported, R_Mic = 800 $\Omega$ s and Max Hook button impedance supported, R_Hook = 320 $\Omega$ s for AC coupled Headphones R26<3> = 0 (else, when R26<3> = 1, R_hook = 150 $\Omega$ s) 1d = Max Hook button impedance supported, R_hook = 680 $\Omega$ s and Minimum Microphone resistance supported, R_Mic = 1350 $\Omega$ s for AC coupled Headphones R26<3> = 0 (else, when R26<3> = 1, R_Mic = 1750 $\Omega$ s)
5-4	JACK_DET_COMP_CTRL 3[1:0]	R/W	00b	Hook Pressed Jack Insertion support, valid only for External Resistor Type P0_R25_D4 = 0 else Don't care. 0d = supports minimum Hook button impedance of 150 $\Omega$ s for Hook Pressed Jack Insertion detection 1d = supports minimum Hook button impedance of 100 $\Omega$ s for Hook Pressed Jack Insertion detection 2d = supports minimum Hook button impedance of 50 $\Omega$ s for Hook Pressed Jack Insertion detection 3d = Reserved
3	HPDET_COUPLING	R/W	0b	Headphone detect coupling 0d = AC coupled 1d = DC coupled
2	HPDET_USE_2x_CURR	R/W	0b	Headset detect current sel config 0d = 2x current for headphone detection disabled 1d = 2x current for headphone detection enabled
1	JACK_DET_EN	R/W	0b	Headset Detection Enable 0d = Headset Detection Disabled 1d = Headset Detection Enabled
0	RESERVED	R	0b	Reserved bit; Write only reset value

**7.1.2.10 JACK\_DET\_CFG2 Register (Address = 0x1B) [Reset = 0x00]**

JACK\_DET\_CFG2 is shown in [Table 7-114](#).

Return to the [Summary Table](#).

This register is the Jack Detection configuration register 2.

**Table 7-114. JACK\_DET\_CFG2 Register Field Descriptions**

Bit	Field	Type	Reset	Description
7	RESERVED	R	0b	Reserved bit; Write only reset value
6	HPDET_DEB	R/W	0b	Headphone Detection Debounce Programmability 0d = No Debounce 1d = Debounce of 3 detections
5-3	JACK_DET_DEB_INSERT[2:0]	R/W	000b	Headset Insert Detection Debounce Programmability 0d = Debounce Time = 16ms 1d = Debounce Time = 32ms 2d = Debounce Time = 64ms 3d = Debounce Time = 128ms 4d = Debounce Time = 256ms 5d = Debounce Time = 512ms 6d = Reserved 7d = No Debounce
2	JACK_DET_DEB_REMOVAL	R/W	0b	Headset Removal Detection Debounce Programmability 0d = Debounce of 5 detections 1d = Debounce of 3 detections

**Table 7-114. JACK\_DET\_CFG2 Register Field Descriptions (continued)**

Bit	Field	Type	Reset	Description
1-0	JACK_DET_DEB_HOOK_PRESS[1:0]	R/W	00b	Hook Press Debounce config 0d = No Debounce 1d = No Debounce 2d = Debounce of 2 detections 3d = Debounce of 3 detections

#### 7.1.2.11 JACK\_DET\_CFG3 Register (Address = 0x1C) [Reset = 0x00]

JACK\_DET\_CFG3 is shown in [Table 7-115](#).

Return to the [Summary Table](#).

This register is the Jack Detection configuration register 3.

**Table 7-115. JACK\_DET\_CFG3 Register Field Descriptions**

Bit	Field	Type	Reset	Description
7-6	JACK_TYPE_FLAG[1:0]	R	00b	Headset Jack type flag 0d = Jack is not inserted 1d = Jack is inserted without Microphone 2d = Reserved. Do not use 3d = Jack is inserted with Microphone
5-4	HEADSET_TYPE_DET[1:0]	R	00b	Headset type 0d = Headset is not inserted 1d = Jack is inserted with mono-HS (RIGHT) 2d = Jack is inserted with mono-HS (LEFT) 3d = Jack is inserted with stereo-HS
3-0	RESERVED	R	0b	Reserved bits; Write only reset value

#### 7.1.2.12 LPAD\_CFG1 Register (Address = 0x1E) [Reset = 0x20]

LPAD\_CFG1 is shown in [Table 7-116](#).

Return to the [Summary Table](#).

This register is the voice activity detection or ultrasonic activity detection configuration register 1.

**Table 7-116. LPAD\_CFG1 Register Field Descriptions**

Bit	Field	Type	Reset	Description
7-6	LPAD_MODE[1:0]	R/W	00b	Auto ADC power up / power down configuration selection. 0d = User initiated ADC power-up and ADC power-down 1d = VAD/UAD interrupt based ADC power up and ADC power down 2d = VAD/UAD interrupt based ADC power up but user initiated ADC power down 3d = Reserved
5-4	LPAD_CH_SEL[1:0]	R/W	10b	VAD channel select. 0d = Channel 1 is monitored for VAD/UAD activity 1d = Channel 2 is monitored for VAD/UAD activity 2d = Channel 3 is monitored for VAD/UAD activity 3d = Channel 4 is monitored for VAD/UAD activity
3	LPAD_DOUT_INT_CFG	R/W	0b	DOUT interrupt configuration. 0d = DOUT pin is not enabled for interrupt function 1d = DOUT pin is enabled to support interrupt output when channel data in not being recorded
2	RESERVED	R	0b	Reserved bit; Write only reset value
1	LPAD_PD_DET_EN	R/W	0b	Enable ASI output data during VAD/UAD activity. 0d = VAD/UAD processing is not enabled during ADC recording 1d = VAD/UAD processing is enabled during ADC recording and VAD interrupts are generated as configured

**Table 7-116. LPAD\_CFG1 Register Field Descriptions (continued)**

Bit	Field	Type	Reset	Description
0	RESERVED	R	0b	Reserved bit; Write only reset value

**7.1.2.13 LPSG\_CFG1 Register (Address = 0x1F) [Reset = 0x80]**

LPSG\_CFG1 is shown in [Table 7-117](#).

Return to the [Summary Table](#).

This register is configuration register 1 for Ultrasonic signal generation.

**Table 7-117. LPSG\_CFG1 Register Field Descriptions**

Bit	Field	Type	Reset	Description
7-6	LPSG_CH_SEL[1:0]	R/W	10b	LPSG channel select.- UAG 0d = UAG activity is generated on channel 1 1d = UAG activity is generated on channel 2 2d = UAG activity is generated on channel 3 3d = UAG activity is generated on channel 4
5	RESERVED	R	0b	Reserved bit; Write only reset value
4-0	RESERVED	R	0b	Reserved bits; Write only reset values

**7.1.2.14 LPAD\_LPSG\_CFG1 Register (Address = 0x20) [Reset = 0x00]**

LPAD\_LPSG\_CFG1 is shown in [Table 7-118](#).

Return to the [Summary Table](#).

This register is configuration register 1 for VAD/UAD/UAG.

**Table 7-118. LPAD\_LPSG\_CFG1 Register Field Descriptions**

Bit	Field	Type	Reset	Description
7-6	LPAD_LPSG_CLK_CFG[1:0]	R/W	00b	Clock select for VAD/UAD/UAG 0d = VAD/UAD/UAG processing using internal oscillator clock 1d = VAD/UAD/UAG processing using external clock on BCLK input 2d = VAD/UAD/UAG processing using external clock on CCLK input 3d = Custom clock configuration based on CNT_CFG, CLK_SRC and CLKGEN_CFG registers in page 0
5-4	LPAD_LPSG_EXT_CLK_CFG[1:0]	R/W	00b	Clock configuration using external clock for VAD/UAD/UAG 0d = External clock is 24.576 MHz 1d = Reserved 2d = External clock is 12.288 MHz 3d = External clock is 18.432 MHz
3	RESERVED	R	0b	Reserved bit; Write only reset value
2	LPAD_PH1_EN	R/W	0b	Enable LPAD Phase 1 detection through Jack Detection comparator. 0d = LPAD phase 1 disabled 1d = LPAD phase 1 enabled
1-0	RESERVED	R	0b	Reserved bits; Write only reset values

**7.1.2.15 LIMITER\_CFG Register (Address = 0x23) [Reset = 0x00]**

LIMITER\_CFG is shown in [Table 7-119](#).

Return to the [Summary Table](#).

This register is configuration register for Limiter.



**Table 7-119. LIMITER\_CFG Register Field Descriptions**

Bit	Field	Type	Reset	Description
7-6	LIMITER_INP_SEL[1:0]	R/W	00b	Limiter input select config 0d = max(dacin_ch0, dacin_ch1) 1d = dacin_ch1 2d = dacin_ch0 3d = avg(dacin_ch0, dacin_ch1)
5-4	LIMITER_OUT_SEL[1:0]	R/W	00b	Limiter output select config 0d = applied on both 1d = dacin_ch1 2d = dacin_ch0 3d = applied none
3-0	RESERVED	R	0b	Reserved bits; Write only reset values

### 7.1.2.16 AGC\_DRC\_CFG Register (Address = 0x24) [Reset = 0x00]

AGC\_DRC\_CFG is shown in [Table 7-120](#).

Return to the [Summary Table](#).

This register is configuration register for AGC and DRC.

**Table 7-120. AGC\_DRC\_CFG Register Field Descriptions**

Bit	Field	Type	Reset	Description
7	AGC_CH1_EN	R/W	0b	AGC Channel 1 enable config 0d = disable 1d = enable
6	AGC_CH2_EN	R/W	0b	AGC Channel 2 enable config 0d = disable 1d = enable
5	AGC_CH3_EN	R/W	0b	AGC Channel 3 enable config 0d = disable 1d = enable
4	AGC_CH4_EN	R/W	0b	AGC Channel 4 enable config 0d = disable 1d = enable
3	DRC_CH1_EN	R/W	0b	DRC Channel 1 enable config 0d = disable 1d = enable
2	DRC_CH2_EN	R/W	0b	DRC Channel 2 enable config 0d = disable 1d = enable
1	DRC_CH3_EN	R/W	0b	DRC Channel 3 enable config 0d = disable 1d = enable
0	DRC_CH4_EN	R/W	0b	DRC Channel 4 enable config 0d = disable 1d = enable

### 7.1.2.17 PLIM\_CFG0 Register (Address = 0x2B) [Reset = 0x00]

PLIM\_CFG0 is shown in [Table 7-121](#).

Return to the [Summary Table](#).

This register is configuration register 0 for PLIM.

**Table 7-121. PLIM\_CFG0 Register Field Descriptions**

Bit	Field	Type	Reset	Description
7	EN_PLIM	R/W	0b	Enable PLIM 0d = Disable 1d = Enable
6-4	PLIM_ATTEN_VAL[2:0]	R/W	000b	PLIM attenuation factor 0d = 0dB 1d = -6dB 2d = -12dB 3d = -18dB 4d = -24dB 5d = -30dB 6d = -36dB 7d = -42dB
3	PLIM_BY_SAR_GPA	R/W	0b	PLIM attenuation value source 0d = Plimit attenuation based on GPIO and reg_plimi_attn_val 1d = Plimit attenuation based on GPA Analog voltage. LUT will map SAR ADC data to Attenuation factor
2	PLIM_RECOVERY	R/W	0b	PLIM attenuation recovery 0d = Plimit func doesn't recover. It stays at same attenuation level or can apply more attenuation if required 1d = Plimit func recovers (reduces the attenuation) if "gpio_val=0" or "sar_adc_gpa" data suggest that Battery Voltage has recovered then we can reduce the attenuation being applied
1-0	RESERVED	R	0b	Reserved bits; Write only reset value

**7.1.2.18 MIXER\_CFG0 Register (Address = 0x2C) [Reset = 0x00]**

MIXER\_CFG0 is shown in [Table 7-122](#).

Return to the [Summary Table](#).

This register is the MIXER configuration register 0.

**Table 7-122. MIXER\_CFG0 Register Field Descriptions**

Bit	Field	Type	Reset	Description
7	EN_DAC_ASI_MIXER	R/W	0b	Enable DAC ASI Mixer 0b = Disabled 1b = Enabled
6	EN_SIDE_CHAIN_MIXER	R/W	0b	Enable Side Chain Mixer 0b = Disabled 1b = Enabled
5	EN_ADC_CHANNEL_MIXER	R/W	0b	Enable ADC Channel Mixer 0b = Disabled 1b = Enabled
4	EN_LOOPBACK_MIXER	R/W	0b	Enable Loopback Mixer 0b = Disabled 1b = Enabled
3-0	RESERVED	R	0b	Reserved bits; Write only reset value

**7.1.2.19 MISC\_CFG0 Register (Address = 0x2D) [Reset = 0x00]**

MISC\_CFG0 is shown in [Table 7-123](#).

Return to the [Summary Table](#).

This register is the miscellaneous configuration register 0.

**Table 7-123. MISC\_CFG0 Register Field Descriptions**

Bit	Field	Type	Reset	Description
7	EN_DISTORTION	R/W	0b	Distortion Limiter enable config 0b = Distortion Limiter disable 1b = Distortion Limiter enable
6	EN_BOP	R/W	0b	BOP enable config 0b = BOP disable 1b = BOP enable
5	EN_THERMAL_FOLDBACK	R/W	0b	Thermal Foldback enable config 0b = Thermal Foldback disable 1b = Thermal Foldback enable
4	RESERVED	R	0b	Reserved bit; Write only reset value
3	DAC_SIGNAL_GENERATOR_1_ENABLE	R/W	0b	DAC signal generator 1 enable config 0b = Signal generator disabled 1b = Signal generator enabled
2	DAC_SIGNAL_GENERATOR_2_ENABLE	R/W	0b	DAC signal generator 2 enable config 0b = Signal generator disabled 1b = Signal generator enabled
1	DSP_AVDD_SEL	R/W	0b	SAR data source select for DSP Limiter, BOP, DRC 0b = Reserved 1b = SAR AVDD data to DSP
0	BRWNOUT_EN	R/W	0b	Brownout enable config 0b = Brownout disable 1b = Brownout enable

#### 7.1.2.20 BRWNOUT Register (Address = 0x2E) [Reset = 0xBF]

BRWNOUT is shown in [Table 7-124](#).

Return to the [Summary Table](#).

This register is the brownout configuration register.

**Table 7-124. BRWNOUT Register Field Descriptions**

Bit	Field	Type	Reset	Description
7-0	BRWNOUT_THRS[7:0]	R/W	10111111b	Threshold for brownout shutdown Default = 7.8V ((IF P1_R45_D1->DSP_AVDD_SEL=1) = 2.7V) Nd = ((0.9*(N*16)/4095)-0.211764)x17 (V) ((IF P1_R45_D1->DSP_AVDD_SEL=1) = ((0.9*(N*16)/4095)-0.225)x6 (V))

#### 7.1.2.21 INT\_MASK0 Register (Address = 0x2F) [Reset = 0xFF]

INT\_MASK0 is shown in [Table 7-125](#).

Return to the [Summary Table](#).

This register is the interrupt mask register 0.

**Table 7-125. INT\_MASK0 Register Field Descriptions**

Bit	Field	Type	Reset	Description
7	INT_MASK0	R/W	1b	Clock error interrupt mask. 0b = Don't Mask 1b = Mask
6	INT_MASK0	R/W	1b	PLL Lock interrupt mask. 0b = Don't Mask 1b = Mask
5	RESERVED	R	0b	Reserved bit; Write only reset value
4	RESERVED	R	0b	Reserved bit; Write only reset value

**Table 7-125. INT\_MASK0 Register Field Descriptions (continued)**

Bit	Field	Type	Reset	Description
3	RESERVED	R	0b	Reserved bit; Write only reset value
2	RESERVED	R	0b	Reserved bit; Write only reset value
1	RESERVED	R	0b	Reserved bit; Write only reset value
0	RESERVED	R	0b	Reserved bit; Write only reset value

**7.1.2.22 INT\_MASK4 Register (Address = 0x32) [Reset = 0x00]**

INT\_MASK4 is shown in [Table 7-126](#).

Return to the [Summary Table](#).

This register is the interrupt mask register 4.

**Table 7-126. INT\_MASK4 Register Field Descriptions**

Bit	Field	Type	Reset	Description
7	RESERVED	R	0b	Reserved bit; Write only reset value
6	RESERVED	R	0b	Reserved bit; Write only reset value
5	INT_MASK4	R/W	0b	OUT Short Circuit Fault Interrupt Mask. 0b = Don't Mask 1b = Mask
4	INT_MASK4	R/W	0b	DRVR Virtual Ground Fault Interrupt Mask. 0b = Don't Mask 1b = Mask
3	INT_MASK4	R/W	0b	Headset insert detection interrupt mask. 0b = Don't Mask 1b = Mask
2	INT_MASK4	R/W	0b	Headset remove detection interrupt mask. 0b = Don't Mask 1b = Mask
1	INT_MASK4	R/W	0b	Headset detection hook(button) interrupt mask. 0b = Don't Mask 1b = Mask
0	RESERVED	R	0b	Reserved bit; Write only reset value

**7.1.2.23 INT\_MASK5 Register (Address = 0x33) [Reset = 0x30]**

INT\_MASK5 is shown in [Table 7-127](#).

Return to the [Summary Table](#).

This register is the interrupt mask register 5.

**Table 7-127. INT\_MASK5 Register Field Descriptions**

Bit	Field	Type	Reset	Description
7	INT_MASK5	R/W	0b	GPA up threshold fault mask. 0b = Don't Mask 1b = Mask
6	INT_MASK5	R/W	0b	GPA low threshold fault mask. 0b = Don't Mask 1b = Mask
5	INT_MASK5	R/W	1b	VAD power up detect interrupt mask. 0b = Don't Mask 1b = Mask

**Table 7-127. INT\_MASK5 Register Field Descriptions (continued)**

Bit	Field	Type	Reset	Description
4	INT_MASK5	R/W	1b	VAD power down detect interrupt mask. 0b = Don't Mask 1b = Mask
3	RESERVED	R	0b	Reserved bit; Write only reset value
2	RESERVED	R	0b	Reserved bit; Write only reset value
1	RESERVED	R	0b	Reserved bit; Write only reset value
0	RESERVED	R	0b	Reserved bit; Write only reset value

#### 7.1.2.24 INT\_LTCH0 Register (Address = 0x34) [Reset = 0x00]

INT\_LTCH0 is shown in [Table 7-128](#).

Return to the [Summary Table](#).

This register is the latched interrupt readback register 0.

**Table 7-128. INT\_LTCH0 Register Field Descriptions**

Bit	Field	Type	Reset	Description
7	INT_LTCH0	R	0b	Interrupt due to clock error (self clearing bit). 0b = No interrupt 1b = Interrupt
6	INT_LTCH0	R	0b	Interrupt due to PLL Lock (self clearing bit) 0b = No interrupt 1b = Interrupt
5	RESERVED	R	0b	Reserved bit; Write only reset value
4	RESERVED	R	0b	Reserved bit; Write only reset value
3	RESERVED	R	0b	Reserved bit; Write only reset value
2	RESERVED	R	0b	Reserved bit; Write only reset value
1	RESERVED	R	0b	Reserved bit; Write only reset value
0	RESERVED	R	0b	Reserved bit; Write only reset value

#### 7.1.2.25 CHx\_LTCH Register (Address = 0x35) [Reset = 0x00]

CHx\_LTCH is shown in [Table 7-129](#).

Return to the [Summary Table](#).

This register is the channel level diagnostics latched status register.

**Table 7-129. CHx\_LTCH Register Field Descriptions**

Bit	Field	Type	Reset	Description
7	RESERVED	R	0b	Reserved bit; Write only reset value
6	RESERVED	R	0b	Reserved bit; Write only reset value
5	STS_CHx_LTCH	R	0b	Status of Output CH1_LTCH (INP1/INM1). 0b = No faults occurred in output channel 1 1b = Fault or Faults have occurred in output channel 1
4	STS_CHx_LTCH	R	0b	Status of Output CH2_LTCH (INP2/INM2). 0b = No faults occurred in output channel 2 1b = Fault or Faults have occurred in output channel 2
3	RESERVED	R	0b	Reserved bit; Write only reset value
2	RESERVED	R	0b	Reserved bit; Write only reset value
1	RESERVED	R	0b	Reserved bit; Write only reset value

**Table 7-129. CHx\_LTCH Register Field Descriptions (continued)**

Bit	Field	Type	Reset	Description
0	RESERVED	R	0b	Reserved bit; Write only reset value

**7.1.2.26 OUT\_CH1\_LTCH Register (Address = 0x38) [Reset = 0x00]**

OUT\_CH1\_LTCH is shown in [Table 7-130](#).

Return to the [Summary Table](#).

This register is the latched status register for channel 1 output DC faults diagnostics.

**Table 7-130. OUT\_CH1\_LTCH Register Field Descriptions**

Bit	Field	Type	Reset	Description
7	OUT_CH1_LTCH	R	0b	OUT1P Short Circuit Fault (self clearing bit). 0b = No short circuit fault 1b = Short circuit fault
6	OUT_CH1_LTCH	R	0b	OUT1M Short Circuit Fault (self clearing bit). 0b = No short circuit fault 1b = Short circuit fault
5	OUT_CH1_LTCH	R	0b	Channel 1 DRVRP Virtual Ground Fault (self clearing bit). 0b = No virtual ground fault 1b = Virtual ground fault
4	OUT_CH1_LTCH	R	0b	Channel 1 DRVRM Virtual Ground Fault (self clearing bit). 0b = No virtual ground fault 1b = Virtual ground fault
3	RESERVED	R	0b	Reserved bit; Write only reset value
2	RESERVED	R	0b	Reserved bit; Write only reset value
1-0	RESERVED	R	0b	Reserved bits; Write only reset value

**7.1.2.27 OUT\_CH2\_LTCH Register (Address = 0x39) [Reset = 0x00]**

OUT\_CH2\_LTCH is shown in [Table 7-131](#).

Return to the [Summary Table](#).

This register is the latched status register for channel 2 output DC faults diagnostics.

**Table 7-131. OUT\_CH2\_LTCH Register Field Descriptions**

Bit	Field	Type	Reset	Description
7	OUT_CH2_LTCH	R	0b	OUT2P Short Circuit Fault (self clearing bit). 0b = No short circuit fault 1b = Short circuit fault
6	OUT_CH2_LTCH	R	0b	OUT2M Short Circuit Fault (self clearing bit). 0b = No short circuit fault 1b = Short circuit fault
5	OUT_CH2_LTCH	R	0b	Channel 2 DRVRP Virtual Ground Fault (self clearing bit). 0b = No virtual ground fault 1b = Virtual ground fault
4	OUT_CH2_LTCH	R	0b	Channel 2 DRVRM Virtual Ground Fault (self clearing bit). 0b = No virtual ground fault 1b = Virtual ground fault
3-2	RESERVED	R	0b	Reserved bits; Write only reset value
1	MASK_AREG_SC_FLAG	R/W	0b	AREG SC fault mask. 0b = Don't Mask 1b = Mask

**Table 7-131. OUT\_CH2\_LTCH Register Field Descriptions (continued)**

Bit	Field	Type	Reset	Description
0	AREG_SC_FLAG_LTCH	R	0b	AREG SC fault (self clearing bit). 0b = No AREG short circuit fault 1b = AREG short circuit fault

#### 7.1.2.28 INT\_LTCH1 Register (Address = 0x3A) [Reset = 0x00]

INT\_LTCH1 is shown in [Table 7-132](#).

Return to the [Summary Table](#).

This is the register 1 for latched interrupt readback.

**Table 7-132. INT\_LTCH1 Register Field Descriptions**

Bit	Field	Type	Reset	Description
7	RESERVED	R	0b	Reserved bit; Write only reset value
6	RESERVED	R	0b	Reserved bit; Write only reset value
5	RESERVED	R	0b	Reserved bit; Write only reset value
4	RESERVED	R	0b	Reserved bit; Write only reset value
3	INT_LTCH1	R	0b	Interrupt due to Headset Insert Detection (self clearing bit). 0b = No interrupt 1b = Interrupt
2	INT_LTCH1	R	0b	Interrupt due to Headset Remove Detection (self clearing bit). 0b = No interrupt 1b = Interrupt
1	INT_LTCH1	R	0b	Interrupt due to Headset hook(button) (self clearing bit). 0b = No interrupt 1b = Interrupt
0	RESERVED	R	0b	Reserved bit; Write only reset value

#### 7.1.2.29 INT\_LTCH2 Register (Address = 0x3B) [Reset = 0x00]

INT\_LTCH2 is shown in [Table 7-133](#).

Return to the [Summary Table](#).

This is the register 2 for latched interrupt readback.

**Table 7-133. INT\_LTCH2 Register Field Descriptions**

Bit	Field	Type	Reset	Description
7	INT_LTCH2	R	0b	Interrupt due to GPA up threshold fault (self clearing bit). 0b = No interrupt 1b = Interrupt
6	INT_LTCH2	R	0b	Interrupt due to GPA low threshold fault (self clearing bit). 0b = No interrupt 1b = Interrupt
5	INT_LTCH2	R	0b	Interrupt due to VAD power up detect (self clearing bit). 0b = No interrupt 1b = Interrupt
4	INT_LTCH2	R	0b	Interrupt due to VAD power down detect (self clearing bit). 0b = No interrupt 1b = Interrupt
3	RESERVED	R	0b	Reserved bit; Write only reset value
2	RESERVED	R	0b	Reserved bit; Write only reset value
1	RESERVED	R	0b	Reserved bit; Write only reset value

**Table 7-133. INT\_LTCH2 Register Field Descriptions (continued)**

Bit	Field	Type	Reset	Description
0	RESERVED	R	0b	Reserved bit; Write only reset value

**7.1.2.30 INT\_LIVE0 Register (Address = 0x3C) [Reset = 0x00]**

INT\_LIVE0 is shown in [Table 7-134](#).

Return to the [Summary Table](#).

This is the register 0 for live interrupt readback.

**Table 7-134. INT\_LIVE0 Register Field Descriptions**

Bit	Field	Type	Reset	Description
7	INT_LIVE0	R	0b	Interrupt due to clock error . 0b = No interrupt 1b = Interrupt
6	INT_LIVE0	R	0b	Interrupt due to PLL Lock 0b = No interrupt 1b = Interrupt
5	RESERVED	R	0b	Reserved bit; Write only reset value
4	RESERVED	R	0b	Reserved bit; Write only reset value
3	RESERVED	R	0b	Reserved bit; Write only reset value
2	RESERVED	R	0b	Reserved bit; Write only reset value
1	RESERVED	R	0b	Reserved bit; Write only reset value
0	RESERVED	R	0b	Reserved bit; Write only reset value

**7.1.2.31 CHx\_LIVE Register (Address = 0x3D) [Reset = 0x00]**

CHx\_LIVE is shown in [Table 7-135](#).

Return to the [Summary Table](#).

This register is the channel level diagnostics live status register.

**Table 7-135. CHx\_LIVE Register Field Descriptions**

Bit	Field	Type	Reset	Description
7	RESERVED	R	0b	Reserved bit; Write only reset value
6	RESERVED	R	0b	Reserved bit; Write only reset value
5	STS_CHx_LIVE	R	0b	Status of Output CH1_LIVE (INP1/INM1). 0b = No faults occurred in output channel 1 1b = Fault or Faults have occurred in output channel 1
4	STS_CHx_LIVE	R	0b	Status of Output CH2_LIVE (INP2/INM2). 0b = No faults occurred in output channel 2 1b = Fault or Faults have occurred in output channel 2
3	RESERVED	R	0b	Reserved bit; Write only reset value
2	RESERVED	R	0b	Reserved bit; Write only reset value
1	RESERVED	R	0b	Reserved bit; Write only reset value
0	RESERVED	R	0b	Reserved bit; Write only reset value

**7.1.2.32 OUT\_CH1\_LIVE Register (Address = 0x40) [Reset = 0x00]**

OUT\_CH1\_LIVE is shown in [Table 7-136](#).

Return to the [Summary Table](#).



This register is the live status register for channel 1 output DC faults diagnostics.

**Table 7-136. OUT\_CH1\_LIVE Register Field Descriptions**

Bit	Field	Type	Reset	Description
7	OUT_CH1_LIVE	R	0b	OUT1P Short Circuit Fault . 0b = No short circuit fault 1b = Short circuit fault
6	OUT_CH1_LIVE	R	0b	OUT1M Short Circuit Fault . 0b = No short circuit fault 1b = Short circuit fault
5	OUT_CH1_LIVE	R	0b	Channel 1 DRVRP Virtual Ground Fault . 0b = No virtual ground fault 1b = Virtual ground fault
4	OUT_CH1_LIVE	R	0b	Channel 1 DRVRM Virtual Ground Fault . 0b = No virtual ground fault 1b = Virtual ground fault
3-0	RESERVED	R	0b	Reserved bits; Write only reset value

### 7.1.2.33 OUT\_CH2\_LIVE Register (Address = 0x41) [Reset = 0x00]

OUT\_CH2\_LIVE is shown in [Table 7-137](#).

Return to the [Summary Table](#).

This register is the live status register for channel 2 output DC faults diagnostics.

**Table 7-137. OUT\_CH2\_LIVE Register Field Descriptions**

Bit	Field	Type	Reset	Description
7	OUT_CH2_LIVE	R	0b	OUT2P Short Circuit Fault . 0b = No short circuit fault 1b = Short circuit fault
6	OUT_CH2_LIVE	R	0b	OUT2M Short Circuit Fault . 0b = No short circuit fault 1b = Short circuit fault
5	OUT_CH2_LIVE	R	0b	Channel 2 DRVRP Virtual Ground Fault . 0b = No virtual ground fault 1b = Virtual ground fault
4	OUT_CH2_LIVE	R	0b	Channel 2 DRVRM Virtual Ground Fault . 0b = No virtual ground fault 1b = Virtual ground fault
3-1	RESERVED	R	0b	Reserved bits; Write only reset value
0	AREG_SC_FLAG_LIVE	R	0b	AREG SC fault . 0b = No AREG short circuit fault 1b = AREG short circuit fault

### 7.1.2.34 INT\_LIVE1 Register (Address = 0x42) [Reset = 0x00]

INT\_LIVE1 is shown in [Table 7-138](#).

Return to the [Summary Table](#).

This is the register 1 for live interrupt readback.

**Table 7-138. INT\_LIVE1 Register Field Descriptions**

Bit	Field	Type	Reset	Description
7	RESERVED	R	0b	Reserved bit; Write only reset value
6	RESERVED	R	0b	Reserved bit; Write only reset value
5	RESERVED	R	0b	Reserved bit; Write only reset value

**Table 7-138. INT\_LIVE1 Register Field Descriptions (continued)**

Bit	Field	Type	Reset	Description
4	RESERVED	R	0b	Reserved bit; Write only reset value
3	INT_LIVE1	R	0b	Interrupt due to Headset Insert Detection . 0b = No interrupt 1b = Interrupt
2	INT_LIVE1	R	0b	Interrupt due to Headset Remove Detection . 0b = No interrupt 1b = Interrupt
1	INT_LIVE1	R	0b	Interrupt due to Headset hook(button) . 0b = No interrupt 1b = Interrupt
0	RESERVED	R	0b	Reserved bit; Write only reset value

**7.1.2.35 INT\_LIVE2 Register (Address = 0x43) [Reset = 0x00]**

INT\_LIVE2 is shown in [Table 7-139](#).

Return to the [Summary Table](#).

This is the register 2 for live interrupt readback.

**Table 7-139. INT\_LIVE2 Register Field Descriptions**

Bit	Field	Type	Reset	Description
7	INT_LIVE2	R	0b	Interrupt due to GPA up threshold fault . 0b = No interrupt 1b = Interrupt
6	INT_LIVE2	R	0b	Interrupt due to GPA low threshold fault 0b = No interrupt 1b = Interrupt
5	INT_LIVE2	R	0b	Interrupt due to VAD power up detect . 0b = No interrupt 1b = Interrupt
4	INT_LIVE2	R	0b	Interrupt due to VAD power down detect . 0b = No interrupt 1b = Interrupt
3	RESERVED	R	0b	Reserved bit; Write only reset value
2	RESERVED	R	0b	Reserved bit; Write only reset value
1	RESERVED	R	0b	Reserved bit; Write only reset value
0	RESERVED	R	0b	Reserved bit; Write only reset value

**7.1.2.36 DIAG\_CFG8 Register (Address = 0x4E) [Reset = 0xBA]**

DIAG\_CFG8 is shown in [Table 7-140](#).

Return to the [Summary Table](#).

This is the input diagnostics configuration register 8.

**Table 7-140. DIAG\_CFG8 Register Field Descriptions**

Bit	Field	Type	Reset	Description
7-0	GPA_UP_THRS_FLT_TH RES[7:0]	R/W	10111010b	General Purpose Analog High Threshold Default = ~ 2.6V $nd = ((0.9 \cdot (N \cdot 16) / 4095) - 0.225) \times 6 \text{ (V)}$

### 7.1.2.37 DIAG\_CFG9 Register (Address = 0x4F) [Reset = 0x4B]

DIAG\_CFG9 is shown in [Table 7-141](#).

Return to the [Summary Table](#).

This is the input diagnostics configuration register 9.

**Table 7-141. DIAG\_CFG9 Register Field Descriptions**

Bit	Field	Type	Reset	Description
7-0	GPA_LOW_THRS_FLT_T HRES[7:0]	R/W	01001011b	General Purpose Analog Low Threshold Default = ~ 0.2V $nd = ((0.9 \cdot (N \cdot 16) / 4095) - 0.225) \times 6$ (V)

### 7.1.2.38 DIAG\_CFG13 Register (Address = 0x53) [Reset = 0x00]

DIAG\_CFG13 is shown in [Table 7-142](#).

Return to the [Summary Table](#).

This is the input diagnostics configuration register 13.

**Table 7-142. DIAG\_CFG13 Register Field Descriptions**

Bit	Field	Type	Reset	Description
7	RESERVED	R	0b	Reserved bit; Write only reset value
6	RESERVED	R	0b	Reserved bit; Write only reset value
5	RESERVED	R	0b	Reserved bit; Write only reset value
4	RESERVED	R	0b	Reserved bit; Write only reset value
3	RESERVED	R	0b	Reserved bit; Write only reset value
2	DIAG_EN_AVDD	R/W	0b	AVDD channel enable for Diagnostics 0b = Diagnostic Disabled 1b = Diagnostic Enabled
1	DIAG_EN_GPA	R/W	0b	GPA channel enable for Diagnostics 0b = Diagnostic Disabled 1b = Diagnostic Enabled
0	RESERVED	R	0b	Reserved bit; Write only reset value

### 7.1.2.39 DIAG\_CFG14 Register (Address = 0x54) [Reset = 0x48]

DIAG\_CFG14 is shown in [Table 7-143](#).

Return to the [Summary Table](#).

This is the input diagnostics configuration register 14.

**Table 7-143. DIAG\_CFG14 Register Field Descriptions**

Bit	Field	Type	Reset	Description
7	RESERVED	R	0b	Reserved bit; Write only reset value
6-5	AVDD_FILT_SEL[1:0]	R/W	10b	AVDD filter select 0d = 3.5MHz 1d = 200kHz 2d = 100kHz 3d = No filter
4	RESERVED	R	0b	Reserved bit; Write only reset value
3-2	RESERVED	R	0b	Reserved bits; Write only reset values
1	RESERVED	R	0b	Reserved bit; Write only reset value
0	RESERVED	R	0b	Reserved bit; Write only reset value

#### 7.1.2.40 DIAGDATA\_CFG Register (Address = 0x55) [Reset = 0x00]

DIAGDATA\_CFG is shown in [Table 7-144](#).

Return to the [Summary Table](#).

This register is the input diagnostics data configuration register.

**Table 7-144. DIAGDATA\_CFG Register Field Descriptions**

Bit	Field	Type	Reset	Description
7-4	RESERVED	R	0b	Reserved bits; Write only reset values
3	RESERVED	R	0b	Reserved bit; Write only reset value
2	RESERVED	R	0b	Reserved bit; Write only reset value
1	OVRD_TEMP_DATA	R/W	0b	Override TEMP data 0b= Override Disabled 1b= Override Enabled
0	HOLD_SAR_DATA	R/W	0b	Hold SAR data update during register readback 0b= Data update is not held, Data register is continuously updated 1b= Data update is held, Data register readback can be done

#### 7.1.2.41 DIAG\_MON\_MSB\_MBIAS Register (Address = 0x58) [Reset = 0x00]

DIAG\_MON\_MSB\_MBIAS is shown in [Table 7-145](#).

Return to the [Summary Table](#).

This register is the diagnostics SAR MICBIAS monitor data MSB byte register.

**Table 7-145. DIAG\_MON\_MSB\_MBIAS Register Field Descriptions**

Bit	Field	Type	Reset	Description
7-0	DIAG_MON_MSB_MBIAS[7:0]	R	00000000b	Diagnostic SAR Monitor Data MSB Byte

#### 7.1.2.42 DIAG\_MON\_LSB\_MBIAS Register (Address = 0x59) [Reset = 0x01]

DIAG\_MON\_LSB\_MBIAS is shown in [Table 7-146](#).

Return to the [Summary Table](#).

This register is the diagnostics SAR MICBIAS monitor data LSB nibble.

**Table 7-146. DIAG\_MON\_LSB\_MBIAS Register Field Descriptions**

Bit	Field	Type	Reset	Description
7-4	DIAG_MON_LSB_MBIAS[3:0]	R	0000b	Diagnostic SAR Monitor Data LSB Nibble
3-0	Channel[3:0]	R	0001b	Channel ID

#### 7.1.2.43 DIAG\_MON\_MSB\_OUT1P Register (Address = 0x62) [Reset = 0x00]

DIAG\_MON\_MSB\_OUT1P is shown in [Table 7-147](#).

Return to the [Summary Table](#).

This register is the diagnostics SAR OUT1P monitor data MSB byte register.

**Table 7-147. DIAG\_MON\_MSB\_OUT1P Register Field Descriptions**

Bit	Field	Type	Reset	Description
7-0	DIAG_MON_MSB_OUT_CH1P[7:0]	R	00000000b	Diagnostic SAR Monitor Data MSB Byte

#### 7.1.2.44 DIAG\_MON\_LSB\_OUT1P Register (Address = 0x63) [Reset = 0x06]

DIAG\_MON\_LSB\_OUT1P is shown in [Table 7-148](#).

Return to the [Summary Table](#).

This register is the diagnostics SAR OUT1P monitor data LSB nibble register.

**Table 7-148. DIAG\_MON\_LSB\_OUT1P Register Field Descriptions**

Bit	Field	Type	Reset	Description
7-4	DIAG_MON_LSB_OUT_C H1P[3:0]	R	0000b	Diagnostic SAR Monitor Data LSB Nibble
3-0	Channel[3:0]	R	0110b	Channel ID

#### 7.1.2.45 DIAG\_MON\_MSB\_OUT1M Register (Address = 0x64) [Reset = 0x00]

DIAG\_MON\_MSB\_OUT1M is shown in [Table 7-149](#).

Return to the [Summary Table](#).

This register is the diagnostics SAR OUT1M monitor data MSB byte register.

**Table 7-149. DIAG\_MON\_MSB\_OUT1M Register Field Descriptions**

Bit	Field	Type	Reset	Description
7-0	DIAG_MON_MSB_OUT_CH1N[7:0]	R	00000000b	Diagnostic SAR Monitor Data MSB Byte

#### 7.1.2.46 DIAG\_MON\_LSB\_OUT1M Register (Address = 0x65) [Reset = 0x07]

DIAG\_MON\_LSB\_OUT1M is shown in [Table 7-150](#).

Return to the [Summary Table](#).

This register is the diagnostics SAR OUT1M monitor data LSB nibble register.

**Table 7-150. DIAG\_MON\_LSB\_OUT1M Register Field Descriptions**

Bit	Field	Type	Reset	Description
7-4	DIAG_MON_LSB_OUT_C H1N[3:0]	R	0000b	Diagnostic SAR Monitor Data LSB Nibble
3-0	Channel[3:0]	R	0111b	Channel ID

#### 7.1.2.47 DIAG\_MON\_MSB\_OUT2P Register (Address = 0x66) [Reset = 0x00]

DIAG\_MON\_MSB\_OUT2P is shown in [Table 7-151](#).

Return to the [Summary Table](#).

This register is the diagnostics SAR OUT2P monitor data MSB byte register.

**Table 7-151. DIAG\_MON\_MSB\_OUT2P Register Field Descriptions**

Bit	Field	Type	Reset	Description
7-0	DIAG_MON_MSB_OUT_CH2P[7:0]	R	00000000b	Diagnostic SAR Monitor Data MSB Byte

**7.1.2.48 DIAG\_MON\_LSB\_OUT2P Register (Address = 0x67) [Reset = 0x08]**

DIAG\_MON\_LSB\_OUT2P is shown in [Table 7-152](#).

Return to the [Summary Table](#).

This register is the diagnostics SAR OUT2P monitor data LSB nibble register.

**Table 7-152. DIAG\_MON\_LSB\_OUT2P Register Field Descriptions**

Bit	Field	Type	Reset	Description
7-4	DIAG_MON_LSB_OUT_C H2P[3:0]	R	0000b	Diagnostic SAR Monitor Data LSB Nibble
3-0	Channel[3:0]	R	1000b	Channel ID

**7.1.2.49 DIAG\_MON\_MSB\_OUT2M Register (Address = 0x68) [Reset = 0x00]**

DIAG\_MON\_MSB\_OUT2M is shown in [Table 7-153](#).

Return to the [Summary Table](#).

This register is the diagnostics SAR OUT2M monitor data MSB byte register.

**Table 7-153. DIAG\_MON\_MSB\_OUT2M Register Field Descriptions**

Bit	Field	Type	Reset	Description
7-0	DIAG_MON_MSB_OUT_CH2N[7:0]	R	00000000b	Diagnostic SAR Monitor Data MSB Byte

**7.1.2.50 DIAG\_MON\_LSB\_OUT2M Register (Address = 0x69) [Reset = 0x09]**

DIAG\_MON\_LSB\_OUT2M is shown in [Table 7-154](#).

Return to the [Summary Table](#).

This register is the diagnostics SAR OUT2M monitor data LSB nibble register.

**Table 7-154. DIAG\_MON\_LSB\_OUT2M Register Field Descriptions**

Bit	Field	Type	Reset	Description
7-4	DIAG_MON_LSB_OUT_C H2N[3:0]	R	0000b	Diagnostic SAR Monitor Data LSB Nibble
3-0	Channel[3:0]	R	1001b	Channel ID

**7.1.2.51 DIAG\_MON\_MSB\_TEMP Register (Address = 0x6A) [Reset = 0x00]**

DIAG\_MON\_MSB\_TEMP is shown in [Table 7-155](#).

Return to the [Summary Table](#).

This register is the diagnostics SAR Temperature monitor data MSB byte register.

**Table 7-155. DIAG\_MON\_MSB\_TEMP Register Field Descriptions**

Bit	Field	Type	Reset	Description
7-0	DIAG_MON_MSB_TEMP[7:0]	R	00000000b	Diagnostic SAR Monitor Data MSB Byte

#### 7.1.2.52 DIAG\_MON\_LSB\_TEMP Register (Address = 0x6B) [Reset = 0x0A]

DIAG\_MON\_LSB\_TEMP is shown in [Table 7-156](#).

Return to the [Summary Table](#).

This register is the diagnostics SAR Temperature monitor data LSB nibble register.

**Table 7-156. DIAG\_MON\_LSB\_TEMP Register Field Descriptions**

Bit	Field	Type	Reset	Description
7-4	DIAG_MON_LSB_TEMP[3:0]	R	0000b	Diagnostic SAR Monitor Data LSB Nibble
3-0	Channel[3:0]	R	1010b	Channel ID

#### 7.1.2.53 DIAG\_MON\_MSB\_AVDD Register (Address = 0x6E) [Reset = 0x00]

DIAG\_MON\_MSB\_AVDD is shown in [Table 7-157](#).

Return to the [Summary Table](#).

This register is the diagnostic SAR AVDD monitor data MSB byte register.

**Table 7-157. DIAG\_MON\_MSB\_AVDD Register Field Descriptions**

Bit	Field	Type	Reset	Description
7-0	DIAG_MON_MSB_AVDD[7:0]	R	00000000b	Diagnostic SAR Monitor Data MSB Byte

#### 7.1.2.54 DIAG\_MON\_LSB\_AVDD Register (Address = 0x6F) [Reset = 0x0C]

DIAG\_MON\_LSB\_AVDD is shown in [Table 7-158](#).

Return to the [Summary Table](#).

This register is the diagnostic SAR AVDD monitor data LSB nibble register

**Table 7-158. DIAG\_MON\_LSB\_AVDD Register Field Descriptions**

Bit	Field	Type	Reset	Description
7-4	DIAG_MON_LSB_AVDD[3:0]	R	0000b	Diagnostic SAR Monitor Data LSB Nibble
3-0	Channel[3:0]	R	1100b	Channel ID

#### 7.1.2.55 DIAG\_MON\_MSB\_GPA Register (Address = 0x70) [Reset = 0x00]

DIAG\_MON\_MSB\_GPA is shown in [Table 7-159](#).

Return to the [Summary Table](#).

This register is the diagnostic SAR GPA monitor data MSB byte register.

**Table 7-159. DIAG\_MON\_MSB\_GPA Register Field Descriptions**

Bit	Field	Type	Reset	Description
7-0	DIAG_MON_MSB_GPA[7:0]	R	00000000b	Diagnostic SAR Monitor Data MSB Byte

**7.1.2.56 DIAG\_MON\_LSB\_GPA Register (Address = 0x71) [Reset = 0x0D]**

DIAG\_MON\_LSB\_GPA is shown in [Table 7-160](#).

Return to the [Summary Table](#).

This register is the diagnostic SAR GPA monitor data LSB nibble register.

**Table 7-160. DIAG\_MON\_LSB\_GPA Register Field Descriptions**

Bit	Field	Type	Reset	Description
7-4	DIAG_MON_LSB_GPA[3:0]	R	0000b	Diagnostic SAR Monitor Data LSB Nibble
3-0	Channel[3:0]	R	1101b	Channel ID



### 7.1.3 TAD5212\_B0\_P3 Registers

Table 7-161 lists the memory-mapped registers for the TAD5212\_B0\_P3 registers. All register offset addresses not listed in Table 7-161 should be considered as reserved locations and the register contents should not be modified.

**Table 7-161. TAD5212\_B0\_P3 Registers**

Address	Acronym	Register Name	Reset Value	Section
0x0	PAGE_CFG	Device page register	0x00	<a href="#">Section 7.1.3.1</a>
0x1A	SASI_CFG0	Secondary ASI configuration register 0	0x30	<a href="#">Section 7.1.3.2</a>
0x1B	SASI_TX_CFG0	SASI TX configuration register 0	0x00	<a href="#">Section 7.1.3.3</a>
0x1C	SASI_TX_CFG1	SASI TX configuration register 1	0x00	<a href="#">Section 7.1.3.4</a>
0x1D	SASI_TX_CFG2	SASI TX configuration register 2	0x00	<a href="#">Section 7.1.3.5</a>
0x1E	SASI_TX_CH1_CFG	SASI TX Channel 1 configuration register	0x00	<a href="#">Section 7.1.3.6</a>
0x1F	SASI_TX_CH2_CFG	SASI TX Channel 2 configuration register	0x01	<a href="#">Section 7.1.3.7</a>
0x20	SASI_TX_CH3_CFG	SASI TX Channel 3 configuration register	0x02	<a href="#">Section 7.1.3.8</a>
0x21	SASI_TX_CH4_CFG	SASI TX Channel 4 configuration register	0x03	<a href="#">Section 7.1.3.9</a>
0x22	SASI_TX_CH5_CFG	SASI TX Channel 5 configuration register	0x04	<a href="#">Section 7.1.3.10</a>
0x23	SASI_TX_CH6_CFG	SASI TX Channel 6 configuration register	0x05	<a href="#">Section 7.1.3.11</a>
0x24	SASI_TX_CH7_CFG	SASI TX Channel 7 configuration register	0x06	<a href="#">Section 7.1.3.12</a>
0x25	SASI_TX_CH8_CFG	SASI TX Channel 8 configuration register	0x07	<a href="#">Section 7.1.3.13</a>
0x26	SASI_RX_CFG0	SASI RX configuration register 0	0x00	<a href="#">Section 7.1.3.14</a>
0x27	SASI_RX_CFG1	SASI RX configuration register 1	0x00	<a href="#">Section 7.1.3.15</a>
0x28	SASI_RX_CH1_CFG	SASI RX Channel 1 configuration register	0x00	<a href="#">Section 7.1.3.16</a>
0x29	SASI_RX_CH2_CFG	SASI RX Channel 2 configuration register	0x01	<a href="#">Section 7.1.3.17</a>
0x2A	SASI_RX_CH3_CFG	SASI RX Channel 3 configuration register	0x02	<a href="#">Section 7.1.3.18</a>
0x2B	SASI_RX_CH4_CFG	SASI RX Channel 4 configuration register	0x03	<a href="#">Section 7.1.3.19</a>
0x2C	SASI_RX_CH5_CFG	SASI RX Channel 5 configuration register	0x04	<a href="#">Section 7.1.3.20</a>
0x2D	SASI_RX_CH6_CFG	SASI RX Channel 6 configuration register	0x05	<a href="#">Section 7.1.3.21</a>
0x2E	SASI_RX_CH7_CFG	SASI RX Channel 7 configuration register	0x06	<a href="#">Section 7.1.3.22</a>
0x2F	SASI_RX_CH8_CFG	SASI RX Channel 8 configuration register	0x07	<a href="#">Section 7.1.3.23</a>
0x32	CLK_CFG12	Clock configuration register 12	0x00	<a href="#">Section 7.1.3.24</a>
0x33	CLK_CFG13	Clock configuration register 13	0x00	<a href="#">Section 7.1.3.25</a>
0x34	CLK_CFG14	Clock configuration register 14	0x10	<a href="#">Section 7.1.3.26</a>
0x35	CLK_CFG15	Clock configuration register 15	0x01	<a href="#">Section 7.1.3.27</a>
0x36	CLK_CFG16	Clock configuration register 16	0x00	<a href="#">Section 7.1.3.28</a>
0x37	CLK_CFG17	Clock configuration register 17	0x00	<a href="#">Section 7.1.3.29</a>
0x38	CLK_CFG18	Clock configuration register 18	0x08	<a href="#">Section 7.1.3.30</a>
0x39	CLK_CFG19	Clock configuration register 19	0x20	<a href="#">Section 7.1.3.31</a>
0x3A	CLK_CFG20	Clock configuration register 20	0x04	<a href="#">Section 7.1.3.32</a>
0x3B	CLK_CFG21	Clock configuration register 21	0x00	<a href="#">Section 7.1.3.33</a>
0x3C	CLK_CFG22	Clock configuration register 22	0x01	<a href="#">Section 7.1.3.34</a>
0x3D	CLK_CFG23	Clock configuration register 23	0x01	<a href="#">Section 7.1.3.35</a>
0x3E	CLK_CFG24	Clock configuration register 24	0x01	<a href="#">Section 7.1.3.36</a>
0x44	CLK_CFG30	Clock configuration register 30	0x00	<a href="#">Section 7.1.3.37</a>
0x45	CLK_CFG31	Clock configuration register 31	0x00	<a href="#">Section 7.1.3.38</a>
0x46	CLKOUT_CFG1	CLKOUT configuration register 1	0x00	<a href="#">Section 7.1.3.39</a>
0x47	CLKOUT_CFG2	CLKOUT configuration register 2	0x01	<a href="#">Section 7.1.3.40</a>

**Table 7-161. TAD5212\_B0\_P3 Registers (continued)**

Address	Acronym	Register Name	Reset Value	Section
0x49	SARCLK_CFG1	SAR clock configuration register 1	0x00	<a href="#">Section 7.1.3.41</a>

**7.1.3.1 PAGE\_CFG Register (Address = 0x0) [Reset = 0x00]**

PAGE\_CFG is shown in [Table 7-162](#).

Return to the [Summary Table](#).

The device memory map is divided into pages. This register sets the page.

**Table 7-162. PAGE\_CFG Register Field Descriptions**

Bit	Field	Type	Reset	Description
7-0	PAGE[7:0]	R/W	00000000b	These bits set the device page. 0d = Page 0 1d = Page 1 2d to 254d = Page 2 to page 254 respectively 255d = Page 255

**7.1.3.2 SASI\_CFG0 Register (Address = 0x1A) [Reset = 0x30]**

SASI\_CFG0 is shown in [Table 7-163](#).

Return to the [Summary Table](#).

This register is the ASI configuration register 0.

**Table 7-163. SASI\_CFG0 Register Field Descriptions**

Bit	Field	Type	Reset	Description
7-6	SASI_FORMAT[1:0]	R/W	00b	Secondary ASI protocol format. 0d = TDM mode 1d = I <sup>2</sup> S mode 2d = LJ (left-justified) mode 3d = Reserved; Don't use
5-4	SASI_WLEN[1:0]	R/W	11b	Secondary ASI word or slot length. 0d = 16 bits (Recommended this setting to be used with 10kΩ input impedance configuration) 1d = 20 bits 2d = 24 bits 3d = 32 bits
3	SASI_FSYNC_POL	R/W	0b	ASI FSYNC polarity (for SASI protocol only). 0d = Default polarity as per standard protocol 1d = Inverted polarity with respect to standard protocol
2	SASI_BCLK_POL	R/W	0b	ASI BCLK polarity (for SASI protocol only). 0d = Default polarity as per standard protocol 1d = Inverted polarity with respect to standard protocol
1	SASI_BUS_ERR	R/W	0b	ASI bus error detection. 0d = Enable bus error detection 1d = Disable bus error detection
0	SASI_BUS_ERR_RCOV	R/W	0b	ASI bus error auto resume. 0d = Enable auto resume after bus error recovery 1d = Disable auto resume after bus error recovery and remain powered down until host configures the device

**7.1.3.3 SASI\_TX\_CFG0 Register (Address = 0x1B) [Reset = 0x00]**

SASI\_TX\_CFG0 is shown in [Table 7-164](#).

Return to the [Summary Table](#).

This register is the SASI TX configuration register 0.

**Table 7-164. SASI\_TX\_CFG0 Register Field Descriptions**

Bit	Field	Type	Reset	Description
7	SASI_TX_EDGE	R/W	0b	Secondary ASI data output (on the primary and secondary data pin) transmit edge. 0d = Default edge as per the protocol configuration setting in SASI_BCLK_POL 1d = Inverted following edge (half cycle delay) with respect to the default edge setting
6	SASI_TX_FILL	R/W	0b	Secondary ASI data output (on the primary and secondary data pin) for any unused cycles 0d = Always transmit 0 for unused cycles 1d = Always use Hi-Z for unused cycles
5	SASI_TX_LSB	R/W	0b	Secondary ASI data output (on the primary and secondary data pin) for LSB transmissions. 0d = Transmit the LSB for a full cycle 1d = Transmit the LSB for the first half cycle and Hi-Z for the second half cycle
4-3	SASI_TX_KEEPER[1:0]	R/W	00b	Secondary ASI data output (on the primary and secondary data pin) bus keeper. 0d = Bus keeper is always disabled 1d = Bus keeper is always enabled 2d = Bus keeper is enabled during LSB transmissions only for one cycle 3d = Bus keeper is enabled during LSB transmissions only for one and half cycles
2	SASI_TX_USE_INT_FSYNC	R/W	0b	Secondary ASI uses internal FSYNC for output data generation in controller mode configuration as applicable. 0d = Use external FSYNC for ASI protocol data generation 1d = Use internal FSYNC for ASI protocol data generation
1	SASI_TX_USE_INT_BCLK	R/W	0b	Secondary ASI uses internal BCLK for output data generation in controller mode configuration. 0d = Use external BCLK for ASI protocol data generation 1d = Use internal BCLK for ASI protocol data generation
0	SASI_TDM_PULSE_WIDTH	R/W	0b	Secondary ASI fsync pulse width in TDM format. 0d = Fsync pulse is 1 bclk period wide 1d = Fsync pulse is 2 bclk period wide

#### 7.1.3.4 SASI\_TX\_CFG1 Register (Address = 0x1C) [Reset = 0x00]

SASI\_TX\_CFG1 is shown in [Table 7-165](#).

Return to the [Summary Table](#).

This register is the SASI TX configuration register 1.

**Table 7-165. SASI\_TX\_CFG1 Register Field Descriptions**

Bit	Field	Type	Reset	Description
7-5	RESERVED	R	0b	Reserved bits; Write only reset value

**Table 7-165. SASI\_TX\_CFG1 Register Field Descriptions (continued)**

Bit	Field	Type	Reset	Description
4-0	SASI_TX_OFFSET[4:0]	R/W	00000b	Secondary ASI output data MSB slot 0 offset (on the primary and secondary data pin). 0d = ASI data MSB location has no offset and is as per standard protocol 1d = ASI data MSB location (TDM mode is slot 0 or I <sup>2</sup> S, LJ mode is the left and right slot 0) offset of one BCLK cycle with respect to standard protocol 2d = ASI data MSB location (TDM mode is slot 0 or I <sup>2</sup> S, LJ mode is the left and right slot 0) offset of two BCLK cycles with respect to standard protocol 3d to 30d = ASI data MSB location (TDM mode is slot 0 or I <sup>2</sup> S, LJ mode is the left and right slot 0) offset assigned as per configuration 31d = ASI data MSB location (TDM mode is slot 0 or I <sup>2</sup> S, LJ mode is the left and right slot 0) offset of 31 BCLK cycles with respect to standard protocol

**7.1.3.5 SASI\_TX\_CFG2 Register (Address = 0x1D) [Reset = 0x00]**

SASI\_TX\_CFG2 is shown in [Table 7-166](#).

Return to the [Summary Table](#).

This register is the SASI TX configuration register 2.

**Table 7-166. SASI\_TX\_CFG2 Register Field Descriptions**

Bit	Field	Type	Reset	Description
7	SASI_TX_CH8_SEL	R/W	0b	Secondary ASI output channel 8 select. 0d = Secondary ASI channel 8 output is on DOUT 1d = Secondary ASI channel 8 output is on DOUT2
6	SASI_TX_CH7_SEL	R/W	0b	Secondary ASI output channel 7 select. 0d = Secondary ASI channel 7 output is on DOUT 1d = Secondary ASI channel 7 output is on DOUT2
5	SASI_TX_CH6_SEL	R/W	0b	Secondary ASI output channel 6 select. 0d = Secondary ASI channel 6 output is on DOUT 1d = Secondary ASI channel 6 output is on DOUT2
4	SASI_TX_CH5_SEL	R/W	0b	Secondary ASI output channel 5 select. 0d = Secondary ASI channel 5 output is on DOUT 1d = Secondary ASI channel 5 output is on DOUT2
3	SASI_TX_CH4_SEL	R/W	0b	Secondary ASI output channel 4 select. 0d = Secondary ASI channel 4 output is on DOUT 1d = Secondary ASI channel 4 output is on DOUT2
2	SASI_TX_CH3_SEL	R/W	0b	Secondary ASI output channel 3 select. 0d = Secondary ASI channel 3 output is on DOUT 1d = Secondary ASI channel 3 output is on DOUT2
1	SASI_TX_CH2_SEL	R/W	0b	Secondary ASI output channel 2 select. 0d = Secondary ASI channel 2 output is on DOUT 1d = Secondary ASI channel 2 output is on DOUT2
0	SASI_TX_CH1_SEL	R/W	0b	Secondary ASI output channel 1 select. 0d = Secondary ASI channel 1 output is on DOUT 1d = Secondary ASI channel 1 output is on DOUT2

**7.1.3.6 SASI\_TX\_CH1\_CFG Register (Address = 0x1E) [Reset = 0x00]**

SASI\_TX\_CH1\_CFG is shown in [Table 7-167](#).

Return to the [Summary Table](#).

This register is the SASI TX Channel 1 configuration register.

**Table 7-167. SASI\_TX\_CH1\_CFG Register Field Descriptions**

Bit	Field	Type	Reset	Description
7-6	RESERVED	R	0b	Reserved bits; Write only reset value
5	SASI_TX_CH1_CFG	R/W	0b	Secondary ASI output channel 1 configuration. 0d = Secondary ASI channel 1 output is in a tri-state condition 1d = Secondary ASI channel 1 output corresponds to ADC Channel 1 data
4-0	SASI_TX_CH1_SLOT_NUM[4:0]	R/W	00000b	Secondary ASI output channel 1 slot assignment. 0d = TDM is slot 0 or I <sup>2</sup> S, LJ is left slot 0 1d = TDM is slot 1 or I <sup>2</sup> S, LJ is left slot 1 2d to 14d = Slot assigned as per configuration 15d = TDM is slot 15 or I <sup>2</sup> S, LJ is left slot 15 16d = TDM is slot 16 or I <sup>2</sup> S, LJ is right slot 0 17d = TDM is slot 17 or I <sup>2</sup> S, LJ is right slot 1 18d to 30d = Slot assigned as per configuration 31d = TDM is slot 31 or I <sup>2</sup> S, LJ is right slot 15

### 7.1.3.7 SASI\_TX\_CH2\_CFG Register (Address = 0x1F) [Reset = 0x01]

SASI\_TX\_CH2\_CFG is shown in [Table 7-168](#).

Return to the [Summary Table](#).

This register is the SASI TX Channel 2 configuration register.

**Table 7-168. SASI\_TX\_CH2\_CFG Register Field Descriptions**

Bit	Field	Type	Reset	Description
7-6	RESERVED	R	0b	Reserved bits; Write only reset value
5	SASI_TX_CH2_CFG	R/W	0b	Secondary ASI output channel 2 configuration. 0d = Secondary ASI channel 2 output is in a tri-state condition 1d = Secondary ASI channel 2 output corresponds to ADC Channel 2 data
4-0	SASI_TX_CH2_SLOT_NUM[4:0]	R/W	00001b	Secondary ASI output channel 2 slot assignment. 0d = TDM is slot 0 or I <sup>2</sup> S, LJ is left slot 0 1d = TDM is slot 1 or I <sup>2</sup> S, LJ is left slot 1 2d to 14d = Slot assigned as per configuration 15d = TDM is slot 15 or I <sup>2</sup> S, LJ is left slot 15 16d = TDM is slot 16 or I <sup>2</sup> S, LJ is right slot 0 17d = TDM is slot 17 or I <sup>2</sup> S, LJ is right slot 1 18d to 30d = Slot assigned as per configuration 31d = TDM is slot 31 or I <sup>2</sup> S, LJ is right slot 15

### 7.1.3.8 SASI\_TX\_CH3\_CFG Register (Address = 0x20) [Reset = 0x02]

SASI\_TX\_CH3\_CFG is shown in [Table 7-169](#).

Return to the [Summary Table](#).

This register is the SASI TX Channel 3 configuration register.

**Table 7-169. SASI\_TX\_CH3\_CFG Register Field Descriptions**

Bit	Field	Type	Reset	Description
7	RESERVED	R	0b	Reserved bit; Write only reset value
6-5	SASI_TX_CH3_CFG[1:0]	R/W	00b	Secondary ASI output channel 3 configuration. 0d = Secondary ASI channel 3 output is in a tri-state condition 1d = Secondary ASI channel 3 output corresponds to ADC Channel 3 data 2d = Reserved 3d = Reserved

**Table 7-169. SASI\_TX\_CH3\_CFG Register Field Descriptions (continued)**

Bit	Field	Type	Reset	Description
4-0	SASI_TX_CH3_SLOT_NUM[4:0]	R/W	00010b	Secondary ASI output channel 3 slot assignment. 0d = TDM is slot 0 or I <sup>2</sup> S, LJ is left slot 0 1d = TDM is slot 1 or I <sup>2</sup> S, LJ is left slot 1 2d to 14d = Slot assigned as per configuration 15d = TDM is slot 15 or I <sup>2</sup> S, LJ is left slot 15 16d = TDM is slot 16 or I <sup>2</sup> S, LJ is right slot 0 17d = TDM is slot 17 or I <sup>2</sup> S, LJ is right slot 1 18d to 30d = Slot assigned as per configuration 31d = TDM is slot 31 or I <sup>2</sup> S, LJ is right slot 15

**7.1.3.9 SASI\_TX\_CH4\_CFG Register (Address = 0x21) [Reset = 0x03]**

SASI\_TX\_CH4\_CFG is shown in [Table 7-170](#).

Return to the [Summary Table](#).

This register is the SASI TX Channel 4 configuration register.

**Table 7-170. SASI\_TX\_CH4\_CFG Register Field Descriptions**

Bit	Field	Type	Reset	Description
7	RESERVED	R	0b	Reserved bit; Write only reset value
6-5	SASI_TX_CH4_CFG[1:0]	R/W	00b	Secondary ASI output channel 4 configuration. 0d = Secondary ASI channel 4 output is in a tri-state condition 1d = Secondary ASI channel 4 output corresponds to ADC Channel 4 data 2d = Secondary ASI channel 4 output corresponds to TEMP data 3d = Reserved
4-0	SASI_TX_CH4_SLOT_NUM[4:0]	R/W	00011b	Secondary ASI output channel 4 slot assignment. 0d = TDM is slot 0 or I <sup>2</sup> S, LJ is left slot 0 1d = TDM is slot 1 or I <sup>2</sup> S, LJ is left slot 1 2d to 14d = Slot assigned as per configuration 15d = TDM is slot 15 or I <sup>2</sup> S, LJ is left slot 15 16d = TDM is slot 16 or I <sup>2</sup> S, LJ is right slot 0 17d = TDM is slot 17 or I <sup>2</sup> S, LJ is right slot 1 18d to 30d = Slot assigned as per configuration 31d = TDM is slot 31 or I <sup>2</sup> S, LJ is right slot 15

**7.1.3.10 SASI\_TX\_CH5\_CFG Register (Address = 0x22) [Reset = 0x04]**

SASI\_TX\_CH5\_CFG is shown in [Table 7-171](#).

Return to the [Summary Table](#).

This register is the SASI TX Channel 5 configuration register.

**Table 7-171. SASI\_TX\_CH5\_CFG Register Field Descriptions**

Bit	Field	Type	Reset	Description
7	RESERVED	R	0b	Reserved bit; Write only reset value
6-5	SASI_TX_CH5_CFG[1:0]	R/W	00b	Secondary ASI output channel 5 configuration. 0d = Secondary ASI channel 5 output is in a tri-state condition 1d = Secondary ASI channel 5 output corresponds to ASI Input Channel 1 loopback data 2d = Secondary ASI channel 5 output corresponds to echo reference channel 1 data 3d = Reserved

**Table 7-171. SASI\_TX\_CH5\_CFG Register Field Descriptions (continued)**

Bit	Field	Type	Reset	Description
4-0	SASI_TX_CH5_SLOT_NUM[4:0]	R/W	00100b	Secondary ASI output channel 5 slot assignment. 0d = TDM is slot 0 or I <sup>2</sup> S, LJ is left slot 0 1d = TDM is slot 1 or I <sup>2</sup> S, LJ is left slot 1 2d to 14d = Slot assigned as per configuration 15d = TDM is slot 15 or I <sup>2</sup> S, LJ is left slot 15 16d = TDM is slot 16 or I <sup>2</sup> S, LJ is right slot 0 17d = TDM is slot 17 or I <sup>2</sup> S, LJ is right slot 1 18d to 30d = Slot assigned as per configuration 31d = TDM is slot 31 or I <sup>2</sup> S, LJ is right slot 15

### 7.1.3.11 SASI\_TX\_CH6\_CFG Register (Address = 0x23) [Reset = 0x05]

SASI\_TX\_CH6\_CFG is shown in [Table 7-172](#).

Return to the [Summary Table](#).

This register is the SASI TX Channel 6 configuration register.

**Table 7-172. SASI\_TX\_CH6\_CFG Register Field Descriptions**

Bit	Field	Type	Reset	Description
7	RESERVED	R	0b	Reserved bit; Write only reset value
6-5	SASI_TX_CH6_CFG[1:0]	R/W	00b	Secondary ASI output channel 6 configuration. 0d = Secondary ASI channel 6 output is in a tri-state condition 1d = Secondary ASI channel 6 output corresponds to ASI Input Channel 2 loopback data 2d = Secondary ASI channel 6 output corresponds to echo reference channel 2 data 3d = Reserved
4-0	SASI_TX_CH6_SLOT_NUM[4:0]	R/W	00101b	Secondary ASI output channel 6 slot assignment. 0d = TDM is slot 0 or I <sup>2</sup> S, LJ is left slot 0 1d = TDM is slot 1 or I <sup>2</sup> S, LJ is left slot 1 2d to 14d = Slot assigned as per configuration 15d = TDM is slot 15 or I <sup>2</sup> S, LJ is left slot 15 16d = TDM is slot 16 or I <sup>2</sup> S, LJ is right slot 0 17d = TDM is slot 17 or I <sup>2</sup> S, LJ is right slot 1 18d to 30d = Slot assigned as per configuration 31d = TDM is slot 31 or I <sup>2</sup> S, LJ is right slot 15

### 7.1.3.12 SASI\_TX\_CH7\_CFG Register (Address = 0x24) [Reset = 0x06]

SASI\_TX\_CH7\_CFG is shown in [Table 7-173](#).

Return to the [Summary Table](#).

This register is the SASI TX Channel 7 configuration register.

**Table 7-173. SASI\_TX\_CH7\_CFG Register Field Descriptions**

Bit	Field	Type	Reset	Description
7	RESERVED	R	0b	Reserved bit; Write only reset value
6-5	SASI_TX_CH7_CFG[1:0]	R/W	00b	Secondary ASI output channel 7 configuration. 0d = Secondary ASI channel 7 output is in a tri-state condition 1d = Reserved 2d = Secondary ASI channel 7 output corresponds to {echo_ref_ch1_wlby2, echo_ref_ch2_wlby2} 3d = Reserved

**Table 7-173. SASI\_TX\_CH7\_CFG Register Field Descriptions (continued)**

Bit	Field	Type	Reset	Description
4-0	SASI_TX_CH7_SLOT_NUM[4:0]	R/W	00110b	Secondary ASI output channel 7 slot assignment. 0d = TDM is slot 0 or I <sup>2</sup> S, LJ is left slot 0 1d = TDM is slot 1 or I <sup>2</sup> S, LJ is left slot 1 2d to 14d = Slot assigned as per configuration 15d = TDM is slot 15 or I <sup>2</sup> S, LJ is left slot 15 16d = TDM is slot 16 or I <sup>2</sup> S, LJ is right slot 0 17d = TDM is slot 17 or I <sup>2</sup> S, LJ is right slot 1 18d to 30d = Slot assigned as per configuration 31d = TDM is slot 31 or I <sup>2</sup> S, LJ is right slot 15

**7.1.3.13 SASI\_TX\_CH8\_CFG Register (Address = 0x25) [Reset = 0x07]**

SASI\_TX\_CH8\_CFG is shown in [Table 7-174](#).

Return to the [Summary Table](#).

This register is the SASI TX Channel 8 configuration register.

**Table 7-174. SASI\_TX\_CH8\_CFG Register Field Descriptions**

Bit	Field	Type	Reset	Description
7-6	RESERVED	R	0b	Reserved bits; Write only reset value
5	SASI_TX_CH8_CFG	R/W	0b	Secondary ASI output channel 8 configuration. 0d = Secondary ASI channel 8 output is in a tri-state condition 1d = Secondary ASI channel 8 output corresponds to ICLA data
4-0	SASI_TX_CH8_SLOT_NUM[4:0]	R/W	00111b	Secondary ASI output channel 8 slot assignment. 0d = TDM is slot 0 or I <sup>2</sup> S, LJ is left slot 0 1d = TDM is slot 1 or I <sup>2</sup> S, LJ is left slot 1 2d to 14d = Slot assigned as per configuration 15d = TDM is slot 15 or I <sup>2</sup> S, LJ is left slot 15 16d = TDM is slot 16 or I <sup>2</sup> S, LJ is right slot 0 17d = TDM is slot 17 or I <sup>2</sup> S, LJ is right slot 1 18d to 30d = Slot assigned as per configuration 31d = TDM is slot 31 or I <sup>2</sup> S, LJ is right slot 15

**7.1.3.14 SASI\_RX\_CFG0 Register (Address = 0x26) [Reset = 0x00]**

SASI\_RX\_CFG0 is shown in [Table 7-175](#).

Return to the [Summary Table](#).

This register is the SASI RX configuration register 0.

**Table 7-175. SASI\_RX\_CFG0 Register Field Descriptions**

Bit	Field	Type	Reset	Description
7	SASI_RX_EDGE	R/W	0b	Secondary ASI data input (on the primary and secondary data pin) receive edge. 0d = Default edge as per the protocol configuration setting in bit 2 (BCLK_POL) 1d = Inverted following edge (half cycle delay) with respect to the default edge setting
6	SASI_RX_USE_INT_FSYNCK	R/W	0b	Secondary ASI uses internal FSYNCK for input data latching in controller mode configuration as applicable. 0d = Use external FSYNCK for ASI protocol data latching 1d = Use internal FSYNCK for ASI protocol data latching
5	SASI_RX_USE_INT_BCLK	R/W	0b	Secondary ASI uses internal BCLK for input data latching in controller mode configuration. 0d = Use external BCLK for ASI protocol data latching 1d = Use internal BCLK for ASI protocol data latching



**Table 7-175. SASI\_RX\_CFG0 Register Field Descriptions (continued)**

Bit	Field	Type	Reset	Description
4-0	SASI_RX_OFFSET[4:0]	R/W	00000b	Secondary ASI data input MSB slot 0 offset (on the primary and secondary data pin). 0d = ASI data MSB location has no offset and is as per standard protocol 1d = ASI data MSB location (TDM mode is slot 0 or I <sup>2</sup> S, LJ mode is the left and right slot 0) offset of one BCLK cycle with respect to standard protocol 2d = ASI data MSB location (TDM mode is slot 0 or I <sup>2</sup> S, LJ mode is the left and right slot 0) offset of two BCLK cycles with respect to standard protocol 3d to 30d = ASI data MSB location (TDM mode is slot 0 or I <sup>2</sup> S, LJ mode is the left and right slot 0) offset assigned as per configuration 31d = ASI data MSB location (TDM mode is slot 0 or I <sup>2</sup> S, LJ mode is the left and right slot 0) offset of 31 BCLK cycles with respect to standard protocol

### 7.1.3.15 SASI\_RX\_CFG1 Register (Address = 0x27) [Reset = 0x00]

SASI\_RX\_CFG1 is shown in [Table 7-176](#).

Return to the [Summary Table](#).

This register is the SASI RX configuration register 1.

**Table 7-176. SASI\_RX\_CFG1 Register Field Descriptions**

Bit	Field	Type	Reset	Description
7	SASI_RX_CH8_SEL	R/W	0b	Secondary ASI input channel 8 select. 0d = Secondary ASI channel 8 input is on DIN 1d = Secondary ASI channel 8 input is on DIN2
6	SASI_RX_CH7_SEL	R/W	0b	Secondary ASI input channel 7 select. 0d = Secondary ASI channel 7 input is on DIN 1d = Secondary ASI channel 7 input is on DIN2
5	SASI_RX_CH6_SEL	R/W	0b	Secondary ASI input channel 6 select. 0d = Secondary ASI channel 6 input is on DIN 1d = Secondary ASI channel 6 input is on DIN2
4	SASI_RX_CH5_SEL	R/W	0b	Secondary ASI input channel 5 select. 0d = Secondary ASI channel 5 input is on DIN 1d = Secondary ASI channel 5 input is on DIN2
3	SASI_RX_CH4_SEL	R/W	0b	Secondary ASI input channel 4 select. 0d = Secondary ASI channel 4 input is on DIN 1d = Secondary ASI channel 4 input is on DIN2
2	SASI_RX_CH3_SEL	R/W	0b	Secondary ASI input channel 3 select. 0d = Secondary ASI channel 3 input is on DIN 1d = Secondary ASI channel 3 input is on DIN2
1	SASI_RX_CH2_SEL	R/W	0b	Secondary ASI input channel 2 select. 0d = Secondary ASI channel 2 input is on DIN 1d = Secondary ASI channel 2 input is on DIN2
0	SASI_RX_CH1_SEL	R/W	0b	Secondary ASI input channel 1 select. 0d = Secondary ASI channel 1 input is on DIN 1d = Secondary ASI channel 1 input is on DIN2

### 7.1.3.16 SASI\_RX\_CH1\_CFG Register (Address = 0x28) [Reset = 0x00]

SASI\_RX\_CH1\_CFG is shown in [Table 7-177](#).

Return to the [Summary Table](#).

This register is the SASI RX Channel 1 configuration register.

**Table 7-177. SASI\_RX\_CH1\_CFG Register Field Descriptions**

Bit	Field	Type	Reset	Description
7-6	RESERVED	R	0b	Reserved bits; Write only reset value
5	SASI_RX_CH1_CFG	R/W	0b	Secondary ASI input channel 1 configuration. 0d = Secondary ASI channel 1 input is disabled 1d = Secondary ASI channel 1 input corresponds to DAC Channel 1 data
4-0	SASI_RX_CH1_SLOT_NUM[4:0]	R/W	00000b	Secondary ASI input channel 1 slot assignment. 0d = TDM is slot 0 or I <sup>2</sup> S, LJ is left slot 0 1d = TDM is slot 1 or I <sup>2</sup> S, LJ is left slot 1 2d to 14d = Slot assigned as per configuration 15d = TDM is slot 15 or I <sup>2</sup> S, LJ is left slot 15 16d = TDM is slot 16 or I <sup>2</sup> S, LJ is right slot 0 17d = TDM is slot 17 or I <sup>2</sup> S, LJ is right slot 1 18d to 30d = Slot assigned as per configuration 31d = TDM is slot 31 or I <sup>2</sup> S, LJ is right slot 15

**7.1.3.17 SASI\_RX\_CH2\_CFG Register (Address = 0x29) [Reset = 0x01]**

SASI\_RX\_CH2\_CFG is shown in [Table 7-178](#).

Return to the [Summary Table](#).

This register is the SASI RX Channel 2 configuration register.

**Table 7-178. SASI\_RX\_CH2\_CFG Register Field Descriptions**

Bit	Field	Type	Reset	Description
7-6	RESERVED	R	0b	Reserved bits; Write only reset value
5	SASI_RX_CH2_CFG	R/W	0b	Secondary ASI input channel 2 configuration. 0d = Secondary ASI channel 2 input is disabled 1d = Secondary ASI channel 2 input corresponds to DAC Channel 2 data
4-0	SASI_RX_CH2_SLOT_NUM[4:0]	R/W	00001b	Secondary ASI input channel 2 slot assignment. 0d = TDM is slot 0 or I <sup>2</sup> S, LJ is left slot 0 1d = TDM is slot 1 or I <sup>2</sup> S, LJ is left slot 1 2d to 14d = Slot assigned as per configuration 15d = TDM is slot 15 or I <sup>2</sup> S, LJ is left slot 15 16d = TDM is slot 16 or I <sup>2</sup> S, LJ is right slot 0 17d = TDM is slot 17 or I <sup>2</sup> S, LJ is right slot 1 18d to 30d = Slot assigned as per configuration 31d = TDM is slot 31 or I <sup>2</sup> S, LJ is right slot 15

**7.1.3.18 SASI\_RX\_CH3\_CFG Register (Address = 0x2A) [Reset = 0x02]**

SASI\_RX\_CH3\_CFG is shown in [Table 7-179](#).

Return to the [Summary Table](#).

This register is the SASI RX Channel 3 configuration register.

**Table 7-179. SASI\_RX\_CH3\_CFG Register Field Descriptions**

Bit	Field	Type	Reset	Description
7-6	RESERVED	R	0b	Reserved bits; Write only reset value
5	SASI_RX_CH3_CFG	R/W	0b	Secondary ASI input channel 3 configuration. 0d = Secondary ASI channel 3 input is disabled 1d = Secondary ASI channel 3 input corresponds to DAC Channel 3 data

**Table 7-179. SASI\_RX\_CH3\_CFG Register Field Descriptions (continued)**

Bit	Field	Type	Reset	Description
4-0	SASI_RX_CH3_SLOT_NUM[4:0]	R/W	00010b	Secondary ASI input channel 3 slot assignment. 0d = TDM is slot 0 or I <sup>2</sup> S, LJ is left slot 0 1d = TDM is slot 1 or I <sup>2</sup> S, LJ is left slot 1 2d to 14d = Slot assigned as per configuration 15d = TDM is slot 15 or I <sup>2</sup> S, LJ is left slot 15 16d = TDM is slot 16 or I <sup>2</sup> S, LJ is right slot 0 17d = TDM is slot 17 or I <sup>2</sup> S, LJ is right slot 1 18d to 30d = Slot assigned as per configuration 31d = TDM is slot 31 or I <sup>2</sup> S, LJ is right slot 15

**7.1.3.19 SASI\_RX\_CH4\_CFG Register (Address = 0x2B) [Reset = 0x03]**

SASI\_RX\_CH4\_CFG is shown in [Table 7-180](#).

Return to the [Summary Table](#).

This register is the SASI RX Channel 4 configuration register.

**Table 7-180. SASI\_RX\_CH4\_CFG Register Field Descriptions**

Bit	Field	Type	Reset	Description
7-6	RESERVED	R	0b	Reserved bits; Write only reset value
5	SASI_RX_CH4_CFG	R/W	0b	Secondary ASI input channel 4 configuration. 0d = Secondary ASI channel 4 input is disabled 1d = Secondary ASI channel 4 input corresponds to DAC Channel 4 data
4-0	SASI_RX_CH4_SLOT_NUM[4:0]	R/W	00011b	Secondary ASI input channel 4 slot assignment. 0d = TDM is slot 0 or I <sup>2</sup> S, LJ is left slot 0 1d = TDM is slot 1 or I <sup>2</sup> S, LJ is left slot 1 2d to 14d = Slot assigned as per configuration 15d = TDM is slot 15 or I <sup>2</sup> S, LJ is left slot 15 16d = TDM is slot 16 or I <sup>2</sup> S, LJ is right slot 0 17d = TDM is slot 17 or I <sup>2</sup> S, LJ is right slot 1 18d to 30d = Slot assigned as per configuration 31d = TDM is slot 31 or I <sup>2</sup> S, LJ is right slot 15

**7.1.3.20 SASI\_RX\_CH5\_CFG Register (Address = 0x2C) [Reset = 0x04]**

SASI\_RX\_CH5\_CFG is shown in [Table 7-181](#).

Return to the [Summary Table](#).

This register is the SASI RX Channel 5 configuration register.

**Table 7-181. SASI\_RX\_CH5\_CFG Register Field Descriptions**

Bit	Field	Type	Reset	Description
7	RESERVED	R	0b	Reserved bit; Write only reset value
6-5	SASI_RX_CH5_CFG[1:0]	R/W	00b	Secondary ASI input channel 5 configuration. 0d = Secondary ASI channel 5 input is disabled 1d = Secondary ASI channel 5 input corresponds to DAC Channel 5 data 2d = Secondary ASI channel 5 input corresponds to ADC Channel 1 output loopback 3d = Reserved

**Table 7-181. SASI\_RX\_CH5\_CFG Register Field Descriptions (continued)**

Bit	Field	Type	Reset	Description
4-0	SASI_RX_CH5_SLOT_NUM[4:0]	R/W	00100b	Secondary ASI input channel 5 slot assignment. 0d = TDM is slot 0 or I <sup>2</sup> S, LJ is left slot 0 1d = TDM is slot 1 or I <sup>2</sup> S, LJ is left slot 1 2d to 14d = Slot assigned as per configuration 15d = TDM is slot 15 or I <sup>2</sup> S, LJ is left slot 15 16d = TDM is slot 16 or I <sup>2</sup> S, LJ is right slot 0 17d = TDM is slot 17 or I <sup>2</sup> S, LJ is right slot 1 18d to 30d = Slot assigned as per configuration 31d = TDM is slot 31 or I <sup>2</sup> S, LJ is right slot 15

**7.1.3.21 SASI\_RX\_CH6\_CFG Register (Address = 0x2D) [Reset = 0x05]**

SASI\_RX\_CH6\_CFG is shown in [Table 7-182](#).

Return to the [Summary Table](#).

This register is the SASI RX Channel 6 configuration register.

**Table 7-182. SASI\_RX\_CH6\_CFG Register Field Descriptions**

Bit	Field	Type	Reset	Description
7	RESERVED	R	0b	Reserved bit; Write only reset value
6-5	SASI_RX_CH6_CFG[1:0]	R/W	00b	Secondary ASI input channel 6 configuration. 0d = Secondary ASI channel 6 input is disabled 1d = Secondary ASI channel 6 input corresponds to DAC Channel 6 data 2d = Secondary ASI channel 6 input corresponds to ADC Channel 2 output loopback 3d = Secondary ASI channel 6 input corresponds to ICLA device 1 data
4-0	SASI_RX_CH6_SLOT_NUM[4:0]	R/W	00101b	Secondary ASI input channel 6 slot assignment. 0d = TDM is slot 0 or I <sup>2</sup> S, LJ is left slot 0 1d = TDM is slot 1 or I <sup>2</sup> S, LJ is left slot 1 2d to 14d = Slot assigned as per configuration 15d = TDM is slot 15 or I <sup>2</sup> S, LJ is left slot 15 16d = TDM is slot 16 or I <sup>2</sup> S, LJ is right slot 0 17d = TDM is slot 17 or I <sup>2</sup> S, LJ is right slot 1 18d to 30d = Slot assigned as per configuration 31d = TDM is slot 31 or I <sup>2</sup> S, LJ is right slot 15

**7.1.3.22 SASI\_RX\_CH7\_CFG Register (Address = 0x2E) [Reset = 0x06]**

SASI\_RX\_CH7\_CFG is shown in [Table 7-183](#).

Return to the [Summary Table](#).

This register is the SASI RX Channel 7 configuration register.

**Table 7-183. SASI\_RX\_CH7\_CFG Register Field Descriptions**

Bit	Field	Type	Reset	Description
7	RESERVED	R	0b	Reserved bit; Write only reset value
6-5	SASI_RX_CH7_CFG[1:0]	R/W	00b	Secondary ASI input channel 7 configuration. 0d = Secondary ASI channel 7 input is disabled 1d = Secondary ASI channel 7 input corresponds to DAC Channel 7 data 2d = Secondary ASI channel 7 input corresponds to ADC Channel 3 output loopback 3d = Secondary ASI channel 7 input corresponds to ICLA device 2 data

**Table 7-183. SASI\_RX\_CH7\_CFG Register Field Descriptions (continued)**

Bit	Field	Type	Reset	Description
4-0	SASI_RX_CH7_SLOT_NUM[4:0]	R/W	00110b	Secondary ASI input channel 7 slot assignment. 0d = TDM is slot 0 or I <sup>2</sup> S, LJ is left slot 0 1d = TDM is slot 1 or I <sup>2</sup> S, LJ is left slot 1 2d to 14d = Slot assigned as per configuration 15d = TDM is slot 15 or I <sup>2</sup> S, LJ is left slot 15 16d = TDM is slot 16 or I <sup>2</sup> S, LJ is right slot 0 17d = TDM is slot 17 or I <sup>2</sup> S, LJ is right slot 1 18d to 30d = Slot assigned as per configuration 31d = TDM is slot 31 or I <sup>2</sup> S, LJ is right slot 15

### 7.1.3.23 SASI\_RX\_CH8\_CFG Register (Address = 0x2F) [Reset = 0x07]

SASI\_RX\_CH8\_CFG is shown in [Table 7-184](#).

Return to the [Summary Table](#).

This register is the SASI RX Channel 8 configuration register.

**Table 7-184. SASI\_RX\_CH8\_CFG Register Field Descriptions**

Bit	Field	Type	Reset	Description
7	RESERVED	R	0b	Reserved bit; Write only reset value
6-5	SASI_RX_CH8_CFG[1:0]	R/W	00b	Secondary ASI input channel 8 configuration. 0d = Secondary ASI channel 8 input is disabled 1d = Secondary ASI channel 8 input corresponds to DAC Channel 8 data 2d = Secondary ASI channel 8 input corresponds to ADC Channel 4 output loopback 3d = Secondary ASI channel 8 input corresponds to ICLA device 3 data
4-0	SASI_RX_CH8_SLOT_NUM[4:0]	R/W	00111b	Secondary ASI input channel 8 slot assignment. 0d = TDM is slot 0 or I <sup>2</sup> S, LJ is left slot 0 1d = TDM is slot 1 or I <sup>2</sup> S, LJ is left slot 1 2d to 14d = Slot assigned as per configuration 15d = TDM is slot 15 or I <sup>2</sup> S, LJ is left slot 15 16d = TDM is slot 16 or I <sup>2</sup> S, LJ is right slot 0 17d = TDM is slot 17 or I <sup>2</sup> S, LJ is right slot 1 18d to 30d = Slot assigned as per configuration 31d = TDM is slot 31 or I <sup>2</sup> S, LJ is right slot 15

### 7.1.3.24 CLK\_CFG12 Register (Address = 0x32) [Reset = 0x00]

CLK\_CFG12 is shown in [Table 7-185](#).

Return to the [Summary Table](#).

This register is the clock configuration register 12.

**Table 7-185. CLK\_CFG12 Register Field Descriptions**

Bit	Field	Type	Reset	Description
7-6	PDIV_CLKSRC_SEL[1:0]	R/W	00b	Source clock selection for PLL PDIV Divider. 0d = PLL_PDIV_IN_CLK is Primary ASI BCLK 1d = PLL_PDIV_IN_CLK is Secondary ASI BCLK 2d = PLL_PDIV_IN_CLK is CCLK 3d = PLL_PDIV_IN_CLK is internal Oscillator Clock (only supported in custom clock configuration)

**Table 7-185. CLK\_CFG12 Register Field Descriptions (continued)**

Bit	Field	Type	Reset	Description
5-3	PASI_BCLK_DIV_CLK_SEL[2:0]	R/W	000b	Primary ASI BCLK divider clock source selection. 0d = Primary ASI BCLK divider clock source is PLL output 1d = Reserved 2d = Primary ASI BCLK divider clock source is secondary ASI BCLK 3d = Primary ASI BCLK divider clock source is CCLK 4d = Primary ASI BCLK divider clock source is internal oscillator clock (only supported in custom clock configuration) 5d = Primary ASI BCLK divider clock source is DSP clock 6d to 7d = Reserved
2-0	RESERVED	R	0b	Reserved bits; Write only reset value

**7.1.3.25 CLK\_CFG13 Register (Address = 0x33) [Reset = 0x00]**

CLK\_CFG13 is shown in [Table 7-186](#).

Return to the [Summary Table](#).

This register is the clock configuration register 13.

**Table 7-186. CLK\_CFG13 Register Field Descriptions**

Bit	Field	Type	Reset	Description
7	RESERVED	R	0b	Reserved bit; Write only reset value
6-4	SASI_BCLK_DIV_CLK_SEL[2:0]	R/W	000b	Secondary ASI BCLK divider clock source selection. 0d = Secondary ASI BCLK divider clock source is PLL output 1d = Secondary ASI BCLK divider clock source is primary ASI BCLK 2d = Reserved 3d = Secondary ASI BCLK divider clock source is CCLK 4d = Secondary ASI BCLK divider clock source is internal oscillator clock (only supported in custom clock configuration) 5d = Secondary ASI BCLK divider clock source is DSP clock 6d to 7d = Reserved
3-0	RESERVED	R	0b	Reserved bits; Write only reset value

**7.1.3.26 CLK\_CFG14 Register (Address = 0x34) [Reset = 0x10]**

CLK\_CFG14 is shown in [Table 7-187](#).

Return to the [Summary Table](#).

This register is the clock configuration register 14.

**Table 7-187. CLK\_CFG14 Register Field Descriptions**

Bit	Field	Type	Reset	Description
7-6	DIG_NM_DIV_CLK_SRC_SEL[1:0]	R/W	00b	Source clock selection for DIG NMDIV CLK clock. 0d = DIG NM divider input clock is Primary ASI BCLK 1d = DIG NM divider input clock is Secondary ASI BCLK 2d = DIG NM divider input clock is CCLK 3d = DIG NM divider input clock is internal oscillator clock (only supported in custom clock configuration)
5-4	ANA_NM_DIV_CLK_SRC_SEL[1:0]	R/W	01b	Source clock selection for NMDIV CLK clock. 0d = NM divider input clock is PLL Output 1d = NM divider input clock is PLL Output 2d = NM divider input clock is DIG NM Divider Clock Source 3d = NM divider input clock is Primary ASI BCLK (Low Jitter Path)
3-2	RESERVED	R	0b	Reserved bits; Write only reset values
1-0	RESERVED	R	0b	Reserved bits; Write only reset values

### 7.1.3.27 CLK\_CFG15 Register (Address = 0x35) [Reset = 0x01]

CLK\_CFG15 is shown in [Table 7-188](#).

Return to the [Summary Table](#).

This register is the clock configuration register 15.

**Table 7-188. CLK\_CFG15 Register Field Descriptions**

Bit	Field	Type	Reset	Description
7-0	PLL_PDIV[7:0]	R/W	00000001b	PLL pre-scaler P-divisor value (Don't care when auto detection is enabled) 0d = PLL PDIV value is 256 1d = PLL PDIV value is 1 2d = PLL PDIV value is 2 3d to 254d = PLL PDIV value is as per configuration 255d = PLL PDIV value is 255

### 7.1.3.28 CLK\_CFG16 Register (Address = 0x36) [Reset = 0x00]

CLK\_CFG16 is shown in [Table 7-189](#).

Return to the [Summary Table](#).

This register is the clock configuration register 16.

**Table 7-189. CLK\_CFG16 Register Field Descriptions**

Bit	Field	Type	Reset	Description
7	PLL_JMUL_MSB	R/W	0b	PLL integer portion J-multiplier value MSB bit. (Don't care when auto detection is enabled)
6	PLL_DIV_CLK_DIG_BY_2	R/W	0b	PLL DIV clock divide by 2 configuration 0d = No divide/2 inside PLL 1d = PLL does a divide/2
5-0	PLL_DMUL_MSB[5:0]	R/W	000000b	PLL fractional portion D-multiplier value MSB bits. (Don't care when auto detection is enabled)

### 7.1.3.29 CLK\_CFG17 Register (Address = 0x37) [Reset = 0x00]

CLK\_CFG17 is shown in [Table 7-190](#).

Return to the [Summary Table](#).

This register is the clock configuration register 17.

**Table 7-190. CLK\_CFG17 Register Field Descriptions**

Bit	Field	Type	Reset	Description
7-0	PLL_DMUL_LSB[7:0]	R/W	00000000b	PLL fractional portion D-multiplier value LSB byte. Above D-multiplier value MSB bits (PLL_DMUL_MSB) along with this LSB byte (PLL_DMUL_LSB) is concatenated to determine final D-multiplier value. (Don't care when auto detection is enabled) 0d = PLL DMUL value is 0 1d = PLL DMUL value is 1 2d = PLL DMUL value is 2 3d to 9998d = PLL JMUL value is as per configuration 9999d = PLL JMUL value is 9999 10000d to 16383d = Reserved; Don't use

### 7.1.3.30 CLK\_CFG18 Register (Address = 0x38) [Reset = 0x08]

CLK\_CFG18 is shown in [Table 7-191](#).

Return to the [Summary Table](#).

This register is the clock configuration register 18.

**Table 7-191. CLK\_CFG18 Register Field Descriptions**

Bit	Field	Type	Reset	Description
7-0	PLL_JMUL_LSB[7:0]	R/W	00001000b	PLL integer portion J-multiplier value LSB byte. Above J-multiplier value MSB bit (PLL_JMUL_MSB) along with this LSB byte (PLL_JMUL_LSB) is concatenated to determine final J-multiplier value. (Don't care when auto detection is enabled) 0d = Reserved; Don't use 1d = PLL JMUL value is 1 2d = PLL JMUL value is 2 3d to 510d = PLL JMUL value is as per configuration 511d = PLL JMUL value is 511

### 7.1.3.31 CLK\_CFG19 Register (Address = 0x39) [Reset = 0x20]

CLK\_CFG19 is shown in [Table 7-192](#).

Return to the [Summary Table](#).

This register is the clock configuration register 19.

**Table 7-192. CLK\_CFG19 Register Field Descriptions**

Bit	Field	Type	Reset	Description
7-5	NDIV[2:0]	R/W	001b	NDIV divider value. (Don't care when auto detection is enabled) 0d = NDIV value is 8 1d = NDIV value is 1 2d = NDIV value is 2 3d to 6d = NDIV value is as per configuration 7d = NDIV value is 7
4-2	PDM_DIV[2:0]	R/W	000b	PDM divider value. (Don't care when auto detection is enabled) 0d = PDM_DIV value is 1 1d = PDM_DIV value is 2 2d = PDM_DIV value is 4 3d = PDM_DIV value is 8 4d = PDM_DIV value is 16 5d-7d Reserved
1-0	RESERVED	R	0b	Reserved bits; Write only reset values

### 7.1.3.32 CLK\_CFG20 Register (Address = 0x3A) [Reset = 0x04]

CLK\_CFG20 is shown in [Table 7-193](#).

Return to the [Summary Table](#).

This register is the clock configuration register 20.

**Table 7-193. CLK\_CFG20 Register Field Descriptions**

Bit	Field	Type	Reset	Description
7-2	MDIV[5:0]	R/W	000001b	MDIV divider value. (Don't care when auto detection is enabled) 0d = MDIV value is 64 1d = MDIV value is 1 2d = MDIV value is 2 3d to 62d = MDIV value is as per configuration 63d = MDIV value is 63



**Table 7-193. CLK\_CFG20 Register Field Descriptions (continued)**

Bit	Field	Type	Reset	Description
1-0	DIG_ADC_MODCLK_DIV[1:0]	R/W	00b	ADC modulator clock divider value. (Don't care when auto detection is enabled) 0d = DIG_ADC_MODCLK_DIV value is 1 1d = DIG_ADC_MODCLK_DIV value is 2 2d = DIG_ADC_MODCLK_DIV value is 4 3d = Reserved

### 7.1.3.33 CLK\_CFG21 Register (Address = 0x3B) [Reset = 0x00]

CLK\_CFG21 is shown in [Table 7-194](#).

Return to the [Summary Table](#).

This register is the clock configuration register 21.

**Table 7-194. CLK\_CFG21 Register Field Descriptions**

Bit	Field	Type	Reset	Description
7-6	RESERVED	R	0b	Reserved bits; Write only reset values
5-4	DIG_DAC_MODCLK_DIV[1:0]	R/W	00b	DAC modulator clock divider value. (Don't care when auto detection is enabled) 0d = DIG_DAC_MODCLK_DIV value is 1 1d = DIG_DAC_MODCLK_DIV value is 2 2d = DIG_DAC_MODCLK_DIV value is 4 3d = Reserved
3	DAC_MODCLKx2_DIS	R/W	0b	DAC modulator clock select configuration. 0d = DAC MOD clock 2x enabled 1d = DAC MOD clock 2x disabled
2	PASI_BDIV_MSB	R/W	0b	Primary ASI BCLK divider value MSB bit. (Don't care when auto detection is enabled)
1	SASI_BDIV_MSB	R/W	0b	Secondary ASI BCLK divider value MSB bit. (Don't care when auto detection is enabled)
0	RESERVED	R	0b	Reserved bit; Write only reset value

### 7.1.3.34 CLK\_CFG22 Register (Address = 0x3C) [Reset = 0x01]

CLK\_CFG22 is shown in [Table 7-195](#).

Return to the [Summary Table](#).

This register is the clock configuration register 22.

**Table 7-195. CLK\_CFG22 Register Field Descriptions**

Bit	Field	Type	Reset	Description
7-0	PASI_BDIV_LSB[7:0]	R/W	0000001b	Secondary ASI BCLK divider value. (Don't care when auto detection is enabled) 0d = SASI BCLK divider value is 512 1d = SASI BCLK divider value is 1 2d = SASI BCLK divider value is 2 3d to 62d = SASI BCLK divider value is as per configuration 63d = SASI BCLK divider value is 511

### 7.1.3.35 CLK\_CFG23 Register (Address = 0x3D) [Reset = 0x01]

CLK\_CFG23 is shown in [Table 7-196](#).

Return to the [Summary Table](#).

This register is the clock configuration register 23.

**Table 7-196. CLK\_CFG23 Register Field Descriptions**

Bit	Field	Type	Reset	Description
7-0	SASI_BDIV_LSB[7:0]	R/W	00000001b	Secondary ASI BCLK divider value. (Don't care when auto detection is enabled) 0d = SASI BCLK divider value is 512 1d = SASI BCLK divider value is 1 2d = SASI BCLK divider value is 2 3d to 62d = SASI BCLK divider value is as per configuration 63d = SASI BCLK divider value is 511

### 7.1.3.36 CLK\_CFG24 Register (Address = 0x3E) [Reset = 0x01]

CLK\_CFG24 is shown in [Table 7-197](#).

Return to the [Summary Table](#).

This register is the clock configuration register 24.

**Table 7-197. CLK\_CFG24 Register Field Descriptions**

Bit	Field	Type	Reset	Description
7-6	RESERVED	R	0b	Reserved bits; Write only reset value
5-0	ANA_NM_DIV[5:0]	R/W	000001b	Analog N-M DIV divider value. (Don't care when auto detection is enabled) 0d = ANA_NM_DIV value is 64 1d = ANA_NM_DIV value is 1 2d = ANA_NM_DIV value is 2 3d to 62d = ANA_NM_DIV value is as per configuration 63d = NDIV value is 63

### 7.1.3.37 CLK\_CFG30 Register (Address = 0x44) [Reset = 0x00]

CLK\_CFG30 is shown in [Table 7-198](#).

Return to the [Summary Table](#).

This register is the clock configuration register 30.

**Table 7-198. CLK\_CFG30 Register Field Descriptions**

Bit	Field	Type	Reset	Description
7-3	RESERVED	R	0b	Reserved bits; Write only reset value
2	NDIV_EN	R/W	0b	NDIV divider enable 0d = divider disabled 1d = divider enabled
1	MDIV_EN	R/W	0b	MDIV divider enable 0d = divider disabled 1d = divider enabled
0	PDM_DIV_EN	R/W	0b	PDM divider enable 0d = divider disabled 1d = divider enabled

### 7.1.3.38 CLK\_CFG31 Register (Address = 0x45) [Reset = 0x00]

CLK\_CFG31 is shown in [Table 7-199](#).

Return to the [Summary Table](#).

This register is the clock configuration register 31.

**Table 7-199. CLK\_CFG31 Register Field Descriptions**

Bit	Field	Type	Reset	Description
7	RESERVED	R	0b	Reserved bit; Write only reset value
6	RESERVED	R	0b	Reserved bit; Write only reset value
5	RESERVED	R	0b	Reserved bit; Write only reset value
4	DIG_DAC_MODCLK_DIV_EN	R/W	0b	DAC MODCLK divider enable 0d = divider disabled 1d = divider enabled
3	PASI_BDIV_EN	R/W	0b	PASI BDIV divider enable 0d = divider disabled 1d = divider enabled
2	SASI_BDIV_EN	R/W	0b	SASI BDIV divider enable 0d = divider disabled 1d = divider enabled
1	PASI_FSYNC_DIV_EN	R/W	0b	PASI FSYNC DIV divider enable 0d = divider disabled 1d = divider enabled
0	SASI_FSYNC_DIV_EN	R/W	0b	SASI FSYNC DIV divider enable 0d = divider disabled 1d = divider enabled

### 7.1.3.39 CLKOUT\_CFG1 Register (Address = 0x46) [Reset = 0x00]

CLKOUT\_CFG1 is shown in [Table 7-200](#).

Return to the [Summary Table](#).

This register is the CLKOUT configuration register 1.

**Table 7-200. CLKOUT\_CFG1 Register Field Descriptions**

Bit	Field	Type	Reset	Description
7-3	RESERVED	R	0b	Reserved bits; Write only reset value
2-0	CLKOUT_CLK_SEL[2:0]	R/W	000b	General Purpose CLKOUT divider clock source selection. 0d = Source clock is PLL output 1d = Source clock is primary ASI BCLK 2d = Source clock is secondary ASI BCLK 3d = Source clock is CCLK 4d = Source clock is internal oscillator clock 5d = Source clock is DSP clock 6d to 7d = Reserved

### 7.1.3.40 CLKOUT\_CFG2 Register (Address = 0x47) [Reset = 0x01]

CLKOUT\_CFG2 is shown in [Table 7-201](#).

Return to the [Summary Table](#).

This register is the CLKOUT configuration register 2.

**Table 7-201. CLKOUT\_CFG2 Register Field Descriptions**

Bit	Field	Type	Reset	Description
7	CLKOUT_DIV_EN	R/W	0b	CLKOUT divider enable. 0d = CLKOUT divider disabled 1d = CLKOUT divider enabled

**Table 7-201. CLKOUT\_CFG2 Register Field Descriptions (continued)**

Bit	Field	Type	Reset	Description
6-0	CLKOUT_DIV[6:0]	R/W	0000001b	CLKOUT DIV divider value. 0d = CLKOUT_DIV value is 128 1d = CLKOUT_DIV value is 1 2d = CLKOUT_DIV value is 2 3d to 126d = CLKOUT_DIV value is as per configuration 127d = CLKOUT_DIV value is 127

**7.1.3.41 SARCLK\_CFG1 Register (Address = 0x49) [Reset = 0x00]**

SARCLK\_CFG1 is shown in [Table 7-202](#).

Return to the [Summary Table](#).

This register is the SAR clock configuration register 1

**Table 7-202. SARCLK\_CFG1 Register Field Descriptions**

Bit	Field	Type	Reset	Description
7-6	SAR_CLK_FREQ_SEL[1:0]	R/W	00b	SAR clock frequency mode 0d = SAR clock frequency is ~6MHz 1d = SAR clock frequency is ~3MHz 2d = SAR clock frequency is ~1.5MHz 3d = SAR clock frequency is ~12MHz (valid only when SAR clock is generated directly using internal oscillator clock in custom clock configuration)
5	SAR_CLK_SRC_AUTO_DISABLE	R/W	0b	SAR divider source clock auto selection disable 0d = SAR divider source clock auto-selection based on clock detection scheme 1d = Reserved
4	SAR_CLK_SRC_MANUAL_SEL	R/W	0b	SAR clock source manual selection (don't care in auto mode) 0d = SAR clock generated based on Audio clock available for ADC/DAC 1d = SAR clock generated based on internal oscillator clock (only supported in custom clock configuration)
3	SAR_CLK_EN_AUTO_DISABLE	R/W	0b	SAR divider source clock auto selection disable 0d = SAR divider auto-enabled 1d = Reserved
2	SAR_CLK_MANUAL_EN	R/W	0b	SAR divider manual enable (don't care in auto mode) 0d = SAR divider disabled 1d = SAR divider enabled
1-0	SAR_CLK_MANUAL_DIV[1:0]	R/W	00b	SAR divider value (don't care in auto mode) 0d = SAR divider value is 1 1d = SAR divider value is 2 2d = SAR divider value is 4 3d = SAR divider value is 8

**7.2 Programmable Coefficient Registers**

The register pages in this section consists of the programmable coefficients of the device. TI recommends using the PPC3 GUI for configuring the programmable coefficients settings; for more details see the [TAC5212EVM-PDK Evaluation module user's guide](#) and the [PurePath™ console graphical development suite](#). To optimize the coefficients register transaction time for the register pages in this section, the device also supports (by default) auto-incremented pages for the I<sup>2</sup>C and SPI burst writes and reads. After a transaction of register address 0x7F, the device auto increments to the next page at register 0x08 to transact the next coefficient value. These programmable coefficients are 32-bit, two's complement numbers. For a successful coefficient register transaction, the host device must write and read all four bytes starting with the most significant byte (BYT1) for a target coefficient register transaction. When using SPI for a coefficient register read transaction, the device transmits the first byte as a dummy read byte; therefore, the host must read five bytes, including the first dummy

read byte and the last four bytes corresponding to the coefficient register value starting with the most significant byte (BYT1).

### 7.2.1 Programmable Coefficient Registers: Page 8

This register page shown in [Table 7-203](#) consists of the programmable coefficients for the ADC biquad 1 to biquad 6 filters.

**Table 7-203. Page 8 Programmable Coefficient Registers**

ADDRESS	REGISTER	RESET	DESCRIPTION
0x00	PAGE[7:0]	0x00	Device Page Register
0x08	ADC_BQ1_N0_BYT1[7:0]	0x7F	Programmable ADC biquad 1, N0 coefficient byte[31:24]
0x09	ADC_BQ1_N0_BYT2[7:0]	0xFF	Programmable ADC biquad 1, N0 coefficient byte[23:16]
0x0A	ADC_BQ1_N0_BYT3[7:0]	0xFF	Programmable ADC biquad 1, N0 coefficient byte[15:8]
0x0B	ADC_BQ1_N0_BYT4[7:0]	0xFF	Programmable ADC biquad 1, N0 coefficient byte[7:0]
0x0C	ADC_BQ1_N1_BYT1[7:0]	0x00	Programmable ADC biquad 1, N1 coefficient byte[31:24]
0x0D	ADC_BQ1_N1_BYT2[7:0]	0x00	Programmable ADC biquad 1, N1 coefficient byte[23:16]
0x0E	ADC_BQ1_N1_BYT3[7:0]	0x00	Programmable ADC biquad 1, N1 coefficient byte[15:8]
0x0F	ADC_BQ1_N1_BYT4[7:0]	0x00	Programmable ADC biquad 1, N1 coefficient byte[7:0]
0x10	ADC_BQ1_N2_BYT1[7:0]	0x00	Programmable ADC biquad 1, N2 coefficient byte[31:24]
0x11	ADC_BQ1_N2_BYT2[7:0]	0x00	Programmable ADC biquad 1, N2 coefficient byte[23:16]
0x12	ADC_BQ1_N2_BYT3[7:0]	0x00	Programmable ADC biquad 1, N2 coefficient byte[15:8]
0x13	ADC_BQ1_N2_BYT4[7:0]	0x00	Programmable ADC biquad 1, N2 coefficient byte[7:0]
0x14	ADC_BQ1_D1_BYT1[7:0]	0x00	Programmable ADC biquad 1, D1 coefficient byte[31:24]
0x15	ADC_BQ1_D1_BYT2[7:0]	0x00	Programmable ADC biquad 1, D1 coefficient byte[23:16]
0x16	ADC_BQ1_D1_BYT3[7:0]	0x00	Programmable ADC biquad 1, D1 coefficient byte[15:8]
0x17	ADC_BQ1_D1_BYT4[7:0]	0x00	Programmable ADC biquad 1, D1 coefficient byte[7:0]
0x18	ADC_BQ1_D2_BYT1[7:0]	0x00	Programmable ADC biquad 1, D2 coefficient byte[31:24]
0x19	ADC_BQ1_D2_BYT2[7:0]	0x00	Programmable ADC biquad 1, D2 coefficient byte[23:16]
0x1A	ADC_BQ1_D2_BYT3[7:0]	0x00	Programmable ADC biquad 1, D2 coefficient byte[15:8]
0x1B	ADC_BQ1_D2_BYT4[7:0]	0x00	Programmable ADC biquad 1, D2 coefficient byte[7:0]
0x1C	ADC_BQ2_N0_BYT1[7:0]	0x7F	Programmable ADC biquad 2, N0 coefficient byte[31:24]
0x1D	ADC_BQ2_N0_BYT2[7:0]	0xFF	Programmable ADC biquad 2, N0 coefficient byte[23:16]
0x1E	ADC_BQ2_N0_BYT3[7:0]	0xFF	Programmable ADC biquad 2, N0 coefficient byte[15:8]
0x1F	ADC_BQ2_N0_BYT4[7:0]	0xFF	Programmable ADC biquad 2, N0 coefficient byte[7:0]
0x20	ADC_BQ2_N1_BYT1[7:0]	0x00	Programmable ADC biquad 2, N1 coefficient byte[31:24]
0x21	ADC_BQ2_N1_BYT2[7:0]	0x00	Programmable ADC biquad 2, N1 coefficient byte[23:16]
0x22	ADC_BQ2_N1_BYT3[7:0]	0x00	Programmable ADC biquad 2, N1 coefficient byte[15:8]
0x23	ADC_BQ2_N1_BYT4[7:0]	0x00	Programmable ADC biquad 2, N1 coefficient byte[7:0]
0x24	ADC_BQ2_N2_BYT1[7:0]	0x00	Programmable ADC biquad 2, N2 coefficient byte[31:24]
0x25	ADC_BQ2_N2_BYT2[7:0]	0x00	Programmable ADC biquad 2, N2 coefficient byte[23:16]
0x26	ADC_BQ2_N2_BYT3[7:0]	0x00	Programmable ADC biquad 2, N2 coefficient byte[15:8]
0x27	ADC_BQ2_N2_BYT4[7:0]	0x00	Programmable ADC biquad 2, N2 coefficient byte[7:0]
0x28	ADC_BQ2_D1_BYT1[7:0]	0x00	Programmable ADC biquad 2, D1 coefficient byte[31:24]
0x29	ADC_BQ2_D1_BYT2[7:0]	0x00	Programmable ADC biquad 2, D1 coefficient byte[23:16]
0x2A	ADC_BQ2_D1_BYT3[7:0]	0x00	Programmable ADC biquad 2, D1 coefficient byte[15:8]
0x2B	ADC_BQ2_D1_BYT4[7:0]	0x00	Programmable ADC biquad 2, D1 coefficient byte[7:0]
0x2C	ADC_BQ2_D2_BYT1[7:0]	0x00	Programmable ADC biquad 2, D2 coefficient byte[31:24]
0x2D	ADC_BQ2_D2_BYT2[7:0]	0x00	Programmable ADC biquad 2, D2 coefficient byte[23:16]

**Table 7-203. Page 8 Programmable Coefficient Registers (continued)**

0x2E	ADC_BQ2_D2_BYT3[7:0]	0x00	Programmable ADC biquad 2, D2 coefficient byte[15:8]
0x2F	ADC_BQ2_D2_BYT4[7:0]	0x00	Programmable ADC biquad 2, D2 coefficient byte[7:0]
0x30	ADC_BQ3_N0_BYT1[7:0]	0x7F	Programmable ADC biquad 3, N0 coefficient byte[31:24]
0x31	ADC_BQ3_N0_BYT2[7:0]	0xFF	Programmable ADC biquad 3, N0 coefficient byte[23:16]
0x32	ADC_BQ3_N0_BYT3[7:0]	0xFF	Programmable ADC biquad 3, N0 coefficient byte[15:8]
0x33	ADC_BQ3_N0_BYT4[7:0]	0xFF	Programmable ADC biquad 3, N0 coefficient byte[7:0]
0x34	ADC_BQ3_N1_BYT1[7:0]	0x00	Programmable ADC biquad 3, N1 coefficient byte[31:24]
0x35	ADC_BQ3_N1_BYT2[7:0]	0x00	Programmable ADC biquad 3, N1 coefficient byte[23:16]
0x36	ADC_BQ3_N1_BYT3[7:0]	0x00	Programmable ADC biquad 3, N1 coefficient byte[15:8]
0x37	ADC_BQ3_N1_BYT4[7:0]	0x00	Programmable ADC biquad 3, N1 coefficient byte[7:0]
0x38	ADC_BQ3_N2_BYT1[7:0]	0x00	Programmable ADC biquad 3, N2 coefficient byte[31:24]
0x39	ADC_BQ3_N2_BYT2[7:0]	0x00	Programmable ADC biquad 3, N2 coefficient byte[23:16]
0x3A	ADC_BQ3_N2_BYT3[7:0]	0x00	Programmable ADC biquad 3, N2 coefficient byte[15:8]
0x3B	ADC_BQ3_N2_BYT4[7:0]	0x00	Programmable ADC biquad 3, N2 coefficient byte[7:0]
0x3C	ADC_BQ3_D1_BYT1[7:0]	0x00	Programmable ADC biquad 3, D1 coefficient byte[31:24]
0x3D	ADC_BQ3_D1_BYT2[7:0]	0x00	Programmable ADC biquad 3, D1 coefficient byte[23:16]
0x3E	ADC_BQ3_D1_BYT3[7:0]	0x00	Programmable ADC biquad 3, D1 coefficient byte[15:8]
0x3F	ADC_BQ3_D1_BYT4[7:0]	0x00	Programmable ADC biquad 3, D1 coefficient byte[7:0]
0x40	ADC_BQ3_D2_BYT1[7:0]	0x00	Programmable ADC biquad 3, D2 coefficient byte[31:24]
0x41	ADC_BQ3_D2_BYT2[7:0]	0x00	Programmable ADC biquad 3, D2 coefficient byte[23:16]
0x42	ADC_BQ3_D2_BYT3[7:0]	0x00	Programmable ADC biquad 3, D2 coefficient byte[15:8]
0x43	ADC_BQ3_D2_BYT4[7:0]	0x00	Programmable ADC biquad 3, D2 coefficient byte[7:0]
0x44	ADC_BQ4_N0_BYT1[7:0]	0x7F	Programmable ADC biquad 4, N0 coefficient byte[31:24]
0x45	ADC_BQ4_N0_BYT2[7:0]	0xFF	Programmable ADC biquad 4, N0 coefficient byte[23:16]
0x46	ADC_BQ4_N0_BYT3[7:0]	0xFF	Programmable ADC biquad 4, N0 coefficient byte[15:8]
0x47	ADC_BQ4_N0_BYT4[7:0]	0xFF	Programmable ADC biquad 4, N0 coefficient byte[7:0]
0x48	ADC_BQ4_N1_BYT1[7:0]	0x00	Programmable ADC biquad 4, N1 coefficient byte[31:24]
0x49	ADC_BQ4_N1_BYT2[7:0]	0x00	Programmable ADC biquad 4, N1 coefficient byte[23:16]
0x4A	ADC_BQ4_N1_BYT3[7:0]	0x00	Programmable ADC biquad 4, N1 coefficient byte[15:8]
0x4B	ADC_BQ4_N1_BYT4[7:0]	0x00	Programmable ADC biquad 4, N1 coefficient byte[7:0]
0x4C	ADC_BQ4_N2_BYT1[7:0]	0x00	Programmable ADC biquad 4, N2 coefficient byte[31:24]
0x4D	ADC_BQ4_N2_BYT2[7:0]	0x00	Programmable ADC biquad 4, N2 coefficient byte[23:16]
0x4E	ADC_BQ4_N2_BYT3[7:0]	0x00	Programmable ADC biquad 4, N2 coefficient byte[15:8]
0x4F	ADC_BQ4_N2_BYT4[7:0]	0x00	Programmable ADC biquad 4, N2 coefficient byte[7:0]
0x50	ADC_BQ4_D1_BYT1[7:0]	0x00	Programmable ADC biquad 4, D1 coefficient byte[31:24]
0x51	ADC_BQ4_D1_BYT2[7:0]	0x00	Programmable ADC biquad 4, D1 coefficient byte[23:16]
0x52	ADC_BQ4_D1_BYT3[7:0]	0x00	Programmable ADC biquad 4, D1 coefficient byte[15:8]
0x53	ADC_BQ4_D1_BYT4[7:0]	0x00	Programmable ADC biquad 4, D1 coefficient byte[7:0]
0x54	ADC_BQ4_D2_BYT1[7:0]	0x00	Programmable ADC biquad 4, D2 coefficient byte[31:24]
0x55	ADC_BQ4_D2_BYT2[7:0]	0x00	Programmable ADC biquad 4, D2 coefficient byte[23:16]
0x56	ADC_BQ4_D2_BYT3[7:0]	0x00	Programmable ADC biquad 4, D2 coefficient byte[15:8]
0x57	ADC_BQ4_D2_BYT4[7:0]	0x00	Programmable ADC biquad 4, D2 coefficient byte[7:0]
0x58	ADC_BQ5_N0_BYT1[7:0]	0x7F	Programmable ADC biquad 5, N0 coefficient byte[31:24]
0x59	ADC_BQ5_N0_BYT2[7:0]	0xFF	Programmable ADC biquad 5, N0 coefficient byte[23:16]
0x5A	ADC_BQ5_N0_BYT3[7:0]	0xFF	Programmable ADC biquad 5, N0 coefficient byte[15:8]
0x5B	ADC_BQ5_N0_BYT4[7:0]	0xFF	Programmable ADC biquad 5, N0 coefficient byte[7:0]

**Table 7-203. Page 8 Programmable Coefficient Registers (continued)**

0x5C	ADC_BQ5_N1_BYT1[7:0]	0x00	Programmable ADC biquad 5, N1 coefficient byte[31:24]
0x5D	ADC_BQ5_N1_BYT2[7:0]	0x00	Programmable ADC biquad 5, N1 coefficient byte[23:16]
0x5E	ADC_BQ5_N1_BYT3[7:0]	0x00	Programmable ADC biquad 5, N1 coefficient byte[15:8]
0x5F	ADC_BQ5_N1_BYT4[7:0]	0x00	Programmable ADC biquad 5, N1 coefficient byte[7:0]
0x60	ADC_BQ5_N2_BYT1[7:0]	0x00	Programmable ADC biquad 5, N2 coefficient byte[31:24]
0x61	ADC_BQ5_N2_BYT2[7:0]	0x00	Programmable ADC biquad 5, N2 coefficient byte[23:16]
0x62	ADC_BQ5_N2_BYT3[7:0]	0x00	Programmable ADC biquad 5, N2 coefficient byte[15:8]
0x63	ADC_BQ5_N2_BYT4[7:0]	0x00	Programmable ADC biquad 5, N2 coefficient byte[7:0]
0x64	ADC_BQ5_D1_BYT1[7:0]	0x00	Programmable ADC biquad 5, D1 coefficient byte[31:24]
0x65	ADC_BQ5_D1_BYT2[7:0]	0x00	Programmable ADC biquad 5, D1 coefficient byte[23:16]
0x66	ADC_BQ5_D1_BYT3[7:0]	0x00	Programmable ADC biquad 5, D1 coefficient byte[15:8]
0x67	ADC_BQ5_D1_BYT4[7:0]	0x00	Programmable ADC biquad 5, D1 coefficient byte[7:0]
0x68	ADC_BQ5_D2_BYT1[7:0]	0x00	Programmable ADC biquad 5, D2 coefficient byte[31:24]
0x69	ADC_BQ5_D2_BYT2[7:0]	0x00	Programmable ADC biquad 5, D2 coefficient byte[23:16]
0x6A	ADC_BQ5_D2_BYT3[7:0]	0x00	Programmable ADC biquad 5, D2 coefficient byte[15:8]
0x6B	ADC_BQ5_D2_BYT4[7:0]	0x00	Programmable ADC biquad 5, D2 coefficient byte[7:0]
0x6C	ADC_BQ6_N0_BYT1[7:0]	0x7F	Programmable ADC biquad 6, N0 coefficient byte[31:24]
0x6D	ADC_BQ6_N0_BYT2[7:0]	0xFF	Programmable ADC biquad 6, N0 coefficient byte[23:16]
0x6E	ADC_BQ6_N0_BYT3[7:0]	0xFF	Programmable ADC biquad 6, N0 coefficient byte[15:8]
0x6F	ADC_BQ6_N0_BYT4[7:0]	0xFF	Programmable ADC biquad 6, N0 coefficient byte[7:0]
0x70	ADC_BQ6_N1_BYT1[7:0]	0x00	Programmable ADC biquad 6, N1 coefficient byte[31:24]
0x71	ADC_BQ6_N1_BYT2[7:0]	0x00	Programmable ADC biquad 6, N1 coefficient byte[23:16]
0x72	ADC_BQ6_N1_BYT3[7:0]	0x00	Programmable ADC biquad 6, N1 coefficient byte[15:8]
0x73	ADC_BQ6_N1_BYT4[7:0]	0x00	Programmable ADC biquad 6, N1 coefficient byte[7:0]
0x74	ADC_BQ6_N2_BYT1[7:0]	0x00	Programmable ADC biquad 6, N2 coefficient byte[31:24]
0x75	ADC_BQ6_N2_BYT2[7:0]	0x00	Programmable ADC biquad 6, N2 coefficient byte[23:16]
0x76	ADC_BQ6_N2_BYT3[7:0]	0x00	Programmable ADC biquad 6, N2 coefficient byte[15:8]
0x77	ADC_BQ6_N2_BYT4[7:0]	0x00	Programmable ADC biquad 6, N2 coefficient byte[7:0]
0x78	ADC_BQ6_D1_BYT1[7:0]	0x00	Programmable ADC biquad 6, D1 coefficient byte[31:24]
0x79	ADC_BQ6_D1_BYT2[7:0]	0x00	Programmable ADC biquad 6, D1 coefficient byte[23:16]
0x7A	ADC_BQ6_D1_BYT3[7:0]	0x00	Programmable ADC biquad 6, D1 coefficient byte[15:8]
0x7B	ADC_BQ6_D1_BYT4[7:0]	0x00	Programmable ADC biquad 6, D1 coefficient byte[7:0]
0x7C	ADC_BQ6_D2_BYT1[7:0]	0x00	Programmable ADC biquad 6, D2 coefficient byte[31:24]
0x7D	ADC_BQ6_D2_BYT2[7:0]	0x00	Programmable ADC biquad 6, D2 coefficient byte[23:16]
0x7E	ADC_BQ6_D2_BYT3[7:0]	0x00	Programmable ADC biquad 6, D2 coefficient byte[15:8]
0x7F	ADC_BQ6_D2_BYT4[7:0]	0x00	Programmable ADC biquad 6, D2 coefficient byte[7:0]

### 7.2.2 Programmable Coefficient Registers: Page 9

This register page shown in [Table 7-204](#) consists of the programmable coefficients for the ADC biquad 7 to biquad 12 filters.

**Table 7-204. Page 9 Programmable Coefficient Registers**

ADDRESS	REGISTER	RESET	DESCRIPTION
0x00	PAGE[7:0]	0x00	Device Page Register
0x08	ADC_BQ7_N0_BYT1[7:0]	0x7F	Programmable ADC biquad 7, N0 coefficient byte[31:24]
0x09	ADC_BQ7_N0_BYT2[7:0]	0xFF	Programmable ADC biquad 7, N0 coefficient byte[23:16]
0x0A	ADC_BQ7_N0_BYT3[7:0]	0xFF	Programmable ADC biquad 7, N0 coefficient byte[15:8]

**Table 7-204. Page 9 Programmable Coefficient Registers (continued)**

0x0B	ADC_BQ7_N0_BYT4[7:0]	0xFF	Programmable ADC biquad 7, N0 coefficient byte[7:0]
0x0C	ADC_BQ7_N1_BYT1[7:0]	0x00	Programmable ADC biquad 7, N1 coefficient byte[31:24]
0x0D	ADC_BQ7_N1_BYT2[7:0]	0x00	Programmable ADC biquad 7, N1 coefficient byte[23:16]
0x0E	ADC_BQ7_N1_BYT3[7:0]	0x00	Programmable ADC biquad 7, N1 coefficient byte[15:8]
0x0F	ADC_BQ7_N1_BYT4[7:0]	0x00	Programmable ADC biquad 7, N1 coefficient byte[7:0]
0x10	ADC_BQ7_N2_BYT1[7:0]	0x00	Programmable ADC biquad 7, N2 coefficient byte[31:24]
0x11	ADC_BQ7_N2_BYT2[7:0]	0x00	Programmable ADC biquad 7, N2 coefficient byte[23:16]
0x12	ADC_BQ7_N2_BYT3[7:0]	0x00	Programmable ADC biquad 7, N2 coefficient byte[15:8]
0x13	ADC_BQ7_N2_BYT4[7:0]	0x00	Programmable ADC biquad 7, N2 coefficient byte[7:0]
0x14	ADC_BQ7_D1_BYT1[7:0]	0x00	Programmable ADC biquad 7, D1 coefficient byte[31:24]
0x15	ADC_BQ7_D1_BYT2[7:0]	0x00	Programmable ADC biquad 7, D1 coefficient byte[23:16]
0x16	ADC_BQ7_D1_BYT3[7:0]	0x00	Programmable ADC biquad 7, D1 coefficient byte[15:8]
0x17	ADC_BQ7_D1_BYT4[7:0]	0x00	Programmable ADC biquad 7, D1 coefficient byte[7:0]
0x18	ADC_BQ7_D2_BYT1[7:0]	0x00	Programmable ADC biquad 7, D2 coefficient byte[31:24]
0x19	ADC_BQ7_D2_BYT2[7:0]	0x00	Programmable ADC biquad 7, D2 coefficient byte[23:16]
0x1A	ADC_BQ7_D2_BYT3[7:0]	0x00	Programmable ADC biquad 7, D2 coefficient byte[15:8]
0x1B	ADC_BQ7_D2_BYT4[7:0]	0x00	Programmable ADC biquad 7, D2 coefficient byte[7:0]
0x1C	ADC_BQ8_N0_BYT1[7:0]	0x7F	Programmable ADC biquad 8, N0 coefficient byte[31:24]
0x1D	ADC_BQ8_N0_BYT2[7:0]	0xFF	Programmable ADC biquad 8, N0 coefficient byte[23:16]
0x1E	ADC_BQ8_N0_BYT3[7:0]	0xFF	Programmable ADC biquad 8, N0 coefficient byte[15:8]
0x1F	ADC_BQ8_N0_BYT4[7:0]	0xFF	Programmable ADC biquad 8, N0 coefficient byte[7:0]
0x20	ADC_BQ8_N1_BYT1[7:0]	0x00	Programmable ADC biquad 8, N1 coefficient byte[31:24]
0x21	ADC_BQ8_N1_BYT2[7:0]	0x00	Programmable ADC biquad 8, N1 coefficient byte[23:16]
0x22	ADC_BQ8_N1_BYT3[7:0]	0x00	Programmable ADC biquad 8, N1 coefficient byte[15:8]
0x23	ADC_BQ8_N1_BYT4[7:0]	0x00	Programmable ADC biquad 8, N1 coefficient byte[7:0]
0x24	ADC_BQ8_N2_BYT1[7:0]	0x00	Programmable ADC biquad 8, N2 coefficient byte[31:24]
0x25	ADC_BQ8_N2_BYT2[7:0]	0x00	Programmable ADC biquad 8, N2 coefficient byte[23:16]
0x26	ADC_BQ8_N2_BYT3[7:0]	0x00	Programmable ADC biquad 8, N2 coefficient byte[15:8]
0x27	ADC_BQ8_N2_BYT4[7:0]	0x00	Programmable ADC biquad 8, N2 coefficient byte[7:0]
0x28	ADC_BQ8_D1_BYT1[7:0]	0x00	Programmable ADC biquad 8, D1 coefficient byte[31:24]
0x29	ADC_BQ8_D1_BYT2[7:0]	0x00	Programmable ADC biquad 8, D1 coefficient byte[23:16]
0x2A	ADC_BQ8_D1_BYT3[7:0]	0x00	Programmable ADC biquad 8, D1 coefficient byte[15:8]
0x2B	ADC_BQ8_D1_BYT4[7:0]	0x00	Programmable ADC biquad 8, D1 coefficient byte[7:0]
0x2C	ADC_BQ8_D2_BYT1[7:0]	0x00	Programmable ADC biquad 8, D2 coefficient byte[31:24]
0x2D	ADC_BQ8_D2_BYT2[7:0]	0x00	Programmable ADC biquad 8, D2 coefficient byte[23:16]
0x2E	ADC_BQ8_D2_BYT3[7:0]	0x00	Programmable ADC biquad 8, D2 coefficient byte[15:8]
0x2F	ADC_BQ8_D2_BYT4[7:0]	0x00	Programmable ADC biquad 8, D2 coefficient byte[7:0]
0x30	ADC_BQ9_N0_BYT1[7:0]	0x7F	Programmable ADC biquad 9, N0 coefficient byte[31:24]
0x31	ADC_BQ9_N0_BYT2[7:0]	0xFF	Programmable ADC biquad 9, N0 coefficient byte[23:16]
0x32	ADC_BQ9_N0_BYT3[7:0]	0xFF	Programmable ADC biquad 9, N0 coefficient byte[15:8]
0x33	ADC_BQ9_N0_BYT4[7:0]	0xFF	Programmable ADC biquad 9, N0 coefficient byte[7:0]
0x34	ADC_BQ9_N1_BYT1[7:0]	0x00	Programmable ADC biquad 9, N1 coefficient byte[31:24]
0x35	ADC_BQ9_N1_BYT2[7:0]	0x00	Programmable ADC biquad 9, N1 coefficient byte[23:16]
0x36	ADC_BQ9_N1_BYT3[7:0]	0x00	Programmable ADC biquad 9, N1 coefficient byte[15:8]
0x37	ADC_BQ9_N1_BYT4[7:0]	0x00	Programmable ADC biquad 9, N1 coefficient byte[7:0]
0x38	ADC_BQ9_N2_BYT1[7:0]	0x00	Programmable ADC biquad 9, N2 coefficient byte[31:24]



**Table 7-204. Page 9 Programmable Coefficient Registers (continued)**

0x39	ADC_BQ9_N2_BYT2[7:0]	0x00	Programmable ADC biquad 9, N2 coefficient byte[23:16]
0x3A	ADC_BQ9_N2_BYT3[7:0]	0x00	Programmable ADC biquad 9, N2 coefficient byte[15:8]
0x3B	ADC_BQ9_N2_BYT4[7:0]	0x00	Programmable ADC biquad 9, N2 coefficient byte[7:0]
0x3C	ADC_BQ9_D1_BYT1[7:0]	0x00	Programmable ADC biquad 9, D1 coefficient byte[31:24]
0x3D	ADC_BQ9_D1_BYT2[7:0]	0x00	Programmable ADC biquad 9, D1 coefficient byte[23:16]
0x3E	ADC_BQ9_D1_BYT3[7:0]	0x00	Programmable ADC biquad 9, D1 coefficient byte[15:8]
0x3F	ADC_BQ9_D1_BYT4[7:0]	0x00	Programmable ADC biquad 9, D1 coefficient byte[7:0]
0x40	ADC_BQ9_D2_BYT1[7:0]	0x00	Programmable ADC biquad 9, D2 coefficient byte[31:24]
0x41	ADC_BQ9_D2_BYT2[7:0]	0x00	Programmable ADC biquad 9, D2 coefficient byte[23:16]
0x42	ADC_BQ9_D2_BYT3[7:0]	0x00	Programmable ADC biquad 9, D2 coefficient byte[15:8]
0x43	ADC_BQ9_D2_BYT4[7:0]	0x00	Programmable ADC biquad 9, D2 coefficient byte[7:0]
0x44	ADC_BQ10_N0_BYT1[7:0]	0x7F	Programmable ADC biquad 10, N0 coefficient byte[31:24]
0x45	ADC_BQ10_N0_BYT2[7:0]	0xFF	Programmable ADC biquad 10, N0 coefficient byte[23:16]
0x46	ADC_BQ10_N0_BYT3[7:0]	0xFF	Programmable ADC biquad 10, N0 coefficient byte[15:8]
0x47	ADC_BQ10_N0_BYT4[7:0]	0xFF	Programmable ADC biquad 10, N0 coefficient byte[7:0]
0x48	ADC_BQ10_N1_BYT1[7:0]	0x00	Programmable ADC biquad 10, N1 coefficient byte[31:24]
0x49	ADC_BQ10_N1_BYT2[7:0]	0x00	Programmable ADC biquad 10, N1 coefficient byte[23:16]
0x4A	ADC_BQ10_N1_BYT3[7:0]	0x00	Programmable ADC biquad 10, N1 coefficient byte[15:8]
0x4B	ADC_BQ10_N1_BYT4[7:0]	0x00	Programmable ADC biquad 10, N1 coefficient byte[7:0]
0x4C	ADC_BQ10_N2_BYT1[7:0]	0x00	Programmable ADC biquad 10, N2 coefficient byte[31:24]
0x4D	ADC_BQ10_N2_BYT2[7:0]	0x00	Programmable ADC biquad 10, N2 coefficient byte[23:16]
0x4E	ADC_BQ10_N2_BYT3[7:0]	0x00	Programmable ADC biquad 10, N2 coefficient byte[15:8]
0x4F	ADC_BQ10_N2_BYT4[7:0]	0x00	Programmable ADC biquad 10, N2 coefficient byte[7:0]
0x50	ADC_BQ10_D1_BYT1[7:0]	0x00	Programmable ADC biquad 10, D1 coefficient byte[31:24]
0x51	ADC_BQ10_D1_BYT2[7:0]	0x00	Programmable ADC biquad 10, D1 coefficient byte[23:16]
0x52	ADC_BQ10_D1_BYT3[7:0]	0x00	Programmable ADC biquad 10, D1 coefficient byte[15:8]
0x53	ADC_BQ10_D1_BYT4[7:0]	0x00	Programmable ADC biquad 10, D1 coefficient byte[7:0]
0x54	ADC_BQ10_D2_BYT1[7:0]	0x00	Programmable ADC biquad 10, D2 coefficient byte[31:24]
0x55	ADC_BQ10_D2_BYT2[7:0]	0x00	Programmable ADC biquad 10, D2 coefficient byte[23:16]
0x56	ADC_BQ10_D2_BYT3[7:0]	0x00	Programmable ADC biquad 10, D2 coefficient byte[15:8]
0x57	ADC_BQ10_D2_BYT4[7:0]	0x00	Programmable ADC biquad 10, D2 coefficient byte[7:0]
0x58	ADC_BQ11_N0_BYT1[7:0]	0x7F	Programmable ADC biquad 11, N0 coefficient byte[31:24]
0x59	ADC_BQ11_N0_BYT2[7:0]	0xFF	Programmable ADC biquad 11, N0 coefficient byte[23:16]
0x5A	ADC_BQ11_N0_BYT3[7:0]	0xFF	Programmable ADC biquad 11, N0 coefficient byte[15:8]
0x5B	ADC_BQ11_N0_BYT4[7:0]	0xFF	Programmable ADC biquad 11, N0 coefficient byte[7:0]
0x5C	ADC_BQ11_N1_BYT1[7:0]	0x00	Programmable ADC biquad 11, N1 coefficient byte[31:24]
0x5D	ADC_BQ11_N1_BYT2[7:0]	0x00	Programmable ADC biquad 11, N1 coefficient byte[23:16]
0x5E	ADC_BQ11_N1_BYT3[7:0]	0x00	Programmable ADC biquad 11, N1 coefficient byte[15:8]
0x5F	ADC_BQ11_N1_BYT4[7:0]	0x00	Programmable ADC biquad 11, N1 coefficient byte[7:0]
0x60	ADC_BQ11_N2_BYT1[7:0]	0x00	Programmable ADC biquad 11, N2 coefficient byte[31:24]
0x61	ADC_BQ11_N2_BYT2[7:0]	0x00	Programmable ADC biquad 11, N2 coefficient byte[23:16]
0x62	ADC_BQ11_N2_BYT3[7:0]	0x00	Programmable ADC biquad 11, N2 coefficient byte[15:8]
0x63	ADC_BQ11_N2_BYT4[7:0]	0x00	Programmable ADC biquad 11, N2 coefficient byte[7:0]
0x64	ADC_BQ11_D1_BYT1[7:0]	0x00	Programmable ADC biquad 11, D1 coefficient byte[31:24]
0x65	ADC_BQ11_D1_BYT2[7:0]	0x00	Programmable ADC biquad 11, D1 coefficient byte[23:16]
0x66	ADC_BQ11_D1_BYT3[7:0]	0x00	Programmable ADC biquad 11, D1 coefficient byte[15:8]

**Table 7-204. Page 9 Programmable Coefficient Registers (continued)**

0x67	ADC_BQ11_D1_BYT4[7:0]	0x00	Programmable ADC biquad 11, D1 coefficient byte[7:0]
0x68	ADC_BQ11_D2_BYT1[7:0]	0x00	Programmable ADC biquad 11, D2 coefficient byte[31:24]
0x69	ADC_BQ11_D2_BYT2[7:0]	0x00	Programmable ADC biquad 11, D2 coefficient byte[23:16]
0x6A	ADC_BQ11_D2_BYT3[7:0]	0x00	Programmable ADC biquad 11, D2 coefficient byte[15:8]
0x6B	ADC_BQ11_D2_BYT4[7:0]	0x00	Programmable ADC biquad 11, D2 coefficient byte[7:0]
0x6C	ADC_BQ12_N0_BYT1[7:0]	0x7F	Programmable ADC biquad 12, N0 coefficient byte[31:24]
0x6D	ADC_BQ12_N0_BYT2[7:0]	0xFF	Programmable ADC biquad 12, N0 coefficient byte[23:16]
0x6E	ADC_BQ12_N0_BYT3[7:0]	0xFF	Programmable ADC biquad 12, N0 coefficient byte[15:8]
0x6F	ADC_BQ12_N0_BYT4[7:0]	0xFF	Programmable ADC biquad 12, N0 coefficient byte[7:0]
0x70	ADC_BQ12_N1_BYT1[7:0]	0x00	Programmable ADC biquad 12, N1 coefficient byte[31:24]
0x71	ADC_BQ12_N1_BYT2[7:0]	0x00	Programmable ADC biquad 12, N1 coefficient byte[23:16]
0x72	ADC_BQ12_N1_BYT3[7:0]	0x00	Programmable ADC biquad 12, N1 coefficient byte[15:8]
0x73	ADC_BQ12_N1_BYT4[7:0]	0x00	Programmable ADC biquad 12, N1 coefficient byte[7:0]
0x74	ADC_BQ12_N2_BYT1[7:0]	0x00	Programmable ADC biquad 12, N2 coefficient byte[31:24]
0x75	ADC_BQ12_N2_BYT2[7:0]	0x00	Programmable ADC biquad 12, N2 coefficient byte[23:16]
0x76	ADC_BQ12_N2_BYT3[7:0]	0x00	Programmable ADC biquad 12, N2 coefficient byte[15:8]
0x77	ADC_BQ12_N2_BYT4[7:0]	0x00	Programmable ADC biquad 12, N2 coefficient byte[7:0]
0x78	ADC_BQ12_D1_BYT1[7:0]	0x00	Programmable ADC biquad 12, D1 coefficient byte[31:24]
0x79	ADC_BQ12_D1_BYT2[7:0]	0x00	Programmable ADC biquad 12, D1 coefficient byte[23:16]
0x7A	ADC_BQ12_D1_BYT3[7:0]	0x00	Programmable ADC biquad 12, D1 coefficient byte[15:8]
0x7B	ADC_BQ12_D1_BYT4[7:0]	0x00	Programmable ADC biquad 12, D1 coefficient byte[7:0]
0x7C	ADC_BQ12_D2_BYT1[7:0]	0x00	Programmable ADC biquad 12, D2 coefficient byte[31:24]
0x7D	ADC_BQ12_D2_BYT2[7:0]	0x00	Programmable ADC biquad 12, D2 coefficient byte[23:16]
0x7E	ADC_BQ12_D2_BYT3[7:0]	0x00	Programmable ADC biquad 12, D2 coefficient byte[15:8]
0x7F	ADC_BQ12_D2_BYT4[7:0]	0x00	Programmable ADC biquad 12, D2 coefficient byte[7:0]

**7.2.3 Programmable Coefficient Registers: Page 10**

This register page shown in [Table 7-205](#) consists of the programmable coefficients for the ADC mixer 1 to 4, ADC to DAC loopback mixer and the ADC first-order IIR filter. All channel mixer coefficients are 32-bit, two's complement numbers using a 1.31 number format. The value of 0x7FFFFFFF is equivalent to +1 (0-dB gain), the value 0x00000000 is equivalent to mute (zero data) and all values in between set the mixer attenuation computed accordingly ( $hex2dec(value)/2^{31}$ ). If the MSB is set to '1' then the attenuation remains the same but the signal phase is inverted.

**Table 7-205. Page 10 Programmable Coefficient Registers**

ADDRESS	REGISTER	RESET	DESCRIPTION
0x00	PAGE[7:0]	0x00	Device Page Register
0x08	ADC_MIX1_CH1_BYT1[7:0]	0x7F	Digital mixer 1, ADC channel 1 coefficient byte[31:24]
0x09	ADC_MIX1_CH1_BYT2[7:0]	0xFF	Digital mixer 1, ADC channel 1 coefficient byte[23:16]
0x0A	ADC_MIX1_CH1_BYT3[7:0]	0xFF	Digital mixer 1, ADC channel 1 coefficient byte[15:8]
0x0B	ADC_MIX1_CH1_BYT4[7:0]	0xFF	Digital mixer 1, ADC channel 1 coefficient byte[7:0]
0x0C	ADC_MIX1_CH2_BYT1[7:0]	0x00	Digital mixer 1, ADC channel 2 coefficient byte[31:24]
0x0D	ADC_MIX1_CH2_BYT2[7:0]	0x00	Digital mixer 1, ADC channel 2 coefficient byte[23:16]
0x0E	ADC_MIX1_CH2_BYT3[7:0]	0x00	Digital mixer 1, ADC channel 2 coefficient byte[15:8]
0x0F	ADC_MIX1_CH2_BYT4[7:0]	0x00	Digital mixer 1, ADC channel 2 coefficient byte[7:0]
0x10	ADC_MIX1_CH3_BYT1[7:0]	0x00	Digital mixer 1, ADC channel 3 coefficient byte[31:24]

**Table 7-205. Page 10 Programmable Coefficient Registers (continued)**

0x11	ADC_MIX1_CH3_BYT2[7:0]	0x00	Digital mixer 1, ADC channel 3 coefficient byte[23:16]
0x12	ADC_MIX1_CH3_BYT3[7:0]	0x00	Digital mixer 1, ADC channel 3 coefficient byte[15:8]
0x13	ADC_MIX1_CH3_BYT4[7:0]	0x00	Digital mixer 1, ADC channel 3 coefficient byte[7:0]
0x14	ADC_MIX1_CH4_BYT1[7:0]	0x00	Digital mixer 1, ADC channel 4 coefficient byte[31:24]
0x15	ADC_MIX1_CH4_BYT2[7:0]	0x00	Digital mixer 1, ADC channel 4 coefficient byte[23:16]
0x16	ADC_MIX1_CH4_BYT3[7:0]	0x00	Digital mixer 1, ADC channel 4 coefficient byte[15:8]
0x17	ADC_MIX1_CH4_BYT4[7:0]	0x00	Digital mixer 1, ADC channel 4 coefficient byte[7:0]
0x18	ADC_MIX2_CH1_BYT1[7:0]	0x00	Digital mixer 2, ADC channel 1 coefficient byte[31:24]
0x19	ADC_MIX2_CH1_BYT2[7:0]	0x00	Digital mixer 2, ADC channel 1 coefficient byte[23:16]
0x1A	ADC_MIX2_CH1_BYT3[7:0]	0x00	Digital mixer 2, ADC channel 1 coefficient byte[15:8]
0x1B	ADC_MIX2_CH1_BYT4[7:0]	0x00	Digital mixer 2, ADC channel 1 coefficient byte[7:0]
0x1C	ADC_MIX2_CH2_BYT1[7:0]	0x7F	Digital mixer 2, ADC channel 2 coefficient byte[31:24]
0x1D	ADC_MIX2_CH2_BYT2[7:0]	0xFF	Digital mixer 2, ADC channel 2 coefficient byte[23:16]
0x1E	ADC_MIX2_CH2_BYT3[7:0]	0xFF	Digital mixer 2, ADC channel 2 coefficient byte[15:8]
0x1F	ADC_MIX2_CH2_BYT4[7:0]	0xFF	Digital mixer 2, ADC channel 2 coefficient byte[7:0]
0x20	ADC_MIX2_CH3_BYT1[7:0]	0x00	Digital mixer 2, ADC channel 3 coefficient byte[31:24]
0x21	ADC_MIX2_CH3_BYT2[7:0]	0x00	Digital mixer 2, ADC channel 3 coefficient byte[23:16]
0x22	ADC_MIX2_CH3_BYT3[7:0]	0x00	Digital mixer 2, ADC channel 3 coefficient byte[15:8]
0x23	ADC_MIX2_CH3_BYT4[7:0]	0x00	Digital mixer 2, ADC channel 3 coefficient byte[7:0]
0x24	ADC_MIX2_CH4_BYT1[7:0]	0x00	Digital mixer 2, ADC channel 4 coefficient byte[31:24]
0x25	ADC_MIX2_CH4_BYT2[7:0]	0x00	Digital mixer 2, ADC channel 4 coefficient byte[23:16]
0x26	ADC_MIX2_CH4_BYT3[7:0]	0x00	Digital mixer 2, ADC channel 4 coefficient byte[15:8]
0x27	ADC_MIX2_CH4_BYT4[7:0]	0x00	Digital mixer 2, ADC channel 4 coefficient byte[7:0]
0x28	ADC_MIX3_CH1_BYT1[7:0]	0x00	Digital mixer 3, ADC channel 1 coefficient byte[31:24]
0x29	ADC_MIX3_CH1_BYT2[7:0]	0x00	Digital mixer 3, ADC channel 1 coefficient byte[23:16]
0x2A	ADC_MIX3_CH1_BYT3[7:0]	0x00	Digital mixer 3, ADC channel 1 coefficient byte[15:8]
0x2B	ADC_MIX3_CH1_BYT4[7:0]	0x00	Digital mixer 3, ADC channel 1 coefficient byte[7:0]
0x2C	ADC_MIX3_CH2_BYT1[7:0]	0x00	Digital mixer 3, ADC channel 2 coefficient byte[31:24]
0x2D	ADC_MIX3_CH2_BYT2[7:0]	0x00	Digital mixer 3, ADC channel 2 coefficient byte[23:16]
0x2E	ADC_MIX3_CH2_BYT3[7:0]	0x00	Digital mixer 3, ADC channel 2 coefficient byte[15:8]
0x2F	ADC_MIX3_CH2_BYT4[7:0]	0x00	Digital mixer 3, ADC channel 2 coefficient byte[7:0]
0x30	ADC_MIX3_CH3_BYT1[7:0]	0x7F	Digital mixer 3, ADC channel 3 coefficient byte[31:24]
0x31	ADC_MIX3_CH3_BYT2[7:0]	0xFF	Digital mixer 3, ADC channel 3 coefficient byte[23:16]
0x32	ADC_MIX3_CH3_BYT3[7:0]	0xFF	Digital mixer 3, ADC channel 3 coefficient byte[15:8]
0x33	ADC_MIX3_CH3_BYT4[7:0]	0xFF	Digital mixer 3, ADC channel 3 coefficient byte[7:0]
0x34	ADC_MIX3_CH4_BYT1[7:0]	0x00	Digital mixer 3, ADC channel 4 coefficient byte[31:24]
0x35	ADC_MIX3_CH4_BYT2[7:0]	0x00	Digital mixer 3, ADC channel 4 coefficient byte[23:16]
0x36	ADC_MIX3_CH4_BYT3[7:0]	0x00	Digital mixer 3, ADC channel 4 coefficient byte[15:8]
0x37	ADC_MIX3_CH4_BYT4[7:0]	0x00	Digital mixer 3, ADC channel 4 coefficient byte[7:0]

**Table 7-205. Page 10 Programmable Coefficient Registers (continued)**

0x38	ADC_MIX4_CH1_BYT1[7:0]	0x00	Digital mixer 4, ADC channel 1 coefficient byte[31:24]
0x39	ADC_MIX4_CH1_BYT2[7:0]	0x00	Digital mixer 4, ADC channel 1 coefficient byte[23:16]
0x3A	ADC_MIX4_CH1_BYT3[7:0]	0x00	Digital mixer 4, ADC channel 1 coefficient byte[15:8]
0x3B	ADC_MIX4_CH1_BYT4[7:0]	0x00	Digital mixer 4, ADC channel 1 coefficient byte[7:0]
0x3C	ADC_MIX4_CH2_BYT1[7:0]	0x00	Digital mixer 4, ADC channel 2 coefficient byte[31:24]
0x3D	ADC_MIX4_CH2_BYT2[7:0]	0x00	Digital mixer 4, ADC channel 2 coefficient byte[23:16]
0x3E	ADC_MIX4_CH2_BYT3[7:0]	0x00	Digital mixer 4, ADC channel 2 coefficient byte[15:8]
0x3F	ADC_MIX4_CH2_BYT4[7:0]	0x00	Digital mixer 4, ADC channel 2 coefficient byte[7:0]
0x40	ADC_MIX4_CH3_BYT1[7:0]	0x00	Digital mixer 4, ADC channel 3 coefficient byte[31:24]
0x41	ADC_MIX4_CH3_BYT2[7:0]	0x00	Digital mixer 4, ADC channel 3 coefficient byte[23:16]
0x42	ADC_MIX4_CH3_BYT3[7:0]	0x00	Digital mixer 4, ADC channel 3 coefficient byte[15:8]
0x43	ADC_MIX4_CH3_BYT4[7:0]	0x00	Digital mixer 4, ADC channel 3 coefficient byte[7:0]
0x44	ADC_MIX4_CH4_BYT1[7:0]	0x7F	Digital mixer 4, ADC channel 4 coefficient byte[31:24]
0x45	ADC_MIX4_CH4_BYT2[7:0]	0xFF	Digital mixer 4, ADC channel 4 coefficient byte[23:16]
0x46	ADC_MIX4_CH4_BYT3[7:0]	0xFF	Digital mixer 4, ADC channel 4 coefficient byte[15:8]
0x47	ADC_MIX4_CH4_BYT4[7:0]	0xFF	Digital mixer 4, ADC channel 4 coefficient byte[7:0]
0x48	ADC_LB_MIX1_CH1_BYT1[7:0]	0x7F	Digital loopback (ADC to DAC) mixer 1, ADC channel 1 coefficient byte[31:24]
0x49	ADC_LB_MIX1_CH1_BYT2[7:0]	0xFF	Digital loopback (ADC to DAC) mixer 1, ADC channel 1 coefficient byte[23:16]
0x4A	ADC_LB_MIX1_CH1_BYT3[7:0]	0xFF	Digital loopback (ADC to DAC) mixer 1, ADC channel 1 coefficient byte[15:8]
0x4B	ADC_LB_MIX1_CH1_BYT4[7:0]	0xFF	Digital loopback (ADC to DAC) mixer 1, ADC channel 1 coefficient byte[7:0]
0x4C	ADC_LB_MIX1_CH2_BYT1[7:0]	0x00	Digital loopback (ADC to DAC) mixer 1, ADC channel 2 coefficient byte[31:24]
0x4D	ADC_LB_MIX1_CH2_BYT2[7:0]	0x00	Digital loopback (ADC to DAC) mixer 1, ADC channel 2 coefficient byte[23:16]
0x4E	ADC_LB_MIX1_CH2_BYT3[7:0]	0x00	Digital loopback (ADC to DAC) mixer 1, ADC channel 2 coefficient byte[15:8]
0x4F	ADC_LB_MIX1_CH2_BYT4[7:0]	0x00	Digital loopback (ADC to DAC) mixer 1, ADC channel 2 coefficient byte[7:0]
0x50	ADC_LB_MIX1_CH3_BYT1[7:0]	0x00	Digital loopback (ADC to DAC) mixer 1, ADC channel 3 coefficient byte[31:24]
0x51	ADC_LB_MIX1_CH3_BYT2[7:0]	0x00	Digital loopback (ADC to DAC) mixer 1, ADC channel 3 coefficient byte[23:16]
0x52	ADC_LB_MIX1_CH3_BYT3[7:0]	0x00	Digital loopback (ADC to DAC) mixer 1, ADC channel 3 coefficient byte[15:8]
0x53	ADC_LB_MIX1_CH3_BYT4[7:0]	0x00	Digital loopback (ADC to DAC) mixer 1, ADC channel 3 coefficient byte[7:0]
0x54	ADC_LB_MIX1_CH4_BYT1[7:0]	0x00	Digital loopback (ADC to DAC) mixer 1, ADC channel 4 coefficient byte[31:24]

**Table 7-205. Page 10 Programmable Coefficient Registers (continued)**

0x55	ADC_LB_MIX1_CH4_BYT2[7:0]	0x00	Digital loopback (ADC to DAC) mixer 1, ADC channel 4 coefficient byte[23:16]
0x56	ADC_LB_MIX1_CH4_BYT3[7:0]	0x00	Digital loopback (ADC to DAC) mixer 1, ADC channel 4 coefficient byte[15:8]
0x57	ADC_LB_MIX1_CH4_BYT4[7:0]	0x00	Digital loopback (ADC to DAC) mixer 1, ADC channel 4 coefficient byte[7:0]
0x58	ADC_LB_MIX2_CH1_BYT1[7:0]	0x00	Digital loopback (ADC to DAC) mixer 2, ADC channel 1 coefficient byte[31:24]
0x59	ADC_LB_MIX2_CH1_BYT2[7:0]	0x00	Digital loopback (ADC to DAC) mixer 2, ADC channel 1 coefficient byte[23:16]
0x5A	ADC_LB_MIX2_CH1_BYT3[7:0]	0x00	Digital loopback (ADC to DAC) mixer 2, ADC channel 1 coefficient byte[15:8]
0x5B	ADC_LB_MIX2_CH1_BYT4[7:0]	0x00	Digital loopback (ADC to DAC) mixer 2, ADC channel 1 coefficient byte[7:0]
0x5C	ADC_LB_MIX2_CH2_BYT1[7:0]	0x7F	Digital loopback (ADC to DAC) mixer 2, ADC channel 2 coefficient byte[31:24]
0x5D	ADC_LB_MIX2_CH2_BYT2[7:0]	0xFF	Digital loopback (ADC to DAC) mixer 2, ADC channel 2 coefficient byte[23:16]
0x5E	ADC_LB_MIX2_CH2_BYT3[7:0]	0xFF	Digital loopback (ADC to DAC) mixer 2, ADC channel 2 coefficient byte[15:8]
0x5F	ADC_LB_MIX2_CH2_BYT4[7:0]	0xFF	Digital loopback (ADC to DAC) mixer 2, ADC channel 2 coefficient byte[7:0]
0x60	ADC_LB_MIX2_CH3_BYT1[7:0]	0x00	Digital loopback (ADC to DAC) mixer 2, ADC channel 3 coefficient byte[31:24]
0x61	ADC_LB_MIX2_CH3_BYT2[7:0]	0x00	Digital loopback (ADC to DAC) mixer 2, ADC channel 3 coefficient byte[23:16]
0x62	ADC_LB_MIX2_CH3_BYT3[7:0]	0x00	Digital loopback (ADC to DAC) mixer 2, ADC channel 3 coefficient byte[15:8]
0x63	ADC_LB_MIX2_CH3_BYT4[7:0]	0x00	Digital loopback (ADC to DAC) mixer 2, ADC channel 3 coefficient byte[7:0]
0x64	ADC_LB_MIX2_CH4_BYT1[7:0]	0x00	Digital loopback (ADC to DAC) mixer 2, ADC channel 4 coefficient byte[31:24]
0x65	ADC_LB_MIX2_CH4_BYT2[7:0]	0x00	Digital loopback (ADC to DAC) mixer 2, ADC channel 4 coefficient byte[23:16]
0x66	ADC_LB_MIX2_CH4_BYT3[7:0]	0x00	Digital loopback (ADC to DAC) mixer 2, ADC channel 4 coefficient byte[15:8]
0x67	ADC_LB_MIX2_CH4_BYT4[7:0]	0x00	Digital loopback (ADC to DAC) mixer 2, ADC channel 4 coefficient byte[7:0]
0x78	ADC_IIR_N0_BYT1[7:0]	0x7F	Programmable ADC first-order IIR, N0 coefficient byte[31:24]
0x79	ADC_IIR_N0_BYT2[7:0]	0xFF	Programmable ADC first-order IIR, N0 coefficient byte[23:16]
0x7A	ADC_IIR_N0_BYT3[7:0]	0xFF	Programmable ADC first-order IIR, N0 coefficient byte[15:8]
0x7B	ADC_IIR_N0_BYT4[7:0]	0xFF	Programmable ADC first-order IIR, N0 coefficient byte[7:0]
0x7C	ADC_IIR_N1_BYT1[7:0]	0x00	Programmable ADC first-order IIR, N1 coefficient byte[31:24]
0x7D	ADC_IIR_N1_BYT2[7:0]	0x00	Programmable ADC first-order IIR, N1 coefficient byte[23:16]

**Table 7-205. Page 10 Programmable Coefficient Registers (continued)**

0x7E	ADC_IIR_N1_BYT3[7:0]	0x00	Programmable ADC first-order IIR, N1 coefficient byte[15:8]
0x7F	ADC_IIR_N1_BYT4[7:0]	0x00	Programmable ADC first-order IIR, N1 coefficient byte[7:0]

**7.2.4 Programmable Coefficient Registers: Page 11**

This register page shown in [Table 7-206](#) consists of the programmable coefficients for the ADC first-order IIR filter, ADC digital volume control and fine gain control for channels 1 to 4, ADC Auxiliary mixer and UAD filters.

**Table 7-206. Page 11 Programmable Coefficient Registers**

ADDRESS	REGISTER	RESET	DESCRIPTION
0x00	PAGE[7:0]	0x00	Device Page Register
0x08	ADC_IIR_D1_BYT1[7:0]	0x00	Programmable ADC first-order IIR, D1 coefficient byte[31:24]
0x09	ADC_IIR_D1_BYT2[7:0]	0x00	Programmable ADC first-order IIR, D1 coefficient byte[23:16]
0x0A	ADC_IIR_D1_BYT3[7:0]	0x00	Programmable ADC first-order IIR, D1 coefficient byte[15:8]
0x0B	ADC_IIR_D1_BYT4[7:0]	0x00	Programmable ADC first-order IIR, D1 coefficient byte[7:0]
0x0C	DEV_BQ_BUFSWAP_FLAG_BYT1[7:0]	0x00	Device Biquad Buffer Swap Flag coefficient byte[31:24]
0x0D	DEV_BQ_BUFSWAP_FLAG_BYT2[7:0]	0x00	Device Biquad Buffer Swap Flag coefficient byte[23:16]
0x0E	DEV_BQ_BUFSWAP_FLAG_BYT3[7:0]	0x00	Device Biquad Buffer Swap Flag coefficient byte[15:8]
0x0F	DEV_BQ_BUFSWAP_FLAG_BYT4[7:0]	0x00	Device Biquad Buffer Swap Flag coefficient byte[7:0]
0x0C	ADC_VOL_CH1_BYT1[7:0]	0x00	Digital volume control, ADC channel 1 coefficient byte[31:24]
0x0D	ADC_VOL_CH1_BYT2[7:0]	0x80	Digital volume control, ADC channel 1 coefficient byte[23:16]
0x0E	ADC_VOL_CH1_BYT3[7:0]	0x00	Digital volume control, ADC channel 1 coefficient byte[15:8]
0x0F	ADC_VOL_CH1_BYT4[7:0]	0x00	Digital volume control, ADC channel 1 coefficient byte[7:0]
0x10	ADC_VOL_CH2_BYT1[7:0]	0x00	Digital volume control, ADC channel 2 coefficient byte[31:24]
0x11	ADC_VOL_CH2_BYT2[7:0]	0x80	Digital volume control, ADC channel 2 coefficient byte[23:16]
0x12	ADC_VOL_CH2_BYT3[7:0]	0x00	Digital volume control, ADC channel 2 coefficient byte[15:8]
0x13	ADC_VOL_CH2_BYT4[7:0]	0x00	Digital volume control, ADC channel 2 coefficient byte[7:0]
0x14	ADC_VOL_CH3_BYT1[7:0]	0x00	Digital volume control, ADC channel 3 coefficient byte[31:24]
0x15	ADC_VOL_CH3_BYT2[7:0]	0x80	Digital volume control, ADC channel 3 coefficient byte[23:16]
0x16	ADC_VOL_CH3_BYT3[7:0]	0x00	Digital volume control, ADC channel 3 coefficient byte[15:8]
0x17	ADC_VOL_CH3_BYT4[7:0]	0x00	Digital volume control, ADC channel 3 coefficient byte[7:0]
0x18	ADC_VOL_CH4_BYT1[7:0]	0x00	Digital volume control, ADC channel 4 coefficient byte[31:24]
0x19	ADC_VOL_CH4_BYT2[7:0]	0x80	Digital volume control, ADC channel 4 coefficient byte[23:16]
0x1A	ADC_VOL_CH4_BYT3[7:0]	0x00	Digital volume control, ADC channel 4 coefficient byte[15:8]
0x1F	ADC_VOL_CH4_BYT4[7:0]	0x00	Digital volume control, ADC channel 4 coefficient byte[7:0]
0x20	ADC_SF2_CH1_BYT1[7:0]	0x40	Digital SF2 (fine gain) control, ADC channel 1 coefficient byte[31:24]
0x21	ADC_SF2_CH1_BYT2[7:0]	0x00	Digital SF2 (fine gain) control, ADC channel 1 coefficient byte[23:16]
0x22	ADC_SF2_CH1_BYT3[7:0]	0x00	Digital SF2 (fine gain) control, ADC channel 1 coefficient byte[15:8]
0x23	ADC_SF2_CH1_BYT4[7:0]	0x00	Digital SF2 (fine gain) control, ADC channel 1 coefficient byte[7:0]
0x24	ADC_SF2_CH2_BYT1[7:0]	0x40	Digital SF2 (fine gain) control, ADC channel 2 coefficient byte[31:24]

**Table 7-206. Page 11 Programmable Coefficient Registers (continued)**

0x25	ADC_SF2_CH2_BYT2[7:0]	0x00	Digital SF2 (fine gain) control, ADC channel 2 coefficient byte[23:16]
0x26	ADC_SF2_CH2_BYT3[7:0]	0x00	Digital SF2 (fine gain) control, ADC channel 2 coefficient byte[15:8]
0x27	ADC_SF2_CH2_BYT4[7:0]	0x00	Digital SF2 (fine gain) control, ADC channel 2 coefficient byte[7:0]
0x28	ADC_SF2_CH3_BYT1[7:0]	0x40	Digital SF2 (fine gain) control, ADC channel 3 coefficient byte[31:24]
0x29	ADC_SF2_CH3_BYT2[7:0]	0x00	Digital SF2 (fine gain) control, ADC channel 3 coefficient byte[23:16]
0x2A	ADC_SF2_CH3_BYT3[7:0]	0x00	Digital SF2 (fine gain) control, ADC channel 3 coefficient byte[15:8]
0x2B	ADC_SF2_CH3_BYT4[7:0]	0x00	Digital SF2 (fine gain) control, ADC channel 3 coefficient byte[7:0]
0x2C	ADC_SF2_CH4_BYT1[7:0]	0x40	Digital SF2 (fine gain) control, ADC channel 4 coefficient byte[31:24]
0x2D	ADC_SF2_CH4_BYT2[7:0]	0x00	Digital SF2 (fine gain) control, ADC channel 4 coefficient byte[23:16]
0x2E	ADC_SF2_CH4_BYT3[7:0]	0x00	Digital SF2 (fine gain) control, ADC channel 4 coefficient byte[15:8]
0x2F	ADC_SF2_CH4_BYT4[7:0]	0x00	Digital SF2 (fine gain) control, ADC channel 4 coefficient byte[7:0]
0x30	ADC_AUX_MIX_CH1_BYT1[7:0]	0x00	ADC Auxiliary Mixer CH1 coefficient byte[31:24]
0x31	ADC_AUX_MIX_CH1_BYT2[7:0]	0x00	ADC Auxiliary Mixer CH1 coefficient byte[23:16]
0x32	ADC_AUX_MIX_CH1_BYT3[7:0]	0x00	ADC Auxiliary Mixer CH1 coefficient byte[15:8]
0x33	ADC_AUX_MIX_CH1_BYT4[7:0]	0x00	ADC Auxiliary Mixer CH1 coefficient byte[7:0]
0x34	ADC_AUX_MIX_CH2_BYT1[7:0]	0x00	ADC Auxiliary Mixer CH2 coefficient byte[31:24]
0x35	ADC_AUX_MIX_CH2_BYT2[7:0]	0x00	ADC Auxiliary Mixer CH2 coefficient byte[23:16]
0x36	ADC_AUX_MIX_CH2_BYT3[7:0]	0x00	ADC Auxiliary Mixer CH2 coefficient byte[15:8]
0x37	ADC_AUX_MIX_CH2_BYT4[7:0]	0x00	ADC Auxiliary Mixer CH2 coefficient byte[7:0]
0x68	ADC_UAD_BPF_B0_BYT1[7:0]	0x07	UAD BQ B0 Coefficient [31:24]
0x69	ADC_UAD_BPF_B0_BYT2[7:0]	0xDF	UAD BQ B0 Coefficient [23:16]
0x6A	ADC_UAD_BPF_B0_BYT3[7:0]	0x9E	UAD BQ B0 Coefficient[15:8]
0x6B	ADC_UAD_BPF_B0_BYT4[7:0]	0x1D	UAD BQ B0 Coefficient[7:0]
0x6C	ADC_UAD_BPF_B1_BYT1[7:0]	0x00	UAD BQ B1 Coefficient [31:24]
0x6D	ADC_UAD_BPF_B1_BYT2[7:0]	0x00	UAD BQ B1 Coefficient [23:16]
0x6E	ADC_UAD_BPF_B1_BYT3[7:0]	0x00	UAD BQ B1 Coefficient[15:8]
0x6F	ADC_UAD_BPF_B1_BYT4[7:0]	0x00	UAD BQ B1 Coefficient [7:0]
0x70	ADC_UAD_BPF_B2_BYT1[7:0]	0xF8	UAD BQ B2 Coefficient [31:24]
0x71	ADC_UAD_BPF_B2_BYT2[7:0]	0x20	UAD BQ B2 Coefficient [23:16]
0x72	ADC_UAD_BPF_B2_BYT3[7:0]	0x61	UAD BQ B2 Coefficient[15:8]
0x73	ADC_UAD_BPF_B2_BYT4[7:0]	0xE2	UAD BQ B2 Coefficient[7:0]
0x74	ADC_UAD_BPF_A1_BYT1[7:0]	0x3C	UAD BQ A1 Coefficient [31:24]
0x75	ADC_UAD_BPF_A1_BYT2[7:0]	0x31	UAD BQ A1 Coefficient [23:16]

**Table 7-206. Page 11 Programmable Coefficient Registers (continued)**

0x76	ADC_UAD_BPF_A1_BYT3[7:0]	0x2E	UAD BQ A1 Coefficient[15:8]
0x77	ADC_UAD_BPF_A1_BYT4[7:0]	0xF5	UAD BQ A1 Coefficient[7:0]
0x78	ADC_UAD_BPF_A2_BYT1[7:0]	0x70	UAD BQ A2 Coefficient [31:24]
0x79	ADC_UAD_BPF_A2_BYT2[7:0]	0x40	UAD BQ A2 Coefficient [23:16]
0x7A	ADC_UAD_BPF_A2_BYT3[7:0]	0xC3	UAD BQ A2 Coefficient[15:8]
0x7B	ADC_UAD_BPF_A2_BYT4[7:0]	0xC5	UAD BQ A2 Coefficient[7:0]

**7.2.5 Programmable Coefficient Registers: Page 15**

This register page shown in [Table 7-207](#) consists of the programmable coefficients for the DAC biquad 1 to biquad 6 filters.

**Table 7-207. Page 15 Programmable Coefficient Registers**

ADDRESS	REGISTER	RESET	DESCRIPTION
0x00	PAGE[7:0]	0x00	Device Page Register
0x08	DAC_BQ1_N0_BYT1[7:0]	0x7F	Programmable DAC biquad 1, N0 coefficient byte[31:24]
0x09	DAC_BQ1_N0_BYT2[7:0]	0xFF	Programmable DAC biquad 1, N0 coefficient byte[23:16]
0x0A	DAC_BQ1_N0_BYT3[7:0]	0xFF	Programmable DAC biquad 1, N0 coefficient byte[15:8]
0x0B	DAC_BQ1_N0_BYT4[7:0]	0xFF	Programmable DAC biquad 1, N0 coefficient byte[7:0]
0x0C	DAC_BQ1_N1_BYT1[7:0]	0x00	Programmable DAC biquad 1, N1 coefficient byte[31:24]
0x0D	DAC_BQ1_N1_BYT2[7:0]	0x00	Programmable DAC biquad 1, N1 coefficient byte[23:16]
0x0E	DAC_BQ1_N1_BYT3[7:0]	0x00	Programmable DAC biquad 1, N1 coefficient byte[15:8]
0x0F	DAC_BQ1_N1_BYT4[7:0]	0x00	Programmable DAC biquad 1, N1 coefficient byte[7:0]
0x10	DAC_BQ1_N2_BYT1[7:0]	0x00	Programmable DAC biquad 1, N2 coefficient byte[31:24]
0x11	DAC_BQ1_N2_BYT2[7:0]	0x00	Programmable DAC biquad 1, N2 coefficient byte[23:16]
0x12	DAC_BQ1_N2_BYT3[7:0]	0x00	Programmable DAC biquad 1, N2 coefficient byte[15:8]
0x13	DAC_BQ1_N2_BYT4[7:0]	0x00	Programmable DAC biquad 1, N2 coefficient byte[7:0]
0x14	DAC_BQ1_D1_BYT1[7:0]	0x00	Programmable DAC biquad 1, D1 coefficient byte[31:24]
0x15	DAC_BQ1_D1_BYT2[7:0]	0x00	Programmable DAC biquad 1, D1 coefficient byte[23:16]
0x16	DAC_BQ1_D1_BYT3[7:0]	0x00	Programmable DAC biquad 1, D1 coefficient byte[15:8]
0x17	DAC_BQ1_D1_BYT4[7:0]	0x00	Programmable DAC biquad 1, D1 coefficient byte[7:0]
0x18	DAC_BQ1_D2_BYT1[7:0]	0x00	Programmable DAC biquad 1, D2 coefficient byte[31:24]
0x19	DAC_BQ1_D2_BYT2[7:0]	0x00	Programmable DAC biquad 1, D2 coefficient byte[23:16]
0x1A	DAC_BQ1_D2_BYT3[7:0]	0x00	Programmable DAC biquad 1, D2 coefficient byte[15:8]
0x1B	DAC_BQ1_D2_BYT4[7:0]	0x00	Programmable DAC biquad 1, D2 coefficient byte[7:0]
0x1C	DAC_BQ2_N0_BYT1[7:0]	0x7F	Programmable DAC biquad 2, N0 coefficient byte[31:24]
0x1D	DAC_BQ2_N0_BYT2[7:0]	0xFF	Programmable DAC biquad 2, N0 coefficient byte[23:16]
0x1E	DAC_BQ2_N0_BYT3[7:0]	0xFF	Programmable DAC biquad 2, N0 coefficient byte[15:8]
0x1F	DAC_BQ2_N0_BYT4[7:0]	0xFF	Programmable DAC biquad 2, N0 coefficient byte[7:0]
0x20	DAC_BQ2_N1_BYT1[7:0]	0x00	Programmable DAC biquad 2, N1 coefficient byte[31:24]
0x21	DAC_BQ2_N1_BYT2[7:0]	0x00	Programmable DAC biquad 2, N1 coefficient byte[23:16]
0x22	DAC_BQ2_N1_BYT3[7:0]	0x00	Programmable DAC biquad 2, N1 coefficient byte[15:8]
0x23	DAC_BQ2_N1_BYT4[7:0]	0x00	Programmable DAC biquad 2, N1 coefficient byte[7:0]
0x24	DAC_BQ2_N2_BYT1[7:0]	0x00	Programmable DAC biquad 2, N2 coefficient byte[31:24]
0x25	DAC_BQ2_N2_BYT2[7:0]	0x00	Programmable DAC biquad 2, N2 coefficient byte[23:16]
0x26	DAC_BQ2_N2_BYT3[7:0]	0x00	Programmable DAC biquad 2, N2 coefficient byte[15:8]
0x27	DAC_BQ2_N2_BYT4[7:0]	0x00	Programmable DAC biquad 2, N2 coefficient byte[7:0]
0x28	DAC_BQ2_D1_BYT1[7:0]	0x00	Programmable DAC biquad 2, D1 coefficient byte[31:24]



**Table 7-207. Page 15 Programmable Coefficient Registers (continued)**

0x29	DAC_BQ2_D1_BYT2[7:0]	0x00	Programmable DAC biquad 2, D1 coefficient byte[23:16]
0x2A	DAC_BQ2_D1_BYT3[7:0]	0x00	Programmable DAC biquad 2, D1 coefficient byte[15:8]
0x2B	DAC_BQ2_D1_BYT4[7:0]	0x00	Programmable DAC biquad 2, D1 coefficient byte[7:0]
0x2C	DAC_BQ2_D2_BYT1[7:0]	0x00	Programmable DAC biquad 2, D2 coefficient byte[31:24]
0x2D	DAC_BQ2_D2_BYT2[7:0]	0x00	Programmable DAC biquad 2, D2 coefficient byte[23:16]
0x2E	DAC_BQ2_D2_BYT3[7:0]	0x00	Programmable DAC biquad 2, D2 coefficient byte[15:8]
0x2F	DAC_BQ2_D2_BYT4[7:0]	0x00	Programmable DAC biquad 2, D2 coefficient byte[7:0]
0x30	DAC_BQ3_N0_BYT1[7:0]	0x7F	Programmable DAC biquad 3, N0 coefficient byte[31:24]
0x31	DAC_BQ3_N0_BYT2[7:0]	0xFF	Programmable DAC biquad 3, N0 coefficient byte[23:16]
0x32	DAC_BQ3_N0_BYT3[7:0]	0xFF	Programmable DAC biquad 3, N0 coefficient byte[15:8]
0x33	DAC_BQ3_N0_BYT4[7:0]	0xFF	Programmable DAC biquad 3, N0 coefficient byte[7:0]
0x34	DAC_BQ3_N1_BYT1[7:0]	0x00	Programmable DAC biquad 3, N1 coefficient byte[31:24]
0x35	DAC_BQ3_N1_BYT2[7:0]	0x00	Programmable DAC biquad 3, N1 coefficient byte[23:16]
0x36	DAC_BQ3_N1_BYT3[7:0]	0x00	Programmable DAC biquad 3, N1 coefficient byte[15:8]
0x37	DAC_BQ3_N1_BYT4[7:0]	0x00	Programmable DAC biquad 3, N1 coefficient byte[7:0]
0x38	DAC_BQ3_N2_BYT1[7:0]	0x00	Programmable DAC biquad 3, N2 coefficient byte[31:24]
0x39	DAC_BQ3_N2_BYT2[7:0]	0x00	Programmable DAC biquad 3, N2 coefficient byte[23:16]
0x3A	DAC_BQ3_N2_BYT3[7:0]	0x00	Programmable DAC biquad 3, N2 coefficient byte[15:8]
0x3B	DAC_BQ3_N2_BYT4[7:0]	0x00	Programmable DAC biquad 3, N2 coefficient byte[7:0]
0x3C	DAC_BQ3_D1_BYT1[7:0]	0x00	Programmable DAC biquad 3, D1 coefficient byte[31:24]
0x3D	DAC_BQ3_D1_BYT2[7:0]	0x00	Programmable DAC biquad 3, D1 coefficient byte[23:16]
0x3E	DAC_BQ3_D1_BYT3[7:0]	0x00	Programmable DAC biquad 3, D1 coefficient byte[15:8]
0x3F	DAC_BQ3_D1_BYT4[7:0]	0x00	Programmable DAC biquad 3, D1 coefficient byte[7:0]
0x40	DAC_BQ3_D2_BYT1[7:0]	0x00	Programmable DAC biquad 3, D2 coefficient byte[31:24]
0x41	DAC_BQ3_D2_BYT2[7:0]	0x00	Programmable DAC biquad 3, D2 coefficient byte[23:16]
0x42	DAC_BQ3_D2_BYT3[7:0]	0x00	Programmable DAC biquad 3, D2 coefficient byte[15:8]
0x43	DAC_BQ3_D2_BYT4[7:0]	0x00	Programmable DAC biquad 3, D2 coefficient byte[7:0]
0x44	DAC_BQ4_N0_BYT1[7:0]	0x7F	Programmable DAC biquad 4, N0 coefficient byte[31:24]
0x45	DAC_BQ4_N0_BYT2[7:0]	0xFF	Programmable DAC biquad 4, N0 coefficient byte[23:16]
0x46	DAC_BQ4_N0_BYT3[7:0]	0xFF	Programmable DAC biquad 4, N0 coefficient byte[15:8]
0x47	DAC_BQ4_N0_BYT4[7:0]	0xFF	Programmable DAC biquad 4, N0 coefficient byte[7:0]
0x48	DAC_BQ4_N1_BYT1[7:0]	0x00	Programmable DAC biquad 4, N1 coefficient byte[31:24]
0x49	DAC_BQ4_N1_BYT2[7:0]	0x00	Programmable DAC biquad 4, N1 coefficient byte[23:16]
0x4A	DAC_BQ4_N1_BYT3[7:0]	0x00	Programmable DAC biquad 4, N1 coefficient byte[15:8]
0x4B	DAC_BQ4_N1_BYT4[7:0]	0x00	Programmable DAC biquad 4, N1 coefficient byte[7:0]
0x4C	DAC_BQ4_N2_BYT1[7:0]	0x00	Programmable DAC biquad 4, N2 coefficient byte[31:24]
0x4D	DAC_BQ4_N2_BYT2[7:0]	0x00	Programmable DAC biquad 4, N2 coefficient byte[23:16]
0x4E	DAC_BQ4_N2_BYT3[7:0]	0x00	Programmable DAC biquad 4, N2 coefficient byte[15:8]
0x4F	DAC_BQ4_N2_BYT4[7:0]	0x00	Programmable DAC biquad 4, N2 coefficient byte[7:0]
0x50	DAC_BQ4_D1_BYT1[7:0]	0x00	Programmable DAC biquad 4, D1 coefficient byte[31:24]
0x51	DAC_BQ4_D1_BYT2[7:0]	0x00	Programmable DAC biquad 4, D1 coefficient byte[23:16]
0x52	DAC_BQ4_D1_BYT3[7:0]	0x00	Programmable DAC biquad 4, D1 coefficient byte[15:8]
0x53	DAC_BQ4_D1_BYT4[7:0]	0x00	Programmable DAC biquad 4, D1 coefficient byte[7:0]
0x54	DAC_BQ4_D2_BYT1[7:0]	0x00	Programmable DAC biquad 4, D2 coefficient byte[31:24]
0x55	DAC_BQ4_D2_BYT2[7:0]	0x00	Programmable DAC biquad 4, D2 coefficient byte[23:16]
0x56	DAC_BQ4_D2_BYT3[7:0]	0x00	Programmable DAC biquad 4, D2 coefficient byte[15:8]

**Table 7-207. Page 15 Programmable Coefficient Registers (continued)**

0x57	DAC_BQ4_D2_BYT4[7:0]	0x00	Programmable DAC biquad 4, D2 coefficient byte[7:0]
0x58	DAC_BQ5_N0_BYT1[7:0]	0x7F	Programmable DAC biquad 5, N0 coefficient byte[31:24]
0x59	DAC_BQ5_N0_BYT2[7:0]	0xFF	Programmable DAC biquad 5, N0 coefficient byte[23:16]
0x5A	DAC_BQ5_N0_BYT3[7:0]	0xFF	Programmable DAC biquad 5, N0 coefficient byte[15:8]
0x5B	DAC_BQ5_N0_BYT4[7:0]	0xFF	Programmable DAC biquad 5, N0 coefficient byte[7:0]
0x5C	DAC_BQ5_N1_BYT1[7:0]	0x00	Programmable DAC biquad 5, N1 coefficient byte[31:24]
0x5D	DAC_BQ5_N1_BYT2[7:0]	0x00	Programmable DAC biquad 5, N1 coefficient byte[23:16]
0x5E	DAC_BQ5_N1_BYT3[7:0]	0x00	Programmable DAC biquad 5, N1 coefficient byte[15:8]
0x5F	DAC_BQ5_N1_BYT4[7:0]	0x00	Programmable DAC biquad 5, N1 coefficient byte[7:0]
0x60	DAC_BQ5_N2_BYT1[7:0]	0x00	Programmable DAC biquad 5, N2 coefficient byte[31:24]
0x61	DAC_BQ5_N2_BYT2[7:0]	0x00	Programmable DAC biquad 5, N2 coefficient byte[23:16]
0x62	DAC_BQ5_N2_BYT3[7:0]	0x00	Programmable DAC biquad 5, N2 coefficient byte[15:8]
0x63	DAC_BQ5_N2_BYT4[7:0]	0x00	Programmable DAC biquad 5, N2 coefficient byte[7:0]
0x64	DAC_BQ5_D1_BYT1[7:0]	0x00	Programmable DAC biquad 5, D1 coefficient byte[31:24]
0x65	DAC_BQ5_D1_BYT2[7:0]	0x00	Programmable DAC biquad 5, D1 coefficient byte[23:16]
0x66	DAC_BQ5_D1_BYT3[7:0]	0x00	Programmable DAC biquad 5, D1 coefficient byte[15:8]
0x67	DAC_BQ5_D1_BYT4[7:0]	0x00	Programmable DAC biquad 5, D1 coefficient byte[7:0]
0x68	DAC_BQ5_D2_BYT1[7:0]	0x00	Programmable DAC biquad 5, D2 coefficient byte[31:24]
0x69	DAC_BQ5_D2_BYT2[7:0]	0x00	Programmable DAC biquad 5, D2 coefficient byte[23:16]
0x6A	DAC_BQ5_D2_BYT3[7:0]	0x00	Programmable DAC biquad 5, D2 coefficient byte[15:8]
0x6B	DAC_BQ5_D2_BYT4[7:0]	0x00	Programmable DAC biquad 5, D2 coefficient byte[7:0]
0x6C	DAC_BQ6_N0_BYT1[7:0]	0x7F	Programmable DAC biquad 6, N0 coefficient byte[31:24]
0x6D	DAC_BQ6_N0_BYT2[7:0]	0xFF	Programmable DAC biquad 6, N0 coefficient byte[23:16]
0x6E	DAC_BQ6_N0_BYT3[7:0]	0xFF	Programmable DAC biquad 6, N0 coefficient byte[15:8]
0x6F	DAC_BQ6_N0_BYT4[7:0]	0xFF	Programmable DAC biquad 6, N0 coefficient byte[7:0]
0x70	DAC_BQ6_N1_BYT1[7:0]	0x00	Programmable DAC biquad 6, N1 coefficient byte[31:24]
0x71	DAC_BQ6_N1_BYT2[7:0]	0x00	Programmable DAC biquad 6, N1 coefficient byte[23:16]
0x72	DAC_BQ6_N1_BYT3[7:0]	0x00	Programmable DAC biquad 6, N1 coefficient byte[15:8]
0x73	DAC_BQ6_N1_BYT4[7:0]	0x00	Programmable DAC biquad 6, N1 coefficient byte[7:0]
0x74	DAC_BQ6_N2_BYT1[7:0]	0x00	Programmable DAC biquad 6, N2 coefficient byte[31:24]
0x75	DAC_BQ6_N2_BYT2[7:0]	0x00	Programmable DAC biquad 6, N2 coefficient byte[23:16]
0x76	DAC_BQ6_N2_BYT3[7:0]	0x00	Programmable DAC biquad 6, N2 coefficient byte[15:8]
0x77	DAC_BQ6_N2_BYT4[7:0]	0x00	Programmable DAC biquad 6, N2 coefficient byte[7:0]
0x78	DAC_BQ6_D1_BYT1[7:0]	0x00	Programmable DAC biquad 6, D1 coefficient byte[31:24]
0x79	DAC_BQ6_D1_BYT2[7:0]	0x00	Programmable DAC biquad 6, D1 coefficient byte[23:16]
0x7A	DAC_BQ6_D1_BYT3[7:0]	0x00	Programmable DAC biquad 6, D1 coefficient byte[15:8]
0x7B	DAC_BQ6_D1_BYT4[7:0]	0x00	Programmable DAC biquad 6, D1 coefficient byte[7:0]
0x7C	DAC_BQ6_D2_BYT1[7:0]	0x00	Programmable DAC biquad 6, D2 coefficient byte[31:24]
0x7D	DAC_BQ6_D2_BYT2[7:0]	0x00	Programmable DAC biquad 6, D2 coefficient byte[23:16]
0x7E	DAC_BQ6_D2_BYT3[7:0]	0x00	Programmable DAC biquad 6, D2 coefficient byte[15:8]
0x7F	DAC_BQ6_D2_BYT4[7:0]	0x00	Programmable DAC biquad 6, D2 coefficient byte[7:0]

**7.2.6 Programmable Coefficient Registers: Page 16**

This register page shown in [Section 7.2.6](#) consists of the programmable coefficients for the DAC biquad 7 to biquad 12 filters.

**Table 7-208. Page 16 Programmable Coefficient Registers**

ADDRESS	REGISTER	RESET	DESCRIPTION
0x00	PAGE[7:0]	0x00	Device Page Register
0x08	DAC_BQ7_N0_BYT1[7:0]	0x7F	Programmable DAC biquad 7, N0 coefficient byte[31:24]
0x09	DAC_BQ7_N0_BYT2[7:0]	0xFF	Programmable DAC biquad 7, N0 coefficient byte[23:16]
0x0A	DAC_BQ7_N0_BYT3[7:0]	0xFF	Programmable DAC biquad 7, N0 coefficient byte[15:8]
0x0B	DAC_BQ7_N0_BYT4[7:0]	0xFF	Programmable DAC biquad 7, N0 coefficient byte[7:0]
0x0C	DAC_BQ7_N1_BYT1[7:0]	0x00	Programmable DAC biquad 7, N1 coefficient byte[31:24]
0x0D	DAC_BQ7_N1_BYT2[7:0]	0x00	Programmable DAC biquad 7, N1 coefficient byte[23:16]
0x0E	DAC_BQ7_N1_BYT3[7:0]	0x00	Programmable DAC biquad 7, N1 coefficient byte[15:8]
0x0F	DAC_BQ7_N1_BYT4[7:0]	0x00	Programmable DAC biquad 7, N1 coefficient byte[7:0]
0x10	DAC_BQ7_N2_BYT1[7:0]	0x00	Programmable DAC biquad 7, N2 coefficient byte[31:24]
0x11	DAC_BQ7_N2_BYT2[7:0]	0x00	Programmable DAC biquad 7, N2 coefficient byte[23:16]
0x12	DAC_BQ7_N2_BYT3[7:0]	0x00	Programmable DAC biquad 7, N2 coefficient byte[15:8]
0x13	DAC_BQ7_N2_BYT4[7:0]	0x00	Programmable DAC biquad 7, N2 coefficient byte[7:0]
0x14	DAC_BQ7_D1_BYT1[7:0]	0x00	Programmable DAC biquad 7, D1 coefficient byte[31:24]
0x15	DAC_BQ7_D1_BYT2[7:0]	0x00	Programmable DAC biquad 7, D1 coefficient byte[23:16]
0x16	DAC_BQ7_D1_BYT3[7:0]	0x00	Programmable DAC biquad 7, D1 coefficient byte[15:8]
0x17	DAC_BQ7_D1_BYT4[7:0]	0x00	Programmable DAC biquad 7, D1 coefficient byte[7:0]
0x18	DAC_BQ7_D2_BYT1[7:0]	0x00	Programmable DAC biquad 7, D2 coefficient byte[31:24]
0x19	DAC_BQ7_D2_BYT2[7:0]	0x00	Programmable DAC biquad 7, D2 coefficient byte[23:16]
0x1A	DAC_BQ7_D2_BYT3[7:0]	0x00	Programmable DAC biquad 7, D2 coefficient byte[15:8]
0x1B	DAC_BQ7_D2_BYT4[7:0]	0x00	Programmable DAC biquad 7, D2 coefficient byte[7:0]
0x1C	DAC_BQ8_N0_BYT1[7:0]	0x7F	Programmable DAC biquad 8, N0 coefficient byte[31:24]
0x1D	DAC_BQ8_N0_BYT2[7:0]	0xFF	Programmable DAC biquad 8, N0 coefficient byte[23:16]
0x1E	DAC_BQ8_N0_BYT3[7:0]	0xFF	Programmable DAC biquad 8, N0 coefficient byte[15:8]
0x1F	DAC_BQ8_N0_BYT4[7:0]	0xFF	Programmable DAC biquad 8, N0 coefficient byte[7:0]
0x20	DAC_BQ8_N1_BYT1[7:0]	0x00	Programmable DAC biquad 8, N1 coefficient byte[31:24]
0x21	DAC_BQ8_N1_BYT2[7:0]	0x00	Programmable DAC biquad 8, N1 coefficient byte[23:16]
0x22	DAC_BQ8_N1_BYT3[7:0]	0x00	Programmable DAC biquad 8, N1 coefficient byte[15:8]
0x23	DAC_BQ8_N1_BYT4[7:0]	0x00	Programmable DAC biquad 8, N1 coefficient byte[7:0]
0x24	DAC_BQ8_N2_BYT1[7:0]	0x00	Programmable DAC biquad 8, N2 coefficient byte[31:24]
0x25	DAC_BQ8_N2_BYT2[7:0]	0x00	Programmable DAC biquad 8, N2 coefficient byte[23:16]
0x26	DAC_BQ8_N2_BYT3[7:0]	0x00	Programmable DAC biquad 8, N2 coefficient byte[15:8]
0x27	DAC_BQ8_N2_BYT4[7:0]	0x00	Programmable DAC biquad 8, N2 coefficient byte[7:0]
0x28	DAC_BQ8_D1_BYT1[7:0]	0x00	Programmable DAC biquad 8, D1 coefficient byte[31:24]
0x29	DAC_BQ8_D1_BYT2[7:0]	0x00	Programmable DAC biquad 8, D1 coefficient byte[23:16]
0x2A	DAC_BQ8_D1_BYT3[7:0]	0x00	Programmable DAC biquad 8, D1 coefficient byte[15:8]
0x2B	DAC_BQ8_D1_BYT4[7:0]	0x00	Programmable DAC biquad 8, D1 coefficient byte[7:0]
0x2C	DAC_BQ8_D2_BYT1[7:0]	0x00	Programmable DAC biquad 8, D2 coefficient byte[31:24]
0x2D	DAC_BQ8_D2_BYT2[7:0]	0x00	Programmable DAC biquad 8, D2 coefficient byte[23:16]
0x2E	DAC_BQ8_D2_BYT3[7:0]	0x00	Programmable DAC biquad 8, D2 coefficient byte[15:8]
0x2F	DAC_BQ8_D2_BYT4[7:0]	0x00	Programmable DAC biquad 8, D2 coefficient byte[7:0]
0x30	DAC_BQ9_N0_BYT1[7:0]	0x7F	Programmable DAC biquad 9, N0 coefficient byte[31:24]
0x31	DAC_BQ9_N0_BYT2[7:0]	0xFF	Programmable DAC biquad 9, N0 coefficient byte[23:16]
0x32	DAC_BQ9_N0_BYT3[7:0]	0xFF	Programmable DAC biquad 9, N0 coefficient byte[15:8]
0x33	DAC_BQ9_N0_BYT4[7:0]	0xFF	Programmable DAC biquad 9, N0 coefficient byte[7:0]

**Table 7-208. Page 16 Programmable Coefficient Registers (continued)**

0x34	DAC_BQ9_N1_BYT1[7:0]	0x00	Programmable DAC biquad 9, N1 coefficient byte[31:24]
0x35	DAC_BQ9_N1_BYT2[7:0]	0x00	Programmable DAC biquad 9, N1 coefficient byte[23:16]
0x36	DAC_BQ9_N1_BYT3[7:0]	0x00	Programmable DAC biquad 9, N1 coefficient byte[15:8]
0x37	DAC_BQ9_N1_BYT4[7:0]	0x00	Programmable DAC biquad 9, N1 coefficient byte[7:0]
0x38	DAC_BQ9_N2_BYT1[7:0]	0x00	Programmable DAC biquad 9, N2 coefficient byte[31:24]
0x39	DAC_BQ9_N2_BYT2[7:0]	0x00	Programmable DAC biquad 9, N2 coefficient byte[23:16]
0x3A	DAC_BQ9_N2_BYT3[7:0]	0x00	Programmable DAC biquad 9, N2 coefficient byte[15:8]
0x3B	DAC_BQ9_N2_BYT4[7:0]	0x00	Programmable DAC biquad 9, N2 coefficient byte[7:0]
0x3C	DAC_BQ9_D1_BYT1[7:0]	0x00	Programmable DAC biquad 9, D1 coefficient byte[31:24]
0x3D	DAC_BQ9_D1_BYT2[7:0]	0x00	Programmable DAC biquad 9, D1 coefficient byte[23:16]
0x3E	DAC_BQ9_D1_BYT3[7:0]	0x00	Programmable DAC biquad 9, D1 coefficient byte[15:8]
0x3F	DAC_BQ9_D1_BYT4[7:0]	0x00	Programmable DAC biquad 9, D1 coefficient byte[7:0]
0x40	DAC_BQ9_D2_BYT1[7:0]	0x00	Programmable DAC biquad 9, D2 coefficient byte[31:24]
0x41	DAC_BQ9_D2_BYT2[7:0]	0x00	Programmable DAC biquad 9, D2 coefficient byte[23:16]
0x42	DAC_BQ9_D2_BYT3[7:0]	0x00	Programmable DAC biquad 9, D2 coefficient byte[15:8]
0x43	DAC_BQ9_D2_BYT4[7:0]	0x00	Programmable DAC biquad 9, D2 coefficient byte[7:0]
0x44	DAC_BQ10_N0_BYT1[7:0]	0x7F	Programmable DAC biquad 10, N0 coefficient byte[31:24]
0x45	DAC_BQ10_N0_BYT2[7:0]	0xFF	Programmable DAC biquad 10, N0 coefficient byte[23:16]
0x46	DAC_BQ10_N0_BYT3[7:0]	0xFF	Programmable DAC biquad 10, N0 coefficient byte[15:8]
0x47	DAC_BQ10_N0_BYT4[7:0]	0xFF	Programmable DAC biquad 10, N0 coefficient byte[7:0]
0x48	DAC_BQ10_N1_BYT1[7:0]	0x00	Programmable DAC biquad 10, N1 coefficient byte[31:24]
0x49	DAC_BQ10_N1_BYT2[7:0]	0x00	Programmable DAC biquad 10, N1 coefficient byte[23:16]
0x4A	DAC_BQ10_N1_BYT3[7:0]	0x00	Programmable DAC biquad 10, N1 coefficient byte[15:8]
0x4B	DAC_BQ10_N1_BYT4[7:0]	0x00	Programmable DAC biquad 10, N1 coefficient byte[7:0]
0x4C	DAC_BQ10_N2_BYT1[7:0]	0x00	Programmable DAC biquad 10, N2 coefficient byte[31:24]
0x4D	DAC_BQ10_N2_BYT2[7:0]	0x00	Programmable DAC biquad 10, N2 coefficient byte[23:16]
0x4E	DAC_BQ10_N2_BYT3[7:0]	0x00	Programmable DAC biquad 10, N2 coefficient byte[15:8]
0x4F	DAC_BQ10_N2_BYT4[7:0]	0x00	Programmable DAC biquad 10, N2 coefficient byte[7:0]
0x50	DAC_BQ10_D1_BYT1[7:0]	0x00	Programmable DAC biquad 10, D1 coefficient byte[31:24]
0x51	DAC_BQ10_D1_BYT2[7:0]	0x00	Programmable DAC biquad 10, D1 coefficient byte[23:16]
0x52	DAC_BQ10_D1_BYT3[7:0]	0x00	Programmable DAC biquad 10, D1 coefficient byte[15:8]
0x53	DAC_BQ10_D1_BYT4[7:0]	0x00	Programmable DAC biquad 10, D1 coefficient byte[7:0]
0x54	DAC_BQ10_D2_BYT1[7:0]	0x00	Programmable DAC biquad 10, D2 coefficient byte[31:24]
0x55	DAC_BQ10_D2_BYT2[7:0]	0x00	Programmable DAC biquad 10, D2 coefficient byte[23:16]
0x56	DAC_BQ10_D2_BYT3[7:0]	0x00	Programmable DAC biquad 10, D2 coefficient byte[15:8]
0x57	DAC_BQ10_D2_BYT4[7:0]	0x00	Programmable DAC biquad 10, D2 coefficient byte[7:0]
0x58	DAC_BQ11_N0_BYT1[7:0]	0x7F	Programmable DAC biquad 11, N0 coefficient byte[31:24]
0x59	DAC_BQ11_N0_BYT2[7:0]	0xFF	Programmable DAC biquad 11, N0 coefficient byte[23:16]
0x5A	DAC_BQ11_N0_BYT3[7:0]	0xFF	Programmable DAC biquad 11, N0 coefficient byte[15:8]
0x5B	DAC_BQ11_N0_BYT4[7:0]	0xFF	Programmable DAC biquad 11, N0 coefficient byte[7:0]
0x5C	DAC_BQ11_N1_BYT1[7:0]	0x00	Programmable DAC biquad 11, N1 coefficient byte[31:24]
0x5D	DAC_BQ11_N1_BYT2[7:0]	0x00	Programmable DAC biquad 11, N1 coefficient byte[23:16]
0x5E	DAC_BQ11_N1_BYT3[7:0]	0x00	Programmable DAC biquad 11, N1 coefficient byte[15:8]
0x5F	DAC_BQ11_N1_BYT4[7:0]	0x00	Programmable DAC biquad 11, N1 coefficient byte[7:0]
0x60	DAC_BQ11_N2_BYT1[7:0]	0x00	Programmable DAC biquad 11, N2 coefficient byte[31:24]
0x61	DAC_BQ11_N2_BYT2[7:0]	0x00	Programmable DAC biquad 11, N2 coefficient byte[23:16]

**Table 7-208. Page 16 Programmable Coefficient Registers (continued)**

0x62	DAC_BQ11_N2_BYT3[7:0]	0x00	Programmable DAC biquad 11, N2 coefficient byte[15:8]
0x63	DAC_BQ11_N2_BYT4[7:0]	0x00	Programmable DAC biquad 11, N2 coefficient byte[7:0]
0x64	DAC_BQ11_D1_BYT1[7:0]	0x00	Programmable DAC biquad 11, D1 coefficient byte[31:24]
0x65	DAC_BQ11_D1_BYT2[7:0]	0x00	Programmable DAC biquad 11, D1 coefficient byte[23:16]
0x66	DAC_BQ11_D1_BYT3[7:0]	0x00	Programmable DAC biquad 11, D1 coefficient byte[15:8]
0x67	DAC_BQ11_D1_BYT4[7:0]	0x00	Programmable DAC biquad 11, D1 coefficient byte[7:0]
0x68	DAC_BQ11_D2_BYT1[7:0]	0x00	Programmable DAC biquad 11, D2 coefficient byte[31:24]
0x69	DAC_BQ11_D2_BYT2[7:0]	0x00	Programmable DAC biquad 11, D2 coefficient byte[23:16]
0x6A	DAC_BQ11_D2_BYT3[7:0]	0x00	Programmable DAC biquad 11, D2 coefficient byte[15:8]
0x6B	DAC_BQ11_D2_BYT4[7:0]	0x00	Programmable DAC biquad 11, D2 coefficient byte[7:0]
0x6C	DAC_BQ12_N0_BYT1[7:0]	0x7F	Programmable DAC biquad 12, N0 coefficient byte[31:24]
0x6D	DAC_BQ12_N0_BYT2[7:0]	0xFF	Programmable DAC biquad 12, N0 coefficient byte[23:16]
0x6E	DAC_BQ12_N0_BYT3[7:0]	0xFF	Programmable DAC biquad 12, N0 coefficient byte[15:8]
0x6F	DAC_BQ12_N0_BYT4[7:0]	0xFF	Programmable DAC biquad 12, N0 coefficient byte[7:0]
0x70	DAC_BQ12_N1_BYT1[7:0]	0x00	Programmable DAC biquad 12, N1 coefficient byte[31:24]
0x71	DAC_BQ12_N1_BYT2[7:0]	0x00	Programmable DAC biquad 12, N1 coefficient byte[23:16]
0x72	DAC_BQ12_N1_BYT3[7:0]	0x00	Programmable DAC biquad 12, N1 coefficient byte[15:8]
0x73	DAC_BQ12_N1_BYT4[7:0]	0x00	Programmable DAC biquad 12, N1 coefficient byte[7:0]
0x74	DAC_BQ12_N2_BYT1[7:0]	0x00	Programmable DAC biquad 12, N2 coefficient byte[31:24]
0x75	DAC_BQ12_N2_BYT2[7:0]	0x00	Programmable DAC biquad 12, N2 coefficient byte[23:16]
0x76	DAC_BQ12_N2_BYT3[7:0]	0x00	Programmable DAC biquad 12, N2 coefficient byte[15:8]
0x77	DAC_BQ12_N2_BYT4[7:0]	0x00	Programmable DAC biquad 12, N2 coefficient byte[7:0]
0x78	DAC_BQ12_D1_BYT1[7:0]	0x00	Programmable DAC biquad 12, D1 coefficient byte[31:24]
0x79	DAC_BQ12_D1_BYT2[7:0]	0x00	Programmable DAC biquad 12, D1 coefficient byte[23:16]
0x7A	DAC_BQ12_D1_BYT3[7:0]	0x00	Programmable DAC biquad 12, D1 coefficient byte[15:8]
0x7B	DAC_BQ12_D1_BYT4[7:0]	0x00	Programmable DAC biquad 12, D1 coefficient byte[7:0]
0x7C	DAC_BQ12_D2_BYT1[7:0]	0x00	Programmable DAC biquad 12, D2 coefficient byte[31:24]
0x7D	DAC_BQ12_D2_BYT2[7:0]	0x00	Programmable DAC biquad 12, D2 coefficient byte[23:16]
0x7E	DAC_BQ12_D2_BYT3[7:0]	0x00	Programmable DAC biquad 12, D2 coefficient byte[15:8]
0x7F	DAC_BQ12_D2_BYT4[7:0]	0x00	Programmable DAC biquad 12, D2 coefficient byte[7:0]

### 7.2.7 Programmable Coefficient Registers: Page 17

This register page shown in [Table 7-209](#) consists of the programmable coefficients for the ASI DIN mixer for DAC channels 1 to 4, DAC Aux mixer, Loopback mixer, Signal-generator mixer and the DAC first-order IIR filter.

**Table 7-209. Page 17 Programmable Coefficient Registers**

ADDRESS	REGISTER	RESET	DESCRIPTION
0x00	PAGE[7:0]	0x00	Device Page Register
0x08	ASI_DIN_MIX_ASI_CH1_RDAC_MIX_BYT1[7:0]	0x00	ASI DIN MIXER, ASI CH1 to RDAC coefficient byte[15:8]
0x09	ASI_DIN_MIX_ASI_CH1_RDAC_MIX_BYT2[7:0]	0x00	ASI DIN MIXER, ASI CH1 to RDAC coefficient byte[7:0]
0x0A	ASI_DIN_MIX_ASI_CH1_LDAC_MIX_BYT1[7:0]	0x40	ASI DIN MIXER, ASI CH1 to LDAC coefficient byte[15:8]
0x0B	ASI_DIN_MIX_ASI_CH1_LDAC_MIX_BYT2[7:0]	0x00	ASI DIN MIXER, ASI CH1 to LDAC coefficient byte[7:0]
0x0C	ASI_DIN_MIX_ASI_CH1_RDAC2_MIX_BYT1[7:0]	0x00	ASI DIN MIXER, ASI CH1 to RDAC2 coefficient byte[15:8]

**Table 7-209. Page 17 Programmable Coefficient Registers (continued)**

0x0D	ASI_DIN_MIX_ASI_CH1_RDAC 2_MIX_BYT2[7:0]	0x00	ASI DIN MIXER, ASI CH1 to RDAC2 coefficient byte[7:0]
0x0E	ASI_DIN_MIX_ASI_CH1_LDAC 2_MIX_BYT1[7:0]	0x00	ASI DIN MIXER, ASI CH1 to LDAC2 coefficient byte[15:8]
0x0F	ASI_DIN_MIX_ASI_CH1_LDAC 2_MIX_BYT2[7:0]	0x00	ASI DIN MIXER, ASI CH1 to LDAC2 coefficient byte[7:0]
0x10	ASI_DIN_MIX_ASI_CH2_RDAC _MIX_BYT1[7:0]	0x40	ASI DIN MIXER, ASI CH2 to RDAC coefficient byte[15:8]
0x11	ASI_DIN_MIX_ASI_CH2_RDAC _MIX_BYT2[7:0]	0x00	ASI DIN MIXER, ASI CH2 to RDAC coefficient byte[7:0]
0x12	ASI_DIN_MIX_ASI_CH2_LDAC _MIX_BYT1[7:0]	0x00	ASI DIN MIXER, ASI CH2 to LDAC coefficient byte[15:8]
0x13	ASI_DIN_MIX_ASI_CH2_LDAC _MIX_BYT2[7:0]	0x00	ASI DIN MIXER, ASI CH2 to LDAC coefficient byte[7:0]
0x14	ASI_DIN_MIX_ASI_CH2_RDAC 2_MIX_BYT1[7:0]	0x00	ASI DIN MIXER, ASI CH2 to RDAC2 coefficient byte[15:8]
0x15	ASI_DIN_MIX_ASI_CH2_RDAC 2_MIX_BYT2[7:0]	0x00	ASI DIN MIXER, ASI CH2 to RDAC2 coefficient byte[7:0]
0x16	ASI_DIN_MIX_ASI_CH2_LDAC 2_MIX_BYT1[7:0]	0x00	ASI DIN MIXER, ASI CH2 to LDAC2 coefficient byte[15:8]
0x17	ASI_DIN_MIX_ASI_CH2_LDAC 2_MIX_BYT2[7:0]	0x00	ASI DIN MIXER, ASI CH2 to LDAC2 coefficient byte[7:0]
0x18	ASI_DIN_MIX_ASI_CH3_RDAC _MIX_BYT1[7:0]	0x00	ASI DIN MIXER, ASI CH3 to RDAC coefficient byte[15:8]
0x19	ASI_DIN_MIX_ASI_CH3_RDAC _MIX_BYT2[7:0]	0x00	ASI DIN MIXER, ASI CH3 to RDAC coefficient byte[7:0]
0x1A	ASI_DIN_MIX_ASI_CH3_LDAC _MIX_BYT1[7:0]	0x00	ASI DIN MIXER, ASI CH3 to LDAC coefficient byte[15:8]
0x1B	ASI_DIN_MIX_ASI_CH3_LDAC _MIX_BYT2[7:0]	0x00	ASI DIN MIXER, ASI CH3 to LDAC coefficient byte[7:0]
0x1C	ASI_DIN_MIX_ASI_CH3_RDAC 2_MIX_BYT1[7:0]	0x00	ASI DIN MIXER, ASI CH3 to RDAC2 coefficient byte[15:8]
0x1D	ASI_DIN_MIX_ASI_CH3_RDAC 2_MIX_BYT2[7:0]	0x00	ASI DIN MIXER, ASI CH3 to RDAC2 coefficient byte[7:0]
0x1E	ASI_DIN_MIX_ASI_CH3_LDAC 2_MIX_BYT1[7:0]	0x40	ASI DIN MIXER, ASI CH3 to LDAC2 coefficient byte[15:8]
0x1F	ASI_DIN_MIX_ASI_CH3_LDAC 2_MIX_BYT2[7:0]	0x00	ASI DIN MIXER, ASI CH3 to LDAC2 coefficient byte[7:0]
0x20	ASI_DIN_MIX_ASI_CH4_RDAC _MIX_BYT1[7:0]	0x00	ASI DIN MIXER, ASI CH4 to RDAC coefficient byte[15:8]
0x21	ASI_DIN_MIX_ASI_CH4_RDAC _MIX_BYT2[7:0]	0x00	ASI DIN MIXER, ASI CH4 to RDAC coefficient byte[7:0]
0x22	ASI_DIN_MIX_ASI_CH4_LDAC _MIX_BYT1[7:0]	0x00	ASI DIN MIXER, ASI CH4 to LDAC coefficient byte[15:8]
0x23	ASI_DIN_MIX_ASI_CH4_LDAC _MIX_BYT2[7:0]	0x00	ASI DIN MIXER, ASI CH4 to LDAC coefficient byte[7:0]
0x24	ASI_DIN_MIX_ASI_CH4_RDAC 2_MIX_BYT1[7:0]	0x40	ASI DIN MIXER, ASI CH4 to RDAC2 coefficient byte[15:8]
0x25	ASI_DIN_MIX_ASI_CH4_RDAC 2_MIX_BYT2[7:0]	0x00	ASI DIN MIXER, ASI CH4 to RDAC2 coefficient byte[7:0]
0x26	ASI_DIN_MIX_ASI_CH4_LDAC 2_MIX_BYT1[7:0]	0x00	ASI DIN MIXER, ASI CH4 to LDAC2 coefficient byte[15:8]
0x27	ASI_DIN_MIX_ASI_CH4_LDAC 2_MIX_BYT2[7:0]	0x00	ASI DIN MIXER, ASI CH4 to LDAC2 coefficient byte[7:0]

**Table 7-209. Page 17 Programmable Coefficient Registers (continued)**

0x28	ASI_DIN_MIX_ASI_CH5_RDAC_MIX_BYT1[7:0]	0x00	ASI DIN MIXER, ASI CH5 to RDAC coefficient byte[15:8]
0x29	ASI_DIN_MIX_ASI_CH5_RDAC_MIX_BYT2[7:0]	0x00	ASI DIN MIXER, ASI CH5 to RDAC coefficient byte[7:0]
0x2A	ASI_DIN_MIX_ASI_CH5_LDAC_MIX_BYT1[7:0]	0x00	ASI DIN MIXER, ASI CH5 to LDAC coefficient byte[15:8]
0x2B	ASI_DIN_MIX_ASI_CH5_LDAC_MIX_BYT2[7:0]	0x00	ASI DIN MIXER, ASI CH5 to LDAC coefficient byte[7:0]
0x2C	ASI_DIN_MIX_ASI_CH5_RDAC_2_MIX_BYT1[7:0]	0x00	ASI DIN MIXER, ASI CH5 to RDAC2 coefficient byte[15:8]
0x2D	ASI_DIN_MIX_ASI_CH5_RDAC_2_MIX_BYT2[7:0]	0x00	ASI DIN MIXER, ASI CH5 to RDAC2 coefficient byte[7:0]
0x2E	ASI_DIN_MIX_ASI_CH5_LDAC_2_MIX_BYT1[7:0]	0x00	ASI DIN MIXER, ASI CH5 to LDAC2 coefficient byte[15:8]
0x2F	ASI_DIN_MIX_ASI_CH5_LDAC_2_MIX_BYT2[7:0]	0x00	ASI DIN MIXER, ASI CH5 to LDAC2 coefficient byte[7:0]
0x30	ASI_DIN_MIX_ASI_CH6_RDAC_MIX_BYT1[7:0]	0x00	ASI DIN MIXER, ASI CH6 to RDAC coefficient byte[15:8]
0x31	ASI_DIN_MIX_ASI_CH6_RDAC_MIX_BYT2[7:0]	0x00	ASI DIN MIXER, ASI CH6 to RDAC coefficient byte[7:0]
0x32	ASI_DIN_MIX_ASI_CH6_LDAC_MIX_BYT1[7:0]	0x00	ASI DIN MIXER, ASI CH6 to LDAC coefficient byte[15:8]
0x33	ASI_DIN_MIX_ASI_CH6_LDAC_MIX_BYT2[7:0]	0x00	ASI DIN MIXER, ASI CH6 to LDAC coefficient byte[7:0]
0x34	ASI_DIN_MIX_ASI_CH6_RDAC_2_MIX_BYT1[7:0]	0x00	ASI DIN MIXER, ASI CH6 to RDAC2 coefficient byte[15:8]
0x35	ASI_DIN_MIX_ASI_CH6_RDAC_2_MIX_BYT2[7:0]	0x00	ASI DIN MIXER, ASI CH6 to RDAC2 coefficient byte[7:0]
0x36	ASI_DIN_MIX_ASI_CH6_LDAC_2_MIX_BYT1[7:0]	0x00	ASI DIN MIXER, ASI CH6 to LDAC2 coefficient byte[15:8]
0x37	ASI_DIN_MIX_ASI_CH6_LDAC_2_MIX_BYT2[7:0]	0x00	ASI DIN MIXER, ASI CH6 to LDAC2 coefficient byte[7:0]
0x38	ASI_DIN_MIX_ASI_CH7_RDAC_MIX_BYT1[7:0]	0x00	ASI DIN MIXER, ASI CH7 to RDAC coefficient byte[15:8]
0x39	ASI_DIN_MIX_ASI_CH7_RDAC_MIX_BYT2[7:0]	0x00	ASI DIN MIXER, ASI CH7 to RDAC coefficient byte[7:0]
0x3A	ASI_DIN_MIX_ASI_CH7_LDAC_MIX_BYT1[7:0]	0x00	ASI DIN MIXER, ASI CH7 to LDAC coefficient byte[15:8]
0x3B	ASI_DIN_MIX_ASI_CH7_LDAC_MIX_BYT2[7:0]	0x00	ASI DIN MIXER, ASI CH7 to LDAC coefficient byte[7:0]
0x3C	ASI_DIN_MIX_ASI_CH7_RDAC_2_MIX_BYT1[7:0]	0x00	ASI DIN MIXER, ASI CH7 to RDAC2 coefficient byte[15:8]
0x3D	ASI_DIN_MIX_ASI_CH7_RDAC_2_MIX_BYT2[7:0]	0x00	ASI DIN MIXER, ASI CH7 to RDAC2 coefficient byte[7:0]
0x3E	ASI_DIN_MIX_ASI_CH7_LDAC_2_MIX_BYT1[7:0]	0x00	ASI DIN MIXER, ASI CH7 to LDAC2 coefficient byte[15:8]
0x3F	ASI_DIN_MIX_ASI_CH7_LDAC_2_MIX_BYT2[7:0]	0x00	ASI DIN MIXER, ASI CH7 to LDAC2 coefficient byte[7:0]
0x40	ASI_DIN_MIX_ASI_CH8_RDAC_MIX_BYT1[7:0]	0x00	ASI DIN MIXER, ASI CH8 to RDAC coefficient byte[15:8]
0x41	ASI_DIN_MIX_ASI_CH8_RDAC_MIX_BYT2[7:0]	0x00	ASI DIN MIXER, ASI CH8 to RDAC coefficient byte[7:0]
0x42	ASI_DIN_MIX_ASI_CH8_LDAC_MIX_BYT1[7:0]	0x00	ASI DIN MIXER, ASI CH8 to LDAC coefficient byte[15:8]

**Table 7-209. Page 17 Programmable Coefficient Registers (continued)**

0x43	ASI_DIN_MIX_ASI_CH8_LDAC_MIX_BYT2[7:0]	0x00	ASI DIN MIXER, ASI CH8 to LDAC coefficient byte[7:0]
0x44	ASI_DIN_MIX_ASI_CH8_RDAC2_MIX_BYT1[7:0]	0x00	ASI DIN MIXER, ASI CH8 to RDAC2 coefficient byte[15:8]
0x45	ASI_DIN_MIX_ASI_CH8_RDAC2_MIX_BYT2[7:0]	0x00	ASI DIN MIXER, ASI CH8 to RDAC2 coefficient byte[7:0]
0x46	ASI_DIN_MIX_ASI_CH8_LDAC2_MIX_BYT1[7:0]	0x00	ASI DIN MIXER, ASI CH8 to LDAC2 coefficient byte[15:8]
0x47	ASI_DIN_MIX_ASI_CH8_LDAC2_MIX_BYT2[7:0]	0x00	ASI DIN MIXER, ASI CH8 to LDAC2 coefficient byte[7:0]
0x48	ASI_DIN_MIX_ASI_AUX_CH1_RDAC_MIX_BYT1[7:0]	0x00	ASI DIN MIXER, ASI AUX_CH1 to RDAC coefficient byte[15:8]
0x49	ASI_DIN_MIX_ASI_AUX_CH1_RDAC_MIX_BYT2[7:0]	0x00	ASI DIN MIXER, ASI AUX_CH1 to RDAC coefficient byte[7:0]
0x4A	ASI_DIN_MIX_ASI_AUX_CH1_LDAC_MIX_BYT1[7:0]	0x40	ASI DIN MIXER, ASI AUX_CH1 to LDAC coefficient byte[15:8]
0x4B	ASI_DIN_MIX_ASI_AUX_CH1_LDAC_MIX_BYT2[7:0]	0x00	ASI DIN MIXER, ASI AUX_CH1 to LDAC coefficient byte[7:0]
0x4C	ASI_DIN_MIX_ASI_AUX_CH1_RDAC2_MIX_BYT1[7:0]	0x00	ASI DIN MIXER, ASI AUX_CH1 to RDAC2 coefficient byte[15:8]
0x4D	ASI_DIN_MIX_ASI_AUX_CH1_RDAC2_MIX_BYT2[7:0]	0x00	ASI DIN MIXER, ASI AUX_CH1 to RDAC2 coefficient byte[7:0]
0x4E	ASI_DIN_MIX_ASI_AUX_CH1_LDAC2_MIX_BYT1[7:0]	0x40	ASI DIN MIXER, ASI AUX_CH1 to LDAC2 coefficient byte[15:8]
0x4F	ASI_DIN_MIX_ASI_AUX_CH1_LDAC2_MIX_BYT2[7:0]	0x00	ASI DIN MIXER, ASI AUX_CH1 to LDAC2 coefficient byte[7:0]
0x50	ASI_DIN_MIX_ASI_AUX_CH2_RDAC_MIX_BYT1[7:0]	0x40	ASI DIN MIXER, ASI AUX_CH2 to RDAC coefficient byte[15:8]
0x51	ASI_DIN_MIX_ASI_AUX_CH2_RDAC_MIX_BYT2[7:0]	0x00	ASI DIN MIXER, ASI AUX_CH2 to RDAC coefficient byte[7:0]
0x52	ASI_DIN_MIX_ASI_AUX_CH2_LDAC_MIX_BYT1[7:0]	0x00	ASI DIN MIXER, ASI AUX_CH2 to LDAC coefficient byte[15:8]
0x53	ASI_DIN_MIX_ASI_AUX_CH2_LDAC_MIX_BYT2[7:0]	0x00	ASI DIN MIXER, ASI AUX_CH2 to LDAC coefficient byte[7:0]
0x54	ASI_DIN_MIX_ASI_AUX_CH2_RDAC2_MIX_BYT1[7:0]	0x40	ASI DIN MIXER, ASI AUX_CH2 to RDAC2 coefficient byte[15:8]
0x55	ASI_DIN_MIX_ASI_AUX_CH2_RDAC2_MIX_BYT2[7:0]	0x00	ASI DIN MIXER, ASI AUX_CH2 to RDAC2 coefficient byte[7:0]
0x56	ASI_DIN_MIX_ASI_AUX_CH2_LDAC2_MIX_BYT1[7:0]	0x00	ASI DIN MIXER, ASI AUX_CH2 to LDAC2 coefficient byte[15:8]
0x57	ASI_DIN_MIX_ASI_AUX_CH2_LDAC2_MIX_BYT2[7:0]	0x00	ASI DIN MIXER, ASI AUX_CH2 to LDAC2 coefficient byte[7:0]
0x58	SC_DAC_MIX_ADCLB_CH1_RDAC_MIX_BYT1[7:0]	0x00	SC DAC MIXER, ADC Loopback CH1 to RDAC coefficient byte[15:8]
0x59	SC_DAC_MIX_ADCLB_CH1_RDAC_MIX_BYT2[7:0]	0x00	SC DAC MIXER, ADC Loopback CH1 to RDAC coefficient byte[7:0]
0x5A	SC_DAC_MIX_ADCLB_CH1_LDAC_MIX_BYT1[7:0]	0x00	SC DAC MIXER, ADC Loopback CH1 to LDAC coefficient byte[15:8]
0x5B	SC_DAC_MIX_ADCLB_CH1_LDAC_MIX_BYT2[7:0]	0x00	SC DAC MIXER, ADC Loopback CH1 to LDAC coefficient byte[7:0]
0x5C	SC_DAC_MIX_ADCLB_CH1_RDAC2_MIX_BYT1[7:0]	0x00	SC DAC MIXER, ADC Loopback CH1 to RDAC2 coefficient byte[15:8]
0x5D	SC_DAC_MIX_ADCLB_CH1_RDAC2_MIX_BYT2[7:0]	0x00	SC DAC MIXER, ADC Loopback CH1 to RDAC2 coefficient byte[7:0]



**Table 7-209. Page 17 Programmable Coefficient Registers (continued)**

0x5E	SC_DAC_MIX_ADCLB_CH1_L DAC2_MIX_BYT1[7:0]	0x00	SC DAC MIXER, ADC Loopback CH1 to LDAC2 coefficient byte[15:8]
0x5F	SC_DAC_MIX_ADCLB_CH1_L DAC2_MIX_BYT2[7:0]	0x00	SC DAC MIXER, ADC Loopback CH1 to LDAC2 coefficient byte[7:0]
0x60	SC_DAC_MIX_ADCLB_CH2_R DAC_MIX_BYT1[7:0]	0x00	SC DAC MIXER, ADC Loopback CH2 to RDAC coefficient byte[15:8]
0x61	SC_DAC_MIX_ADCLB_CH2_R DAC_MIX_BYT2[7:0]	0x00	SC DAC MIXER, ADC Loopback CH2 to RDAC coefficient byte[7:0]
0x62	SC_DAC_MIX_ADCLB_CH2_L DAC_MIX_BYT1[7:0]	0x00	SC DAC MIXER, ADC Loopback CH2 to LDAC coefficient byte[15:8]
0x63	SC_DAC_MIX_ADCLB_CH2_L DAC_MIX_BYT2[7:0]	0x00	SC DAC MIXER, ADC Loopback CH2 to LDAC coefficient byte[7:0]
0x64	SC_DAC_MIX_ADCLB_CH2_R DAC2_MIX_BYT1[7:0]	0x00	SC DAC MIXER, ADC Loopback CH2 to RDAC2 coefficient byte[15:8]
0x65	SC_DAC_MIX_ADCLB_CH2_R DAC2_MIX_BYT2[7:0]	0x00	SC DAC MIXER, ADC Loopback CH2 to RDAC2 coefficient byte[7:0]
0x66	SC_DAC_MIX_ADCLB_CH2_L DAC2_MIX_BYT1[7:0]	0x00	SC DAC MIXER, ADC Loopback CH2 to LDAC2 coefficient byte[15:8]
0x67	SC_DAC_MIX_ADCLB_CH2_L DAC2_MIX_BYT2[7:0]	0x00	SC DAC MIXER, ADC Loopback CH2 to LDAC2 coefficient byte[7:0]
0x68	SC_DAC_MIX_SIGGEN_CH1_ RDAC_MIX_BYT1[7:0]	0x00	SC DAC MIXER, Signal Generator CH1 to RDAC coefficient byte[15:8]
0x69	SC_DAC_MIX_SIGGEN_CH1_ RDAC_MIX_BYT2[7:0]	0x00	SC DAC MIXER, Signal Generator CH1 to RDAC coefficient byte[7:0]
0x6A	SC_DAC_MIX_SIGGEN_CH1_ LDAC_MIX_BYT1[7:0]	0x00	SC DAC MIXER, Signal Generator CH1 to LDAC coefficient byte[15:8]
0x6B	SC_DAC_MIX_SIGGEN_CH1_ LDAC_MIX_BYT2[7:0]	0x00	SC DAC MIXER, Signal Generator CH1 to LDAC coefficient byte[7:0]
0x6C	SC_DAC_MIX_SIGGEN_CH1_ RDAC2_MIX_BYT1[7:0]	0x00	SC DAC MIXER, Signal Generator CH1 to RDAC2 coefficient byte[15:8]
0x6D	SC_DAC_MIX_SIGGEN_CH1_ RDAC2_MIX_BYT2[7:0]	0x00	SC DAC MIXER, Signal Generator CH1 to RDAC2 coefficient byte[7:0]
0x6E	SC_DAC_MIX_SIGGEN_CH1_ LDAC2_MIX_BYT1[7:0]	0x00	SC DAC MIXER, Signal Generator CH1 to LDAC2 coefficient byte[15:8]
0x6F	SC_DAC_MIX_SIGGEN_CH1_ LDAC2_MIX_BYT2[7:0]	0x00	SC DAC MIXER, Signal Generator CH1 to LDAC2 coefficient byte[7:0]
0x70	SC_DAC_MIX_SIGGEN_CH2_ RDAC_MIX_BYT1[7:0]	0x00	SC DAC MIXER, Signal Generator CH2 to RDAC coefficient byte[15:8]
0x71	SC_DAC_MIX_SIGGEN_CH2_ RDAC_MIX_BYT2[7:0]	0x00	SC DAC MIXER, Signal Generator CH2 to RDAC coefficient byte[7:0]
0x72	SC_DAC_MIX_SIGGEN_CH2_ LDAC_MIX_BYT1[7:0]	0x00	SC DAC MIXER, Signal Generator CH2 to LDAC coefficient byte[15:8]
0x73	SC_DAC_MIX_SIGGEN_CH2_ LDAC_MIX_BYT2[7:0]	0x00	SC DAC MIXER, Signal Generator CH2 to LDAC coefficient byte[7:0]
0x74	SC_DAC_MIX_SIGGEN_CH2_ RDAC2_MIX_BYT1[7:0]	0x00	SC DAC MIXER, Signal Generator CH2 to RDAC2 coefficient byte[15:8]
0x75	SC_DAC_MIX_SIGGEN_CH2_ RDAC2_MIX_BYT2[7:0]	0x00	SC DAC MIXER, Signal Generator CH2 to RDAC2 coefficient byte[7:0]
0x76	SC_DAC_MIX_SIGGEN_CH2_ LDAC2_MIX_BYT1[7:0]	0x00	SC DAC MIXER, Signal Generator CH2 to LDAC2 coefficient byte[15:8]
0x77	SC_DAC_MIX_SIGGEN_CH2_ LDAC2_MIX_BYT2[7:0]	0x00	SC DAC MIXER, Signal Generator CH2 to LDAC2 coefficient byte[7:0]
0x78	DAC_IIR_N0_BYT1[7:0]	0x7F	Programmable DAC first-order IIR, N0 coefficient byte[31:24]
0x79	DAC_IIR_N0_BYT2[7:0]	0xFF	Programmable DAC first-order IIR, N0 coefficient byte[23:16]

**Table 7-209. Page 17 Programmable Coefficient Registers (continued)**

0x7A	DAC_IIR_N0_BYT3[7:0]	0xFF	Programmable DAC first-order IIR, N0 coefficient byte[15:8]
0x7B	DAC_IIR_N0_BYT4[7:0]	0xFF	Programmable DAC first-order IIR, N0 coefficient byte[7:0]
0x7C	DAC_IIR_N1_BYT1[7:0]	0x00	Programmable DAC first-order IIR, N1 coefficient byte[31:24]
0x7D	DAC_IIR_N1_BYT2[7:0]	0x00	Programmable DAC first-order IIR, N1 coefficient byte[23:16]
0x7E	DAC_IIR_N1_BYT3[7:0]	0x00	Programmable DAC first-order IIR, N1 coefficient byte[15:8]
0x7F	DAC_IIR_N1_BYT4[7:0]	0x00	Programmable DAC first-order IIR, N1 coefficient byte[7:0]

**7.2.8 Programmable Coefficient Registers: Page 18**

This register page shown in [Table 7-210](#) consists of the programmable coefficients for the DAC first-order IIR filter, DAC digital volume control for channels 1 to 4 and DAC Beep generator.

**Table 7-210. Page 18 Programmable Coefficient Registers**

ADDRESS	REGISTER	RESET	DESCRIPTION
0x00	PAGE[7:0]	0x00	Device Page Register
0x08	DAC_IIR_D1_BYT1[7:0]	0x00	Programmable DAC first-order IIR, D1 coefficient byte[31:24]
0x09	DAC_IIR_D1_BYT2[7:0]	0x00	Programmable DAC first-order IIR, D1 coefficient byte[23:16]
0x0A	DAC_IIR_D1_BYT3[7:0]	0x00	Programmable DAC first-order IIR, D1 coefficient byte[15:8]
0x0B	DAC_IIR_D1_BYT4[7:0]	0x00	Programmable DAC first-order IIR, D1 coefficient byte[7:0]
0x0C	DAC_VOL_CH1_BYT1[7:0]	0x00	Digital volume control, DAC channel 1 coefficient byte[31:24]
0x0D	DAC_VOL_CH1_BYT2[7:0]	0x80	Digital volume control, DAC channel 1 coefficient byte[23:16]
0x0E	DAC_VOL_CH1_BYT3[7:0]	0x00	Digital volume control, DAC channel 1 coefficient byte[15:8]
0x0F	DAC_VOL_CH1_BYT4[7:0]	0x00	Digital volume control, DAC channel 1 coefficient byte[7:0]
0x10	DAC_VOL_CH2_BYT1[7:0]	0x00	Digital volume control, DAC channel 2 coefficient byte[31:24]
0x11	DAC_VOL_CH2_BYT2[7:0]	0x80	Digital volume control, DAC channel 2 coefficient byte[23:16]
0x12	DAC_VOL_CH2_BYT3[7:0]	0x00	Digital volume control, DAC channel 2 coefficient byte[15:8]
0x13	DAC_VOL_CH2_BYT4[7:0]	0x00	Digital volume control, DAC channel 2 coefficient byte[7:0]
0x14	DAC_VOL_CH3_BYT1[7:0]	0x00	Digital volume control, DAC channel 3 coefficient byte[31:24]
0x15	DAC_VOL_CH3_BYT2[7:0]	0x80	Digital volume control, DAC channel 3 coefficient byte[23:16]
0x16	DAC_VOL_CH3_BYT3[7:0]	0x00	Digital volume control, DAC channel 3 coefficient byte[15:8]
0x17	DAC_VOL_CH3_BYT4[7:0]	0x00	Digital volume control, DAC channel 3 coefficient byte[7:0]
0x18	DAC_VOL_CH4_BYT1[7:0]	0x00	Digital volume control, DAC channel 4 coefficient byte[31:24]
0x19	DAC_VOL_CH4_BYT2[7:0]	0x80	Digital volume control, DAC channel 4 coefficient byte[23:16]
0x1A	DAC_VOL_CH4_BYT3[7:0]	0x00	Digital volume control, DAC channel 4 coefficient byte[15:8]
0x1B	DAC_VOL_CH4_BYT4[7:0]	0x00	Digital volume control, DAC channel 4 coefficient byte[7:0]
0x20	DAC_BEEP GEN_SINX_BYT1[7:0]	0x45	Programmable DAC BEEP GEN sin(x) coefficient byte[31:24]
0x21	DAC_BEEP GEN_SINX_BYT2[7:0]	0xF4	Programmable DAC BEEP GEN sin(x) coefficient byte[23:16]
0x22	DAC_BEEP GEN_SINX_BYT3[7:0]	0x61	Programmable DAC BEEP GEN sin(x) coefficient byte[15:8]
0x23	DAC_BEEP GEN_SINX_BYT4[7:0]	0xD0	Programmable DAC BEEP GEN sin(x) coefficient byte[7:0]
0x24	DAC_BEEP GEN_COSX_BYT1[7:0]	0x7F	Programmable DAC BEEP GEN cos(x) coefficient byte[31:24]
0x25	DAC_BEEP GEN_COSX_BYT2[7:0]	0xFE	Programmable DAC BEEP GEN cos(x) coefficient byte[23:16]
0x26	DAC_BEEP GEN_COSX_BYT3[7:0]	0xFD	Programmable DAC BEEP GEN cos(x) coefficient byte[15:8]

**Table 7-210. Page 18 Programmable Coefficient Registers (continued)**

0x27	DAC_BEEP GEN_COSX_BYT4[7:0]	0x46	Programmable DAC BEEP GEN cos(x) coefficient byte[7:0]
0x28	DAC_BEEP GEN2_SINX_BYT1[7:0]	0x5D	Programmable DAC BEEP GEN2 sin(x) coefficient byte[31:24]
0x29	DAC_BEEP GEN2_SINX_BYT2[7:0]	0xA2	Programmable DAC BEEP GEN2 sin(x) coefficient byte[23:16]
0x2A	DAC_BEEP GEN2_SINX_BYT3[7:0]	0x74	Programmable DAC BEEP GEN2 sin(x) coefficient byte[15:8]
0x2B	DAC_BEEP GEN2_SINX_BYT4[7:0]	0xB4	Programmable DAC BEEP GEN2 sin(x) coefficient byte[7:0]
0x2C	DAC_BEEP GEN2_COSX_BYT1[7:0]	0x01	Programmable DAC BEEP GEN2 cos(x) coefficient byte[31:24]
0x2D	DAC_BEEP GEN2_COSX_BYT2[7:0]	0x01	Programmable DAC BEEP GEN2 cos(x) coefficient byte[23:16]
0x2E	DAC_BEEP GEN2_COSX_BYT3[7:0]	0x5B	Programmable DAC BEEP GEN2 cos(x) coefficient byte[15:8]
0x2F	DAC_BEEP GEN2_COSX_BYT4[7:0]	0x4B	Programmable DAC BEEP GEN2 cos(x) coefficient byte[7:0]

### 7.2.9 Programmable Coefficient Registers: Page 19

This register page shown in [Table 7-211](#) consists of the programmable coefficients for the ADC and DAC MSA for channels 1 to 4.

**Table 7-211. Page 19 Programmable Coefficient Registers**

ADDRESS	REGISTER	RESET	DESCRIPTION
0x00	PAGE[7:0]	0x00	Device Page Register
0x58	ADC_CH1_SF1_BYT1[7:0]	0x04	ADC CH1 MSA coefficient byte[31:24]
0x59	ADC_CH1_SF1_BYT2[7:0]	0x00	ADC CH1 MSA coefficient byte[23:16]
0x5A	ADC_CH1_SF1_BYT3[7:0]	0x00	ADC CH1 MSA coefficient byte[15:8]
0x5B	ADC_CH1_SF1_BYT4[7:0]	0x00	ADC CH1 MSA coefficient byte[7:0]
0x5C	ADC_CH2_SF1_BYT1[7:0]	0x04	ADC CH2 MSA coefficient byte[31:24]
0x5D	ADC_CH2_SF1_BYT2[7:0]	0x00	ADC CH2 MSA coefficient byte[23:16]
0x5E	ADC_CH2_SF1_BYT3[7:0]	0x00	ADC CH2 MSA coefficient byte[15:8]
0x5F	ADC_CH2_SF1_BYT4[7:0]	0x00	ADC CH2 MSA coefficient byte[7:0]
0x60	ADC_CH3_SF1_BYT1[7:0]	0x04	ADC CH3 MSA coefficient byte[31:24]
0x61	ADC_CH3_SF1_BYT2[7:0]	0x00	ADC CH3 MSA coefficient byte[23:16]
0x62	ADC_CH3_SF1_BYT3[7:0]	0x00	ADC CH3 MSA coefficient byte[15:8]
0x63	ADC_CH3_SF1_BYT4[7:0]	0x00	ADC CH3 MSA coefficient byte[7:0]
0x64	ADC_CH4_SF1_BYT1[7:0]	0x04	ADC CH4 MSA coefficient byte[31:24]
0x65	ADC_CH4_SF1_BYT2[7:0]	0x00	ADC CH4 MSA coefficient byte[23:16]
0x66	ADC_CH4_SF1_BYT3[7:0]	0x00	ADC CH4 MSA coefficient byte[15:8]
0x67	ADC_CH4_SF1_BYT4[7:0]	0x00	ADC CH4 MSA coefficient byte[7:0]
0x68	LDAC_SF1_BYT1[7:0]	0x04	LDAC MSA coefficient byte[31:24]
0x69	LDAC_SF1_BYT2[7:0]	0x00	LDAC MSA coefficient byte[23:16]
0x6A	LDAC_SF1_BYT3[7:0]	0x00	LDAC MSA coefficient byte[15:8]
0x6B	LDAC_SF1_BYT4[7:0]	0x00	LDAC MSA coefficient byte[7:0]
0x6C	RDAC_SF1_BYT1[7:0]	0x04	RDAC MSA coefficient byte[31:24]
0x6D	RDAC_SF1_BYT2[7:0]	0x00	RDAC MSA coefficient byte[23:16]
0x6E	RDAC_SF1_BYT3[7:0]	0x00	RDAC MSA coefficient byte[15:8]
0x6F	RDAC_SF1_BYT4[7:0]	0x00	RDAC MSA coefficient byte[7:0]

**Table 7-211. Page 19 Programmable Coefficient Registers (continued)**

0x70	LDAC2_SF1_BYT1[7:0]	0x04	LDAC2 MSA coefficient byte[31:24]
0x71	LDAC2_SF1_BYT2[7:0]	0x00	LDAC2 MSA coefficient byte[23:16]
0x72	LDAC2_SF1_BYT3[7:0]	0x00	LDAC2 MSA coefficient byte[15:8]
0x73	LDAC2_SF1_BYT4[7:0]	0x00	LDAC2 MSA coefficient byte[7:0]
0x74	RDAC2_SF1_BYT1[7:0]	0x04	RDAC2 MSA coefficient byte[31:24]
0x75	RDAC2_SF1_BYT2[7:0]	0x00	RDAC2 MSA coefficient byte[23:16]
0x76	RDAC2_SF1_BYT3[7:0]	0x00	RDAC2 MSA coefficient byte[15:8]
0x77	RDAC2_SF1_BYT4[7:0]	0x00	RDAC2 MSA coefficient byte[7:0]

**7.2.10 Programmable Coefficient Registers: Page 25**

This register page shown in [Table 7-212](#) consists of the programmable coefficients for the DAC Limiter.

**Table 7-212. Page 25 Programmable Coefficient Registers**

ADDRESS	REGISTER	RESET	DESCRIPTION
0x00	PAGE[7:0]	0x00	Device Page Register
0x60	LIMITER_ATTACK_COEFF_BYT1[7:0]	0x78	Distortion limiter Attack coefficient byte[31:24]
0x61	LIMITER_ATTACK_COEFF_BYT2[7:0]	0xD6	Distortion limiter Attack coefficient byte[23:16]
0x62	LIMITER_ATTACK_COEFF_BYT3[7:0]	0xFC	Distortion limiter Attack coefficient byte[15:8]
0x63	LIMITER_ATTACK_COEFF_BYT4[7:0]	0x9F	Distortion limiter Attack coefficient byte[7:0]
0x64	LIMITER_RELEASE_COEFF_BYT1[7:0]	0x40	Distortion limiter Release coefficient byte[31:24]
0x65	LIMITER_RELEASE_COEFF_BYT2[7:0]	0xBD	Distortion limiter Release coefficient byte[23:16]
0x66	LIMITER_RELEASE_COEFF_BYT3[7:0]	0xB7	Distortion limiter Release coefficient byte[15:8]
0x67	LIMITER_RELEASE_COEFF_BYT4[7:0]	0xC0	Distortion limiter Release coefficient byte[7:0]
0x68	LIMITER_ENV_DECAY_COEFF_BYT1[7:0]	0x7F	Distortion limiter envelope decay coefficient byte[31:24]
0x69	LIMITER_ENV_DECAY_COEFF_BYT2[7:0]	0xFC	Distortion limiter envelope decay coefficient byte[23:16]
0x6A	LIMITER_ENV_DECAY_COEFF_BYTT3[7:0]	0x3A	Distortion limiter envelope decay coefficient byte[15:8]
0x6B	LIMITER_ENV_DECAY_COEFF_BYTT4[7:0]	0x48	Distortion limiter envelope decay coefficient byte[7:0]
0x6C	LIMITER_THRESHOLD_MAX_BYT1[7:0]	0x01	Distortion limiter Threshold Max coefficient byte[31:24]
0x6D	LIMITER_THRESHOLD_MAX_BYT2[7:0]	0x69	Distortion limiter Threshold Max coefficient byte[23:16]
0x6E	LIMITER_THRESHOLD_MAX_BYTT3[7:0]	0x9C	Distortion limiter Threshold Max coefficient byte[15:8]
0x6F	LIMITER_THRESHOLD_MAX_BYTT4[7:0]	0x10	Distortion limiter Threshold Max coefficient byte[7:0]
0x70	LIMITER_THRESHOLD_MIN_BYT1[7:0]	0x00	Distortion limiter Threshold Min coefficient byte[31:24]
0x71	LIMITER_THRESHOLD_MIN_BYT2[7:0]	0x72	Distortion limiter Threshold Min coefficient byte[23:16]
0x72	LIMITER_THRESHOLD_MIN_BYTT3[7:0]	0x59	Distortion limiter Threshold Min coefficient byte[15:8]

**Table 7-212. Page 25 Programmable Coefficient Registers (continued)**

0x73	LIMITER_THRESHOLD_MIN_BYTT4[7:0]	0xDB	Distortion limiter Threshold Min coefficient byte[7:0]
0x74	LIMITER_INFLECTION_POINT_BYT1[7:0]	0x00	Distortion limiter Inflection Point coefficient byte[31:24]
0x75	LIMITER_INFLECTION_POINT_BYT2[7:0]	0x00	Distortion limiter Inflection Point coefficient byte[23:16]
0x76	LIMITER_INFLECTION_POINT_BYTT3[7:0]	0x19	Distortion limiter Inflection Point coefficient byte[15:8]
0x77	LIMITER_INFLECTION_POINT_BYTT4[7:0]	0x9A	Distortion limiter Inflection Point coefficient byte[7:0]
0x78	LIMITER_SLOPE_BYT1[7:0]	0x10	Distortion limiter Slope coefficient byte[31:24]
0x79	LIMITER_SLOPE_BYT2[7:0]	0x00	Distortion limiter Slope coefficient byte[23:16]
0x7A	LIMITER_SLOPE_BYTT3[7:0]	0x00	Distortion limiter Slope coefficient byte[15:8]
0x7B	LIMITER_SLOPE_BYTT4[7:0]	0x00	Distortion limiter Slope coefficient byte[7:0]
0x7C	LIMITER_RESET_COUNTER_BYT1[7:0]	0x00	Distortion limiter Hold Count coefficient byte[31:24]
0x7D	LIMITER_RESET_COUNTER_BYT2[7:0]	0x00	Distortion limiter Hold Count coefficient byte[23:16]
0x7E	LIMITER_RESET_COUNTER_BYTT3[7:0]	0x09	Distortion limiter Hold Count coefficient byte[15:8]
0x7F	LIMITER_RESET_COUNTER_BYTT4[7:0]	0x60	Distortion limiter Hold Count coefficient byte[7:0]

### 7.2.11 Programmable Coefficient Registers: Page 26

This register page shown in [Table 7-213](#) consists of the programmable coefficients for the DAC brownout protection (BOP), thermal foldback (THF) protection and Limiter.

**Table 7-213. Page 26 Programmable Coefficient Registers**

ADDRESS	REGISTER	RESET	DESCRIPTION
0x00	PAGE[7:0]	0x00	Device Page Register
0x14	BOP_ATTACK_COEFF_BYT1[7:0]	0x78	BOP Attack coefficient byte[31:24]
0x15	BOP_ATTACK_COEFF_BYT2[7:0]	0xD6	BOP Attack coefficient byte[23:16]
0x16	BOP_ATTACK_COEFF_BYTT3[7:0]	0xFC	BOP Attack coefficient byte[15:8]
0x17	BOP_ATTACK_COEFF_BYTT4[7:0]	0x9F	BOP Attack coefficient byte[7:0]
0x18	BOP_RELEASE_COEFF_BYT1[7:0]	0x40	BOP Release coefficient byte[31:24]
0x19	BOP_RELEASE_COEFF_BYT2[7:0]	0xBD	BOP Release coefficient byte[23:16]
0x1A	BOP_RELEASE_COEFF_BYTT3[7:0]	0xB7	BOP Release coefficient byte[15:8]
0x1B	BOP_RELEASE_COEFF_BYTT4[7:0]	0xC0	BOP Release coefficient byte[7:0]
0x1C	BOP_RESET_COUNTER_BYT1[7:0]	0x00	BOP Hold Count coefficient byte[31:24]
0x1D	BOP_RESET_COUNTER_BYT2[7:0]	0x00	BOP Hold Count coefficient byte[23:16]
0x1E	BOP_RESET_COUNTER_BYTT3[7:0]	0x09	BOP Hold Count coefficient byte[15:8]
0x1F	BOP_RESET_COUNTER_BYTT4[7:0]	0x60	BOP Hold Count coefficient byte[7:0]

**Table 7-213. Page 26 Programmable Coefficient Registers (continued)**

0x20	BOP_VSUP_TH1_BYT1[7:0]	0x00	BOP Supply Threshold1 coefficient byte[31:24]
0x21	BOP_VSUP_TH1_BYT2[7:0]	0x00	BOP Supply Threshold1 coefficient byte[23:16]
0x22	BOP_VSUP_TH1_BYTT3[7:0]	0x19	BOP Supply Threshold1 coefficient byte[15:8]
0x23	BOP_VSUP_TH1_BYTT4[7:0]	0x9A	BOP Supply Threshold1 coefficient byte[7:0]
0x24	BOP_THRESHOLD1_BYT1[7:0]	0x2D	BOP Threshold1 Gain coefficient byte[31:24]
0x25	BOP_THRESHOLD1_BYT2[7:0]	0x4E	BOP Threshold1 Gain coefficient byte[23:16]
0x26	BOP_THRESHOLD1_BYTT3[7:0]	0xFB	BOP Threshold1 Gain coefficient byte[15:8]
0x27	BOP_THRESHOLD1_BYTT4[7:0]	0xD6	BOP Threshold1 Gain coefficient byte[7:0]
0x28	BOP_VSUP_TH2_BYT1[7:0]	0x00	BOP Supply Threshold2 coefficient byte[31:24]
0x29	BOP_VSUP_TH2_BYT2[7:0]	0x00	BOP Supply Threshold2 coefficient byte[23:16]
0x2A	BOP_VSUP_TH2_BYTT3[7:0]	0x16	BOP Supply Threshold2 coefficient byte[15:8]
0x2B	BOP_VSUP_TH2_BYTT4[7:0]	0x66	BOP Supply Threshold2 coefficient byte[7:0]
0x2C	BOP_THRESHOLD2_BYT1[7:0]	0x14	BOP Threshold2 Gain coefficient byte[31:24]
0x2D	BOP_THRESHOLD2_BYT2[7:0]	0x3D	BOP Threshold2 Gain coefficient byte[23:16]
0x2E	BOP_THRESHOLD2_BYTT3[7:0]	0x13	BOP Threshold2 Gain coefficient byte[15:8]
0x2F	BOP_THRESHOLD2_BYTT4[7:0]	0x62	BOP Threshold2 Gain coefficient byte[7:0]
0x30	THF_ATTACK_COEFF_BYT1[7:0]	0x78	THF Attack coefficient byte[31:24]
0x31	THF_ATTACK_COEFF_BYT2[7:0]	0xD6	THF Attack coefficient byte[23:16]
0x32	THF_ATTACK_COEFF_BYTT3[7:0]	0xFC	THF Attack coefficient byte[15:8]
0x33	THF_ATTACK_COEFF_BYTT4[7:0]	0x9F	THF Attack coefficient byte[7:0]
0x34	THF_RELEASE_COEFF_BYT1[7:0]	0x40	THF Release coefficient byte[31:24]
0x35	THF_RELEASE_COEFF_BYT2[7:0]	0xBD	THF Release coefficient byte[23:16]
0x36	THF_RELEASE_COEFF_BYTT3[7:0]	0xB7	THF Release coefficient byte[15:8]
0x37	THF_RELEASE_COEFF_BYTT4[7:0]	0xC0	THF Release coefficient byte[7:0]
0x38	THF_RESET_COUNTER_BYT1[7:0]	0x00	THF Hold Count coefficient byte[31:24]
0x39	THF_RESET_COUNTER_BYT2[7:0]	0x00	THF Hold Count coefficient byte[23:16]
0x3A	THF_RESET_COUNTER_BYT3[7:0]	0x09	THF Hold Count coefficient byte[15:8]
0x3B	THF_RESET_COUNTER_BYT4[7:0]	0x60	THF Hold Count coefficient byte[7:0]
0x3C	THF_TEMP_THRESHOLD_BYT1[7:0]	0x00	THF Temperature Threshold coefficient byte[31:24]
0x3D	THF_TEMP_THRESHOLD_BYT2[7:0]	0x00	THF Temperature Threshold coefficient byte[23:16]

**Table 7-213. Page 26 Programmable Coefficient Registers (continued)**

0x3E	THF_TEMP_THRESHOLD_BYTT3[7:0]	0x23	THF Temperature Threshold coefficient byte[15:8]
0x3F	THF_TEMP_THRESHOLD_BYTT4[7:0]	0x80	THF Temperature Threshold coefficient byte[7:0]
0x40	THF_MAX_ATTEN_BYT1[7:0]	0x2D	THF Max Attenuation coefficient byte[31:24]
0x41	THF_MAX_ATTEN_BYT2[7:0]	0x6A	THF Max Attenuation coefficient byte[23:16]
0x42	THF_MAX_ATTEN_BYTT3[7:0]	0x86	THF Max Attenuation coefficient byte[15:8]
0x43	THF_MAX_ATTEN_BYTT4[7:0]	0x6F	THF Max Attenuation coefficient byte[7:0]
0x44	THF_SLOPE_BYT1[7:0]	0xFE	THF Slope coefficient byte[31:24]
0x45	THF_SLOPE_BYT2[7:0]	0x66	THF Slope coefficient byte[23:16]
0x46	THF_SLOPE_BYTT3[7:0]	0x66	THF Slope coefficient byte[15:8]
0x47	THF_SLOPE_BYTT4[7:0]	0x66	THF Slope coefficient byte[7:0]
0x48	LIMITER_ATTACK_HYS_LEVEL_BYT1[7:0]	0x08	Distortion Limiter Attack Level Hysteresis coefficient byte[31:24]
0x49	LIMITER_ATTACK_HYS_LEVEL_BYT2[7:0]	0xF9	Distortion Limiter Attack Level Hysteresis coefficient byte[23:16]
0x4A	LIMITER_ATTACK_HYS_LEVEL_BYTT3[7:0]	0xE4	Distortion Limiter Attack Level Hysteresis coefficient byte[15:8]
0x4B	LIMITER_ATTACK_HYS_LEVEL_BYTT4[7:0]	0xD0	Distortion Limiter Attack Level Hysteresis coefficient byte[7:0]
0x4C	LIMITER_RELEASE_HYS_LEVEL_BYT1[7:0]	0x07	Distortion Limiter Release Level Hysteresis coefficient byte[31:24]
0x4D	LIMITER_RELEASE_HYS_LEVEL_BYT2[7:0]	0x21	Distortion Limiter Release Level Hysteresis coefficient byte[23:16]
0x4E	LIMITER_RELEASE_HYS_LEVEL_BYTT3[7:0]	0x48	Distortion Limiter Release Level Hysteresis coefficient byte[15:8]
0x4F	LIMITER_RELEASE_HYS_LEVEL_BYTT4[7:0]	0x2C	Distortion Limiter Release Level Hysteresis coefficient byte[7:0]
0x50	BOP_LEVEL_HYS_SUP_BYT1[7:0]	0x00	BOP Level Hysteresis coefficient byte[31:24]
0x51	BOP_LEVEL_HYS_SUP_BYT2[7:0]	0x00	BOP Level Hysteresis coefficient byte[23:16]
0x52	BOP_LEVEL_HYS_SUP_BYTT3[7:0]	0x00	BOP Level Hysteresis coefficient byte[15:8]
0x53	BOP_LEVEL_HYS_SUP_BYTT4[7:0]	0x14	BOP Level Hysteresis coefficient byte[7:0]
0x54	BOP_LEVEL_HYS_GAIN_BYT1[7:0]	0x03	BOP gain Hysteresis coefficient byte[31:24]
0x55	BOP_LEVEL_HYS_GAIN_BYT2[7:0]	0xD7	BOP gain Hysteresis coefficient byte[23:16]
0x56	BOP_LEVEL_HYS_GAIN_BYT3[7:0]	0x0A	BOP gain Hysteresis coefficient byte[15:8]
0x57	BOP_LEVEL_HYS_GAIN_BYT4[7:0]	0x3E	BOP gain Hysteresis coefficient byte[7:0]
0x58	THF_GAIN_HYS_BYT1[7:0]	0x03	THF gain Hysteresis coefficient byte[31:24]
0x59	THF_GAIN_HYS_BYT2[7:0]	0xD7	THF gain Hysteresis coefficient byte[23:16]
0x5A	THF_GAIN_HYS_BYTT3[7:0]	0x0A	THF gain Hysteresis coefficient byte[15:8]
0x5B	THF_GAIN_HYS_BYTT4[7:0]	0x3D	THF gain Hysteresis coefficient byte[7:0]

### 7.2.12 Programmable Coefficient Registers: Page 27

This register page shown in [Table 7-214](#) consists of the programmable coefficients for the ADC AGC.

**Table 7-214. Page 27 Programmable Coefficient Registers**

ADDRESS	REGISTER	RESET	DESCRIPTION
0x00	PAGE[7:0]	0x00	Device Page Register
0x5C	AGC_NOISE_FLOOR_BYT1[7:0]	0xFF	AGC Noise Floor coefficient byte[31:24]
0x5D	AGC_NOISE_FLOOR_BYT2[7:0]	0xFE	AGC Noise Floor coefficient byte[23:16]
0x5E	AGC_NOISE_FLOOR_BYTT3[7:0]	0xB0	AGC Noise Floor coefficient byte[15:8]
0x5F	AGC_NOISE_FLOOR_BYTT4[7:0]	0x00	AGC Noise Floor coefficient byte[7:0]
0x60	AGC_TARGET_LEVEL_BYT1[7:0]	0xFF	AGC Target Level coefficient byte[31:24]
0x61	AGC_TARGET_LEVEL_BYT2[7:0]	0xFF	AGC Target Level coefficient byte[23:16]
0x62	AGC_TARGET_LEVEL_BYTT3[7:0]	0x78	AGC Target Level coefficient byte[15:8]
0x63	AGC_TARGET_LEVEL_BYTT4[7:0]	0x00	AGC Target Level coefficient byte[7:0]
0x64	AGC_NOISE_COUNT_MAX_BYT1[7:0]	0x00	AGC Noise Floor Hold Count coefficient byte[31:24]
0x65	AGC_NOISE_COUNT_MAX_BYT2[7:0]	0x00	AGC Noise Floor Hold Count coefficient byte[23:16]
0x66	AGC_NOISE_COUNT_MAX_BYTT3[7:0]	0x04	AGC Noise Floor Hold Count coefficient byte[15:8]
0x67	AGC_NOISE_COUNT_MAX_BYTT4[7:0]	0xB0	AGC Noise Floor Hold Count coefficient byte[7:0]
0x68	AGC_MAX_GAIN_BYT1[7:0]	0x00	AGC Maximum Gain coefficient byte[31:24]
0x69	AGC_MAX_GAIN_BYT2[7:0]	0x00	AGC Maximum Gain coefficient byte[23:16]
0x6A	AGC_MAX_GAIN_BYTT3[7:0]	0x60	AGC Maximum Gain coefficient byte[15:8]
0x6B	AGC_MAX_GAIN_BYTT4[7:0]	0x00	AGC Maximum Gain coefficient byte[7:0]
0x6C	AGC_MIN_GAIN_BYT1[7:0]	0xFF	AGC Minimum Gain coefficient byte[31:24]
0x6D	AGC_MIN_GAIN_BYT2[7:0]	0xFF	AGC Minimum Gain coefficient byte[23:16]
0x6E	AGC_MIN_GAIN_BYTT3[7:0]	0x88	AGC Minimum Gain coefficient byte[15:8]
0x6F	AGC_MIN_GAIN_BYTT4[7:0]	0x00	AGC Minimum Gain coefficient byte[7:0]
0x70	AGC_NOISE_HYS_BYT1[7:0]	0x00	AGC Noise Gate Hysteresis coefficient byte[31:24]
0x71	AGC_NOISE_HYS_BYT2[7:0]	0x00	AGC Noise Gate Hysteresis coefficient byte[23:16]
0x72	AGC_NOISE_HYS_BYTT3[7:0]	0x18	AGC Noise Gate Hysteresis coefficient byte[15:8]
0x73	AGC_NOISE_HYS_BYTT4[7:0]	0x00	AGC Noise Gate Hysteresis coefficient byte[7:0]
0x74	AGC_ATTACK_HOLD_COUNT_BYT1[7:0]	0x00	AGC Attack Hold Count coefficient byte[31:24]
0x75	AGC_ATTACK_HOLD_COUNT_BYT2[7:0]	0x00	AGC Attack Hold Count coefficient byte[23:16]
0x76	AGC_ATTACK_HOLD_COUNT_BYTT3[7:0]	0x00	AGC Attack Hold Count coefficient byte[15:8]
0x77	AGC_ATTACK_HOLD_COUNT_BYTT4[7:0]	0x01	AGC Attack Hold Count coefficient byte[7:0]
0x78	AGC_RELEASE_HOLD_COUNT_BYT1[7:0]	0x00	AGC Release Hold Count coefficient byte[31:24]
0x79	AGC_RELEASE_HOLD_COUNT_BYT2[7:0]	0x00	AGC Release Hold Count coefficient byte[23:16]
0x7A	AGC_RELEASE_HOLD_COUNT_BYTT3[7:0]	0x04	AGC Release Hold Count coefficient byte[15:8]



**Table 7-214. Page 27 Programmable Coefficient Registers (continued)**

0x7B	AGC_RELEASE_HOLD_COUNT_BYTT4[7:0]	0xB0	AGC Release Hold Count coefficient byte[7:0]
0x7C	AGC_RELEASE_HYST_BYT1[7:0]	0x00	AGC Release Hysteresis coefficient byte[31:24]
0x7D	AGC_RELEASE_HYST_BYT2[7:0]	0x00	AGC Release Hysteresis coefficient byte[23:16]
0x7E	AGC_RELEASE_HYST_BYTT3[7:0]	0x08	AGC Release Hysteresis coefficient byte[15:8]
0x7F	AGC_RELEASE_HYST_BYTT4[7:0]	0x00	AGC Release Hysteresis coefficient byte[7:0]

**7.2.13 Programmable Coefficient Registers: Page 28**

This register page shown in [Table 7-215](#) consists of the programmable coefficients for the ADC AGC and DAC DRC.

**Table 7-215. Page 28 Programmable Coefficient Registers**

ADDRESS	REGISTER	RESET	DESCRIPTION
0x00	PAGE[7:0]	0x00	Device Page Register
0x08	AGC_ATTACK_RATE_BYT1[7:0]	0x50	AGC Attack Rate coefficient byte[31:24]
0x09	AGC_ATTACK_RATE_BYT2[7:0]	0xFC	AGC Attack Rate coefficient byte[23:16]
0x0A	AGC_ATTACK_RATE_BYTT3[7:0]	0x64	AGC Attack Rate coefficient byte[15:8]
0x0B	AGC_ATTACK_RATE_BYTT4[7:0]	0x5C	AGC Attack Rate coefficient byte[7:0]
0x0C	AGC_RELEASE_RATE_BYT1[7:0]	0x7F	AGC Release Rate coefficient byte[31:24]
0x0D	AGC_RELEASE_RATE_BYT2[7:0]	0xC4	AGC Release Rate coefficient byte[23:16]
0x0E	AGC_RELEASE_RATE_BYTT3[7:0]	0x0E	AGC Release Rate coefficient byte[15:8]
0x0F	AGC_RELEASE_RATE_BYTT4[7:0]	0x57	AGC Release Rate coefficient byte[7:0]
0x1C	DRC_MAX_GAIN_BYT1[7:0]	0x00	DRC Maximum Gain (dB) coefficient byte[31:24]
0x1D	DRC_MAX_GAIN_BYT2[7:0]	0x00	DRC Maximum Gain (dB) coefficient byte[23:16]
0x1E	DRC_MAX_GAIN_BYTT3[7:0]	0x60	DRC Maximum Gain (dB) coefficient byte[15:8]
0x1F	DRC_MAX_GAIN_BYTT4[7:0]	0x00	DRC Maximum Gain (dB) coefficient byte[7:0]
0x20	DRC_MIN_GAIN_BYT1[7:0]	0xFF	DRC Minimum Gain (dB) coefficient byte[31:24]
0x21	DRC_MIN_GAIN_BYT2[7:0]	0xFF	DRC Minimum Gain (dB) coefficient byte[23:16]
0x22	DRC_MIN_GAIN_BYTT3[7:0]	0x82	DRC Minimum Gain (dB) coefficient byte[15:8]
0x23	DRC_MIN_GAIN_BYTT4[7:0]	0x00	DRC Minimum Gain (dB) coefficient byte[7:0]
0x24	DRC_ATTACK_TC_BYT1[7:0]	0x67	DRC Attack Time Constant coefficient byte[31:24]
0x25	DRC_ATTACK_TC_BYT2[7:0]	0xED	DRC Attack Time Constant coefficient byte[23:16]
0x26	DRC_ATTACK_TC_BYTT3[7:0]	0x87	DRC Attack Time Constant coefficient byte[15:8]
0x27	DRC_ATTACK_TC_BYTT4[7:0]	0xBB	DRC Attack Time Constant coefficient byte[7:0]
0x28	DRC_RELEASE_TC_BYT1[7:0]	0x7E	DRC Release Time Constant coefficient byte[31:24]
0x29	DRC_RELEASE_TC_BYT2[7:0]	0xAC	DRC Release Time Constant coefficient byte[23:16]
0x2A	DRC_RELEASE_TC_BYTT3[7:0]	0x70	DRC Release Time Constant coefficient byte[15:8]
0x2B	DRC_RELEASE_TC_BYTT4[7:0]	0x34	DRC Release Time Constant coefficient byte[7:0]

**Table 7-215. Page 28 Programmable Coefficient Registers (continued)**

0x2C	DRC_RELEASE_HOLD_COUNT_BYT1[7:0]	0x00	DRC Release Hold Count coefficient byte[31:24]
0x2D	DRC_RELEASE_HOLD_COUNT_BYT2[7:0]	0x00	DRC Release Hold Count coefficient byte[23:16]
0x2E	DRC_RELEASE_HOLD_COUNT_BYTT3[7:0]	0x04	DRC Release Hold Count coefficient byte[15:8]
0x2F	DRC_RELEASE_HOLD_COUNT_BYTT4[7:0]	0xB0	DRC Release Hold Count coefficient byte[7:0]
0x30	DRC_RELEASE_HYST_BYT1[7:0]	0x00	DRC Release Hysteresis coefficient byte[31:24]
0x31	DRC_RELEASE_HYST_BYT2[7:0]	0x00	DRC Release Hysteresis coefficient byte[23:16]
0x32	DRC_RELEASE_HYST_BYTT3[7:0]	0x0C	DRC Release Hysteresis coefficient byte[15:8]
0x33	DRC_RELEASE_HYST_BYTT4[7:0]	0x00	DRC Release Hysteresis coefficient byte[7:0]
0x34	DRC_INV_RATIO_BYT1[7:0]	0xF8	DRC Ratio coefficient byte[31:24]
0x35	DRC_INV_RATIO_BYT2[7:0]	0x00	DRC Ratio coefficient byte[23:16]
0x36	DRC_INV_RATIO_BYTT3[7:0]	0x00	DRC Ratio coefficient byte[15:8]
0x37	DRC_INV_RATIO_BYTT4[7:0]	0x00	DRC Ratio coefficient byte[7:0]
0x38	DRC_INFLECTION_PT_BYT1[7:0]	0xFF	DRC Inflection Point(dB) coefficient byte[31:24]
0x39	DRC_INFLECTION_PT_BYT2[7:0]	0xFF	DRC Inflection Point(dB) coefficient byte[23:16]
0x3A	DRC_INFLECTION_PT_BYTT3[7:0]	0xA0	DRC Inflection Point(dB) coefficient byte[15:8]
0x3B	DRC_INFLECTION_PT_BYTT4[7:0]	0x00	DRC Inflection Point(dB) coefficient byte[7:0]
0x40	DAC_ADSR_NOTE_BYT1[7:0]	0x00	ADSR Enable/Disable coefficient byte[31:24]
0x41	DAC_ADSR_NOTE_BYT2[7:0]	0x00	ADSR Enable/Disable coefficient byte[23:16]
0x42	DAC_ADSR_NOTE_BYT3[7:0]	0x00	ADSR Enable/Disable coefficient byte[15:8]
0x43	DAC_ADSR_NOTE_BYT4[7:0]	0x00	ADSR Enable/Disable coefficient byte[7:0]
0x50	DAC_ADSR_RESTART_TIMER_BYT1[7:0]	0x00	ADSR Restart Count coefficient byte[31:24]
0x51	DAC_ADSR_RESTART_TIMER_BYT2[7:0]	0x00	ADSR Restart Count coefficient byte[23:16]
0x52	DAC_ADSR_RESTART_TIMER_BYT3[7:0]	0x25	ADSR Restart Count coefficient byte[15:8]
0x53	DAC_ADSR_RESTART_TIMER_BYT4[7:0]	0x80	ADSR Restart Count coefficient byte[7:0]
0x54	DAC_ADSR_SUSTAIN_TIMER_BYT1[7:0]	0x00	ADSR Sustain Count coefficient byte[31:24]
0x55	DAC_ADSR_SUSTAIN_TIMER_BYT2[7:0]	0x00	ADSR Sustain Count coefficient byte[23:16]
0x56	DAC_ADSR_SUSTAIN_TIMER_BYT3[7:0]	0x03	ADSR Sustain Count coefficient byte[15:8]
0x57	DAC_ADSR_SUSTAIN_TIMER_BYT4[7:0]	0xC0	ADSR Sustain Count coefficient byte[7:0]
0x58	DAC_ADSR_DELATTACK_BYT1[7:0]	0x00	ADSR Attack Slope coefficient byte[31:24]
0x59	DAC_ADSR_DELATTACK_BYT2[7:0]	0x44	ADSR Attack Slope coefficient byte[23:16]

**Table 7-215. Page 28 Programmable Coefficient Registers (continued)**

0x5A	DAC_ADSR_DELATTACK_BYT3[7:0]	0x52	ADSR Attack Slope coefficient byte[15:8]
0x5B	DAC_ADSR_DELATTACK_BYT4[7:0]	0x3F	ADSR Attack Slope coefficient byte[7:0]
0x5C	DAC_ADSR_DELRELEASE_BYT1[7:0]	0xFF	ADSR Release Slope coefficient byte[31:24]
0x5D	DAC_ADSR_DELRELEASE_BYT2[7:0]	0xBB	ADSR Release Slope coefficient byte[23:16]
0x5E	DAC_ADSR_DELRELEASE_BYT3[7:0]	0xAD	ADSR Release Slope coefficient byte[15:8]
0x5F	DAC_ADSR_DELRELEASE_BYT4[7:0]	0xC1	ADSR Release Slope coefficient byte[7:0]
0x60	DAC_ADSR_DELDECAY_BYT1[7:0]	0x00	ADSR Decay Slope coefficient byte[31:24]
0x61	DAC_ADSR_DELDECAY_BYT2[7:0]	0x00	ADSR Decay Slope coefficient byte[23:16]
0x62	DAC_ADSR_DELDECAY_BYT3[7:0]	0x00	ADSR Decay Slope coefficient byte[15:8]
0x63	DAC_ADSR_DELDECAY_BYT4[7:0]	0x00	ADSR Decay Slope coefficient byte[7:0]
0x64	DAC_ADSR_SUSLVL_BYT1[7:0]	0x40	ADSR Sustain Level coefficient byte[31:24]
0x65	DAC_ADSR_SUSLVL_BYT2[7:0]	0x00	ADSR Sustain Level coefficient byte[23:16]
0x66	DAC_ADSR_SUSLVL_BYT3[7:0]	0x00	ADSR Sustain Level coefficient byte[15:8]
0x67	DAC_ADSR_SUSLVL_BYT4[7:0]	0x00	ADSR Sustain Level coefficient byte[7:0]

## 8 Application and Implementation

### Note

Information in the following applications sections is not part of the TI component specification, and TI does not warrant its accuracy or completeness. TI's customers are responsible for determining suitability of components for their purposes, as well as validating and testing their design implementation to confirm system functionality.

### 8.1 Application Information

The TAD5212 is a stereo, high-performance audio DAC that supports sample rates of up to 768 kHz. The device supports up to 4 channel simultaneous playback which can be configured as a 2-channel differential or pseudo-differential output or up to 4-channel single-ended output with options for headphone and line-out drive capabilities. The device also supports up to 4 channel recording using digital pulse density (PDM) microphones using the multi-function general purpose input/output pins.

Communication to the TAD5212 for configuration of the control registers is supported using an I<sup>2</sup>C or SPI interface. The device supports a highly flexible, audio serial interface (TDM, I<sup>2</sup>S, and LJ) to transmit audio data seamlessly in the system across devices.

### 8.2 Typical Application

#### 8.2.1 Application

Figure 8-1 shows a typical configuration of the TAD5212 for an application using two channel line-out operation with an I<sup>2</sup>C control interface and a time-division multiplexing (TDM) audio data target interface.

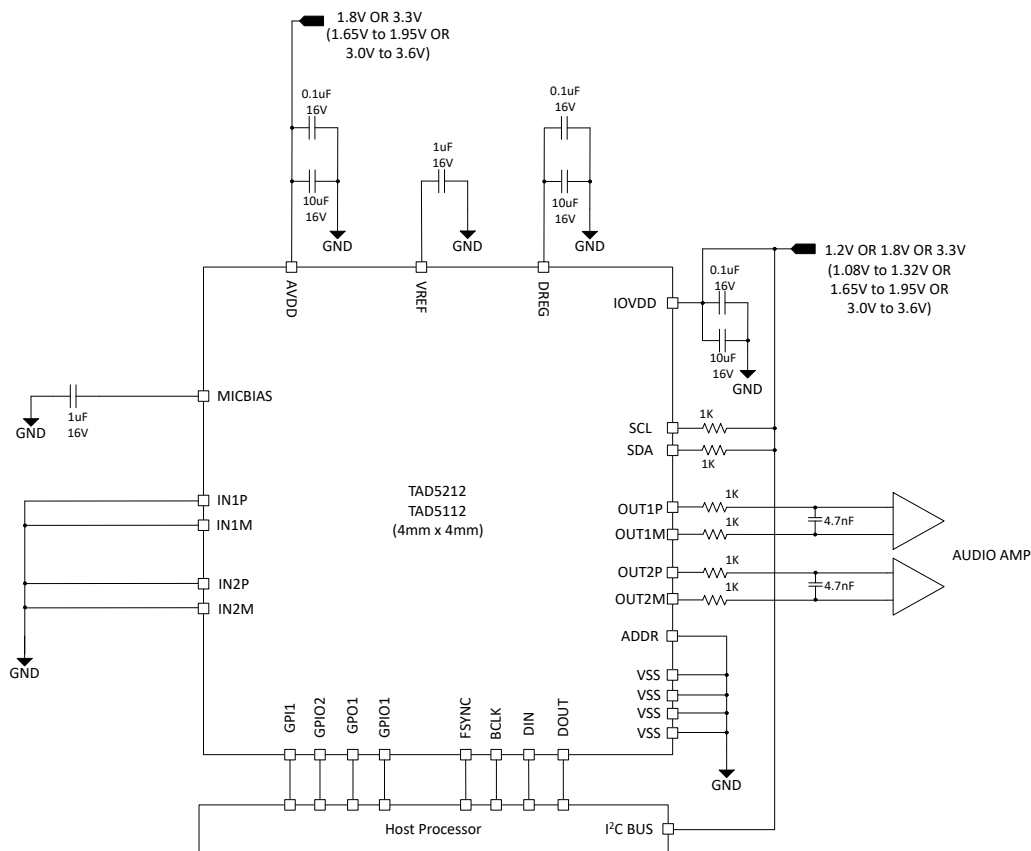

Figure 8-1. Stereo Lineout Block Diagram

## 8.2.2 Design Requirements

Table 8-1 lists the design parameters for this application.

**Table 8-1. Design Parameters**

PARAMETER	VALUE
AVDD	1.8V or 3.3V
IOVDD	1.2V or 1.8V or 3.3V
AVDD supply current consumption	17mA, with AVDD = 3.3V (MICBIAS off, PLL on, stereo playback, $f_s = 48\text{kHz}$ )
IOVDD supply current consumption	0.04mA, with IOVDD = 3.3V
Maximum MICBIAS current	5mA
Load on OUT1M, OUT1P, OUT2M, OUT2P	>600Ω

## 8.2.3 Detailed Design Procedure

This section describes the necessary steps to configure the TAD5212 for this specific application. The following steps provide a sequence of items that must be executed in the time between powering the device up and reading data from the device or transitioning from one mode to another mode of operation.

1. Apply power to the device:
  - a. Power up the IOVDD and AVDD power supplies
  - b. Wait for at least 2ms to allow the device to initialize the internal registers.
  - c. The device now goes into sleep mode (low-power mode < 10μA)
2. Transition from sleep mode to active mode whenever required for the operation:
  - a. Wake up the device by writing to P0\_R2 to disable sleep mode
  - b. Wait for at least 2ms to allow the device to complete the internal wake-up sequence
  - c. Override the default configuration registers or programmable coefficients value as required (this step is optional)
  - d. Enable all desired audio serial interface input/output channels by writing to P0\_R40 to P0\_R47 for DAC
  - e. Power-up the DAC by writing to P0\_R120
  - f. Apply FSYNC and BCLK with the desired output sample rates and the BCLK to FSYNC ratio

This specific step can be done at any point in the sequence after step a.

See the [Section 6.3.2](#) section for supported sample rates and the BCLK to FSYNC ratio.

- g. The device playback data is now received from the host processor using the TDM audio serial data bus and this playback data from TDM is now played on the line-out
3. Transition from active mode to sleep mode (again) as required in the system for low-power operation:
  - a. Enter sleep mode by writing to P0\_R2 to enable sleep mode
  - b. Wait at least 10ms (when FSYNC = 48kHz) for the volume to ramp down and for all blocks to power down
  - c. Read P0\_R122 to check the device shutdown and sleep mode status
  - d. If the device P0\_R122\_D[7:5] status bit is 3'b100 then stop FSYNC and BCLK in the system
  - e. The device now goes into sleep mode (low-power mode < 10μA) and retains all register values
4. Transition from sleep mode to active mode (again) as required for the recording operation:
  - a. Wake up the device by writing to P0\_R2 to disable sleep mode
  - b. Wait at least 2ms to allow the device to complete the internal wake-up sequence
  - c. Apply FSYNC and BCLK with the desired output sample rates and the BCLK to FSYNC ratio
  - d. The device playback data is now received from the host processor using the TDM audio serial data bus and this playback data from TDM is now played on the line-out
5. Repeat the steps as required for different device configurations and modes of operation

## 8.2.4 Application Performance Plots

At  $T_A = 25^\circ\text{C}$ , AVDD = 3.3V, IOVDD = 3.3V,  $f_{IN} = 1\text{kHz}$  sinusoidal signal,  $f_s = 48\text{kHz}$ , 32-bit audio data, BCLK =  $256 \times f_s$ , TDM target mode, PLL on, channel gain = 0dB, linear phase interpolation filters, 1200Ω line-out load

in differential configuration, and other default configurations; measured filter free with an audio precision with a 20Hz to 20kHz un-weighted bandwidth, unless otherwise noted

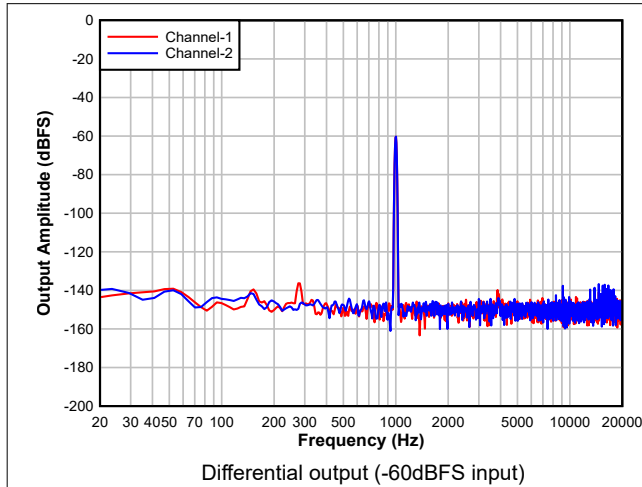

Figure 8-2. DAC FFT with -60dBFS Input

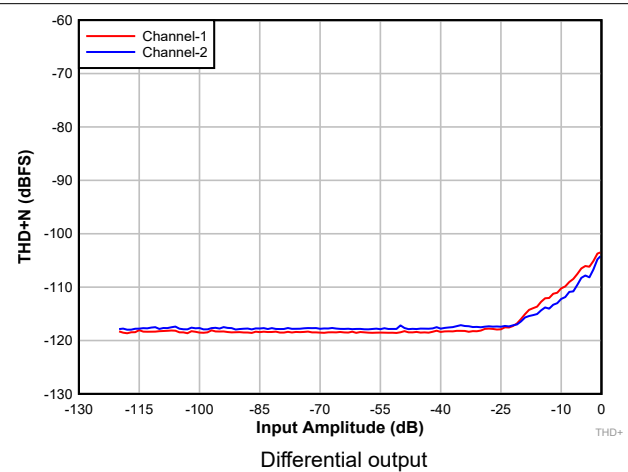

Figure 8-3. DAC THD+N Level vs Input

### 8.2.5 Example Device Register Configuration Script for EVM Setup

This section provides a typical EVM I<sup>2</sup>C register control script for various applications

#### Stereo differential line output playback

```
# Key: w a0 XX YY ==> write to I2C address 0xa0, to register 0xxx, data 0xyy
# # ==> comment delimiter
#
# The following list gives an example sequence of items that must be executed in the time
# between powering the device up and reading data from the device. Note that there are
# other valid sequences depending on which features are used.
#
# Differential 2-channel Line Out DAC: OUT1P/OUT1M - Ch1, OUT2P/OUT2M - Ch2
# FSYNC = 48 kHz (Output Data Sample Rate), BCLK = 12.288 MHz (BCLK/FSYNC = 256)
# AVDD = 3.3 V; IOVDD = 3.3 V
#####
#
#
# Page 0 Register Writes
w a0 00 00
w a0 01 01 #SW Reset
d 01
# Page 0 Register Writes
w a0 00 00
w a0 02 09 #Exit Sleep Mode with DREG and VREF Enabled
w a0 1a 30 #TDM protocol with 32-bit word length
w a0 64 20 #DAC Channel 1 configured for differential output with 0.6*vref as common mode
w a0 65 20 #DAC OUT1P configured for line out driver and audio bandwidth
w a0 66 20 #DAC OUT1M configured for line out driver and audio bandwidth
w a0 6b 20 #DAC Channel 2 configured for differential output with 0.6*vref as common mode
w a0 6c 20 #DAC OUT2P configured for line out driver and audio bandwidth
w a0 6d 20 #DAC OUT2M configured for line out driver and audio bandwidth
w a0 76 0c #Output channels 1, 2 enabled
w a0 78 40 #DAC Powered Up
# Apply FSYNC = 48 kHz and BCLK = 12.288 MHz and
# Start playback data by host on ASI bus with TDM protocol 32-bits channel wordlength
```

#### Four-channel PDM microphone recording

```
# Key: w a0 XX YY ==> write to I2C address 0xa0, to register 0xxx, data 0xyy
# # ==> comment delimiter
#
```

```
# The following list gives an example sequence of items that must be executed in the time
# between powering the device up and reading data from the device. Note that there are
# other valid sequences depending on which features are used.
#
# GPIO1 - PDMCLK @ 3.072MHz
# PDM Ch1/2 on GPIO2
# PDM Ch3/4 on GPI1
# FSYNC = 48kHz (Output Data Sample Rate), BCLK = 12.288MHz (BCLK/FSYNC = 256)
# AVDD = 3.3V; IOVDD = 3.3V
#####
#
# Page 0 Register Writes
w a0 00 00
w a0 01 01 #SW Reset
d 01
# Page 0 Register Writes
w a0 00 00
w a0 02 09 #Exit Sleep Mode with DREG and VREF Enabled
w a0 0a 41 #Configure GPIO1 as PDMCLK, with active high/active low drive
w a0 35 00 #PDMCLK frequency = 3.072MHz
w a0 0b 10 #Configure GPIO2 as GPI input
w a0 0d 02 #Configure GPI1 as GPI input
w a0 13 cb #Configure Channel1 and Channel2 as PDM; PDM1/2 data in on GPIO2; PDM3/4 data in on GPI1
w a0 1a 30 #TDM protocol with 32-bit word length
w a0 1e 20 #Channel1 data on TDM slot 0
w a0 1f 21 #Channel2 data on TDM slot 1
w a0 20 22 #Channel3 data on TDM slot 2
w a0 21 23 #Channel4 data on TDM slot 3
w a0 76 f0 #Enable input channels 1-4
w a0 78 80 #Power Up ADC path
# Provide BCLK, FSYNC corresponding to 48kSPS, and record with 32-bit TDM bus
```

### 8.3 Power Supply Recommendations

The power-supply sequence between the IOVDD and AVDD rails can be applied in any order. However, only initiate the I<sup>2</sup>C or SPI transactions to initialize the device after all supplies are stable.

For the supply power-up requirement,  $t_1$ ,  $t_2$  must be at least 2ms to allow the device to initialize the internal registers. See the [Section 6.4](#) section for details on how the device operates in various modes after the device power supplies are settled to the recommended operating voltage levels. For the supply power-down requirement,  $t_4$ ,  $t_5$  and  $t_6$  must be at least 10ms. This timing (as shown in [Figure 8-4](#)) allows the device to ramp down the volume on the record data, power down the analog and digital blocks, and put the device into shutdown mode. The device can also be immediately put into shutdown mode by ramping down power supplies, but doing so causes an abrupt shutdown.

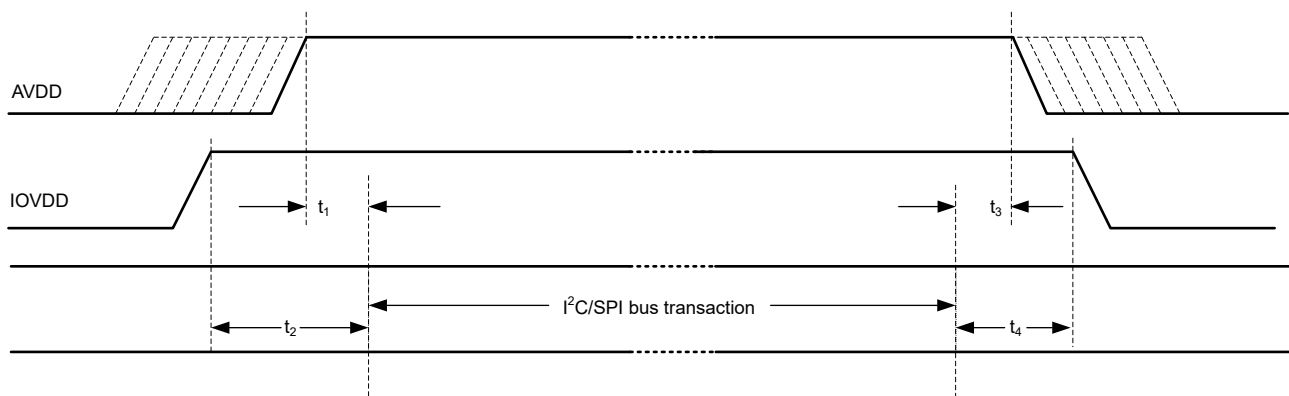

**Figure 8-4. Power-Supply Sequencing Requirement Timing Diagram**

Make sure that the supply ramp rate is slower than 0.1V/ $\mu$ s and that the wait time between a power-down and a power-up event is at least 100ms. For supply ramp rate slower than 0.1V/ms, host device must apply a software reset as first transaction before doing any device configuration. Make sure all digital input pins are at valid input levels and not toggling during supply sequencing.

The TAD5212 supports a single AVDD supply operation by integrating an on-chip digital regulator, DREG, and an integrated analog regulator. Ensure AVDD\_MODE (P0\_R2\_D[2]) and IOVDD\_IO\_MODE (P0\_R2\_D[1]) registers are set correctly for AVDD 1.8V operation and for IOVDD 1.8V and 1.2V operation as described in [Section 8.3.1](#) and [Section 8.3.2](#) respectively.

### 8.3.1 AVDD\_MODE for 1.8V Operation

After the supplies are stable, whenever using AVDD 1.8V operation, always set the AVDD\_MODE (P0\_R2\_D[2]) setting to 1'b1 right after power-up to set the correct analog regulator (AREG) voltage. This setting is not needed when using AVDD 3.3V operation.

### 8.3.2 IOVDD\_IO\_MODE for 1.8V and 1.2V Operation

After the supplies are stable, the default register configuration of the device has a speed limitation on the maximum clock speed that can be supported for IOVDD = 1.8V or 1.2V at first power up of device with default configurations except for the first write operation. Whenever using IOVDD 1.8V and 1.2V operation, the first operation by user should always be to write the IOVDD\_IO\_MODE (P0\_R2\_D[1]) setting to 1'b1 after power-up or reset, and then there are no speed limitations in subsequent operation of device. This setting is not needed or applicable when using IOVDD 3.3V operation.

## 8.4 Layout

### 8.4.1 Layout Guidelines

Each system design and printed circuit board (PCB) layout is unique. The layout must be carefully reviewed in the context of a specific PCB design. However, the following guidelines can optimize the device performance:

- Connect the thermal pad to ground. Use a via pattern to connect the device thermal pad, which is the area directly under the device, to the ground planes. This connection helps dissipate heat from the device.
- Star connect all ground pins to the board ground plane. Use the same ground between VSS pins to avoid any potential voltage difference between them.
- The decoupling capacitors for the power supplies must be placed close to the device pins.
- Route the analog differential audio signals differentially on the PCB for better noise immunity. Avoid crossing digital and analog signals to prevent undesirable crosstalk.
- Avoid running high-frequency clock and control signals near INxx and OUTxx pins where possible.
- The device internal voltage references must be filtered using external capacitors. Place the filter capacitors near the VREF pin for good performance.
- Directly tap the MICBIAS pin to avoid common impedance when routing the biasing or supply traces for multiple microphones to avoid coupling across microphones.
- Provide a direct connection from the VREF and MICBIAS external capacitor ground terminal to VSS.
- Place the MICBIAS capacitor (with low equivalent series resistance) close to the device with minimal trace impedance.
- Use ground planes to provide the lowest impedance for power and signal current between the device and the decoupling capacitors. Treat the area directly under the device as a central ground area for the device, and all device grounds must be connected directly to that area.



### 8.4.2 Layout Example

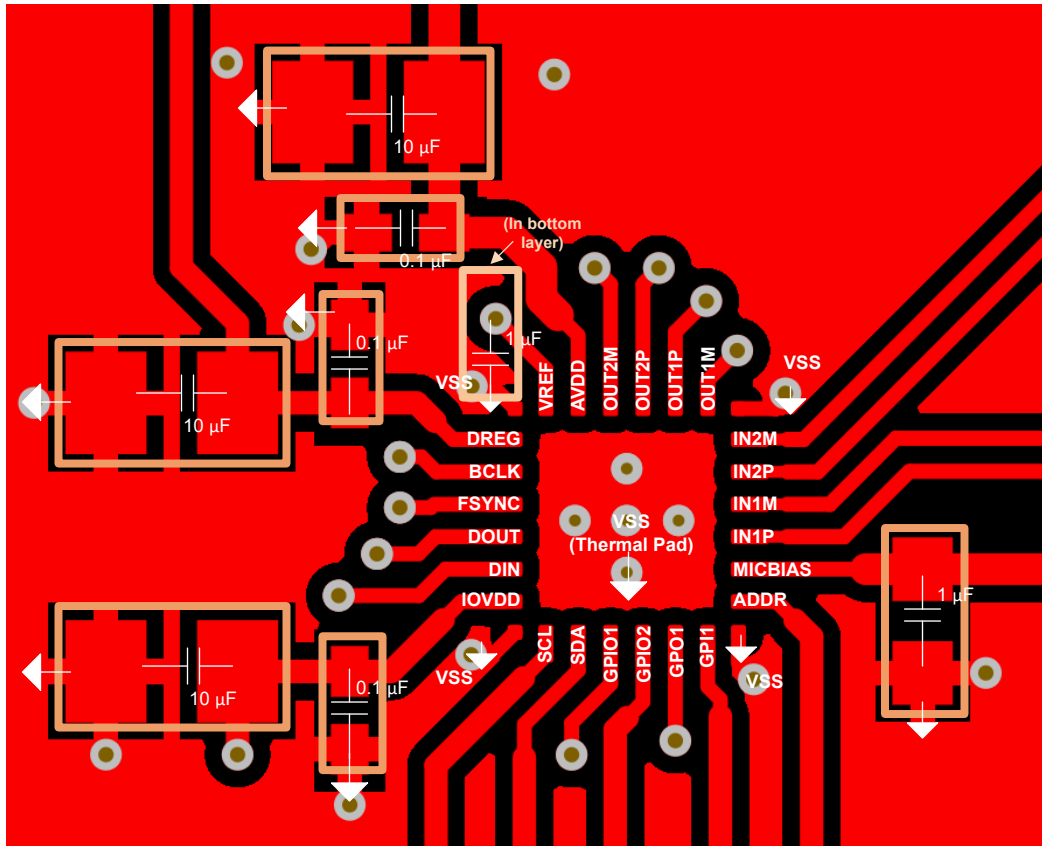

Figure 8-5. Example Layout

## 9 Device and Documentation Support

TI offers an extensive line of development tools. Tools and software to evaluate the performance of the device, generate code, and develop solutions are listed below.

### 9.1 Documentation Support

#### 9.1.1 Related Documentation

For related documentation see the following:

- Texas Instruments, [TAX5x12EVM-K Evaluation Module User's Guide](#)
- Texas Instruments, [TAX5X1X Synchronous Sample Rate Conversion application report](#)
- Texas Instruments, [Clocking Configuration of Device and Flexible Clocking For TAX5x1x Family application report](#)
- Texas Instruments, [Clock Error Configuration, Detection, and Modes Supported in TAX5x1x Family application report](#)
- Texas Instruments, [TAC5x1x and TAC5x1x-Q1 Programmable Biquad Filters - Configuration and Applications application report](#)
- Texas Instruments, [Tone Generation and Application Modes of TAX5x1x Devices application report](#)
- Texas Instruments, [TAD5x1x Power Consumption Matrix Across Various Usage Scenarios application report](#)
- Texas Instruments, [Output Swings and Common-mode Settings in AC-coupled and DC-coupled DAC application report](#)
- Texas Instruments, [Dynamic Voltage and Temperature Tracking Based Limiter in TAX5XXX-Q1 application report](#)
- Texas Instruments, [Inter Chip Limiter Alignment in TAX5xxx-Q1 Devices application report](#)
- Texas Instruments, [Headset Detection for TAX52xx Family application report](#)
- Texas Instruments, [Improving out-of-band noise and click and pop noise in TAD5xx2 devices application report](#)
- Texas Instruments, [Using the TAX5x1x Programmable Digital Channel Mixer application report](#)
- Texas Instruments, [Multiple TAC5x1x Devices With a Shared TDM and I2C/SPI Bus application report](#)
- Texas Instruments, [TAC5212 Integrated Analog Antialiasing Filter and Flexible Digital Filter application report](#)
- Texas Instruments, [TAC5212 Sampling Rates and Programmable Processing Blocks Supported application report](#)
- Texas Instruments, [Audio ADC, DAC, and CODEC for Professional Audio and Music Applications application report](#)

### 9.2 Receiving Notification of Documentation Updates

To receive notification of documentation updates, navigate to the device product folder on [ti.com](#). Click on *Notifications* to register and receive a weekly digest of any product information that has changed. For change details, review the revision history included in any revised document.

### 9.3 Support Resources

TI E2E™ [support forums](#) are an engineer's go-to source for fast, verified answers and design help — straight from the experts. Search existing answers or ask your own question to get the quick design help you need.

Linked content is provided "AS IS" by the respective contributors. They do not constitute TI specifications and do not necessarily reflect TI's views; see TI's [Terms of Use](#).

### 9.4 Trademarks

TI E2E™ is a trademark of Texas Instruments.

All trademarks are the property of their respective owners.

## 9.5 Electrostatic Discharge Caution



This integrated circuit can be damaged by ESD. Texas Instruments recommends that all integrated circuits be handled with appropriate precautions. Failure to observe proper handling and installation procedures can cause damage.

ESD damage can range from subtle performance degradation to complete device failure. Precision integrated circuits may be more susceptible to damage because very small parametric changes could cause the device not to meet its published specifications.

## 9.6 Glossary

[TI Glossary](#) This glossary lists and explains terms, acronyms, and definitions.

## 10 Revision History

NOTE: Page numbers for previous revisions may differ from page numbers in the current version.

<b>Changes from Revision * (January 2024) to Revision A (January 2025)</b>	<b>Page</b>
• Updated device status to production data.....	<b>1</b>

## 11 Mechanical, Packaging, and Orderable Information

The following pages include mechanical, packaging, and orderable information. This information is the most current data available for the designated devices. This data is subject to change without notice and revision of this document. For browser-based versions of this data sheet, refer to the left-hand navigation.

**PACKAGING INFORMATION**

Orderable Device	Status (1)	Package Type	Package Drawing	Pins	Package Qty	Eco Plan (2)	Lead finish/ Ball material (6)	MSL Peak Temp (3)	Op Temp (°C)	Device Marking (4/5)	Samples
TAD5212IRGER	ACTIVE	VQFN	RGE	24	3000	RoHS & Green	NIPDAU	Level-2-260C-1 YEAR	-40 to 125	TAD5212	Samples

(1) The marketing status values are defined as follows:

**ACTIVE:** Product device recommended for new designs.

**LIFEBUY:** TI has announced that the device will be discontinued, and a lifetime-buy period is in effect.

**NRND:** Not recommended for new designs. Device is in production to support existing customers, but TI does not recommend using this part in a new design.

**PREVIEW:** Device has been announced but is not in production. Samples may or may not be available.

**OBSELETE:** TI has discontinued the production of the device.

(2) **RoHS:** TI defines "RoHS" to mean semiconductor products that are compliant with the current EU RoHS requirements for all 10 RoHS substances, including the requirement that RoHS substance do not exceed 0.1% by weight in homogeneous materials. Where designed to be soldered at high temperatures, "RoHS" products are suitable for use in specified lead-free processes. TI may reference these types of products as "Pb-Free".

**RoHS Exempt:** TI defines "RoHS Exempt" to mean products that contain lead but are compliant with EU RoHS pursuant to a specific EU RoHS exemption.

**Green:** TI defines "Green" to mean the content of Chlorine (Cl) and Bromine (Br) based flame retardants meet JS709B low halogen requirements of <=1000ppm threshold. Antimony trioxide based flame retardants must also meet the <=1000ppm threshold requirement.

(3) MSL, Peak Temp. - The Moisture Sensitivity Level rating according to the JEDEC industry standard classifications, and peak solder temperature.

(4) There may be additional marking, which relates to the logo, the lot trace code information, or the environmental category on the device.

(5) Multiple Device Markings will be inside parentheses. Only one Device Marking contained in parentheses and separated by a "-" will appear on a device. If a line is indented then it is a continuation of the previous line and the two combined represent the entire Device Marking for that device.

(6) Lead finish/Ball material - Orderable Devices may have multiple material finish options. Finish options are separated by a vertical ruled line. Lead finish/Ball material values may wrap to two lines if the finish value exceeds the maximum column width.

**Important Information and Disclaimer:**The information provided on this page represents TI's knowledge and belief as of the date that it is provided. TI bases its knowledge and belief on information provided by third parties, and makes no representation or warranty as to the accuracy of such information. Efforts are underway to better integrate information from third parties. TI has taken and continues to take reasonable steps to provide representative and accurate information but may not have conducted destructive testing or chemical analysis on incoming materials and chemicals. TI and TI suppliers consider certain information to be proprietary, and thus CAS numbers and other limited information may not be available for release.

In no event shall TI's liability arising out of such information exceed the total purchase price of the TI part(s) at issue in this document sold by TI to Customer on an annual basis.

**OTHER QUALIFIED VERSIONS OF TAD5212 :**

- Automotive : [TAD5212-Q1](#)

NOTE: Qualified Version Definitions:

- Automotive - Q100 devices qualified for high-reliability automotive applications targeting zero defects

## GENERIC PACKAGE VIEW

RGE 24

VQFN - 1 mm max height

PLASTIC QUAD FLATPACK - NO LEAD

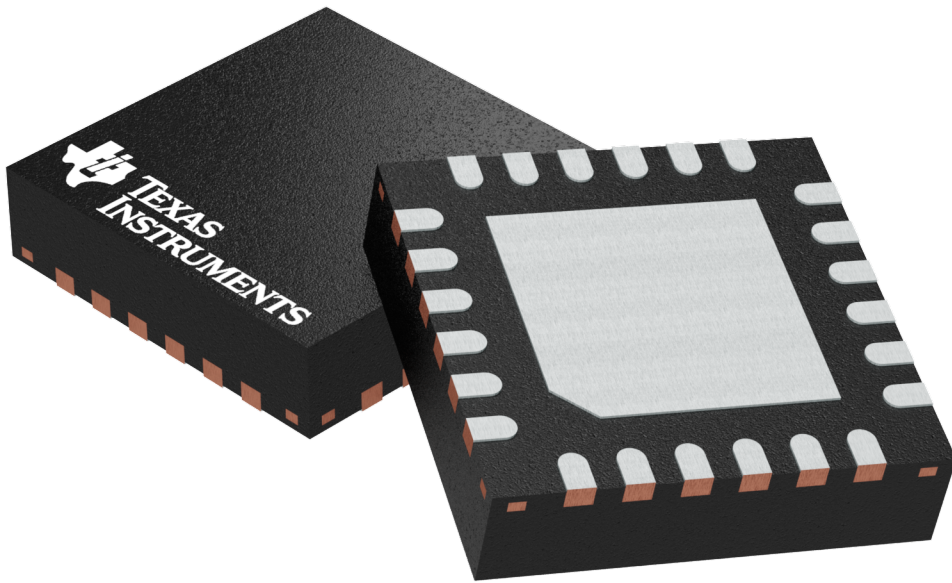

Images above are just a representation of the package family, actual package may vary.  
Refer to the product data sheet for package details.

4204104/H

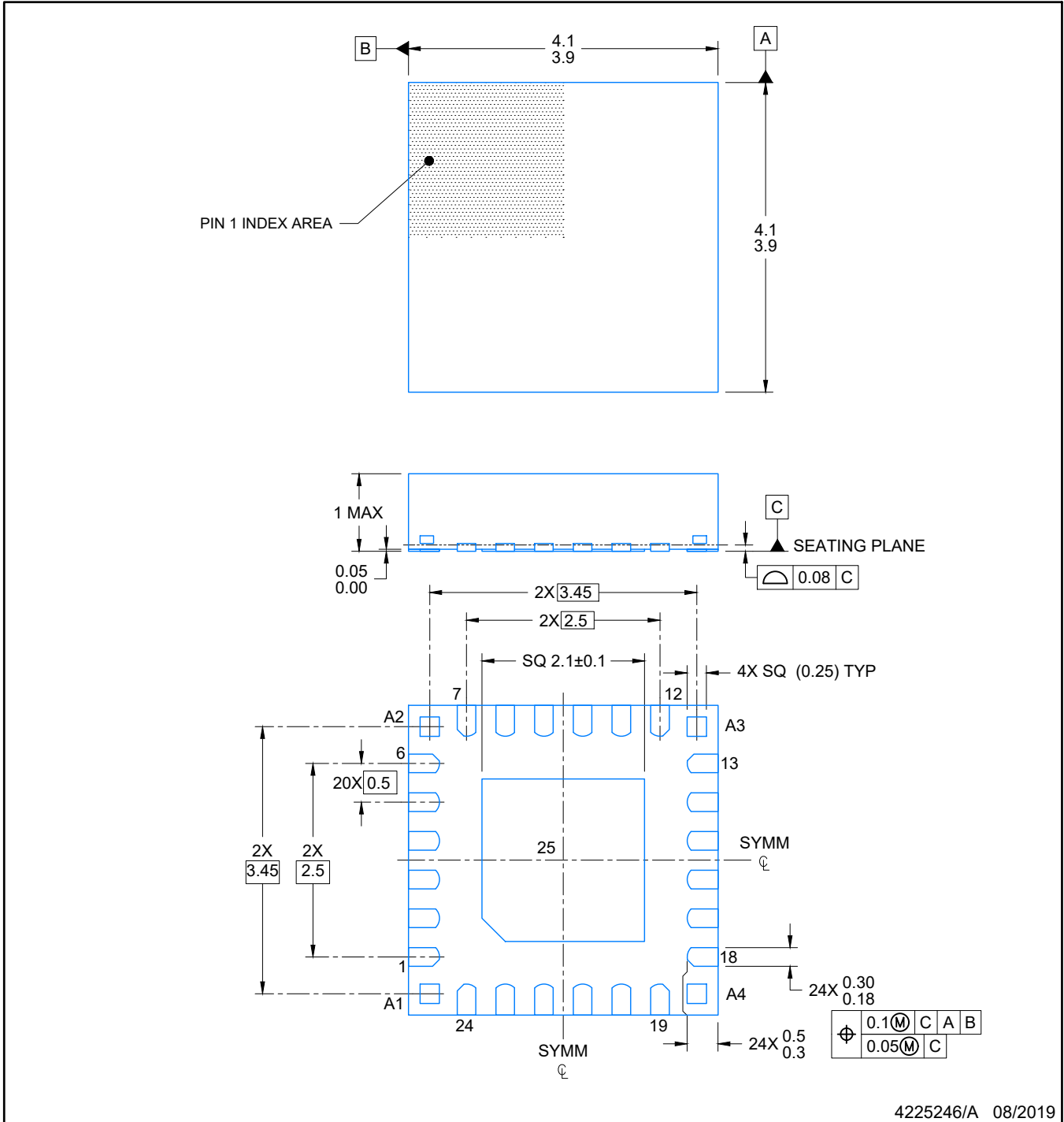

NOTES:

1. All linear dimensions are in millimeters. Any dimensions in parenthesis are for reference only. Dimensioning and tolerancing per ASME Y14.5M.
2. This drawing is subject to change without notice.
3. The package thermal pad must be soldered to the printed circuit board for optimal thermal and mechanical performance.

# EXAMPLE BOARD LAYOUT

RGE0024R

VQFN - 1 mm max height

PLASTIC QUAD FLATPACK-NO LEAD

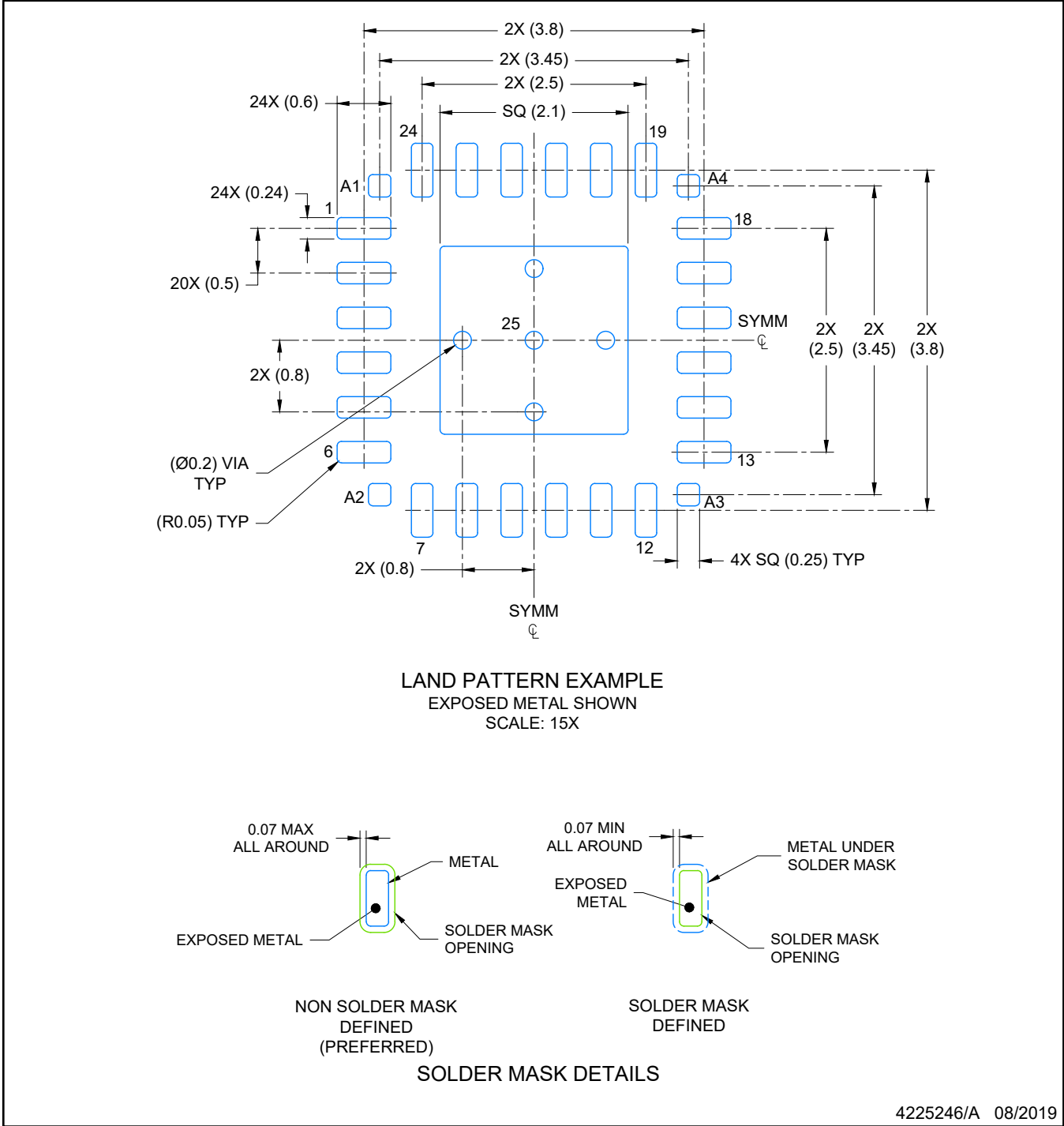

NOTES: (continued)

4. This package is designed to be soldered to a thermal pad on the board. For more information, see Texas Instruments literature number SLUA271 ([www.ti.com/lit/slua271](http://www.ti.com/lit/slua271)).
5. Vias are optional depending on application, refer to device data sheet. If any vias are implemented, refer to their locations shown on this view. It is recommended that vias under paste be filled, plugged or tented.



# EXAMPLE STENCIL DESIGN

RGE0024R

VQFN - 1 mm max height

PLASTIC QUAD FLATPACK-NO LEAD

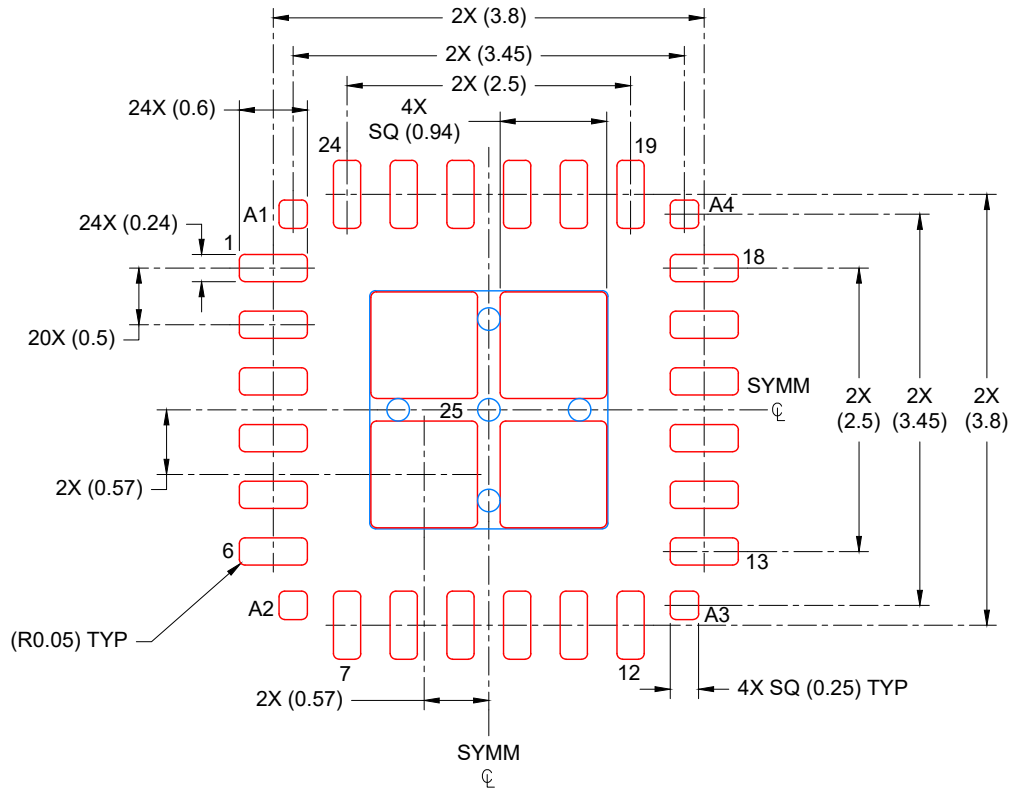

SOLDER PASTE EXAMPLE  
BASED ON 0.125 mm THICK STENCIL

EXPOSED PAD  
80% PRINTED COVERAGE BY AREA  
SCALE: 15X

4225246/A 08/2019

NOTES: (continued)

6. Laser cutting apertures with trapezoidal walls and rounded corners may offer better paste release. IPC-7525 may have alternate design recommendations.

## IMPORTANT NOTICE AND DISCLAIMER

TI PROVIDES TECHNICAL AND RELIABILITY DATA (INCLUDING DATA SHEETS), DESIGN RESOURCES (INCLUDING REFERENCE DESIGNS), APPLICATION OR OTHER DESIGN ADVICE, WEB TOOLS, SAFETY INFORMATION, AND OTHER RESOURCES "AS IS" AND WITH ALL FAULTS, AND DISCLAIMS ALL WARRANTIES, EXPRESS AND IMPLIED, INCLUDING WITHOUT LIMITATION ANY IMPLIED WARRANTIES OF MERCHANTABILITY, FITNESS FOR A PARTICULAR PURPOSE OR NON-INFRINGEMENT OF THIRD PARTY INTELLECTUAL PROPERTY RIGHTS.

These resources are intended for skilled developers designing with TI products. You are solely responsible for (1) selecting the appropriate TI products for your application, (2) designing, validating and testing your application, and (3) ensuring your application meets applicable standards, and any other safety, security, regulatory or other requirements.

These resources are subject to change without notice. TI grants you permission to use these resources only for development of an application that uses the TI products described in the resource. Other reproduction and display of these resources is prohibited. No license is granted to any other TI intellectual property right or to any third party intellectual property right. TI disclaims responsibility for, and you will fully indemnify TI and its representatives against, any claims, damages, costs, losses, and liabilities arising out of your use of these resources.

TI's products are provided subject to [TI's Terms of Sale](#) or other applicable terms available either on [ti.com](https://www.ti.com) or provided in conjunction with such TI products. TI's provision of these resources does not expand or otherwise alter TI's applicable warranties or warranty disclaimers for TI products.

TI objects to and rejects any additional or different terms you may have proposed.

Mailing Address: Texas Instruments, Post Office Box 655303, Dallas, Texas 75265  
Copyright © 2025, Texas Instruments Incorporated