

TLVx313-Q1 Low-Power, Rail-to-Rail In/Out, 750- μ V Typical Offset, 1-MHz Operational Amplifier for Cost-Sensitive Systems

1 Features

- Qualified for Automotive Applications
- AEC-Q100 Qualified With the Following Results
 - Device Temperature Grade 1: -40°C to $+125^{\circ}\text{C}$
 - Ambient Operating Temperature Range
 - Device HBM ESD Classification Level 3A
 - Device CDM ESD Classification Level C6
- Precision Amplifier for Cost-Sensitive Systems
- Low I_Q : 65 $\mu\text{A}/\text{ch}$
- Wide Supply Range: 1.8 V to 5.5 V
- Low Noise: 26 $\text{nV}/\sqrt{\text{Hz}}$ at 1 kHz
- Gain Bandwidth: 1 MHz
- Rail-to-Rail Input/Output
- Low Input Bias Current: 1 pA
- Low Offset Voltage: 0.75 mV
- Unity-Gain Stable
- Internal RFI/EMI Filter

2 Applications

- Infotainment
- Engine Control Unit
- Automotive Lighting
- Low-Side Sensing
- Battery Management Systems
- Passive Safety
- Capacitive Sensing
- Fuel Pumps

3 Description

The TLVx313-Q1 family of single- and dual-channel operational amplifiers combine low power consumption with good performance. This makes them designed for a wide range of applications, such as infotainment, engine control units, automotive lighting and more. The family features rail-to-rail input and output (RRIO) swings, low quiescent current (65 μA , typical), wide bandwidth (1 MHz) and very low noise (26 $\text{nV}/\sqrt{\text{Hz}}$ at 1 kHz), making them attractive for a variety of battery-powered applications that require a good balance between cost and performance. Further, low-input-bias current enables these devices to be used in applications with megaohm source impedances.

The robust design of the TLVx313-Q1 devices provides ease-of-use to the circuit designer: unity-gain stability with capacitive loads of up to 100 pF, integrated RFI/EMI rejection filter, no phase reversal in overdrive conditions, and high electrostatic discharge (ESD) protection (4-kV HBM).

The devices are optimized for operation at voltages as low as 1.8 V (± 0.9 V) and up to 5.5 V (± 2.75 V), and are specified over the extended temperature range of -40°C to $+125^{\circ}\text{C}$.

The single-channel TLV313-Q1 device is available in an SC70-5 package. The dual-channel TLV2313-Q1 device is offered in SOIC-8 (D) and VSSOP-8 (DGK) packages.

Device Information⁽¹⁾

| PART NUMBER | PACKAGE | BODY SIZE (NOM) |
|-------------|-----------|-------------------|
| TLV313-Q1 | SC70 (5) | 2.00 mm x 1.25 mm |
| TLV2313-Q1 | SOIC (8) | 4.90 mm x 3.91 mm |
| | VSSOP (8) | 3.00 mm x 3.00 mm |

(1) For all available packages, see the orderable addendum at the end of the data sheet.

EMIRR IN+ vs Frequency

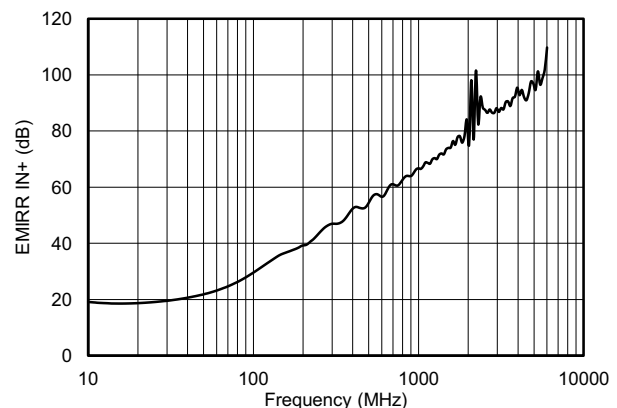

Table of Contents

| | | | |
|---|-----------|--|-----------|
| 1 Features | 1 | 8.4 Device Functional Modes..... | 15 |
| 2 Applications | 1 | 9 Application and Implementation | 16 |
| 3 Description | 1 | 9.1 Application Information..... | 16 |
| 4 Revision History | 2 | 9.2 Typical Application | 16 |
| 5 Device Comparison Table | 3 | 9.3 System Examples | 17 |
| 6 Pin Configuration and Functions | 3 | 10 Power Supply Recommendations | 18 |
| 7 Specifications | 5 | 11 Layout | 19 |
| 7.1 Absolute Maximum Ratings | 5 | 11.1 Layout Guidelines | 19 |
| 7.2 ESD Ratings..... | 5 | 11.2 Layout Example: Single Channel..... | 19 |
| 7.3 Recommended Operating Conditions..... | 5 | 11.3 Layout Example: Dual Channel | 20 |
| 7.4 Thermal Information: TLV313-Q1 | 6 | 12 Device and Documentation Support | 21 |
| 7.5 Thermal Information: TLV2313-Q1 | 6 | 12.1 Documentation Support | 21 |
| 7.6 Electrical Characteristics: 5.5 V | 7 | 12.2 Related Links | 21 |
| 7.7 Electrical Characteristics: 1.8 V | 8 | 12.3 Receiving Notification of Documentation Updates | 21 |
| 7.8 Typical Characteristics: Table of Graphs..... | 9 | 12.4 Community Resources..... | 21 |
| 7.9 Typical Characteristics..... | 10 | 12.5 Trademarks | 21 |
| 8 Detailed Description | 13 | 12.6 Electrostatic Discharge Caution..... | 21 |
| 8.1 Overview | 13 | 12.7 Glossary | 21 |
| 8.2 Functional Block Diagram | 13 | 13 Mechanical, Packaging, and Orderable | 21 |
| 8.3 Feature Description..... | 14 | Information | 21 |

4 Revision History

| Changes from Original (October 2017) to Revision A | Page |
|--|-------------|
| • Added TLV2313-Q1 device to data sheet | 1 |
| • Added dual channel information for TLV2313-Q1 device throughout data sheet | 1 |
| • Changed <i>Input and ESD Protection</i> section From <i>Power Supply</i> section : To <i>Feature Description</i> section | 15 |
| • Changed the formatting of the <i>Related Documentation</i> section | 21 |

5 Device Comparison Table

| DEVICE | NO. OF CHANNELS | PACKAGE LEADS | | |
|------------|-----------------|---------------|----------|-------------|
| | | SC70 (DCK) | SOIC (D) | VSSOP (DGK) |
| TLV313-Q1 | 1 | 5 | — | — |
| TLV2313-Q1 | 2 | — | 8 | 8 |

6 Pin Configuration and Functions

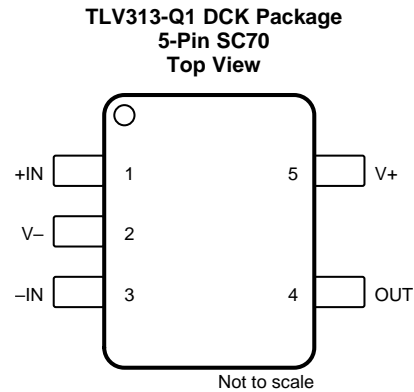

Pin Functions: TLV313-Q1

| PIN | | I/O | DESCRIPTION |
|------|-----|-----|---------------------------------|
| NAME | NO. | | |
| +IN | 1 | I | Noninverting input |
| -IN | 3 | I | Inverting input |
| OUT | 4 | O | Output |
| V- | 2 | — | Negative (lowest) power supply |
| V+ | 5 | — | Positive (highest) power supply |

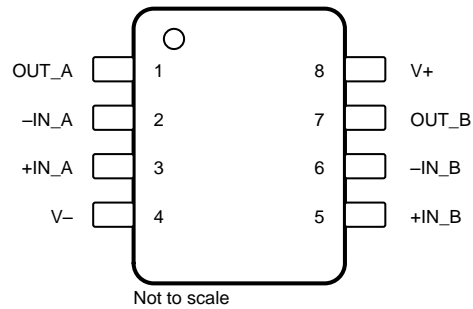
**TLV2313-Q1 D, DGK Packages
8-Pin SOIC, 8-Pin VSSOP
Top View**

Pin Functions: TLV2313-Q1

| NAME | PIN | | I/O | DESCRIPTION |
|-------|----------|-------------|-----|---------------------------------|
| | D (SOIC) | DGK (VSSOP) | | |
| V- | 4 | 4 | — | Negative (lowest) power supply |
| V+ | 8 | 8 | — | Positive (highest) power supply |
| OUT A | 1 | 1 | O | Output, channel A |
| OUT B | 7 | 7 | O | Output, channel B |
| -IN A | 2 | 2 | I | Inverting input, channel A |
| +IN A | 3 | 3 | I | Noninverting input, channel A |
| -IN B | 6 | 6 | I | Inverting input, channel B |
| +IN B | 5 | 5 | I | Noninverting input, channel B |

7 Specifications

7.1 Absolute Maximum Ratings

over operating free-air temperature range (unless otherwise noted)⁽¹⁾

| | | MIN | MAX | UNIT |
|-------------|---------------------------------------|--------------|------------|------|
| Voltage | Supply voltage (V+) – (V–) | 0 | 7 | V |
| | Signal input terminals ⁽²⁾ | (V–) – (0.5) | (V+) + 0.5 | |
| Current | Signal input terminals ⁽²⁾ | –10 | 10 | mA |
| | Output short circuit ⁽³⁾ | Continuous | | |
| Temperature | Operating, T _A | –40 | 150 | °C |
| | Junction, T _J | | 150 | |
| | Storage, T _{stg} | –65 | 150 | |

- (1) Stresses beyond those listed under *Absolute Maximum Ratings* may cause permanent damage to the device. These are stress ratings only, which do not imply functional operation of the device at these or any other conditions beyond those indicated under *Recommended Operating Conditions*. Exposure to absolute-maximum-rated conditions for extended periods may affect device reliability.
- (2) Input pins are diode-clamped to the power-supply rails. Input signals that may swing more than 0.5 V beyond the supply rails must be current limited to 10 mA or less.
- (3) Short-circuit to ground, one amplifier per package.

7.2 ESD Ratings

| | | VALUE | UNIT |
|--|--|-------|------|
| V _(ESD) Electrostatic discharge | Human-body model (HBM), per ANSI/ESDA/JEDEC JS-001 ⁽¹⁾ | ±4000 | V |
| | Charged-device model (CDM), per JEDEC specification JESD22-C101 ⁽²⁾ | ±1000 | |

- (1) JEDEC document JEP155 states that 500-V HBM allows safe manufacturing with a standard ESD control process.
- (2) JEDEC document JEP157 states that 250-V CDM allows safe manufacturing with a standard ESD control process.

7.3 Recommended Operating Conditions

over operating free-air temperature range (unless otherwise noted)

| | | MIN | MAX | UNIT |
|----------------|-----------------------|-----|-----|------|
| V _S | Supply voltage | 1.8 | 5.5 | V |
| T _A | Specified temperature | –40 | 125 | °C |

7.4 Thermal Information: TLV313-Q1

| THERMAL METRIC ⁽¹⁾ | | TLV313-Q1 | |
|-------------------------------|--|------------|------|
| | | DCK (SC70) | |
| | | 5 PINS | |
| | | | UNIT |
| $R_{\theta JA}$ | Junction-to-ambient thermal resistance | 281.4 | °C/W |
| $R_{\theta JC(top)}$ | Junction-to-case (top) thermal resistance | 91.6 | °C/W |
| $R_{\theta JB}$ | Junction-to-board thermal resistance | 59.6 | °C/W |
| Ψ_{JT} | Junction-to-top characterization parameter | 1.5 | °C/W |
| Ψ_{JB} | Junction-to-board characterization parameter | 58.8 | °C/W |

(1) For more information about traditional and new thermal metrics, see the [Semiconductor and IC Package Thermal Metrics](#) application report.

7.5 Thermal Information: TLV2313-Q1

| THERMAL METRIC | | TLV2313-Q1 | | UNIT |
|----------------------|--|------------|-------------|------|
| | | D (SOIC) | DGK (VSSOP) | |
| | | 8 PINS | 8 PINS | |
| $R_{\theta JA}$ | Junction-to-ambient thermal resistance | 131.6 | 186.0 | °C/W |
| $R_{\theta JC(top)}$ | Junction-to-case (top) thermal resistance | 71.4 | 73.2 | °C/W |
| $R_{\theta JB}$ | Junction-to-board thermal resistance | 75.4 | 107.3 | °C/W |
| Ψ_{JT} | Junction-to-top characterization parameter | 22.7 | 14.4 | °C/W |
| Ψ_{JB} | Junction-to-board characterization parameter | 74.6 | 105.6 | °C/W |

7.6 Electrical Characteristics: 5.5 V

at $T_A = 25^\circ\text{C}$, $R_L = 10\text{ k}\Omega$ connected to $V_S / 2$, and $V_{CM} = V_{OUT} = V_S / 2$, (unless otherwise noted)⁽¹⁾

| PARAMETER | | TEST CONDITIONS | MIN | TYP | MAX | UNIT |
|----------------------------|--|---|-------------------|--------------------|--------------|------------------------------|
| OFFSET VOLTAGE | | | | | | |
| V_{OS} | Input offset voltage | | | 0.75 | 3 | mV |
| dV_{OS}/dT | Input offset voltage vs temperature | $T_A = -40^\circ\text{C}$ to 125°C | | 2 | | $\mu\text{V}/^\circ\text{C}$ |
| PSRR | Power-supply rejection ratio | | 74 | 90 | | dB |
| INPUT VOLTAGE RANGE | | | | | | |
| V_{CM} | Common-mode voltage range | No phase reversal, rail-to-rail input | $(V-) - 0.2$ | | $(V+) + 0.2$ | V |
| CMRR | Common-mode rejection ratio | $(V-) - 0.2\text{ V} < V_{CM} < (V+) - 1.3\text{ V}$ | | 85 | | dB |
| | | $V_{CM} = -0.2\text{ V}$ to 5.7 V | 64 | 80 | | |
| INPUT BIAS CURRENT | | | | | | |
| I_B | Input bias current | | | ± 1 | | pA |
| I_{OS} | Input offset current | | | ± 1 | | pA |
| NOISE | | | | | | |
| | Input voltage noise (peak-to-peak) | $f = 0.1\text{ Hz}$ to 10 Hz | | 6 | | μV_{PP} |
| e_n | Input voltage noise density | $f = 10\text{ kHz}$ | | 22 | | $\text{nV}/\sqrt{\text{Hz}}$ |
| | | $f = 1\text{ kHz}$ | | 26 | | |
| i_n | Input current noise density | $f = 1\text{ kHz}$ | | 5 | | $\text{fA}/\sqrt{\text{Hz}}$ |
| INPUT CAPACITANCE | | | | | | |
| C_{IN} | Differential | | | 1 | | pF |
| | Common-mode | | | 5 | | |
| OPEN-LOOP GAIN | | | | | | |
| A_{OL} | Open-loop voltage gain | $0.05\text{ V} < V_O < (V+) - 0.05\text{ V}$ $R_L = 100\text{ k}\Omega$ | | 104 | | dB |
| | | $0.3\text{ V} < V_O < (V+) - 0.3\text{ V}$ $R_L = 2\text{ k}\Omega$ | 100 | 110 | | |
| | Phase margin | $V_S = 5\text{ V}$, $G = +1$ | | 65 | | $^\circ$ |
| FREQUENCY RESPONSE | | | | | | |
| GBW | Gain-bandwidth product | $V_S = 5\text{ V}$, $C_L = 10\text{ pF}$ | | 1 | | MHz |
| SR | Slew rate | $V_S = 5\text{ V}$, $G = +1$ | | 0.5 | | V/ μs |
| t_S | Settling time | To 0.01%, $V_S = 5\text{ V}$, 2-V step, $G = +1$ | | 6 | | μs |
| | Overload recovery time | $V_S = 5\text{ V}$, $V_{IN} \times \text{Gain} > V_S$ | | 3 | | μs |
| OUTPUT | | | | | | |
| V_O | Voltage output swing from supply rails | $R_L = 100\text{ k}\Omega$ ⁽²⁾ | | 5 | 20 | mV |
| | | $R_L = 2\text{ k}\Omega$ ⁽²⁾ | | 75 | 100 | |
| I_{SC} | Short-circuit current | | | ± 15 | | mA |
| R_O | Open-loop output impedance | | | 2300 | | Ω |
| POWER SUPPLY | | | | | | |
| V_S | Specified voltage range | | 1.8 (± 0.9) | 5.5 (± 2.75) | | V |
| I_Q | Quiescent current per amplifier | $T_A = -40^\circ\text{C}$ to 125°C , $V_S = 5\text{ V}$, $I_O = 0\text{ mA}$ | | 65 | 90 | μA |
| | Power-on time | $V_S = 0\text{ V}$ to 5 V , to 90% I_Q level | | 10 | | |

- (1) Parameters with minimum or maximum specification limits are 100% production tested at 25°C , unless otherwise noted. Over-temperature limits are based on characterization and statistical analysis.
- (2) Specified by design and characterization; not production tested.

7.7 Electrical Characteristics: 1.8 V

at $T_A = 25^\circ\text{C}$, $R_L = 10\text{ k}\Omega$ connected to $V_S / 2$, $V_{CM} = V_{S+} - 1.3\text{ V}$, and $V_{OUT} = V_S / 2$, (unless otherwise noted)⁽¹⁾

| PARAMETER | | TEST CONDITIONS | MIN | TYP | MAX | UNIT |
|----------------------------|--|--|---------------|---------|---------------|------------------------------|
| OFFSET VOLTAGE | | | | | | |
| V_{OS} | Input offset voltage | | | 0.75 | 3 | mV |
| dV_{OS}/dT | Input offset voltage vs temperature | $T_A = -40^\circ\text{C}$ to 125°C | | 2 | | $\mu\text{V}/^\circ\text{C}$ |
| PSRR | Power-supply rejection ratio | | 74 | 90 | | dB |
| INPUT VOLTAGE RANGE | | | | | | |
| V_{CM} | Common-mode voltage range | No phase reversal, rail-to-rail input | $(V_-) - 0.2$ | | $(V_+) + 0.2$ | V |
| CMRR | Common-mode rejection ratio | $(V_{S-}) - 0.2\text{ V} < V_{CM} < (V_{S+}) - 1.3\text{ V}$ | | 85 | | dB |
| | | $V_{CM} = -0.2\text{ V}$ to 1.8 V | | 73 | | |
| INPUT BIAS CURRENT | | | | | | |
| I_B | Input bias current | | | ± 1 | | pA |
| I_{OS} | Input offset current | | | ± 1 | | pA |
| NOISE | | | | | | |
| | Input voltage noise (peak-to-peak) | $f = 0.1\text{ Hz}$ to 10 Hz | | 6 | | μV_{PP} |
| e_n | Input voltage noise density | $f = 10\text{ kHz}$ | | 22 | | $\text{nV}/\sqrt{\text{Hz}}$ |
| | | $f = 1\text{ kHz}$ | | 26 | | |
| i_n | Input current noise density | $f = 1\text{ kHz}$ | | 5 | | $\text{fA}/\sqrt{\text{Hz}}$ |
| INPUT CAPACITANCE | | | | | | |
| C_{IN} | Differential | | | 1 | | pF |
| | Common-mode | | | 5 | | |
| OPEN-LOOP GAIN | | | | | | |
| A_{OL} | Open-loop voltage gain | $0.1\text{ V} < V_O < (V_+) - 0.1\text{ V}$, $R_L = 10\text{ k}\Omega$ | | 110 | | dB |
| | | $0.05\text{ V} < V_O < (V_+) - 0.05\text{ V}$, $R_L = 100\text{ k}\Omega$ | | 110 | | |
| FREQUENCY RESPONSE | | | | | | |
| GBW | Gain-bandwidth product | $C_L = 10\text{ pF}$ | | 0.9 | | MHz |
| SR | Slew rate | $G = 1$ | | 0.45 | | V/ μs |
| OUTPUT | | | | | | |
| V_O | Voltage output swing from supply rails | $R_L = 100\text{ k}\Omega^{(2)}$ | | 5 | | mV |
| | | $R_L = 2\text{ k}\Omega^{(2)}$ | | 25 | | |
| I_{SC} | Short-circuit current | | | ± 6 | | mA |
| R_O | Open-loop output impedance | | | 2300 | | Ω |

- (1) Parameters with minimum or maximum specification limits are 100% production tested at 25°C , unless otherwise noted. Over-temperature limits are based on characterization and statistical analysis.
 (2) Specified by design and characterization; not production tested.

7.8 Typical Characteristics: Table of Graphs

Table 1. Table of Graphs

| TITLE | FIGURE |
|--|---------------------------|
| Open-Loop Gain and Phase vs Frequency | Figure 1 |
| Quiescent Current vs Supply Voltage | Figure 2 |
| Offset Voltage Production Distribution | Figure 3 |
| Offset Voltage vs Common-Mode Voltage (Maximum Supply) | Figure 4 |
| CMRR and PSRR vs Frequency (RTI) | Figure 5 |
| 0.1-Hz to 10-Hz Input Voltage Noise (5.5 V) | Figure 6 |
| Input Voltage Noise Spectral Density vs Frequency (1.8 V, 5.5 V) | Figure 7 |
| Input Bias and Offset Current vs Temperature | Figure 8 |
| Open-Loop Output Impedance vs Frequency | Figure 9 |
| Maximum Output Voltage vs Frequency and Supply Voltage | Figure 10 |
| Output Voltage Swing vs Output Current (Over Temperature) | Figure 11 |
| Closed-Loop Gain vs Frequency, $G = 1, -1, 10$ (1.8 V) | Figure 12 |
| Small-Signal Step Response, Noninverting (1.8 V) | Figure 13 |
| Small-Signal Step Response, Noninverting (5.5 V) | Figure 14 |
| Large-Signal Step Response, Noninverting (1.8 V) | Figure 15 |
| Large-Signal Step Response, Noninverting (5.5 V) | Figure 16 |
| No Phase Reversal | Figure 17 |
| EMIRR IN+ vs Frequency | Figure 18 |

7.9 Typical Characteristics

at $T_A = 25^\circ\text{C}$, $V_S = 5\text{ V}$, $R_L = 10\text{ k}\Omega$ connected to $V_S / 2$, and $V_{CM} = V_{OUT} = V_S / 2$, (unless otherwise noted)

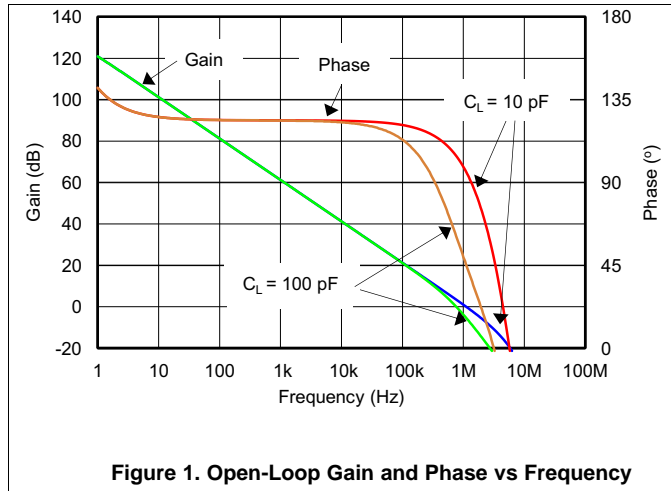

Figure 1. Open-Loop Gain and Phase vs Frequency

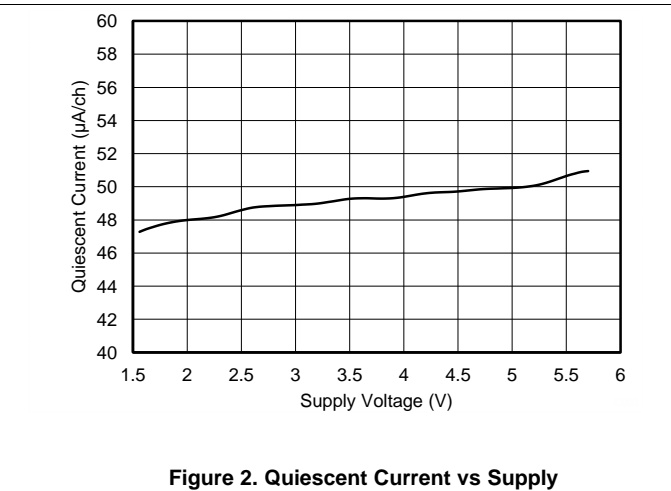

Figure 2. Quiescent Current vs Supply

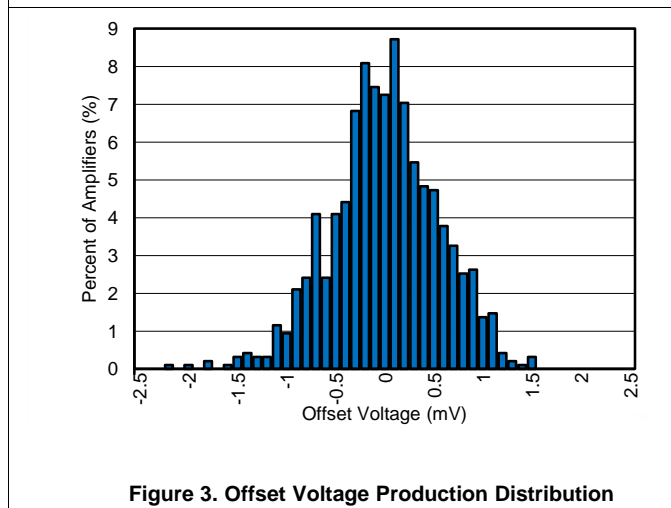

Figure 3. Offset Voltage Production Distribution

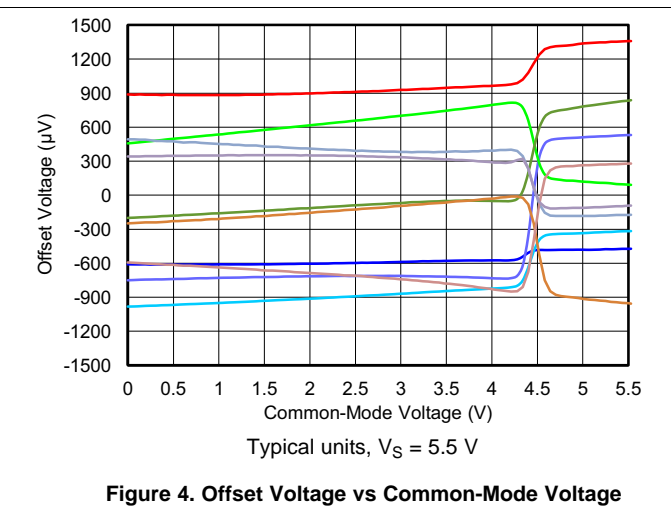

Figure 4. Offset Voltage vs Common-Mode Voltage

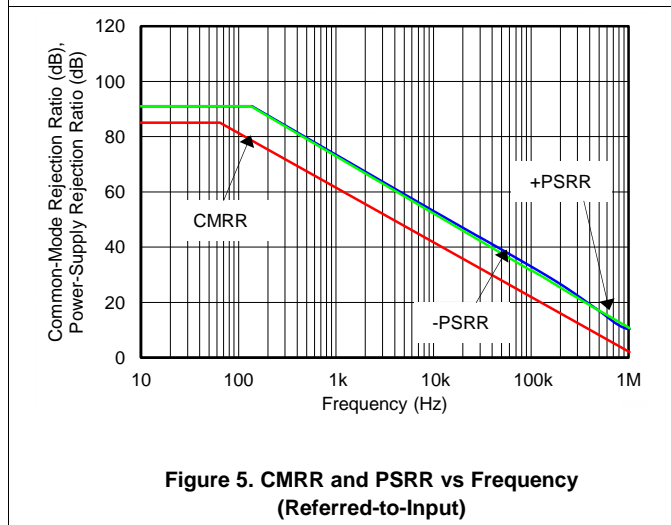

Figure 5. CMRR and PSRR vs Frequency (Referred-to-Input)

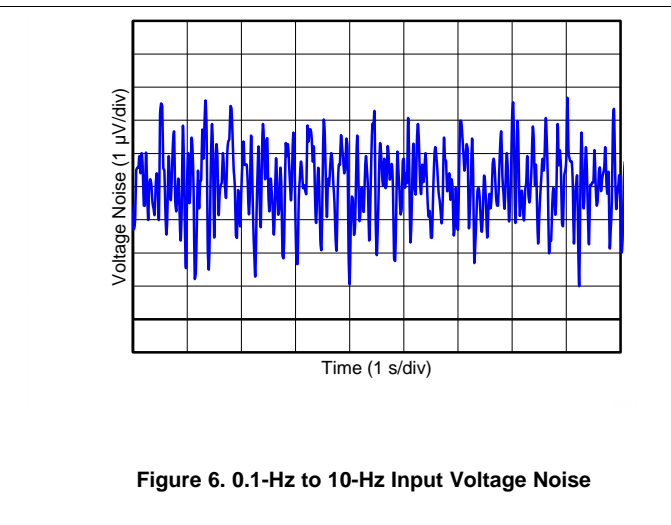

Figure 6. 0.1-Hz to 10-Hz Input Voltage Noise

Typical Characteristics (continued)

at $T_A = 25^\circ\text{C}$, $V_S = 5\text{ V}$, $R_L = 10\text{ k}\Omega$ connected to $V_S / 2$, and $V_{CM} = V_{OUT} = V_S / 2$, (unless otherwise noted)

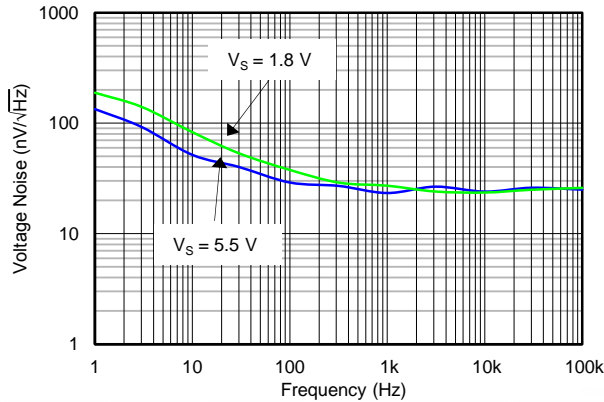

Figure 7. Input Voltage Noise Spectral Density vs Frequency

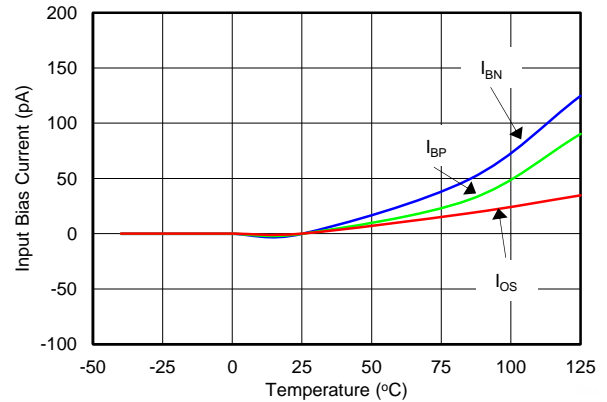

Figure 8. Input Bias and Offset Current vs Temperature

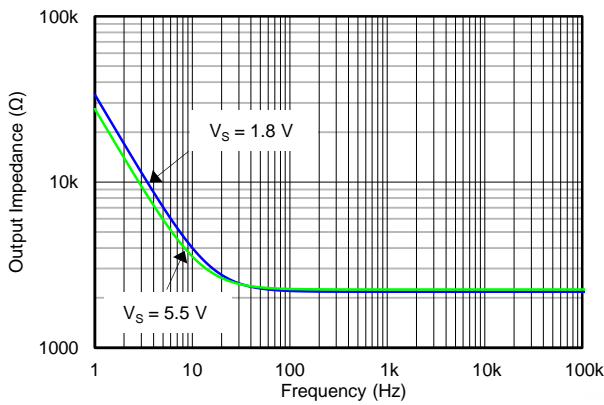
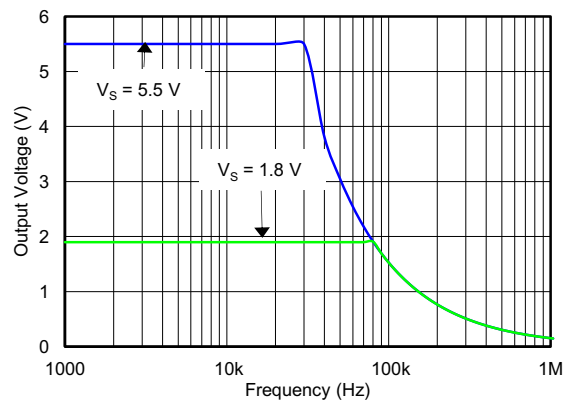

Figure 9. Open-Loop Output Impedance vs Frequency



$R_L = 10\text{ k}\Omega$ $C_L = 10\text{ pF}$

Figure 10. Maximum Output Voltage vs Frequency and Supply Voltage

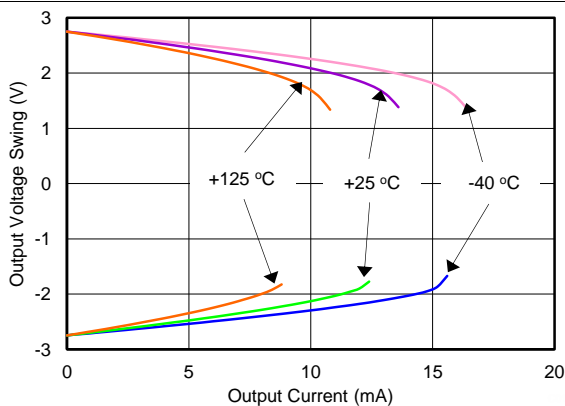
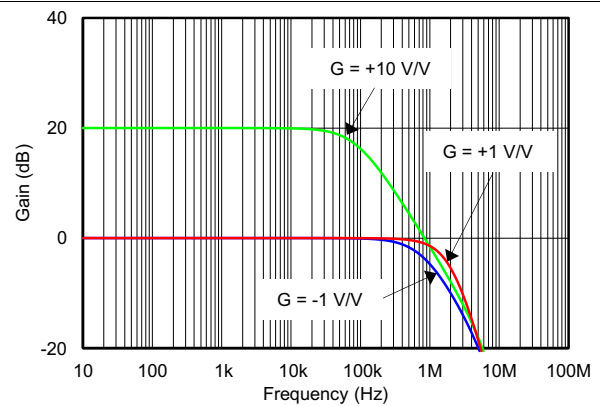

Figure 11. Output Voltage Swing vs Output Current (Over Temperature)



$V_S = 1.8\text{ V}$

Figure 12. Closed-Loop Gain vs Frequency (Minimum Supply)

Typical Characteristics (continued)

at $T_A = 25^\circ\text{C}$, $V_S = 5\text{ V}$, $R_L = 10\text{ k}\Omega$ connected to $V_S / 2$, and $V_{CM} = V_{OUT} = V_S / 2$, (unless otherwise noted)

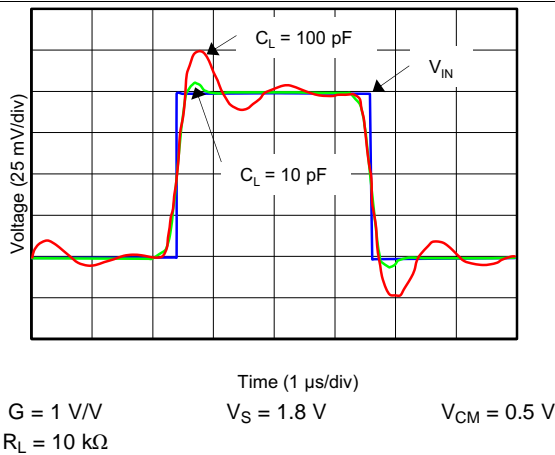

Figure 13. Small-Signal Pulse Response (Minimum Supply)

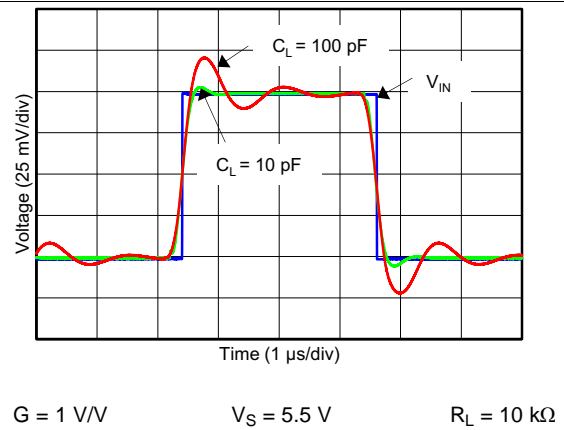

Figure 14. Small-Signal Pulse Response (Maximum Supply)

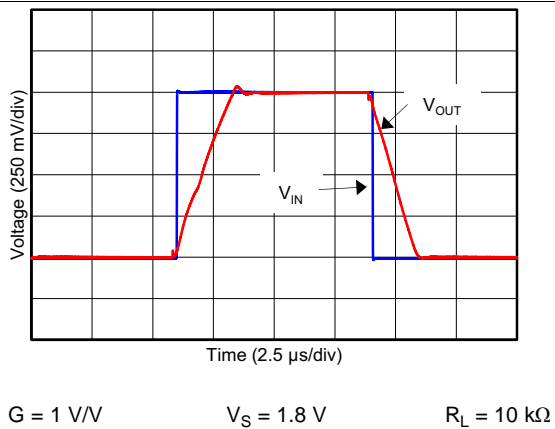

Figure 15. Large-Signal Pulse Response (Minimum Supply)

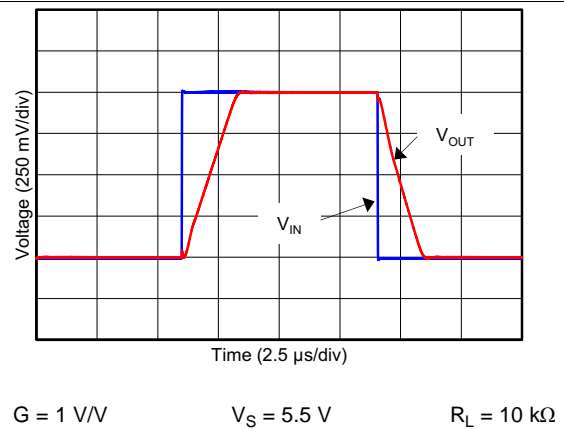

Figure 16. Large-Signal Pulse Response (Maximum Supply)

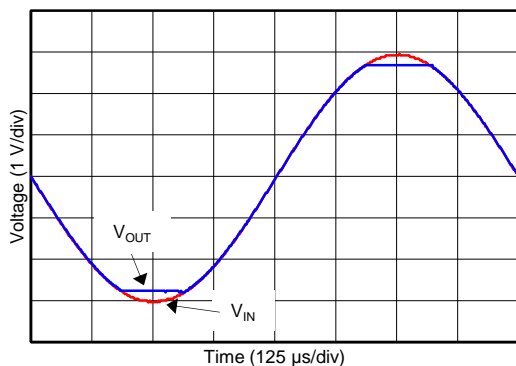

Figure 17. No Phase Reversal

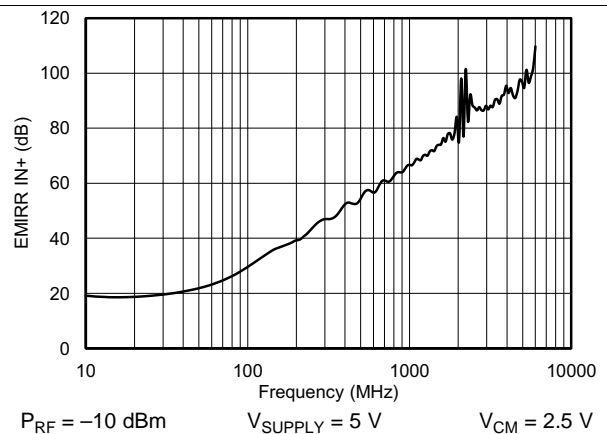

Figure 18. EMIRR IN+ vs Frequency

8 Detailed Description

8.1 Overview

The TLVx313-Q1 family of operational amplifiers are general-purpose devices that are designed for a wide range of portable, low-cost applications. Rail-to-rail input and output swings, low quiescent current, and wide dynamic range make the op amps designed for driving sampling analog-to-digital converters (ADCs) and other single-supply applications.

8.2 Functional Block Diagram

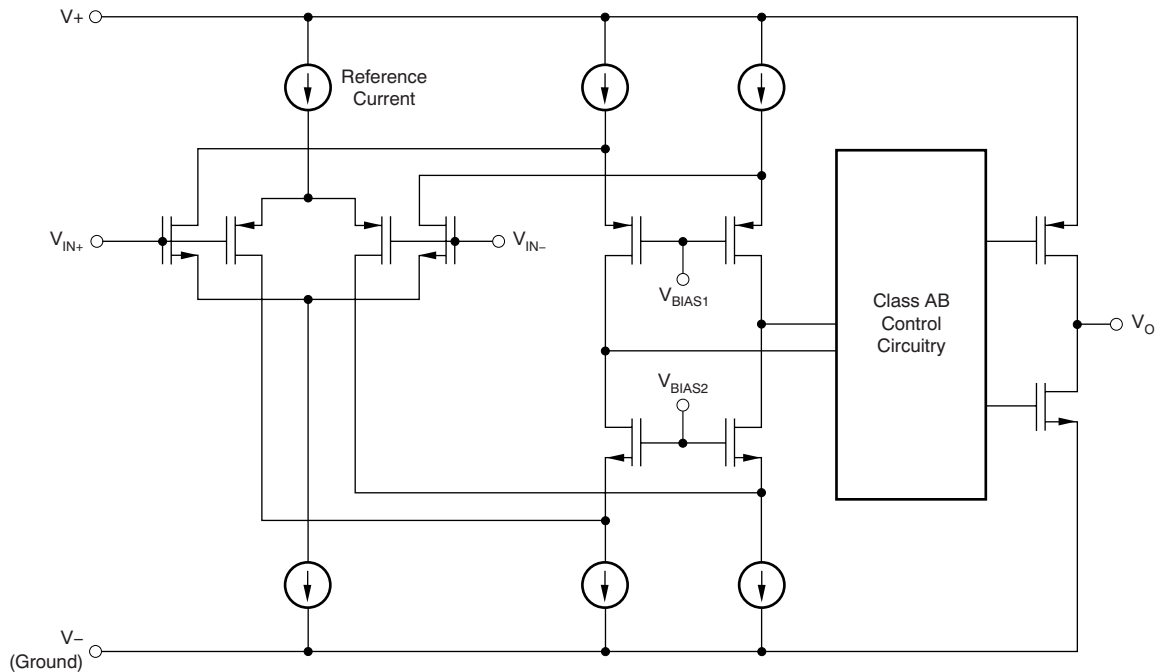

8.3 Feature Description

8.3.1 Operating Voltage

The TLVx313-Q1 family is fully specified and tested from 1.8 V to 5.5 V (± 0.9 V to ± 2.75 V). Parameters that vary with supply voltage are illustrated in the [Typical Characteristics](#) section.

8.3.2 Rail-to-Rail Input

The input common-mode voltage range of the TLVx313-Q1 family extends 200 mV beyond the supply rails. This performance is achieved with a complementary input stage: an N-channel input differential pair in parallel with a P-channel differential pair, as shown in the [Functional Block Diagram](#) section. The N-channel pair is active for input voltages close to the positive rail, typically $(V+) - 1.3$ V to 200 mV above the positive supply, while the P-channel pair is on for inputs from 200 mV below the negative supply to approximately $(V+) - 1.3$ V. There is a small transition region, typically $(V+) - 1.4$ V to $(V+) - 1.2$ V, in which both pairs are on. This 200-mV transition region may vary up to 300 mV with process variation. Thus, the transition region (both stages on) may range from $(V+) - 1.7$ V to $(V+) - 1.5$ V on the low end, up to $(V+) - 1.1$ V to $(V+) - 0.9$ V on the high end. Within this transition region, PSRR, CMRR, offset voltage, offset drift, and THD may be degraded compared to device operation outside this region.

8.3.3 Rail-to-Rail Output

Designed as a micro-power, low-noise operational amplifier, the TLVx313-Q1 family delivers a robust output drive capability. A class AB output stage with common-source transistors is used to achieve full rail-to-rail output swing capability. For resistive loads up to 100 k Ω , the output swings typically to within 5 mV of either supply rail regardless of the power-supply voltage applied. Different load conditions change the ability of the amplifier to swing close to the rails, as shown in [Figure 11](#).

8.3.4 Common-Mode Rejection Ratio (CMRR)

CMRR for the TLVx313-Q1 family is specified in several ways so the best match for a given application may be used; see the [Electrical Characteristics](#). First, the CMRR of the device in the common-mode range below the transition region ($V_{CM} < (V+) - 1.3$ V) is given. This specification is the best indicator of the capability of the device when the application requires use of one of the differential input pairs. Second, the CMRR over the entire common-mode range is specified at ($V_{CM} = -0.2$ V to 5.7 V). This last value includes the variations seen through the transition region, as shown in [Figure 4](#).

8.3.5 Capacitive Load and Stability

The TLVx313-Q1 family is designed to be used in applications where driving a capacitive load is required. As with all op amps, there may be specific instances where the TLVx313-Q1 device may become unstable. The particular op amp circuit configuration, layout, gain, and output loading are some of the factors to consider when establishing whether or not an amplifier is stable in operation. An op amp in the unity-gain ($+1-V/V$) buffer configuration that drives a capacitive load exhibits a greater tendency to be unstable than an amplifier operated at a higher noise gain. The capacitive load, in conjunction with the op amp output resistance, creates a pole within the feedback loop that degrades the phase margin. The degradation of the phase margin increases as the capacitive loading increases. When operating in the unity-gain configuration, the TLVx313-Q1 device remains stable with a pure capacitive load up to approximately 1 nF. The equivalent series resistance (ESR) of some capacitors (C_L greater than 1 μ F) is sufficient to alter the phase characteristics in the feedback loop such that the amplifier remains stable. Increasing the amplifier closed-loop gain allows the amplifier to drive increasingly larger capacitance. This increased capability is evident when observing the overshoot response of the amplifier at higher voltage gains.

Feature Description (continued)

One technique for increasing the capacitive load drive capability of the amplifier when it operates in a unity-gain configuration is to insert a small resistor, typically $10\ \Omega$ to $20\ \Omega$, in series with the output, as shown in Figure 19. This resistor significantly reduces the overshoot and ringing associated with large capacitive loads. One possible problem with this technique is that a voltage divider is created with the added series resistor and any resistor connected in parallel with the capacitive load. The voltage divider introduces a gain error at the output that reduces the output swing.

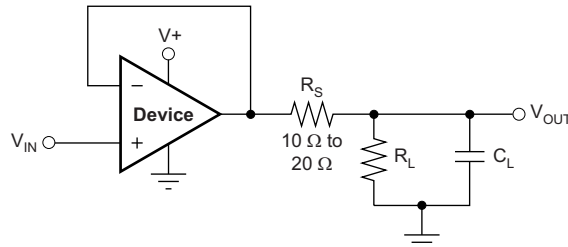

Figure 19. Improving Capacitive Load Drive

8.3.6 EMI Susceptibility and Input Filtering

Operational amplifiers vary with regard to the susceptibility of the device to electromagnetic interference (EMI). If conducted EMI enters the op amp, the DC offset observed at the amplifier output may shift from the nominal value while EMI is present. This shift is a result of signal rectification associated with the internal semiconductor junctions. While all op amp pin functions may be affected by EMI, the signal input pins are likely to be the most susceptible. The TLVx313-Q1 family incorporates an internal input low-pass filter that reduces the amplifiers response to EMI. Both common-mode and differential mode filtering are provided by this filter. The filter is designed for a common-mode cutoff frequency of approximately 35 MHz ($-3\ \text{dB}$), with a rolloff of 20 dB per decade.

Texas Instruments has developed the ability to accurately measure and quantify the immunity of an operational amplifier over a broad frequency spectrum extending from 10 MHz to 6 GHz. The EMI rejection ratio (EMIRR) metric allows op amps to be directly compared by the EMI immunity. Figure 18 illustrates the results of this testing on the TLV313-Q1 family. Detailed information may be found in *EMI Rejection Ratio of Operational Amplifiers*, available for download from www.ti.com.

8.3.7 Input and ESD Protection

The TLVx313-Q1 family incorporates internal electrostatic discharge (ESD) protection circuits on all pins. In the case of input and output pins, this protection primarily consists of current-steering diodes connected between the input and power-supply pins. The ESD protection diodes also provide in-circuit, input overdrive protection, as long as the current is limited to 10 mA as stated in the *Absolute Maximum Ratings*. Figure 20 shows how a series input resistor may be added to the driven input to limit the input current. The added resistor contributes thermal noise at the amplifier input and the value must be kept to a minimum in noise-sensitive applications.

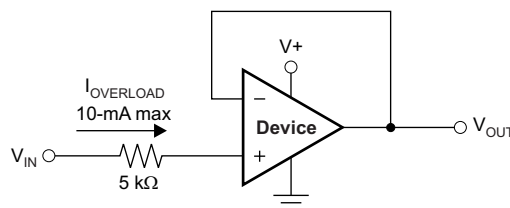

Figure 20. Input Current Protection

8.4 Device Functional Modes

The TLV313-Q1 devices have a single functional mode. The devices are powered on as long as the power-supply voltage is between 1.8 V ($\pm 0.9\ \text{V}$) and 5.5 V ($\pm 2.75\ \text{V}$).

9 Application and Implementation

NOTE

Information in the following applications sections is not part of the TI component specification, and TI does not warrant its accuracy or completeness. TI's customers are responsible for determining suitability of components for their purposes. Customers should validate and test their design implementation to confirm system functionality.

9.1 Application Information

The TLVx313-Q1 devices are a family of low-power, rail-to-rail input and output operational amplifiers specifically designed for portable applications. The devices operate from 1.8 V to 5.5 V, are unity-gain stable, and are designed for a wide range of general-purpose applications. The class AB output stage is capable of driving loads greater than 10 kΩ connected to any point between V+ and ground. The input common-mode voltage range includes both rails, and allows the TLVx313-Q1 family to be used in virtually any single-supply application.

9.2 Typical Application

A typical application for an operational amplifier is an inverting amplifier, as shown in [Figure 21](#). An inverting amplifier takes a positive voltage on the input and outputs a signal inverted to the input, making a negative voltage of the same magnitude. In the same manner, the amplifier also makes negative input voltages positive on the output. In addition, amplification may be added by selecting the input resistor (R_I) and the feedback resistor (R_F).

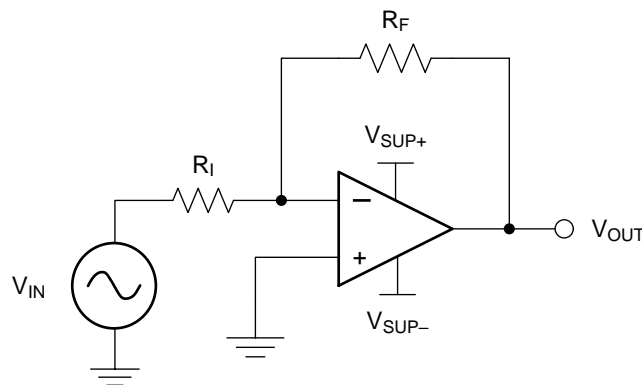

Figure 21. Application Schematic

9.2.1 Design Requirements

The supply voltage must be chosen to be larger than the input voltage range and the desired output range. The limits of the input common-mode range (V_{CM}) and the output voltage swing to the rails (V_O) must also be considered. For instance, this application scales a signal of ± 0.5 V (1 V) to ± 1.8 V (3.6 V). Setting the supply at ± 2.5 V is sufficient to accommodate this application.

9.2.2 Detailed Design Procedure

Determine the gain required by the inverting amplifier using [Equation 1](#) and [Equation 2](#):

$$A_V = \frac{V_{OUT}}{V_{IN}} \quad (1)$$

$$A_V = \frac{1.8}{-0.5} = -3.6 \quad (2)$$

Typical Application (continued)

When the desired gain is determined, choose a value for R_1 or R_F . Choosing a value in the kilohm range is desirable for general-purpose applications because the amplifier circuit uses currents in the milliamp range. This milliamp current range ensures the device does not draw too much current. The trade-off is that very large resistors (100s of kilohms) draw the smallest current but generate the highest noise. Small resistors (100s of ohms) generate low noise but draw high current. This example uses 10 k Ω for R_1 , meaning 36 k Ω is used for R_F . The values are determined by Equation 3:

$$A_V = -\frac{R_F}{R_1} \tag{3}$$

9.2.3 Application Curve

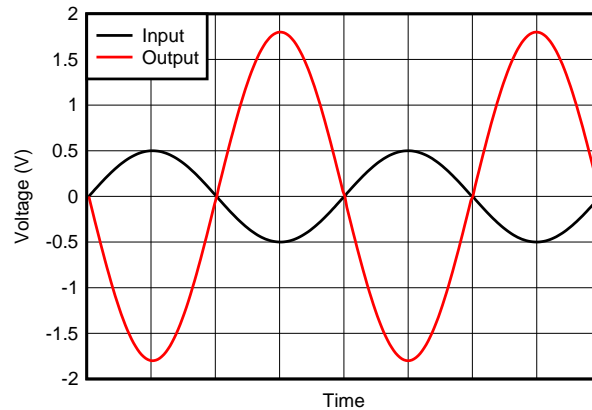
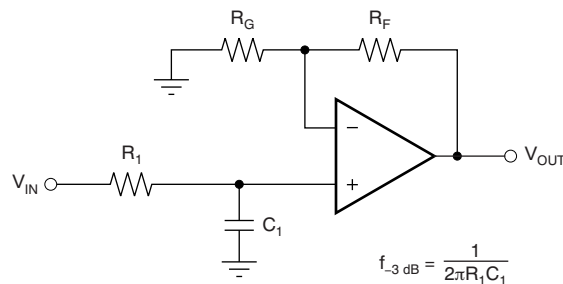

Figure 22. Inverting Amplifier Input and Output

9.3 System Examples

When receiving low-level signals, limiting the bandwidth of the incoming signals into the system is often required. The simplest way to establish this limited bandwidth is to place an RC filter at the noninverting terminal of the amplifier, as shown in Figure 23.



$$\frac{V_{OUT}}{V_{IN}} = \left(1 + \frac{R_F}{R_G}\right) \left(\frac{1}{1 + sR_1C_1}\right)$$

Figure 23. Single-Pole Low-Pass Filter

System Examples (continued)

If even more attenuation is needed, a multiple pole filter is required. The Sallen-Key filter may be used for this task, as shown in [Figure 24](#). For best results, the amplifier must have a bandwidth that is eight to 10 times the filter frequency bandwidth. Failure to follow this guideline may result in phase shift of the amplifier.

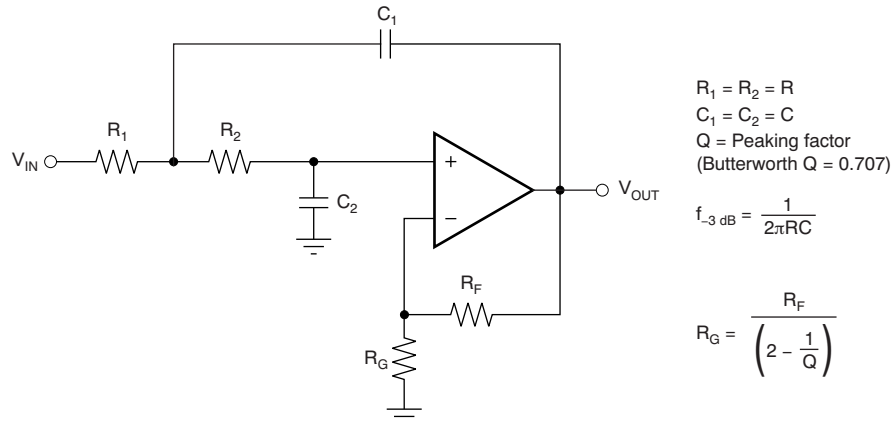

Figure 24. Two-Pole, Low-Pass, Sallen-Key Filter

10 Power Supply Recommendations

The TLVx313-Q1 family is specified for operation from 1.8 V to 5.5 V (± 0.9 V to ± 2.75 V); many specifications apply from -40°C to $+125^\circ\text{C}$. The [Typical Characteristics](#) section presents parameters that may exhibit significant variance with regard to operating voltage or temperature.

CAUTION

Supply voltages larger than 7 V can permanently damage the device (see the [Absolute Maximum Ratings](#) table).

Place 0.1- μF bypass capacitors close to the power-supply pins to reduce errors coupling in from noisy or high-impedance power supplies. For more detailed information on bypass capacitor placement, refer to the [Layout Guidelines](#) section.

11 Layout

11.1 Layout Guidelines

For best operational performance of the device, use good printed circuit board (PCB) layout practices, including:

- Noise may propagate into analog circuitry through the power pins of the circuit and the operational amplifier. Use bypass capacitors to reduce the coupled noise by providing low-impedance power sources local to the analog circuitry.
 - Connect low-ESR, 0.1- μ F ceramic bypass capacitors between each supply pin and ground, placed as close to the device as possible. A single bypass capacitor from V+ to ground is applicable for single-supply applications.
- Separate grounding for analog and digital portions of the circuitry is one of the simplest and most effective methods of noise suppression. One or more layers on multilayer PCBs are usually devoted to ground planes. A ground plane helps distribute heat and reduces EMI noise pickup. Take care to physically separate digital and analog grounds, paying attention to the flow of the ground current. For more detailed information, see [Circuit Board Layout Techniques](#).
- To reduce parasitic coupling, run the input traces as far away from the supply or output traces as possible. If the traces cannot be kept separate, crossing the sensitive trace perpendicularly is much better than crossing in parallel with the noisy trace.
- Place the external components as close to the device as possible. Keep R_F and R_G close to the inverting input to minimize parasitic capacitance, as shown in [Figure 25](#).
- Keep the length of input traces as short as possible. Remember that the input traces are the most sensitive part of the circuit.
- Consider a driven, low-impedance guard ring around the critical traces. A guard ring may significantly reduce leakage currents from nearby traces that are at different potentials.

11.2 Layout Example: Single Channel

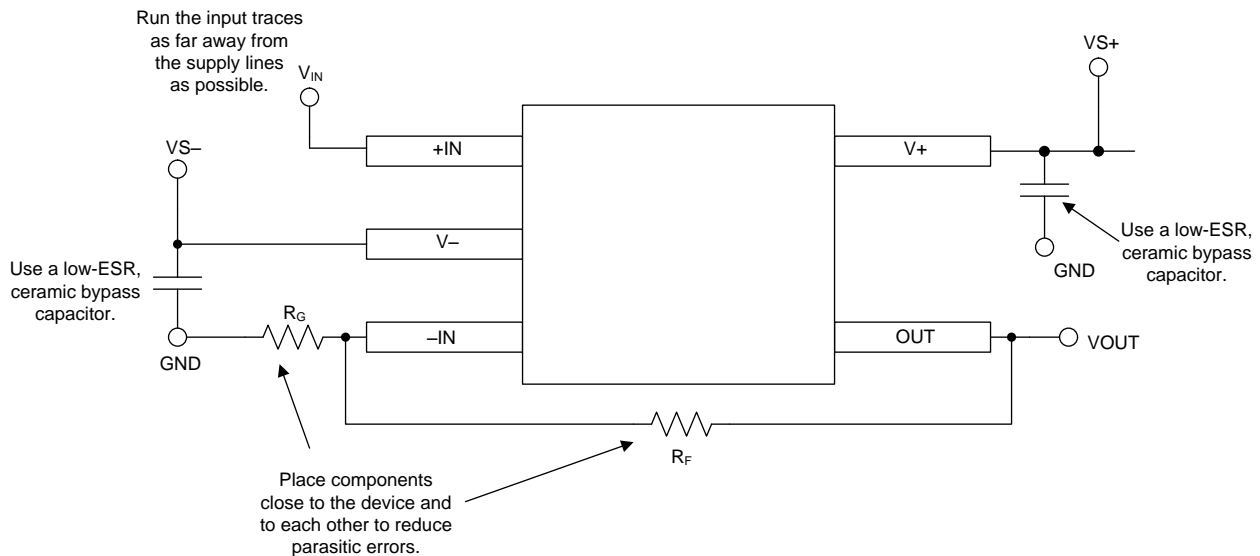

Copyright © 2017, Texas Instruments Incorporated

Figure 25. Operational Amplifier Board Layout for Noninverting Configuration

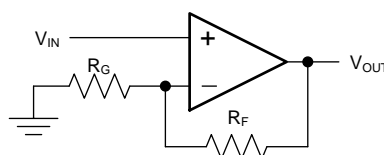

Figure 26. Schematic Representation of [Figure 25](#)

11.3 Layout Example: Dual Channel

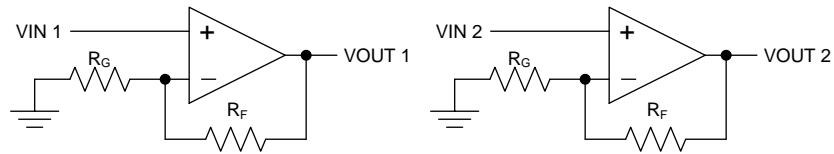

Figure 27. Schematic Representation for Figure 28

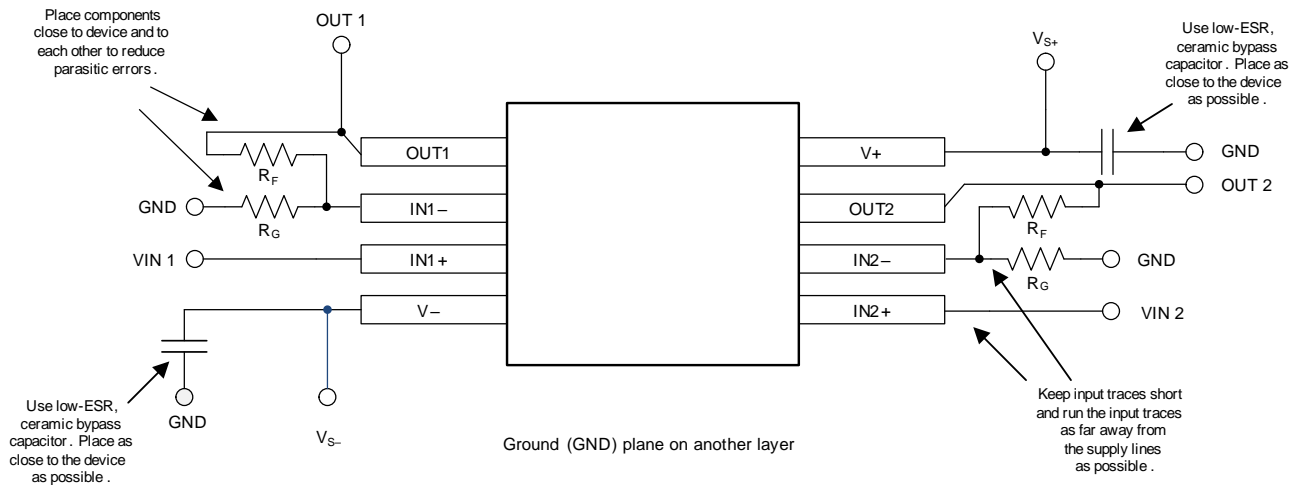

Figure 28. Layout Example

12 Device and Documentation Support

12.1 Documentation Support

12.1.1 Related Documentation

For related documentation, see the following:

- [EMI Rejection Ratio of Operational Amplifiers](#)
- [Circuit Board Layout Techniques](#)

12.2 Related Links

The table below lists quick access links. Categories include technical documents, support and community resources, tools and software, and quick access to order now.

Table 2. Related Links

| PARTS | PRODUCT FOLDER | ORDER NOW | TECHNICAL DOCUMENTS | TOOLS & SOFTWARE | SUPPORT & COMMUNITY |
|------------|----------------------------|----------------------------|----------------------------|----------------------------|----------------------------|
| TLV313-Q1 | Click here | Click here | Click here | Click here | Click here |
| TLV2313-Q1 | Click here | Click here | Click here | Click here | Click here |

12.3 Receiving Notification of Documentation Updates

To receive notification of documentation updates, navigate to the device product folder on ti.com. In the upper right corner, click on *Alert me* to register and receive a weekly digest of any product information that has changed. For change details, review the revision history included in any revised document.

12.4 Community Resources

The following links connect to TI community resources. Linked contents are provided "AS IS" by the respective contributors. They do not constitute TI specifications and do not necessarily reflect TI's views; see TI's [Terms of Use](#).

TI E2E™ Online Community *TI's Engineer-to-Engineer (E2E) Community*. Created to foster collaboration among engineers. At e2e.ti.com, you can ask questions, share knowledge, explore ideas and help solve problems with fellow engineers.

Design Support *TI's Design Support* Quickly find helpful E2E forums along with design support tools and contact information for technical support.

12.5 Trademarks

E2E is a trademark of Texas Instruments.

12.6 Electrostatic Discharge Caution



This integrated circuit can be damaged by ESD. Texas Instruments recommends that all integrated circuits be handled with appropriate precautions. Failure to observe proper handling and installation procedures can cause damage.

ESD damage can range from subtle performance degradation to complete device failure. Precision integrated circuits may be more susceptible to damage because very small parametric changes could cause the device not to meet its published specifications.

12.7 Glossary

[SLYZ022](#) — *TI Glossary*.

This glossary lists and explains terms, acronyms, and definitions.

13 Mechanical, Packaging, and Orderable Information

The following pages include mechanical, packaging, and orderable information. This information is the most current data available for the designated devices. This data is subject to change without notice and revision of this document. For browser-based versions of this data sheet, refer to the left-hand navigation.

PACKAGING INFORMATION

| Orderable Device | Status (1) | Package Type | Package Drawing | Pins | Package Qty | Eco Plan (2) | Lead finish/ Ball material (6) | MSL Peak Temp (3) | Op Temp (°C) | Device Marking (4/5) | Samples |
|------------------|---------------|--------------|-----------------|------|-------------|-----------------|--------------------------------------|----------------------|--------------|-------------------------|-------------------------|
| TLV2313QDGKRQ1 | ACTIVE | VSSOP | DGK | 8 | 2500 | RoHS & Green | NIPDAU NIPDAUAG | Level-2-260C-1 YEAR | -40 to 125 | 1NJ6 | Samples |
| TLV2313QDRQ1 | ACTIVE | SOIC | D | 8 | 2500 | RoHS & Green | NIPDAU | Level-2-260C-1 YEAR | -40 to 125 | V2313Q | Samples |
| TLV313QDCKRQ1 | ACTIVE | SC70 | DCK | 5 | 3000 | RoHS & Green | NIPDAUAG | Level-1-260C-UNLIM | -40 to 125 | 19A | Samples |
| TLV313QDCKTQ1 | ACTIVE | SC70 | DCK | 5 | 250 | RoHS & Green | NIPDAUAG | Level-1-260C-UNLIM | -40 to 125 | 19A | Samples |

(1) The marketing status values are defined as follows:

ACTIVE: Product device recommended for new designs.

LIFEBUY: TI has announced that the device will be discontinued, and a lifetime-buy period is in effect.

NRND: Not recommended for new designs. Device is in production to support existing customers, but TI does not recommend using this part in a new design.

PREVIEW: Device has been announced but is not in production. Samples may or may not be available.

OBSELETE: TI has discontinued the production of the device.

(2) **RoHS:** TI defines "RoHS" to mean semiconductor products that are compliant with the current EU RoHS requirements for all 10 RoHS substances, including the requirement that RoHS substance do not exceed 0.1% by weight in homogeneous materials. Where designed to be soldered at high temperatures, "RoHS" products are suitable for use in specified lead-free processes. TI may reference these types of products as "Pb-Free".

RoHS Exempt: TI defines "RoHS Exempt" to mean products that contain lead but are compliant with EU RoHS pursuant to a specific EU RoHS exemption.

Green: TI defines "Green" to mean the content of Chlorine (Cl) and Bromine (Br) based flame retardants meet JS709B low halogen requirements of <=1000ppm threshold. Antimony trioxide based flame retardants must also meet the <=1000ppm threshold requirement.

(3) MSL, Peak Temp. - The Moisture Sensitivity Level rating according to the JEDEC industry standard classifications, and peak solder temperature.

(4) There may be additional marking, which relates to the logo, the lot trace code information, or the environmental category on the device.

(5) Multiple Device Markings will be inside parentheses. Only one Device Marking contained in parentheses and separated by a "-" will appear on a device. If a line is indented then it is a continuation of the previous line and the two combined represent the entire Device Marking for that device.

(6) Lead finish/Ball material - Orderable Devices may have multiple material finish options. Finish options are separated by a vertical ruled line. Lead finish/Ball material values may wrap to two lines if the finish value exceeds the maximum column width.

Important Information and Disclaimer:The information provided on this page represents TI's knowledge and belief as of the date that it is provided. TI bases its knowledge and belief on information provided by third parties, and makes no representation or warranty as to the accuracy of such information. Efforts are underway to better integrate information from third parties. TI has taken and

continues to take reasonable steps to provide representative and accurate information but may not have conducted destructive testing or chemical analysis on incoming materials and chemicals. TI and TI suppliers consider certain information to be proprietary, and thus CAS numbers and other limited information may not be available for release.

In no event shall TI's liability arising out of such information exceed the total purchase price of the TI part(s) at issue in this document sold by TI to Customer on an annual basis.

OTHER QUALIFIED VERSIONS OF TLV2313-Q1, TLV313-Q1 :

- Catalog : [TLV2313](#), [TLV313](#)

NOTE: Qualified Version Definitions:

- Catalog - TI's standard catalog product

TAPE AND REEL INFORMATION

QUADRANT ASSIGNMENTS FOR PIN 1 ORIENTATION IN TAPE

*All dimensions are nominal

| Device | Package Type | Package Drawing | Pins | SPQ | Reel Diameter (mm) | Reel Width W1 (mm) | A0 (mm) | B0 (mm) | K0 (mm) | P1 (mm) | W (mm) | Pin1 Quadrant |
|----------------|--------------|-----------------|------|------|--------------------|--------------------|---------|---------|---------|---------|--------|---------------|
| TLV2313QDGKRQ1 | VSSOP | DGK | 8 | 2500 | 330.0 | 12.4 | 5.3 | 3.4 | 1.4 | 8.0 | 12.0 | Q1 |
| TLV2313QDRQ1 | SOIC | D | 8 | 2500 | 330.0 | 12.4 | 6.4 | 5.2 | 2.1 | 8.0 | 12.0 | Q1 |
| TLV313QDCKRQ1 | SC70 | DCK | 5 | 3000 | 180.0 | 8.4 | 2.47 | 2.3 | 1.25 | 4.0 | 8.0 | Q3 |
| TLV313QDCKTQ1 | SC70 | DCK | 5 | 250 | 180.0 | 8.4 | 2.47 | 2.3 | 1.25 | 4.0 | 8.0 | Q3 |

TAPE AND REEL BOX DIMENSIONS

*All dimensions are nominal

| Device | Package Type | Package Drawing | Pins | SPQ | Length (mm) | Width (mm) | Height (mm) |
|----------------|--------------|-----------------|------|------|-------------|------------|-------------|
| TLV2313QDGKRQ1 | VSSOP | DGK | 8 | 2500 | 353.0 | 353.0 | 32.0 |
| TLV2313QDRQ1 | SOIC | D | 8 | 2500 | 353.0 | 353.0 | 32.0 |
| TLV313QDCKRQ1 | SC70 | DCK | 5 | 3000 | 183.0 | 183.0 | 20.0 |
| TLV313QDCKTQ1 | SC70 | DCK | 5 | 250 | 183.0 | 183.0 | 20.0 |

DCK0005A



PACKAGE OUTLINE

SOT - 1.1 max height

SMALL OUTLINE TRANSISTOR

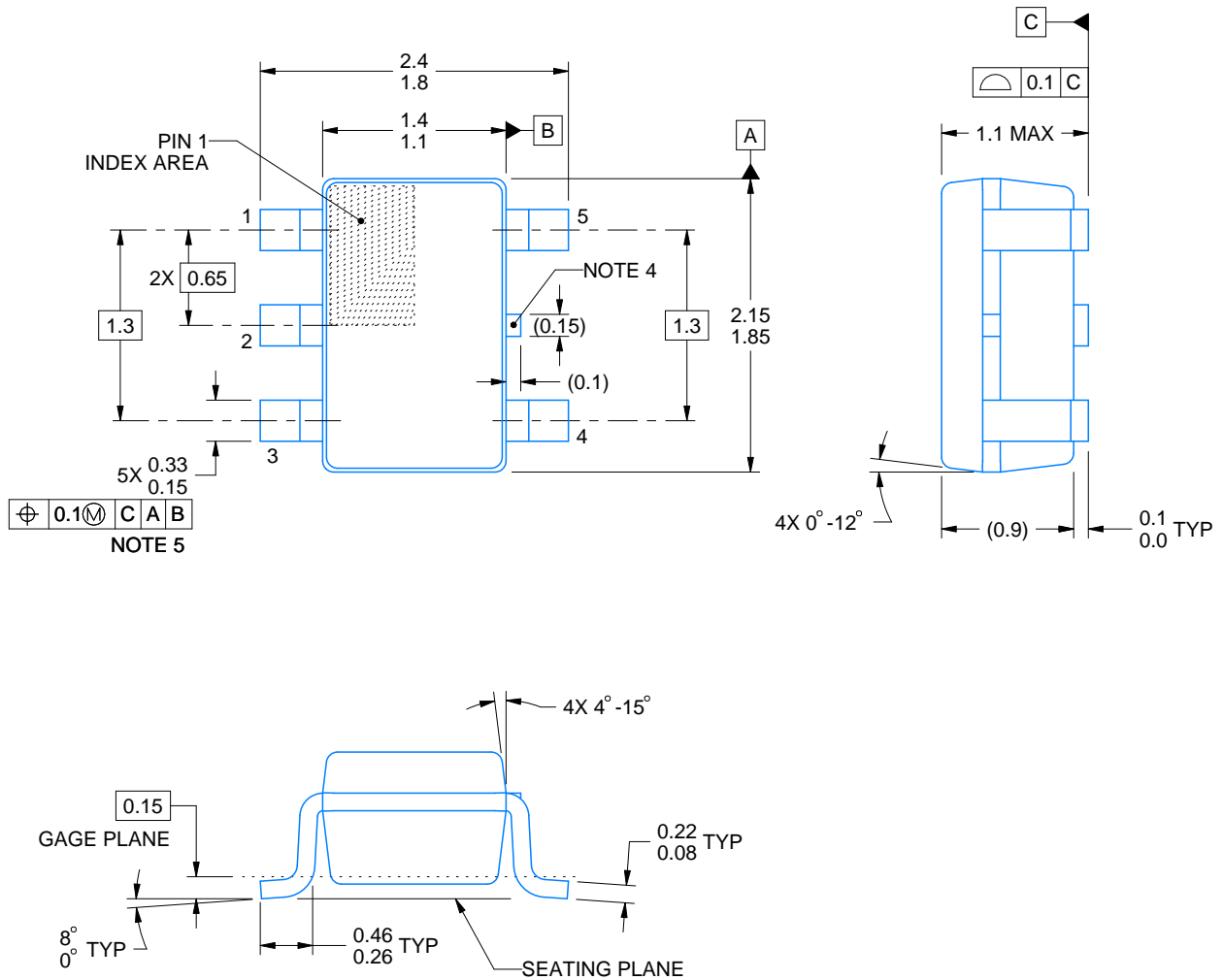

4214834/G 11/2024

NOTES:

1. All linear dimensions are in millimeters. Any dimensions in parenthesis are for reference only. Dimensioning and tolerancing per ASME Y14.5M.
2. This drawing is subject to change without notice.
3. Reference JEDEC MO-203.
4. Support pin may differ or may not be present.
5. Lead width does not comply with JEDEC.
6. Body dimensions do not include mold flash, protrusions, or gate burrs. Mold flash, protrusions, or gate burrs shall not exceed 0.25mm per side

EXAMPLE BOARD LAYOUT

DCK0005A

SOT - 1.1 max height

SMALL OUTLINE TRANSISTOR



LAND PATTERN EXAMPLE
EXPOSED METAL SHOWN
SCALE:18X

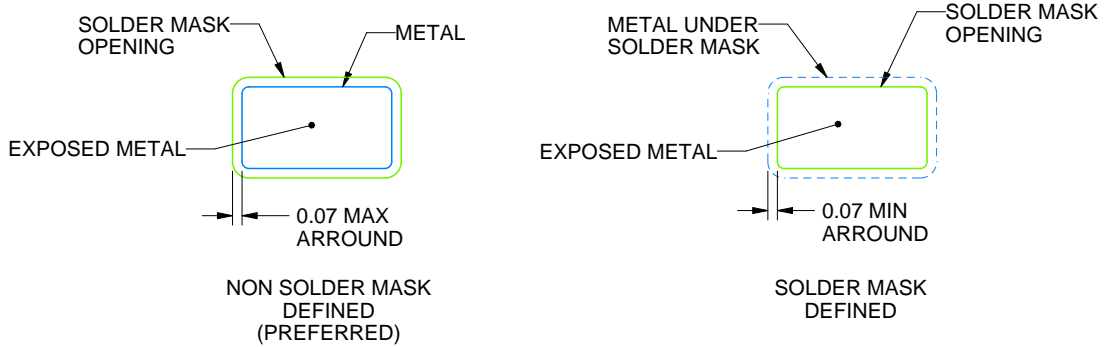

SOLDER MASK DETAILS

4214834/G 11/2024

NOTES: (continued)

- 7. Publication IPC-7351 may have alternate designs.
- 8. Solder mask tolerances between and around signal pads can vary based on board fabrication site.

EXAMPLE STENCIL DESIGN

DCK0005A

SOT - 1.1 max height

SMALL OUTLINE TRANSISTOR



SOLDER PASTE EXAMPLE
BASED ON 0.125 THICK STENCIL
SCALE: 18X

4214834/G 11/2024

NOTES: (continued)

9. Laser cutting apertures with trapezoidal walls and rounded corners may offer better paste release. IPC-7525 may have alternate design recommendations.
10. Board assembly site may have different recommendations for stencil design.



D0008A

PACKAGE OUTLINE

SOIC - 1.75 mm max height

SMALL OUTLINE INTEGRATED CIRCUIT



4214825/C 02/2019

NOTES:

1. Linear dimensions are in inches [millimeters]. Dimensions in parenthesis are for reference only. Controlling dimensions are in inches. Dimensioning and tolerancing per ASME Y14.5M.
2. This drawing is subject to change without notice.
3. This dimension does not include mold flash, protrusions, or gate burrs. Mold flash, protrusions, or gate burrs shall not exceed $.006$ [0.15] per side.
4. This dimension does not include interlead flash.
5. Reference JEDEC registration MS-012, variation AA.

EXAMPLE BOARD LAYOUT

D0008A

SOIC - 1.75 mm max height

SMALL OUTLINE INTEGRATED CIRCUIT



LAND PATTERN EXAMPLE
 EXPOSED METAL SHOWN
 SCALE:8X



SOLDER MASK DETAILS

4214825/C 02/2019

NOTES: (continued)

- 6. Publication IPC-7351 may have alternate designs.
- 7. Solder mask tolerances between and around signal pads can vary based on board fabrication site.

EXAMPLE STENCIL DESIGN

D0008A

SOIC - 1.75 mm max height

SMALL OUTLINE INTEGRATED CIRCUIT



SOLDER PASTE EXAMPLE
BASED ON .005 INCH [0.125 MM] THICK STENCIL
SCALE:8X

4214825/C 02/2019

NOTES: (continued)

8. Laser cutting apertures with trapezoidal walls and rounded corners may offer better paste release. IPC-7525 may have alternate design recommendations.
9. Board assembly site may have different recommendations for stencil design.

DGK0008A



PACKAGE OUTLINE

VSSOP - 1.1 mm max height

SMALL OUTLINE PACKAGE



4214862/A 04/2023

NOTES:

PowerPAD is a trademark of Texas Instruments.

1. All linear dimensions are in millimeters. Any dimensions in parenthesis are for reference only. Dimensioning and tolerancing per ASME Y14.5M.
2. This drawing is subject to change without notice.
3. This dimension does not include mold flash, protrusions, or gate burrs. Mold flash, protrusions, or gate burrs shall not exceed 0.15 mm per side.
4. This dimension does not include interlead flash. Interlead flash shall not exceed 0.25 mm per side.
5. Reference JEDEC registration MO-187.

EXAMPLE BOARD LAYOUT

DGK0008A

™ VSSOP - 1.1 mm max height

SMALL OUTLINE PACKAGE



LAND PATTERN EXAMPLE
EXPOSED METAL SHOWN
SCALE: 15X



SOLDER MASK DETAILS

4214862/A 04/2023

NOTES: (continued)

6. Publication IPC-7351 may have alternate designs.
7. Solder mask tolerances between and around signal pads can vary based on board fabrication site.
8. Vias are optional depending on application, refer to device data sheet. If any vias are implemented, refer to their locations shown on this view. It is recommended that vias under paste be filled, plugged or tented.
9. Size of metal pad may vary due to creepage requirement.

EXAMPLE STENCIL DESIGN

DGK0008A

TM VSSOP - 1.1 mm max height

SMALL OUTLINE PACKAGE



SOLDER PASTE EXAMPLE
SCALE: 15X

4214862/A 04/2023

NOTES: (continued)

11. Laser cutting apertures with trapezoidal walls and rounded corners may offer better paste release. IPC-7525 may have alternate design recommendations.
12. Board assembly site may have different recommendations for stencil design.

IMPORTANT NOTICE AND DISCLAIMER

TI PROVIDES TECHNICAL AND RELIABILITY DATA (INCLUDING DATA SHEETS), DESIGN RESOURCES (INCLUDING REFERENCE DESIGNS), APPLICATION OR OTHER DESIGN ADVICE, WEB TOOLS, SAFETY INFORMATION, AND OTHER RESOURCES "AS IS" AND WITH ALL FAULTS, AND DISCLAIMS ALL WARRANTIES, EXPRESS AND IMPLIED, INCLUDING WITHOUT LIMITATION ANY IMPLIED WARRANTIES OF MERCHANTABILITY, FITNESS FOR A PARTICULAR PURPOSE OR NON-INFRINGEMENT OF THIRD PARTY INTELLECTUAL PROPERTY RIGHTS.

These resources are intended for skilled developers designing with TI products. You are solely responsible for (1) selecting the appropriate TI products for your application, (2) designing, validating and testing your application, and (3) ensuring your application meets applicable standards, and any other safety, security, regulatory or other requirements.

These resources are subject to change without notice. TI grants you permission to use these resources only for development of an application that uses the TI products described in the resource. Other reproduction and display of these resources is prohibited. No license is granted to any other TI intellectual property right or to any third party intellectual property right. TI disclaims responsibility for, and you will fully indemnify TI and its representatives against, any claims, damages, costs, losses, and liabilities arising out of your use of these resources.

TI's products are provided subject to [TI's Terms of Sale](#) or other applicable terms available either on [ti.com](https://www.ti.com) or provided in conjunction with such TI products. TI's provision of these resources does not expand or otherwise alter TI's applicable warranties or warranty disclaimers for TI products.

TI objects to and rejects any additional or different terms you may have proposed.

Mailing Address: Texas Instruments, Post Office Box 655303, Dallas, Texas 75265
Copyright © 2025, Texas Instruments Incorporated