

# TLV3011-EP and TLV3012-EP Enhanced Product Low Power Comparators With Integrated 1.24V Voltage Reference

## 1 Features

- VID V62/07604-01XE (TLV3011-EP)
- VID V62/23603-01XE (TLV3012-EP)
- Controlled baseline
  - One assembly - test site
  - One fabrication site
  - Extended product life cycle
- Enhanced diminishing manufacturing sources (DMS) support
- Extended temperature range of  $-55^{\circ}\text{C}$  to  $125^{\circ}\text{C}$
- Low quiescent current:  $3.1\ \mu\text{A}$  (maximum)
- Integrated series voltage reference:  $1.242\ \text{V}$
- Input common-mode range:  $200\ \text{mV}$  beyond rails
- Voltage reference initial accuracy: 1%
- Open-drain output (TLV3011-EP)
- Push-pull output (TLV3012-EP)
- Interated hysteresis (TLV3012-EP Only)
- Fail-safe inputs (TLV3012-EP Only)
- Power on reset (TLV3012-EP Only)
- Supply range:  $1.65\ \text{V}$  to  $5.5\ \text{V}$  (TLV3012-EP Only)
- Fast response time:  $2\ \mu\text{s}$
- Microsize package: SOT-23-6

## 2 Applications

- [Battery-powered level detection](#)
- [Data acquisition](#)
- [System monitoring](#)
- [Oscillators](#)
- [Sensor systems](#)

## 3 Description

The TLV3011-EP is a low-power, open-drain output comparator; the TLV3012-EP is a push-pull output comparator. Both devices feature an uncommitted onchip voltage reference and have a  $3.1\ \mu\text{A}$  (maximum) quiescent current, an input common-mode range  $200\ \text{mV}$  beyond the supply rails, and single-supply operation from  $1.65\ \text{V}$  to  $5.5\ \text{V}$ .

The integrated  $1.242\text{-V}$  series voltage reference offers low  $100\text{-ppm}/^{\circ}\text{C}$  (maximum) drift, is stable with up to  $10\text{-nF}$  capacitive load, and can sink or source up to  $0.5\ \text{mA}$  (typical) of output current that allows driving external circuitry.

The TLV3011-EP and TLV3012-EP are available in the tiny SOT-23-6 package for constrained-space designs. The devices are specified for the extended temperature range of  $-55^{\circ}\text{C}$  to  $125^{\circ}\text{C}$ .

**Table 3-1. Device Information**

PART NUMBER	PACKAGE (1)	BODY SIZE (NOM)
TLV3011-EP, TLV3012-EP	SOT-23 (6)	$2.90\ \text{mm} \times 1.60\ \text{mm}$

- (1) For all available packages, see the orderable addendum at the end of the data sheet.

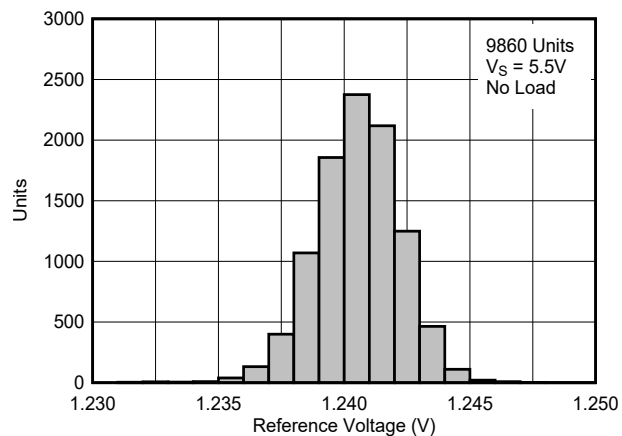

**TLV3012-EP Reference Voltage Distribution**

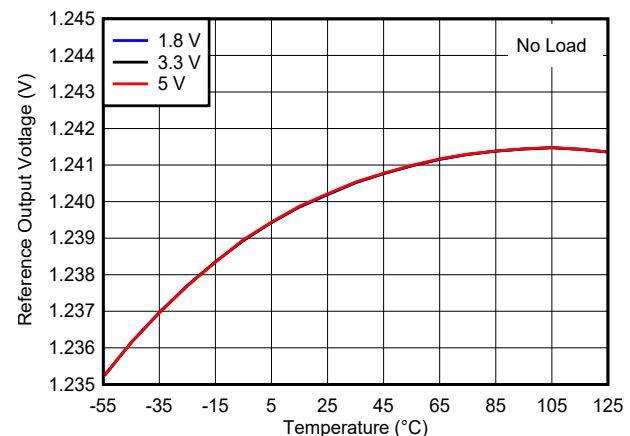

**TLV3012-EP Reference Voltage vs Temperature**



## Table of Contents

<b>1 Features</b> .....	<b>1</b>	<b>7 Detailed Description</b> .....	<b>18</b>
<b>2 Applications</b> .....	<b>1</b>	7.1 Overview.....	18
<b>3 Description</b> .....	<b>1</b>	7.2 Functional Block Diagram.....	18
<b>4 Revision History</b> .....	<b>2</b>	7.3 Feature Description.....	18
<b>5 Pin Configuration and Functions</b> .....	<b>3</b>	7.4 Device Functional Modes.....	18
<b>6 Specifications</b> .....	<b>4</b>	<b>8 Application and Implementation</b> .....	<b>20</b>
6.1 Absolute Maximum Ratings - TLV3011-EP.....	4	8.1 Application Information.....	20
6.2 Absolute Maximum Ratings - TLV3012-EP.....	4	8.2 Typical Application.....	21
6.3 ESD Ratings.....	4	8.3 Power Supply Recommendations.....	23
6.4 Thermal Resistance Characteristics.....	5	8.4 Layout.....	23
6.5 Recommended Operating Conditions - TLV3011-EP.....	5	<b>9 Device and Documentation Support</b> .....	<b>24</b>
6.6 Recommended Operating Conditions - TLV3012-EP.....	5	9.1 Receiving Notification of Documentation Updates.....	24
6.7 Electrical Characteristics - TLV3011-EP.....	6	9.2 Support Resources.....	24
6.8 Electrical Characteristics - TLV3012-EP.....	7	9.3 Trademarks.....	24
6.9 Switching Characteristics - TLV3012-EP.....	8	9.4 Electrostatic Discharge Caution.....	24
6.10 Typical Characteristics - TLV3011-EP.....	9	9.5 Glossary.....	24
6.11 Typical Characteristics - TLV3012-EP.....	12	<b>10 Mechanical, Packaging, and Orderable Information</b> .....	<b>25</b>

## 4 Revision History

NOTE: Page numbers for previous revisions may differ from page numbers in the current version.

<b>Changes from Revision * (October 2006) to Revision A (May 2023)</b>	<b>Page</b>
• Updated the numbering format for tables, figures, and cross-references throughout the document.....	1
• Added TLV3012-EP device.....	1
• Updated <i>Features</i> , <i>Description</i> and <i>Device Information</i> table for new device.....	1
• Added TLV3012-EP <i>Electirical Characteristics</i> Tables.....	4
• Added TLV3012-EP <i>Typical Characteristics</i> graphs.....	12
• Updated <i>Detailed Description</i> section.....	18

## 5 Pin Configuration and Functions

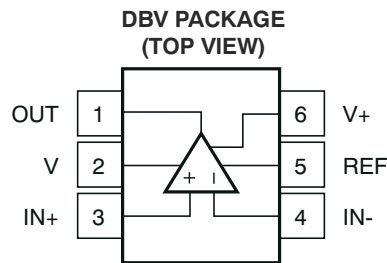

**DBV Package  
6-Pin SOT-23  
Top View**

**Table 5-1. Pin Functions**

PIN		TYPE <sup>(1)</sup>	DESCRIPTION
NAME	NO.		
OUT	1	O	Comparator Output
V-	2	P	Negative Supply Voltage
IN+	3	I	Non-Inverting (Positive) Input
IN-	4	I	Inverting (Negative) Input
REF	5	O	Reference Voltage Output
V+	6	P	Positive Supply Voltage

## 6 Specifications

### 6.1 Absolute Maximum Ratings - TLV3011-EP

over operating free-air temperature range (unless otherwise noted)<sup>(1)</sup>

		MIN	MAX	UNIT	
	Supply voltage		7	V	
	Signal input terminals	Voltage <sup>(2)</sup>	-0.5	(V+) +0.5	V
		Current <sup>(2)</sup>		±10	mA
	Output short circuit <sup>(3)</sup>	Continuous			
	Operating temperature range	-55	125	°C	
T <sub>stg</sub>	Storage temperature range	-65	150	°C	
T <sub>J</sub>	Junction temperature		150	°C	

- (1) Stresses beyond those listed under "absolute maximum ratings" may cause permanent damage to the device. These are stress ratings only, and functional operation of the device at these or any other conditions beyond those indicated under "recommended operating conditions" is not implied. Exposure to absolute-maximum-rated conditions for extended periods may affect device reliability.
- (2) All voltage values are with respect to the network ground terminal.
- (3) Short circuit to ground

### 6.2 Absolute Maximum Ratings - TLV3012-EP

over operating free-air temperature range (unless otherwise noted)<sup>(1)</sup>

		MIN	MAX	UNIT
Supply voltage: V <sub>S</sub> = (V+) – (V–)		-0.5	7	V
Input pins (IN+, IN–) from (V–) <sup>(2)</sup>		-0.5	7	V
Output (OUT) (Push-Pull) from (V–)		-0.5	(V+) + 0.5	V
Output short circuit current <sup>(3)</sup>			10	mA
Junction temperature, T <sub>J</sub>			150	°C
Storage temperature, T <sub>stg</sub>		-65	150	°C

- (1) Operation outside the Absolute Maximum Ratings may cause permanent device damage. Absolute Maximum Ratings do not imply functional operation of the device at these or any other conditions beyond those listed under Recommended Operating Conditions. If used outside the Recommended Operating Conditions but within the Absolute Maximum Ratings, the device may not be fully functional, and this may affect device reliability, functionality, performance, and shorten the device lifetime.
- (2) Input pins are diode-clamped to (V–). Inputs (IN+, IN–) can be greater than (V+) as long as within the –0.5 V to 7 V range. Inputs beyond –0.3 V must be current-limited to less than –10 mA, while inputs beyond 7 V must be externally voltage clamped.
- (3) Short-circuit to (V–) or (V+).

### 6.3 ESD Ratings

		VALUE	UNIT
V <sub>(ESD)</sub>	Electrostatic discharge	Human-body model (HBM), per ANSI/ESDA/JEDEC JS-001 <sup>(1)</sup>	±2000
		Charged-device model (CDM), per ANSI/ESDA/JEDEC JS-002 <sup>(2)</sup> (TLV3012-EP Only)	±1000

- (1) JEDEC document JEP155 states that 500 V HBM allows safe manufacturing with a standard ESD control process.
- (2) JEDEC document JEP157 states that 250 V CDM allows safe manufacturing with a standard ESD control process.

## 6.4 Thermal Resistance Characteristics

THERMAL METRIC <sup>1</sup>		TLV3011-EP	TLV3012-EP	UNIT
		DBV (SOT-23)	DBV (SOT-23)	
		6 PINS	6 PINS	
$R_{\theta JA}$	Junction-to-ambient thermal resistance	191.9	162.5	°C/W
$R_{\theta JC(top)}$	Junction-to-case (top) thermal resistance	123.9	78.8	°C/W
$R_{\theta JB}$	Junction-to-board thermal resistance	38.7	42.1	°C/W
$\Psi_{JT}$	Junction-to-top characterization parameter	21.2	21.2	°C/W
$\Psi_{JB}$	Junction-to-board characterization parameter	38.2	41.9	°C/W

(1) For more information about traditional and new thermal metrics, see the [Semiconductor and IC package thermal metrics](#) report.

## 6.5 Recommended Operating Conditions - TLV3011-EP

over operating free-air temperature range (unless otherwise noted)

	MIN	MAX	UNIT
Supply voltage: $V_S = (V+) - (V-)$	1.8	5.5	V
Input voltage range from (V-)	-0.2	(V+) + 0.2	V
Output voltage range from (V-)	-0.2	≤ V+	V
Ambient temperature, $T_A$	-55	125	°C

## 6.6 Recommended Operating Conditions - TLV3012-EP

over operating free-air temperature range (unless otherwise noted)

	MIN	MAX	UNIT
Supply voltage: $V_S = (V+) - (V-)$	1.65	5.5	V
Input voltage range from (V-)	-0.2	(V+) + 0.2	V
Ambient temperature, $T_A$	-55	125	°C

## 6.7 Electrical Characteristics - TLV3011-EP

over operating free-air temperature range (unless otherwise noted)

PARAMETER		TEST CONDITIONS	MIN	TYP	MAX	UNIT	
<b>Offset Voltage</b>							
$V_{OS}$	Input offset voltage	$V_{CM} = 0\text{ V}, I_O = 0\text{ V}$		0.5	15	mV	
$dV_{OS}/dT$	Input offset voltage vs temperature	$T_A = -55^\circ\text{C to } 125^\circ\text{C}$		$\pm 12$		$\mu\text{V}/^\circ\text{C}$	
PSRR	Power supply rejection ratio	$V_S = 1.8\text{ V to } 5.5\text{ V}$		100	1000	$\mu\text{V}/\text{V}$	
<b>Input Bias Current</b>							
$I_S$	Input bias current	$V_{CM} = V_S/2$		$\pm 10$		pA	
$I_{OS}$	Input offset current	$V_{CM} = V_S/2$		$\pm 10$		pA	
<b>Input Voltage Range</b>							
$V_{CM}$	Common-mode voltage range		$(V-) - 0.2$		$(V+) + 0.2$	V	
CMRR	Common-mode rejection ratio	$V_{CM} = -0.2\text{ V to } (V+) - 1.5\text{ V}$	60	74		dB	
		$V_{CM} = -0.2\text{ V to } (V+) + 0.2\text{ V}$	54	62			
<b>Input Impedance</b>							
	Common mode			$10^{13} \parallel 2$		$\Omega \parallel \text{pF}$	
	Differential			$10^{13} \parallel 4$		$\Omega \parallel \text{pF}$	
<b>Switching Characteristics</b>							
$t_{pd}$	Propagation delay time	Low to high	$f = 10\text{ kHz}, V_{STEP} = 1\text{ V},$ input overdrive = 10 mV		12	$\mu\text{s}$	
			$f = 10\text{ kHz}, V_{STEP} = 1\text{ V},$ input overdrive = 100 mV		6		
		High to low	$f = 10\text{ kHz}, V_{STEP} = 1\text{ V},$ input overdrive = 10 mV		13.5		
			$f = 10\text{ kHz}, V_{STEP} = 1\text{ V},$ input overdrive = 100 mV		6.5		
$t_r$	Rise time	$C_L = 10\text{ pF}$		(1)			
$t_f$	Fall time	$C_L = 10\text{ pF}$		100		ns	
<b>Output</b>							
$V_{OL}$	Voltage output low from rail	$V_S = 5\text{ V}$		160	200	mV	
<b>Voltage Reference</b>							
$V_{OUT}$	Output voltage		1.208	1.242	1.276	V	
	Initial accuracy				$\pm 1\%$		
$dV_{OUT}/dT$	Temperature drift	$-55^\circ\text{C} \leq T_A \leq 125^\circ\text{C}$		40	100	ppm/ $^\circ\text{C}$	
$dV_{OUT}/dI_{LOAD}$	Load regulation	Sourcing	$0\text{ mA} < I_{SOURCE} \leq 0.5\text{ mA}$		0.36	1	mV/mA
		Sinking	$0\text{ mA} < I_{SINK} \leq 0.5\text{ mA}$		6.6		
$I_{LOAD}$	Output current			0.5		mA	
$dV_{OUT}/dV_{IN}$	Line regulation	$1.8\text{ V} \leq V_{IN} \leq 5.5\text{ V}$		10	100	$\mu\text{V}/\text{V}$	
<b>Noise</b>							
	Reference voltage noise	$f = 0.1\text{ Hz to } 10\text{ Hz}$		0.2		mV <sub>PP</sub>	
<b>Power Supply</b>							
$V_S$	Specified voltage		1.8		5.5	V	
	Operating voltage range		1.8		5.5	V	
$I_Q$	Quiescent current	$V_S = 5\text{ V}, V_O = \text{High}$		2.8	5	$\mu\text{A}$	

(1)  $t_r$  dependent on  $R_{PULLUP}$  and  $C_{LOAD}$ .

## 6.8 Electrical Characteristics - TLV3012-EP

For  $V_S$  (TOTAL SUPPLY VOLTAGE) =  $(V+) - (V-) = 1.8V$  and  $5.5V$ ,  $V_{CM} = V_S/2$  at  $T_A = 25^\circ C$  (Unless otherwise noted)

PARAMETER		TEST CONDITIONS	MIN	TYP	MAX	UNIT
<b>OFFSET VOLTAGE</b>						
$V_{OS}$	Input offset voltage	$V_{CM} = (V-)$	-6	±0.3	6	mV
$V_{OS}$	Input offset voltage	$V_{CM} = (V-)$ $T_A = -55^\circ C$ to $+125^\circ C$	-9		9	mV
$dV_{IO}/dT$	Input offset voltage drift	$V_{CM} = (V-)$ $T_A = -55^\circ C$ to $+125^\circ C$		±12		$\mu V/^\circ C$
PSRR	power supply rejection ratio	$V_{CM} = (V-)$ $V_S = 1.65 V$ to $5.5 V$ $T_A = -55^\circ C$ to $+125^\circ C$		100	1000	$\mu V/V$
$V_{HYS}$	Input hysteresis voltage	$T_A = -55^\circ C$ to $+125^\circ C$	2	6	8	mV
<b>INPUT BIAS CURRENT</b>						
$I_B$	Input bias current	$V_{CM} = V_S/2$	-10 <sup>(1)</sup>	±4.5	10 <sup>(1)</sup>	pA
$I_{OS}$	Input offset current	$V_{CM} = V_S/2$	-10 <sup>(1)</sup>	±1	10 <sup>(1)</sup>	pA
<b>INPUT COMMON MODE RANGE</b>						
$V_{CM-Range}$	Common-mode voltage range	$V_S = 1.8 V$ to $5.5 V$ $T_A = -55^\circ C$ to $+125^\circ C$	$(V-) - 0.2$		$(V+) + 0.2$	V
CMRR	Common mode rejection ratio	$V_{CM} = (V-) + 1.5V$ to $(V+) + 0.2V$ $T_A = -55^\circ C$ to $+125^\circ C$	60	74		dB
CMRR	Common mode rejection ratio	$V_{CM} = (V-) - 0.2V$ to $(V+) + 0.2V$ $T_A = -55^\circ C$ to $+125^\circ C$	54	62		dB
$R_{CM}$	Input Common Mode Resistance			$10^{13}$		$\Omega$
$C_{IC}$	Input Common Mode Capacitance			2		pF
<b>INPUT IMPEDANCE</b>						
$R_{DM}$	Input Differential Mode Resistance			$10^{13}$		$\Omega$
$C_{ID}$	Input Differential Mode Capacitance			4		pF
<b>OUTPUT</b>						
$V_{OL}$	Voltage swing from $(V-)$	$V_S = 5 V$ $I_{SINK} = 5 mA$ $T_A = -55^\circ C$ to $+125^\circ C$		160	200	mV
$V_{OH}$	Voltage swing from $(V+)$	$V_S = 5 V$ $I_{SOURCE} = 5 mA$ $T_A = -55^\circ C$ to $+125^\circ C$		90	200	mV
<b>VOLTAGE REFERENCE</b>						
$V_{OUT}$	Reference Voltage		1.223	1.242	1.260	V
	Accuracy			±0.25%	±1.5%	
$dV_{OUT}/dT$	Temperature Drift	$T_A = -55^\circ C$ to $+125^\circ C$		40	100	ppm/ $^\circ C$
$dV_{OUT}/dI_{LOAD}$	Load Regulation, Sourcing	$0 mA < I_{SOURCE} \leq 0.5 mA$		0.36	1 <sup>(1)</sup>	mV/mA
	Load Regulation, Sinking	$0 mA < I_{SINK} \leq 0.5 mA$		6.6		mV/mA
$I_{LOAD}$	Output Current			0.5		mA
$dV_{OUT}/dV_S$	Line Regulation	$1.65 V \leq V_S \leq 5.5 V$		10	100 <sup>(1)</sup>	$\mu V/V$
$V_{noise}$	Noise	$f = 0.1 Hz$ to $10 Hz$		0.2		mV <sub>PP</sub>

## 6.8 Electrical Characteristics - TLV3012-EP (continued)

For  $V_S$  (TOTAL SUPPLY VOLTAGE) = (V+) – (V-) = 1.8V and 5.5V,  $V_{CM} = V_S / 2$  at  $T_A = 25^\circ\text{C}$  (Unless otherwise noted)

PARAMETER		TEST CONDITIONS	MIN	TYP	MAX	UNIT
<b>POWER SUPPLY</b>						
$I_Q$	Quiescent current per comparator	Output is logic high		2.4	3.1	$\mu\text{A}$
$I_Q$	Quiescent current per comparator	Output is logic high $T_A = -55^\circ\text{C}$ to $+125^\circ\text{C}$			3.6	$\mu\text{A}$

(1) Ensured by characterization

## 6.9 Switching Characteristics - TLV3012-EP

For  $V_S$  (TOTAL SUPPLY VOLTAGE) = (V+) – (V-) = 1.8 V and 5.5 V,  $V_{CM} = V_S / 2$  at  $T_A = 25^\circ\text{C}$  (Unless otherwise noted)

PARAMETER		TEST CONDITIONS	MIN	TYP	MAX	UNIT
<b>OUTPUT</b>						
$T_{PD-LH}$	Propagation delay time, low-to-high (push-pull output)	$f = 10\text{ kHz}$ , $V_{STEP} = 200\text{mV}$ , $V_{OD} = 100\text{ mV}$ , $C_L = 10\text{ pF}$		2	4	$\mu\text{s}$
$T_{PD-HL}$	Propagation delay time, high-to-low	$f = 10\text{ kHz}$ , $V_{STEP} = 200\text{mV}$ , $V_{OD} = 100\text{ mV}$ , $C_L = 10\text{ pF}$		2	4	$\mu\text{s}$
$T_{RISE}$	Output Rise Time, 20% to 80%, push-pull output	$C_L = 10\text{ pF}$		10		ns
$T_{FALL}$	Output Fall Time, 80% to 20%	$C_L = 10\text{ pF}$		10		ns
$T_{FALL}$	Output Fall Time, 80% to 20%, open-drain output	$R_L = 10\text{ k}\Omega$ , $C_L = 10\text{ pF}$		10		ns
$t_{ON}$	Power on-time			1.9		ms



## 6.10 Typical Characteristics - TLV3011-EP

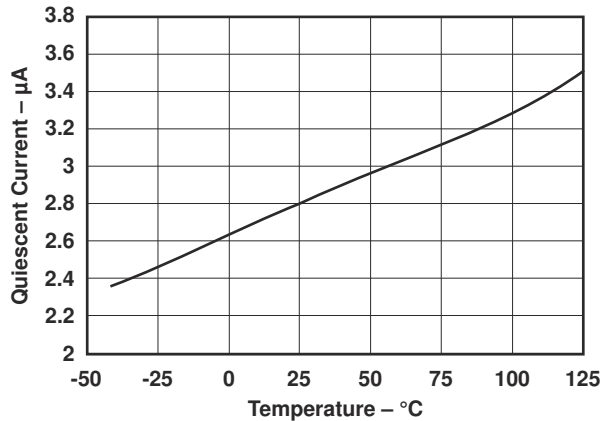

Figure 6-1. QUIESCENT CURRENT vs TEMPERATURE

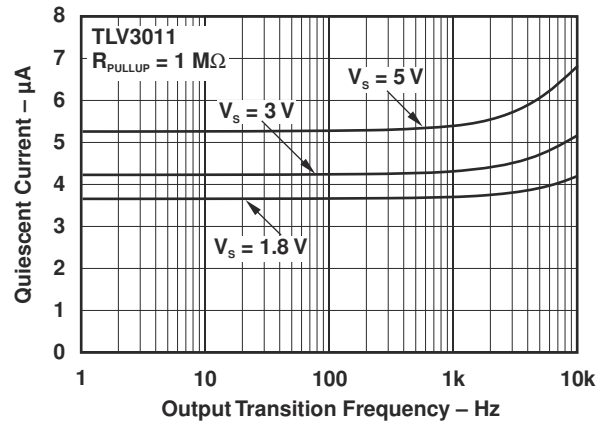

Figure 6-2. QUIESCENT CURRENT vs OUTPUT SWITCHING FREQUENCY

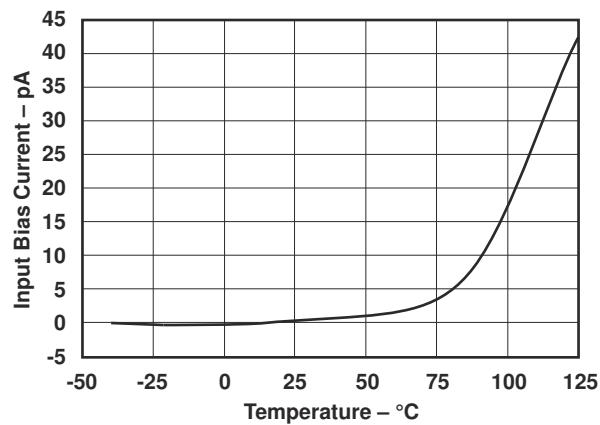

Figure 6-3. INPUT BIAS CURRENT vs TEMPERATURE

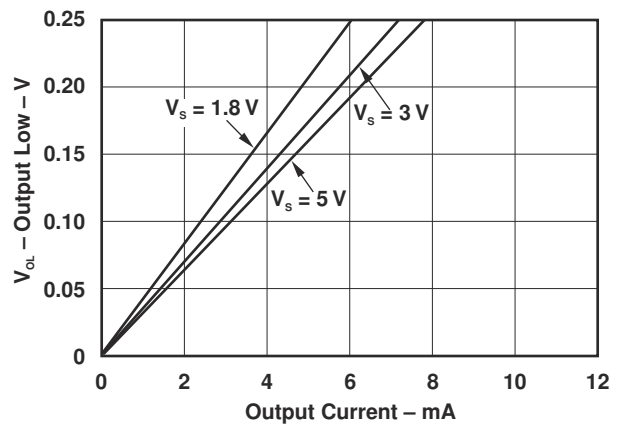

Figure 6-4. OUTPUT LOW vs OUTPUT CURRENT

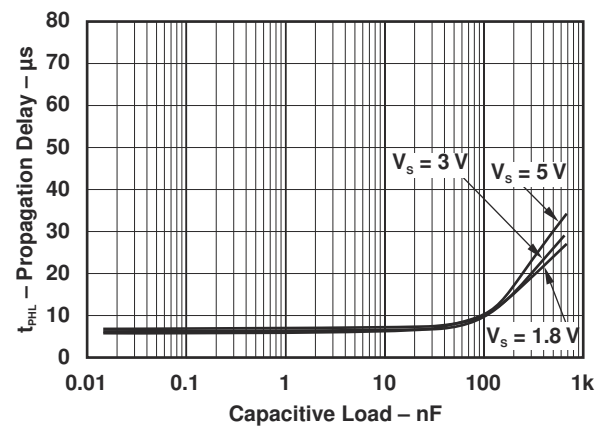

Figure 6-5. PROPAGATION DELAY ( $t_{PHL}$ ) vs CAPACITIVE LOAD

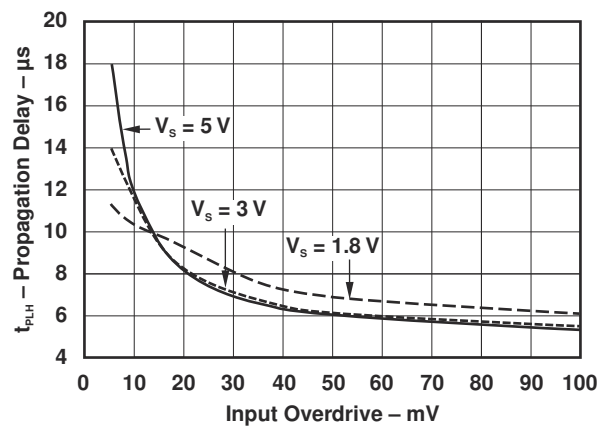

Figure 6-6. PROPAGATION DELAY ( $t_{PLH}$ ) vs INPUT OVERDRIVE

### 6.10 Typical Characteristics - TLV3011-EP (continued)

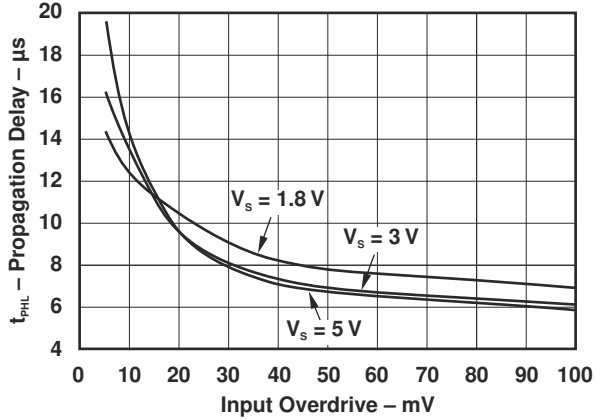

Figure 6-7. PROPAGATION DELAY ( $t_{pHL}$ ) vs INPUT OVERDRIVE

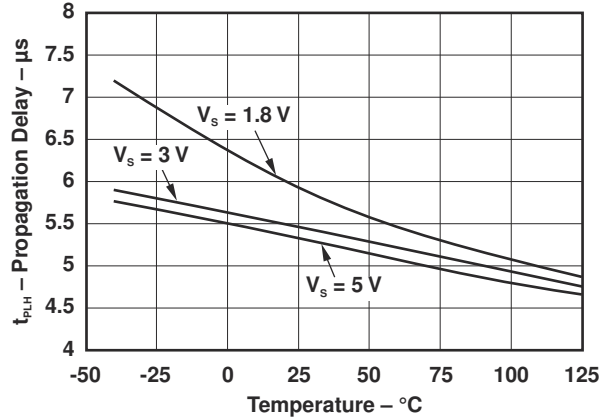

Figure 6-8. PROPAGATION DELAY ( $t_{pLH}$ ) vs TEMPERATURE

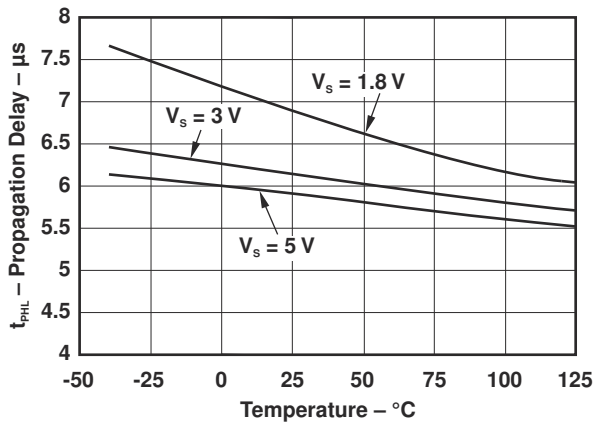

Figure 6-9. PROPAGATION DELAY ( $t_{pHL}$ ) vs TEMPERATURE

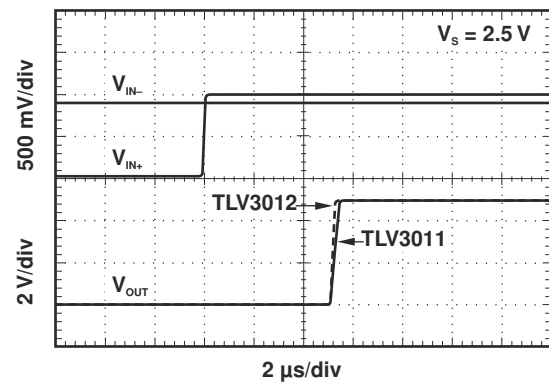

Figure 6-10. PROPAGATION DELAY ( $t_{pLH}$ )

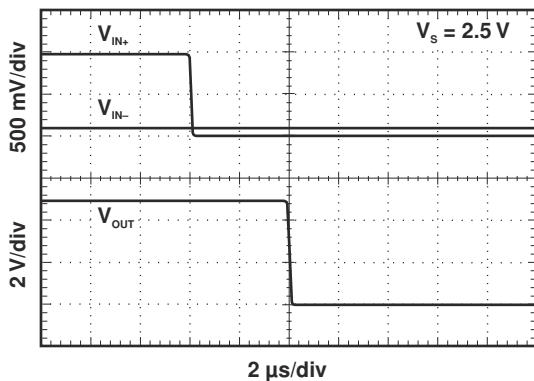

Figure 6-11. PROPAGATION DELAY ( $t_{pHL}$ )

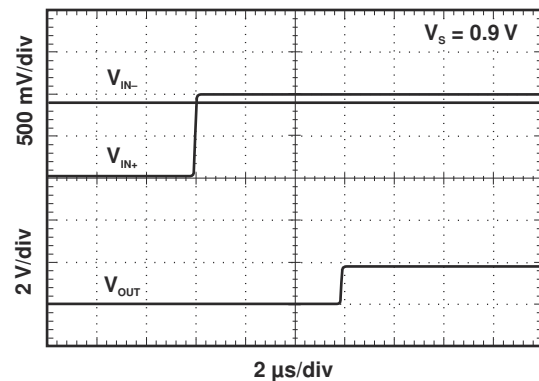

Figure 6-12. PROPAGATION DELAY ( $t_{pLH}$ )

### 6.10 Typical Characteristics - TLV3011-EP (continued)

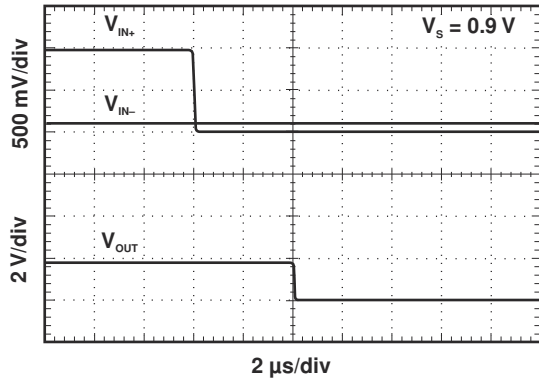

Figure 6-13. PROPAGATION DELAY ( $t_{PHL}$ )

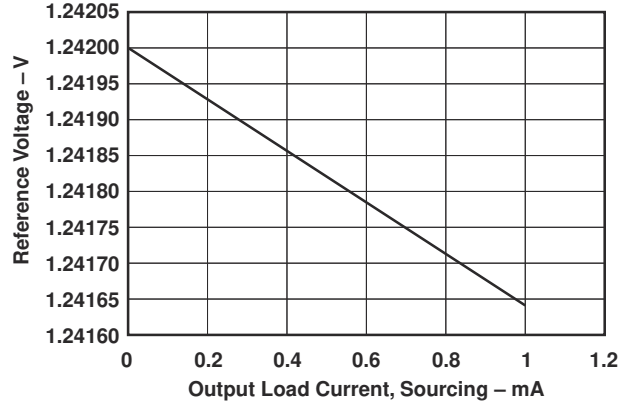

Figure 6-14. REFERENCE VOLTAGE vs OUTPUT LOAD CURRENT (SOURCING)

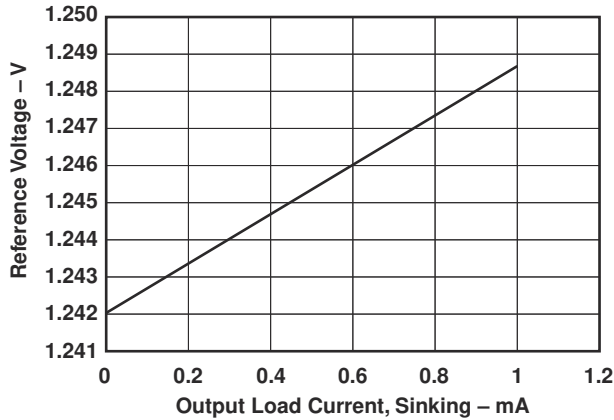

Figure 6-15. REFERENCE VOLTAGE vs OUTPUT LOAD CURRENT (SINKING)

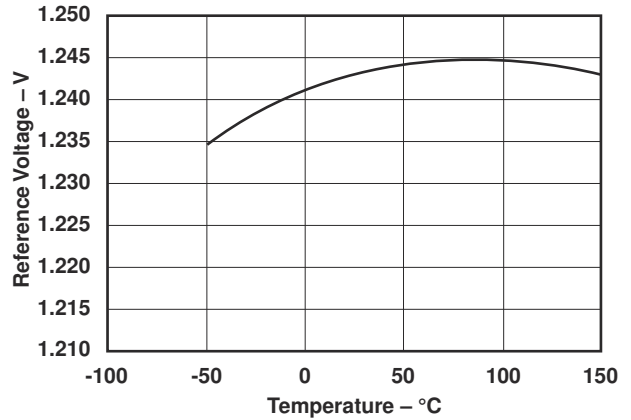

Figure 6-16. REFERENCE VOLTAGE vs TEMPERATURE

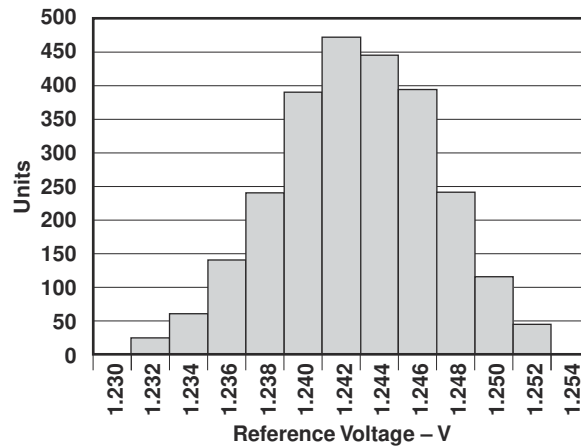

Figure 6-17. REFERENCE VOLTAGE DISTRIBUTION

### 6.11 Typical Characteristics - TLV3012-EP

For  $V_S$  (Total Supply Voltage) =  $(V+) - (V-) = +5V$ ,  $V_{CM} = V_S / 2$  at  $T_A = 25^\circ C$ ,  $R_{PULLUP} = 1M\Omega$  to  $V+$ ,  $C_L = 15pF$ ,  $V_{OD} = 100mV$  unless otherwise noted.

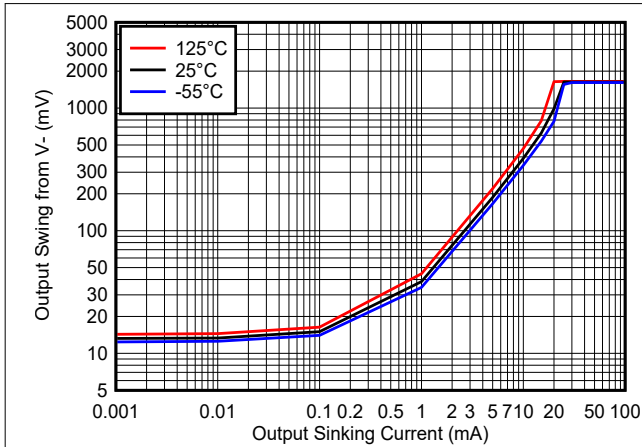

Figure 6-18. Output Swing vs. Output Sinking Current - 1.8V

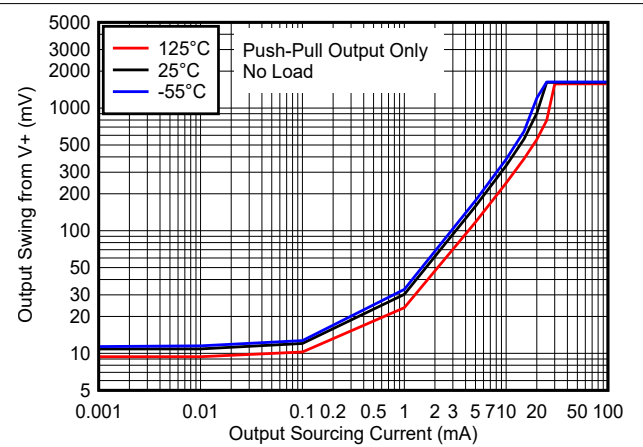

Figure 6-19. Output Swing vs. Output Sourcing Current - 1.8V

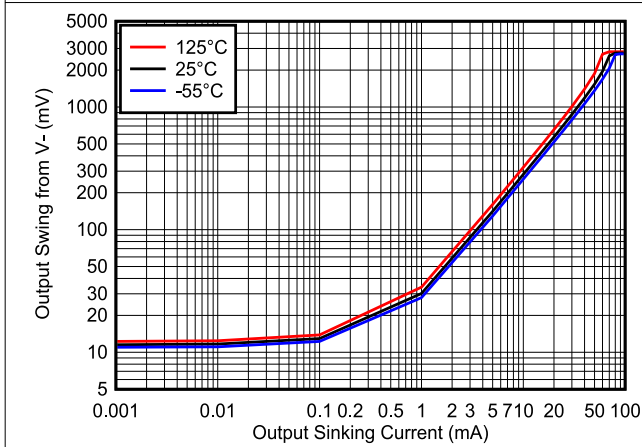

Figure 6-20. Output Swing vs. Output Sinking Current - 3.3V

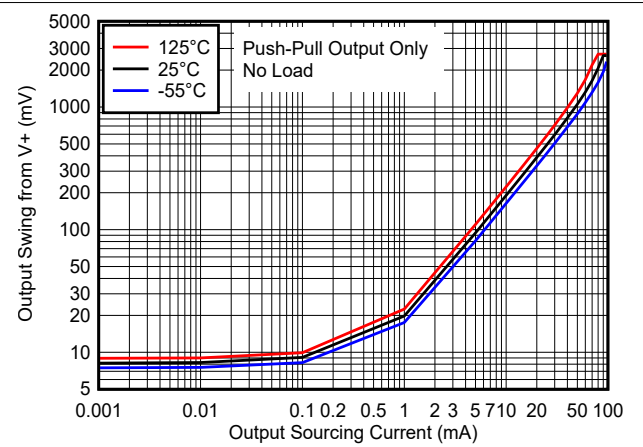

Figure 6-21. Output Swing vs. Output Sourcing Current - 3.3V

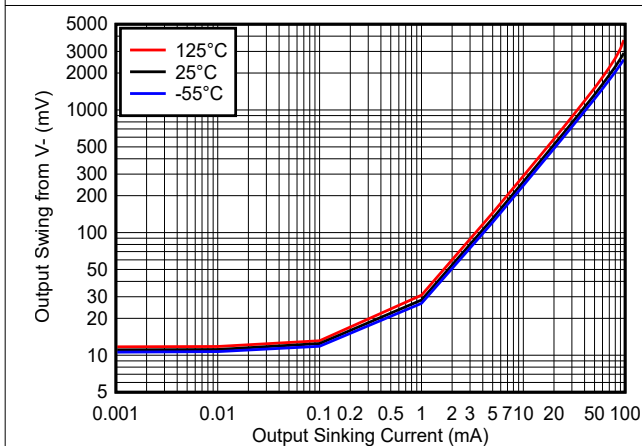

Figure 6-22. Output Swing vs. Output Sinking Current - 5V

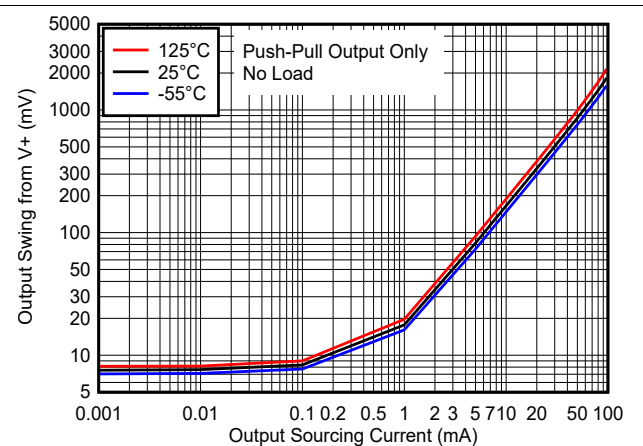

Figure 6-23. Output Swing vs. Output Sourcing Current - 5V

### 6.11 Typical Characteristics - TLV3012-EP (continued)

For  $V_S$  (Total Supply Voltage) =  $(V+) - (V-) = +5V$ ,  $V_{CM} = V_S / 2$  at  $T_A = 25^\circ C$ ,  $R_{PULLUP} = 1M\Omega$  to  $V+$ ,  $C_L = 15pF$ ,  $V_{OD} = 100mV$  unless otherwise noted.

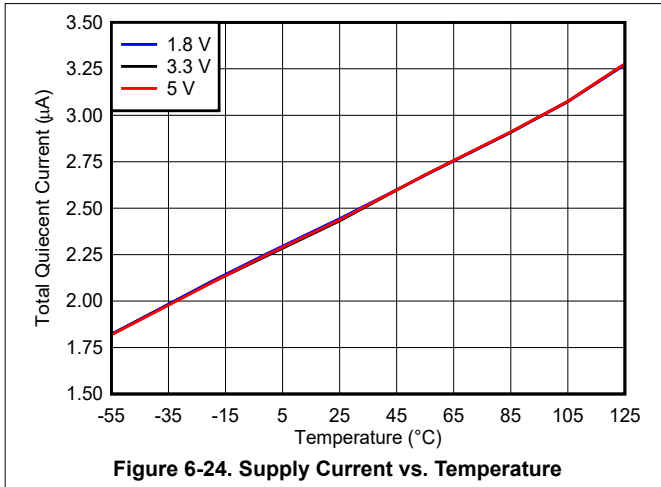

Figure 6-24. Supply Current vs. Temperature

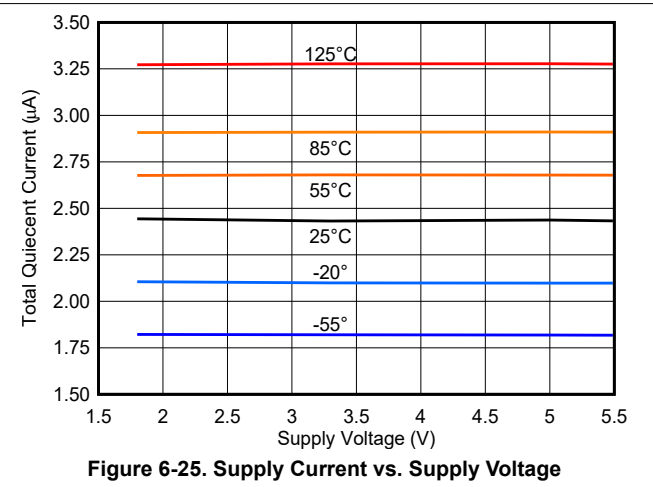

Figure 6-25. Supply Current vs. Supply Voltage

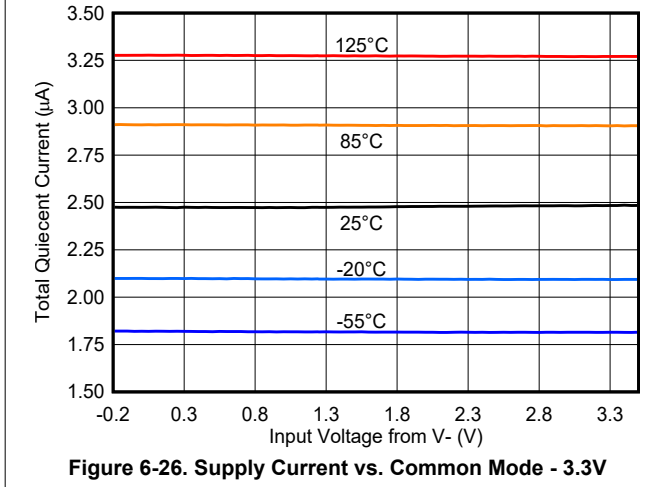

Figure 6-26. Supply Current vs. Common Mode - 3.3V

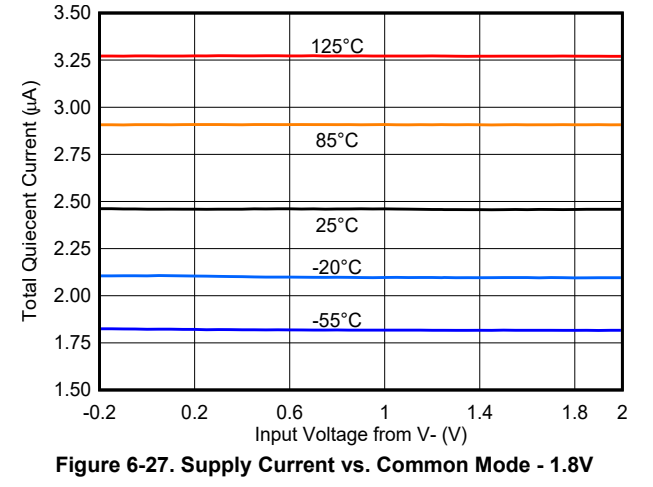

Figure 6-27. Supply Current vs. Common Mode - 1.8V

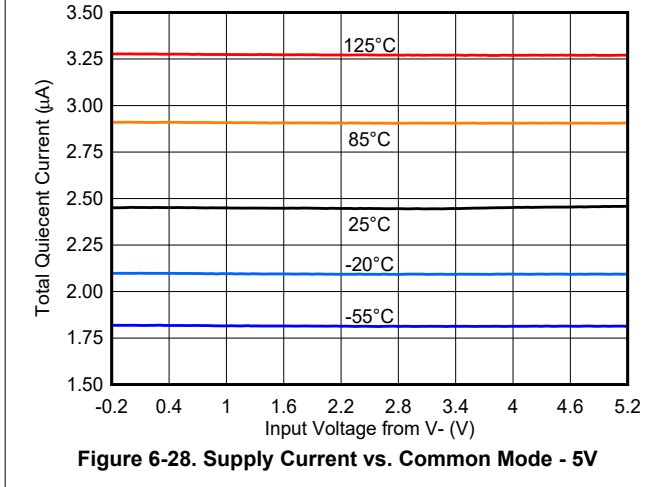

Figure 6-28. Supply Current vs. Common Mode - 5V

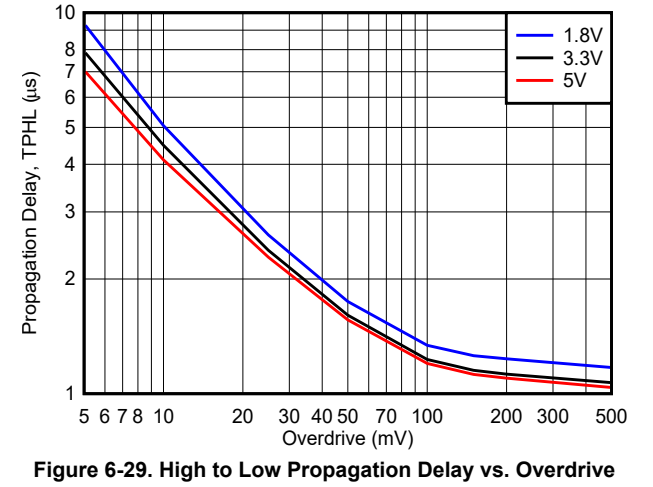

Figure 6-29. High to Low Propagation Delay vs. Overdrive

### 6.11 Typical Characteristics - TLV3012-EP (continued)

For  $V_S$  (Total Supply Voltage) =  $(V+) - (V-) = +5V$ ,  $V_{CM} = V_S / 2$  at  $T_A = 25^\circ C$ ,  $R_{PULLUP} = 1M\Omega$  to  $V+$ ,  $C_L = 15pF$ ,  $V_{OD} = 100mV$  unless otherwise noted.

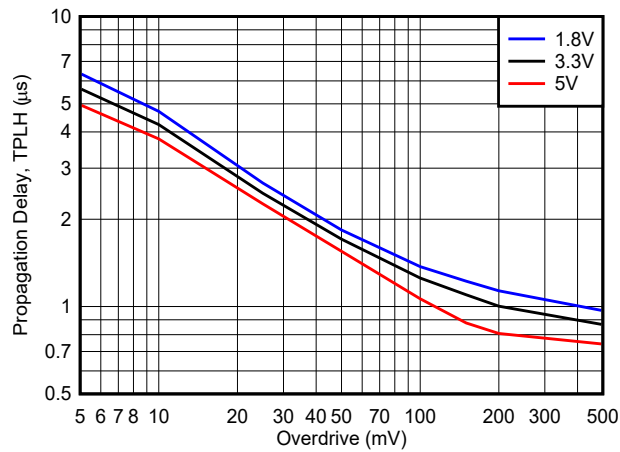

Figure 6-30. Low to High Propagation Delay vs. Overdrive

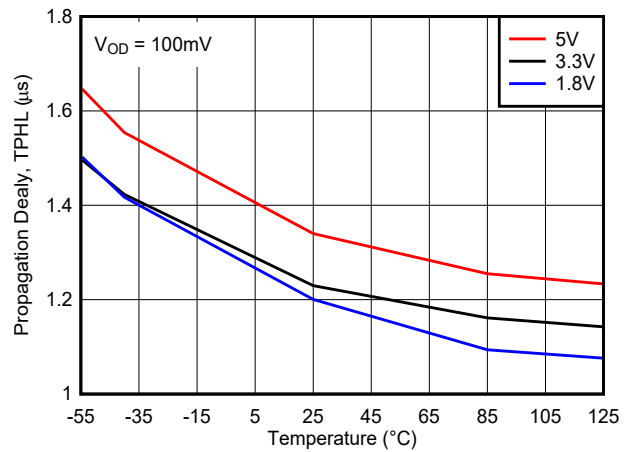

Figure 6-31. High to Low Propagation Delay vs. Temperature

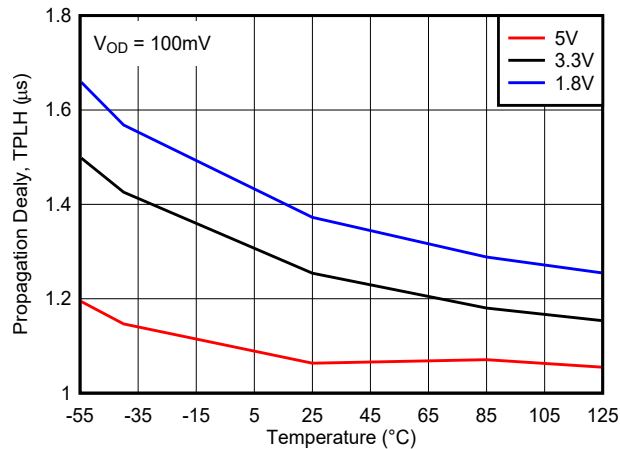

Figure 6-32. Low to High Propagation Delay vs. Temperature

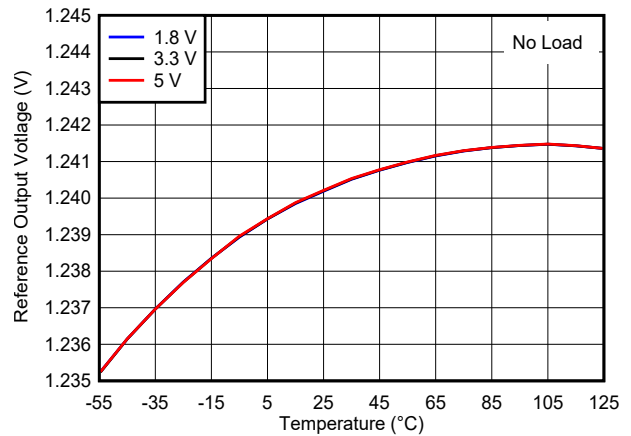

Figure 6-33. Reference Voltage vs. Temperature

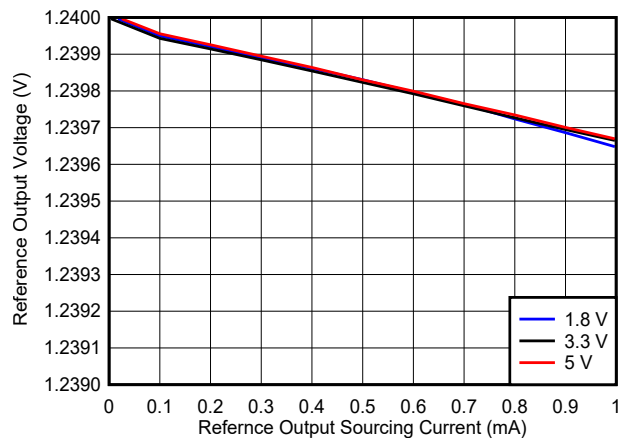

Figure 6-34. Reference Voltage vs. Reference Output Sourcing Current

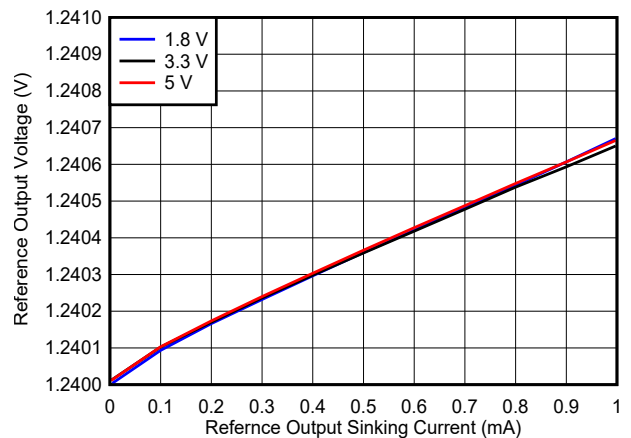
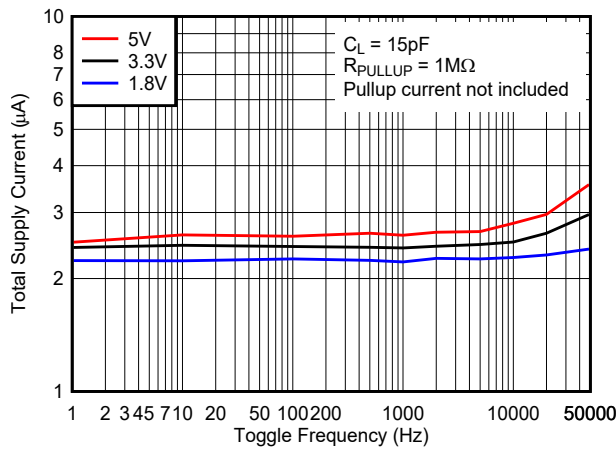

Figure 6-35. Reference Voltage vs. Reference Output Sinking Current

### 6.11 Typical Characteristics - TLV3012-EP (continued)

For  $V_S$  (Total Supply Voltage) =  $(V+) - (V-) = +5V$ ,  $V_{CM} = V_S / 2$  at  $T_A = 25^\circ C$ ,  $R_{PULLUP} = 1M\Omega$  to  $V+$ ,  $C_L = 15pF$ ,  $V_{OD} = 100mV$  unless otherwise noted.



**Figure 6-36. Supply Current vs. Toggle Frequency - Open Drain Output**

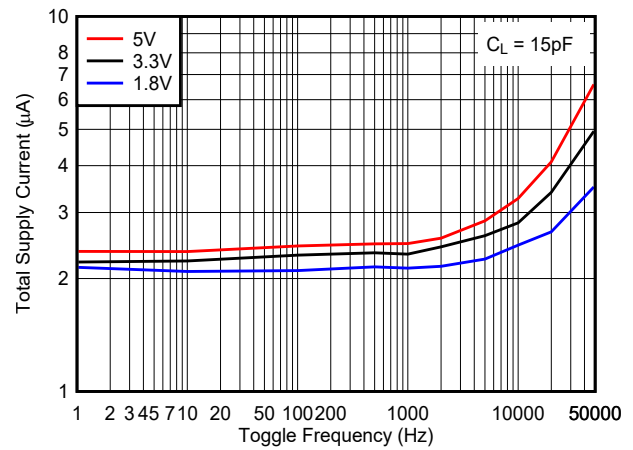

**Figure 6-37. Supply Current vs. Toggle Frequency - Push-Pull Output**

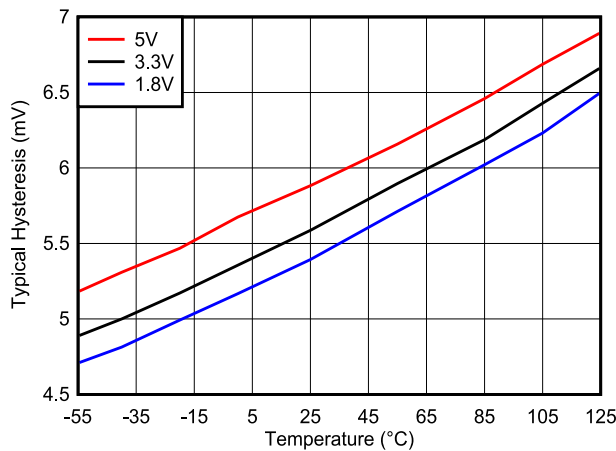

**Figure 6-38. Hysteresis Voltage vs. Temperature**

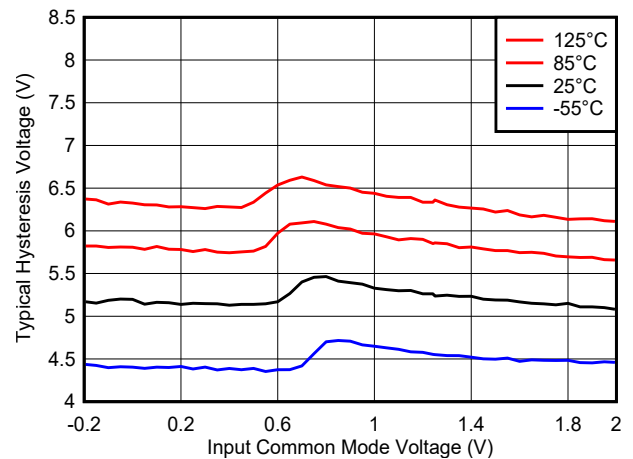

**Figure 6-39. Hysteresis Voltage vs. Common Mode, 1.8V**

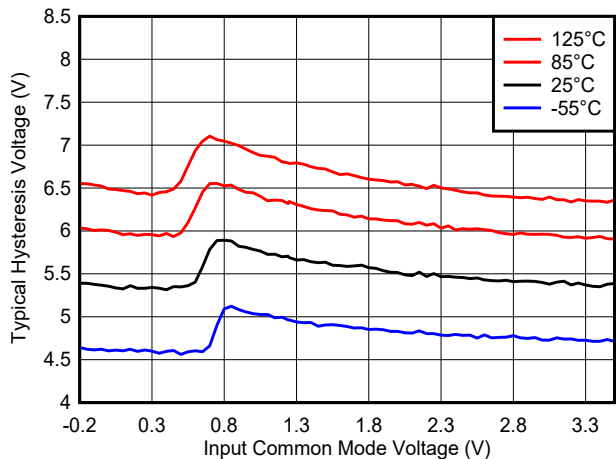

**Figure 6-40. Hysteresis Voltage vs. Common Mode, 3.3V**

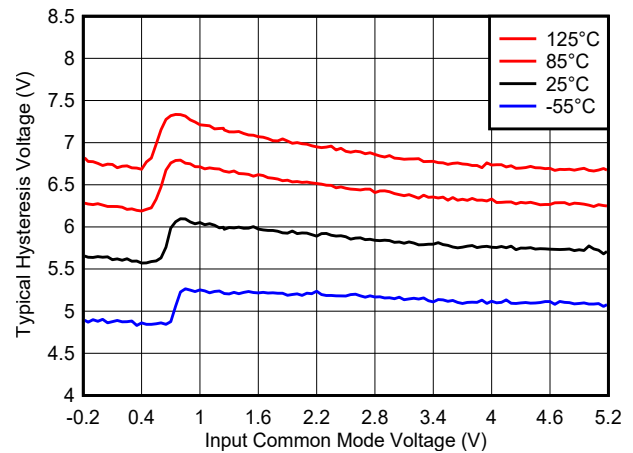

**Figure 6-41. Hysteresis Voltage vs. Common Mode, 5V**

### 6.11 Typical Characteristics - TLV3012-EP (continued)

For  $V_S$  (Total Supply Voltage) =  $(V+) - (V-) = +5V$ ,  $V_{CM} = V_S / 2$  at  $T_A = 25^\circ C$ ,  $R_{PULLUP} = 1M\Omega$  to  $V+$ ,  $C_L = 15pF$ ,  $V_{OD} = 100mV$  unless otherwise noted.

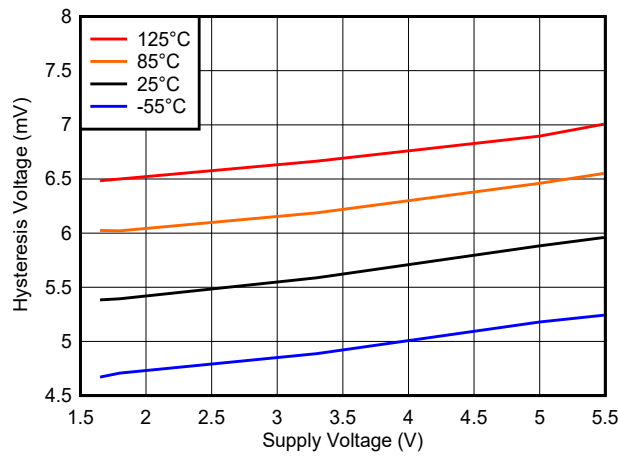

**Figure 6-42. Hysteresis Voltage vs. Supply Voltage**

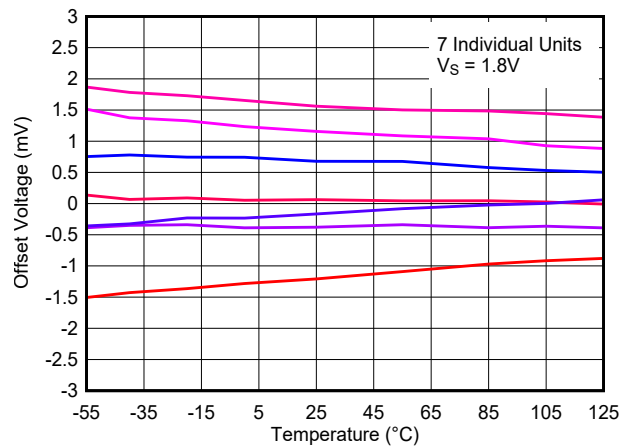

**Figure 6-43. Offset Voltage vs. Temperature, 1.8 V**

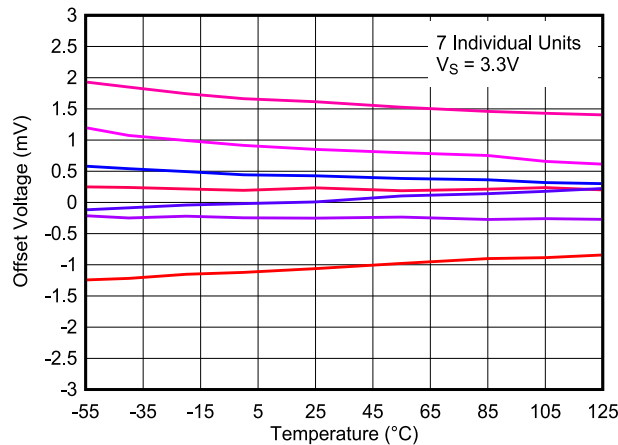

**Figure 6-44. Offset Voltage vs. Temperature, 3.3 V**

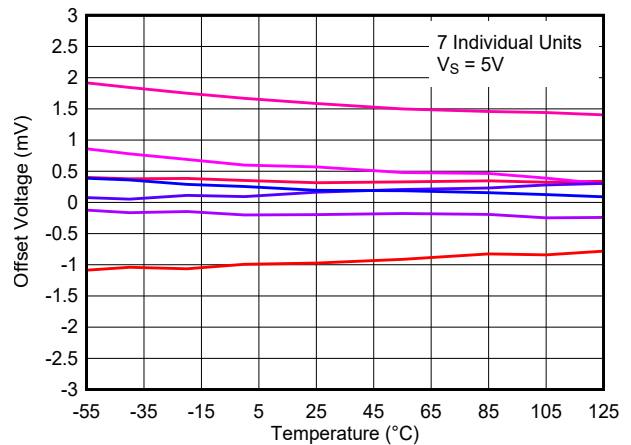

**Figure 6-45. Offset Voltage vs. Temperature, 5 V**

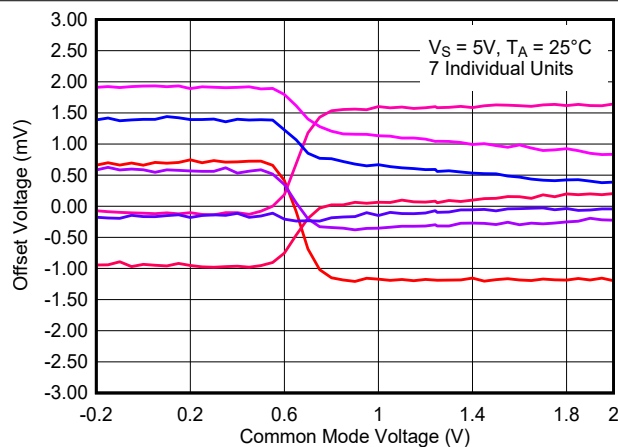

**Figure 6-46. Offset Voltage vs. Common Mode Voltage, 1.8 V**

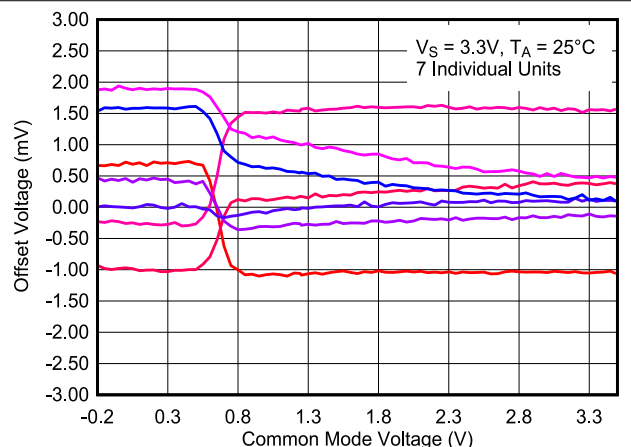
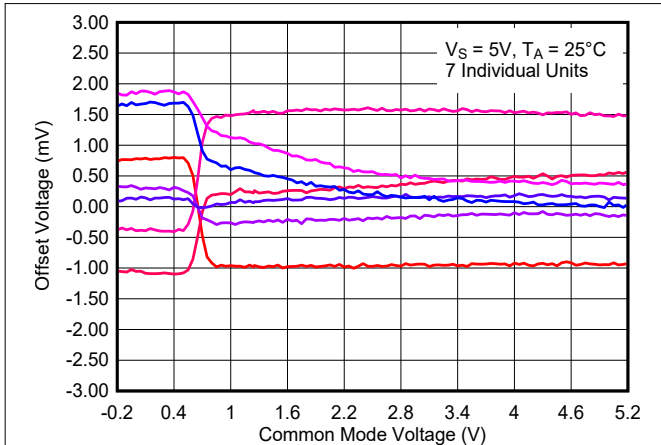

**Figure 6-47. Offset Voltage vs. Common Mode Voltage, 3.3 V**



### 6.11 Typical Characteristics - TLV3012-EP (continued)

For  $V_S$  (Total Supply Voltage) =  $(V+) - (V-) = +5V$ ,  $V_{CM} = V_S / 2$  at  $T_A = 25^\circ C$ ,  $R_{PULLUP} = 1M\Omega$  to  $V+$ ,  $C_L = 15pF$ ,  $V_{OD} = 100mV$  unless otherwise noted.



**Figure 6-48. Offset Voltage vs. Common Mode Voltage, 5 V**

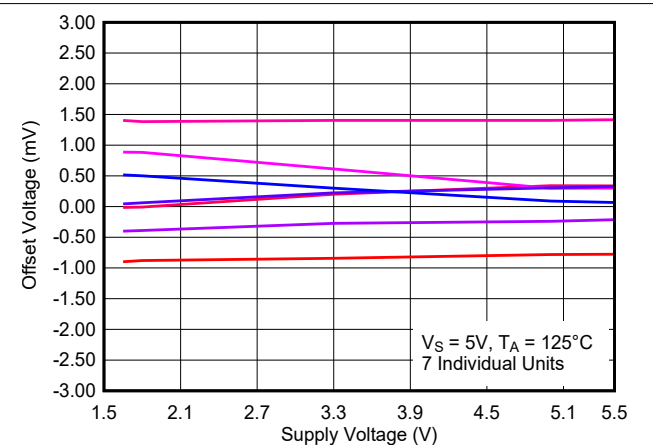

**Figure 6-49. Offset Voltage vs. Supply Voltage, 125°C**

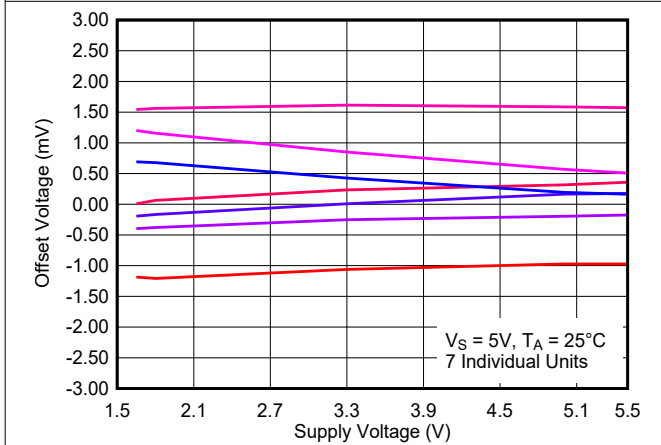

**Figure 6-50. Offset Voltage vs. Supply Voltage, 25°C**

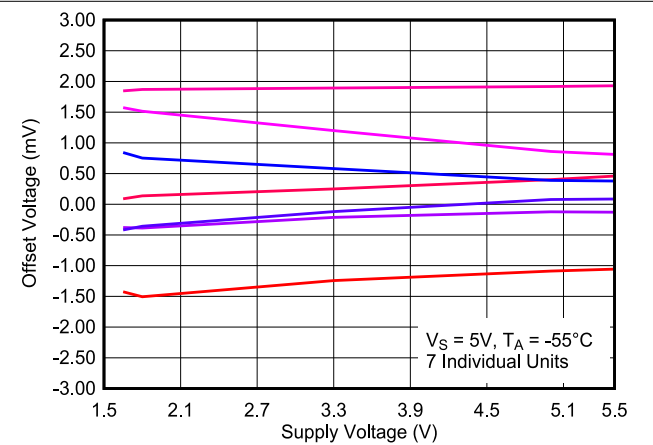

**Figure 6-51. Offset Voltage vs. Supply Voltage, -55°C**

## 7 Detailed Description

### 7.1 Overview

The TLV301x-EP is a MicroPower comparator with an integrated reference that is well suited for compact, low-current, precision voltage detection applications. With a high-accuracy, internal reference of 1.242 V and 5  $\mu$ A of quiescent current, the TLV301x-EP enables power conscious systems to monitor and respond quickly to fault conditions.

### 7.2 Functional Block Diagram

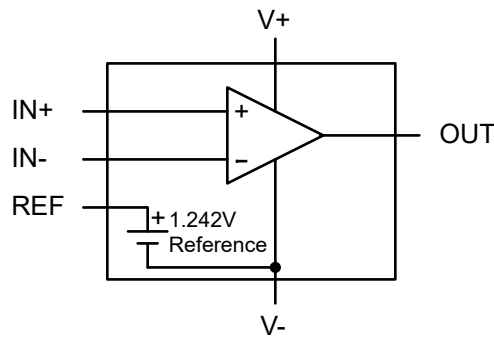

### 7.3 Feature Description

The TLV301x-EP is comprised of a rail-to-rail input comparator with open-drain or push-pull output options and a voltage reference that is externally available.

### 7.4 Device Functional Modes

The TLV3011-EP requires an operating voltage between 1.8 V and 5.5 V for the comparator output to reflect the voltage applied to the inputs. Similarly, the reference output (REF) will also be valid over the same operating voltage range.

#### 7.4.1 Open Drain Output (TLV3011-EP)

The TLV3011-EP features an Open-Drain (sinking only) output that allows multiple devices to be driven by a single pull-up resistor to accomplish an OR function, making the TLV3011-EP useful for logic applications. The value of the pull-up resistor and supply voltage used will affect current consumption due to additional current drawn when the output is in a low state. This effect can be seen in the typical curve Quiescent Current vs Output Switching Frequency.

The pull-up voltage should NOT exceed the V+ supply.

#### 7.4.2 Push Pull Output (TLV3012-EP)

The TLV3012-EP has a "Push-Pull" output capable of both sinking and sourcing current. The push-pull output stage is optimal for reduced power budget applications by eliminating the need for a pull-up resistor and features no shoot-through current.

Do not tie push-pull outputs together.

#### 7.4.3 Voltage Reference

The TLV301x-EP requires an operating voltage between 1.8 V and 5.5 V for the comparator output to reflect the voltage applied to the inputs. Similarly, the reference output (REF) will also be valid over the same operating voltage range.

The integrated 1.242-V voltage reference offers low 100-ppm/ $^{\circ}$ C (maximum) drift provided on a separate output pin that allows use of external dividers or to provide a reference voltage for other external circuitry. The reference is stable with up to a 10-nF capacitive load and can sink or source up to 500 $\mu$ A (typical) of output current.

#### 7.4.4 Fail-Safe Input (TLV3012-EP Only)

This section does **NOT** apply to the open drain output TLV3011-EP.

The TLV3012-EP inputs are Fail-Safe up to 5.5V independent of V+ voltage. Fail-Safe is defined as maintaining the same high input impedance when V+ is unpowered or within the recommended operating ranges.

The Fail-Safe inputs can be any value between 0 V and 5.5 V, even while V+ is zero or ramping up or down. This feature avoids power sequencing issues as long as the input voltage range and supply voltage are within the specified ranges.

This is possible since the inputs are not clamped to V+ and the input current maintains its value even when a higher voltage is applied to the inputs.

As long as one of the input pins remains within the valid input range, and the supply voltage is valid and not in POR, the output state will be correct. The specified input voltage range is -0.2 V to (V+) + 0.2 V.

The following is a summary of the TLV3012-EP device input voltage excursions and their outcomes:

1. When both IN- and IN+ are within the specified input voltage range:
  - a. If IN- is higher than IN+ and the offset voltage, the output is low.
  - b. If IN- is lower than IN+ and the offset voltage, the output is high.
2. When IN- is higher than the specified input voltage range and IN+ is within the specified voltage range, the output is low.
3. When IN+ is higher than the specified input voltage range and IN- is within the specified input voltage range, the output is high
4. When IN- and IN+ are both outside the specified input voltage range, the output state is **indeterminate** (random). *Do not* operate in this region.

Because the inputs do not have upper ESD diode clamps to V+, input voltages must be externally clamped to below 5.5 V if the source could possibly exceed 5.5 V. A current limiting resistor in series with the input is also recommend in case of input transients.

#### 7.4.5 Power-On Reset (POR) (TLV3012-EP Only)

This section does **NOT** apply to the open-drain output TLV3011-EP.

The TLV3012-EP has an internal Power-on-Reset (POR) circuit for known start-up or power-down conditions. While the power supply (V+) is ramping up or ramping down, the POR circuitry will be activated for up to 1.9ms after the minimum supply voltage threshold is crossed, or immediately when the supply voltage drops below minimum supply. When the supply voltage is equal to or greater than the minimum supply voltage, and after the delay period, the comparator output reflects the state of the differential input (V<sub>ID</sub>). This delay is long enough to allow the reference output to stabilize with up to a 10nF capacitive load.

During the POR period (t<sub>on</sub>), the outputs will be low (sinking)

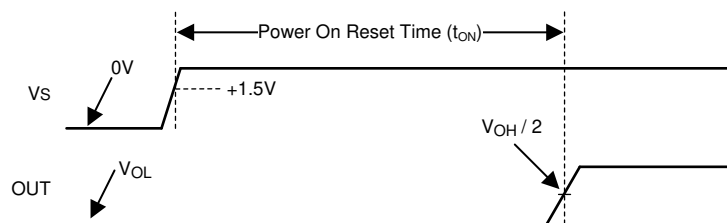

**Figure 7-1. Power-On Reset Example Timing Diagram for TLV3012-EP**

## 8 Application and Implementation

### Note

Information in the following applications sections is not part of the TI component specification, and TI does not warrant its accuracy or completeness. TI's customers are responsible for determining suitability of components for their purposes, as well as validating and testing their design implementation to confirm system functionality.

### 8.1 Application Information

The TLV301x-EP comparator family with on-chip 1.242-V series reference with the choice of either open-drain or push-pull output stages.

A typical supply current of 2.8  $\mu\text{A}$  and small packaging combine with 1.8-V supply requirements to make the TLV301x-EP devices optimal for battery and portable designs.

Figure 8-1 shows the typical connections for the TLV301x-EP device.

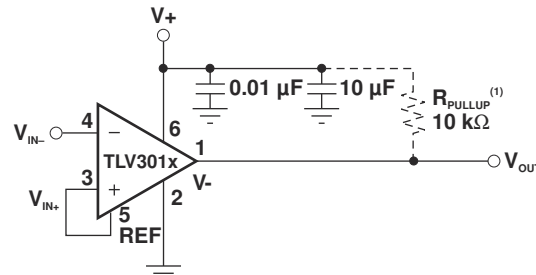

(1) Use  $R_{\text{PULLUP}}$  with the TLV3011 only.

Figure 8-1. Basic Connections of the TLV301x-EP

#### 8.1.1 External Hysteresis

Comparator inputs have no noise immunity within the range of specified offset voltage ( $\pm 12$  mV). For noisy input signals, the comparator output may display multiple switching as input signals move through the switching threshold. The typical comparator threshold of the TLV301x-EP is  $\pm 0.5$  mV. To prevent multiple switching within the comparison threshold of the comparator, external hysteresis may be added by connecting a small amount of feedback to the positive input. Figure 8-2 shows a typical topology used to introduce hysteresis, described by this equation:

$$V_{\text{HYST}} = \frac{V_+ \times R_1}{R_1 + R_2}$$

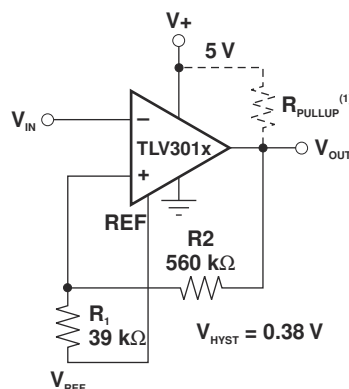

(1) Use  $R_{\text{PULLUP}}$  with the TLV3011 only.

Figure 8-2. Adding Hysteresis

$V_{HYST}$  sets the value of the transition voltage required to switch the comparator output by increasing the threshold region, thereby reducing sensitivity to noise.

## 8.2 Typical Application

### 8.2.1 Under Voltage Detection

Under-voltage detection is frequently required to alert the system that a battery voltage has dropped below the usable voltage level. Figure 8-3 shows a simple under-voltage detection circuit using the TLV3012-EP which is configured as a non-inverting comparator with the integrated 1.242 V reference is externally connected to the inverting input pin (IN-).

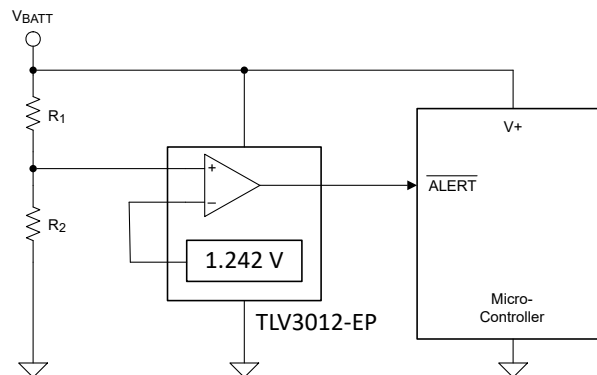

**Figure 8-3. Under-Voltage Detection**

#### 8.2.1.1 Design Requirements

For this design, follow these design requirements:

- Operate from power supply that powers the microcontroller.
- Under-voltage alert is active low.
- Logic low output when  $V_{BAT}$  is less than 2.0V.

#### 8.2.1.2 Detailed Design Procedure

Configure the circuit as shown in Figure 8-3. Connect (V+) to  $V_{BAT}$  which also powers the microcontroller. Resistors  $R_1$  and  $R_2$  create the under-voltage alert level of 2.0 V. When the battery voltage sags down to 2.0 V, the resistor divider voltage crosses  $V_{REF}$ , the 1.242 V reference threshold of the TLV3012-EP. This causes the comparator output to transition from a logic high to a logic low. The push-pull output of the TLV3012-EP is selected since the comparator operating voltage is shared with the microcontroller which is receiving the under-voltage alert signal.

Equation 1 is derived from the analysis of Figure 8-3.

$$V_{REF} = \frac{R_2}{R_1 + R_2} \times V_{BAT} \quad (1)$$

where

- $R_1$  and  $R_2$  are the resistor values for the resistor divider connected to IN+
- $V_{BAT}$  is the voltage source that is being monitored for an undervoltage condition.
- $V_{REF}$  is the falling edge threshold where the comparator output changes state from high to low

Rearranging Equation 1 and solving for  $R_1$  yields Equation 2.

$$R_1 = \frac{(V_{BAT} - V_{REF})}{V_{REF}} \times R_2 \tag{2}$$

For the specific undervoltage detection of 2.0 V using the TLV3012-Q1, the following results are calculated.

$$R_1 = \frac{(2.0 - 1.242)}{1.242} \times 1M = 610 \text{ k}\Omega \tag{3}$$

where:

- $R_2$  is set to 1 M $\Omega$
- $V_{BAT}$  is set to 2.0 V
- $V_{REF}$  is set to 1.242 V

Choose  $R_{TOTAL}$  ( $R_1 + R_2$ ) such that the current through the divider is at least 100 times higher than the input bias current ( $I_{BIAS}$ ). The resistors can have high values to minimize current consumption in the circuit without adding significant error to the resistive divider.

### 8.2.1.3 Application Performance Plots

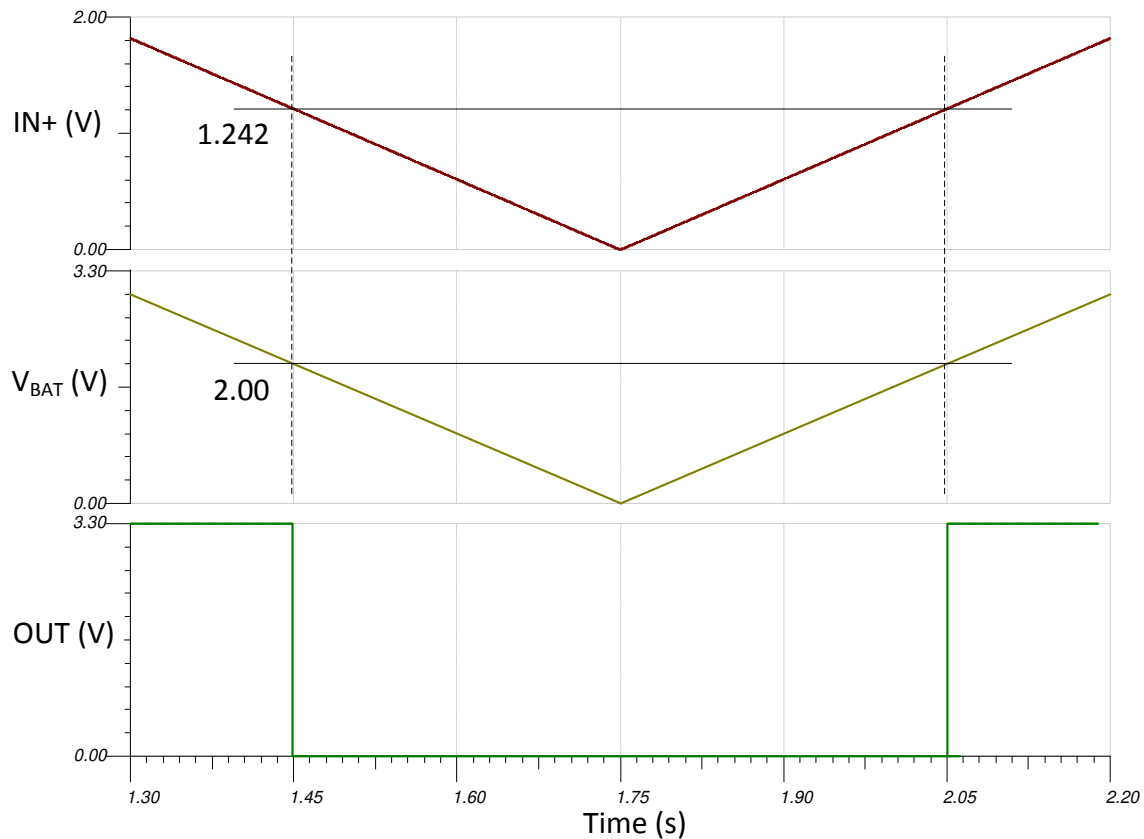

Figure 8-4.

### 8.3 Power Supply Recommendations

The TLV3012x-EP has a recommended operating voltage range ( $V_S$ ) of 1.8 V to 5.5 V.  $V_S$  is defined as  $(V+) - (V-)$ .

Therefore, the supply voltages used to create  $V_S$  can be single-ended or bipolar. For example, single-ended supply voltages of 5 V and 0 V and bipolar supply voltages of +2.5 V and –2.5 V create comparable operating voltages for  $V_S$ .

However, when bipolar supply voltages are used, it is important to realize that the reference (REF) and logic low level of the comparator output is referenced to  $(V-)$ . Output capacitive loading and output toggle rate will cause the average supply current to rise over the quiescent current in the EC Table.

### 8.4 Layout

#### 8.4.1 Layout Guidelines

To minimize supply noise, power supplies should be capacitively decoupled by a 0.1- $\mu$ F ceramic capacitor. Comparators are sensitive to input noise and precautions such as proper grounding (use of ground plane), supply bypassing, and guarding of high-impedance nodes minimize the effects of noise and help to ensure specified performance.

#### 8.4.2 Layout Example

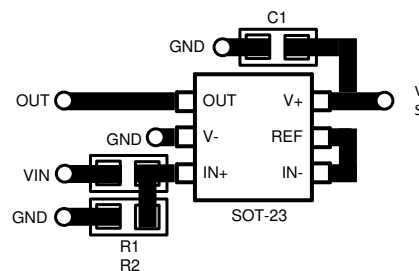

**Figure 8-5. Layout Example**

## 9 Device and Documentation Support

TI offers an extensive line of development tools. Tools and software to evaluate the performance of the device, generate code, and develop solutions are listed below.

### 9.1 Receiving Notification of Documentation Updates

To receive notification of documentation updates, navigate to the device product folder on [ti.com](http://ti.com). Click on *Subscribe to updates* to register and receive a weekly digest of any product information that has changed. For change details, review the revision history included in any revised document.

### 9.2 Support Resources

[TI E2E™ support forums](#) are an engineer's go-to source for fast, verified answers and design help — straight from the experts. Search existing answers or ask your own question to get the quick design help you need.

Linked content is provided "AS IS" by the respective contributors. They do not constitute TI specifications and do not necessarily reflect TI's views; see TI's [Terms of Use](#).

### 9.3 Trademarks

TI E2E™ is a trademark of Texas Instruments.

All trademarks are the property of their respective owners.

### 9.4 Electrostatic Discharge Caution



This integrated circuit can be damaged by ESD. Texas Instruments recommends that all integrated circuits be handled with appropriate precautions. Failure to observe proper handling and installation procedures can cause damage.

ESD damage can range from subtle performance degradation to complete device failure. Precision integrated circuits may be more susceptible to damage because very small parametric changes could cause the device not to meet its published specifications.

### 9.5 Glossary

[TI Glossary](#) This glossary lists and explains terms, acronyms, and definitions.



## 10 Mechanical, Packaging, and Orderable Information

The following pages include mechanical, packaging, and orderable information. This information is the most current data available for the designated devices. This data is subject to change without notice and revision of this document. For browser-based versions of this data sheet, refer to the left-hand navigation.

**PACKAGING INFORMATION**

Orderable Device	Status (1)	Package Type	Package Drawing	Pins	Package Qty	Eco Plan (2)	Lead finish/ Ball material (6)	MSL Peak Temp (3)	Op Temp (°C)	Device Marking (4/5)	Samples
TLV3011AMDBVREP	ACTIVE	SOT-23	DBV	6	3000	RoHS & Green	NIPDAU	Level-1-260C-UNLIM	-55 to 125	BTV	<a href="#">Samples</a>
TLV3012AMDBVREP	ACTIVE	SOT-23	DBV	6	3000	RoHS & Green	NIPDAU	Level-1-260C-UNLIM	-55 to 125	2QDF	<a href="#">Samples</a>
V62/07604-01XE	ACTIVE	SOT-23	DBV	6	3000	RoHS & Green	NIPDAU	Level-1-260C-UNLIM	-55 to 125	BTV	<a href="#">Samples</a>
V62/23603-01XE	ACTIVE	SOT-23	DBV	6	3000	RoHS & Green	NIPDAU	Level-1-260C-UNLIM	-55 to 125	2QDF	<a href="#">Samples</a>

(1) The marketing status values are defined as follows:

**ACTIVE:** Product device recommended for new designs.

**LIFEBUY:** TI has announced that the device will be discontinued, and a lifetime-buy period is in effect.

**NRND:** Not recommended for new designs. Device is in production to support existing customers, but TI does not recommend using this part in a new design.

**PREVIEW:** Device has been announced but is not in production. Samples may or may not be available.

**OBSELETE:** TI has discontinued the production of the device.

(2) **RoHS:** TI defines "RoHS" to mean semiconductor products that are compliant with the current EU RoHS requirements for all 10 RoHS substances, including the requirement that RoHS substance do not exceed 0.1% by weight in homogeneous materials. Where designed to be soldered at high temperatures, "RoHS" products are suitable for use in specified lead-free processes. TI may reference these types of products as "Pb-Free".

**RoHS Exempt:** TI defines "RoHS Exempt" to mean products that contain lead but are compliant with EU RoHS pursuant to a specific EU RoHS exemption.

**Green:** TI defines "Green" to mean the content of Chlorine (Cl) and Bromine (Br) based flame retardants meet JS709B low halogen requirements of <=1000ppm threshold. Antimony trioxide based flame retardants must also meet the <=1000ppm threshold requirement.

(3) MSL, Peak Temp. - The Moisture Sensitivity Level rating according to the JEDEC industry standard classifications, and peak solder temperature.

(4) There may be additional marking, which relates to the logo, the lot trace code information, or the environmental category on the device.

(5) Multiple Device Markings will be inside parentheses. Only one Device Marking contained in parentheses and separated by a "-" will appear on a device. If a line is indented then it is a continuation of the previous line and the two combined represent the entire Device Marking for that device.

(6) Lead finish/Ball material - Orderable Devices may have multiple material finish options. Finish options are separated by a vertical ruled line. Lead finish/Ball material values may wrap to two lines if the finish value exceeds the maximum column width.

**Important Information and Disclaimer:**The information provided on this page represents TI's knowledge and belief as of the date that it is provided. TI bases its knowledge and belief on information provided by third parties, and makes no representation or warranty as to the accuracy of such information. Efforts are underway to better integrate information from third parties. TI has taken and

continues to take reasonable steps to provide representative and accurate information but may not have conducted destructive testing or chemical analysis on incoming materials and chemicals. TI and TI suppliers consider certain information to be proprietary, and thus CAS numbers and other limited information may not be available for release.

In no event shall TI's liability arising out of such information exceed the total purchase price of the TI part(s) at issue in this document sold by TI to Customer on an annual basis.

**OTHER QUALIFIED VERSIONS OF TLV3011-EP, TLV3012-EP :**

- Catalog : [TLV3011](#), [TLV3012](#)
- Automotive : [TLV3011-Q1](#), [TLV3012-Q1](#)

NOTE: Qualified Version Definitions:

- Catalog - TI's standard catalog product
- Automotive - Q100 devices qualified for high-reliability automotive applications targeting zero defects

**TAPE AND REEL INFORMATION**

**QUADRANT ASSIGNMENTS FOR PIN 1 ORIENTATION IN TAPE**

\*All dimensions are nominal

Device	Package Type	Package Drawing	Pins	SPQ	Reel Diameter (mm)	Reel Width W1 (mm)	A0 (mm)	B0 (mm)	K0 (mm)	P1 (mm)	W (mm)	Pin1 Quadrant
TLV3011AMDBVREP	SOT-23	DBV	6	3000	179.0	8.4	3.2	3.2	1.4	4.0	8.0	Q3
TLV3011AMDBVREP	SOT-23	DBV	6	3000	180.0	8.4	3.2	3.2	1.4	4.0	8.0	Q3
TLV3012AMDBVREP	SOT-23	DBV	6	3000	180.0	8.4	3.2	3.2	1.4	4.0	8.0	Q3

**TAPE AND REEL BOX DIMENSIONS**

\*All dimensions are nominal

Device	Package Type	Package Drawing	Pins	SPQ	Length (mm)	Width (mm)	Height (mm)
TLV3011AMDBVREP	SOT-23	DBV	6	3000	200.0	183.0	25.0
TLV3011AMDBVREP	SOT-23	DBV	6	3000	210.0	185.0	35.0
TLV3012AMDBVREP	SOT-23	DBV	6	3000	210.0	185.0	35.0



# DBV0006A

# PACKAGE OUTLINE

SOT-23 - 1.45 mm max height

SMALL OUTLINE TRANSISTOR



4214840/G 08/2024

## NOTES:

1. All linear dimensions are in millimeters. Any dimensions in parenthesis are for reference only. Dimensioning and tolerancing per ASME Y14.5M.
2. This drawing is subject to change without notice.
3. Body dimensions do not include mold flash or protrusion. Mold flash and protrusion shall not exceed 0.25 per side.
4. Leads 1,2,3 may be wider than leads 4,5,6 for package orientation.
5. Reference JEDEC MO-178.

# EXAMPLE BOARD LAYOUT

DBV0006A

SOT-23 - 1.45 mm max height

SMALL OUTLINE TRANSISTOR



LAND PATTERN EXAMPLE  
EXPOSED METAL SHOWN  
SCALE:15X



SOLDER MASK DETAILS

4214840/G 08/2024

NOTES: (continued)

- 6. Publication IPC-7351 may have alternate designs.
- 7. Solder mask tolerances between and around signal pads can vary based on board fabrication site.

# EXAMPLE STENCIL DESIGN

DBV0006A

SOT-23 - 1.45 mm max height

SMALL OUTLINE TRANSISTOR



SOLDER PASTE EXAMPLE  
BASED ON 0.125 mm THICK STENCIL  
SCALE:15X

4214840/G 08/2024

NOTES: (continued)

8. Laser cutting apertures with trapezoidal walls and rounded corners may offer better paste release. IPC-7525 may have alternate design recommendations.
9. Board assembly site may have different recommendations for stencil design.



# DCK0006A



# PACKAGE OUTLINE

SOT - 1.1 max height

SMALL OUTLINE TRANSISTOR

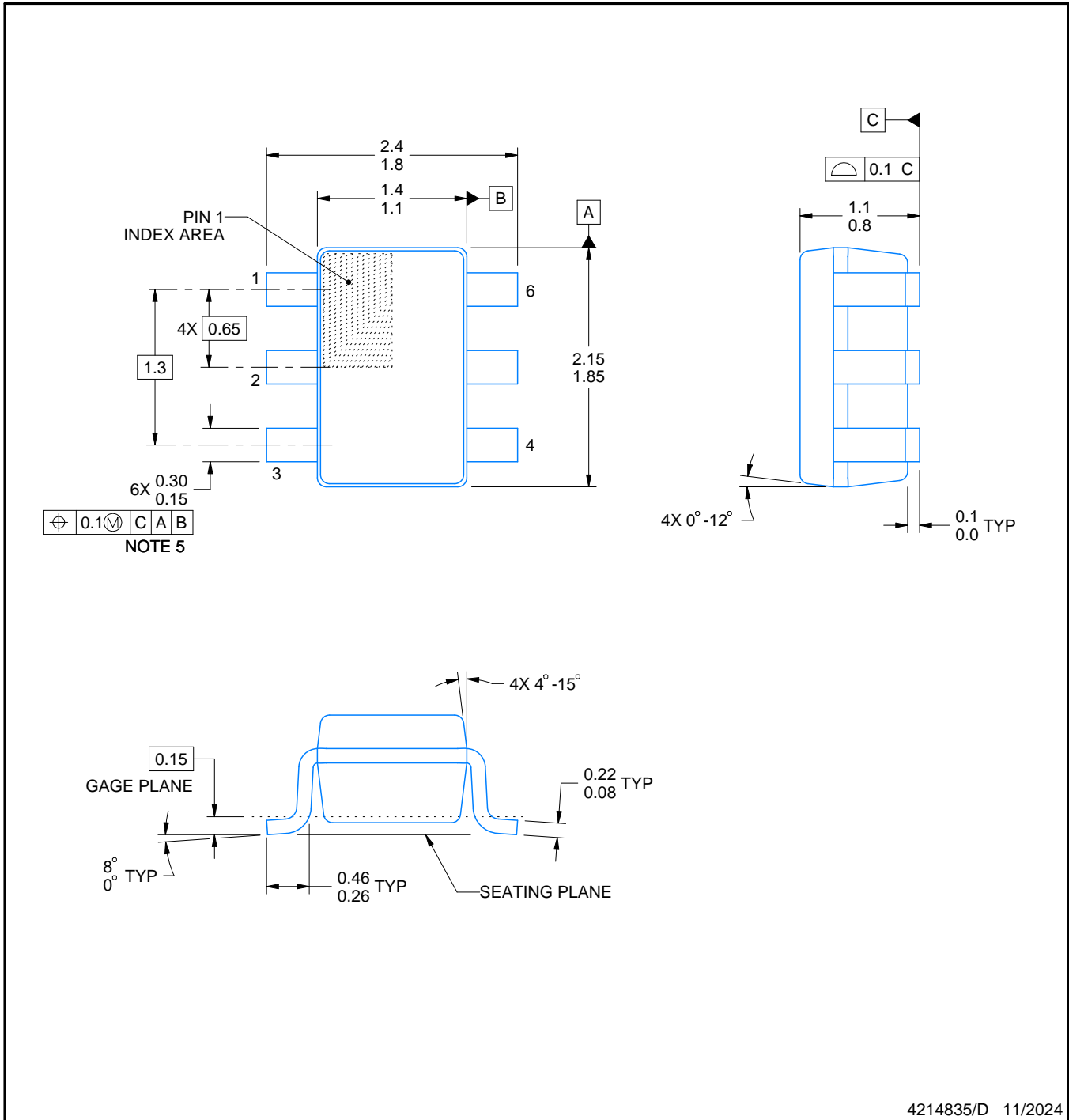

4214835/D 11/2024

**NOTES:**

1. All linear dimensions are in millimeters. Any dimensions in parenthesis are for reference only. Dimensioning and tolerancing per ASME Y14.5M.
2. This drawing is subject to change without notice.
3. Body dimensions do not include mold flash or protrusion. Mold flash and protrusion shall not exceed 0.15 per side.
4. Falls within JEDEC MO-203 variation AB.

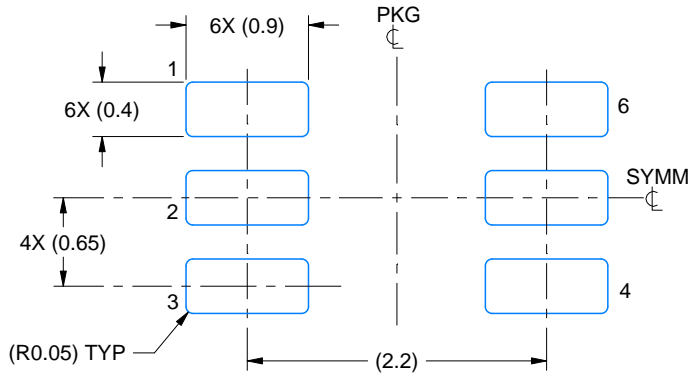

LAND PATTERN EXAMPLE  
EXPOSED METAL SHOWN  
SCALE:18X

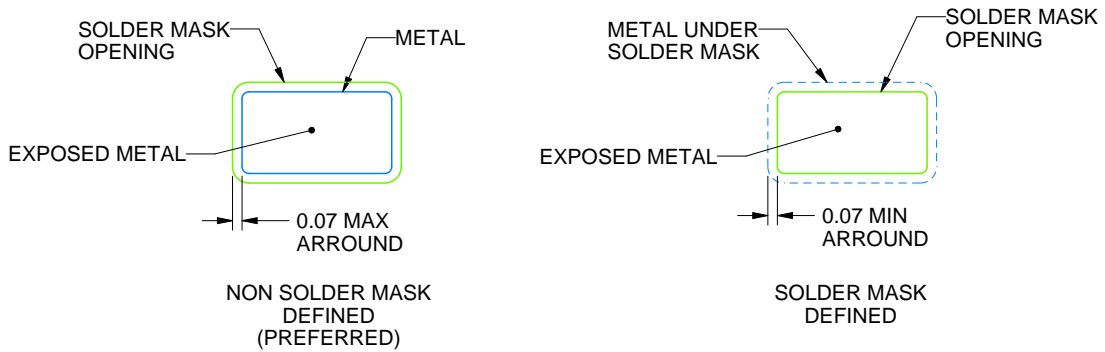

SOLDER MASK DETAILS

4214835/D 11/2024

NOTES: (continued)

5. Publication IPC-7351 may have alternate designs.
6. Solder mask tolerances between and around signal pads can vary based on board fabrication site.



SOLDER PASTE EXAMPLE  
 BASED ON 0.125 THICK STENCIL  
 SCALE:18X

4214835/D 11/2024

NOTES: (continued)

7. Laser cutting apertures with trapezoidal walls and rounded corners may offer better paste release. IPC-7525 may have alternate design recommendations.
8. Board assembly site may have different recommendations for stencil design.

## IMPORTANT NOTICE AND DISCLAIMER

TI PROVIDES TECHNICAL AND RELIABILITY DATA (INCLUDING DATA SHEETS), DESIGN RESOURCES (INCLUDING REFERENCE DESIGNS), APPLICATION OR OTHER DESIGN ADVICE, WEB TOOLS, SAFETY INFORMATION, AND OTHER RESOURCES "AS IS" AND WITH ALL FAULTS, AND DISCLAIMS ALL WARRANTIES, EXPRESS AND IMPLIED, INCLUDING WITHOUT LIMITATION ANY IMPLIED WARRANTIES OF MERCHANTABILITY, FITNESS FOR A PARTICULAR PURPOSE OR NON-INFRINGEMENT OF THIRD PARTY INTELLECTUAL PROPERTY RIGHTS.

These resources are intended for skilled developers designing with TI products. You are solely responsible for (1) selecting the appropriate TI products for your application, (2) designing, validating and testing your application, and (3) ensuring your application meets applicable standards, and any other safety, security, regulatory or other requirements.

These resources are subject to change without notice. TI grants you permission to use these resources only for development of an application that uses the TI products described in the resource. Other reproduction and display of these resources is prohibited. No license is granted to any other TI intellectual property right or to any third party intellectual property right. TI disclaims responsibility for, and you will fully indemnify TI and its representatives against, any claims, damages, costs, losses, and liabilities arising out of your use of these resources.

TI's products are provided subject to [TI's Terms of Sale](#) or other applicable terms available either on [ti.com](https://www.ti.com) or provided in conjunction with such TI products. TI's provision of these resources does not expand or otherwise alter TI's applicable warranties or warranty disclaimers for TI products.

TI objects to and rejects any additional or different terms you may have proposed.

Mailing Address: Texas Instruments, Post Office Box 655303, Dallas, Texas 75265  
Copyright © 2025, Texas Instruments Incorporated