

## TLV521 NanoPower, 350nA, RRIO, CMOS Input, Operational Amplifier

### 1 Features

- Unmatched Price Performance
- For  $V_S = 3.3\text{ V}$ , Typical Unless Otherwise Noted
  - Ultra-low Supply Current
    - 350 nA Typical, 500 nA Maximum
  - Wide Operating Voltage Range 1.7 V to 5.5 V
  - Low  $TCV_{OS}$  1.5  $\mu\text{V}/^\circ\text{C}$
  - $V_{OS}$  3 mV (Max)
  - Input Bias Current 1 pA
  - PSRR 100 dB
  - CMRR 90 dB
  - Open-Loop Gain 110 dB
  - Gain Bandwidth Product 6 kHz
  - Slew Rate 2.5 V/ms
  - Input Voltage Noise at  $f = 100\text{ Hz}$  300  $\text{nV}/\sqrt{\text{Hz}}$
  - Temperature Range  $-40^\circ\text{C}$  to  $125^\circ\text{C}$
  - Rail to Rail Input and Output (RRIO)

### 2 Applications

- Wireless Remote Sensors
- Powerline Monitoring
- Power Meters
- Battery Powered Industrial Sensors
- Micropower Oxygen Sensor and Toxic Gas Sensor
- Active RFID Readers
- Zigbee Based Sensors for HVAC Control
- Sensor Network Powered by Energy Scavenging
- Current Sensing
- Glucose Monitoring

### 3 Description

The TLV521 350 nA nanopower op amp offers optimum price performance in TI's nanopower family of operational amplifiers. The TLV521 has a carefully designed CMOS input stage enabling very low  $I_{BIAS}$  and  $I_{OS}$  errors that would otherwise impact sensitive applications like Megaohm resistance, high-impedance photodiode and charge sense situations. Additionally, built-in EMI protection reduces sensitivity to unwanted RF signals from sources like mobile phones and RFID readers.

The TLV521 is offered in the 5-pin SC70 package, and operates from  $-40^\circ\text{C}$  to  $125^\circ\text{C}$ .

#### Device Information<sup>(1)</sup>

PART NUMBER	PACKAGE	BODY SIZE (NOM)
TLV521	SC70 (5)	2.00 mm x 1.25 mm

(1) For all available packages, see the orderable addendum at the end of the data sheet.

#### Nanopower Supply Current

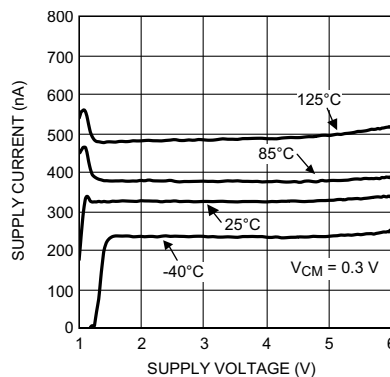

## Table of Contents

<b>1 Features</b> .....	<b>1</b>	7.4 Device Functional Modes.....	<b>11</b>
<b>2 Applications</b> .....	<b>1</b>	<b>8 Applications and Implementation</b> .....	<b>12</b>
<b>3 Description</b> .....	<b>1</b>	8.1 Application Information.....	<b>12</b>
<b>4 Revision History</b> .....	<b>2</b>	8.2 Typical Applications .....	<b>13</b>
<b>5 Pin Configuration and Functions</b> .....	<b>2</b>	<b>9 Power Supply Recommendations</b> .....	<b>17</b>
<b>6 Specifications</b> .....	<b>3</b>	<b>10 Layout</b> .....	<b>18</b>
6.1 Absolute Maximum Ratings .....	<b>3</b>	10.1 Layout Guidelines .....	<b>18</b>
6.2 ESD Ratings.....	<b>3</b>	10.2 Layout Example .....	<b>18</b>
6.3 Recommended Operating Conditions.....	<b>3</b>	<b>11 Device and Documentation Support</b> .....	<b>19</b>
6.4 Thermal Information .....	<b>3</b>	11.1 Device Support .....	<b>19</b>
6.5 Electrical Characteristics.....	<b>4</b>	11.2 Documentation Support .....	<b>19</b>
6.6 AC Electrical Characteristics.....	<b>5</b>	11.3 Community Resources.....	<b>19</b>
6.7 Typical Characteristics.....	<b>6</b>	11.4 Trademarks .....	<b>19</b>
<b>7 Detailed Description</b> .....	<b>11</b>	11.5 Electrostatic Discharge Caution.....	<b>19</b>
7.1 Overview .....	<b>11</b>	11.6 Glossary .....	<b>19</b>
7.2 Functional Block Diagram .....	<b>11</b>	<b>12 Mechanical, Packaging, and Orderable Information</b> .....	<b>20</b>
7.3 Feature Description.....	<b>11</b>		

## 4 Revision History

DATE	REVISION	NOTES
May 2016	*	Initial release.

## 5 Pin Configuration and Functions

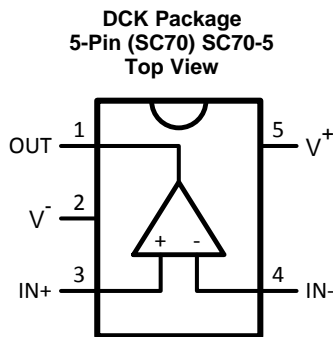

**Pin Functions**

PIN		TYPE	DESCRIPTION
NO.	NAME		
1	OUT	O	Output
2	V-	P	Negative Power Supply
3	IN+	I	Noninverting Input
4	IN-	I	Inverting Input
5	V+	P	Positive Power Supply

## 6 Specifications

### 6.1 Absolute Maximum Ratings<sup>(1)</sup>

over operating free-air temperature range (unless otherwise noted)<sup>(1)</sup>

		MIN	MAX	UNIT
Any pin relative to $V^-$		-0.3	6	V
IN+, IN-, OUT Pins		$V^- - 0.3\text{ V}$	$V^+ + 0.3\text{ V}$	V
$V^+$ , $V^-$ , OUT Pins			40	mA
Differential Input Voltage ( $V_{IN+} - V_{IN-}$ )		-300	300	mV
Junction Temperature		-40	150	°C
Mounting Temperature	Infrared or Convection (30 sec.)		260	°C
	Wave Soldering Lead Temp. (4 sec.)		260	°C
Storage temperature, $T_{stg}$		-65	150	°C

- (1) Stresses beyond those listed under *Absolute Maximum Ratings* may cause permanent damage to the device. These are stress ratings only, which do not imply functional operation of the device at these or any other conditions beyond those indicated under *Recommended Operating Conditions*. Exposure to absolute-maximum-rated conditions for extended periods may affect device reliability.

### 6.2 ESD Ratings

		VALUE	UNIT
$V_{(ESD)}$ Electrostatic discharge	Human-body model (HBM), per ANSI/ESDA/JEDEC JS-001 <sup>(1)</sup>	±2000	V
	Charged-device model (CDM), per JEDEC specification JESD22-C101 <sup>(2)</sup>	±1000	
	Machine Model	±200	

- (1) JEDEC document JEP155 states that 500-V HBM allows safe manufacturing with a standard ESD control process.  
(2) JEDEC document JEP157 states that 250-V CDM allows safe manufacturing with a standard ESD control process.

### 6.3 Recommended Operating Conditions<sup>(1)</sup>

over operating free-air temperature range (unless otherwise noted)

		MIN	MAX	UNIT
Temperature Range		-40	125	°C
Supply Voltage ( $V_S = V^+ - V^-$ )		1.7	5.5	V

- (1) *Absolute Maximum Ratings* indicate limits beyond which damage may occur. *Recommended Operating Conditions* indicate conditions for which the device is intended to be functional, but specific performance is not ensured. For ensured specifications and test conditions, see *Electrical Characteristics*.

### 6.4 Thermal Information

THERMAL METRIC <sup>(1)</sup>		TLV521	UNIT
		DCK (SC70)	
		5 PINS	
$R_{\theta JA}$	Junction-to-ambient thermal resistance	269.9	°C/W
$R_{\theta JC(top)}$	Junction-to-case (top) thermal resistance	93.7	°C/W
$R_{\theta JB}$	Junction-to-board thermal resistance	48.8	°C/W
$\Psi_{JT}$	Junction-to-top characterization parameter	2	°C/W
$\Psi_{JB}$	Junction-to-board characterization parameter	47.9	°C/W
$R_{\theta JC(bot)}$	Junction-to-case (bottom) thermal resistance	N/A	°C/W

- (1) For more information about traditional and new thermal metrics, see the *Semiconductor and IC Package Thermal Metrics* application report, [SPRA953](#).

## 6.5 Electrical Characteristics

Unless otherwise specified, all limits for  $T_A = 25^\circ\text{C}$ ,  $V^+ = 3.3\text{ V}$ ,  $V^- = 0\text{ V}$ ,  $V_{CM} = V_O = V^+/2$ , and  $R_L > 1\text{ M}\Omega$ .<sup>(1)</sup>

PARAMETER		TEST CONDITIONS	MIN	TYP	MAX	UNIT
$V_{OS}$	Input Offset Voltage	$V_{CM} = 0.3\text{ V}$	-3	0.1	3	mV
		$V_{CM} = 3\text{ V}$	-3	0.1	3	
$TCV_{OS}$	Input Offset Voltage Drift			$\pm 1.5$		$\mu\text{V}/^\circ\text{C}$
$I_{BIAS}$	Input Bias Current			1		pA
$I_{OS}$	Input Offset Current			50		fA
CMRR	Common Mode Rejection Ratio	$0\text{ V} \leq V_{CM} \leq 3.3\text{ V}$	70	90		dB
		$0\text{ V} \leq V_{CM} \leq 2.2\text{ V}$		100		
PSRR	Power Supply Rejection Ratio	$V^+ = 1.8\text{ V to } 3.3\text{ V}$ ; $V_{CM} = 0.3\text{ V}$	80	100		dB
CMVR	Common Mode Voltage Range	CMRR $\geq 70\text{ dB}$	0		3.3	V
$A_{VOL}$	Large Signal Voltage Gain	$V_O = 0.5\text{ V to } 2.8\text{ V}$ $R_L = 100\text{ k}\Omega\text{ to } V^+/2$	80	110		dB
$V_O$	Output Swing High	$R_L = 100\text{ k}\Omega\text{ to } V^+/2$ $V_{IN}(\text{diff}) = 100\text{ mV}$		3	50	mV from either rail
	Output Swing Low	$R_L = 100\text{ k}\Omega\text{ to } V^+/2$ $V_{IN}(\text{diff}) = -100\text{ mV}$		2	50	
$I_O$	Output Current	Sourcing, $V_O\text{ to } V^-$ $V_{IN}(\text{diff}) = 100\text{ mV}$		11		mA
		Sinking, $V_O\text{ to } V^+$ $V_{IN}(\text{diff}) = -100\text{ mV}$		12		
$I_S$	Supply Current	$V_{CM} = 0.3\text{ V}$		350	500	nA

- (1) [Electrical Characteristics](#) values apply only for factory testing conditions at the temperature indicated. Factory testing conditions result in very limited self-heating of the device such that  $T_J = T_A$ . Parametric performance, as indicated in the electrical tables, is not ensured under conditions of self heating where  $T_J > T_A$ . [Absolute Maximum Ratings](#) indicate junction temperature limits beyond which the device may be permanently degraded, either mechanically or electrically.

## 6.6 AC Electrical Characteristics<sup>(1)</sup>

Unless otherwise specified, all limits for  $T_A = 25^\circ\text{C}$ ,  $V^+ = 3.3\text{ V}$ ,  $V^- = 0\text{ V}$ ,  $V_{\text{CM}} = V_O = V^+/2$ , and  $R_L > 1\text{ M}\Omega$ .

PARAMETER		TEST CONDITIONS	MIN (2)	TYP (3)	MAX (2)	UNIT
GBW	Gain-Bandwidth Product	$C_L = 20\text{ pF}$ , $R_L = 100\text{ k}\Omega$		6		kHz
SR	Slew Rate	$A_V = +1$ , $V_{\text{IN}} = 0\text{ V to } 3.3\text{ V}$	Falling Edge	2.9		V/ms
			Rising Edge	2.5		
$\theta_m$	Phase Margin	$C_L = 20\text{ pF}$ , $R_L = 100\text{ k}\Omega$		73		deg
$G_m$	Gain Margin	$C_L = 20\text{ pF}$ , $R_L = 100\text{ k}\Omega$		19		dB
$e_n$	Input-Referred Voltage Noise Density	$f = 100\text{ Hz}$		300		$\text{nV}/\sqrt{\text{Hz}}$
	Input-Referred Voltage Noise	0.1 Hz to 10 Hz		22		$\mu\text{V}_{\text{PP}}$
$I_n$	Input-Referred Current Noise	$f = 100\text{ Hz}$		100		$\text{fA}/\sqrt{\text{Hz}}$
EMIRR	EMI Rejection Ratio, $\text{IN}^+$ and $\text{IN}^-$ <sup>(4)</sup>	$V_{\text{RF\_PEAK}} = 100\text{ mV}_P$ ( $-20\text{ dB}_P$ ), $f = 400\text{ MHz}$		121		dB
		$V_{\text{RF\_PEAK}} = 100\text{ mV}_P$ ( $-20\text{ dB}_P$ ), $f = 900\text{ MHz}$		121		
		$V_{\text{RF\_PEAK}} = 100\text{ mV}_P$ ( $-20\text{ dB}_P$ ), $f = 1800\text{ MHz}$		124		
		$V_{\text{RF\_PEAK}} = 100\text{ mV}_P$ ( $-20\text{ dB}_P$ ), $f = 2400\text{ MHz}$		142		

- (1) *Electrical Characteristics* values apply only for factory testing conditions at the temperature indicated. Factory testing conditions result in very limited self-heating of the device such that  $T_J = T_A$ . Parametric performance, as indicated in the electrical tables, is not ensured under conditions of self heating where  $T_J > T_A$ . *Absolute Maximum Ratings* indicate junction temperature limits beyond which the device may be permanently degraded, either mechanically or electrically.
- (2) All limits are ensured by testing, statistical analysis or design.
- (3) Typical values represent the most likely parametric norm at the time of characterization. Actual typical values may vary over time and will also depend on the application and configuration. The typical values are not tested and are not ensured on shipped production material.
- (4) The EMI Rejection Ratio is defined as  $\text{EMIRR} = 20\log(V_{\text{RF\_PEAK}}/\Delta\text{VOS})$ .

### 6.7 Typical Characteristics

At  $T_J = 25^\circ\text{C}$ , unless otherwise specified.

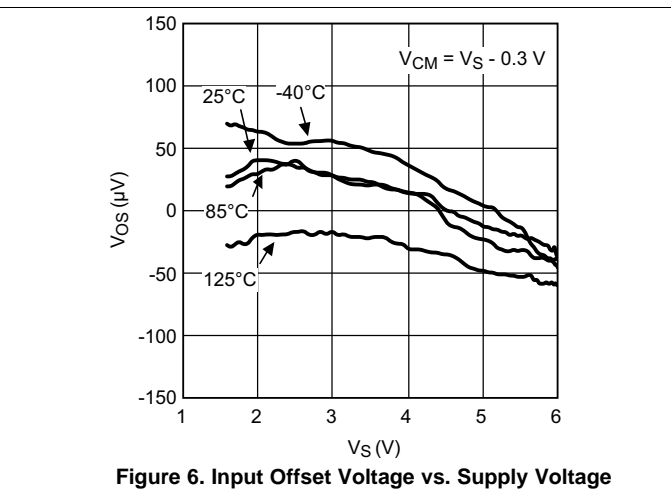
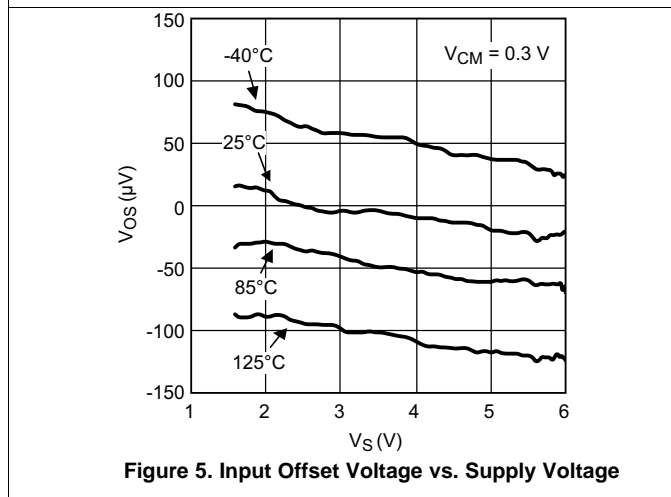
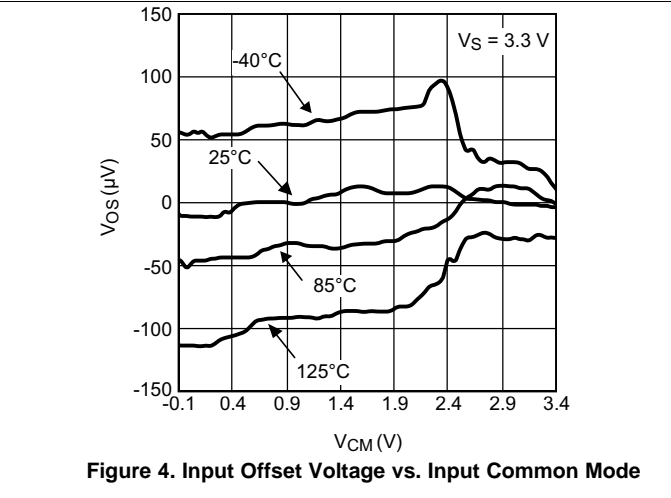
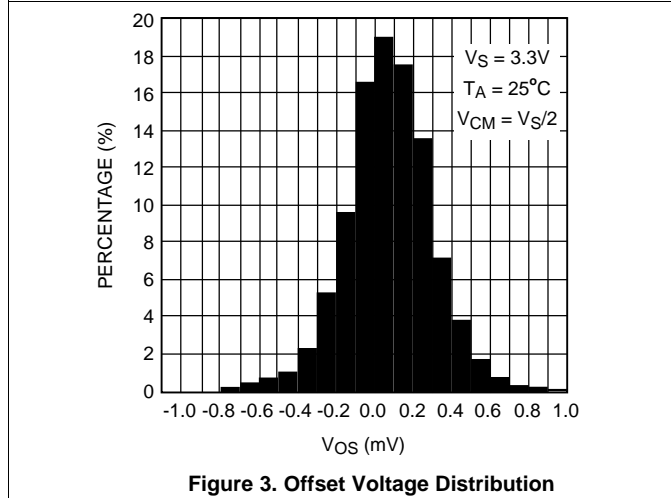
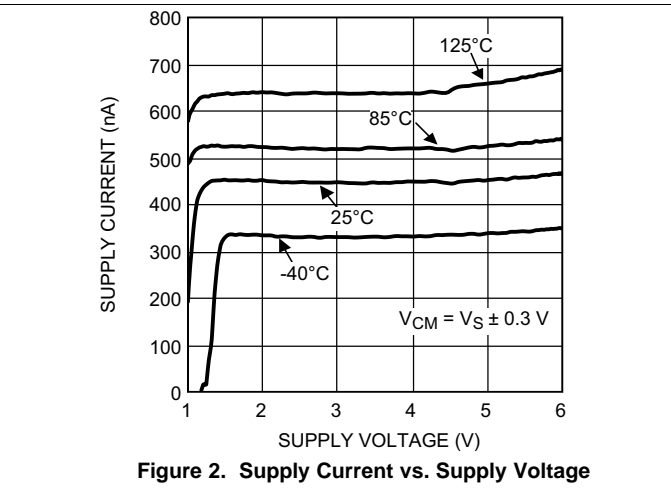
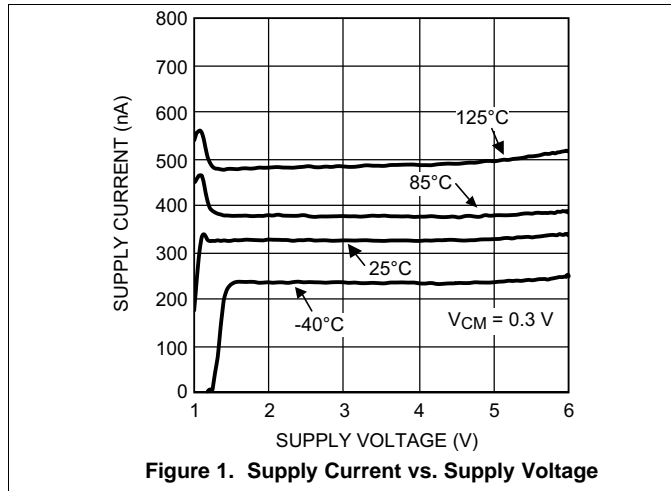

### Typical Characteristics (continued)

At  $T_J = 25^\circ\text{C}$ , unless otherwise specified.

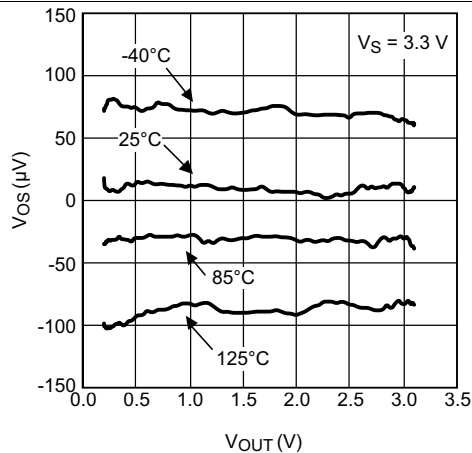

Figure 7. Input Offset Voltage vs. Output Voltage

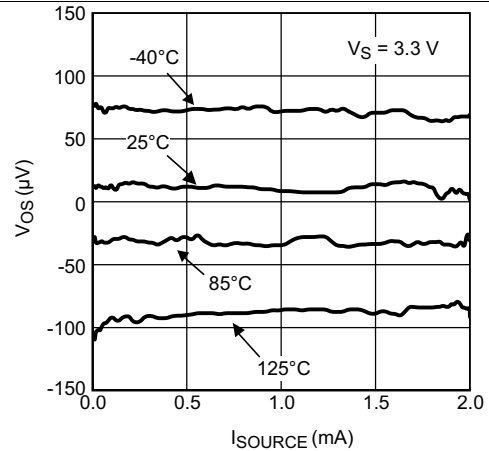

Figure 8. Input Offset Voltage vs. Sourcing Current

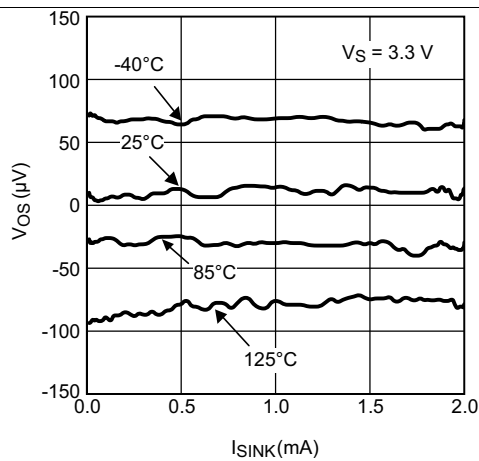

Figure 9. Input Offset Voltage vs. Sinking Current

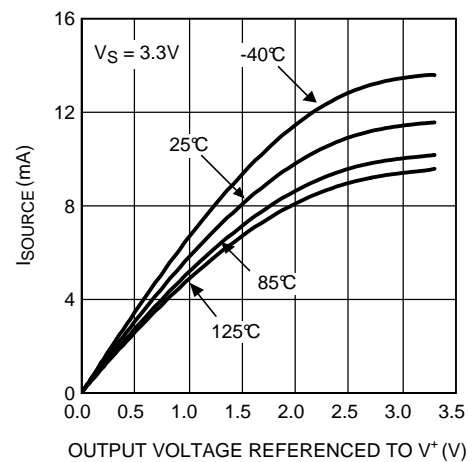

Figure 10. Sourcing Current vs. Output Voltage

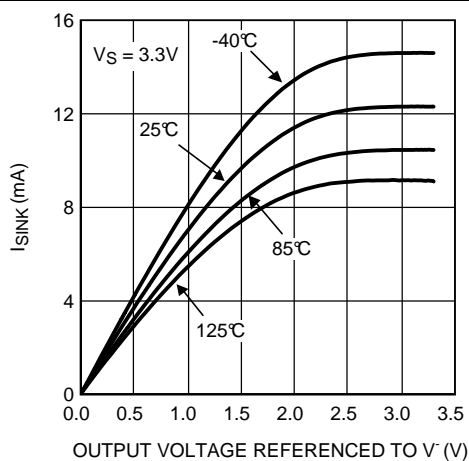

Figure 11. Sinking Current vs. Output Voltage

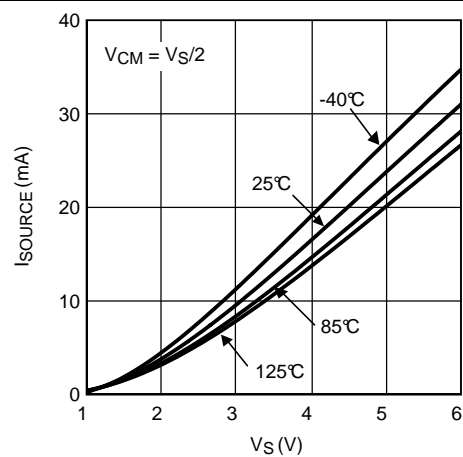

Figure 12. Sourcing Current vs. Supply Voltage

### Typical Characteristics (continued)

At  $T_J = 25^\circ\text{C}$ , unless otherwise specified.

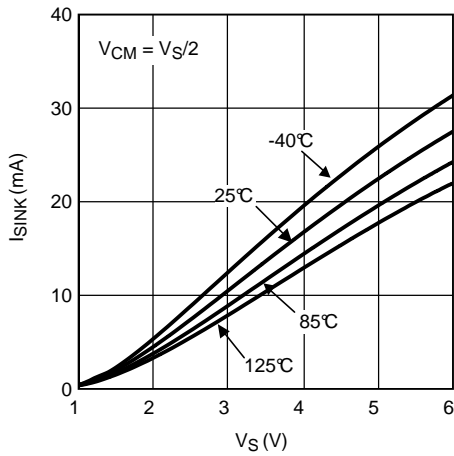

Figure 13. Sinking Current vs. Supply Voltage

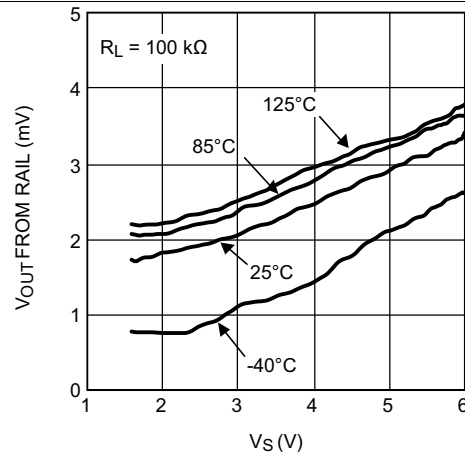

Figure 14. Output Swing High vs. Supply Voltage

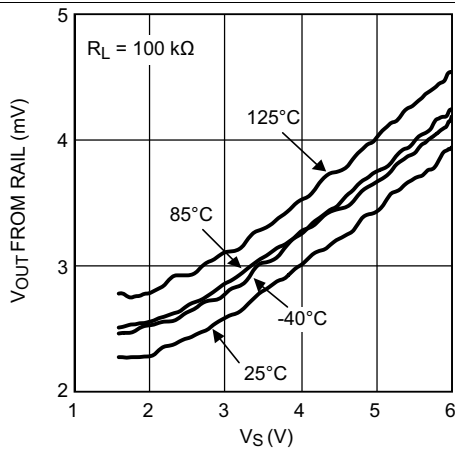

Figure 15. Output Swing Low vs. Supply Voltage

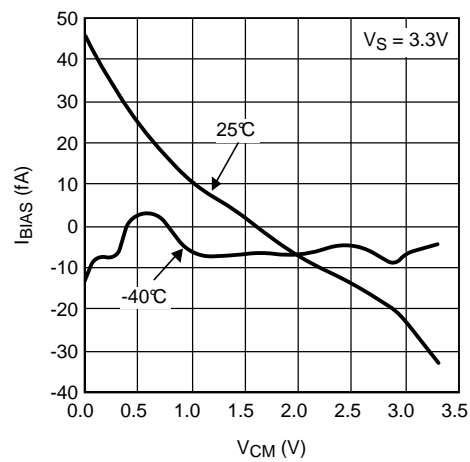

Figure 16. Input Bias Current vs. Common Mode Voltage

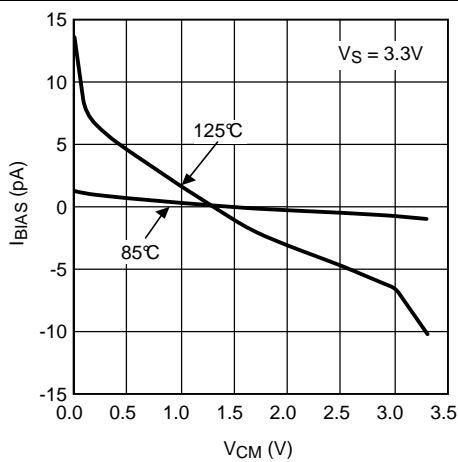

Figure 17. Input Bias Current vs. Common Mode Voltage

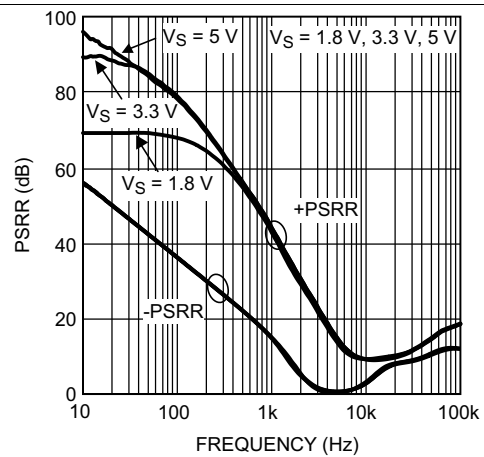

Figure 18. PSRR vs. Frequency



Typical Characteristics (continued)

At  $T_J = 25^\circ\text{C}$ , unless otherwise specified.

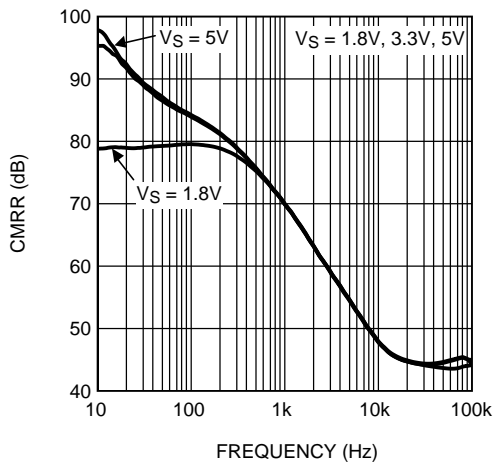

Figure 19. CMRR vs. Frequency

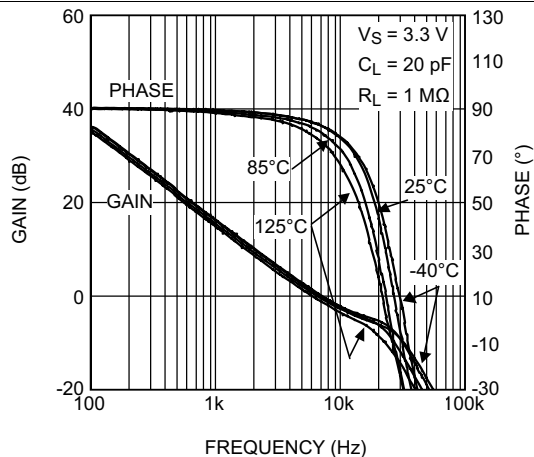

Figure 20. Frequency Response vs. Temperature

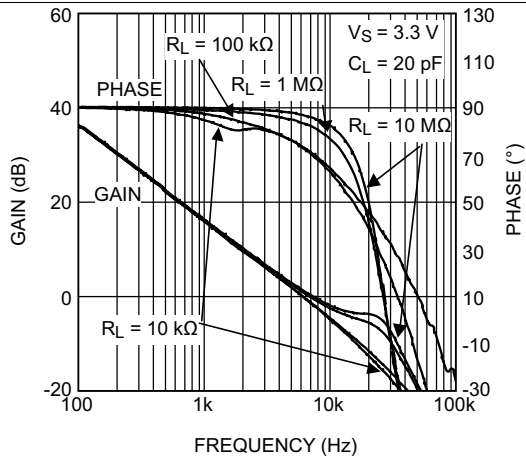

Figure 21. Frequency Response vs.  $R_L$

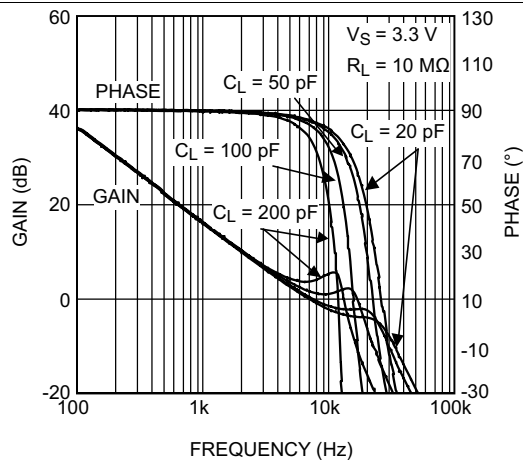

Figure 22. Frequency Response vs.  $C_L$

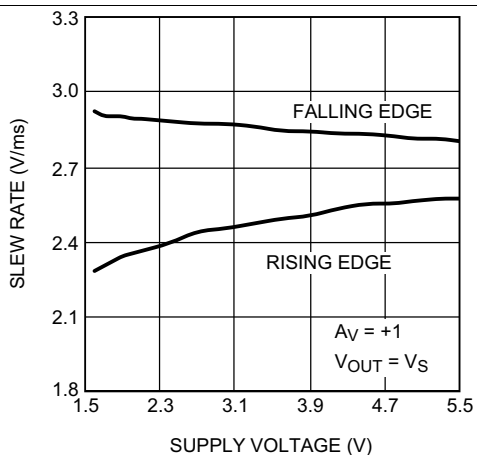

Figure 23. Slew Rate vs. Supply Voltage

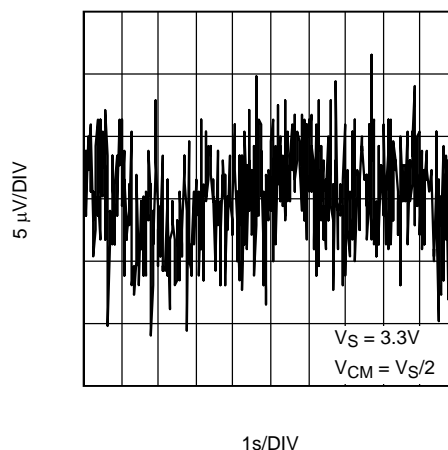
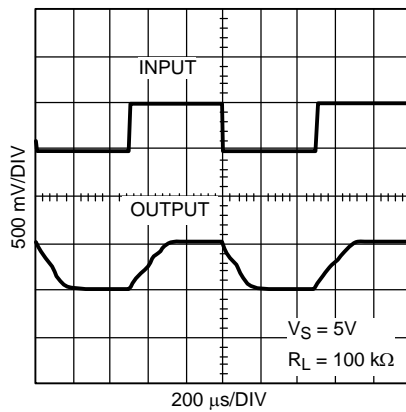
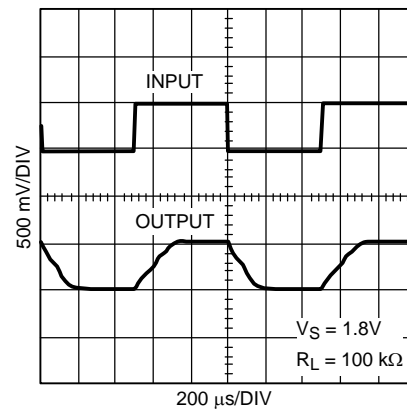
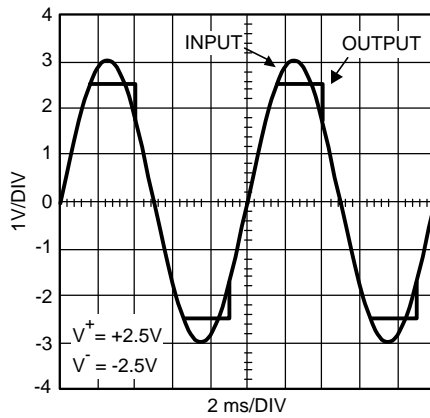
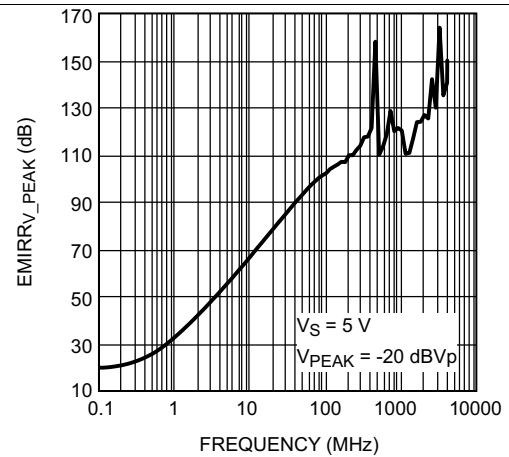

Figure 24. 0.1 to 10 Hz Time Domain Voltage Noise

**Typical Characteristics (continued)**

 At  $T_J = 25^\circ\text{C}$ , unless otherwise specified.

**Figure 25. Large Signal Pulse Response**

**Figure 26. Large Signal Pulse Response**

**Figure 27. Overload Recovery Waveform**

**Figure 28. EMIRR vs. Frequency**

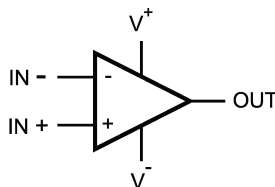
## 7 Detailed Description

### 7.1 Overview

The TLV521 is fabricated with Texas Instruments' state-of-the-art VIP50 process. This proprietary process dramatically improves the performance of Texas Instruments' low-power and low-voltage operational amplifiers. The following sections showcase the advantages of the VIP50 process and highlight circuits which enable ultra-low power consumption.

### 7.2 Functional Block Diagram



**Figure 29. Block Diagram**

### 7.3 Feature Description

The amplifier's differential inputs consist of a noninverting input (IN+) and an inverting input (IN-). The amplifier amplifies only the difference in voltage between the two inputs, which is called the differential input voltage. The output voltage of the op-amp  $V_{OUT}$  is given by [Equation 1](#):

$$V_{OUT} = A_{OL} (IN^+ - IN^-) \quad (1)$$

where  $A_{OL}$  is the open-loop gain of the amplifier, typically around 100 dB.

### 7.4 Device Functional Modes

#### 7.4.1 Input Stage

The TLV521 has a rail-to-rail input which provides more flexibility for the system designer. Rail-to-rail input is achieved by using in parallel, one PMOS differential pair and one NMOS differential pair. When the common mode input voltage ( $V_{CM}$ ) is near  $V_+$ , the NMOS pair is on and the PMOS pair is off. When  $V_{CM}$  is near  $V_-$ , the NMOS pair is off and the PMOS pair is on. When  $V_{CM}$  is between  $V_+$  and  $V_-$ , internal logic decides how much current each differential pair will get. This special logic ensures stable and low distortion amplifier operation within the entire common mode voltage range.

Because both input stages have their own offset voltage ( $V_{OS}$ ) characteristic, the offset voltage of the TLV521 becomes a function of  $V_{CM}$ .  $V_{OS}$  has a crossover point at 1.0 V below  $V_+$ . Refer to the ' $V_{OS}$  vs.  $V_{CM}$ ' curve in the Typical Performance Characteristics section. Caution should be taken in situations where the input signal amplitude is comparable to the  $V_{OS}$  value and/or the design requires high accuracy. In these situations, it is necessary for the input signal to avoid the crossover point. In addition, parameters such as PSRR and CMRR which involve the input offset voltage will also be affected by changes in  $V_{CM}$  across the differential pair transition region.

#### 7.4.2 Output Stage

The TLV521 output voltage swings 3 mV from rails at 3.3-V supply, which provides the maximum possible dynamic range at the output. This is particularly important when operating on low supply voltages.

The TLV521 Maximum Output Voltage Swing defines the maximum swing possible under a particular output load. The TLV521 output swings 50 mV from the rail at 5-V supply with an output load of 100 k $\Omega$ .

## 8 Applications and Implementation

### NOTE

Information in the following applications sections is not part of the TI component specification, and TI does not warrant its accuracy or completeness. TI's customers are responsible for determining suitability of components for their purposes. Customers should validate and test their design implementation to confirm system functionality.

### 8.1 Application Information

The TLV521 is specified for operation from 1.7 V to 5.5 V ( $\pm 0.85$  V to  $\pm 2.275$  V). The TLV521 features rail to rail input and rail-to-rail output swings while consuming only nanowatts of power. Parameters that can exhibit significant variance with regard to operating voltage or temperature are presented in the [Typical Characteristics](#) section.

#### 8.1.1 Driving Capacitive Load

The TLV521 is internally compensated for stable unity gain operation, with a 6-kHz, typical gain bandwidth. However, the unity gain follower is the most sensitive configuration to capacitive load. The combination of a capacitive load placed at the output of an amplifier along with the amplifier's output impedance creates a phase lag, which reduces the phase margin of the amplifier. If the phase margin is significantly reduced, the response will be under damped which causes peaking in the transfer and, when there is too much peaking, the op amp might start oscillating.

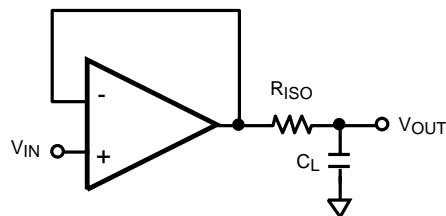

Figure 30. Resistive Isolation of Capacitive Load

In order to drive heavy capacitive loads, an isolation resistor,  $R_{ISO}$ , should be used, as shown in [Figure 30](#). By using this isolation resistor, the capacitive load is isolated from the amplifier's output. The larger the value of  $R_{ISO}$ , the more stable the amplifier will be. If the value of  $R_{ISO}$  is sufficiently large, the feedback loop will be stable, independent of the value of  $C_L$ . However, larger values of  $R_{ISO}$  result in reduced output swing and reduced output current drive.

Recommended minimum values for  $R_{ISO}$  are given in the following table, for 5-V supply. [Figure 31](#) shows the typical response obtained with the  $C_L = 50$  pF and  $R_{ISO} = 154$  k $\Omega$ . The other values of  $R_{ISO}$  in the table were chosen to achieve similar dampening at their respective capacitive loads. Notice that for the TLV521 with larger  $C_L$  a smaller  $R_{ISO}$  can be used for stability. However, for a given  $C_L$  a larger  $R_{ISO}$  will provide a more damped response. For capacitive loads of 20 pF and below no isolation resistor is needed.

Table 1. Capacitive Loads vs. Needed Isolation Resistors

$C_L$	$R_{ISO}$
0 – 20 pF	not needed
50 pF	154 k $\Omega$
100 pF	118 k $\Omega$
500 pF	52.3 k $\Omega$
1 nF	33.2 k $\Omega$
5 nF	17.4 k $\Omega$
10 nF	13.3 k $\Omega$

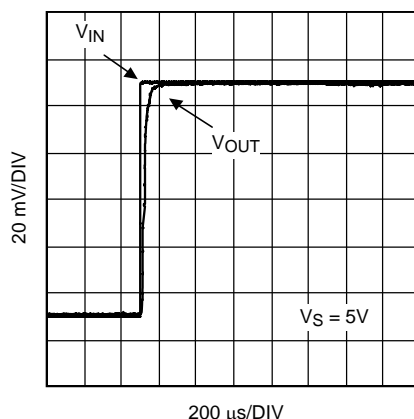

Figure 31. Step Response

### 8.1.2 EMI Suppression

The near-ubiquity of cellular, Bluetooth, and Wi-Fi signals and the rapid rise of sensing systems incorporating wireless radios make electromagnetic interference (EMI) an evermore important design consideration for precision signal paths. Though RF signals lie outside the op amp band, RF carrier switching can modulate the DC offset of the op amp. Also some common RF modulation schemes can induce down-converted components. The added DC offset and the induced signals are amplified with the signal of interest and thus corrupt the measurement. The TLV521 uses on chip filters to reject these unwanted RF signals at the inputs and power supply pins; thereby preserving the integrity of the precision signal path.

Twisted pair cabling and the active front-end's common-mode rejection provide immunity against low-frequency noise (i.e. 60-Hz or 50-Hz mains) but are ineffective against RF interference. Even a few centimeters of PCB trace and wiring for sensors located close to the amplifier can pick up significant 1 GHz RF. The integrated EMI filters of the TLV521 reduce or eliminate external shielding and filtering requirements, thereby increasing system robustness. A larger EMIRR means more rejection of the RF interference. For more information on EMIRR, please refer to [AN-1698](#).

## 8.2 Typical Applications

### 8.2.1 60-Hz Twin T-Notch Filter

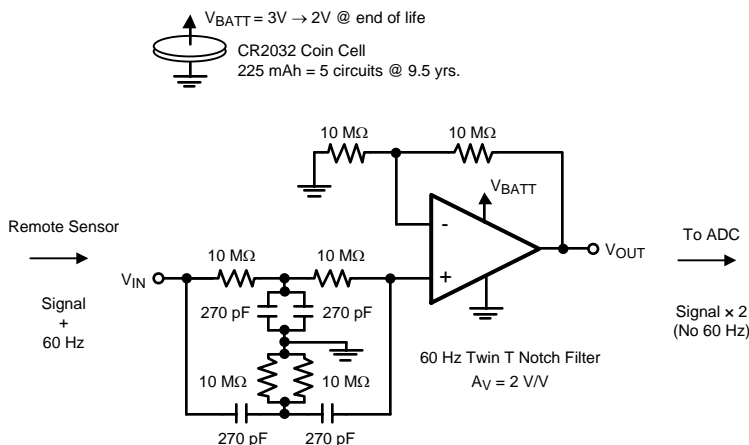

Figure 32. 60-Hz Notch Filter

## Typical Applications (continued)

### 8.2.1.1 Design Requirements

Small signals from transducers in remote and distributed sensing applications commonly suffer strong 60-Hz interference from AC power lines. The circuit of [Figure 32](#) notches out the 60 Hz and provides a gain  $A_V = 2$  for the sensor signal represented by a 1-kHz sine wave. Similar stages may be cascaded to remove 2<sup>nd</sup> and 3<sup>rd</sup> harmonics of 60 Hz. Thanks to the nA power consumption of the TLV521, even 5 such circuits can run for 9.5 years from a small CR2032 lithium cell. These batteries have a nominal voltage of 3 V and an end of life voltage of 2 V. With an operating voltage from 1.7 V to 5.5 V the TLV521 can function over this voltage range.

### 8.2.1.2 Detailed Design Procedure

The notch frequency is set by  $F_0 = 1 / 2\pi RC$ . To achieve a 60-Hz notch use  $R = 10 \text{ M}\Omega$  and  $C = 270 \text{ pF}$ . If eliminating 50-Hz noise, which is common in European systems, use  $R = 11.8 \text{ M}\Omega$  and  $C = 270 \text{ pF}$ .

The Twin T Notch Filter works by having two separate paths from  $V_{IN}$  to the amplifier's input. A low frequency path through the resistors R - R and another separate high frequency path through the capacitors C - C. However, at frequencies around the notch frequency, the two paths have opposing phase angles and the two signals will tend to cancel at the amplifier's input.

To ensure that the target center frequency is achieved and to maximize the notch depth (Q factor) the filter needs to be as balanced as possible. To obtain circuit balance, while overcoming limitations of available standard resistor and capacitor values, use passives in parallel to achieve the 2C and R/2 circuit requirements for the filter components that connect to ground.

To make sure passive component values stay as expected clean board with alcohol, rinse with deionized water, and air dry. Make sure board remains in a relatively low humidity environment to minimize moisture which may increase the conductivity of board components. Also large resistors come with considerable parasitic stray capacitance which effects can be reduced by cutting out the ground plane below components of concern.

Large resistors are used in the feedback network to minimize battery drain. When designing with large resistors, resistor thermal noise, op amp current noise, as well as op amp voltage noise, must be considered in the noise analysis of the circuit. The noise analysis for the circuit in [Figure 32](#) can be done over a bandwidth of 5 kHz, which takes the conservative approach of overestimating the bandwidth (TLV521 typical  $GBW/A_V$  is lower). The total noise at the output is approximately 800  $\mu\text{Vpp}$ , which is excellent considering the total consumption of the circuit is only 540 nA. The dominant noise terms are op amp voltage noise (550  $\mu\text{Vpp}$ ), current noise through the feedback network (430  $\mu\text{Vpp}$ ), and current noise through the notch filter network (280  $\mu\text{Vpp}$ ). Thus the total circuit's noise is below  $\frac{1}{2}$  LSB of a 10 bit system with a 2-V reference, which is 1 mV.

### 8.2.1.3 Application Curve

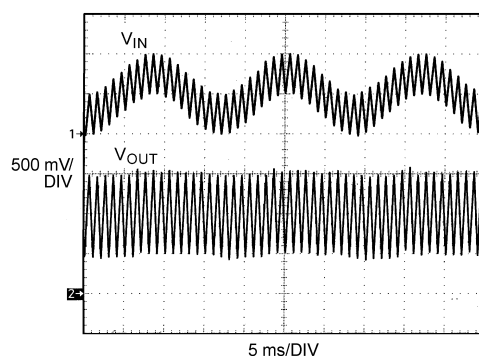

**Figure 33. 60-Hz Notch Filter Waveform**

## Typical Applications (continued)

### 8.2.2 Portable Gas Detection Sensor

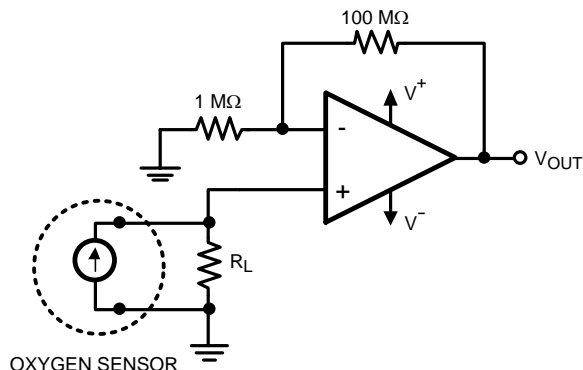

Figure 34. Precision Oxygen Sensor

#### 8.2.2.1 Design Requirements

Gas sensors are used in many different industrial and medical applications. They generate a current which is proportional to the percentage of a particular gas sensed in an air sample. This current goes through a load resistor and the resulting voltage drop is measured. The TLV521 makes an excellent choice for this application as it only draws 350 nA of current and operates on supply voltages down to 1.7 V. Depending on the sensed gas and sensitivity of the sensor, the output current can be in the order of tens of microamperes to a few milliamperes. Gas sensor data sheets often specify a recommended load resistor value or they suggest a range of load resistors to choose from.

Oxygen sensors are used when air quality or oxygen delivered to a patient needs to be monitored. Fresh air contains 20.9% oxygen. Air samples containing less than 18% oxygen are considered dangerous. This application detects oxygen in air. Oxygen sensors are also used in industrial applications where the environment must lack oxygen. An example is when food is vacuum packed. There are two main categories of oxygen sensors, those which sense oxygen when it is abundantly present (i.e. in air or near an oxygen tank) and those which detect traces of oxygen in ppm.

#### 8.2.2.2 Detailed Design Procedure

Figure 34 shows a typical circuit used to amplify the output of an oxygen detector. The oxygen sensor outputs a known current through the load resistor. This value changes with the amount of oxygen present in the air sample. Oxygen sensors usually recommend a particular load resistor value or specify a range of acceptable values for the load resistor. The use of the nanopower TLV521 means minimal power usage by the op amp and it enhances the battery life. With the components shown in Figure 34 the circuit can consume less than 0.5  $\mu$ A of current ensuring that even batteries used in compact portable electronics, with low mAh charge ratings, could last beyond the life of the oxygen sensor. The precision specifications of the TLV521, such as its very low offset voltage, low  $TCV_{OS}$ , low input bias current, high CMRR, and high PSRR are other factors which make the TLV521 a great choice for this application.

## Typical Applications (continued)

### 8.2.2.3 Application Curve

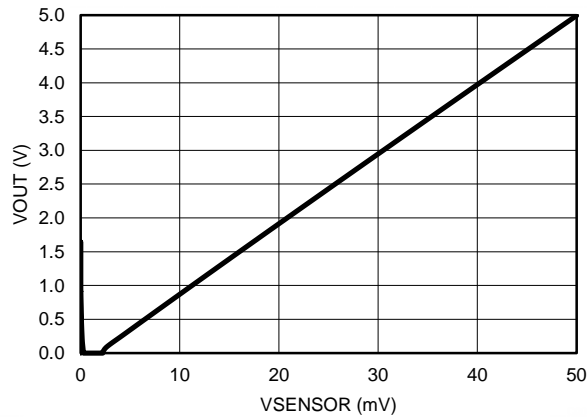

Figure 35. Calculated Oxygen Sensor Circuit Output (Single 5V Supply)

### 8.2.3 High-Side Battery Current Sensing

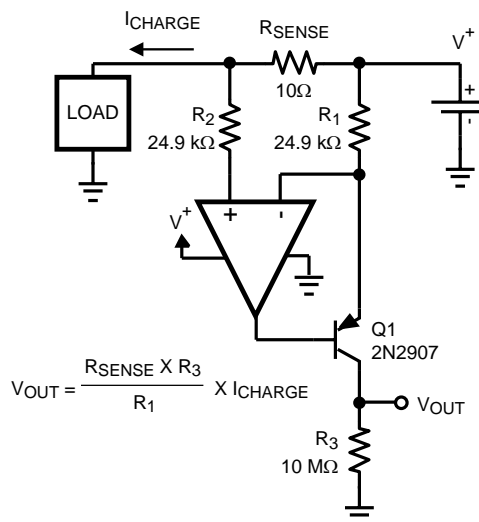

Figure 36. High-Side Current Sensing

#### 8.2.3.1 Design Requirements

The rail-to-rail common mode input range and the very low quiescent current make the TLV521 ideal to use in high-side and low-side battery current sensing applications. The high-side current sensing circuit in [Figure 36](#) is commonly used in a battery charger to monitor the charging current in order to prevent over charging. A sense resistor  $R_{SENSE}$  is connected in series with the battery.

#### 8.2.3.2 Detailed Design Procedure

The theoretical output voltage of the circuit is  $V_{OUT} = [R_{SENSE} \times R_3] / R_1 \times I_{CHARGE}$ . In reality, however, due to the finite Current Gain,  $\beta$ , of the transistor the current that travels through  $R_3$  will not be  $I_{CHARGE}$ , but instead, will be  $\alpha \times I_{CHARGE}$  or  $\beta / (\beta + 1) \times I_{CHARGE}$ . A Darlington pair can be used to increase the  $\beta$  and performance of the measuring circuit.

Using the components shown in [Figure 36](#) will result in  $V_{OUT} \approx 4000 \Omega \times I_{CHARGE}$ . This is ideal to amplify a 1 mA  $I_{CHARGE}$  to near full scale of an ADC with  $V_{REF}$  at 4.1 V. A resistor,  $R_2$  is used at the noninverting input of the amplifier, with the same value as  $R_1$  to minimize offset voltage.



### Typical Applications (continued)

Selecting values per Figure 36 will limit the current traveling through the  $R_1 - Q1 - R_3$  leg of the circuit to under  $1 \mu\text{A}$  which is on the same order as the TLV521 supply current. Increasing resistors  $R_1$ ,  $R_2$ , and  $R_3$  will decrease the measuring circuit supply current and extend battery life.

Decreasing  $R_{\text{SENSE}}$  will minimize error due to resistor tolerance, however, this will also decrease  $V_{\text{SENSE}} = I_{\text{CHARGE}} \times R_{\text{SENSE}}$ , and in turn the amplifier offset voltage will have a more significant contribution to the total error of the circuit. With the components shown in Figure 36 the measurement circuit supply current can be kept below  $1.5 \mu\text{A}$  and measure  $100 \mu\text{A}$  to  $1 \text{ mA}$ .

#### 8.2.3.3 Application Curve

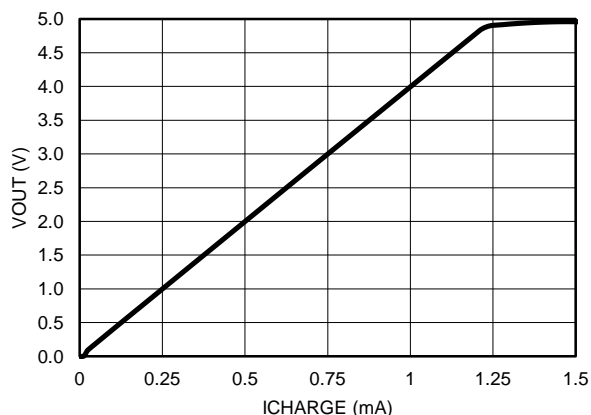

Figure 37. Calculated High-Side Current Sense Circuit Output

## 9 Power Supply Recommendations

The TLV521 is specified for operation from  $1.7 \text{ V}$  to  $5.5 \text{ V}$  ( $\pm 0.85 \text{ V}$  to  $\pm 2.275 \text{ V}$ ) over a  $-40^\circ\text{C}$  to  $125^\circ\text{C}$  temperature range. Parameters that can exhibit significant variance with regard to operating voltage or temperature are presented in the *Typical Characteristics*.

### CAUTION

Supply voltages larger than  $6 \text{ V}$  can permanently damage the device.

Low bandwidth nanopower devices do not have good high frequency ( $>1\text{kHz}$ ) AC PSRR rejection against high-frequency switching supplies and other kHz and above noise sources, so extra supply filtering is recommended if kHz range noise is expected on the power supply lines.

## 10 Layout

### 10.1 Layout Guidelines

For best operational performance of the device, use good printed circuit board (PCB) layout practices, including:

- Noise can propagate into analog circuitry through the power pins of the circuit as a whole and op amp itself. Bypass capacitors are used to reduce the coupled noise by providing low-impedance power sources local to the analog circuitry.
- Connect low-ESR, 0.1- $\mu\text{F}$  ceramic bypass capacitors between each supply pin and ground, placed as close to the device as possible. A single bypass capacitor from  $V+$  to ground is applicable for single supply applications.
- Separate grounding for analog and digital portions of circuitry is one of the simplest and most-effective methods of noise suppression. One or more layers on multilayer PCBs are usually devoted to ground planes. A ground plane helps distribute heat and reduces EMI noise pickup. Make sure to physically separate digital and analog grounds paying attention to the flow of the ground current. For more detailed information refer to *Circuit Board Layout Techniques*, [SLOA089](#).
- In order to reduce parasitic coupling, run the input traces as far away from the supply or output traces as possible. If it is not possible to keep them separate, it is much better to cross the sensitive trace perpendicular as opposed to in parallel with the noisy trace.
- Place the external components as close to the device as possible. As shown in [Layout Example](#), keeping RF and RG close to the inverting input minimizes parasitic capacitance.
- Keep the length of input traces as short as possible. Always remember that the input traces are the most sensitive part of the circuit.
- Consider a driven, low-impedance guard ring around the critical traces. A guard ring can significantly reduce leakage currents from nearby traces that are at different potentials.

### 10.2 Layout Example

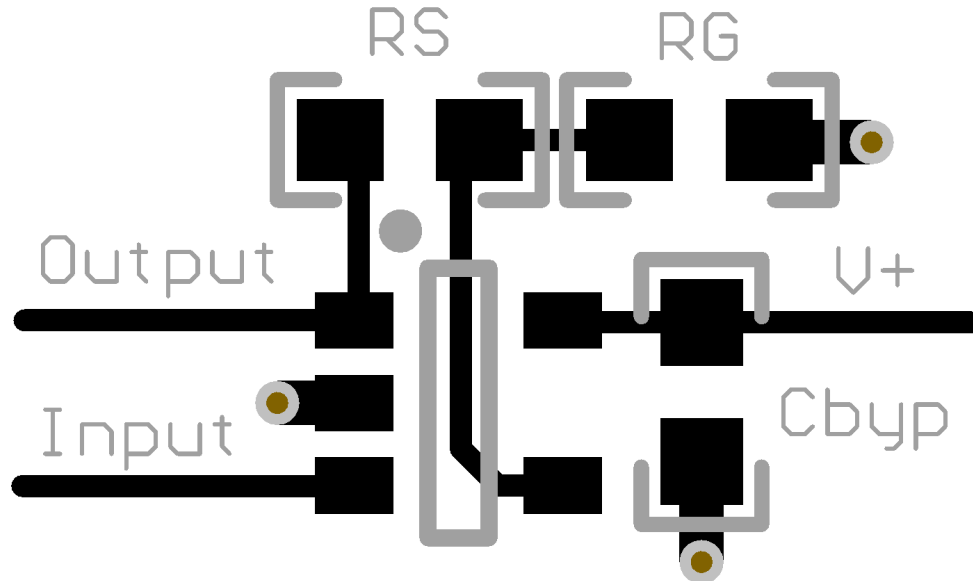

Figure 38. Noninverting Layout Example

## 11 Device and Documentation Support

### 11.1 Device Support

#### 11.1.1 Development Support

TLV521 PSPICE Model, [SNOM024](#)

TINA-TI SPICE-Based Analog Simulation Program, <http://www.ti.com/tool/tina-ti>

TI Filterpro Software, <http://www.ti.com/tool/filterpro>

DIP Adapter Evaluation Module, <http://www.ti.com/tool/dip-adapter-evm>

TI Universal Operational Amplifier Evaluation Module, <http://www.ti.com/tool/opampevm>

Evaluation board for 5-pin, north-facing amplifiers in the SC70 package, [SNOA487](#).

Manual for LMH730268 Evaluation board [551012922-001](#)

### 11.2 Documentation Support

#### 11.2.1 Related Documentation

For related documentation, see the following:

- Feedback Plots Define Op Amp AC Performance, [SBOA015 \(AB-028\)](#)
- Circuit Board Layout Techniques, [SLOA089](#)
- Op Amps for Everyone, [SLOD006](#)
- AN-1698 A Specification for EMI Hardened Operational Amplifiers, [SNOA497](#)
- EMI Rejection Ratio of Operational Amplifiers, [SBOA128](#)
- Capacitive Load Drive Solution using an Isolation Resistor, [TIPD128](#)
- Handbook of Operational Amplifier Applications, [SBOA092](#)

### 11.3 Community Resources

The following links connect to TI community resources. Linked contents are provided "AS IS" by the respective contributors. They do not constitute TI specifications and do not necessarily reflect TI's views; see TI's [Terms of Use](#).

**TI E2E™ Online Community** *TI's Engineer-to-Engineer (E2E) Community*. Created to foster collaboration among engineers. At [e2e.ti.com](http://e2e.ti.com), you can ask questions, share knowledge, explore ideas and help solve problems with fellow engineers.

**Design Support** *TI's Design Support* Quickly find helpful E2E forums along with design support tools and contact information for technical support.

### 11.4 Trademarks

E2E is a trademark of Texas Instruments.

All other trademarks are the property of their respective owners.

### 11.5 Electrostatic Discharge Caution



This integrated circuit can be damaged by ESD. Texas Instruments recommends that all integrated circuits be handled with appropriate precautions. Failure to observe proper handling and installation procedures can cause damage.

ESD damage can range from subtle performance degradation to complete device failure. Precision integrated circuits may be more susceptible to damage because very small parametric changes could cause the device not to meet its published specifications.

### 11.6 Glossary

[SLYZ022](#) — *TI Glossary*.

This glossary lists and explains terms, acronyms, and definitions.

## 12 Mechanical, Packaging, and Orderable Information

The following pages include mechanical, packaging, and orderable information. This information is the most current data available for the designated devices. This data is subject to change without notice and revision of this document. For browser-based versions of this data sheet, refer to the left-hand navigation.

**PACKAGING INFORMATION**

Orderable part number	Status (1)	Material type (2)	Package   Pins	Package qty   Carrier	RoHS (3)	Lead finish/ Ball material (4)	MSL rating/ Peak reflow (5)	Op temp (°C)	Part marking (6)
<a href="#">TLV521DCKR</a>	Active	Production	SC70 (DCK)   5	3000   LARGE T&R	Yes	SN	Level-1-260C-UNLIM	-40 to 125	14F
TLV521DCKR.A	Active	Production	SC70 (DCK)   5	3000   LARGE T&R	Yes	SN	Level-1-260C-UNLIM	-40 to 125	14F
<a href="#">TLV521DCKT</a>	Active	Production	SC70 (DCK)   5	250   SMALL T&R	Yes	SN	Level-1-260C-UNLIM	-40 to 125	14F
TLV521DCKT.A	Active	Production	SC70 (DCK)   5	250   SMALL T&R	Yes	SN	Level-1-260C-UNLIM	-40 to 125	14F

(1) **Status:** For more details on status, see our [product life cycle](#).

(2) **Material type:** When designated, preproduction parts are prototypes/experimental devices, and are not yet approved or released for full production. Testing and final process, including without limitation quality assurance, reliability performance testing, and/or process qualification, may not yet be complete, and this item is subject to further changes or possible discontinuation. If available for ordering, purchases will be subject to an additional waiver at checkout, and are intended for early internal evaluation purposes only. These items are sold without warranties of any kind.

(3) **RoHS values:** Yes, No, RoHS Exempt. See the [TI RoHS Statement](#) for additional information and value definition.

(4) **Lead finish/Ball material:** Parts may have multiple material finish options. Finish options are separated by a vertical ruled line. Lead finish/Ball material values may wrap to two lines if the finish value exceeds the maximum column width.

(5) **MSL rating/Peak reflow:** The moisture sensitivity level ratings and peak solder (reflow) temperatures. In the event that a part has multiple moisture sensitivity ratings, only the lowest level per JEDEC standards is shown. Refer to the shipping label for the actual reflow temperature that will be used to mount the part to the printed circuit board.

(6) **Part marking:** There may be an additional marking, which relates to the logo, the lot trace code information, or the environmental category of the part.

Multiple part markings will be inside parentheses. Only one part marking contained in parentheses and separated by a "~" will appear on a part. If a line is indented then it is a continuation of the previous line and the two combined represent the entire part marking for that device.

**Important Information and Disclaimer:** The information provided on this page represents TI's knowledge and belief as of the date that it is provided. TI bases its knowledge and belief on information provided by third parties, and makes no representation or warranty as to the accuracy of such information. Efforts are underway to better integrate information from third parties. TI has taken and continues to take reasonable steps to provide representative and accurate information but may not have conducted destructive testing or chemical analysis on incoming materials and chemicals. TI and TI suppliers consider certain information to be proprietary, and thus CAS numbers and other limited information may not be available for release.

In no event shall TI's liability arising out of such information exceed the total purchase price of the TI part(s) at issue in this document sold by TI to Customer on an annual basis.

**TAPE AND REEL INFORMATION**

**QUADRANT ASSIGNMENTS FOR PIN 1 ORIENTATION IN TAPE**

\*All dimensions are nominal

Device	Package Type	Package Drawing	Pins	SPQ	Reel Diameter (mm)	Reel Width W1 (mm)	A0 (mm)	B0 (mm)	K0 (mm)	P1 (mm)	W (mm)	Pin1 Quadrant
TLV521DCKR	SC70	DCK	5	3000	178.0	8.4	2.25	2.45	1.2	4.0	8.0	Q3
TLV521DCKT	SC70	DCK	5	250	178.0	8.4	2.25	2.45	1.2	4.0	8.0	Q3

**TAPE AND REEL BOX DIMENSIONS**

\*All dimensions are nominal

Device	Package Type	Package Drawing	Pins	SPQ	Length (mm)	Width (mm)	Height (mm)
TLV521DCKR	SC70	DCK	5	3000	208.0	191.0	35.0
TLV521DCKT	SC70	DCK	5	250	208.0	191.0	35.0

# DCK0005A



## PACKAGE OUTLINE

SOT - 1.1 max height

SMALL OUTLINE TRANSISTOR

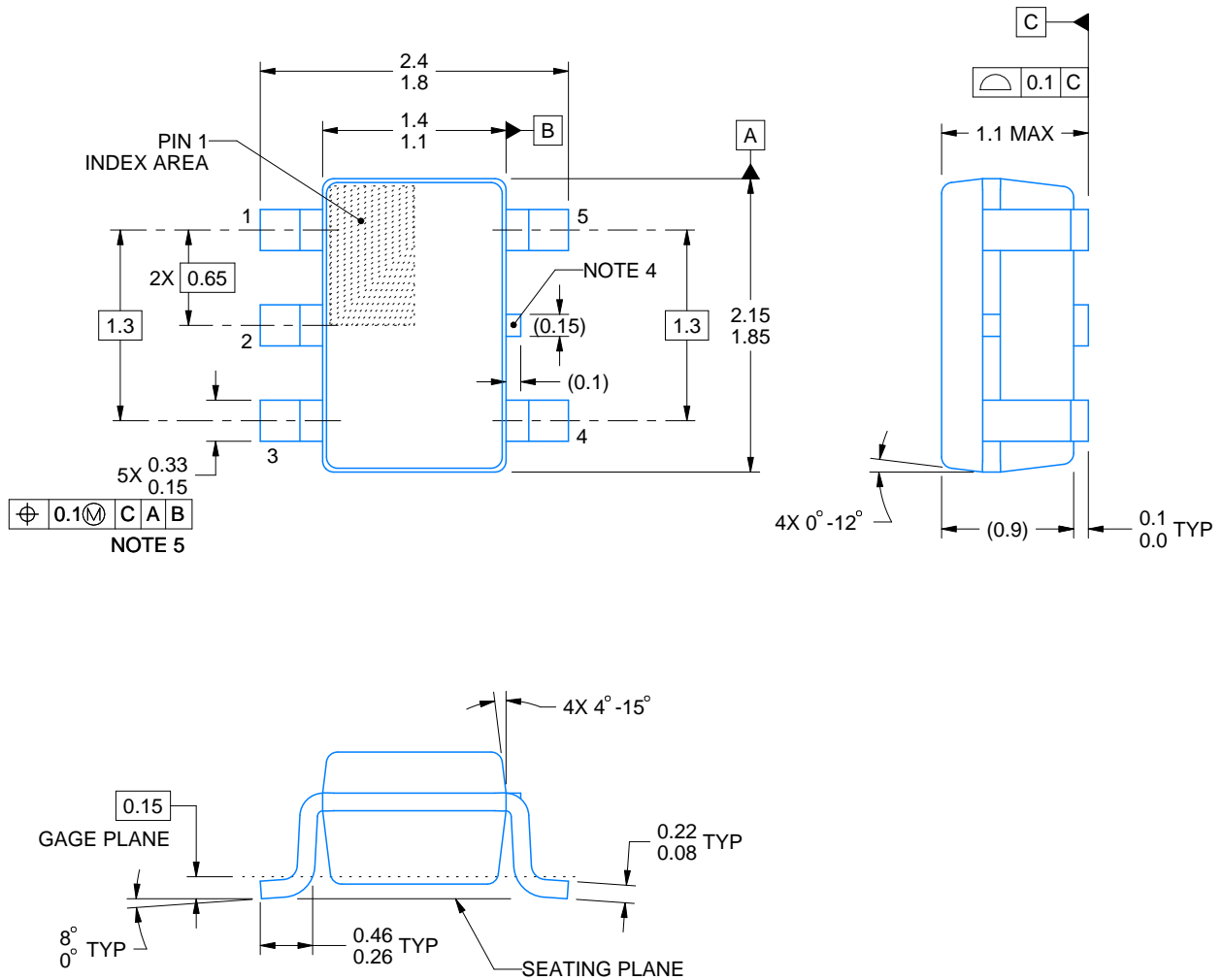

4214834/G 11/2024

### NOTES:

1. All linear dimensions are in millimeters. Any dimensions in parenthesis are for reference only. Dimensioning and tolerancing per ASME Y14.5M.
2. This drawing is subject to change without notice.
3. Reference JEDEC MO-203.
4. Support pin may differ or may not be present.
5. Lead width does not comply with JEDEC.
6. Body dimensions do not include mold flash, protrusions, or gate burrs. Mold flash, protrusions, or gate burrs shall not exceed 0.25mm per side



# EXAMPLE BOARD LAYOUT

DCK0005A

SOT - 1.1 max height

SMALL OUTLINE TRANSISTOR



LAND PATTERN EXAMPLE  
EXPOSED METAL SHOWN  
SCALE:18X

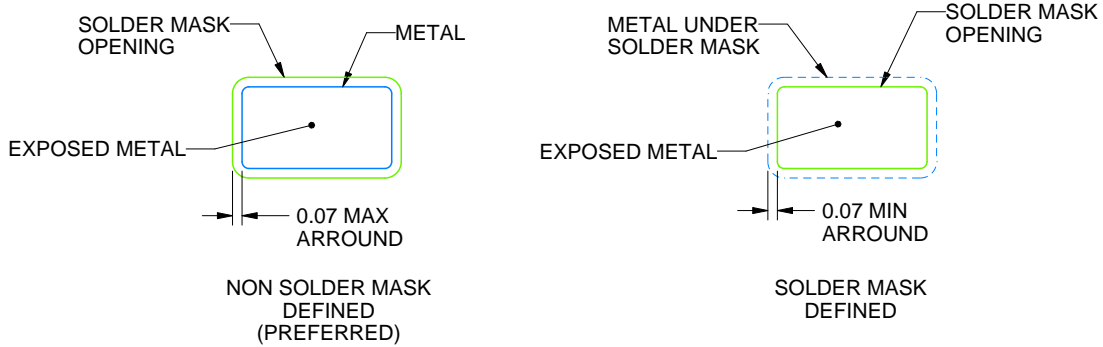

SOLDER MASK DETAILS

4214834/G 11/2024

NOTES: (continued)

- 7. Publication IPC-7351 may have alternate designs.
- 8. Solder mask tolerances between and around signal pads can vary based on board fabrication site.

# EXAMPLE STENCIL DESIGN

DCK0005A

SOT - 1.1 max height

SMALL OUTLINE TRANSISTOR



SOLDER PASTE EXAMPLE  
BASED ON 0.125 THICK STENCIL  
SCALE: 18X

4214834/G 11/2024

NOTES: (continued)

9. Laser cutting apertures with trapezoidal walls and rounded corners may offer better paste release. IPC-7525 may have alternate design recommendations.
10. Board assembly site may have different recommendations for stencil design.

## IMPORTANT NOTICE AND DISCLAIMER

TI PROVIDES TECHNICAL AND RELIABILITY DATA (INCLUDING DATASHEETS), DESIGN RESOURCES (INCLUDING REFERENCE DESIGNS), APPLICATION OR OTHER DESIGN ADVICE, WEB TOOLS, SAFETY INFORMATION, AND OTHER RESOURCES "AS IS" AND WITH ALL FAULTS, AND DISCLAIMS ALL WARRANTIES, EXPRESS AND IMPLIED, INCLUDING WITHOUT LIMITATION ANY IMPLIED WARRANTIES OF MERCHANTABILITY, FITNESS FOR A PARTICULAR PURPOSE OR NON-INFRINGEMENT OF THIRD PARTY INTELLECTUAL PROPERTY RIGHTS.

These resources are intended for skilled developers designing with TI products. You are solely responsible for (1) selecting the appropriate TI products for your application, (2) designing, validating and testing your application, and (3) ensuring your application meets applicable standards, and any other safety, security, regulatory or other requirements.

These resources are subject to change without notice. TI grants you permission to use these resources only for development of an application that uses the TI products described in the resource. Other reproduction and display of these resources is prohibited. No license is granted to any other TI intellectual property right or to any third party intellectual property right. TI disclaims responsibility for, and you fully indemnify TI and its representatives against any claims, damages, costs, losses, and liabilities arising out of your use of these resources.

TI's products are provided subject to [TI's Terms of Sale](#), [TI's General Quality Guidelines](#), or other applicable terms available either on [ti.com](#) or provided in conjunction with such TI products. TI's provision of these resources does not expand or otherwise alter TI's applicable warranties or warranty disclaimers for TI products. Unless TI explicitly designates a product as custom or customer-specified, TI products are standard, catalog, general purpose devices.

TI objects to and rejects any additional or different terms you may propose.

Copyright © 2026, Texas Instruments Incorporated

Last updated 10/2025