

TLV741P 150-mA, Low-Dropout Regulator With Foldback Current Limit

1 Features

- Input Voltage Range: 1.4 V to 5.5 V
- Stable Operation With 1- μ F Ceramic Capacitors
- Foldback Overcurrent Protection
- Packages:
 - 5-Pin SOT-23
 - 4-Pin X2SON
- Very Low Dropout: 230 mV at 150 mA
- Accuracy: 1%
- Low I_Q : 50 μ A
- Available in Fixed-Output Voltages: 1 V to 3.3 V
- High PSRR: 65 dB at 1 kHz
- Active Output Discharge (P Version Only)

2 Applications

- PDAs and Battery-Powered Portable Devices
- MP3 Players and Other Hand-Held Products
- WLAN and Other PC Add-On Cards

3 Description

The TLV741P low-dropout linear regulator (LDO) is a low quiescent current device with excellent line and load transient performance for power-sensitive applications. This device provides a typical accuracy of 1%.

The TLV741P is designed to be stable with a small, 1- μ F output capacitor.

The TLV741P provides inrush current control during device power up and enabling. The TLV741P limits the input current to the defined current limit to avoid large currents from flowing from the input power source. This functionality is especially important in battery-operated devices.

The TLV741P is available in standard DBV (SOT-23) and DQN (X2SON) packages. The TLV741P provides an active pulldown circuit to quickly discharge output loads.

Device Information⁽¹⁾

DEVICE NAME	PACKAGE	BODY SIZE
TLV741P	SOT-23 (5)	2.90 mm x 1.60 mm
	X2SON (4)	1.00 mm x 1.00 mm

(1) For all available packages, see the package option addendum at the end of the data sheet.

Typical Application Circuit

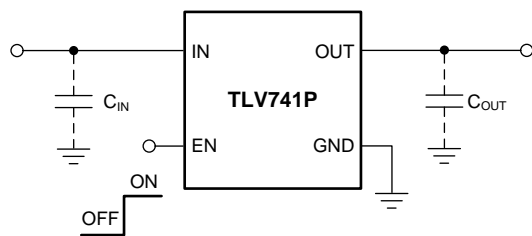

Dropout Voltage vs Output Current



Table of Contents

1 Features	1	8 Application and Implementation	14
2 Applications	1	8.1 Application Information.....	14
3 Description	1	8.2 Typical Application	15
4 Revision History	2	8.3 What to Do and What Not to Do	16
5 Pin Configuration and Functions	3	9 Power Supply Recommendations	17
6 Specifications	4	10 Layout	17
6.1 Absolute Maximum Ratings	4	10.1 Layout Guidelines	17
6.2 ESD Ratings.....	4	10.2 Layout Examples.....	17
6.3 Recommended Operating Conditions.....	4	10.3 Power Dissipation	18
6.4 Thermal Information	4	11 Device and Documentation Support	19
6.5 Electrical Characteristics.....	5	11.1 Documentation Support	19
6.6 Typical Characteristics.....	7	11.2 Receiving Notification of Documentation Updates	19
7 Detailed Description	11	11.3 Community Resources.....	19
7.1 Overview	11	11.4 Trademarks	19
7.2 Functional Block Diagram	11	11.5 Electrostatic Discharge Caution.....	19
7.3 Feature Description.....	12	11.6 Glossary	19
7.4 Device Functional Modes.....	13	12 Mechanical, Packaging, and Orderable Information	19

4 Revision History

Changes from Original (July 2017) to Revision A

Page

• Added DQN (X2SON) package to data sheet.....	1
--	---

5 Pin Configuration and Functions

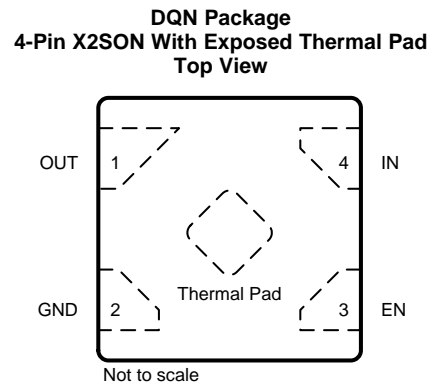
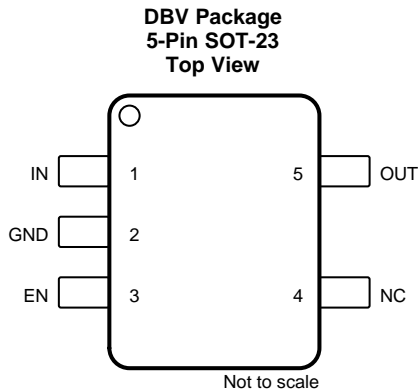

Pin Functions

NAME	PIN		I/O	DESCRIPTION
	NO.			
	SOT-23	X2SON		
EN	3	3	I	Enable pin. Driving EN over 0.9 V turns on the regulator. Driving EN below 0.4 V puts the regulator into shutdown mode.
GND	2	2	—	Ground pin
IN	1	4	I	Input pin. Use a small capacitor from this pin to ground. See the Input and Output Capacitor Considerations section for more details.
NC	4	—	—	No internal connection
OUT	5	1	O	Regulated output voltage pin. For best transient response, use a small 1- μ F ceramic capacitor from this pin to ground. See the Input and Output Capacitor Considerations section for more details.
Thermal pad	—	—	—	The thermal pad is electrically connected to the GND node. Connect the thermal pad to the ground plane for improved thermal performance.

6 Specifications

6.1 Absolute Maximum Ratings

over operating junction temperature range (unless otherwise noted). All voltages are with respect to GND.⁽¹⁾

		MIN	MAX	UNIT
Voltage	Input, V_{IN}	-0.3	6	V
	Enable, V_{EN}	-0.3	$V_{IN} + 0.3$	
	Output, V_{OUT}	-0.3	3.6	
Current	Maximum output, $I_{OUT(max)}$	Internally limited		
Output short-circuit duration		Indefinite		
Total power dissipation	Continuous, $P_{D(tot)}$	See Thermal Information		
Temperature	Junction, T_J	-55	125	°C
	Storage, T_{stg}	-55	150	

- (1) Stresses beyond those listed under *Absolute Maximum Ratings* may cause permanent damage to the device. These are stress ratings only, which do not imply functional operation of the device at these or any other conditions beyond those indicated under *Recommended Operating Conditions*. Exposure to absolute-maximum-rated conditions for extended periods may affect device reliability.

6.2 ESD Ratings

			VALUE	UNIT
$V_{(ESD)}$	Electrostatic discharge	Human body model (HBM), per ANSI/ESDA/JEDEC JS-001, all pins ⁽¹⁾	±2000	V
		Charged device model (CDM), per JEDEC specification JESD22-C101, all pins ⁽²⁾	±500	

- (1) JEDEC document JEP155 states that 500-V HBM allows safe manufacturing with a standard ESD control process.
 (2) JEDEC document JEP157 states that 250-V CDM allows safe manufacturing with a standard ESD control process.

6.3 Recommended Operating Conditions

over operating junction temperature range (unless otherwise noted)

		MIN	NOM	MAX	UNIT
V_{IN}	Input voltage	1.4		5.5	V
V_{EN}	Enable range	0		V_{IN}	V
I_{OUT}	Output current	0		150	mA
C_{IN}	Input capacitor	0	1		µF
C_{OUT}	Output capacitor	1		100	µF
T_J	Operating junction temperature	-40		125	°C

6.4 Thermal Information

THERMAL METRIC ⁽¹⁾		TLV741P		UNIT
		DQN (X2SON)	DBV (SOT-23)	
		4 PINS	5 PINS	
$R_{\theta JA}$	Junction-to-ambient thermal resistance	228.5	249	°C/W
$R_{\theta JC(top)}$	Junction-to-case (top) thermal resistance	210.4	172.7	°C/W
$R_{\theta JB}$	Junction-to-board thermal resistance	174.7	76.7	°C/W
Ψ_{JT}	Junction-to-top characterization parameter	21.2	49.7	°C/W
Ψ_{JB}	Junction-to-board characterization parameter	174.5	75.8	°C/W
$R_{\theta JC(bot)}$	Junction-to-case (bottom) thermal resistance	140.6	N/A	°C/W

- (1) For more information about traditional and new thermal metrics, see the [Semiconductor and IC Package Thermal Metrics application report](#)

6.5 Electrical Characteristics

over operating temperature range $T_J = -40^{\circ}\text{C}$ to $+125^{\circ}\text{C}$, $V_{\text{IN}(\text{nom})} = V_{\text{OUT}(\text{nom})} + 0.5\text{ V}$ or $V_{\text{IN}(\text{nom})} = 2\text{ V}$ (whichever is greater), $I_{\text{OUT}} = 1\text{ mA}$, $V_{\text{EN}} = V_{\text{IN}}$, and $C_{\text{OUT}} = 1\text{ }\mu\text{F}$ (unless otherwise noted). Typical values are at $T_J = 25^{\circ}\text{C}$.

PARAMETER		TEST CONDITIONS		MIN	TYP	MAX	UNIT	
V_{OUT}	Output voltage range			1		3.3	V	
	DC output accuracy	$V_{\text{OUT}} \geq 1.8\text{ V}$ $T_J = 25^{\circ}\text{C}$		-1%		1%		
		$V_{\text{OUT}} < 1.8\text{ V}$ $T_J = 25^{\circ}\text{C}$		-20		20	mV	
		$V_{\text{OUT}} \geq 1.2\text{ V}$ $-40^{\circ}\text{C} \leq T_J \leq 125^{\circ}\text{C}$		-1.5%		1.5%		
		$V_{\text{OUT}} < 1.2\text{ V}$ $-40^{\circ}\text{C} \leq T_J \leq 125^{\circ}\text{C}$		-50		50	mV	
$\Delta V_{\text{OUT}(\Delta V_{\text{IN}})}$	Line regulation	Maximum $\{V_{\text{OUT}(\text{nom})} + 0.5\text{ V}$ $V_{\text{IN}} = 2\text{ V}\} \leq V_{\text{IN}} \leq 5.5\text{ V}$			1	5	mV	
$\Delta V_{\text{OUT}(\Delta I_{\text{OUT}})}$	Load regulation	$0\text{ mA} \leq I_{\text{OUT}} \leq 150\text{ mA}$			10	30	mV	
V_{DO}	Dropout voltage	$V_{\text{OUT}} = 0.98 \times V_{\text{OUT}(\text{nom})}$ $T_J = -40^{\circ}\text{C}$ to 85°C	$1\text{ V} \leq V_{\text{OUT}} < 1.8\text{ V}$ $I_{\text{OUT}} = 150\text{ mA}$		600	900	mV	
			$V_{\text{OUT}} = 1.1\text{ V}$ $I_{\text{OUT}} = 100\text{ mA}$		470	600		
			$1.8\text{ V} \leq V_{\text{OUT}} < 2.1\text{ V}$ $I_{\text{OUT}} = 30\text{ mA}$		70			
			$1.8\text{ V} \leq V_{\text{OUT}} < 2.1\text{ V}$ $I_{\text{OUT}} = 150\text{ mA}$		350	575		
			$2.1\text{ V} \leq V_{\text{OUT}} < 2.5\text{ V}$ $I_{\text{OUT}} = 30\text{ mA}$		90			
			$2.1\text{ V} \leq V_{\text{OUT}} < 2.5\text{ V}$ $I_{\text{OUT}} = 150\text{ mA}$		290	481		
			$2.5\text{ V} \leq V_{\text{OUT}} < 3\text{ V}$ $I_{\text{OUT}} = 30\text{ mA}$		50			
			$2.5\text{ V} \leq V_{\text{OUT}} < 3\text{ V}$ $I_{\text{OUT}} = 150\text{ mA}$		246	445		
		$3\text{ V} \leq V_{\text{OUT}} < 3.6\text{ V}$ $I_{\text{OUT}} = 30\text{ mA}$		46				
		$3\text{ V} \leq V_{\text{OUT}} < 3.6\text{ V}$ $I_{\text{OUT}} = 150\text{ mA}$		230	420			
		$V_{\text{OUT}} = 0.98 \times V_{\text{OUT}(\text{nom})}$ $T_J = -40^{\circ}\text{C}$ to 125°C	$1\text{ V} \leq V_{\text{OUT}} < 1.8\text{ V}$ $I_{\text{OUT}} = 150\text{ mA}$		600	1020		
			$V_{\text{OUT}} = 1.1\text{ V}$ $I_{\text{OUT}} = 100\text{ mA}$		470	720		
			$1.8\text{ V} \leq V_{\text{OUT}} < 2.1\text{ V}$ $I_{\text{OUT}} = 150\text{ mA}$		350	695		
			$2.1\text{ V} \leq V_{\text{OUT}} < 2.5\text{ V}$ $I_{\text{OUT}} = 150\text{ mA}$		290	601		
			$2.5\text{ V} \leq V_{\text{OUT}} < 3\text{ V}$ $I_{\text{OUT}} = 150\text{ mA}$		246	565		
			$3\text{ V} \leq V_{\text{OUT}} < 3.6\text{ V}$ $I_{\text{OUT}} = 150\text{ mA}$		230	540		
I_{GND}	Ground pin current		$I_{\text{OUT}} = 0\text{ mA}$			50	75	μA
I_{SHUTDOWN}	Shutdown current		$V_{\text{EN}} \leq 0.4\text{ V}$, $2\text{ V} \leq V_{\text{IN}} \leq 5.5\text{ V}$ $T_J = 25^{\circ}\text{C}$			0.1	1	μA
PSRR	Power-supply rejection ratio	$V_{\text{IN}} = 3.3\text{ V}$ $V_{\text{OUT}} = 2.8\text{ V}$ $I_{\text{OUT}} = 30\text{ mA}$	$f = 100\text{ Hz}$		70	dB		
			$f = 10\text{ kHz}$		55			
			$f = 1\text{ MHz}$		55			
V_n	Output noise voltage	BW = 100 Hz to 100 kHz $V_{\text{IN}} = 2.3\text{ V}$ $V_{\text{OUT}} = 1.8\text{ V}$ $I_{\text{OUT}} = 10\text{ mA}$			73	μV_{RMS}		
t_{STR}	Start-up time ⁽¹⁾	$C_{\text{OUT}} = 1\text{ }\mu\text{F}$ $I_{\text{OUT}} = 150\text{ mA}$			100	μs		

(1) Start-up time is the time from EN assertion to $(0.98 \times V_{\text{OUT}(\text{nom})})$.

Electrical Characteristics (continued)

over operating temperature range $T_J = -40^{\circ}\text{C}$ to $+125^{\circ}\text{C}$, $V_{\text{IN}(\text{nom})} = V_{\text{OUT}(\text{nom})} + 0.5\text{ V}$ or $V_{\text{IN}(\text{nom})} = 2\text{ V}$ (whichever is greater), $I_{\text{OUT}} = 1\text{ mA}$, $V_{\text{EN}} = V_{\text{IN}}$, and $C_{\text{OUT}} = 1\text{ }\mu\text{F}$ (unless otherwise noted). Typical values are at $T_J = 25^{\circ}\text{C}$.

PARAMETER		TEST CONDITIONS	MIN	TYP	MAX	UNIT
V_{HI}	Enable high (enabled)		0.9		V_{IN}	V
V_{LO}	Enable low (disabled)		0		0.4	V
I_{EN}	EN pin current	$V_{\text{IN}} = 5.5\text{ V}$		0.01		μA
R_{PULLDOWN}	Pulldown resistor	$V_{\text{IN}} = 4\text{ V}$		120		Ω
I_{LIM}	Output current limit	$V_{\text{IN}} = 3.8\text{ V}$ $V_{\text{OUT}} = 3.3\text{ V}$ $T_J = -40\text{ to }85^{\circ}\text{C}$	180			mA
		$V_{\text{IN}} = 2.25\text{ V}$ $V_{\text{OUT}} = 1.8\text{ V}$ $T_J = -40\text{ to }85^{\circ}\text{C}$	180			
		$V_{\text{IN}} = 2\text{ V}$ $V_{\text{OUT}} = 1.2\text{ V}$ $T_J = -40\text{ to }85^{\circ}\text{C}$	180			
I_{SC}	Short-circuit current	$V_{\text{OUT}} = 0\text{ V}$		40		mA
T_{SD}	Thermal shutdown	Shutdown, temperature increasing		158		$^{\circ}\text{C}$
		Reset, temperature decreasing		140		

6.6 Typical Characteristics

over operating temperature range $T_J = -40^{\circ}\text{C}$ to $+125^{\circ}\text{C}$, $V_{IN} = V_{OUT(nom)} + 0.5\text{ V}$ or 2 V (whichever is greater), $I_{OUT} = 10\text{ mA}$, $V_{EN} = V_{IN}$, $C_{OUT} = 1\text{ }\mu\text{F}$, and $V_{OUT(nom)} = 1.8\text{ V}$ (unless otherwise noted). Typical values are at $T_J = 25^{\circ}\text{C}$.

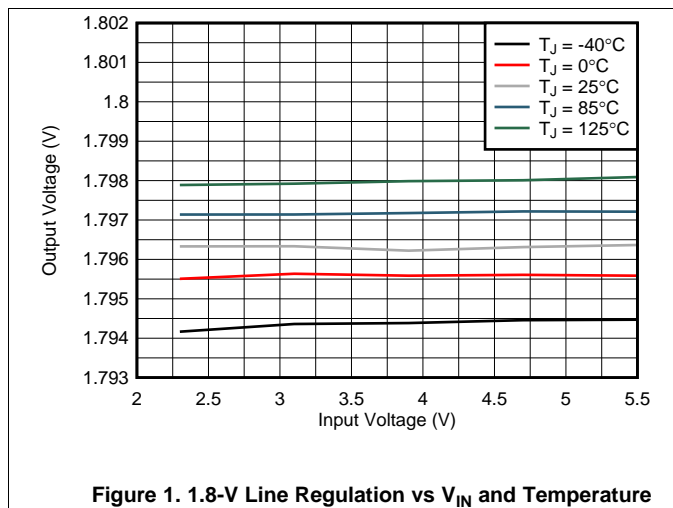

Figure 1. 1.8-V Line Regulation vs V_{IN} and Temperature

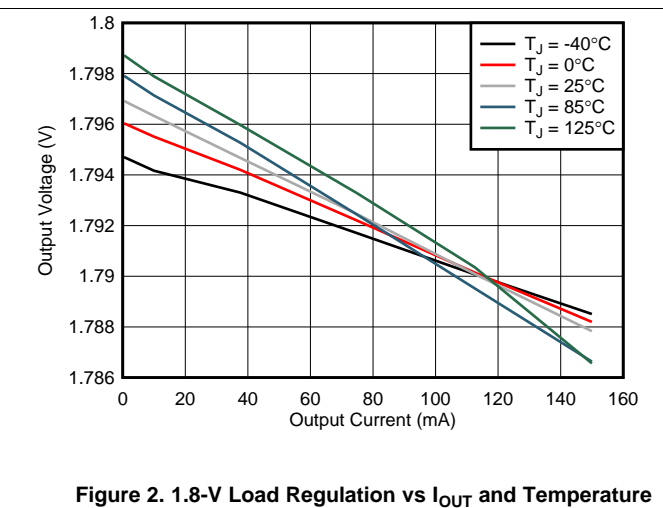

Figure 2. 1.8-V Load Regulation vs I_{OUT} and Temperature

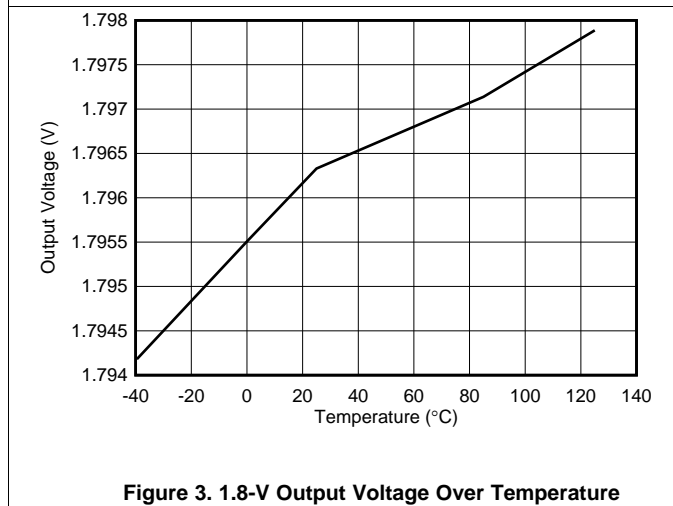

Figure 3. 1.8-V Output Voltage Over Temperature

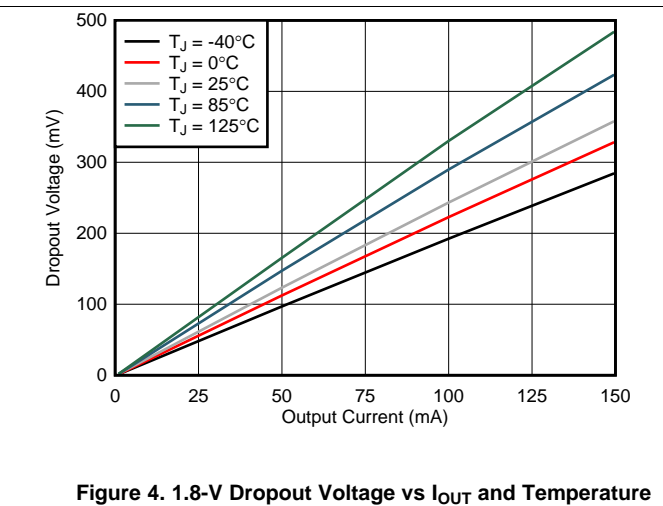

Figure 4. 1.8-V Dropout Voltage vs I_{OUT} and Temperature

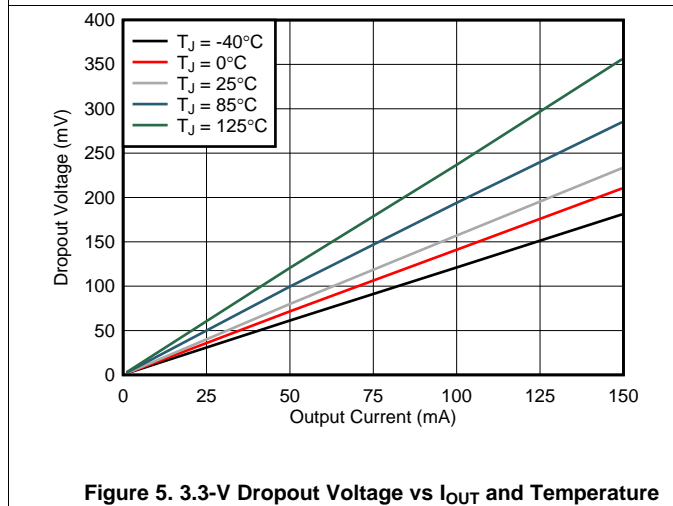

Figure 5. 3.3-V Dropout Voltage vs I_{OUT} and Temperature

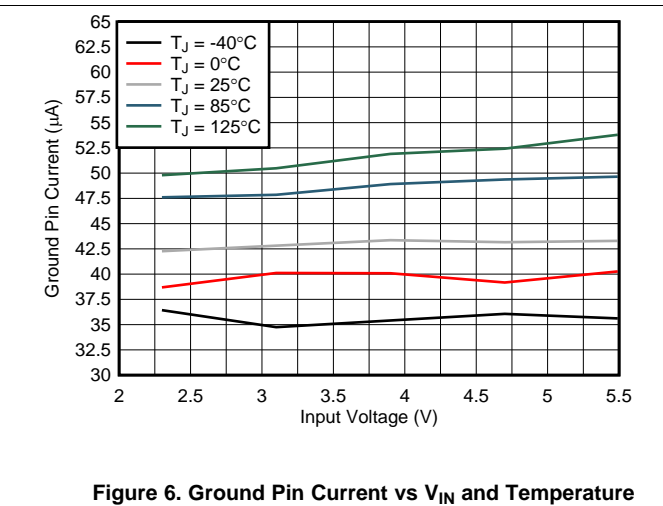

Figure 6. Ground Pin Current vs V_{IN} and Temperature

Typical Characteristics (continued)

over operating temperature range $T_J = -40^{\circ}\text{C}$ to $+125^{\circ}\text{C}$, $V_{IN} = V_{OUT(nom)} + 0.5\text{ V}$ or 2 V (whichever is greater), $I_{OUT} = 10\text{ mA}$, $V_{EN} = V_{IN}$, $C_{OUT} = 1\text{ }\mu\text{F}$, and $V_{OUT(nom)} = 1.8\text{ V}$ (unless otherwise noted). Typical values are at $T_J = 25^{\circ}\text{C}$.



Figure 7. Ground Pin Current vs I_{OUT} and Temperature



Figure 8. Shutdown Current vs V_{IN} and Temperature



Figure 9. Power-Supply Rejection Ratio Over C_{OUT}



Figure 10. Power-Supply Rejection Ratio Over I_{OUT}



Figure 11. Output Spectral Noise Density



Figure 12. Line Transient

Typical Characteristics (continued)

over operating temperature range $T_J = -40^{\circ}\text{C}$ to $+125^{\circ}\text{C}$, $V_{IN} = V_{OUT(nom)} + 0.5\text{ V}$ or 2 V (whichever is greater), $I_{OUT} = 10\text{ mA}$, $V_{EN} = V_{IN}$, $C_{OUT} = 1\text{ }\mu\text{F}$, and $V_{OUT(nom)} = 1.8\text{ V}$ (unless otherwise noted). Typical values are at $T_J = 25^{\circ}\text{C}$.

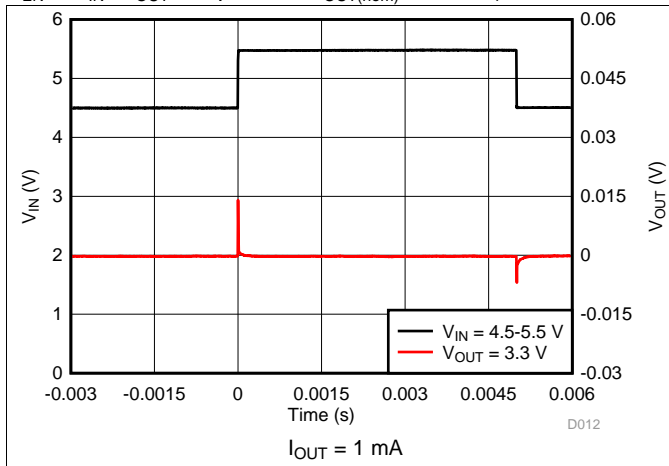

Figure 13. Line Transient



Figure 14. Line Transient

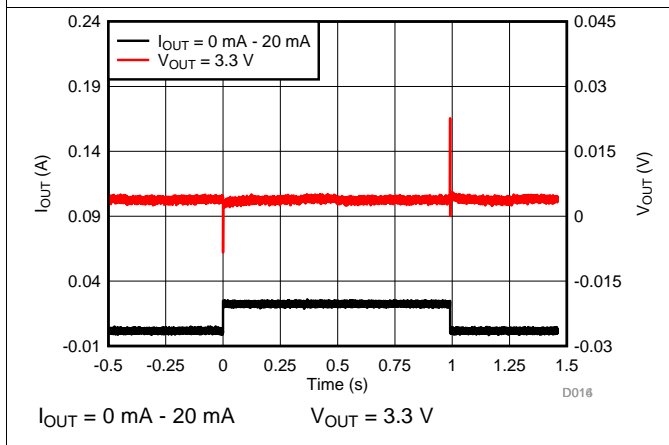

Figure 15. Load Transient

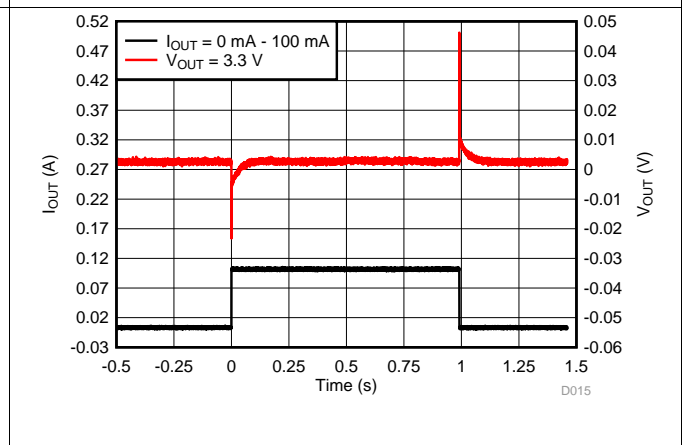

Figure 16. Load Transient

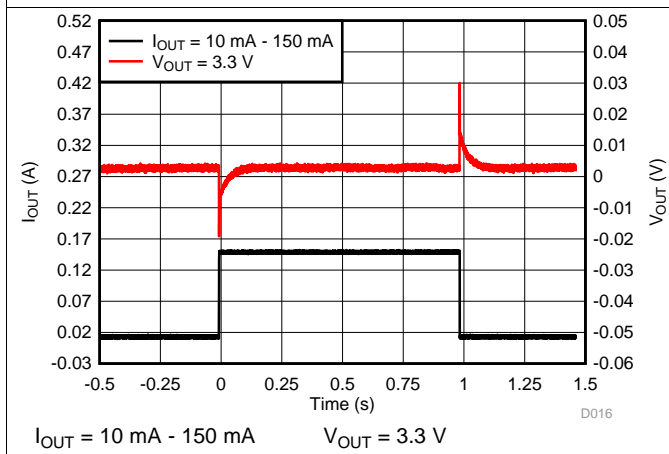

Figure 17. Load Transient



Figure 18. 3.3-V Output Voltage vs Output Current (Foldback Current Limit)

Typical Characteristics (continued)

over operating temperature range $T_J = -40^{\circ}\text{C}$ to $+125^{\circ}\text{C}$, $V_{IN} = V_{OUT(nom)} + 0.5\text{ V}$ or 2 V (whichever is greater), $I_{OUT} = 10\text{ mA}$, $V_{EN} = V_{IN}$, $C_{OUT} = 1\text{ }\mu\text{F}$, and $V_{OUT(nom)} = 1.8\text{ V}$ (unless otherwise noted). Typical values are at $T_J = 25^{\circ}\text{C}$.



Figure 19. 1.8-V Output Voltage vs Output Current (Foldback Current Limit)

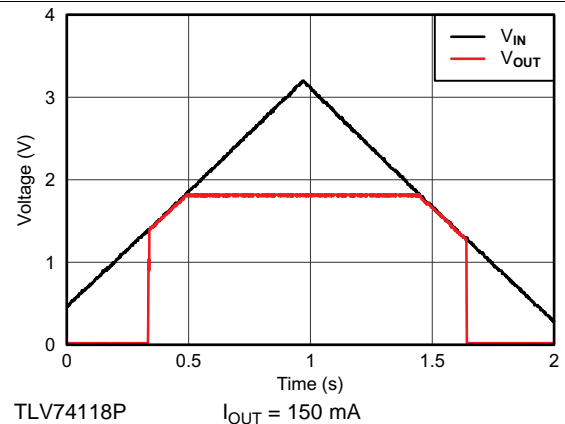

Figure 20. V_{IN} Power-Up and Power-Down



Figure 21. Start-Up With EN

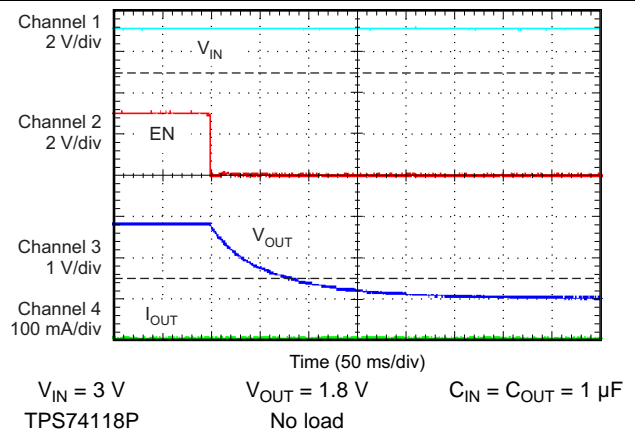

Figure 22. Shutdown Response With Enable

7 Detailed Description

7.1 Overview

The TLV741P belongs to a new family of next-generation value low-dropout (LDO) regulators. The TLV741P consumes low quiescent current and delivers excellent line and load transient performance. These characteristics, combined with low noise, very good PSRR with little ($V_{IN} - V_{OUT}$) headroom makes the device suitable for RF portable applications.

This regulator offers current limit and thermal protection. Device operating junction temperature is -40°C to $+125^{\circ}\text{C}$.

7.2 Functional Block Diagram



7.3 Feature Description

7.3.1 Undervoltage Lockout (UVLO)

The TLV741P uses a UVLO circuit that disables the output until the input voltage is greater than the rising UVLO voltage. The circuit makes sure that the device does not exhibit any unpredictable behavior when the supply voltage is lower than the operational range of the internal circuitry, $V_{IN(min)}$. During UVLO disable, the output of the TLV741P version is connected to ground with a 120- Ω pulldown resistor.

7.3.2 Shutdown

The enable pin (EN) is active high. Enable the device by forcing the EN pin to exceed $V_{EN(high)}$ (0.9 V, minimum). Turn off the device by forcing the EN pin to drop below 0.4 V. If shutdown capability is not required, connect EN to IN.

The TLV741P has an internal pulldown MOSFET that connects a 120- Ω resistor to ground when the device is disabled. The discharge time after disabling depends on the output capacitance (C_{OUT}) and the load resistance (R_L) in parallel with the 120- Ω pulldown resistor. The time constant is calculated in [Equation 1](#).

$$\tau = \frac{120 \cdot R_L}{120 + R_L} \cdot C_{OUT} \quad (1)$$

7.3.3 Foldback Current Limit

The TLV741P has an internal foldback current limit that helps protect the regulator during fault conditions. The current supplied by the device is gradually reduced while the output voltage decreases. When the output shorts, the LDO supplies a typical current of 40 mA. Output voltage is not regulated when the device is in current limit, and is calculated by [Equation 2](#):

$$V_{OUT} = I_{LIMIT} \times R_{LOAD} \quad (2)$$

The PMOS pass transistor dissipates $[(V_{IN} - V_{OUT}) \times I_{LIMIT}]$ until thermal shutdown is triggered and the device turns off. The internal thermal shutdown circuit turns on the device during cool down. If the fault condition continues, the device cycles between current limit and thermal shutdown. See [Thermal Protection](#) for more details.

The TLV741P PMOS pass element has a built-in body diode that conducts current when the voltage at OUT exceeds the voltage at IN. This current is not limited, so if extended reverse voltage operation is anticipated, TI recommends externally limiting the rated output current to 5%.

7.3.4 Thermal Protection

Thermal protection disables the output when the junction temperature rises to approximately 158°C, allowing the device to cool. When the junction temperature cools to approximately 140°C, the output circuitry is again enabled. Depending on power dissipation, thermal resistance, and ambient temperature, the thermal protection circuit may cycle on and off. This cycling limits regulator dissipation, which protects the device from damage as a result of overheating.

Any tendency to activate the thermal protection circuit indicates excessive power dissipation or an inadequate heat sink. For reliable operation, junction temperature must be limited to 125°C maximum. To estimate the margin of safety in a complete design (including heat sink), increase the ambient temperature until the thermal protection is triggered; use worst-case loads and signal conditions.

The TLV741P internal protection circuitry is designed to protect against overload conditions. This circuitry is not intended to replace proper heat sinking. Continuously running the TLV741P into thermal shutdown degrades device reliability.

7.4 Device Functional Modes

7.4.1 Normal Operation

The device regulates to the nominal output voltage under the following conditions:

- The input voltage is at least as high as $V_{IN(min)}$.
- The input voltage is greater than the nominal output voltage added to the dropout voltage.
- The enable voltage has previously exceeded the enable rising threshold voltage and has not decreased below the enable falling threshold.
- The output current is less than the current limit.
- The device junction temperature is less than the maximum specified junction temperature.

7.4.2 Dropout Operation

If the input voltage is lower than the nominal output voltage plus the specified dropout voltage, but all other conditions are met for normal operation, the device operates in dropout mode. In this mode of operation, the output voltage is the same as the input voltage minus the dropout voltage. The transient performance of the device is significantly degraded because the pass device is in the linear region and no longer controls the current through the LDO. Line or load transients in dropout can result in large output voltage deviations.

7.4.3 Disabled

The device is disabled under the following conditions:

- The enable voltage is less than the enable falling threshold voltage or has not yet exceeded the enable rising threshold.
- The device junction temperature is greater than the thermal shutdown temperature.

[Table 1](#) lists conditions that result in different operating modes.

Table 1. Device Functional Mode Comparison

OPERATING MODE	PARAMETER			
	V_{IN}	V_{EN}	I_{OUT}	T_J
Normal mode	$V_{IN} > V_{OUT(nom)} + V_{DO}$ and $V_{IN} > V_{IN(min)}$	$V_{EN} > V_{EN(high)}$	$I_{OUT} < I_{LIM}$	$T_J < 125^{\circ}C$
Dropout mode	$V_{IN(min)} < V_{IN} < V_{OUT(nom)} + V_{DO}$	$V_{EN} > V_{EN(high)}$	—	$T_J < 125^{\circ}C$
Disabled mode (any true condition disables the device)	—	$V_{EN} < V_{EN(low)}$	—	$T_J > 158^{\circ}C$

8 Application and Implementation

NOTE

Information in the following applications sections is not part of the TI component specification, and TI does not warrant its accuracy or completeness. TI's customers are responsible for determining suitability of components for their purposes. Customers should validate and test their design implementation to confirm system functionality.

8.1 Application Information

8.1.1 Input and Output Capacitor Considerations

The TLV741P uses an advanced internal control loop to obtain stable operation by using an input or output capacitor. An output capacitance of 1 μF or larger generally provides good dynamic response. TI recommends using X5R- and X7R-type ceramic capacitors because these capacitors have minimal variation in value and equivalent series resistance (ESR) over temperature.

Although an input capacitor is not required for stability, it is good analog design practice to connect a 0.1- μF to 1- μF capacitor from IN to GND. This capacitor counteracts reactive input sources and improves transient response, input ripple, and PSRR. TI recommends using an input capacitor if the source impedance is more than 0.5 Ω . A higher-value capacitor may be necessary if large, fast, rise-time load transients are anticipated or if the device is located several inches from the input power source.

8.1.2 Dropout Voltage

The TLV741P uses a PMOS pass transistor to achieve low dropout. When $(V_{\text{IN}} - V_{\text{OUT}})$ is less than the dropout voltage (V_{DO}), the PMOS pass device is in the linear region of operation and the input-to-output resistance is the $R_{\text{DS(on)}}$ of the PMOS pass element. V_{DO} scales approximately with output current because the PMOS device behaves like a resistor in dropout. As with any linear regulator, PSRR and transient response are degraded as $(V_{\text{IN}} - V_{\text{OUT}})$ approaches dropout.

8.1.3 Transient Response

As with any regulator, increasing the size of the output capacitor reduces over- and undershoot magnitude but increases the duration of the transient response.

8.2 Typical Application

Several versions of the TLV741P are suitable for powering the [MSP430 microcontroller](#).

[Figure 23](#) shows a diagram of the TLV741P powering an MSP430 microcontroller. [Table 2](#) lists potential applications of some voltage versions.



Figure 23. TLV741P Powering a Microcontroller

Table 2. Typical MSP430 Applications

DEVICE	V _{OUT} (TYPICAL)	APPLICATION
TLV741P18P	1.8 V	Allows for lowest power consumption with many MSP430s
TLV741P25P	2.5 V	2.2-V supply required by many MSP430s for flash programming and erasing

8.2.1 Design Requirements

[Table 3](#) lists the design requirements.

Table 3. Design Parameters

PARAMETER	DESIGN REQUIREMENT
Input voltage	4.2 V to 3 V (Lithium Ion battery)
Output voltage	1.8 V, ±1%
DC output current	10 mA
Peak output current	75 mA
Maximum ambient temperature	65°C

8.2.2 Detailed Design Procedure

An input capacitor is not required for this design because of the low impedance connection directly to the battery.

A small output capacitor allows for the minimal possible inrush current during start-up, and makes sure that the 180-mA maximum input current limit is not exceeded.

See [Figure 29](#) to verify that the maximum junction temperature is not exceeded.

8.2.3 Application Curves



8.3 What to Do and What Not to Do

Place at least one 1- μ F ceramic capacitor as close as possible to the OUT pin of the regulator for best transient performance.

Place at least one 1- μ F capacitor as close as possible to the IN pin for best transient performance.

Do not place the output capacitor more than 10 mm away from the regulator.

Do not exceed the absolute maximum ratings.

Do not continuously operate the device in current limit or near thermal shutdown.

9 Power Supply Recommendations

This device is designed to operate from an input voltage supply range from 1.4 V to 5.5 V. The input voltage range must provide adequate headroom for the device to have a regulated output. This input supply must be well-regulated and stable. If the input supply is noisy, additional input capacitors with low ESR can help improve the output noise performance.

10 Layout

10.1 Layout Guidelines

10.1.1 Board Layout Recommendations to Improve PSRR and Noise Performance

Input and output capacitors must be placed as close to the device pins as possible. To improve AC performance (such as PSRR, output noise, and transient response), TI recommends that the board be designed with separate ground planes for V_{IN} and V_{OUT} , with the ground plane connected only at the device GND pin. In addition, the output capacitor ground connection must be connected directly to the device GND pin. High-ESR capacitors may degrade PSRR performance.

10.2 Layout Examples



● Represents via used for application-specific connections

(1) Not required.

Figure 27. X2SON Layout Example



● Represents via used for application-specific connections

Figure 28. SOT-23 Layout Example

10.3 Power Dissipation

The ability to remove heat from the die is different for each package type, presenting different considerations in the printed-circuit-board (PCB) layout. The PCB area around the device that is free of other components moves the heat from the device to the ambient air. Performance data for JEDEC low- and high-K boards are given in [Thermal Information](#). Using heavier copper increases the effectiveness in removing heat from the device. The addition of plated through-holes to heat-dissipating layers also improves the heat sink effectiveness.

Power dissipation depends on input voltage and load conditions. Power dissipation (P_D) can be approximated by the product of the output current times the voltage drop across the output pass element (V_{IN} to V_{OUT}), as shown in [Equation 3](#):

$$P_D = (V_{IN} - V_{OUT}) \times I_{OUT} \tag{3}$$

[Figure 29](#) shows the maximum ambient temperature versus the power dissipation of the TLV741P. This figure assumes the device is soldered on a JEDEC standard, high-K layout with no airflow over the board. Actual board thermal impedances vary widely. If the application requires high power dissipation, having a thorough understanding of the board temperature and thermal impedances is helpful to make sure the TLV741P does not operate above a junction temperature of 125°C.



Figure 29. Maximum Ambient Temperature vs Device Power Dissipation

Estimate junction temperature by using the Ψ_{JT} and Ψ_{JB} thermal metrics, shown in [Thermal Information](#). These metrics are a more accurate representation of the heat transfer characteristics of the die and the package than $R_{\theta JA}$. The junction temperature can be estimated with [Equation 4](#):

$$\Psi_{JT}: T_J = T_T + \Psi_{JT} \cdot P_D$$

$$\Psi_{JB}: T_J = T_B + \Psi_{JB} \cdot P_D$$

where

- P_D is the power dissipation shown by [Equation 3](#),
- T_T is the temperature at the center-top of the device package,
- T_B is the PCB temperature measured 1 mm away from the device package on the PCB surface. (4)

NOTE

Both T_T and T_B can be measured on actual application boards using a thermogun (an infrared thermometer).

For more information about measuring T_T and T_B , see [Using New Thermal Metrics](#), available for download at www.ti.com.

11 Device and Documentation Support

11.1 Documentation Support

11.1.1 Related Documentation

For related documentation see the following:

[Universal Low-Dropout \(LDO\) Linear Voltage Regulator EVM User's Guide](#)

11.2 Receiving Notification of Documentation Updates

To receive notification of documentation updates, navigate to the device product folder on ti.com. In the upper right corner, click on *Alert me* to register and receive a weekly digest of any product information that has changed. For change details, review the revision history included in any revised document.

11.3 Community Resources

The following links connect to TI community resources. Linked contents are provided "AS IS" by the respective contributors. They do not constitute TI specifications and do not necessarily reflect TI's views; see TI's [Terms of Use](#).

TI E2E™ Online Community *TI's Engineer-to-Engineer (E2E) Community*. Created to foster collaboration among engineers. At e2e.ti.com, you can ask questions, share knowledge, explore ideas and help solve problems with fellow engineers.

Design Support *TI's Design Support* Quickly find helpful E2E forums along with design support tools and contact information for technical support.

11.4 Trademarks

E2E is a trademark of Texas Instruments.
All other trademarks are the property of their respective owners.

11.5 Electrostatic Discharge Caution



This integrated circuit can be damaged by ESD. Texas Instruments recommends that all integrated circuits be handled with appropriate precautions. Failure to observe proper handling and installation procedures can cause damage.

ESD damage can range from subtle performance degradation to complete device failure. Precision integrated circuits may be more susceptible to damage because very small parametric changes could cause the device not to meet its published specifications.

11.6 Glossary

[SLYZ022](#) — *TI Glossary*.

This glossary lists and explains terms, acronyms, and definitions.

12 Mechanical, Packaging, and Orderable Information

The following pages include mechanical, packaging, and orderable information. This information is the most current data available for the designated devices. This data is subject to change without notice and revision of this document. For browser-based versions of this data sheet, refer to the left-hand navigation.

PACKAGING INFORMATION

Orderable part number	Status (1)	Material type (2)	Package Pins	Package qty Carrier	RoHS (3)	Lead finish/ Ball material (4)	MSL rating/ Peak reflow (5)	Op temp (°C)	Part marking (6)
TLV741105PDBVR	Active	Production	SOT-23 (DBV) 5	3000 LARGE T&R	Yes	NIPDAU SN	Level-1-260C-UNLIM	-40 to 125	1NFT
TLV741105PDBVR.A	Active	Production	SOT-23 (DBV) 5	3000 LARGE T&R	Yes	SN	Level-1-260C-UNLIM	-40 to 125	1NFT
TLV74110PDBVR	Active	Production	SOT-23 (DBV) 5	3000 LARGE T&R	Yes	NIPDAU SN	Level-1-260C-UNLIM	-40 to 125	1C9T
TLV74110PDBVR.A	Active	Production	SOT-23 (DBV) 5	3000 LARGE T&R	Yes	SN	Level-1-260C-UNLIM	-40 to 125	1C9T
TLV74110PDQNR	Active	Production	X2SON (DQN) 4	3000 LARGE T&R	Yes	NIPDAU	Level-1-260C-UNLIM	-40 to 125	8T
TLV74110PDQNR.B	Active	Production	X2SON (DQN) 4	3000 LARGE T&R	Yes	NIPDAU	Level-1-260C-UNLIM	-40 to 125	8T
TLV74111PDBVR	Active	Production	SOT-23 (DBV) 5	3000 LARGE T&R	Yes	NIPDAU SN	Level-1-260C-UNLIM	-40 to 125	1DHT
TLV74111PDBVR.A	Active	Production	SOT-23 (DBV) 5	3000 LARGE T&R	Yes	NIPDAU	Level-1-260C-UNLIM	-40 to 125	1DHT
TLV74111PDQNR	Active	Production	X2SON (DQN) 4	3000 LARGE T&R	Yes	NIPDAU	Level-1-260C-UNLIM	-40 to 125	8R
TLV74111PDQNR.B	Active	Production	X2SON (DQN) 4	3000 LARGE T&R	Yes	NIPDAU	Level-1-260C-UNLIM	-40 to 125	8R
TLV74112PDBVR	Active	Production	SOT-23 (DBV) 5	3000 LARGE T&R	Yes	NIPDAU SN	Level-1-260C-UNLIM	-40 to 125	1DIT
TLV74112PDBVR.A	Active	Production	SOT-23 (DBV) 5	3000 LARGE T&R	Yes	NIPDAU	Level-1-260C-UNLIM	-40 to 125	1DIT
TLV74112PDQNR	Active	Production	X2SON (DQN) 4	3000 LARGE T&R	Yes	NIPDAU	Level-1-260C-UNLIM	-40 to 125	8Q
TLV74112PDQNR.B	Active	Production	X2SON (DQN) 4	3000 LARGE T&R	Yes	NIPDAU	Level-1-260C-UNLIM	-40 to 125	8Q
TLV74115PDBVR	Active	Production	SOT-23 (DBV) 5	3000 LARGE T&R	Yes	Call TI Sn Nipdau	Level-1-260C-UNLIM	-40 to 125	1DJT
TLV74115PDBVR.A	Active	Production	SOT-23 (DBV) 5	3000 LARGE T&R	Yes	NIPDAU	Level-1-260C-UNLIM	-40 to 125	1DJT
TLV74115PDQNR	Active	Production	X2SON (DQN) 4	3000 LARGE T&R	Yes	NIPDAU	Level-1-260C-UNLIM	-40 to 125	8P
TLV74115PDQNR.B	Active	Production	X2SON (DQN) 4	3000 LARGE T&R	Yes	NIPDAU	Level-1-260C-UNLIM	-40 to 125	8P
TLV74118PDBVR	Active	Production	SOT-23 (DBV) 5	3000 LARGE T&R	Yes	Call TI Sn Nipdau	Level-1-260C-UNLIM	-40 to 125	1DKT
TLV74118PDBVR.A	Active	Production	SOT-23 (DBV) 5	3000 LARGE T&R	Yes	NIPDAU	Level-1-260C-UNLIM	-40 to 125	1DKT
TLV74118PDQNR	Active	Production	X2SON (DQN) 4	3000 LARGE T&R	Yes	NIPDAU	Level-1-260C-UNLIM	-40 to 125	8O
TLV74118PDQNR.B	Active	Production	X2SON (DQN) 4	3000 LARGE T&R	Yes	NIPDAU	Level-1-260C-UNLIM	-40 to 125	8O
TLV74125PDBVR	Active	Production	SOT-23 (DBV) 5	3000 LARGE T&R	Yes	Call TI Sn Nipdau	Level-1-260C-UNLIM	-40 to 125	1DLT
TLV74125PDBVR.A	Active	Production	SOT-23 (DBV) 5	3000 LARGE T&R	Yes	NIPDAU	Level-1-260C-UNLIM	-40 to 125	1DLT
TLV74125PDQNR	Active	Production	X2SON (DQN) 4	3000 LARGE T&R	Yes	NIPDAU	Level-1-260C-UNLIM	-40 to 125	8N
TLV74125PDQNR.B	Active	Production	X2SON (DQN) 4	3000 LARGE T&R	Yes	NIPDAU	Level-1-260C-UNLIM	-40 to 125	8N
TLV741285PDBVR	Active	Production	SOT-23 (DBV) 5	3000 LARGE T&R	Yes	Call TI Sn Nipdau	Level-1-260C-UNLIM	-40 to 125	1DMT
TLV741285PDBVR.A	Active	Production	SOT-23 (DBV) 5	3000 LARGE T&R	Yes	Call TI	Level-1-260C-UNLIM	-40 to 125	1DMT
TLV741285PDQNR	Active	Production	X2SON (DQN) 4	3000 LARGE T&R	Yes	NIPDAU	Level-1-260C-UNLIM	-40 to 125	8M

Orderable part number	Status (1)	Material type (2)	Package Pins	Package qty Carrier	RoHS (3)	Lead finish/ Ball material (4)	MSL rating/ Peak reflow (5)	Op temp (°C)	Part marking (6)
TLV741285PDQNR.B	Active	Production	X2SON (DQN) 4	3000 LARGE T&R	Yes	NIPDAU	Level-1-260C-UNLIM	-40 to 125	8M
TLV74128PDBVR	Active	Production	SOT-23 (DBV) 5	3000 LARGE T&R	Yes	Call TI Sn Nipdau	Level-1-260C-UNLIM	-40 to 125	1DNT
TLV74128PDBVR.A	Active	Production	SOT-23 (DBV) 5	3000 LARGE T&R	Yes	NIPDAU	Level-1-260C-UNLIM	-40 to 125	1DNT
TLV74128PDQNR	Active	Production	X2SON (DQN) 4	3000 LARGE T&R	Yes	NIPDAU	Level-1-260C-UNLIM	-40 to 125	8L
TLV74128PDQNR.B	Active	Production	X2SON (DQN) 4	3000 LARGE T&R	Yes	NIPDAU	Level-1-260C-UNLIM	-40 to 125	8L
TLV74130PDBVR	Active	Production	SOT-23 (DBV) 5	3000 LARGE T&R	Yes	Call TI Sn Nipdau	Level-1-260C-UNLIM	-40 to 125	1DOT
TLV74130PDBVR.A	Active	Production	SOT-23 (DBV) 5	3000 LARGE T&R	Yes	NIPDAU	Level-1-260C-UNLIM	-40 to 125	1DOT
TLV74130PDQNR	Active	Production	X2SON (DQN) 4	3000 LARGE T&R	Yes	NIPDAU	Level-1-260C-UNLIM	-40 to 125	8K
TLV74130PDQNR.B	Active	Production	X2SON (DQN) 4	3000 LARGE T&R	Yes	NIPDAU	Level-1-260C-UNLIM	-40 to 125	8K
TLV74133PDBVR	Active	Production	SOT-23 (DBV) 5	3000 LARGE T&R	Yes	Call TI Sn Nipdau	Level-1-260C-UNLIM	-40 to 125	1CAT
TLV74133PDBVR.A	Active	Production	SOT-23 (DBV) 5	3000 LARGE T&R	Yes	Call TI	Level-1-260C-UNLIM	-40 to 125	1CAT
TLV74133PDQNR	Active	Production	X2SON (DQN) 4	3000 LARGE T&R	Yes	NIPDAU	Level-1-260C-UNLIM	-40 to 125	8J
TLV74133PDQNR.B	Active	Production	X2SON (DQN) 4	3000 LARGE T&R	Yes	NIPDAU	Level-1-260C-UNLIM	-40 to 125	8J

⁽¹⁾ **Status:** For more details on status, see our [product life cycle](#).

⁽²⁾ **Material type:** When designated, preproduction parts are prototypes/experimental devices, and are not yet approved or released for full production. Testing and final process, including without limitation quality assurance, reliability performance testing, and/or process qualification, may not yet be complete, and this item is subject to further changes or possible discontinuation. If available for ordering, purchases will be subject to an additional waiver at checkout, and are intended for early internal evaluation purposes only. These items are sold without warranties of any kind.

⁽³⁾ **RoHS values:** Yes, No, RoHS Exempt. See the [TI RoHS Statement](#) for additional information and value definition.

⁽⁴⁾ **Lead finish/Ball material:** Parts may have multiple material finish options. Finish options are separated by a vertical ruled line. Lead finish/Ball material values may wrap to two lines if the finish value exceeds the maximum column width.

⁽⁵⁾ **MSL rating/Peak reflow:** The moisture sensitivity level ratings and peak solder (reflow) temperatures. In the event that a part has multiple moisture sensitivity ratings, only the lowest level per JEDEC standards is shown. Refer to the shipping label for the actual reflow temperature that will be used to mount the part to the printed circuit board.

⁽⁶⁾ **Part marking:** There may be an additional marking, which relates to the logo, the lot trace code information, or the environmental category of the part.

Multiple part markings will be inside parentheses. Only one part marking contained in parentheses and separated by a "-" will appear on a part. If a line is indented then it is a continuation of the previous line and the two combined represent the entire part marking for that device.

Important Information and Disclaimer: The information provided on this page represents TI's knowledge and belief as of the date that it is provided. TI bases its knowledge and belief on information provided by third parties, and makes no representation or warranty as to the accuracy of such information. Efforts are underway to better integrate information from third parties. TI has taken and continues to take reasonable steps to provide representative and accurate information but may not have conducted destructive testing or chemical analysis on incoming materials and chemicals. TI and TI suppliers consider certain information to be proprietary, and thus CAS numbers and other limited information may not be available for release.

In no event shall TI's liability arising out of such information exceed the total purchase price of the TI part(s) at issue in this document sold by TI to Customer on an annual basis.

TAPE AND REEL INFORMATION

QUADRANT ASSIGNMENTS FOR PIN 1 ORIENTATION IN TAPE

*All dimensions are nominal

Device	Package Type	Package Drawing	Pins	SPQ	Reel Diameter (mm)	Reel Width W1 (mm)	A0 (mm)	B0 (mm)	K0 (mm)	P1 (mm)	W (mm)	Pin1 Quadrant
TLV741105PDBVR	SOT-23	DBV	5	3000	180.0	8.4	3.2	3.2	1.4	4.0	8.0	Q3
TLV74110PDBVR	SOT-23	DBV	5	3000	180.0	8.4	3.2	3.2	1.4	4.0	8.0	Q3
TLV74110PDQNR	X2SON	DQN	4	3000	180.0	8.4	1.16	1.16	0.5	4.0	8.0	Q2
TLV74111PDBVR	SOT-23	DBV	5	3000	180.0	8.4	3.2	3.2	1.4	4.0	8.0	Q3
TLV74111PDQNR	X2SON	DQN	4	3000	180.0	8.4	1.16	1.16	0.5	4.0	8.0	Q2
TLV74112PDBVR	SOT-23	DBV	5	3000	180.0	8.4	3.2	3.2	1.4	4.0	8.0	Q3
TLV74112PDQNR	X2SON	DQN	4	3000	180.0	8.4	1.16	1.16	0.5	4.0	8.0	Q2
TLV74115PDBVR	SOT-23	DBV	5	3000	180.0	8.4	3.2	3.2	1.4	4.0	8.0	Q3
TLV74115PDQNR	X2SON	DQN	4	3000	180.0	8.4	1.16	1.16	0.5	4.0	8.0	Q2
TLV74118PDBVR	SOT-23	DBV	5	3000	178.0	8.4	3.2	3.2	1.4	4.0	8.0	Q3
TLV74118PDQNR	X2SON	DQN	4	3000	180.0	8.4	1.16	1.16	0.5	4.0	8.0	Q2
TLV74125PDBVR	SOT-23	DBV	5	3000	178.0	8.4	3.2	3.2	1.4	4.0	8.0	Q3
TLV74125PDQNR	X2SON	DQN	4	3000	180.0	8.4	1.16	1.16	0.5	4.0	8.0	Q2
TLV741285PDBVR	SOT-23	DBV	5	3000	180.0	8.4	3.2	3.2	1.4	4.0	8.0	Q3
TLV741285PDQNR	X2SON	DQN	4	3000	180.0	8.4	1.16	1.16	0.5	4.0	8.0	Q2
TLV74128PDBVR	SOT-23	DBV	5	3000	180.0	8.4	3.2	3.2	1.4	4.0	8.0	Q3

Device	Package Type	Package Drawing	Pins	SPQ	Reel Diameter (mm)	Reel Width W1 (mm)	A0 (mm)	B0 (mm)	K0 (mm)	P1 (mm)	W (mm)	Pin1 Quadrant
TLV74128PDQNR	X2SON	DQN	4	3000	180.0	8.4	1.16	1.16	0.5	4.0	8.0	Q2
TLV74130PDBVR	SOT-23	DBV	5	3000	180.0	8.4	3.2	3.2	1.4	4.0	8.0	Q3
TLV74130PDQNR	X2SON	DQN	4	3000	180.0	8.4	1.16	1.16	0.5	4.0	8.0	Q2
TLV74133PDBVR	SOT-23	DBV	5	3000	178.0	8.4	3.2	3.2	1.4	4.0	8.0	Q3
TLV74133PDQNR	X2SON	DQN	4	3000	180.0	8.4	1.16	1.16	0.5	4.0	8.0	Q2

TAPE AND REEL BOX DIMENSIONS

*All dimensions are nominal

Device	Package Type	Package Drawing	Pins	SPQ	Length (mm)	Width (mm)	Height (mm)
TLV741105PDBVR	SOT-23	DBV	5	3000	210.0	185.0	35.0
TLV741110PDBVR	SOT-23	DBV	5	3000	210.0	185.0	35.0
TLV741110PDQNR	X2SON	DQN	4	3000	210.0	185.0	35.0
TLV741111PDBVR	SOT-23	DBV	5	3000	210.0	185.0	35.0
TLV741111PDQNR	X2SON	DQN	4	3000	210.0	185.0	35.0
TLV741112PDBVR	SOT-23	DBV	5	3000	210.0	185.0	35.0
TLV741112PDQNR	X2SON	DQN	4	3000	210.0	185.0	35.0
TLV741115PDBVR	SOT-23	DBV	5	3000	210.0	185.0	35.0
TLV741115PDQNR	X2SON	DQN	4	3000	210.0	185.0	35.0
TLV741118PDBVR	SOT-23	DBV	5	3000	208.0	191.0	35.0
TLV741118PDQNR	X2SON	DQN	4	3000	210.0	185.0	35.0
TLV74125PDBVR	SOT-23	DBV	5	3000	208.0	191.0	35.0
TLV74125PDQNR	X2SON	DQN	4	3000	210.0	185.0	35.0
TLV741285PDBVR	SOT-23	DBV	5	3000	210.0	185.0	35.0
TLV741285PDQNR	X2SON	DQN	4	3000	210.0	185.0	35.0
TLV74128PDBVR	SOT-23	DBV	5	3000	210.0	185.0	35.0
TLV74128PDQNR	X2SON	DQN	4	3000	210.0	185.0	35.0
TLV74130PDBVR	SOT-23	DBV	5	3000	210.0	185.0	35.0

Device	Package Type	Package Drawing	Pins	SPQ	Length (mm)	Width (mm)	Height (mm)
TLV74130PDQNR	X2SON	DQN	4	3000	210.0	185.0	35.0
TLV74133PDBVR	SOT-23	DBV	5	3000	208.0	191.0	35.0
TLV74133PDQNR	X2SON	DQN	4	3000	210.0	185.0	35.0

EXAMPLE BOARD LAYOUT

DBV0005A

SOT-23 - 1.45 mm max height

SMALL OUTLINE TRANSISTOR



LAND PATTERN EXAMPLE
EXPOSED METAL SHOWN
SCALE:15X



SOLDER MASK DETAILS

4214839/K 08/2024

NOTES: (continued)

- 6. Publication IPC-7351 may have alternate designs.
- 7. Solder mask tolerances between and around signal pads can vary based on board fabrication site.

EXAMPLE STENCIL DESIGN

DBV0005A

SOT-23 - 1.45 mm max height

SMALL OUTLINE TRANSISTOR



SOLDER PASTE EXAMPLE
BASED ON 0.125 mm THICK STENCIL
SCALE:15X

4214839/K 08/2024

NOTES: (continued)

8. Laser cutting apertures with trapezoidal walls and rounded corners may offer better paste release. IPC-7525 may have alternate design recommendations.
9. Board assembly site may have different recommendations for stencil design.

GENERIC PACKAGE VIEW

DQN 4

X2SON - 0.4 mm max height

PLASTIC SMALL OUTLINE - NO LEAD



Images above are just a representation of the package family, actual package may vary.
Refer to the product data sheet for package details.

4210367/F



LAND PATTERN EXAMPLE
SCALE: 40X



SOLDER MASK DETAIL

4215302/E 12/2016

NOTES: (continued)

7. This package is designed to be soldered to a thermal pad on the board. For more information, see Texas Instruments literature number SLUA271 (www.ti.com/lit/sluea271).
8. If any vias are implemented, it is recommended that vias under paste be filled, plugged or tented.



SOLDER PASTE EXAMPLE
 BASED ON 0.075 - 0.1mm THICK STENCIL
 EXPOSED PAD
 88% PRINTED SOLDER COVERAGE BY AREA
 SCALE: 60X

4215302/E 12/2016

NOTES: (continued)

- 9. Laser cutting apertures with trapezoidal walls and rounded corners may offer better paste release. IPC-7525 may have alternate design recommendations.

IMPORTANT NOTICE AND DISCLAIMER

TI PROVIDES TECHNICAL AND RELIABILITY DATA (INCLUDING DATASHEETS), DESIGN RESOURCES (INCLUDING REFERENCE DESIGNS), APPLICATION OR OTHER DESIGN ADVICE, WEB TOOLS, SAFETY INFORMATION, AND OTHER RESOURCES "AS IS" AND WITH ALL FAULTS, AND DISCLAIMS ALL WARRANTIES, EXPRESS AND IMPLIED, INCLUDING WITHOUT LIMITATION ANY IMPLIED WARRANTIES OF MERCHANTABILITY, FITNESS FOR A PARTICULAR PURPOSE OR NON-INFRINGEMENT OF THIRD PARTY INTELLECTUAL PROPERTY RIGHTS.

These resources are intended for skilled developers designing with TI products. You are solely responsible for (1) selecting the appropriate TI products for your application, (2) designing, validating and testing your application, and (3) ensuring your application meets applicable standards, and any other safety, security, regulatory or other requirements.

These resources are subject to change without notice. TI grants you permission to use these resources only for development of an application that uses the TI products described in the resource. Other reproduction and display of these resources is prohibited. No license is granted to any other TI intellectual property right or to any third party intellectual property right. TI disclaims responsibility for, and you fully indemnify TI and its representatives against any claims, damages, costs, losses, and liabilities arising out of your use of these resources.

TI's products are provided subject to [TI's Terms of Sale](#), [TI's General Quality Guidelines](#), or other applicable terms available either on ti.com or provided in conjunction with such TI products. TI's provision of these resources does not expand or otherwise alter TI's applicable warranties or warranty disclaimers for TI products. Unless TI explicitly designates a product as custom or customer-specified, TI products are standard, catalog, general purpose devices.

TI objects to and rejects any additional or different terms you may propose.

Copyright © 2026, Texas Instruments Incorporated

Last updated 10/2025