

TPPM0303

250-mA LOW-DROPOUT REGULATOR WITH AUXILIARY POWER MANAGEMENT

SLVS364 – FEBRUARY 2001

- Automatic Input Voltage Source Selection
- Glitch-Free Regulated Output
- 5-V Input Voltage Source Detector With Hysteresis
- 250-mA Load Current Capability With 5-V or 3.3-V Input Source
- Low $r_{DS(on)}$ Auxiliary Switch

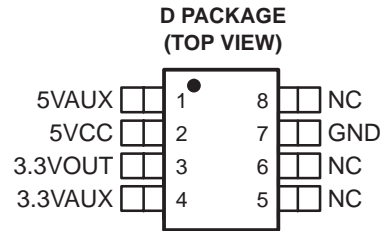

description

The TPPM0303 is a low-dropout regulator with auxiliary power management that provides a constant 3.3-V supply at the output capable of driving a 250-mA load.

The TPPM0303 provides a regulated power output for systems that have multiple input sources and require a constant voltage source with a low-dropout voltage. This is a single output, multiple input, intelligent power source selection device with a low-dropout regulator for either 5VCC or 5VAUX inputs, and a low-resistance bypass switch for the 3.3VAUX input.

Transitions may occur from one input supply to another without generating a glitch outside of the specification range on the 3.3-V output. The device has an incorporated reverse-blocking scheme to prevent excess leakage from the input terminals in the event that the output voltage is greater than the input voltage.

The input voltage is prioritized in the following order: 5VCC, 5VAUX, and 3.3VAUX.



Please be aware that an important notice concerning availability, standard warranty, and use in critical applications of Texas Instruments semiconductor products and disclaimers thereto appears at the end of this data sheet.

PRODUCTION DATA information is current as of publication date. Products conform to specifications per the terms of Texas Instruments standard warranty. Production processing does not necessarily include testing of all parameters.

 **TEXAS
INSTRUMENTS**

POST OFFICE BOX 655303 • DALLAS, TEXAS 75265

Copyright © 2001, Texas Instruments Incorporated

TPPM0303
250-mA LOW-DROPOUT REGULATOR
WITH AUXILIARY POWER MANAGEMENT

SLVS364 – FEBRUARY 2001

functional block diagram

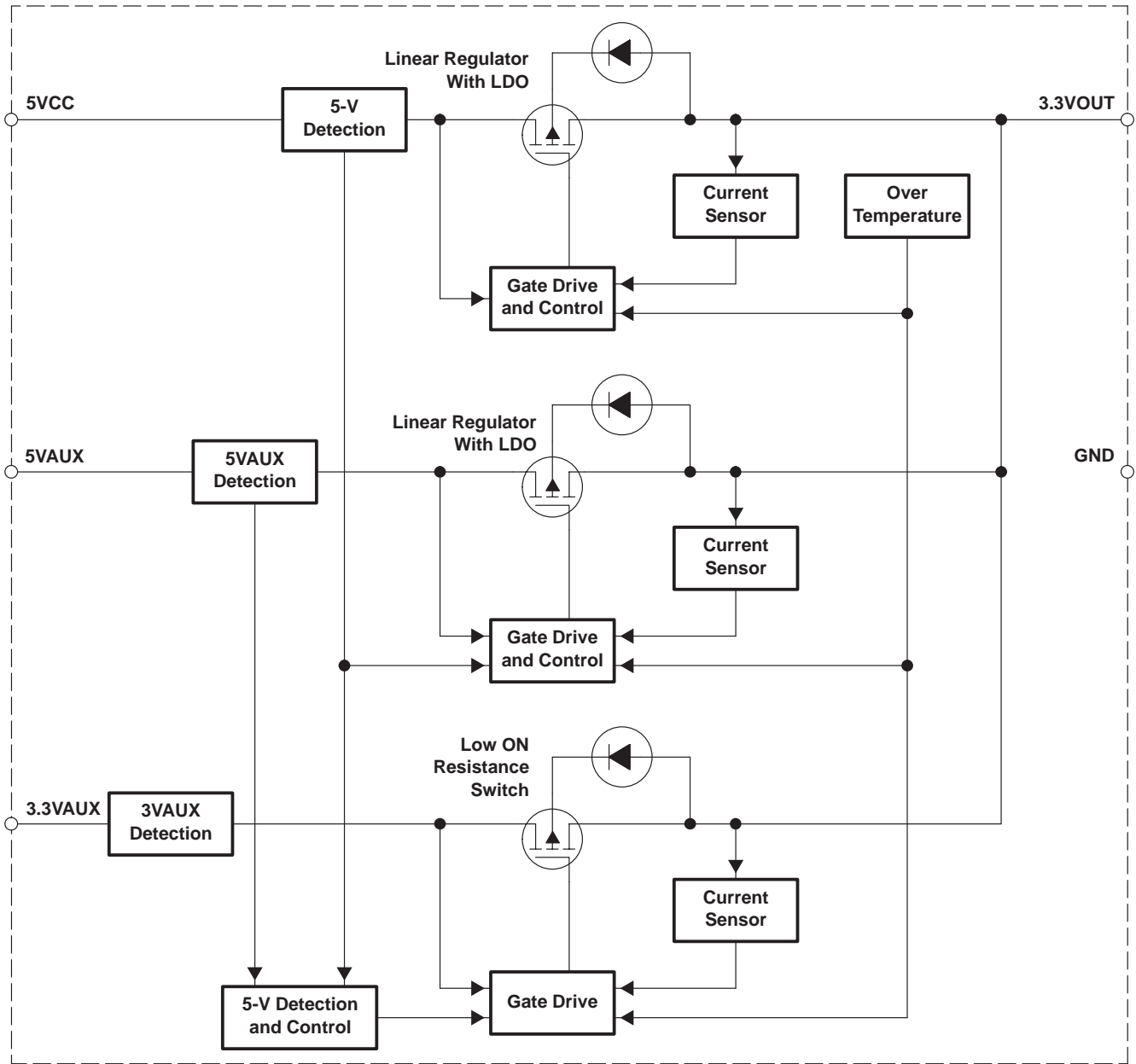

Terminal Functions

TERMINAL NAME	NO.	I/O	DESCRIPTION
3.3VAUX	4	I	3.3-V auxiliary input
3.3VOUT	3	O	3.3-V output with a typical capacitance load of 4.7 μ F
5VAUX	1	I	5-V auxiliary input
5VCC	2	I	5-V main input
GND	7	I	Ground
NC	5,6,8		No internal connection



POST OFFICE BOX 655303 • DALLAS, TEXAS 75265

Table 1. Input Selection

INPUT VOLTAGE STATUS (V)			INPUT SELECTED	OUTPUT (V)	OUTPUT (I)
5VCC	5VAUX	3.3VAUX	5VCC/5VAUX/3.3VAUX	3.3VOUT	I _L (mA)
0	0	0	None	0	0
0	0	3.3	3.3VAUX	3.3	250
0	5	0	5VAUX	3.3	250
0	5	3.3	5VAUX	3.3	250
5	0	0	5VCC	3.3	250
5	0	3.3	5VCC	3.3	250
5	5	0	5VCC	3.3	250
5	5	3.3	5VCC	3.3	250

absolute maximum ratings over operating free-air temperature (unless otherwise noted)†

Supply voltage, 5-V main input, V _(5VCC) (see Notes 1 and 2)	7 V
Auxiliary voltage, 5-V input, V _(5VAUX) (see Notes 1 and 2)	7 V
Auxiliary voltage, 3.3-V input, V _(3.3VAUX) (see Notes 1 and 2)	5 V
3.3-V output current limit, I _(LIMIT)	1.5 A
Continuous power dissipation (low-K), P _D (see Note 3)	0.625 W
Electrostatic discharge susceptibility, human body model, V _(HBMESD)	2 kV
Operating ambient temperature range, T _A	0°C to 70°C
Storage temperature range, T _{stg}	–55°C to 150°C
Operating junction temperature range, T _J	–5°C to 120°C
Lead temperature (soldering, 10 second), T _(LEAD)	260°C

† Stresses beyond those listed under “absolute maximum ratings” may cause permanent damage to the device. These are stress ratings only, and functional operation of the device at these or any other conditions beyond those indicated under “recommended operating conditions” is not implied. Exposure to absolute-maximum-rated conditions for extended periods may affect device reliability.

- NOTES: 1. All voltage values are with respect to GND.
 2. Absolute negative voltage on these terminal should not be below –0.5 V.
 3. The device derates with increase in ambient temperature, T_A. See Thermal Information section.

recommended operating conditions

	MIN	TYP	MAX	UNIT
5-V main input, V _(5VCC)	4.5		5.5	V
5-V auxiliary input, V _(5VAUX)	4.5		5.5	V
3.3-V auxiliary input, V _(3.3VAUX)	3		3.6	V
Load capacitance, C _L	4.23	4.7	5.17	μF
Load current, I _L	0		250	mA
Ambient temperature, T _A	0		70	°C

TPPM0303
250-mA LOW-DROPOUT REGULATOR
WITH AUXILIARY POWER MANAGEMENT

SLVS364 – FEBRUARY 2001

electrical characteristics over recommended operating free-air temperature range, $T_A = 0^\circ\text{C}$ to 70°C , $C_L = 4.7\ \mu\text{F}$ (unless otherwise noted)

PARAMETER	TEST CONDITIONS	MIN	TYP	MAX	UNIT
$V_{(5VCC)}/V_{(5VAUX)}$ 5-V inputs		4.5	5	5.5	V
$I_{(Q)}$ Quiescent supply current	From 5VCC or 5VAUX terminals, $I_L = 0$ to 250 mA		2.5	5	mA
	From 3.3VAUX terminal, $I_L = 0$ A		250	500	μA
I_L Output load current		0.25			A
$I_{(LIMIT)}$ Output current limit	3.3VOUT = 0 V			2	
$T_{(TSD)}^\dagger$ Thermal shutdown	3.3VOUT output shorted to 0 V			150	$^\circ\text{C}$
T_{hys}^\dagger Thermal hysteresis				15	
$V_{(3.3VOUT)}$ 3.3-V output	$I_L = 250$ mA	3.135	3.3	3.465	V
C_L Load capacitance	Minimal ESR to insure stability of regulated output		4.7		μF
$I_{lkg(REV)}$ Reverse leakage output current	Tested for input that is grounded. 3.3VAUX, 5VAUX or 5VCC = GND, 3.3VOUT = 3.3 V			50	μA

† Design targets only. Not tested in production.

5-V detect

PARAMETER	TEST CONDITIONS	MIN	TYP	MAX	UNIT
$V_{(TO_LO)}$ Threshold voltage, low	5VAUX or 5VCC \downarrow	3.85	4.05	4.25	V
$V_{(TO_HI)}$ Threshold voltage, high	5VAUX or 5VCC \uparrow	4.1	4.3	4.5	V

auxiliary switch

PARAMETER	TEST CONDITIONS	MIN	TYP	MAX	UNIT
$R_{(SWITCH)}$ Auxiliary switch resistance	5VAUX = 5VCC = 0 V, 3.3VAUX = 3.3 V, $I_L = 150$ mA			0.4	Ω
$\Delta V_{O(\Delta VI)}$ Line regulation voltage	5VAUX or 5VCC = 4.5 V to 5.5 V		2		mV
$\Delta V_{O(\Delta IO)}$ Load regulation voltage	20 mA < I_L < 250 mA		40		mV
$V_I - V_O$ Dropout voltage	$I_L < 250$ mA			1	V

thermal characteristics

PARAMETER	TEST CONDITIONS	MIN	TYP	MAX	UNIT
$R_{\theta JC}$ Thermal impedance, junction-to-case				39	$^\circ\text{C}/\text{W}$
$R_{\theta JA}$ Thermal impedance, junction-to-ambient	Low-K (see Note 4)			176	$^\circ\text{C}/\text{W}$
	High-K (see Note 4)			98	

NOTE 4: See JEDEC PCB specifications for low-K and high-K.



TYPICAL CHARACTERISTICS

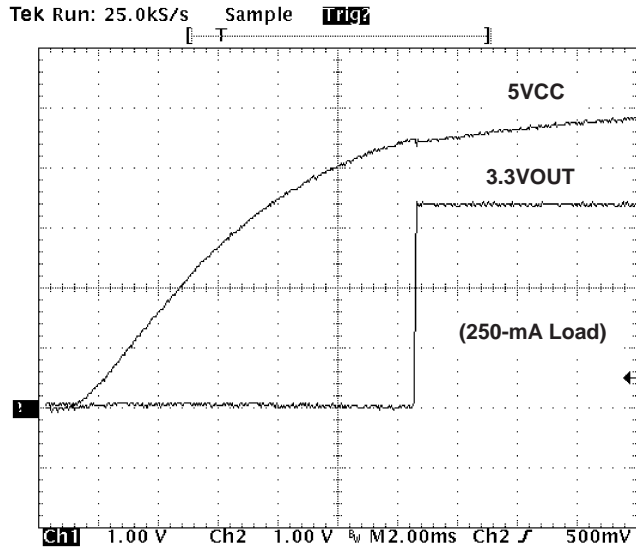

Figure 1. 5VCC Cold Start

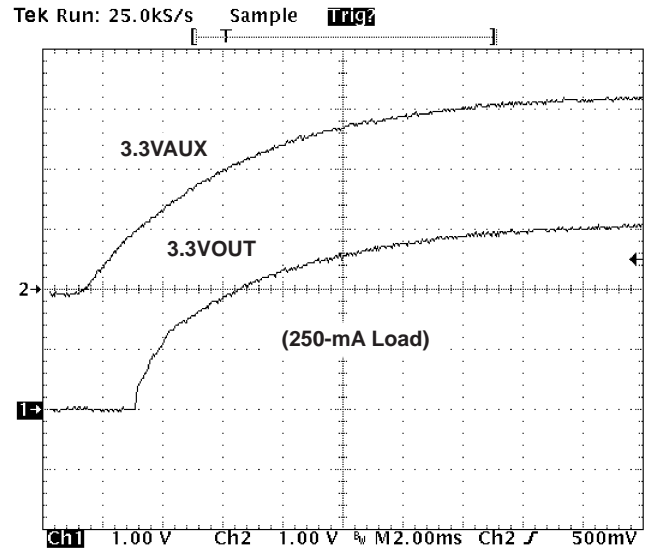

Figure 2. 3.3VAUX Cold Start

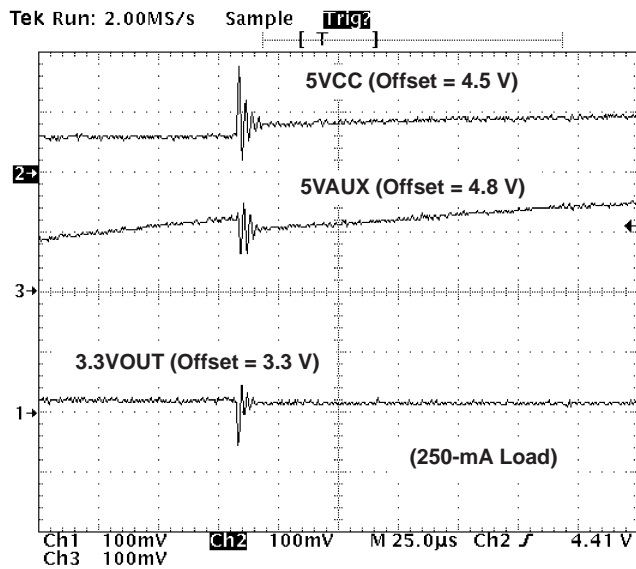

Figure 3. 5VCC Power Up (5VAUX = 5 V)

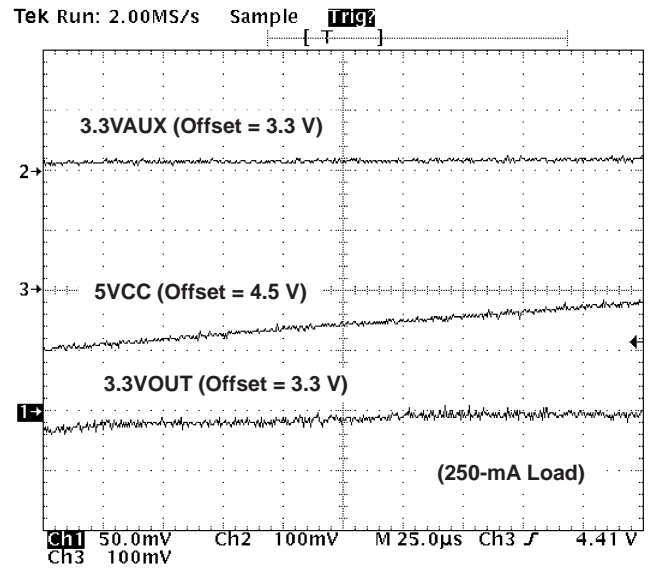

Figure 4. 5VCC Power Up (3.3VAUX = 3.3 V)

TPPM0303
250-mA LOW-DROPOUT REGULATOR
WITH AUXILIARY POWER MANAGEMENT

SLVS364 – FEBRUARY 2001

TYPICAL CHARACTERISTICS

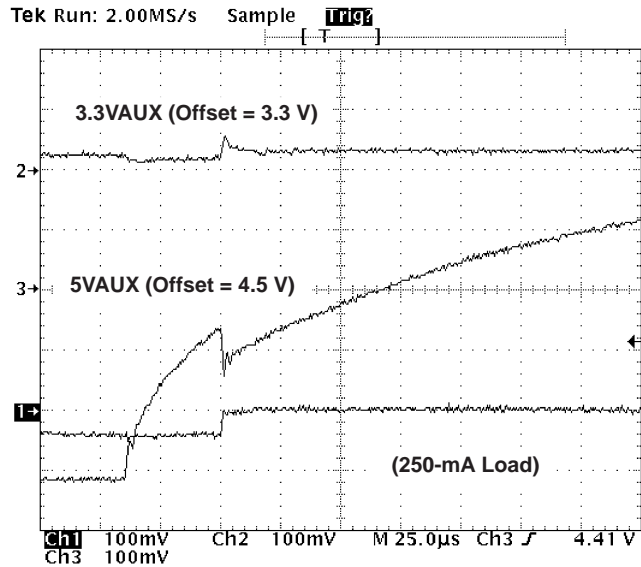

Figure 5. 5VAUX Power Up (3.3VAUX = 3.3 V)

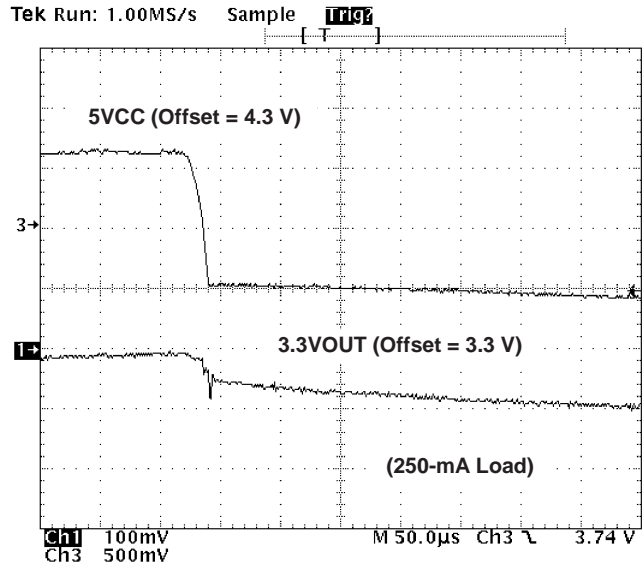

Figure 6. 5VCC Power Down (3.3VAUX = 3.3 V)

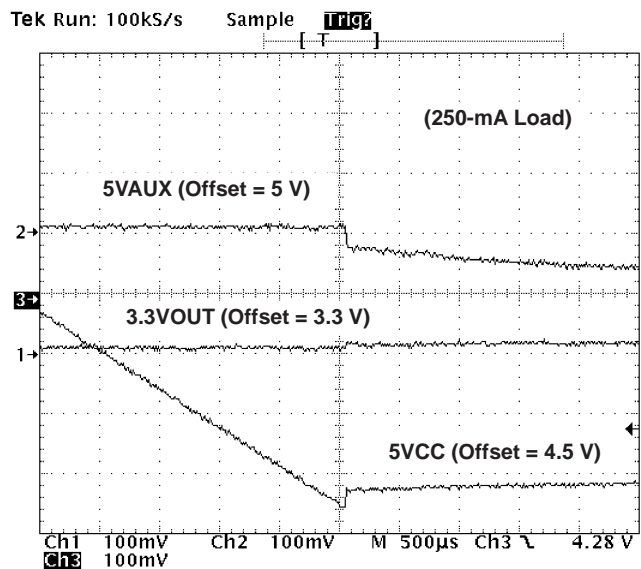

Figure 7. 5VCC Power Down (5VAUX = 5 V)

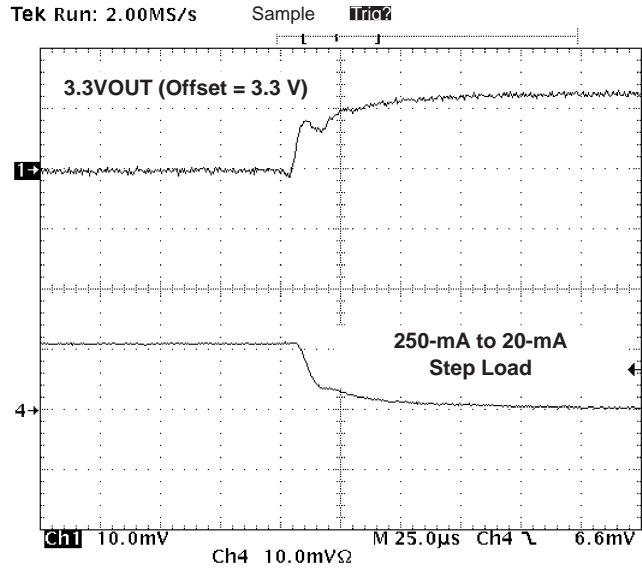

Figure 8. 5VCC Load Transient Response Falling

TYPICAL CHARACTERISTICS

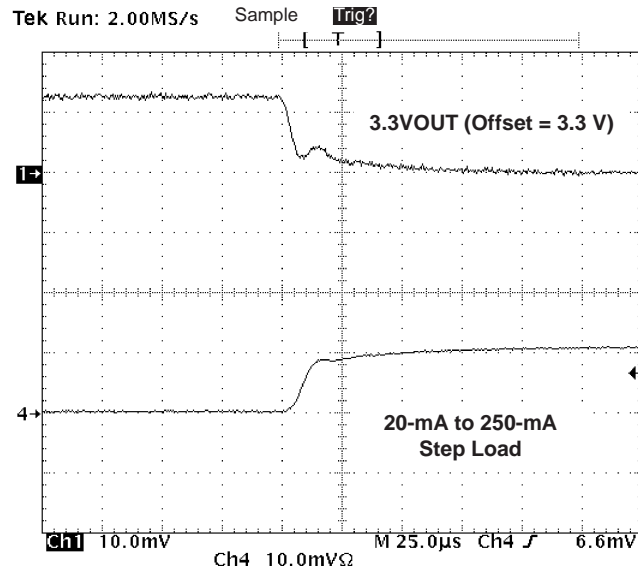

Figure 9. 5VCC Load Transient Response Rising

THERMAL INFORMATION

To ensure reliable operation of the device, the junction temperature of the output device must be within the safe operating area (SOA). This is achieved by having a means to dissipate the heat generated from the junction of the output structure. There are two components that contribute to thermal resistance. They consist of two paths in series. The first is the junction to case thermal resistance, $R_{\theta JC}$; the second is the case to ambient thermal resistance, $R_{\theta CA}$. The overall junction to ambient thermal resistance, $R_{\theta JA}$, is determined by:

$$R_{\theta JA} = R_{\theta JC} + R_{\theta CA}$$

The ability to efficiently dissipate the heat from the junction is a function of the package style and board layout incorporated in the application. The operating junction temperature is determined by the operating ambient temperature, T_A , and the junction power dissipation, P_J .

The junction temperature, T_J , is equal to the following thermal equation:

$$T_J = T_A + P_J (R_{\theta JC}) + P_J (R_{\theta CA})$$

$$T_J = T_A + P_J (R_{\theta JA})$$

This particular application uses the 8-pin SO package with standard lead frame with a dedicated ground terminal. Hence, the maximum power dissipation allowable for an operating ambient temperature of 70°C, and a maximum junction temperature of 150°C is determined as:

$$P_J = (T_J - T_A) / R_{\theta JA}$$

$$P_J = (150 - 70) / 176 = 0.45 \text{ W when using a low-K PCB.}$$

$$P_J = (150 - 70) / 98 = 0.81 \text{ W when using a high-K PCB.}$$

Worst case maximum power dissipation is determined by:

$$P_D = (5.5 - 3) \times 0.25 = 0.625 \text{ W}$$

Normal operating maximum power dissipation is (see Figure 10):

$$P_D = (5 - 3.3) \times 0.25 = 0.425 \text{ W}$$

TPPM0303
250-mA LOW-DROPOUT REGULATOR
WITH AUXILIARY POWER MANAGEMENT

SLVS364 – FEBRUARY 2001

THERMAL INFORMATION

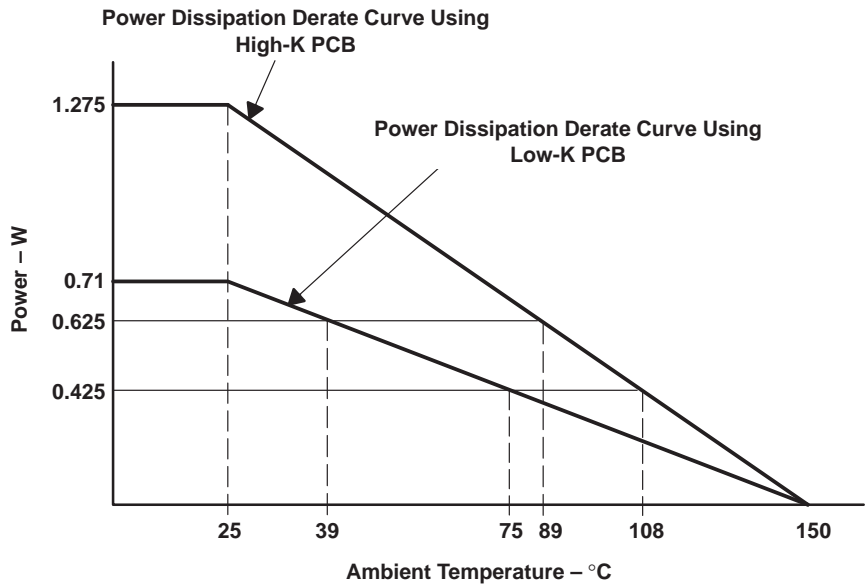

NOTE: These curves are to be used for guideline purposes only. For a particular application, a more specific thermal characterization is required.

Figure 10. Power Dissipation Derating Curves

APPLICATION INFORMATION

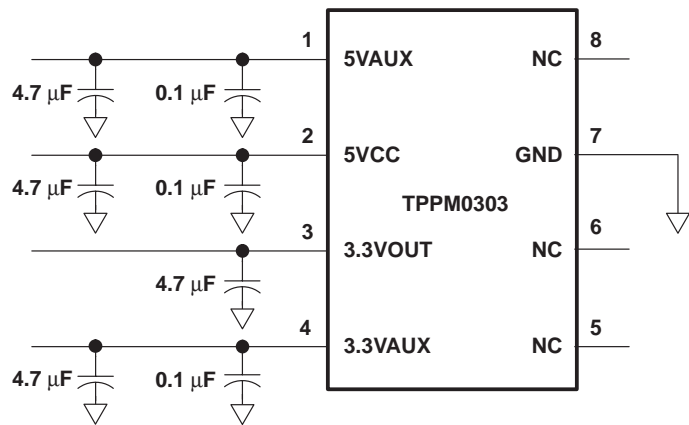

Figure 11. Typical Application Schematic

MECHANICAL DATA

D (R-PDSO-G**)

PLASTIC SMALL-OUTLINE PACKAGE

14 PINS SHOWN

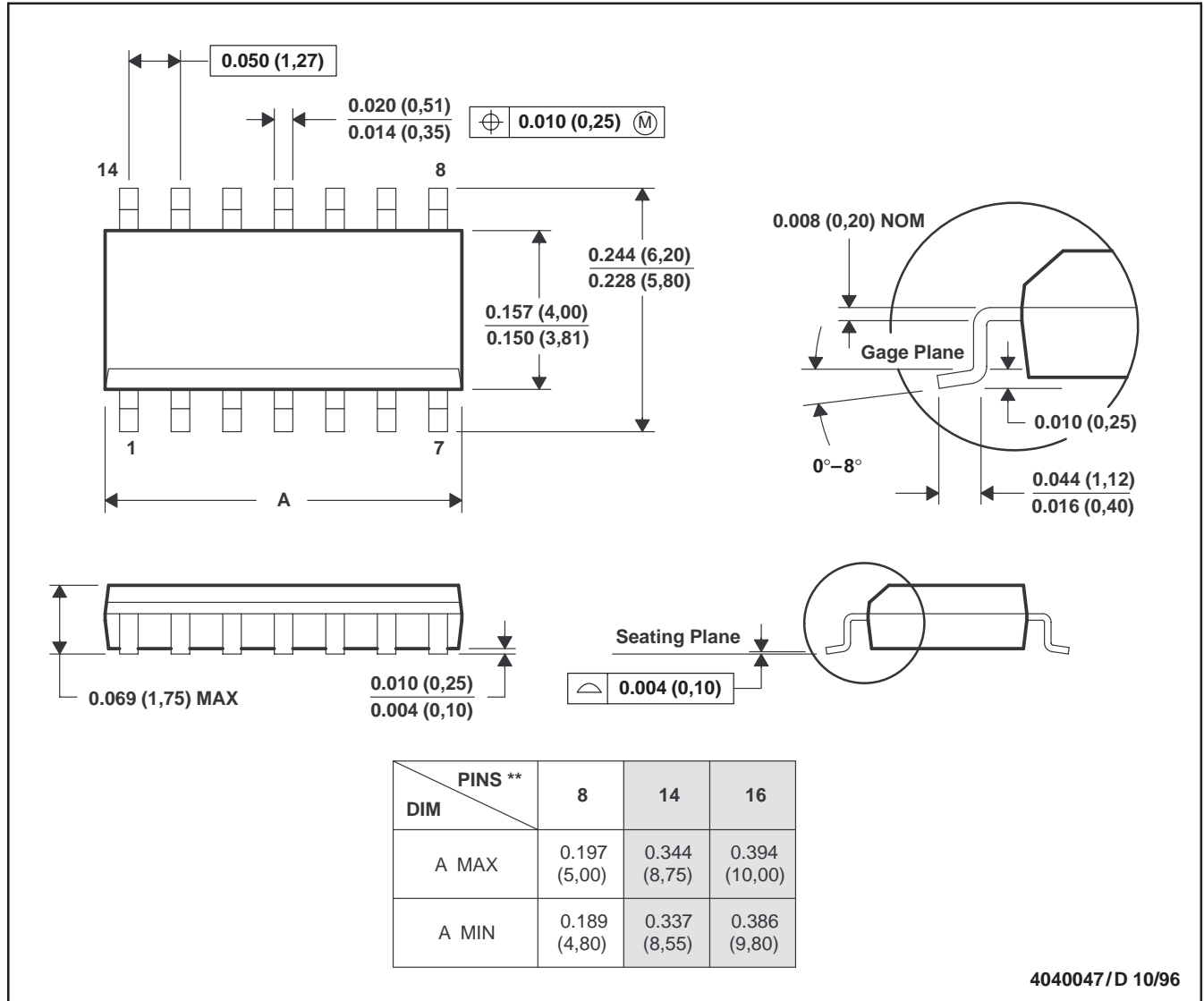

- NOTES: A. All linear dimensions are in inches (millimeters).
 B. This drawing is subject to change without notice.
 C. Body dimensions do not include mold flash or protrusion, not to exceed 0.006 (0,15).
 D. Falls within JEDEC MS-012

PACKAGING INFORMATION

Orderable Device	Status (1)	Package Type	Package Drawing	Pins	Package Qty	Eco Plan (2)	Lead finish/ Ball material (6)	MSL Peak Temp (3)	Op Temp (°C)	Device Marking (4/5)	Samples
TPPM0303D	ACTIVE	SOIC	D	8	75	RoHS & Green	NIPDAU	Level-1-260C-UNLIM	0 to 70	TPPM0303	Samples
TPPM0303DR	ACTIVE	SOIC	D	8	2500	RoHS & Green	NIPDAU	Level-1-260C-UNLIM	0 to 70	TPPM0303	Samples

(1) The marketing status values are defined as follows:

ACTIVE: Product device recommended for new designs.

LIFEBUY: TI has announced that the device will be discontinued, and a lifetime-buy period is in effect.

NRND: Not recommended for new designs. Device is in production to support existing customers, but TI does not recommend using this part in a new design.

PREVIEW: Device has been announced but is not in production. Samples may or may not be available.

OBSOLETE: TI has discontinued the production of the device.

(2) **RoHS:** TI defines "RoHS" to mean semiconductor products that are compliant with the current EU RoHS requirements for all 10 RoHS substances, including the requirement that RoHS substance do not exceed 0.1% by weight in homogeneous materials. Where designed to be soldered at high temperatures, "RoHS" products are suitable for use in specified lead-free processes. TI may reference these types of products as "Pb-Free".

RoHS Exempt: TI defines "RoHS Exempt" to mean products that contain lead but are compliant with EU RoHS pursuant to a specific EU RoHS exemption.

Green: TI defines "Green" to mean the content of Chlorine (Cl) and Bromine (Br) based flame retardants meet JS709B low halogen requirements of <=1000ppm threshold. Antimony trioxide based flame retardants must also meet the <=1000ppm threshold requirement.

(3) MSL, Peak Temp. - The Moisture Sensitivity Level rating according to the JEDEC industry standard classifications, and peak solder temperature.

(4) There may be additional marking, which relates to the logo, the lot trace code information, or the environmental category on the device.

(5) Multiple Device Markings will be inside parentheses. Only one Device Marking contained in parentheses and separated by a "~" will appear on a device. If a line is indented then it is a continuation of the previous line and the two combined represent the entire Device Marking for that device.

(6) Lead finish/Ball material - Orderable Devices may have multiple material finish options. Finish options are separated by a vertical ruled line. Lead finish/Ball material values may wrap to two lines if the finish value exceeds the maximum column width.

Important Information and Disclaimer:The information provided on this page represents TI's knowledge and belief as of the date that it is provided. TI bases its knowledge and belief on information provided by third parties, and makes no representation or warranty as to the accuracy of such information. Efforts are underway to better integrate information from third parties. TI has taken and continues to take reasonable steps to provide representative and accurate information but may not have conducted destructive testing or chemical analysis on incoming materials and chemicals. TI and TI suppliers consider certain information to be proprietary, and thus CAS numbers and other limited information may not be available for release.

In no event shall TI's liability arising out of such information exceed the total purchase price of the TI part(s) at issue in this document sold by TI to Customer on an annual basis.

TAPE AND REEL INFORMATION

QUADRANT ASSIGNMENTS FOR PIN 1 ORIENTATION IN TAPE

*All dimensions are nominal

Device	Package Type	Package Drawing	Pins	SPQ	Reel Diameter (mm)	Reel Width W1 (mm)	A0 (mm)	B0 (mm)	K0 (mm)	P1 (mm)	W (mm)	Pin1 Quadrant
TPPM0303DR	SOIC	D	8	2500	330.0	12.4	6.4	5.2	2.1	8.0	12.0	Q1

TAPE AND REEL BOX DIMENSIONS



*All dimensions are nominal

Device	Package Type	Package Drawing	Pins	SPQ	Length (mm)	Width (mm)	Height (mm)
TPPM0303DR	SOIC	D	8	2500	340.5	338.1	20.6

TUBE

*All dimensions are nominal

Device	Package Name	Package Type	Pins	SPQ	L (mm)	W (mm)	T (μm)	B (mm)
TPPM0303D	D	SOIC	8	75	507	8	3940	4.32

IMPORTANT NOTICE AND DISCLAIMER

TI PROVIDES TECHNICAL AND RELIABILITY DATA (INCLUDING DATA SHEETS), DESIGN RESOURCES (INCLUDING REFERENCE DESIGNS), APPLICATION OR OTHER DESIGN ADVICE, WEB TOOLS, SAFETY INFORMATION, AND OTHER RESOURCES "AS IS" AND WITH ALL FAULTS, AND DISCLAIMS ALL WARRANTIES, EXPRESS AND IMPLIED, INCLUDING WITHOUT LIMITATION ANY IMPLIED WARRANTIES OF MERCHANTABILITY, FITNESS FOR A PARTICULAR PURPOSE OR NON-INFRINGEMENT OF THIRD PARTY INTELLECTUAL PROPERTY RIGHTS.

These resources are intended for skilled developers designing with TI products. You are solely responsible for (1) selecting the appropriate TI products for your application, (2) designing, validating and testing your application, and (3) ensuring your application meets applicable standards, and any other safety, security, regulatory or other requirements.

These resources are subject to change without notice. TI grants you permission to use these resources only for development of an application that uses the TI products described in the resource. Other reproduction and display of these resources is prohibited. No license is granted to any other TI intellectual property right or to any third party intellectual property right. TI disclaims responsibility for, and you will fully indemnify TI and its representatives against, any claims, damages, costs, losses, and liabilities arising out of your use of these resources.

TI's products are provided subject to [TI's Terms of Sale](#) or other applicable terms available either on [ti.com](https://www.ti.com) or provided in conjunction with such TI products. TI's provision of these resources does not expand or otherwise alter TI's applicable warranties or warranty disclaimers for TI products.

TI objects to and rejects any additional or different terms you may have proposed.

Mailing Address: Texas Instruments, Post Office Box 655303, Dallas, Texas 75265
Copyright © 2023, Texas Instruments Incorporated