

# TPS568215OA 4.5-V to 17-V Input , 8-A Synchronous Step-Down SWIFT™ Converter

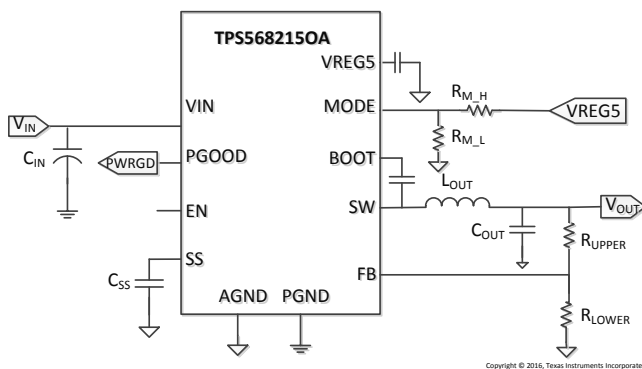
## 1 Features

- Integrated 19-mΩ and 9.4-mΩ MOSFETs
- Selectable  $F_{SW}$  of 400 kHz, 800 kHz or 1.2 MHz
- Out-of-Audio Feature to Keep Switching Frequency Out of Audio Frequency Range
- Adjustable Current Limit Settings with Hiccup Re-start
- 0.6 V  $\pm$ 1% Reference Voltage Across Full Temperature Range
- Optional External 5-V Bias Support for Enhanced Efficiency
- D-CAP3™ Control Mode for Fast Transient Response
- 0.6 V to 5.5 V Output Voltage Range
- Supports all Ceramic Capacitors
- Monotonic Startup into Pre-biased Outputs
- Adjustable Soft Start with a Default 1-ms Soft Start Time
- $-40^{\circ}\text{C}$  to  $150^{\circ}\text{C}$  Operating Junction Temperature
- Small 3.5-mm x 3.5-mm HotRod™ QFN Package

## 2 Applications

- Server and Storage
- Set top Box, High-End DTV
- Laptop and Gaming Systems

### Typical Application Schematic



## 3 Description

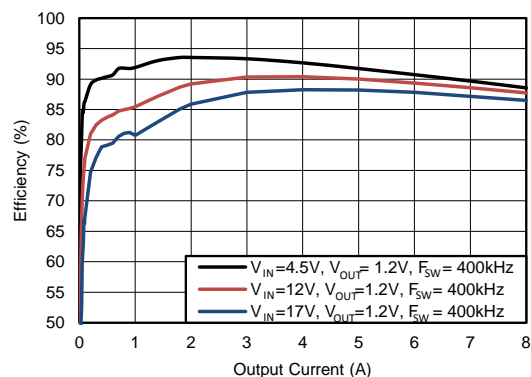
The TPS568215OA is TI's smallest monolithic 8-A synchronous buck converter with an adaptive on-time D-CAP3™ control mode. The device integrates low  $R_{DS(on)}$  power MOSFETs that enable high efficiency and it offers ease-of-use with minimal external component count for space-conscious power systems. Key features include a very accurate reference voltage, fast load transient response, Out-of-Audio mode, adjustable current limit and no requirement for external compensation. A forced continuous conduction mode helps meet tight voltage regulation accuracy requirements for performance DSPs and FPGAs. The TPS568215OA is available in a thermally enhanced 18-pin HotRod™ QFN package and is designed to operate from  $-40^{\circ}\text{C}$  to  $150^{\circ}\text{C}$  junction temperature. TPS568215OA is pin to pin compatible with TPS568215 and TPS56C215 which gives the user flexibility to pick solutions from 6A to 12A in the same footprint.

### Device Information<sup>(1)</sup>

PART NUMBER	PACKAGE	BODY SIZE (NOM)
TPS568215OA	VQFN (18)	3.50 mm x 3.50 mm

(1) For all available packages, see the orderable addendum at the end of the data sheet.

### Efficiency vs Output Current



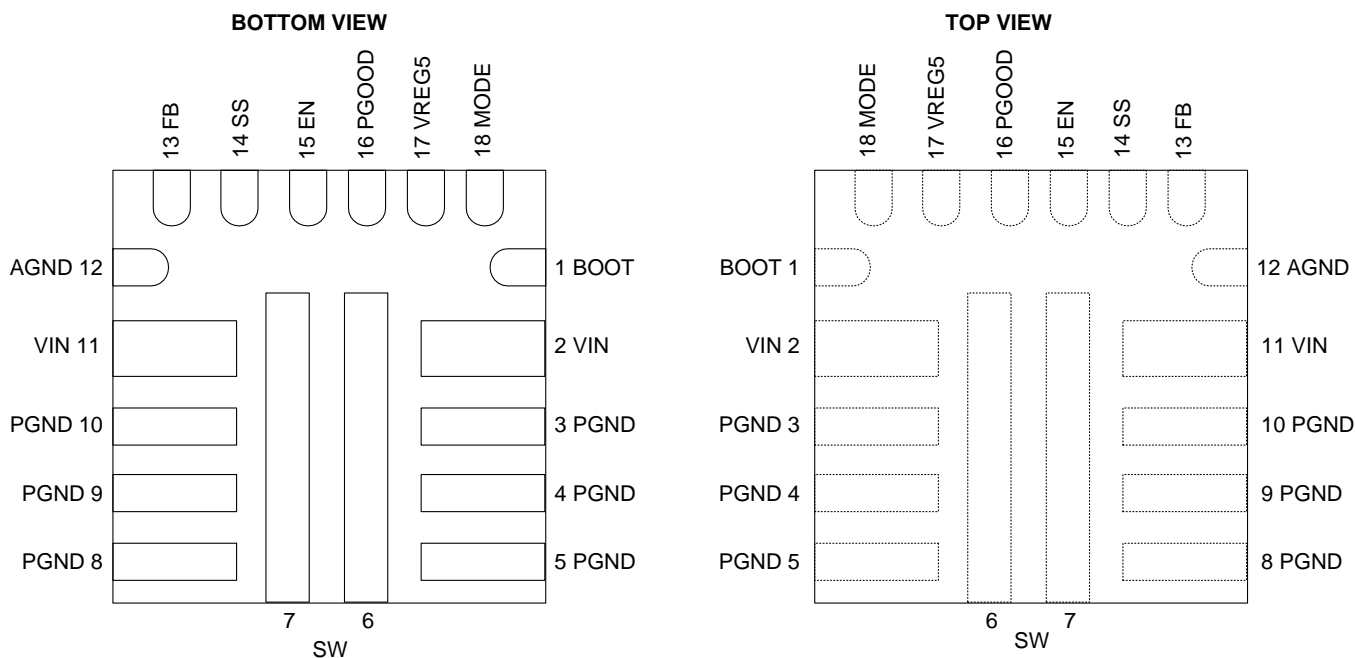
## Table of Contents

<b>1 Features</b> .....	<b>1</b>	7.4 Device Functional Modes.....	<b>18</b>
<b>2 Applications</b> .....	<b>1</b>	<b>8 Application and Implementation</b> .....	<b>19</b>
<b>3 Description</b> .....	<b>1</b>	8.1 Application Information.....	<b>19</b>
<b>4 Revision History</b> .....	<b>2</b>	8.2 Typical Application .....	<b>19</b>
<b>5 Pin Configuration and Functions</b> .....	<b>3</b>	<b>9 Power Supply Recommendations</b> .....	<b>24</b>
<b>6 Specifications</b> .....	<b>4</b>	<b>10 Layout</b> .....	<b>25</b>
6.1 Absolute Maximum Ratings .....	4	10.1 Layout Guidelines .....	25
6.2 ESD Ratings .....	4	10.2 Layout Example .....	25
6.3 Recommended Operating Conditions.....	4	<b>11 Device and Documentation Support</b> .....	<b>28</b>
6.4 Thermal Information .....	5	11.1 Device Support .....	28
6.5 Electrical Characteristics.....	6	11.2 Receiving Notification of Documentation Updates	28
6.6 Timing Requirements .....	7	11.3 Community Resources.....	28
6.7 Typical Characteristics .....	8	11.4 Trademarks .....	28
<b>7 Detailed Description</b> .....	<b>12</b>	11.5 Electrostatic Discharge Caution.....	28
7.1 Overview .....	12	11.6 Glossary .....	28
7.2 Functional Block Diagram .....	13	<b>12 Mechanical, Packaging, and Orderable</b>	<b>28</b>
7.3 Feature Description.....	14	<b>Information</b> .....	<b>28</b>

## 4 Revision History

DATE	REVISION	NOTES
January 2017	*	Initial release.

## 5 Pin Configuration and Functions

**RNN Package  
18-Pin VQFN**


### Pin Functions

PIN		I/O	DESCRIPTION
NO.	NAME		
1	BOOT	I	Supply input for the gate drive voltage of the high-side MOSFET. Connect a 0.1- $\mu$ F bootstrap capacitor between BOOT and SW.
2,11	VIN	P	Input voltage supply pin for the control circuitry. Connect the input decoupling capacitors between VIN and PGND.
3, 4, 5, 8, 9, 10	PGND	G	Power GND terminal for the controller circuit and the internal circuitry.
6, 7	SW	O	Switch node terminal. Connect the output inductor to this pin.
12	AGND	G	Ground of internal analog circuitry. Connect AGND to PGND plane.
13	FB	I	Converter feedback input. Connect to the resistor divider between output voltage and AGND.
14	SS	O	Soft-Start time selection pin. Connecting an external capacitor sets the soft-start time and if no external capacitor is connected, the soft-start time is 1ms.
15	EN	I	Enable input control, leaving this pin floating enables the converter. It can also be used to adjust the input UVLO by connecting to the resistor divider between VIN and EN.
16	PGOOD	O	Open Drain Power Good Indicator, it is asserted low if output voltage is out of PGOOD threshold, Overvoltage or if the device is under thermal shutdown, EN shutdown or during soft start.
17	VREG5	I/O	4.7-V internal LDO output which can also be driven externally with a 5V input. This pin supplies voltage to the internal circuitry and gate driver. Bypass this pin with a 4.7- $\mu$ F capacitor.
18	MODE	I	Switching Frequency, Current Limit selection and Light load operation mode selection pin. Connect this pin to a resistor divider from VREG5 and AGND for different MODE options shown in table 4.

## 6 Specifications

### 6.1 Absolute Maximum Ratings

over operating free-air temperature range (unless otherwise noted) <sup>(1)</sup>

		MIN	MAX	UNIT
Input Voltage	V <sub>IN</sub>	-0.3	20	V
	SW	-2	19	
	SW(10 ns transient)	-3	20	
	EN	-0.3	6.5	
	BOOT –SW	-0.3	6.5	
	BOOT	-0.3	25.5	
	SS, MODE, FB	-0.3	6.5	
	VREG5	-0.3	6	
Output Voltage	PGOOD	-0.3	6.5	V
Output Current, I <sub>OUT</sub> <sup>(2)</sup>			10	A
Operating junction temperature, T <sub>J</sub>		-40	150	°C
Storage temperature, T <sub>stg</sub>		-55	150	°C

- (1) Stresses beyond those listed under *Absolute Maximum Ratings* may cause permanent damage to the device. These are stress ratings only, which do not imply functional operation of the device at these or any other conditions beyond those indicated under *Recommended Operating Conditions*. Exposure to absolute-maximum-rated conditions for extended periods may affect device reliability.
- (2) In order to be consistent with the TI reliability requirement of 100k continuous Power-On-Hours with 105°C junction temperature at the max output current of 10A, the converter's duty cycle should be limited to 60% operation as to prevent electromigration failure in the solder. If higher duty cycle is required at 10A load the total power on hours or the junction temperature have to be reduced.

### 6.2 ESD Ratings

		VALUE	UNIT
V <sub>(ESD)</sub> Electrostatic discharge	Human-body model (HBM), per ANSI/ESDA/JEDEC JS-001 <sup>(1)</sup>	±2000	V
	Charged-device model (CDM), per JEDEC specification JESD22-C101 <sup>(2)</sup>	±500	

- (1) JEDEC document JEP155 states that 500-V HBM allows safe manufacturing with a standard ESD control process.
- (2) JEDEC document JEP157 states that 250-V CDM allows safe manufacturing with a standard ESD control process.

### 6.3 Recommended Operating Conditions

over operating free-air temperature range (unless otherwise noted)

		MIN	NOM	MAX	UNIT
Input Voltage	V <sub>IN</sub>	4.5		17	V
	SW	-1.8		17	
	BOOT	-0.1		23.5	
	VREG5	-0.1		5.2	
T <sub>J</sub>	Operating junction temperature	-40		150	°C

## 6.4 Thermal Information

THERMAL METRIC <sup>(1)</sup>		TPS568215OA	UNIT
		RNN (VQFN)	
		18 PINS	
$R_{\theta JA}$	Junction-to-ambient thermal resistance	42.3	°C/W
$R_{\theta JC(top)}$	Junction-to-case (top) thermal resistance	23.9	°C/W
$R_{\theta JB}$	Junction-to-board thermal resistance	10.0	°C/W
$\Psi_{JT}$	Junction-to-top characterization parameter	0.5	°C/W
$\Psi_{JB}$	Junction-to-board characterization parameter	10.0	°C/W
$R_{\theta JC(bot)}$	Junction-to-case (bottom) thermal resistance	0.5	°C/W

(1) For more information about traditional and new thermal metrics, see the [Semiconductor and IC Package Thermal Metrics](#) application report.

## 6.5 Electrical Characteristics

 $T_J = -40^{\circ}\text{C}$  to  $150^{\circ}\text{C}$ ,  $V_{IN}=12\text{V}$  (unless otherwise noted)

PARAMETER		CONDITIONS	MIN	TYP	MAX	UNIT
<b>SUPPLY CURRENT</b>						
$I_{IN}$	$V_{IN}$ supply current	$T_J = 25^{\circ}\text{C}$ , $V_{EN}=5\text{ V}$ , non switching		850		$\mu\text{A}$
$I_{VINS DN}$	$V_{IN}$ shutdown current	$T_J = 25^{\circ}\text{C}$ , $V_{EN}=0\text{ V}$		7		$\mu\text{A}$
<b>LOGIC THRESHOLD</b>						
$V_{ENH}$	EN H-level threshold voltage		1.175	1.225	1.3	V
$V_{ENL}$	EN L-level threshold voltage		1.025	1.104	1.15	V
$V_{ENHYS}$				0.121		V
$I_{ENp1}$	EN pull-up current	$V_{EN} = 1.0\text{ V}$	0.35	1.91	2.95	$\mu\text{A}$
$I_{ENp2}$		$V_{EN} = 1.3\text{ V}$	3	4.197	5.5	$\mu\text{A}$
<b>FEEDBACK VOLTAGE</b>						
$V_{FB}$	FB voltage	$T_J = 25^{\circ}\text{C}$	598	600	602	mV
		$T_J = 0^{\circ}\text{C}$ to $85^{\circ}\text{C}$	597.5	600	602.5	mV
		$T_J = -40^{\circ}\text{C}$ to $85^{\circ}\text{C}$	594	600	602.5	mV
		$T_J = -40^{\circ}\text{C}$ to $150^{\circ}\text{C}$	594	600	606	mV
<b>LDO VOLTAGE</b>						
VREG5	LDO Output voltage	$T_J = -40^{\circ}\text{C}$ to $150^{\circ}\text{C}$	4.58	4.7	4.83	V
ILIM5	LDO Output Current limit	$T_J = -40^{\circ}\text{C}$ to $150^{\circ}\text{C}$	100	150	200	mA
<b>MOSFET</b>						
$R_{DS(on)H}$	High side switch resistance	$T_J = 25^{\circ}\text{C}$ , $V_{VREG5} = 4.7\text{ V}$		19		m $\Omega$
$R_{DS(on)L}$	Low side switch resistance	$T_J = 25^{\circ}\text{C}$ , $V_{VREG5} = 4.7\text{ V}$		9.4		m $\Omega$
<b>SOFT START</b>						
$I_{ss}$	Soft start charge current	$T_J = -40^{\circ}\text{C}$ to $150^{\circ}\text{C}$	4.9	6	7.1	$\mu\text{A}$
<b>CURRENT LIMIT</b>						
$I_{OCL}$	Current Limit (Low side sourcing)	ILIM-1 option, Valley Current	6	7.1	8.15	A
		ILIM option, Valley Current	8	9.4	10.8	A
		ILIM+1 option, Valley Current	10	11.8	13.5	A
	Current Limit (Low side negative)	Valley Current		3		A
<b>POWER GOOD</b>						
$V_{PGOODTH}$	PGOOD threshold	$V_{FB}$ falling (fault)		84%		$\%V_{REF}$
		$V_{FB}$ rising (good)		93%		$\%V_{REF}$
		$V_{FB}$ rising (fault)		116%		$\%V_{REF}$
		$V_{FB}$ falling (good)		107%		$\%V_{REF}$
<b>OUTPUT UNDERVOLTAGE PROTECTION</b>						
$V_{UVP}$	Output UVP threshold	Hiccup detect		$68\% \times V_{FB}$		
<b>THERMAL SHUTDOWN</b>						
$T_{SDN}$	Thermal shutdown threshold	Shutdown temperature		160		$^{\circ}\text{C}$
		Hysteresis		15		$^{\circ}\text{C}$
$T_{SDN VREG5}$	VREG5 thermal shutdown threshold	Shutdown temperature		171		$^{\circ}\text{C}$
		Hysteresis		18		$^{\circ}\text{C}$
<b>UVLO</b>						
UVLO	UVLO threshold	VREG5 rising voltage	4.1	4.3	4.5	V
		VREG5 falling voltage	3.34	3.57	3.8	V
		VREG5 hysteresis		730		mV

## 6.6 Timing Requirements

PARAMETER		CONDITIONS	MIN	TYP	MAX	UNIT
<b>ON-TIME TIMER CONTROL</b>						
$t_{ON}$	SW On Time	$V_{IN} = 12\text{ V}$ , $V_{OUT}=3.3\text{ V}$ , $F_{SW} = 800\text{ kHz}$	310	340	380	ns
$t_{ON\ min}$	SW Minimum on time	$V_{IN} = 17\text{ V}$ , $V_{OUT}=0.6\text{ V}$ , $F_{SW}= 1200\text{ kHz}$		54		ns
$t_{OFF}$	SW Minimum off time	$25^{\circ}\text{C}$ , $V_{FB}=0.5\text{ V}$			310	ns
$F_{S\ WOOA}$	OOA Switching Frequency	$T_J = -40^{\circ}\text{C}$ to $150^{\circ}\text{C}$ , No Load	20		27	KHz
<b>SOFT START</b>						
$t_{SS}$	Soft start time	Internal soft start time		1.045		ms
<b>OUTPUT UNDERVOLTAGE AND OVERVOLTAGE PROTECTION</b>						
$t_{UVPDEL}$	Output Hiccup delay relative to SS time	UVP detect		1		cycle
$t_{UVPEN}$	Output Hiccup enable delay relative to SS time	UVP detect		7		cycle

## 6.7 Typical Characteristics

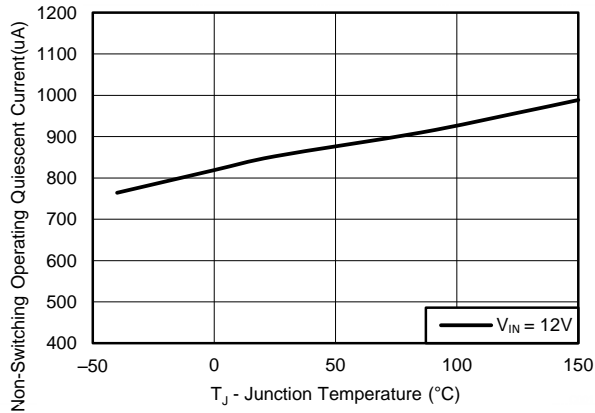


Figure 1. Quiescent Current vs Temperature

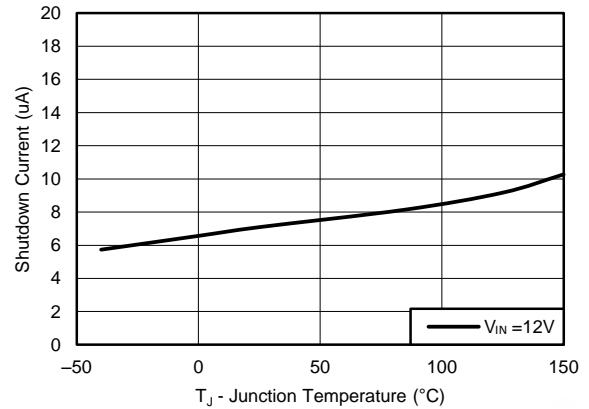


Figure 2. Shutdown Current vs Temperature

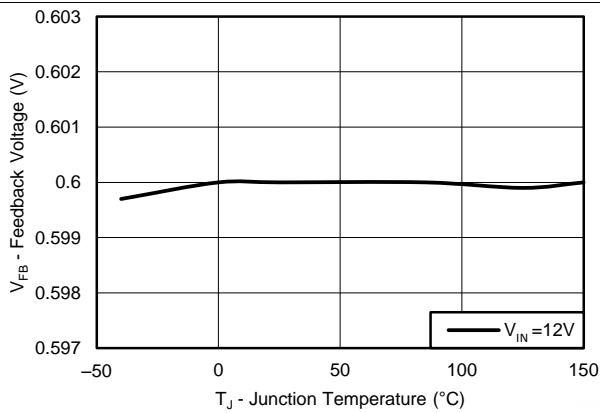


Figure 3. Feedback Voltage vs Temperature

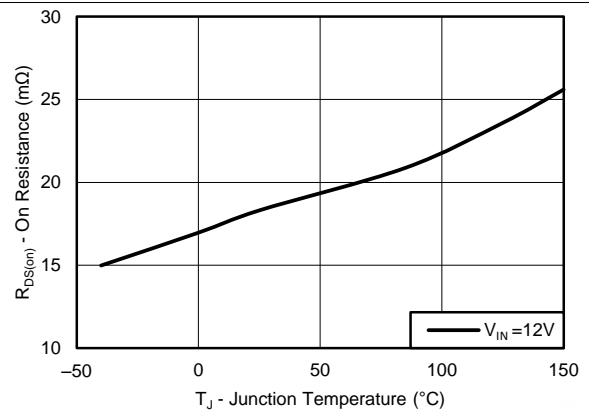


Figure 4. High-side R<sub>dson</sub> vs Temperature

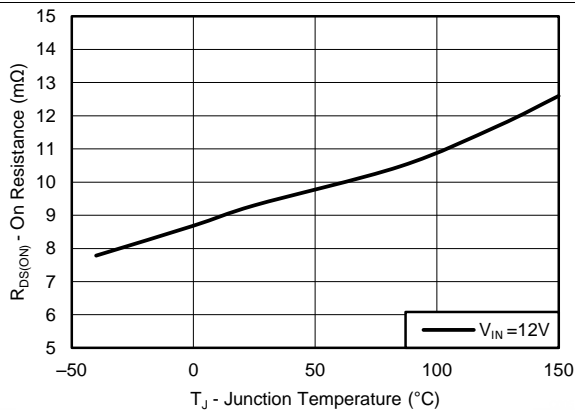


Figure 5. Low-side R<sub>dson</sub> vs Temperature

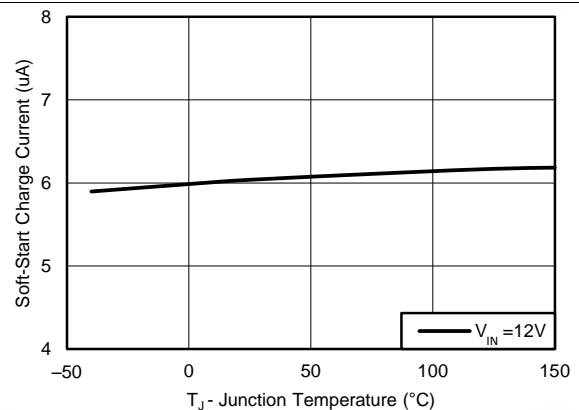
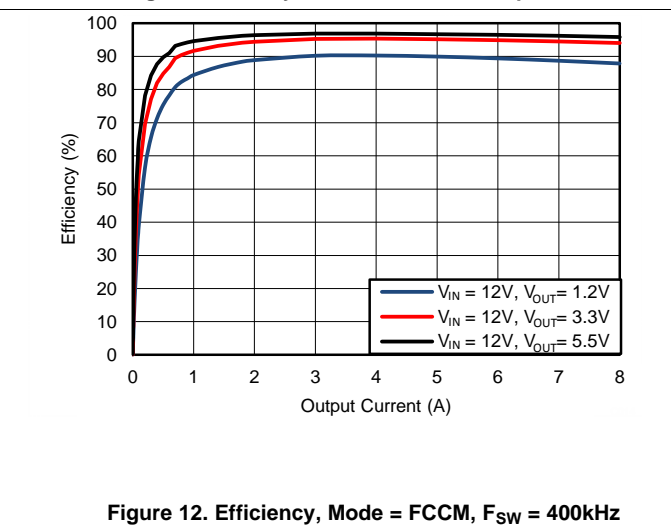
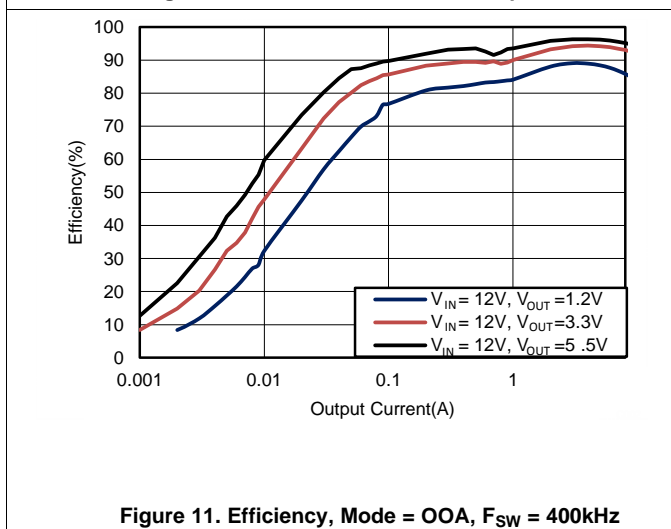
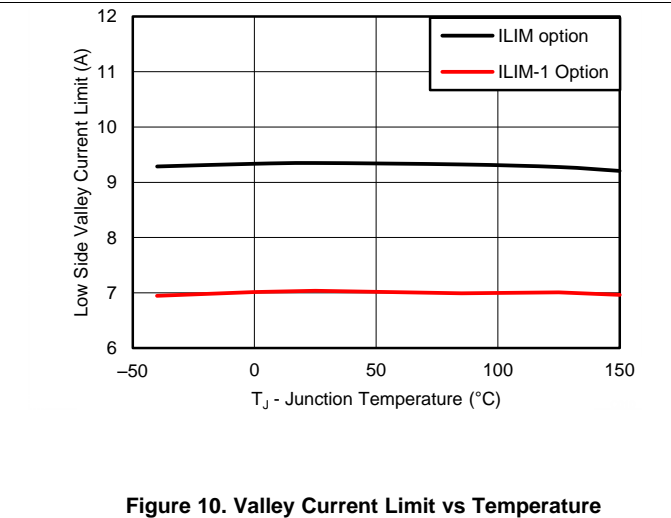
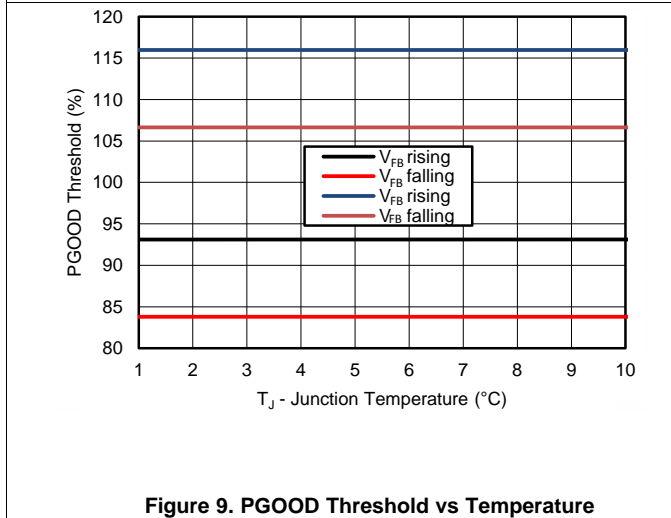
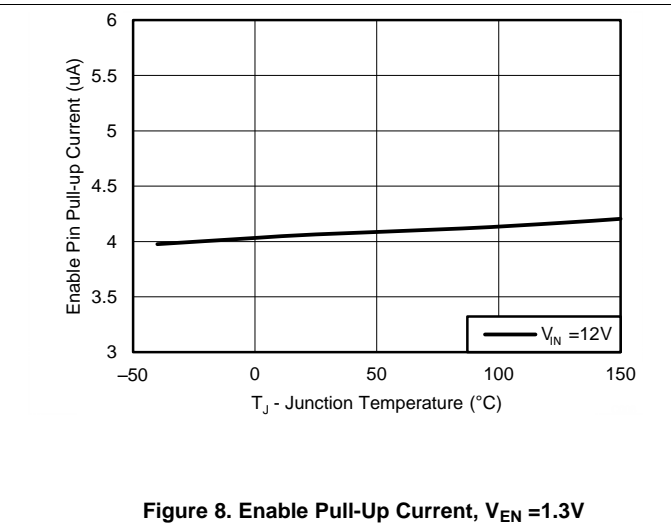
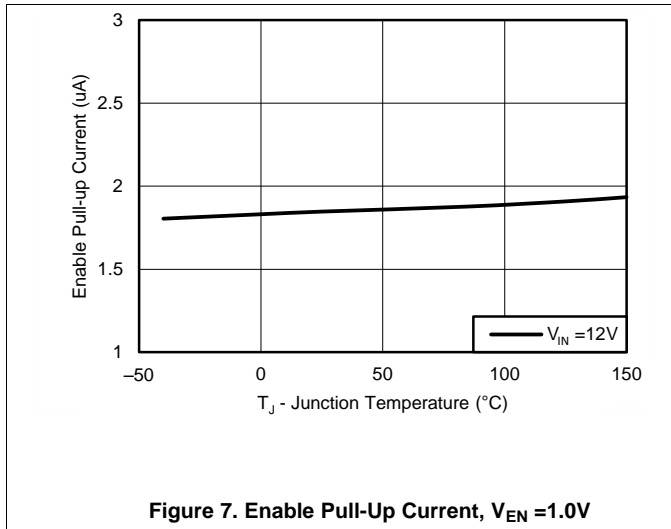


Figure 6. Soft-Start Charge Current vs Temperature



Typical Characteristics (continued)



Typical Characteristics (continued)

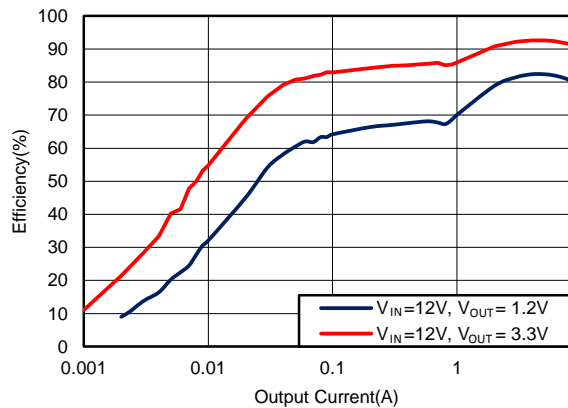


Figure 13. Efficiency, Mode = OOA,  $F_{SW} = 1200\text{kHz}$

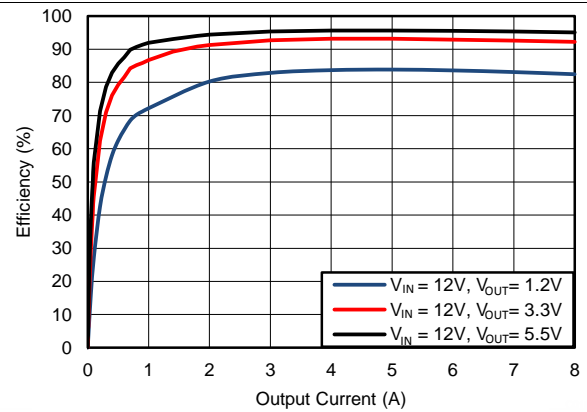


Figure 14. Efficiency, Mode = FCCM,  $F_{SW} = 1200\text{kHz}$

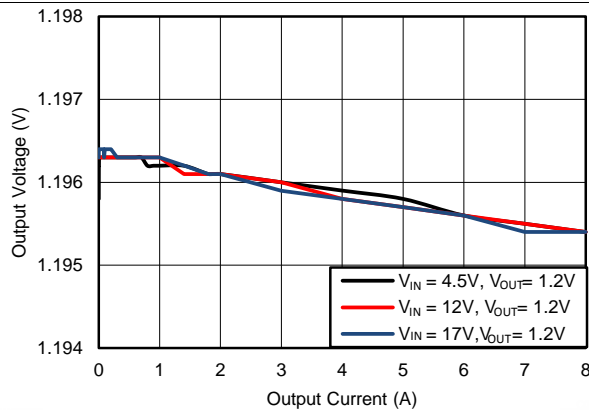


Figure 15. Load Regulation,  $F_{SW} = 400\text{kHz}$

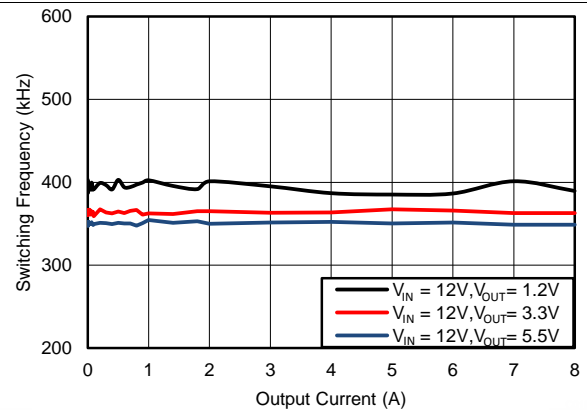


Figure 16.  $F_{SW}$  Load Regulation, Mode = FCCM,  $F_{SW} = 400\text{kHz}$

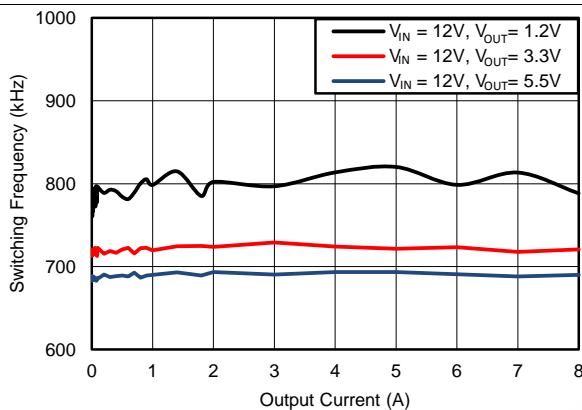


Figure 17.  $F_{SW}$  Load Regulation, Mode = FCCM,  $F_{SW} = 800\text{kHz}$

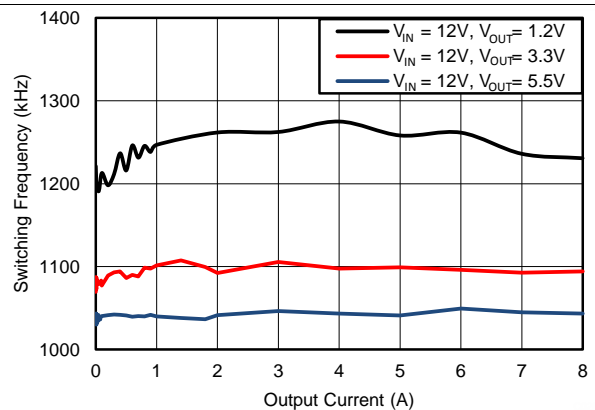
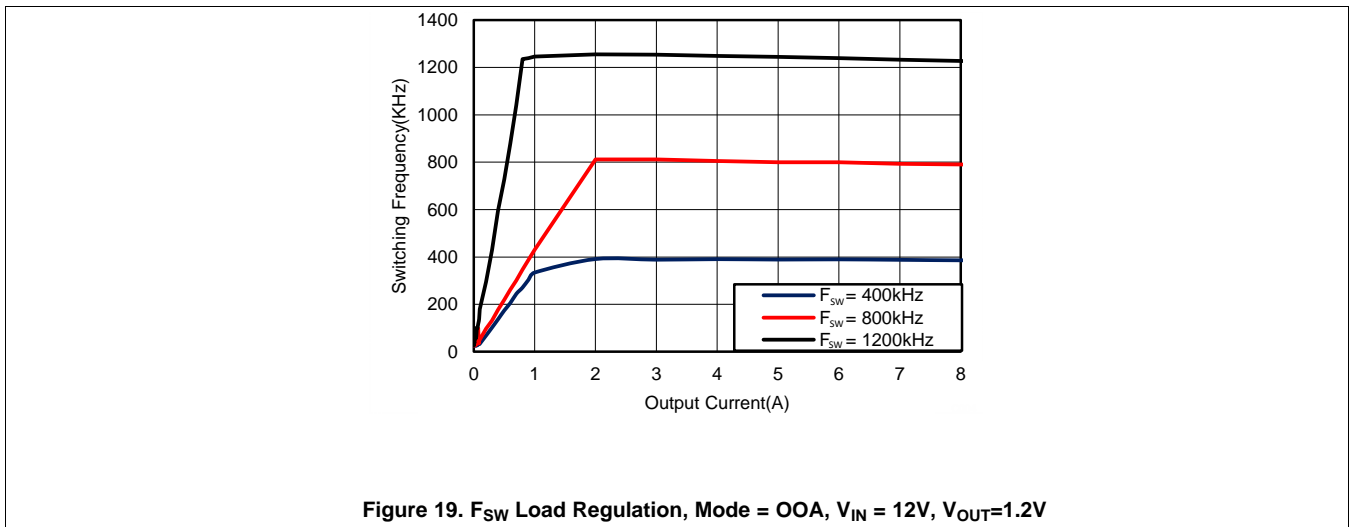


Figure 18.  $F_{SW}$  Load Regulation, Mode = FCCM,  $F_{SW} = 1200\text{kHz}$

**Typical Characteristics (continued)**



## 7 Detailed Description

### 7.1 Overview

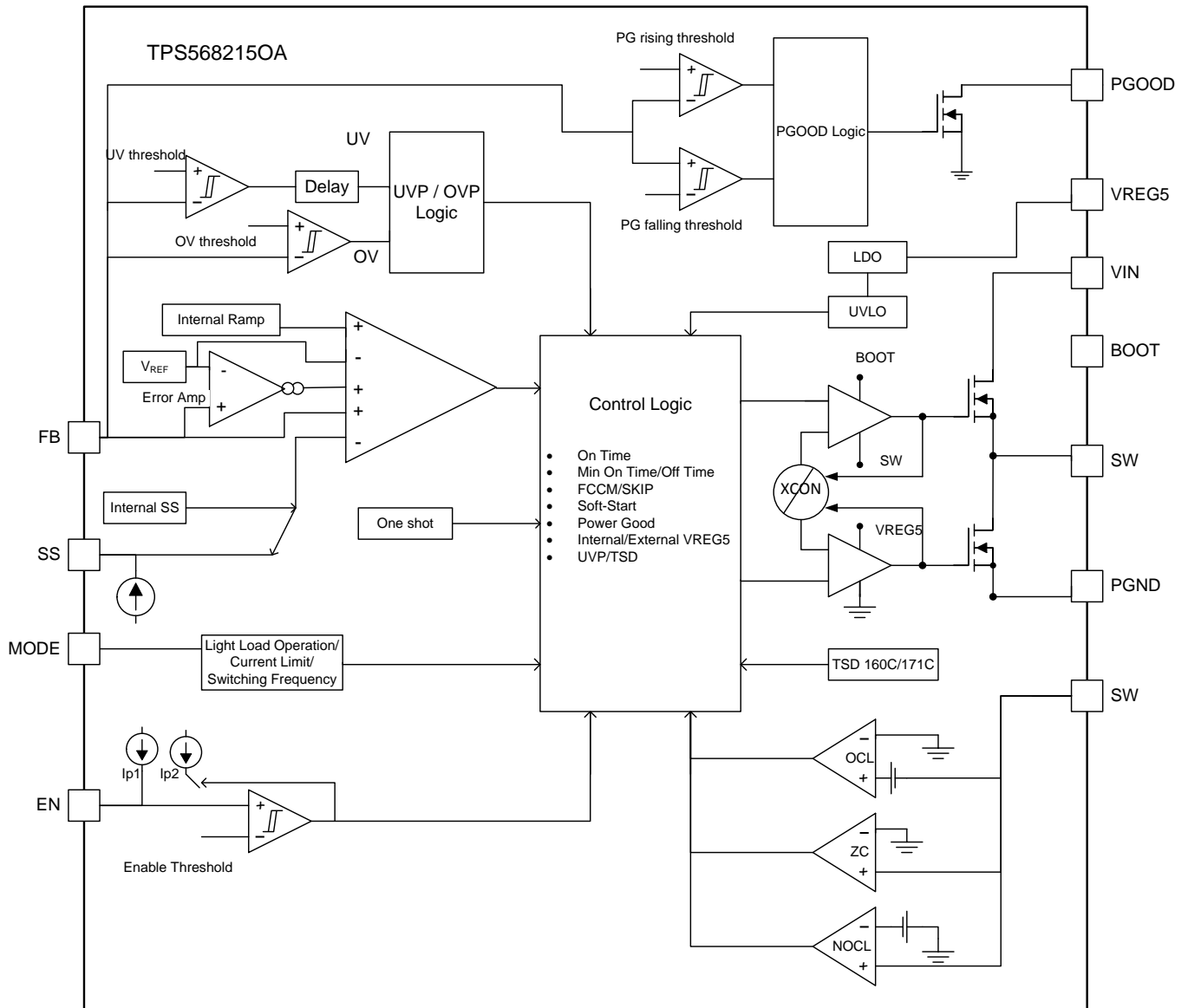
The TPS568215OA is a high density synchronous step down buck converter which can operate from 4.5-V to 17-V input voltage ( $V_{IN}$ ). It has 19-m $\Omega$  and 9-m $\Omega$  integrated MOSFETs that enable high efficiency up to 10 A. The device employs D-CAP3™ mode control that provides fast transient response with no external compensation components and an accurate feedback voltage. The control topology provides seamless transition between FCCM operating mode at higher load condition and OOA operation at lighter load condition. OOA feature allows the TPS568215OA to keep switching frequency above the audible frequency range. The TPS568215OA is able to adapt to both low equivalent series resistance (ESR) output capacitors such as POSCAP or SP-CAP, and ultralow ESR ceramic capacitors.

The TPS568215OA has three selectable switching frequencies ( $F_{SW}$ ) 400kHz, 800kHz and 1200kHz which gives the flexibility to optimize the design for higher efficiency or smaller size. There are three selectable current limits. All these options are configured by choosing the right voltage on the MODE pin.

The TPS568215OA has a 4.7 V internal LDO that creates bias for all internal circuitry. There is a feature to overdrive this internal LDO with an external voltage on the VREG5 pin which improves the converter's efficiency. The undervoltage lockout (UVLO) circuit monitors the VREG5 pin voltage to protect the internal circuitry from low input voltages. The device has an internal pull-up current source on the EN pin which can enable the device even with the pin floating.

Soft-start time can be selected by connecting a capacitor to the SS pin. The device is protected from output short, undervoltage and over temperature conditions.

## 7.2 Functional Block Diagram



Copyright © 2016, Texas Instruments Incorporated

## 7.3 Feature Description

### 7.3.1 PWM Operation and D-CAP3™ Control

The TPS568215OA operates using the adaptive on-time PWM control with a proprietary D-CAP3™ control which enables low external component count with a fast load transient response while maintaining a good output voltage accuracy. At the beginning of each switching cycle the high side MOSFET is turned on for an on-time set by an internal one shot timer. This on-time is set based on the converter's input voltage, output voltage and the pseudo-fixed frequency hence this type of control topology is called an adaptive on-time control. The one shot timer resets and turns on again once the feedback voltage ( $V_{FB}$ ) falls below the internal reference voltage ( $V_{REF}$ ). An internal ramp is generated which is fed to the FB pin to simulate the output voltage ripple. This enables the use of very low-ESR output capacitors such as multi-layered ceramic caps (MLCC). No external current sense network or loop compensation is required for DCAP3™ control topology.

The TPS568215OA includes an error amplifier that makes the output voltage very accurate. This error amplifier is absent in other flavors of DCAP3™. For any control topology that is compensated internally, there is a range of the output filter it can support. The output filter used with the TPS568215OA is a low pass L-C circuit. This L-C filter has double pole that is described in

$$f_P = \frac{1}{2 \times \pi \times \sqrt{L_{OUT} \times C_{OUT}}} \quad (1)$$

At low frequencies, the overall loop gain is set by the output set-point resistor divider network and the internal gain of the TPS568215OA. The low frequency L-C double pole has a 180 degree in phase. At the output filter frequency, the gain rolls off at a –40dB per decade rate and the phase drops rapidly. The internal ripple generation network introduces a high-frequency zero that reduces the gain roll off from –40dB to –20dB per decade and increases the phase to 90 degree one decade above the zero frequency. The internal ripple injection high frequency zero is changed according to the switching frequency selected as shown in table below. The inductor and capacitor selected for the output filter must be such that the double pole is located close enough to the high-frequency zero so that the phase boost provided by this high-frequency zero provides adequate phase margin for the stability requirement. The crossover frequency of the overall system should usually be targeted to be less than one-fifth of the switching frequency ( $F_{SW}$ ).

**Table 1. Ripple Injection Zero**

SWITCHING FREQUENCY (kHz)	ZERO LOCATION (kHz)
400	7.1
800	14.3
1200	21.4

Table 2 lists the inductor values and part numbers that are used to plot the efficiency curves in the *Typical Characteristics* section.

**Table 2. Inductor Values**

$V_{OUT}(V)$	$F_{SW}(kHz)$	$L_{OUT}(\mu H)$	Würth PART NUMBER <sup>(1)</sup>
1.2	400	1.2	744325120
	800	0.68	744311068
	1200	0.47	744314047
3.3	400	2.4	744325240
	800	1.5	744314150
	1200	1.1	744314110
5.5	400	3.3	744325330
	800	2.4	744325240
	1200	1.2	744325120

(1) See *Third-Party Products* disclaimer

### 7.3.2 Out-of-Audio Operation™

The TPS568215OA is designed with OOA feature that keeps switching frequency above the audible frequency region at light load or no load conditions. Once the converter determines that there is no switching for longer than 40 $\mu$ s, it turns on the LS FET which brings  $V_{FB}$  lower than internal  $V_{REF}$  and initiates a new Ton cycle. This ensures that the switching frequency doesn't go lower than 25kHz typical.

### 7.3.3 4.7 V LDO and External Bias

The VREG5 pin is the output of the internal 4.7-V linear regulator that creates the bias for all the internal circuitry and MOSFET gate drivers. The VREG5 pin needs to be bypassed with a 4.7- $\mu$ F capacitor. An external voltage that is above the LDO's internal output voltage can override the internal LDO, switching it to the external rail once a higher voltage is detected. This enhances the efficiency of the converter because the quiescent current now runs off this external rail instead of the input power supply. The UVLO circuit monitors the VREG5 pin voltage and disables the output when VREG5 falls below the UVLO threshold. When using an external bias on the VREG5 rail, any power-up and power-down sequencing can be applied but it is important to understand that if there is a discharge path on the VREG5 rail that can pull a current higher than the internal LDO's current limit (ILIM5) from the VREG5, then the VREG5 LDO turns off thereby shutting down the output of TPS568215OA. If such condition does not exist and if the external VREG5 rail is turned off, the VREG5 voltage switches over to the internal LDO voltage which is 4.7 V typically in a few nanoseconds. Figure 26 below shows this transition of the VREG5 voltage from an external bias of 5.5 V to the internal LDO output of 4.7 V when the external bias to VREG5 is disabled while the output of TPS568215OA remains unchanged.

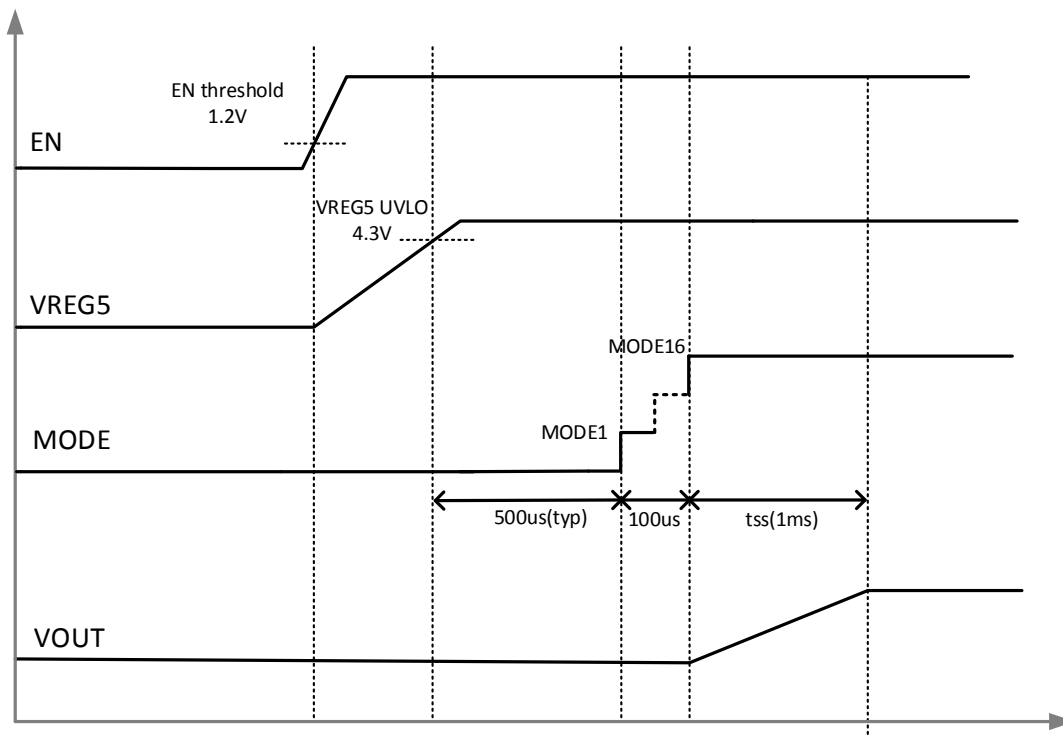
### 7.3.4 MODE Selection

TPS568215OA has a MODE pin that can offer 16 different states of operation as a combination of Current Limit, Switching Frequency and Light Load operation. The device can operate at three different current limits ILIM-1, ILIM and ILIM+1 to support an output continuous current of 6 A, 8 A and 10A respectively. The device can provide 10A output current only at switching frequencies of 400kHz and 800kHz. The TPS568215OA is designed to compare the valley current of the inductor against the current limit thresholds so it is important to understand that the output current will be half the ripple current above the valley current. TPS568215OA can operate at three different frequencies of 400 kHz, 800 kHz and 1200 kHz and also can choose between OOA and FCCM mode. The device reads the voltage on the MODE pin during start-up and latches onto one of the MODE options listed below in table 3. The voltage on the MODE pin can be set by connecting this pin to the center tap of a resistor divider connected between VREG5 and AGND. A guideline for the top resistor ( $R_{M\_H}$ ) and the bottom resistor ( $R_{M\_L}$ ) as 5% resistors is shown in Table 3. It is important that the voltage for the MODE pin is derived from the VREG5 rail only since internally this voltage is referenced to detect the MODE option. The MODE pin setting can be reset only by a VIN power cycling.

**Table 3. Mode Pin Resistor Settings**

$R_{M\_L}$ (k $\Omega$ )	$R_{M\_H}$ (k $\Omega$ )	LIGHT LOAD OPERATION	CURRENT LIMIT	FREQUENCY (kHz)
5.1	300	FCCM	ILIM-1	400
10	200	FCCM	ILIM	400
20	240	FCCM	ILIM+1	400
20	160	FCCM	ILIM-1	800
20	120	FCCM	ILIM	800
51	240	FCCM	ILIM+1	800
51	200	FCCM	ILIM-1	1200
51	180	FCCM	ILIM	1200
51	150	OOA	ILIM-1	400
51	120	OOA	ILIM	400
51	110	OOA	ILIM+1	400
51	91	OOA	ILIM-1	800
51	82	OOA	ILIM	800
51	75	OOA	ILIM+1	800
51	62	OOA	ILIM-1	1200
51	51	OOA	ILIM	1200

Figure 20 below shows the typical start-up sequence of the device once the enable signal crosses the EN turn-on threshold. After the voltage on VREG5 crosses the rising UVLO threshold it takes about 500us to read the first mode setting and approximately 100us from there to finish the last mode setting. The output voltage starts ramping after the mode reading is done.



**Figure 20. Power-Up Sequence**

### 7.3.5 Soft Start and Pre-biased Soft Start

The TPS568215OA has an adjustable soft-start time that can be set by connecting a capacitor on SS pin. When the EN pin becomes high, the soft-start charge current ( $I_{SS}$ ) begins charging the external capacitor ( $C_{SS}$ ) connected between SS and AGND. The device tracks the lower of the internal soft-start voltage or the external soft-start voltage as the reference. The equation for the soft-start time ( $T_{SS}$ ) is shown in Equation 2:

$$T_{SS(S)} = \frac{C_{SS} \times V_{REF}}{I_{SS}}$$

where

- $V_{REF}$  is 0.6 V and  $I_{SS}$  is 6  $\mu$ A (2)

If the output capacitor is pre-biased at startup, the device initiates switching and starts ramping up only after the internal reference voltage becomes greater than the feedback voltage  $V_{FB}$ . This scheme ensures that the converters ramp up smoothly into regulation point.

### 7.3.6 Enable and Adjustable UVLO

The EN pin controls the turn-on and turn-off of the device. When EN pin voltage is above the turn-on threshold which is around 1.2 V, the device starts switching and when the EN pin voltage falls below the turn-off threshold which is around 1.1V it stops switching. If the user application requires a different turn-on ( $V_{START}$ ) and turn-off thresholds ( $V_{STOP}$ ) respectively, the EN pin can be configured as shown in Figure 21 by connecting a resistor divider between VIN and EN. The EN pin has a pull-up current  $I_{p1}$  that sets the default state of the pin when it is floating. This current increases to  $I_{p2}$  when the EN pin voltage crosses the turn-on threshold. The UVLO thresholds can be set by using Equation 3 and Equation 4.



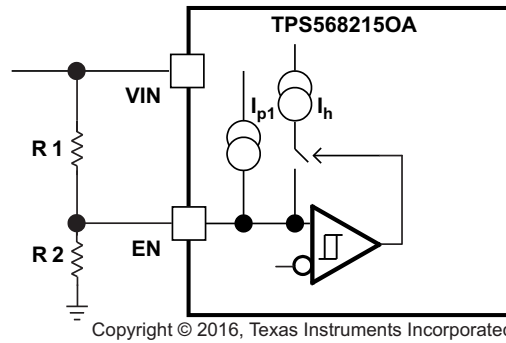


Figure 21. Adjustable VIN Under Voltage Lock Out

$$R1 = \frac{V_{START} \left( \frac{V_{ENFALLING}}{V_{ENRISING}} \right) - V_{STOP}}{I_{p1} \left( 1 - \frac{V_{ENFALLING}}{V_{ENRISING}} \right) + I_h} \quad (3)$$

$$R2 = \frac{R1 \times V_{ENFALLING}}{V_{STOP} - V_{ENFALLING} + R1 I_{p2}}$$

where

- $I_{p2} = 4.197 \mu A$
  - $I_{p1} = 1.91 \mu A$
  - $I_h = 2.287 \mu A$
  - $V_{ENRISING} = 1.225 V$
  - $V_{ENFALLING} = 1.104 V$
- (4)

### 7.3.7 Power Good

The Power Good (PGOOD) pin is an open drain output. Once the FB pin voltage is between 93% and 107% of the internal reference voltage ( $V_{REF}$ ) the PGOOD is de-asserted and floats after a 200  $\mu s$  de-glitch time. A pull-up resistor of 10 k $\Omega$  is recommended to pull it up to VREG5. The PGOOD pin is pulled low when the FB pin voltage is lower than  $V_{UVP}$  or greater than  $V_{OVP}$  threshold; or, in an event of thermal shutdown or during the soft-start period.

### 7.3.8 Over Current Protection and Under Voltage Protection

The output overcurrent limit (OCL) is implemented using a cycle-by-cycle valley detect control circuit. The switch current is monitored during the OFF state by measuring the low-side FET drain to source voltage. This voltage is proportional to the switch current. During the on time of the high-side FET switch, the switch current increases at a linear rate determined by input voltage, output voltage, the on-time and the output inductor value. During the on time of the low-side FET switch, this current decreases linearly. The average value of the switch current is the load current  $I_{OUT}$ . If the measured drain to source voltage of the low-side FET is above the voltage proportional to current limit, the low side FET stays on until the current level becomes lower than the OCL level which reduces the output current available. When the current is limited the output voltage tends to drop because the load demand is higher than what the converter can support. When the output voltage falls below 68% of the target voltage, the UVP comparator detects it and shuts down the device after a wait time of 1ms, the device re-starts after a hiccup time of 7ms. In this type of valley detect control the load current is higher than the OCL threshold by one half of the peak to peak inductor ripple current. When the overcurrent condition is removed, the output voltage returns to the regulated value. If an OCL condition happens during start-up then the device enters hiccup-mode immediately without a wait time of 1ms.

### 7.3.9 Out-of-Bounds Operation

The device has an out-of-bounds (OOB) overvoltage protection that protects the output load at a much lower overvoltage threshold of 8% above the target voltage. OOB protection does not trigger an overvoltage fault, OOB protection operates as an early no-fault overvoltage protection mechanism. During the OOB operation, the controller operates in forced PWM mode only by turning on the low-side FET. Turning on the low-side FET beyond the zero inductor current quickly discharges the output capacitor thus causing the output voltage to fall quickly toward the setpoint. During the operation, the cycle-by cycle negative current limit is also activated to ensure the safe operation of the internal FETs.

#### 7.3.10 UVLO Protection

Under voltage lock out protection (UVLO) monitors the internal VREG5 regulator voltage. When the VREG5 voltage is lower than UVLO threshold voltage, the device is shut off. This protection is non-latching.

#### 7.3.11 Thermal Shutdown

The device monitors the internal die temperature. If this temperature exceeds the thermal shutdown threshold value ( $T_{SDN}$  typically 160°C) the device shuts off. This is a non-latch protection. During start up, if the device temperature is higher than 160°C the device does not start switching and does not load the MODE settings. If the device temp goes higher than  $T_{SDN}$  threshold after startup, it stops switching with SS reset to ground and an internal discharge switch turns on to quickly discharge the output voltage. The device re-starts switching when the temperature goes below the thermal shutdown threshold but the MODE settings are not re-loaded again. There is a second higher thermal protection on the device  $T_{SDN\_VREG5}$  which protects it from over temperature conditions not caused by the switching of the device itself. This threshold is at typically 170°C. Even under nonswitching condition of the device after exceeding  $T_{SDN}$  threshold, if it still continues to heat up the VREG5 output shuts off once temperature goes beyond  $T_{SDN\_VREG5}$ , thereby shutting down the device completely.

#### 7.3.12 Output Voltage Discharge

The device has a 500ohm discharge switch that discharges the output  $V_{OUT}$  through SW node during any event of fault like output overvoltage, output undervoltage, TSD, if VREG5 voltage below the UVLO and when the EN pin voltage ( $V_{EN}$ ) is below the turn-on threshold.

## 7.4 Device Functional Modes

### 7.4.1 Light Load Operation

When the MODE pin is selected to operate in FCCM mode, the converter operates in continuous conduction mode (FCCM) during light-load conditions. During FCCM, the switching frequency ( $F_{SW}$ ) is maintained at an almost constant level over the entire load range which is suitable for applications requiring tight control of the switching frequency and output voltage ripple at the cost of lower efficiency under light load. If the MODE pin is selected to operate in OOA, the device enters pulse skip mode after the valley of the inductor ripple current crosses zero. The OOA mode maintains higher efficiency at light load with a lower switching frequency but this switching frequency is restricted to not go below 25kHz typical.

### 7.4.2 Standby Operation

The TPS5682150A can be placed in standby mode by pulling the EN pin low. The device operates with a shutdown current of 7uA when in standby condition.

## 8 Application and Implementation

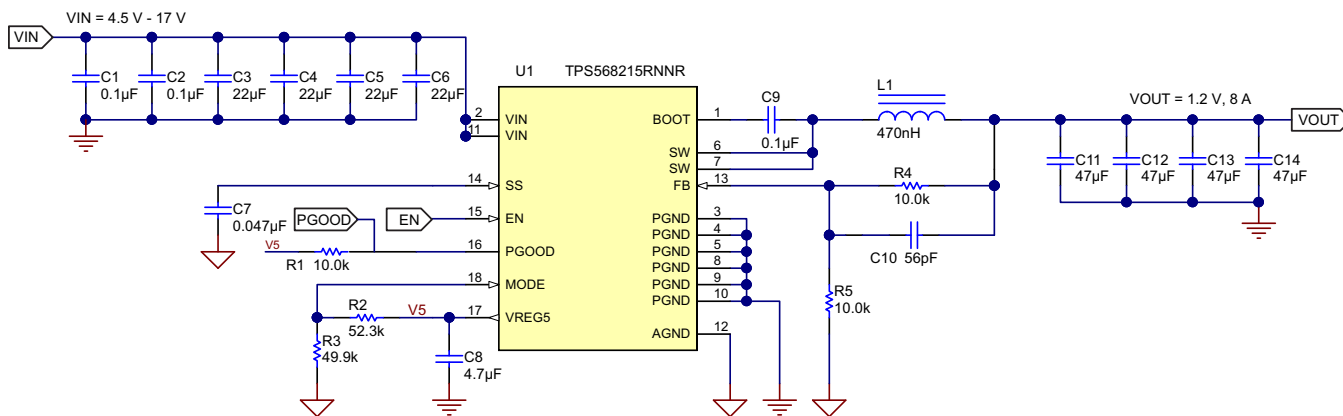
### NOTE

Information in the following applications sections is not part of the TI component specification, and TI does not warrant its accuracy or completeness. TI's customers are responsible for determining suitability of components for their purposes. Customers should validate and test their design implementation to confirm system functionality.

### 8.1 Application Information

The schematic of Figure 22 shows a typical application for TPS568215OA. This design converts an input voltage range of 4.5 V to 17 V down to 1.2 V with a maximum output current of 10 A.

### 8.2 Typical Application



Copyright © 2016, Texas Instruments Incorporated

Figure 22. Application Schematic

#### 8.2.1 Design Requirements

Table 4. Design Parameters

PARAMETER	CONDITIONS	MIN	TYP	MAX	UNIT
$V_{OUT}$	Output voltage		1.2		V
$I_{OUT}$	Output current		10		A
$\Delta V_{OUT}$	Transient response		±30		mV
$V_{IN}$	Input voltage	4.5	12	17	V
$V_{OUT(ripple)}$	Output voltage ripple		<10		mV <sub>(P-P)</sub>
	Start input voltage		Internal UVLO		V
	Stop input voltage		Internal UVLO		V
$f_{SW}$	Switching frequency		1.2		MHz
Operating Mode			OOA		
$T_A$	Ambient temperature		25		°C

## 8.2.2 Detailed Design Procedure

### 8.2.2.1 External Component Selection

#### 8.2.2.1.1 Output Voltage Set Point

To change the output voltage of the application, it is necessary to change the value of the upper feedback resistor. By changing this resistor the user can change the output voltage above 0.6 V. See [Equation 5](#)

$$V_{OUT} = 0.6 \times \left( 1 + \frac{R_{UPPER}}{R_{LOWER}} \right) \quad (5)$$

#### 8.2.2.1.2 Switching Frequency and Mode Selection

Switching Frequency, current limit and switching mode (OOA or FCCM) are set by a voltage divider from VREG5 to GND connected to the MODE pin. See [Table 3](#) for possible MODE pin configurations. Switching frequency selection is a tradeoff between higher efficiency and smaller system solution size. Lower switching frequency yields higher overall efficiency but relatively bigger external components. Higher switching frequencies cause additional switching losses which impact efficiency and thermal performance. For this design 1.2 MHz is chosen as the switching frequency, the switching mode is OOA and the output current is 8 A.

#### 8.2.2.1.3 Inductor Selection

The inductor ripple current is filtered by the output capacitor. A higher inductor ripple current means the output capacitor should have a ripple current rating higher than the inductor ripple current. See [Table 5](#) for recommended inductor values.

The RMS and peak currents through the inductor can be calculated using [Equation 6](#) and [Equation 7](#). It is important that the inductor is rated to handle these currents.

$$I_{L(rms)} = \sqrt{I_{OUT}^2 + \frac{1}{12} \times \left( \frac{V_{OUT} \times (V_{IN(max)} - V_{OUT})}{V_{IN(max)} \times L_{OUT} \times F_{SW}} \right)^2} \quad (6)$$

$$I_{L(peak)} = I_{OUT} + \frac{I_{OUT(ripple)}}{2} \quad (7)$$

During transient/short circuit conditions the inductor current can increase up to the current limit of the device so it is safe to choose an inductor with a saturation current higher than the peak current under current limit condition.

#### 8.2.2.1.4 Output Capacitor Selection

After selecting the inductor the output capacitor needs to be optimized. In DCAP3, the regulator reacts within one cycle to the change in the duty cycle so the good transient performance can be achieved without needing large amounts of output capacitance. The recommended output capacitance range is given in [Table 5](#)

Ceramic capacitors have very low ESR, otherwise the maximum ESR of the capacitor should be less than  $V_{OUT(ripple)}/I_{OUT(ripple)}$

**Table 5. Recommended Component Values**

V <sub>OUT</sub> (V)	R <sub>LOWER</sub> (kΩ)	R <sub>UPPER</sub> (kΩ)	F <sub>SW</sub> (kHz)	L <sub>OUT</sub> (μH)	C <sub>OUT(min)</sub> (μF)	C <sub>OUT(max)</sub> (μF)	C <sub>FF</sub> (pF)
0.6	10	0	400	0.68	300	500	–
			800	0.47	100	500	–
			1200	0.33	88	500	–
1.2		10	400	1.2	100	500	–
			800	0.68	88	500	–
			1200	0.47	88	500	–
3.3		45.3	400	2.4	88	500	100–220
			800	1.5	88	500	100–220
			1200	1.1	88	500	100–220

Table 5. Recommended Component Values (continued)

V <sub>OUT</sub> (V)	R <sub>LOWER</sub> (kΩ)	R <sub>UPPER</sub> (kΩ)	F <sub>SW</sub> (kHz)	L <sub>OUT</sub> (μH)	C <sub>OUT(min)</sub> (μF)	C <sub>OUT(max)</sub> (μF)	C <sub>FF</sub> (pF)
5.5		82.5	400	3.3	88	500	100–220
			800	2.4	88	500	100–220
			1200	1.2	88	700	100–220

8.2.2.1.5 Input Capacitor Selection

The minimum input capacitance required is given in Equation 8.

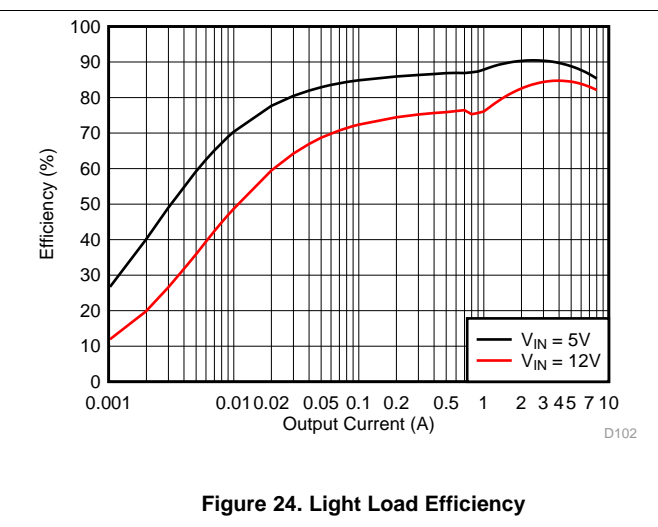
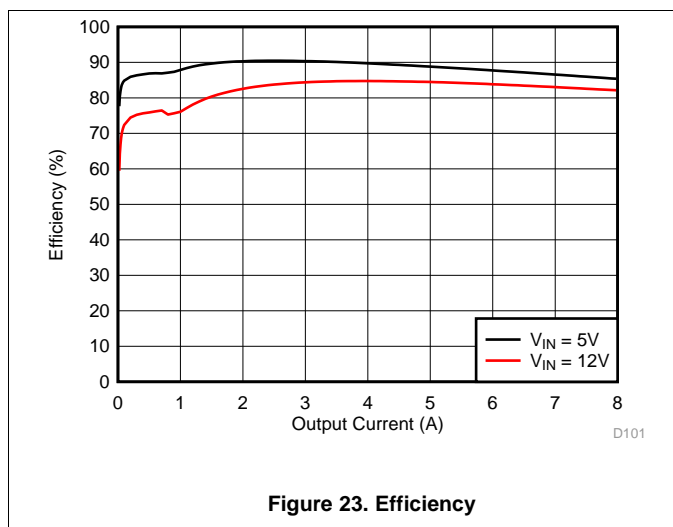
$$C_{IN(min)} = \frac{I_{OUT} \times V_{OUT}}{V_{IN(ripple)} \times V_{IN} \times F_{SW}} \tag{8}$$

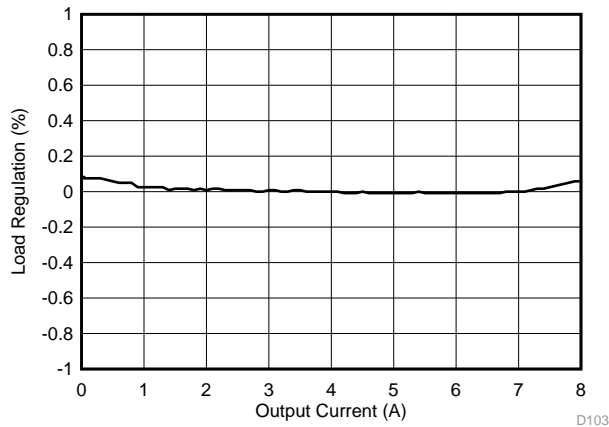
TI recommends using a high quality X5R or X7R input decoupling capacitors of 40 μF on the input voltage pin. The voltage rating on the input capacitor must be greater than the maximum input voltage. The capacitor must also have a ripple current rating greater than the maximum input current ripple of the application. The input ripple current is calculated by Equation 9 below:

$$I_{CIN(rms)} = I_{OUT} \times \sqrt{\frac{V_{OUT}}{V_{IN(min)}} \times \frac{(V_{IN(min)} - V_{OUT})}{V_{IN(min)}}} \tag{9}$$

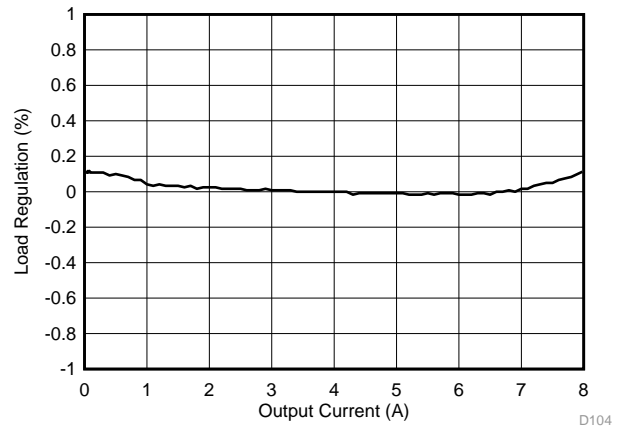
8.2.3 Application Curves

Figure 23 through Figure 39 apply to the circuit of Figure 22. V<sub>IN</sub> = 12 V. T<sub>a</sub> = 25 °C unless otherwise specified.

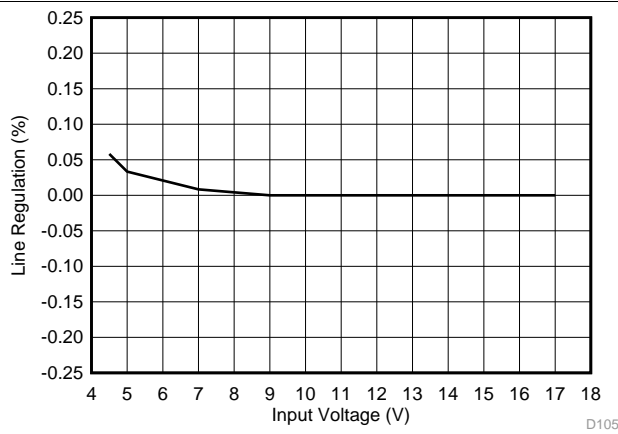




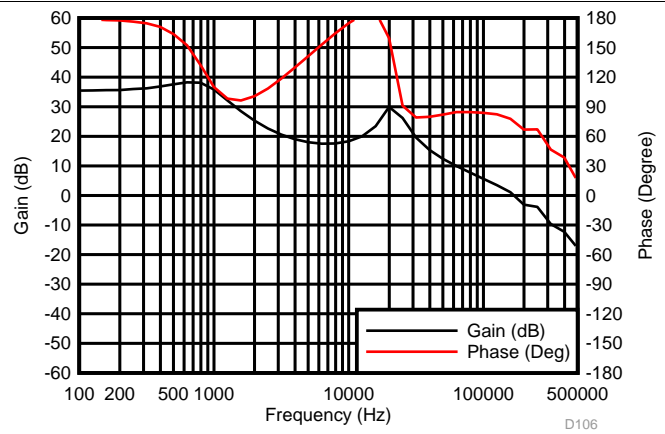
**Figure 25. Load Regulation,  $V_{IN} = 5\text{ V}$**



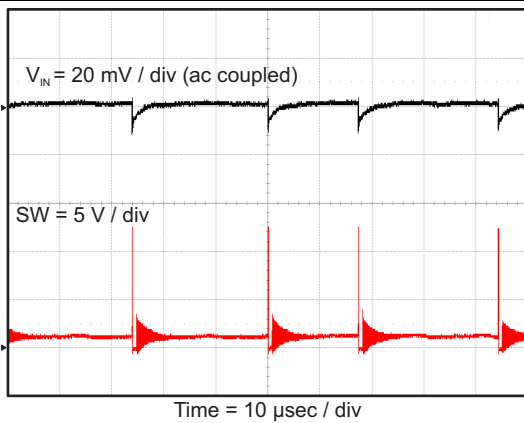
**Figure 26. Load Regulation,  $V_{IN} = 12\text{ V}$**



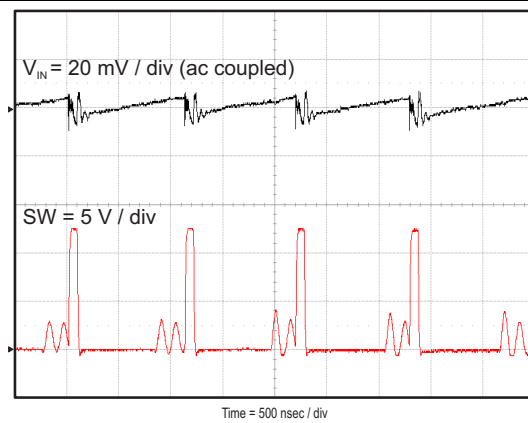
**Figure 27. Line Regulation,  $I_{OUT} = 6\text{ A}$**



**Figure 28. Loop Response,  $I_{OUT} = 6\text{ A}$**



**Figure 29. Input Voltage Ripple,  $I_{OUT} = 10\text{ mA}$**



**Figure 30. Input Voltage Ripple,  $I_{OUT} = 700\text{ mA}$**

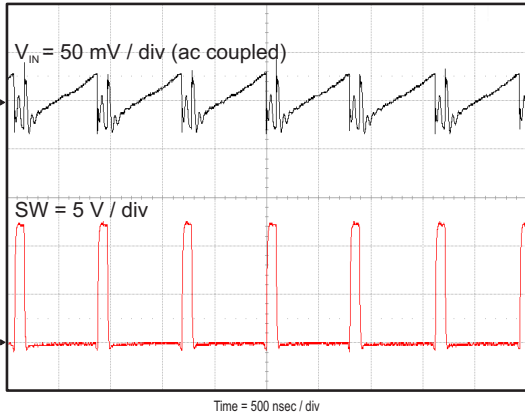


Figure 31. Input Voltage Ripple,  $I_{OUT} = 8 \text{ A}$

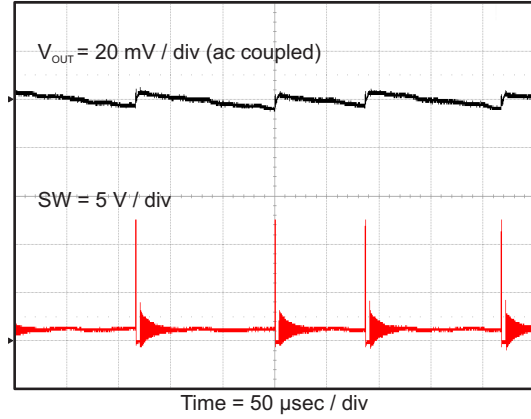


Figure 32. Output Voltage Ripple,  $I_{OUT} = 10 \text{ mA}$

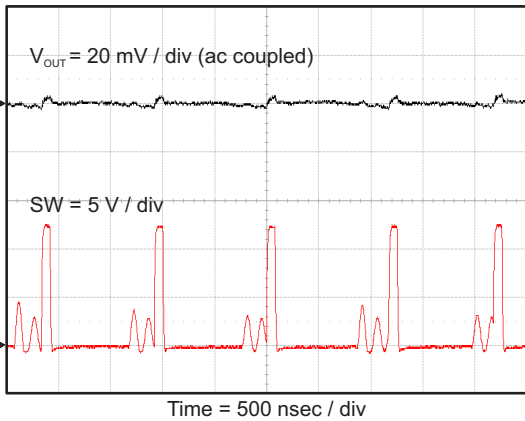


Figure 33. Output Voltage Ripple,  $I_{OUT} = 700 \text{ mA}$

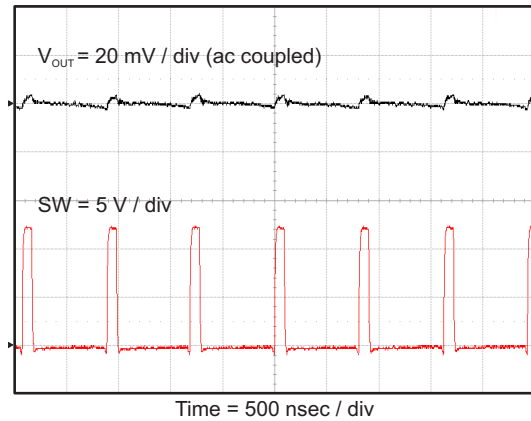


Figure 34. Output Voltage Ripple,  $I_{OUT} = 8 \text{ A}$

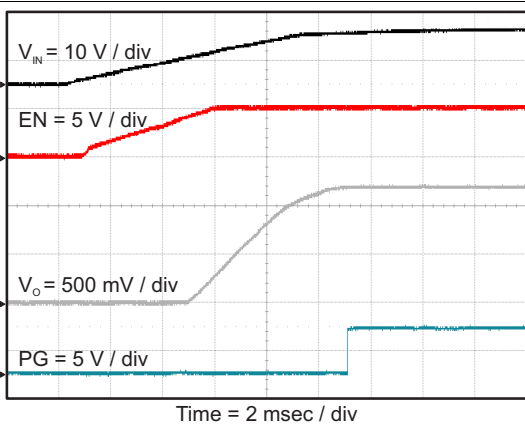


Figure 35. Start Up Relative to  $V_{IN}$  Rising

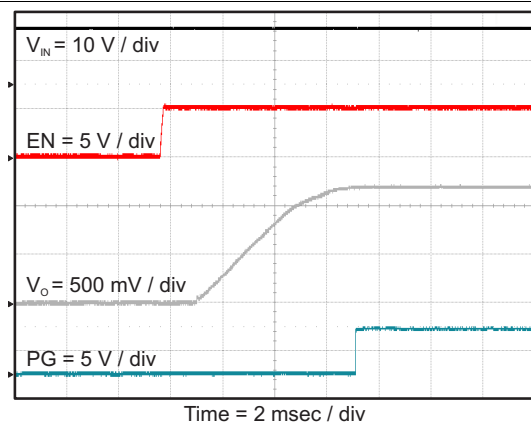
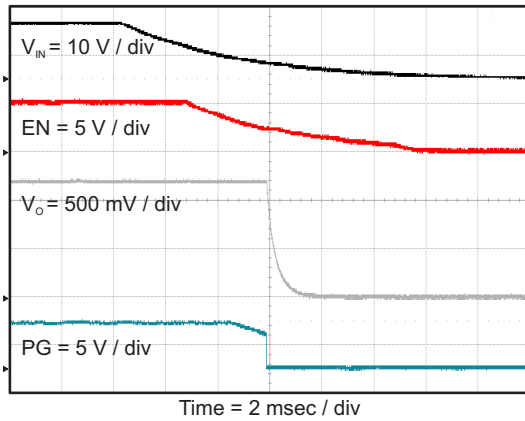
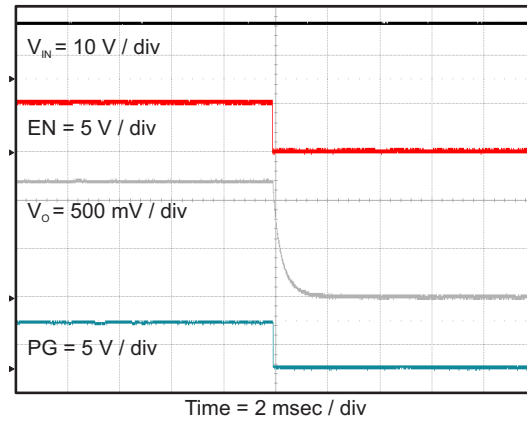
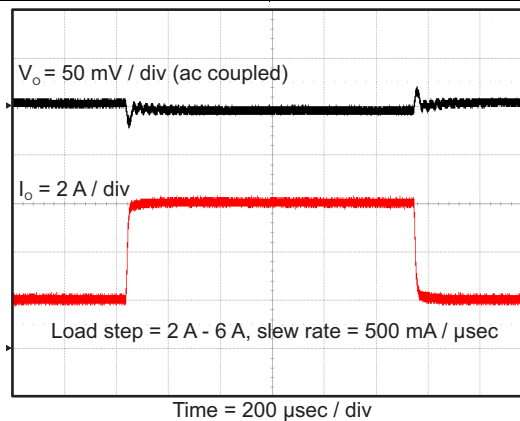


Figure 36. Start Up Relative to EN Rising


**Figure 37. Shut Down Relative to  $V_{IN}$  Falling**

**Figure 38. Shut Down Relative to EN Falling**

**Figure 39. Transient Response**

## 9 Power Supply Recommendations

The TPS568215OA is intended to be powered by a well regulated dc voltage. The input voltage range is 4.5 to 17 V. TPS568215OA is a buck converter. The input supply voltage must be greater than the desired output voltage for proper operation. Input supply current must be appropriate for the desired output current. If the input voltage supply is located far from the TPS568215OA circuit, some additional input bulk capacitance is recommended. Typical values are 100  $\mu\text{F}$  to 470  $\mu\text{F}$ .



## 10 Layout

### 10.1 Layout Guidelines

- Recommend a four-layer or six-layer PCB for good thermal performance and with maximum ground plane. 3" x 3", four-layer PCB with 2-oz. copper used as example.
- Recommend having equal caps on each side of the IC. Place them right across VIN as close as possible.
- Inner layer 1 will be ground with the PGND to AGND net tie
- Inner layer2 has VIN copper pour that has vias to the top layer VIN. **Place multiple vias under the device near VIN and GND and near input capacitors** to reduce parasitic inductance and improve thermal performance
- Bottom later is GND with the BOOT trace routing.
- Feedback should be referenced to the quite AGND and routed away from the switch node.
- VIN trace must be wide to reduce the trace impedance.

### 10.2 Layout Example

Figure 40 shows the recommended top side layout. Component reference designators are the same as the circuit shown in Figure 22. Resistor divider for EN is not used in the circuit of Figure 22, but are shown in the layout for reference.

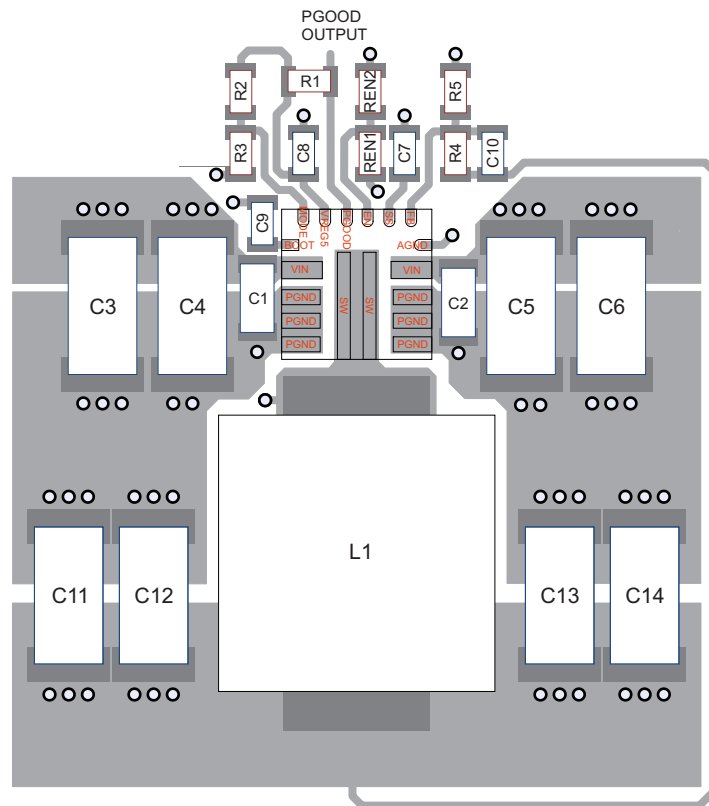
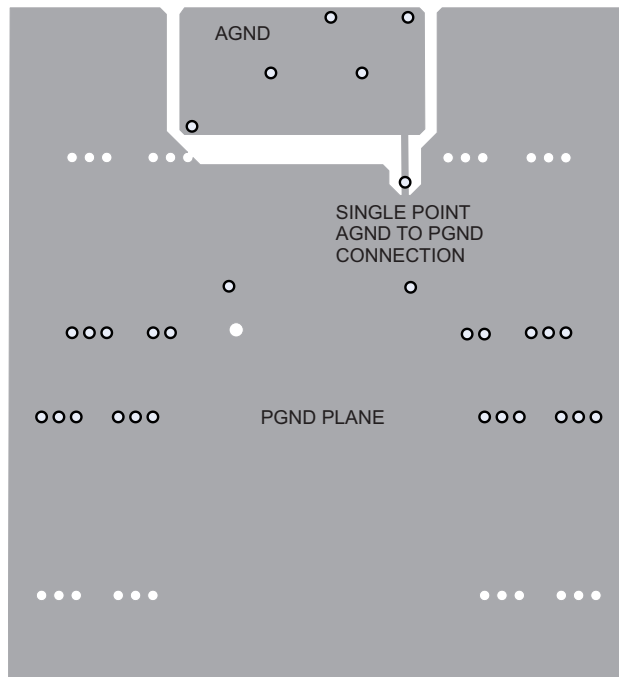


Figure 40. Top Side Layout

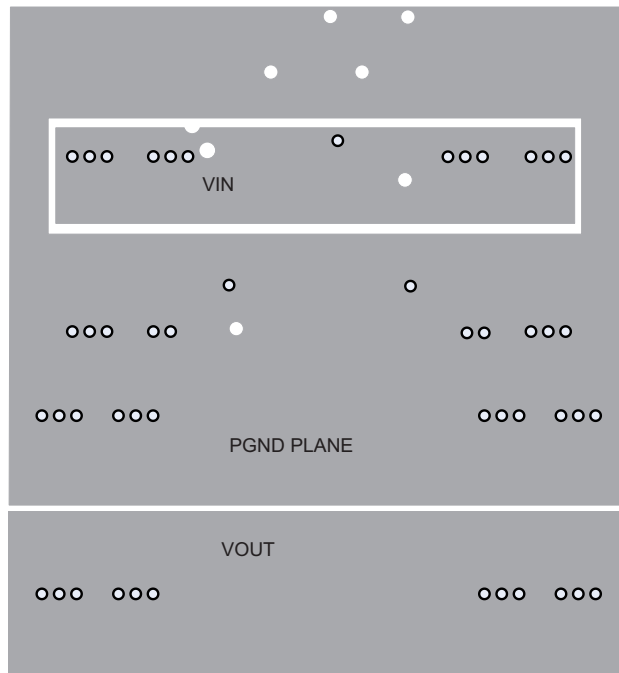
**Layout Example (continued)**

Figure 41 shows the recommended layout for the first internal layer. It is comprised of a large PGND plane and a smaller AGND island. AGND and PGND are connected at a single point to reduce circulating currents.



**Figure 41. Mid Layer 1 Layout**

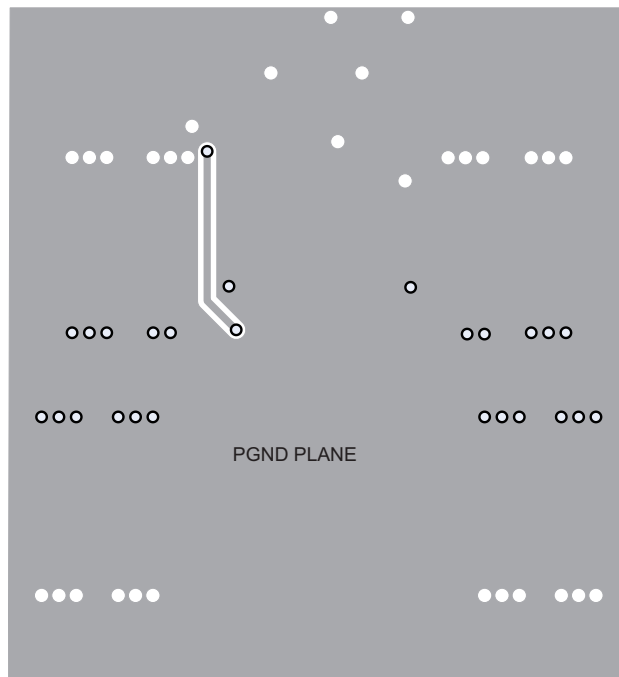
Figure 42 shows the recommended layout for the second internal layer. It is comprised of a large PGND plane, a smaller copper fill area to connect the two top side  $V_{IN}$  copper areas and a second  $V_{OUT}$  copper fill area.



**Figure 42. Mid Layer 2 Layout**

**Layout Example (continued)**

Figure 43 shows the recommended layout for the bottom layer. It is comprised of a large PGND plane and a trace to connect the BOOT capacitor to the SW node.



**Figure 43. Bottom Layer Layout**

## 11 Device and Documentation Support

### 11.1 Device Support

#### 11.1.1 Third-Party Products Disclaimer

TI'S PUBLICATION OF INFORMATION REGARDING THIRD-PARTY PRODUCTS OR SERVICES DOES NOT CONSTITUTE AN ENDORSEMENT REGARDING THE SUITABILITY OF SUCH PRODUCTS OR SERVICES OR A WARRANTY, REPRESENTATION OR ENDORSEMENT OF SUCH PRODUCTS OR SERVICES, EITHER ALONE OR IN COMBINATION WITH ANY TI PRODUCT OR SERVICE.

#### 11.1.2 Development Support

- [TPS568215EVM-762 8-A, SWIFT™ Regulator Evaluation Module User's Guide](#)

### 11.2 Receiving Notification of Documentation Updates

To receive notification of documentation updates, navigate to the device product folder on ti.com. In the upper right corner, click on *Alert me* to register and receive a weekly digest of any product information that has changed. For change details, review the revision history included in any revised document.

### 11.3 Community Resources

The following links connect to TI community resources. Linked contents are provided "AS IS" by the respective contributors. They do not constitute TI specifications and do not necessarily reflect TI's views; see TI's [Terms of Use](#).

**TI E2E™ Online Community** *TI's Engineer-to-Engineer (E2E) Community*. Created to foster collaboration among engineers. At e2e.ti.com, you can ask questions, share knowledge, explore ideas and help solve problems with fellow engineers.

**Design Support** *TI's Design Support* Quickly find helpful E2E forums along with design support tools and contact information for technical support.

### 11.4 Trademarks

D-CAP3, HotRod, Out-of-Audio Operation, E2E are trademarks of Texas Instruments. All other trademarks are the property of their respective owners.

### 11.5 Electrostatic Discharge Caution



These devices have limited built-in ESD protection. The leads should be shorted together or the device placed in conductive foam during storage or handling to prevent electrostatic damage to the MOS gates.

### 11.6 Glossary

[SLYZ022](#) — *TI Glossary*.

This glossary lists and explains terms, acronyms, and definitions.

## 12 Mechanical, Packaging, and Orderable Information

The following pages include mechanical, packaging, and orderable information. This information is the most current data available for the designated devices. This data is subject to change without notice and revision of this document. For browser-based versions of this data sheet, refer to the left-hand navigation.

**PACKAGING INFORMATION**

Orderable Device	Status (1)	Package Type	Package Drawing	Pins	Package Qty	Eco Plan (2)	Lead finish/ Ball material (6)	MSL Peak Temp (3)	Op Temp (°C)	Device Marking (4/5)	Samples
TPS568215OARNNR	ACTIVE	VQFN-HR	RNN	18	3000	RoHS & Green	Call TI   SN	Level-2-260C-1 YEAR	-40 to 125	215OA	<a href="#">Samples</a>
TPS568215OARNNT	ACTIVE	VQFN-HR	RNN	18	250	RoHS & Green	Call TI   SN	Level-2-260C-1 YEAR	-40 to 125	215OA	<a href="#">Samples</a>

(1) The marketing status values are defined as follows:

**ACTIVE:** Product device recommended for new designs.

**LIFEBUY:** TI has announced that the device will be discontinued, and a lifetime-buy period is in effect.

**NRND:** Not recommended for new designs. Device is in production to support existing customers, but TI does not recommend using this part in a new design.

**PREVIEW:** Device has been announced but is not in production. Samples may or may not be available.

**OBSOLETE:** TI has discontinued the production of the device.

(2) **RoHS:** TI defines "RoHS" to mean semiconductor products that are compliant with the current EU RoHS requirements for all 10 RoHS substances, including the requirement that RoHS substance do not exceed 0.1% by weight in homogeneous materials. Where designed to be soldered at high temperatures, "RoHS" products are suitable for use in specified lead-free processes. TI may reference these types of products as "Pb-Free".

**RoHS Exempt:** TI defines "RoHS Exempt" to mean products that contain lead but are compliant with EU RoHS pursuant to a specific EU RoHS exemption.

**Green:** TI defines "Green" to mean the content of Chlorine (Cl) and Bromine (Br) based flame retardants meet JS709B low halogen requirements of <=1000ppm threshold. Antimony trioxide based flame retardants must also meet the <=1000ppm threshold requirement.

(3) MSL, Peak Temp. - The Moisture Sensitivity Level rating according to the JEDEC industry standard classifications, and peak solder temperature.

(4) There may be additional marking, which relates to the logo, the lot trace code information, or the environmental category on the device.

(5) Multiple Device Markings will be inside parentheses. Only one Device Marking contained in parentheses and separated by a "~" will appear on a device. If a line is indented then it is a continuation of the previous line and the two combined represent the entire Device Marking for that device.

(6) Lead finish/Ball material - Orderable Devices may have multiple material finish options. Finish options are separated by a vertical ruled line. Lead finish/Ball material values may wrap to two lines if the finish value exceeds the maximum column width.

**Important Information and Disclaimer:**The information provided on this page represents TI's knowledge and belief as of the date that it is provided. TI bases its knowledge and belief on information provided by third parties, and makes no representation or warranty as to the accuracy of such information. Efforts are underway to better integrate information from third parties. TI has taken and continues to take reasonable steps to provide representative and accurate information but may not have conducted destructive testing or chemical analysis on incoming materials and chemicals. TI and TI suppliers consider certain information to be proprietary, and thus CAS numbers and other limited information may not be available for release.

In no event shall TI's liability arising out of such information exceed the total purchase price of the TI part(s) at issue in this document sold by TI to Customer on an annual basis.



**TAPE AND REEL INFORMATION**

**QUADRANT ASSIGNMENTS FOR PIN 1 ORIENTATION IN TAPE**


\*All dimensions are nominal

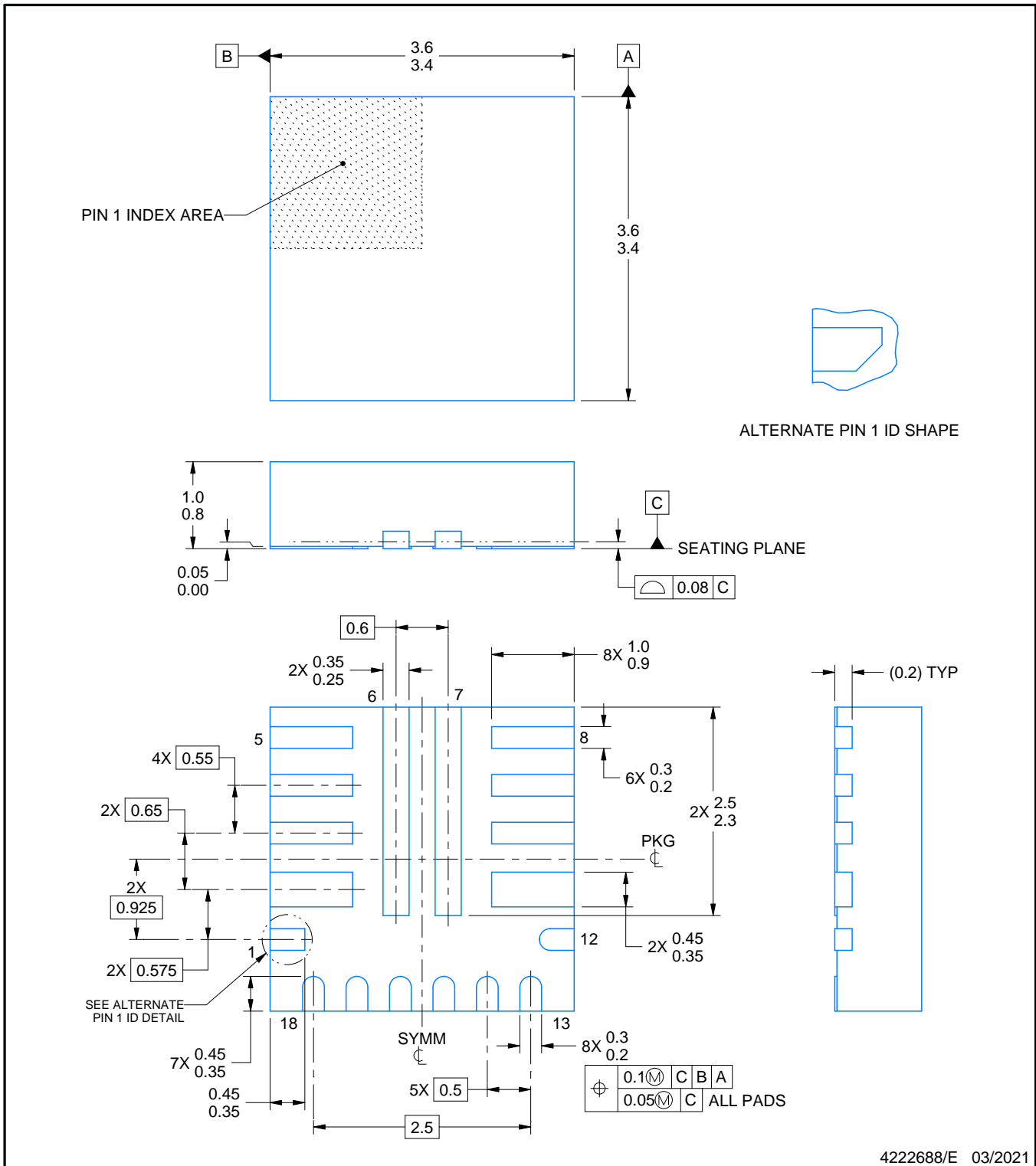
Device	Package Type	Package Drawing	Pins	SPQ	Reel Diameter (mm)	Reel Width W1 (mm)	A0 (mm)	B0 (mm)	K0 (mm)	P1 (mm)	W (mm)	Pin1 Quadrant
TPS568215OARNNR	VQFN-HR	RNN	18	3000	330.0	12.4	3.75	3.75	1.15	8.0	12.0	Q2
TPS568215OARNNT	VQFN-HR	RNN	18	250	180.0	12.4	3.75	3.75	1.15	8.0	12.0	Q2

**TAPE AND REEL BOX DIMENSIONS**


\*All dimensions are nominal

Device	Package Type	Package Drawing	Pins	SPQ	Length (mm)	Width (mm)	Height (mm)
TPS568215OARNNR	VQFN-HR	RNN	18	3000	346.0	346.0	33.0
TPS568215OARNNT	VQFN-HR	RNN	18	250	210.0	185.0	35.0





**NOTES:**

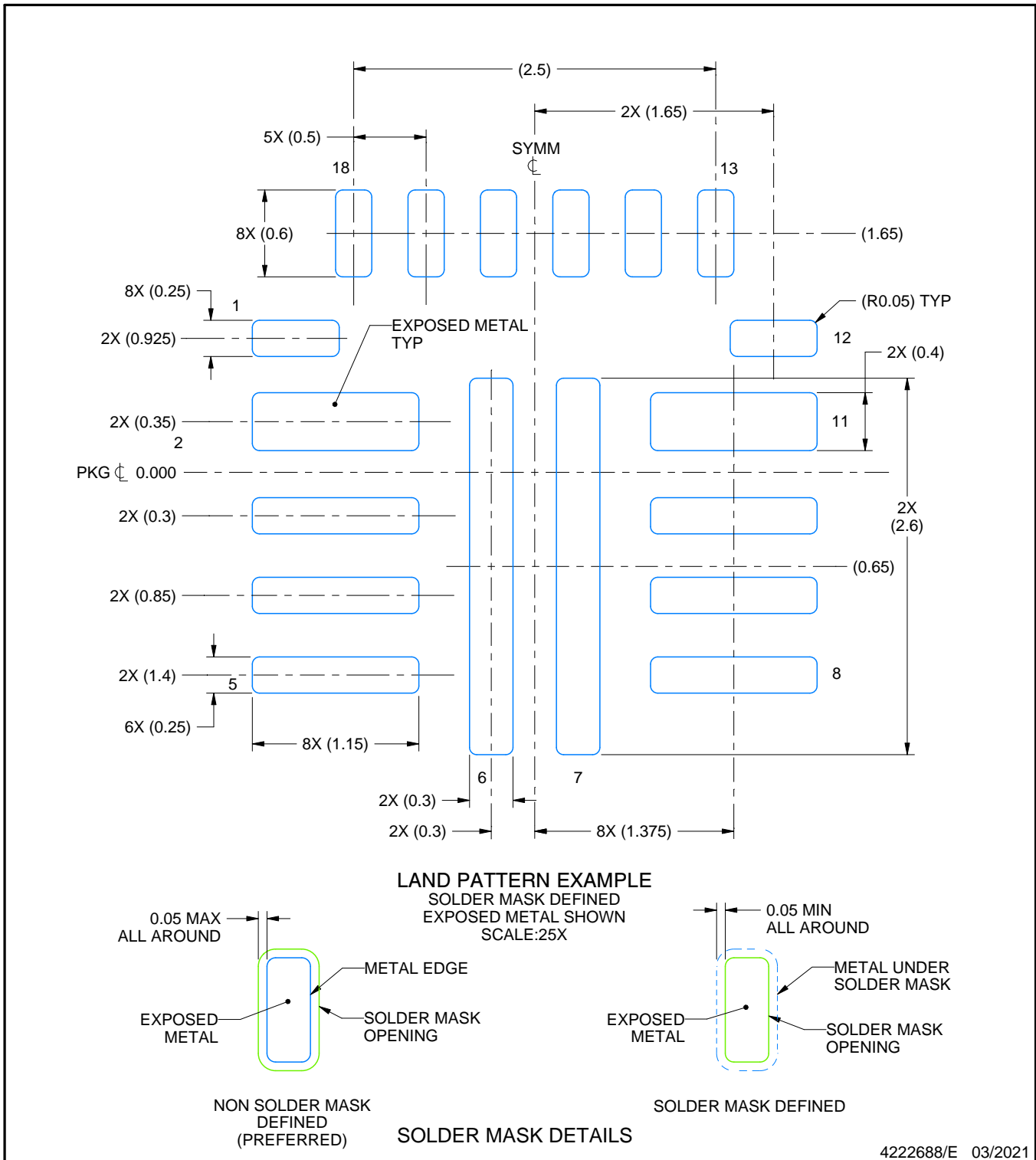
1. All linear dimensions are in millimeters. Any dimensions in parenthesis are for reference only. Dimensioning and tolerancing per ASME Y14.5M.
2. This drawing is subject to change without notice.

# EXAMPLE BOARD LAYOUT

RNN0018A

VQFN-HR - 1 mm max height

PLASTIC QUAD FLATPACK - NO LEAD



NOTES: (continued)

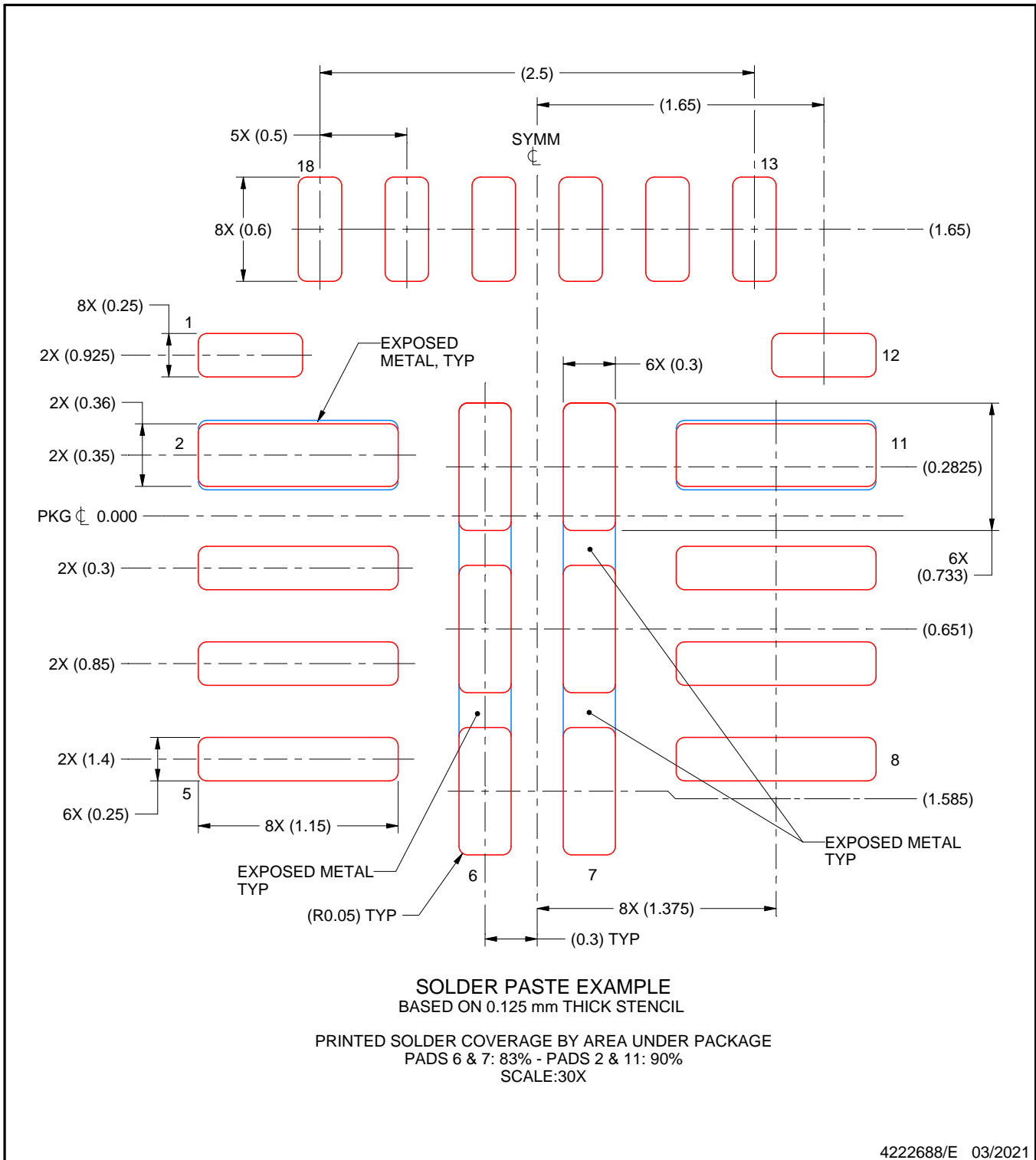
- This package is designed to be soldered to a thermal pad on the board. For more information, see Texas Instruments literature number SLUA271 ([www.ti.com/lit/slua271](http://www.ti.com/lit/slua271)).
- Solder mask tolerances between and around signal pads can vary based on board fabrication site.

# EXAMPLE STENCIL DESIGN

RNN0018A

VQFN-HR - 1 mm max height

PLASTIC QUAD FLATPACK - NO LEAD



NOTES: (continued)

5. For alternate stencil design recommendations, see IPC-7525 or board assembly site preference.

## IMPORTANT NOTICE AND DISCLAIMER

TI PROVIDES TECHNICAL AND RELIABILITY DATA (INCLUDING DATA SHEETS), DESIGN RESOURCES (INCLUDING REFERENCE DESIGNS), APPLICATION OR OTHER DESIGN ADVICE, WEB TOOLS, SAFETY INFORMATION, AND OTHER RESOURCES "AS IS" AND WITH ALL FAULTS, AND DISCLAIMS ALL WARRANTIES, EXPRESS AND IMPLIED, INCLUDING WITHOUT LIMITATION ANY IMPLIED WARRANTIES OF MERCHANTABILITY, FITNESS FOR A PARTICULAR PURPOSE OR NON-INFRINGEMENT OF THIRD PARTY INTELLECTUAL PROPERTY RIGHTS.

These resources are intended for skilled developers designing with TI products. You are solely responsible for (1) selecting the appropriate TI products for your application, (2) designing, validating and testing your application, and (3) ensuring your application meets applicable standards, and any other safety, security, regulatory or other requirements.

These resources are subject to change without notice. TI grants you permission to use these resources only for development of an application that uses the TI products described in the resource. Other reproduction and display of these resources is prohibited. No license is granted to any other TI intellectual property right or to any third party intellectual property right. TI disclaims responsibility for, and you will fully indemnify TI and its representatives against, any claims, damages, costs, losses, and liabilities arising out of your use of these resources.

TI's products are provided subject to [TI's Terms of Sale](#) or other applicable terms available either on [ti.com](https://www.ti.com) or provided in conjunction with such TI products. TI's provision of these resources does not expand or otherwise alter TI's applicable warranties or warranty disclaimers for TI products.

TI objects to and rejects any additional or different terms you may have proposed.

Mailing Address: Texas Instruments, Post Office Box 655303, Dallas, Texas 75265  
Copyright © 2024, Texas Instruments Incorporated