

TPS6380x High-Efficiency, Low I_Q Buck-Boost Converter with Small Solution Size

1 Features

- Three pin-to-pin device options: TPS63805, TPS63806, and TPS63807 with specific application focus
- Input voltage range: 1.3 V to 5.5 V
 - Device input voltage > 1.8 V for start-up
- Output voltage range: 1.8 V to 5.2 V (adjustable)
- High efficiency over the entire load range
 - Power save mode and mode selection for forced PWM-mode
- Peak current buck-boost mode architecture
 - Defined transition points between buck, buck-boost, and boost operation modes
 - Forward and reverse current operation
 - Start-up into pre-biased outputs
- Safety and robust operation features
 - Integrated soft start
 - Overtemperature- and overvoltage-protection
 - True shutdown function with load disconnect
 - Forward and backward current limit
- TPS63805
 - Optimized for smallest solution size of 18.5 mm² (works with a 22-μF minimum output capacitor)
 - 2-A output current for V_I ≥ 2.3 V, V_O = 3.3 V
 - 11-μA operating quiescent current
- TPS63806
 - Optimized for best load step response (180-mV load-step response at a 2 A current step)
 - Up to 2.5-A transient output current
 - 13-μA operating quiescent current
- TPS63807
 - Optimized for smallest solution size of 18.5 mm² (works with a 22-μF minimum output capacitor)
 - 2-A output current for V_I ≥ 2.3 V, V_O = 3.3 V
 - 11-μA operating quiescent current

- Output discharge feature when EN is low
- 480-μs T_{ramp} for small inrush current during start-up

2 Applications

- TPS63805
 - System pre-regulator (smartphone, tablet, left terminal, and telematics)
 - Point-of-load regulation (wired sensor, port/cable adapter, and dongle)
- TPS63806
 - Time-of-flight camera sensor (smartphone, electronic smart lock, and ip network camera)
 - Broadband network radio or SoC supply (IoT, tracking, home automation, and EPOS)
 - Thermoelectric device supply (TEC, optical modules)
 - General purpose voltage stabilizer
- TPS63807
 - Applications needing an output discharge feature

3 Description

The TPS63805, TPS63806, and TPS63807 are high efficiency, high output current buck-boost converters. Depending on the input voltage, they automatically operate in boost, buck, or in a novel 4-cycle buck-boost mode when the input voltage is approximately equal to the output voltage.

Device Information

PART NUMBER	PACKAGE ⁽¹⁾	BODY SIZE (NOM)
TPS63805	3 × 5 Balls WCSP (0.4 mm pitch)	2.3 mm × 1.4 mm
TPS63806		
TPS63807		

- (1) For all available packages, see the orderable addendum at the end of the datasheet.

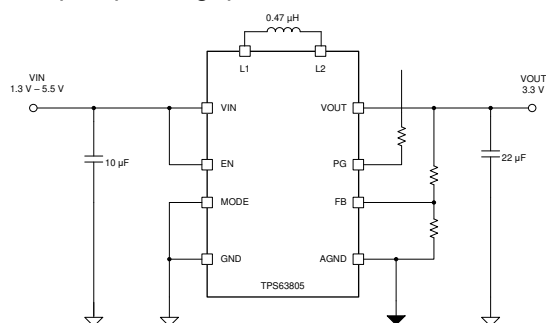

Typical Application

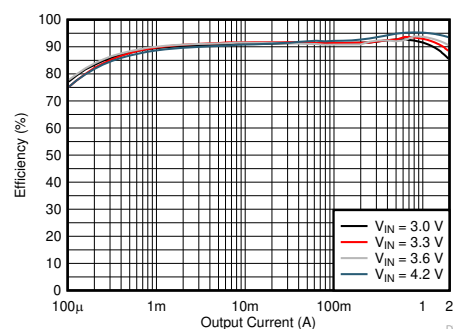

Efficiency Versus Output Current (V_O = 3.3 V)



Table of Contents

1 Features	1	9.4 Device Functional Modes.....	11
2 Applications	1	10 Application and Implementation	15
3 Description	1	10.1 Application Information.....	15
4 Revision History	2	10.2 Typical Application.....	15
5 Description (continued)	3	11 Power Supply Recommendations	31
6 Device Comparison Table	3	12 Layout	32
7 Pin Configuration and Functions	3	12.1 Layout Guidelines.....	32
8 Specifications	4	12.2 Layout Example.....	32
8.1 Absolute Maximum Ratings.....	4	13 Device and Documentation Support	33
8.2 ESD Ratings.....	4	13.1 Device Support.....	33
8.3 Recommended Operating Conditions.....	4	13.2 Receiving Notification of Documentation Updates.....	33
8.4 Thermal Information.....	4	13.3 Support Resources.....	33
8.5 Electrical Characteristics.....	5	13.4 Trademarks.....	33
8.6 Typical Characteristics.....	7	13.5 Electrostatic Discharge Caution.....	33
9 Detailed Description	8	13.6 Glossary.....	33
9.1 Overview.....	8	14 Mechanical, Packaging, and Orderable Information	34
9.2 Functional Block Diagram.....	8		
9.3 Feature Description.....	9		

4 Revision History

Changes from Revision D (January 2021) to Revision E (August 2021)	Page
• Added the TPS63807.....	1

Changes from Revision C (September 2019) to Revision D (January 2021)	Page
• Updated the numbering format for tables, figures and cross-references throughout the document.	1

5 Description (continued)

The transitions between modes happen at defined thresholds and avoid unwanted toggling within the modes to reduce output voltage ripple. The device output voltages are individually set by a resistive divider within a wide output voltage range. The TPS63805 and TPS63807 achieve the lowest solution size with a tiny bill of materials. An 11- μ A quiescent current enables the highest efficiency for little to no-load conditions. The TPS63805, TPS63806, and TPS63807 come in a 1.4-mm \times 2.3-mm package. The device works with tiny passive components to keep the overall solution size small.

The TPS63806 is optimized for applications where the load-step response under a heavy load profile is a concern.

6 Device Comparison Table

PART NUMBER	OUTPUT VOLTAGE (V _O)	I _(Q;VIN) (TYP.)	C _(O,EFF) (MIN.)	V _{PP} LOAD TRANSIENT RESPONDS (TYP.)
TPS63805/ TPS63807	Adjustable	11 μ A	7 μ F	320 mV
TPS63806	Adjustable	13 μ A	21 μ F	180 mV

7 Pin Configuration and Functions

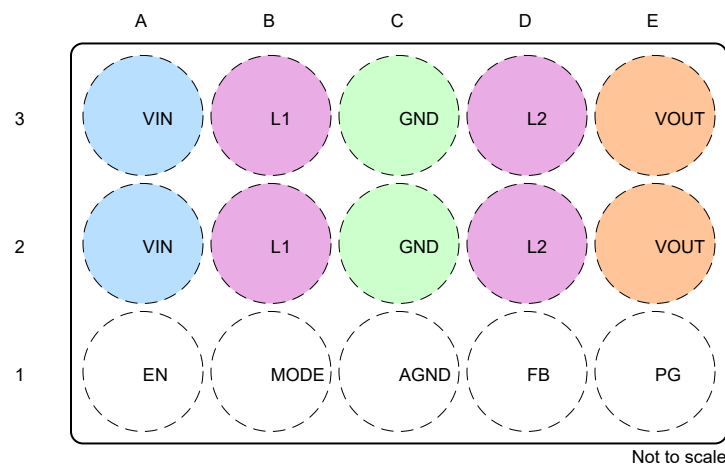

Figure 7-1. WCSP Package Top View

Table 7-1. Pin Functions

PIN		DESCRIPTION
NO	NAME	
A2, A3	VIN	Supply voltage
B2, B3	L1	Connection for inductor
A1	EN	Device Enable input. Set HIGH to enable and LOW to disable. It must not be left floating.
C2, C3	GND	Power ground
B1	MODE	PFM/PWM mode selection. Set LOW for power save mode, set HIGH for forced PWM mode. It must not be left floating.
C1	AGND	Analog ground
D2, D3	L2	Connection for inductor
E2, E3	VOUT	Power stage output
D1	FB	Voltage feedback sensing pin
E1	PG	Power good indicator, open drain output. If not used can be left floating.

8 Specifications

8.1 Absolute Maximum Ratings

over junction temperature range (unless otherwise noted)⁽¹⁾

		MIN	MAX	UNIT
Voltage ⁽²⁾	VIN, L1, L2, EN, MODE, VOUT, FB, PG	-0.3	6	V
	L1, L2 (AC, less than 10 ns)	-3	9	V
Operating junction temperature, T _J		-40	150	°C
Storage temperature, T _{stg}		-65	150	°C

- (1) Stresses beyond those listed under *Absolute Maximum Ratings* may cause permanent damage to the device. These are stress ratings only, which do not imply functional operation of the device at these or any other conditions beyond those indicated under *Recommended Operating Conditions*. Exposure to absolute-maximum-rated conditions for extended periods may affect device reliability.
- (2) All voltage values are with respect to network ground pin.

8.2 ESD Ratings

			VALUE	UNIT
V _(ESD)	Electrostatic discharge	Human-body model (HBM), per ANSI/ESDA/JEDEC JS-001 ⁽¹⁾	±2000	V
		Charged-device model (CDM), per JEDEC specification JESD22-C101 ⁽²⁾	±500	

- (1) JEDEC document JEP155 states that 500-V HBM allows safe manufacturing with a standard ESD control process.
- (2) JEDEC document JEP157 states that 250-V CDM allows safe manufacturing with a standard ESD control process.

8.3 Recommended Operating Conditions

		MIN	NOM	MAX	UNIT
V _I	Input voltage	1.3 ⁽¹⁾		5.5	V
V _O	Output voltage	1.8		5.2 ⁽²⁾	V
C _I	Effective capacitance connected to V _{IN}	4	5		µF
L	Effective inductance	0.37	0.47	0.57	µH
C _O	TPS63805/TPS63807 Effective capacitance connected to V _{OUT}	1.8 V ≤ V _O ≤ 2.3 V		10	µF
		V _O > 2.3 V	7	8.2	µF
C _O	TPS63806 Effective capacitance connected to V _{OUT}	1.8 V ≤ V _O < 2.3 V		30	µF
		V _O > 2.3 V	21	27	µF
T _J	Operating junction temperature	-40		125	°C

- (1) Minimum start-up voltage of V_I > 1.8 V until power good
- (2) V_O margin for accuracy and load steps is considered in absolute maximum ratings

8.4 Thermal Information

over operating free-air temperature range (unless otherwise noted)

THERMAL METRIC ⁽¹⁾		TPS6380x	UNIT
		3x5 Ball WCSP	
		15 PINS	
R _{θJA}	Junction-to-ambient thermal resistance	78.8	°C/W
R _{θJC(top)}	Junction-to-case (top) thermal resistance	0.6	°C/W
R _{θJB}	Junction-to-board thermal resistance	19.5	°C/W
Ψ _{JT}	Junction-to-top characterization parameter	0.3	°C/W
Ψ _{JB}	Junction-to-board characterization parameter	19.5	°C/W
R _{θJC(bot)}	Junction-to-case (bottom) thermal resistance	N/A	°C/W

- (1) For more information about traditional and new thermal metrics, see the [Semiconductor and IC Package Thermal Metrics](#) application report.

8.5 Electrical Characteristics

V_{IN} = 1.8 V to 5.5 V, V_{OUT} = 1.8 V to 5.2 V, T_J = -40°C to $+125^{\circ}\text{C}$, typical values are at V_{IN} = 3.6 V, V_{OUT} = 3.3 V and T_J = 25°C (unless otherwise noted)

PARAMETER		TEST CONDITIONS	MIN	TYP	MAX	UNIT
SUPPLY						
$V_{IN,LOAD}$	Minimum input voltage for full load, once started	$I_{OUT} = 2\text{ A}$, $V_{OUT} = 3.3\text{ V}$, $T_J = 25^{\circ}\text{C}$		2.3		V
$I_{Q,VIN}$	Quiescent current into VIN	TPS63805/TPS63807; $T_J = 25^{\circ}\text{C}$, $EN = V_{IN} = 3.6\text{ V}$, $V_{OUT} = 3.3\text{ V}$, not switching		11		μA
$I_{Q,VIN}$	Quiescent current into VIN	TPS63806; $T_J = 25^{\circ}\text{C}$, $EN = V_{IN} = 3.6\text{ V}$, $V_{OUT} = 3.3\text{ V}$, not switching		13		μA
I_{SD}	Shutdown current into VIN	$EN = \text{low}$, $-40^{\circ}\text{C} \leq T_J \leq 85^{\circ}\text{C}$, $V_{IN} = 3.6\text{ V}$, $V_{OUT} = 0\text{ V}$		45	600	nA
UVLO	Undervoltage lockout threshold	V_{IN} falling, $V_{OUT} \geq 1.8\text{ V}$, once started	1.2	1.25	1.29	V
	Undervoltage lockout threshold	V_{IN} rising	1.6	1.7	1.79	V
T_{SD}	Thermal shutdown	Temperature rising		150		$^{\circ}\text{C}$
$T_{SD,HYST}$	Thermal shutdown hysteresis			20		$^{\circ}\text{C}$
SOFT-START, POWER GOOD						
T_{ramp}	Soft-start, Current limit ramp time	TPS63805/TPS63806 $T_J = 25^{\circ}\text{C}$, $V_{IN} = 3.6\text{ V}$, $V_{OUT} = 3.3\text{ V}$, $I_O = 3.5\text{ A}$, time from first switching to power good		224		μs
		TPS63807 $T_J = 25^{\circ}\text{C}$, $V_{IN} = 3.6\text{ V}$, $V_{OUT} = 3.3\text{ V}$, $I_O = 3.5\text{ A}$, time from first switching to power good		480		μs
T_{delay}	Delay from EN-edge until rising V_{OUT}	$T_J = 25^{\circ}\text{C}$, $V_{IN} = 3.6\text{ V}$, $V_{OUT} = 3.3\text{ V}$, Delay from EN-edge until rising first switching		321		μs
LOGIC SIGNALS EN, MODE						
$V_{THR,EN}$	Threshold Voltage rising for EN-Pin		1.07	1.1	1.13	V
$V_{THF,EN}$	Threshold Voltage falling for EN-Pin		0.97	1	1.03	V
V_{IH}	High-level input voltage		1.2			V
V_{IL}	Low-level input voltage				0.4	V
$V_{PG,rising}$	Power Good threshold voltage	V_{OUT} rising, referenced to V_{OUT} nominal		95		%
$V_{PG,falling}$		V_{OUT} falling, referenced to V_{OUT} nominal		90		%
$V_{PG,Low}$	Power Good low-level output voltage	$I_{SINK} = 1\text{ mA}$			0.4	V
$t_{PG,delay}$	Power Good delay time	V_{FB} falling		14		μs
I_{Ikg}	Input leakage current			0.01	0.2	μA
OUTPUT						
I_{SD}	Shutdown current into VOUT	TPS63805/TPS63806 $EN = \text{low}$, $-40^{\circ}\text{C} \leq T_J \leq 85^{\circ}\text{C}$, $V_{IN} = 3.6\text{ V}$, $V_{OUT} = 3.3\text{ V}$		± 0.5	± 600	nA
V_{FB}	Feedback Regulation Voltage			500		mV
V_{FB}	Feedback Voltage accuracy	PWM mode	-1		1	%
	Overvoltage Protection Threshold	V_{OUT} rising	5.5	5.7	5.9	V
		V_{IN} rising	5.5	5.7	5.9	V
$I_{PWM/PFM}$	Peak Inductor Current to enter PFM-Mode	$V_{IN} = 3.6\text{ V}$; $V_{OUT} = 3.3\text{ V}$		1.06		A
I_{FB}	Feedback Input Bias Current	$V_{FB} = 500\text{ mV}$		5	100	nA
I_{PK}	Peak Current Limit, Boost Mode	TPS63805/TPS63807; $V_{IN} \geq 2.5\text{ V}$	4	5	5.75	A
	Peak Current Limit, Buck-Boost Mode			5		A
	Peak Current Limit, Buck Mode			3.8		A
I_{PK}	Peak Current Limit, Boost Mode	TPS63806; $V_{IN} \geq 2.5\text{ V}$	4.4	5.5	6.25	A
	Peak Current Limit, Buck-Boost Mode			5.5		A
	Peak Current Limit, Buck Mode			4		A
$I_{PK,Reverse}$	Peak Current Limit for Reverse Operation	$V_I = 5\text{ V}$, $V_O = 3.3\text{ V}$		-0.9		A

TPS63805, TPS63806, TPS63807

SLVSDS9E – JULY 2018 – REVISED AUGUST 2021

 V_{IN} = 1.8 V to 5.5 V, V_{OUT} = 1.8 V to 5.2 V, T_J = -40°C to $+125^{\circ}\text{C}$, typical values are at V_{IN} = 3.6 V, V_{OUT} = 3.3 V and T_J = 25°C (unless otherwise noted)

PARAMETER		TEST CONDITIONS		MIN	TYP	MAX	UNIT
Buck $R_{DS,ON}$	High-side FET on-resistance	$V_{IN} = 3\text{ V}$, $V_{OUT} = 3.3\text{ V}$; $I_{(L2)} = 0.19\text{ A}$	$V_{IN} = 3\text{ V}$, $V_{OUT} = 3.3\text{ V}$; $I_O = 0.5\text{ A}$		47		m Ω
	Low-side FET on-resistance	$V_{IN} = 3\text{ V}$, $V_{OUT} = 3.3\text{ V}$; $I_{(L2)} = 0.19\text{ A}$	$V_{IN} = 3\text{ V}$, $V_{OUT} = 3.3\text{ V}$; $I_O = 0.5\text{ A}$		30		m Ω
Boost $R_{DS,ON}$	High-side FET on-resistance	$V_{IN} = 3\text{ V}$, $V_{OUT} = 3.3\text{ V}$; $I_{(L1)} = 0.19\text{ A}$	$V_{IN} = 3\text{ V}$, $V_{OUT} = 3.3\text{ V}$; $I_O = 0.5\text{ A}$		43		m Ω
	Low-side FET on-resistance	$V_{IN} = 3\text{ V}$, $V_{OUT} = 3.3\text{ V}$; $I_{(L1)} = 0.19\text{ A}$	$V_{IN} = 3\text{ V}$, $V_{OUT} = 3.3\text{ V}$; $I_O = 0.5\text{ A}$		18		m Ω
f_{sw}	Inductor Switching Frequency, Boost Mode	$V_{IN} = 2.3\text{V}$, $V_{OUT} = 3.3\text{V}$, no Load, MODE = HIGH, $T_J = 25^{\circ}\text{C}$			2.1		MHz
	Inductor Switching Frequency, Buck-Boost Mode	$V_{IN} = 3.3\text{V}$, $V_{OUT} = 3.3\text{V}$, no Load, MODE = HIGH, $T_J = 25^{\circ}\text{C}$			1.4		MHz
	Inductor Switching Frequency, Buck Mode	$V_{IN} = 4.3$, $V_{OUT} = 3.3\text{V}$, no Load, MODE = HIGH, $T_J = 25^{\circ}\text{C}$			1.6		MHz
	Line regulation	$V_{IN} = 2.4\text{ V to }5.5\text{ V}$, $V_{OUT} = 3.3\text{V}$, $I_{OUT} = 2\text{ A}$			0.3		%
	Load regulation	$V_{IN} = 3.6\text{ V}$, $V_{OUT} = 3.3\text{V}$, $I_{OUT} = 0\text{ A to }2\text{ A}$, forced-PWM mode			0.1		%

8.6 Typical Characteristics

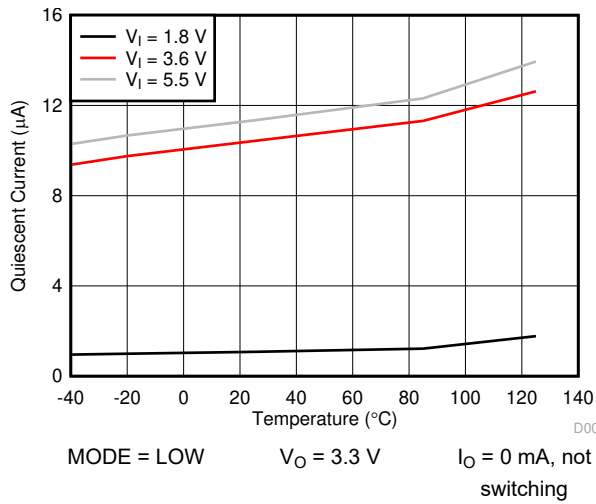

Figure 8-1. TPS63805/TPS63807 Quiescent Current vs. Temperature

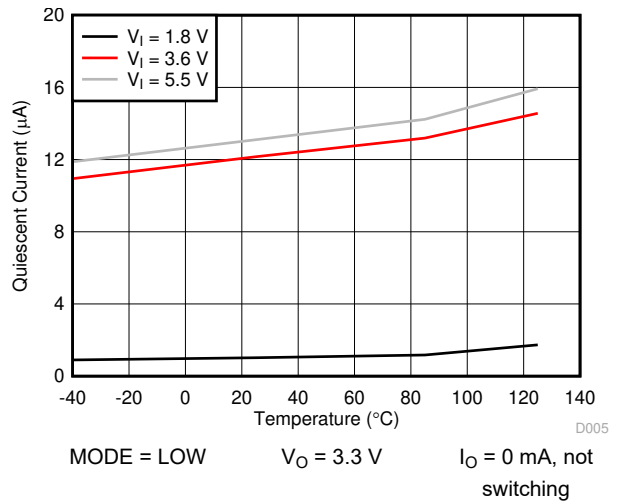

Figure 8-2. Quiescent Current vs. Temperature

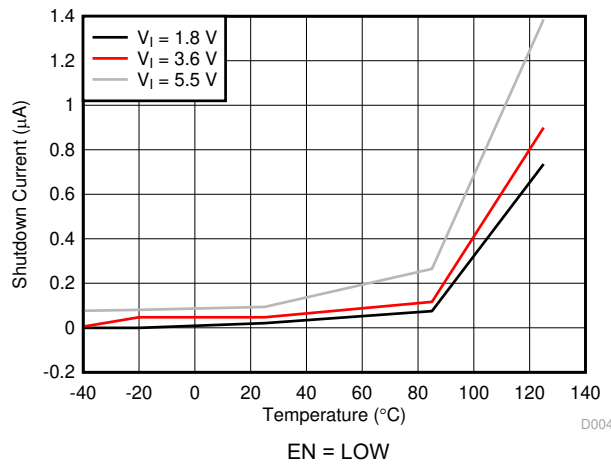

Figure 8-3. Shutdown Current vs. Temperature

9 Detailed Description

9.1 Overview

The TPS63805, TPS63806, and TPS63807 buck-boost converter use four internal switches to maintain synchronous power conversion at all possible operating conditions. This enables the device to keep high efficiency over a wide input voltage and output load range. To regulate the output voltage at all possible input voltage conditions, the device automatically transitions between buck, buck-boost, and boost operation as required by the operating conditions. Therefore, it operates as a buck converter when the input voltage is higher than the output voltage, and as a boost converter when the input voltage is lower than the output voltage. When the input voltage is close to the output voltage, it operates in a 3-cycle buck-boost operation. In this mode, all four switches are active (see [Section 9.4.1.3](#)). The RMS current through the switches and the inductor is kept at a minimum to minimize switching and conduction losses. Controlling the switches this way allows the converter to always keep high efficiency over the complete input voltage range. The device provides a seamless transition between all modes.

9.2 Functional Block Diagram

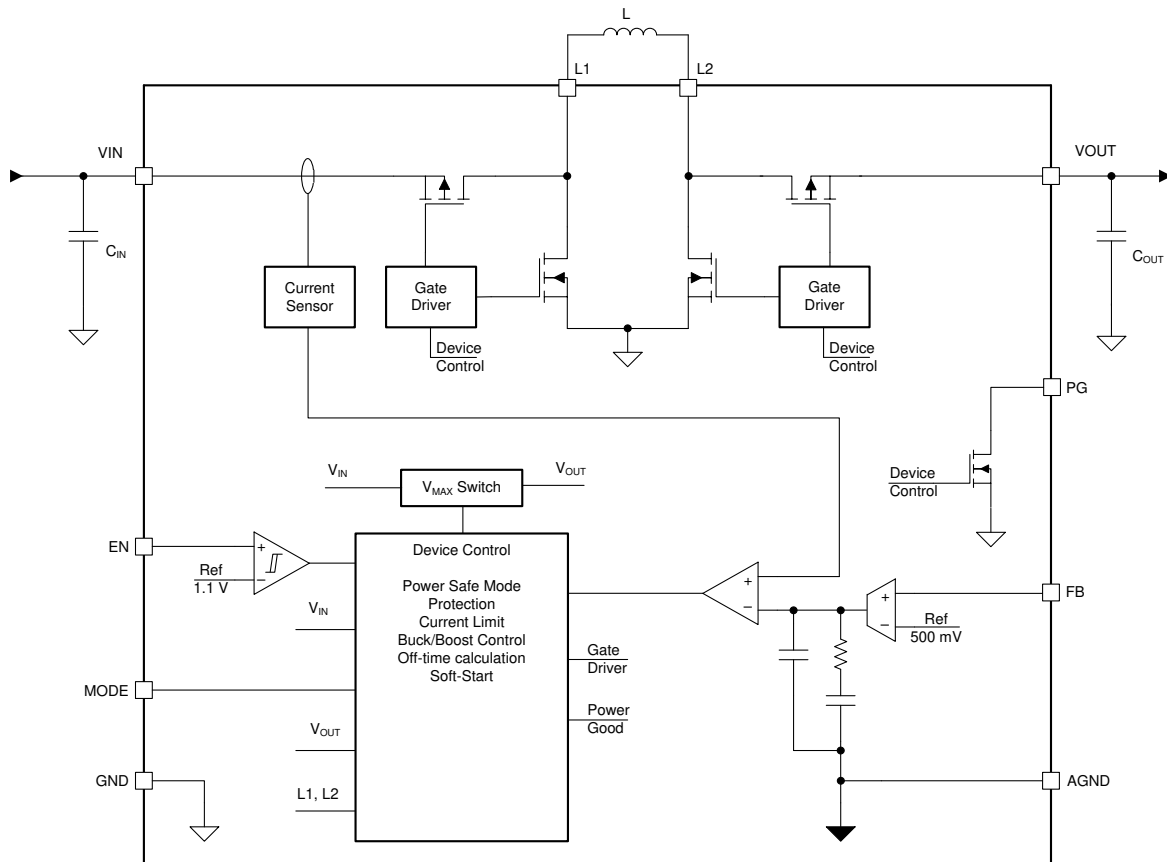

9.3 Feature Description

9.3.1 Control Loop Description

The TPS63805, TPS63806, and TPS63807 use a peak current mode control architecture. It has an inner current loop where it measures the peak current of the boost high-side MOSFET and compares it to a reference current. This current is the output of the outer voltage loop. It measures the output voltage via the FB-pin and compares it with the internal voltage reference. That means, the outer voltage loop measures the voltage error ($V_{REF}-V_{FB}$), and transforms it into the system current demand (I_{REF}) for the inner current loop.

Figure 9-1 shows the simplified schematic of the control loop. The error amplifier and the type-2 compensation represent the voltage loop. The voltage output is converted into the reference current I_{REF} and fed into the current comparator.

The scheme shows the skip-comparator handling the power-save mode (PFM) to achieve high efficiency at light loads. See Section 9.4.2 for further details.

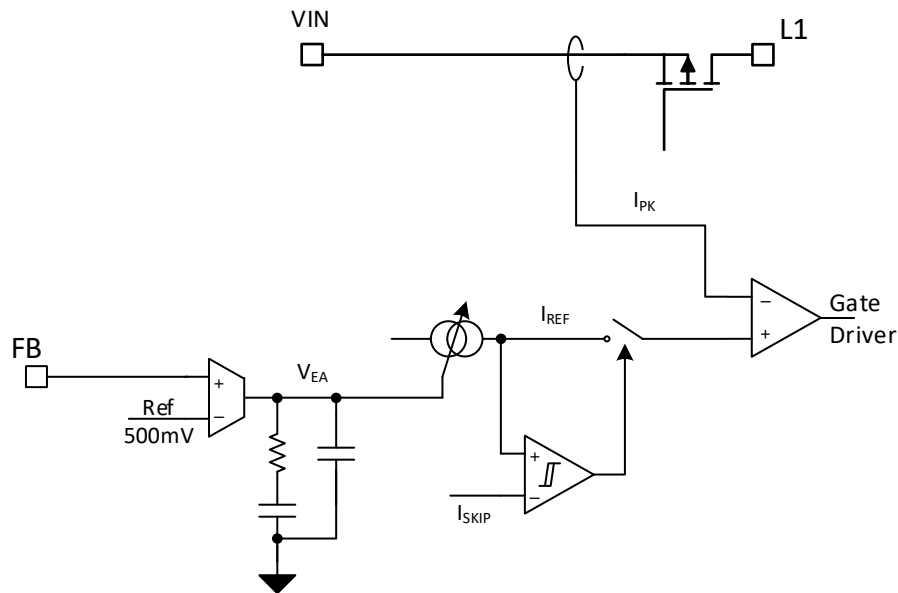

Figure 9-1. Control Loop Architecture Scheme

9.3.2 Precise Device Enable: Threshold- or Delayed Enable

The enable-pin is a digital input to enable or disable the device by applying a high or low level. The device enters shutdown when EN is set low. In addition, this input features a precise threshold and can be used as a comparator that enables and disables the part at a defined threshold. This allows you to drive the state by a slowly changing voltage and enables the use of an external RC network to achieve a precise power-up delay. The enable pin can also be used with an external voltage divider to set a user-defined minimum supply voltage. For proper operation, the EN pin must be terminated and must not be left floating.

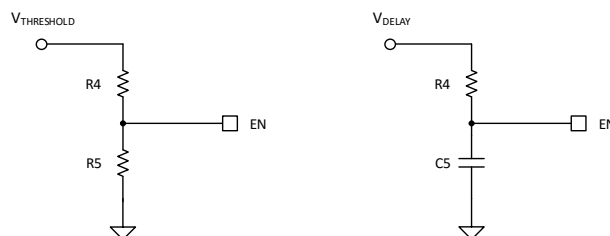

Figure 9-2. Circuit Example for How to Use the Precise Device Enable Feature

9.3.3 Mode Selection (PFM/PWM)

The mode-pin is a digital input to enable the automatic PWM/PFM mode that features the highest efficiency by allowing pulse-frequency-modulation for lower output currents. This mode is enabled by applying a low level. The device can be forced in PWM operation regardless of the output current to achieve minimum output ripple by applying a high level. This pin must not be left floating.

9.3.4 Undervoltage Lockout (UVLO)

To avoid mis-operation of the device at low input voltages, an undervoltage lockout is included. It activates the device once the input voltage (V_I) has increased the $UVLO_{rising}$ value. Once active, the device allows operation down to even smaller input voltages, which is determined by the $UVLO_{falling}$. This behavior requires V_O to be higher than the minimum value of 1.8 V.

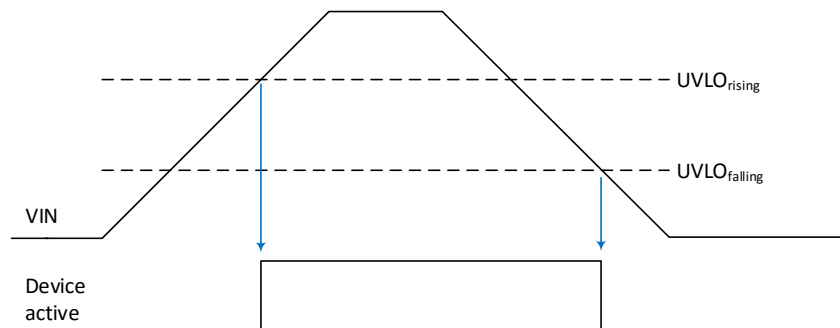

Figure 9-3. Rising and Falling Undervoltage Lockout Behavior

9.3.5 Soft Start

To minimize inrush current and output voltage overshoot during start-up, the device features a controlled soft start. After the device is enabled, the device starts all internal reference and control circuits within the enable delay time, T_{delay} . After that, the maximum switch current limit rises monotonically from 0 mA to the current limit. The loop stops switching once V_O is reached. This allows a quick output voltage ramp for small capacitors at the output. The bigger the output capacitor, the longer it takes to settle V_O . A potential load during start-up will lengthen the duration of the output voltage ramp as well. The gradual ramp of the current limit allows a small inrush current for no-load conditions, as well as the possibility to start into high loads at start-up.

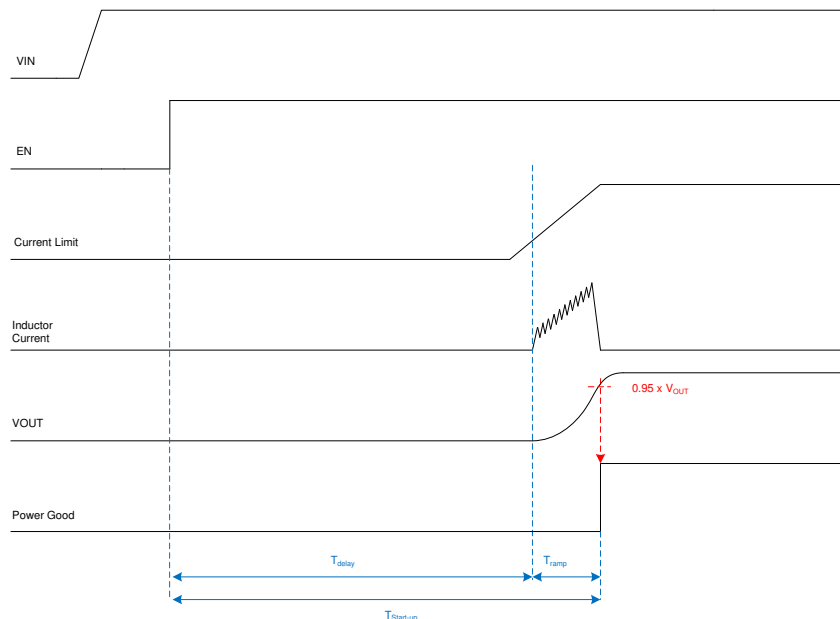

Figure 9-4. Device Start-up Scheme

9.3.6 Adjustable Output Voltage

The device's output voltage is adjusted by applying an external resistive divider between V_O , the FB-pin, and GND. This allows you to program the output voltage in the recommended range. The divider must provide a low-side resistor of less than 100 k Ω . The high-side resistor is chosen accordingly.

9.3.7 Overtemperature Protection - Thermal Shutdown

The device has a built-in temperature sensor which monitors the junction temperature. If the temperature exceeds the threshold, the device stops operating. As soon as the IC temperature has decreased below the programmed threshold, it starts operating again. There is a built-in hysteresis to avoid unstable operation at junction temperatures at the overtemperature threshold.

9.3.8 Input Overvoltage - Reverse-Boost Protection (IVP)

The TPS63805, TPS63806, and TPS63807 can operate in reverse mode where the device transfers energy from the output back to the input. If the source is not able to sink the revers current, the negative current builds up a charge to the input capacitance and V_{IN} rises. To protect the device and other components from that scenario, the device features an input voltage protection (IVP) for reverse boost operation. Once the input voltage is above the threshold, the converter forces PFM mode and the negative current operation is interrupted.

The PG signal goes low to indicate that behavior.

9.3.9 Output Overvoltage Protection (OVP)

In case of a broken feedback-path connection, the device can lose V_O information and is not able to regulate. To avoid an uncontrolled boosting of V_O , the TPS63805, TPS63806, and TPS63807 feature output overvoltage protection. It measures the voltage on the VOUT pin and stops switching when V_O is greater than the threshold to avoid harm to the converter and other components.

9.3.10 Power-Good Indicator

The power good goes high-impedance once the output is above 95% of the nominal voltage, and is driven low once the output voltage falls below typically 90% of the nominal voltage. This feature also indicates overvoltage and device shutdown cases as shown in [Table 9-1](#). The PG pin is an open-drain output and is specified to sink up to 1 mA. The power-good output requires a pullup resistor connecting to any voltage rail less than 5.5 V. The PG signal can be used to sequence multiple rails by connecting it to the EN pin of other converters. Leave the PG pin unconnected when not used.

Table 9-1. Power-Good Indicator Truth Table

LOGIC SIGNALS					PG LOGIC STATUS
EN	V_O	V_I	OVP	IVP	
X	< 1.8 V	< UVLO_R	X	X	Undefined
LOW	X	> UVLO_F	X	X	LOW
HIGH	$V_O < 0.9 \times \text{target-}V_O$	> 1.3V	X	X	LOW
HIGH	X	> UVLO_F	HIGH	X	LOW
HIGH	X	> UVLO_F	X	HIGH	LOW
HIGH	$V_O > 0.95 \times \text{target-}V_O$	> UVLO_F	LOW	LOW	HIGH Z

9.4 Device Functional Modes

9.4.1 Peak-Current Mode Architecture

The TPS63805, TPS63806, and TPS63807 are based on a peak-current mode architecture. The error amplifier provides a peak-current target (voltage that is translated into an equivalent current, see [Figure 9-1](#)), based on the current demand from the voltage loop. This target is compared to the actual inductor current during the ON-time. The ON-time is ended once the inductor current is equal to the current target and OFF-time is initiated. The OFF-time is calculated by the control and a function of V_I and V_O .

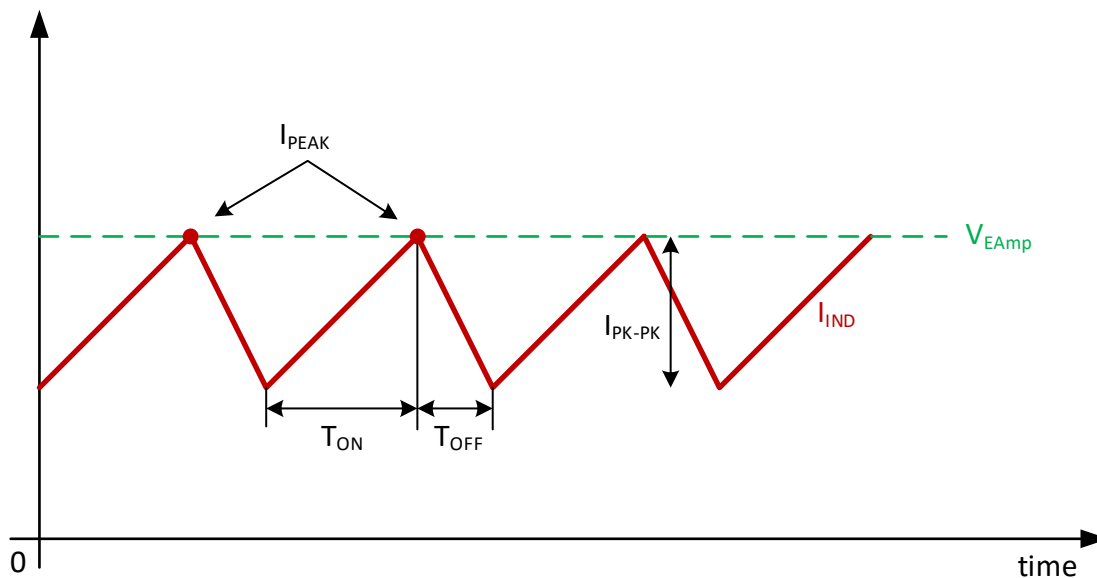

Figure 9-5. Peak-Current Architecture Operation

9.4.1.1 Reverse Current Operation, Negative Current

When the TPS63805, TPS63806, and TPS63807 are forced to PWM operation (MODE = HIGH), the device current can flow in reverse direction. This happens by the negative current capability of the TPS63805, TPS63806, and TPS63807. The error amplifier provides a peak-current target (voltage that is translated into an equivalent current, see Figure 9-1), even if the target has a negative value. The maximum average current is even more negative than the peak current.

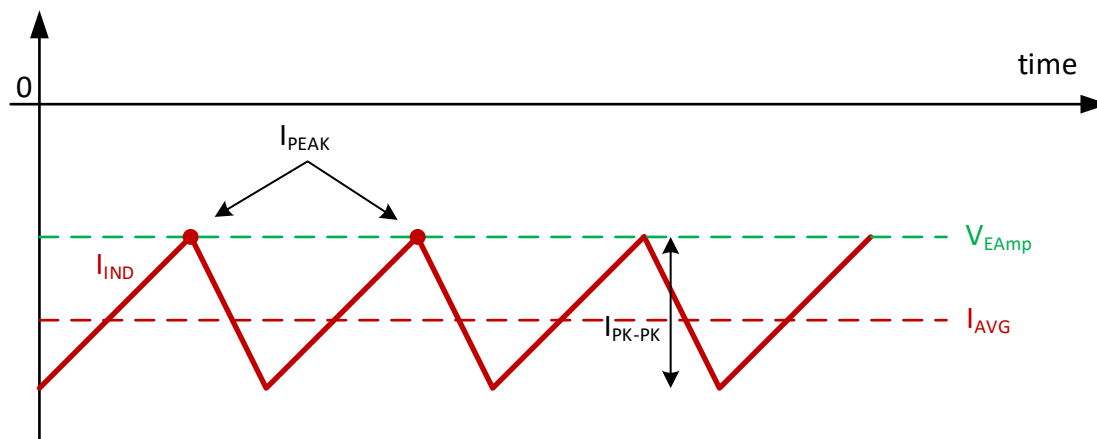

Figure 9-6. Peak-Current Operation, Reverse Current

9.4.1.2 Boost Operation

When V_I is smaller than V_O (and the voltages are not close enough to trigger buck-boost operation), the TPS63805, TPS63806, and TPS63807 operate in boost mode where the boost high-side and low-side switches are active. The buck high-side switch is always turned on and the buck low-side switch is always turned off. This lets the TPS63805, TPS63806, and TPS63807 operate as a classical boost converter.

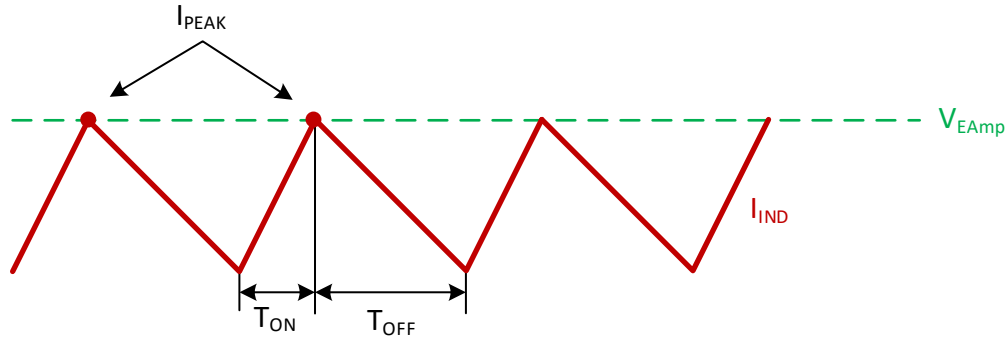

Figure 9-7. Peak-Current Boost Operation

9.4.1.3 Buck-Boost Operation

When V_I is close to V_O , the TPS63805, TPS63806, and TPS63807 operate in buck-boost mode where all switches are active and the device repeats 3-cycles:

- T_{ON} : Boost-charge phase where boost low-side and buck high-side are closed and the inductor current is built up
- T_{OFF} : Buck discharge phase where boost high-side and buck low-side are closed and the inductor is discharged
- T_{COM} : V_I connected to V_O where all high-side switches are closed and the input is connected to the output

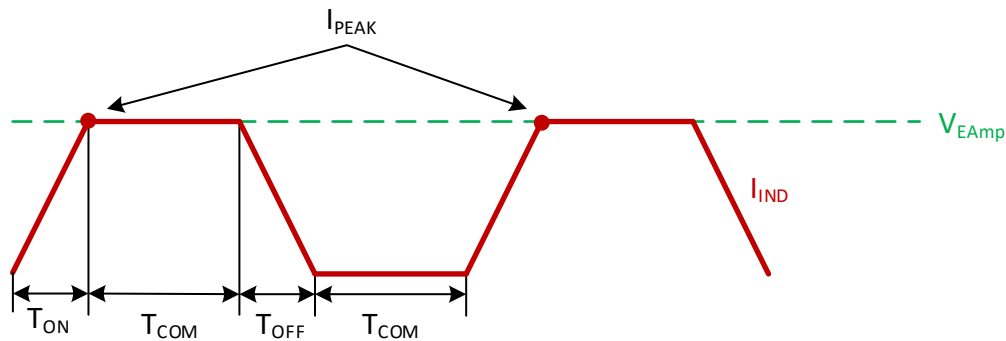

Figure 9-8. Peak-Current Buck-Boost Operation

9.4.1.4 Buck Operation

When V_I is greater than V_O (and the voltages are not close enough to trigger buck-boost operation), the TPS63805, TPS63806, and TPS63807 operate in buck mode where the buck high-side and low-side switches are active. The boost high-side switch is always turned on and the boost low-side switch is always turned off. This lets the TPS63805, TPS63806, and TPS63807 operate as a classical buck converter.

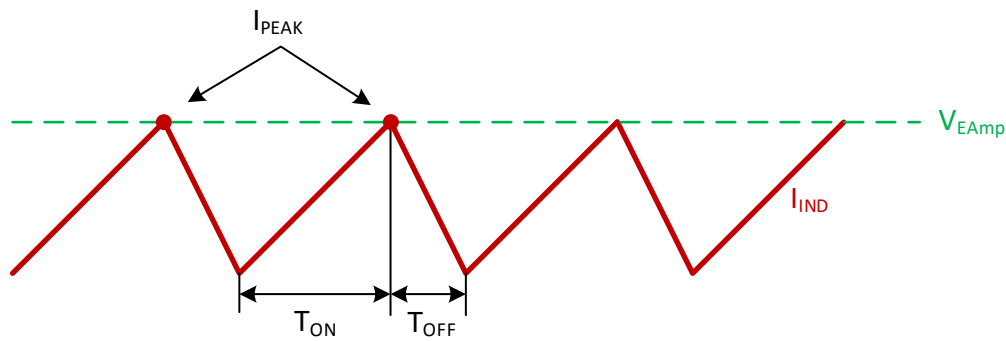

Figure 9-9. Peak-Current Buck Operation

9.4.2 Power Save Mode Operation

Besides continuous conduction mode (PWM), the TPS63805, TPS63806, and TPS63807 feature power safe mode (PFM) operation to achieve high efficiency at light load currents. This is implemented by pausing the switching operation, depending on the load current.

The skip comparator manages the switching or pause operation. It compares the current demand signal from the voltage loop, I_{REF} , with the skip threshold, I_{SKIP} , as shown in Figure 9-1. If the current demand is lower than the skip value, the comparator pauses switching operation. If the current demand goes higher (due to falling V_O), the comparator activates the current loop and allows switching according to the loop behavior. Whenever the current loop has risen V_O by bringing charge to the output, the voltage loop output, I_{REF} (respectively V_{EA}), decreases. When I_{REF} falls below I_{SKIP} -hysteresis, it automatically pauses again.

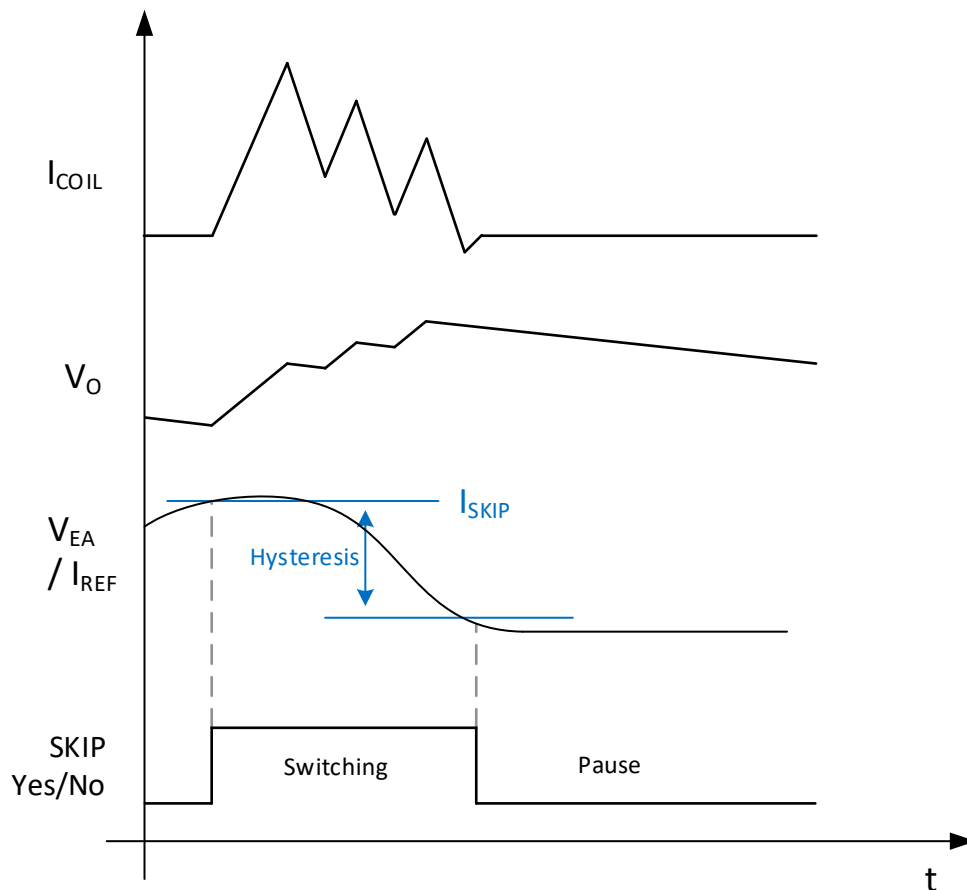

Figure 9-10. Power Safe Mode Operation Curves

9.4.2.1 Current Limit Operation

To limit current and protect the device and application, the maximum peak inductor current is limited internally on the IC. It is measured at the buck high-side switch which turns into an input current detection. To provide a certain load current across all operation modes, the boost and buck-boost peak current limit is higher than in buck mode. It limits the input current and allows no further increase of the delivered current. When using the device in this mode, it behaves similar to a current source.

The current limit depends on the operation mode (buck, buck-boost, or boost mode).

10 Application and Implementation

Note

Information in the following applications sections is not part of the TI component specification, and TI does not warrant its accuracy or completeness. TI's customers are responsible for determining suitability of components for their purposes, as well as validating and testing their design implementation to confirm system functionality.

10.1 Application Information

The TPS63805, TPS63806, and TPS63807 are high efficiency, low quiescent current, non-inverting buck-boost converters, suitable for applications that need a regulated output voltage from an input supply that can be higher or lower than the output voltage.

10.2 Typical Application

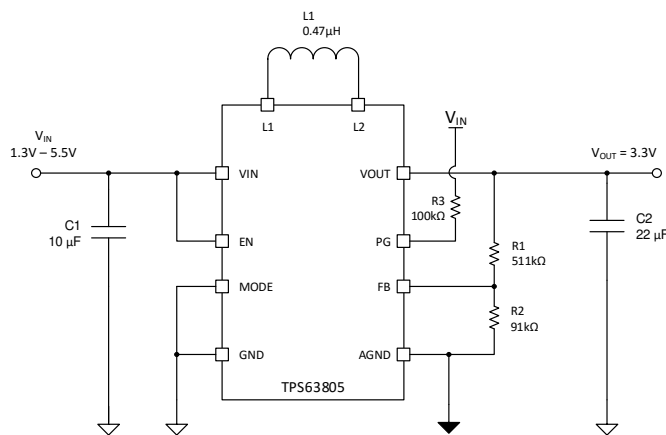

Figure 10-1. TPS63805/TPS63807 3.3 V_{OUT} Typical Application

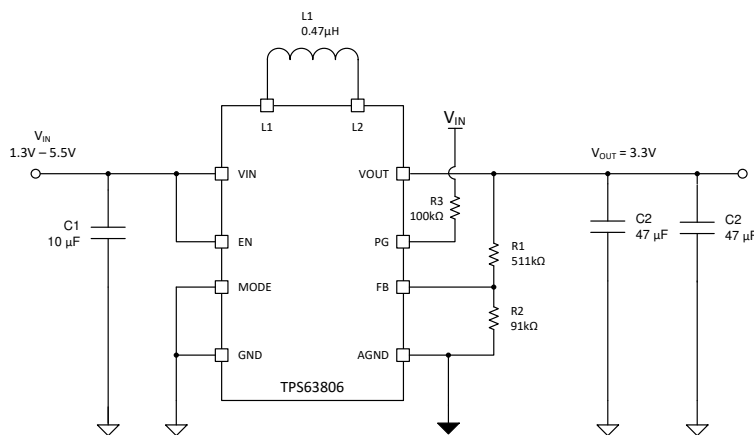

Figure 10-2. TPS63806 3.3 V_{OUT} Typical Application

10.2.1 Design Requirements

The design guideline provides a component selection to operate the device within [Table 10-1](#).

[Table 10-1](#) shows the list of components for the application characteristic curves.

Table 10-1. Matrix of Output Capacitor and Inductor Combinations for the TPS63805/TPS63807

NOMINAL INDUCTOR VALUE [μ H] ⁽¹⁾	NOMINAL OUTPUT CAPACITOR VALUE [μ F] ⁽²⁾				
	10	22	47	66	100
0.47	-	+ ⁽³⁾	+	+	+

- (1) Inductor tolerance and current derating is anticipated. The effective inductance can vary by 20% and –30%.
 (2) Capacitance tolerance and DC bias voltage derating is anticipated. The effective capacitance can vary by 20% and –50%.
 (3) TPS63805/TPS63807 typical application. Other check marks indicate possible filter combinations.

Table 10-2. Matrix of Output Capacitor and Inductor Combinations for TPS63806

NOMINAL INDUCTOR VALUE [μ H] ⁽¹⁾	NOMINAL OUTPUT CAPACITOR VALUE [μ F] ⁽²⁾				
	10	22	47	66	100
0.47	-	-	+ ⁽¹⁾	+	+

- (1) TPS63806 typical application. Other check marks indicate possible filter combinations.

10.2.2 Detailed Design Procedure

The first step is the selection of the output filter components. To simplify this process, [Section 8.1](#) outlines minimum and maximum values for inductance and capacitance. Take tolerance and derating into account when selecting nominal inductance and capacitance.

10.2.2.1 Custom Design With WEBENCH® Tools

[Click here](#) to create a custom design using the TPS63805/TPS63807 device with the WEBENCH® Power Designer. [Click here](#) to create a custom design using the TPS63806 device with the WEBENCH® Power Designer.

1. Start by entering the input voltage (V_{IN}), output voltage (V_{OUT}), and output current (I_{OUT}) requirements.
2. Optimize the design for key parameters such as efficiency, footprint, and cost using the optimizer dial.
3. Compare the generated design with other possible solutions from Texas Instruments.

The WEBENCH Power Designer provides a customized schematic along with a list of materials with real-time pricing and component availability.

In most cases, these actions are available:

- Run electrical simulations to see important waveforms and circuit performance
- Run thermal simulations to understand board thermal performance
- Export customized schematic and layout into popular CAD formats
- Print PDF reports for the design, and share the design with colleagues

Get more information about WEBENCH tools at www.ti.com/WEBENCH.

10.2.2.2 Inductor Selection

The inductor selection is affected by several parameters such as the following:

- Inductor ripple current
- Output voltage ripple
- Transition point into power save mode
- Efficiency

See [Table 10-3](#) for typical inductors.

For high efficiencies, the inductor must have a low DC resistance to minimize conduction losses. Especially at high-switching frequencies, the core material has a high impact on efficiency. When using small chip inductors, the efficiency is reduced, mainly due to higher inductor core losses. This needs to be considered when selecting the appropriate inductor. The inductor value determines the inductor ripple current. The larger the inductor value, the smaller the inductor ripple current and the lower the conduction losses of the converter. Conversely, larger inductor values cause a slower load transient response. To avoid saturation of the inductor, the peak current for the inductor in steady-state operation is calculated using [Equation 2](#). Only the equation which defines the switch

current in boost mode is shown because this provides the highest value of current and represents the critical current value for selecting the right inductor.

$$\text{Duty Cycle Boost} \quad D = \frac{V_{\text{OUT}} - V_{\text{IN}}}{V_{\text{OUT}}} \quad (1)$$

$$I_{\text{PEAK}} = \frac{I_{\text{out}}}{\eta \times (1 - D)} + \frac{V_{\text{in}} \times D}{2 \times f \times L} \quad (2)$$

where

- D = Duty Cycle in Boost mode
- f = Converter switching frequency
- L = Inductor value
- η = Estimated converter efficiency (use the number from the efficiency curves or 0.9 as an assumption)

Note

The calculation must be done for the minimum input voltage in boost mode.

Calculating the maximum inductor current using the actual operating conditions gives the minimum saturation current of the inductor needed. It is recommended to choose an inductor with a saturation current 20% higher than the value calculated using [Equation 2](#). [Table 10-3](#) lists the possible inductors.

Table 10-3. List of Recommended Inductors

INDUCTOR VALUE [μH]	SATURATION CURRENT [A]	DCR [m Ω]	PART NUMBER	MANUFACTURER ⁽¹⁾	SIZE (LxWxH mm)
0.47	5.4	7.6	XFL4015-471ME	Coilcraft	4 x 4 x 2
0.47	5.5	26	DFE201612E	Toko	2.0 x 1.6 x 1.2

(1) See [Third-party Products Disclaimer](#).

10.2.2.3 Output Capacitor Selection

For the output capacitor, it is recommended to use small ceramic capacitors placed as close as possible to the VOUT and PGND pins of the IC. The recommended nominal output capacitor value is a single 22 μF for the TPS63805/TPS63807 and 2x47 μF for the TPS63806 for all programmed output voltages ≤ 3.6 V. Above that voltage, 2x22 μF for the TPS63805/TPS63807 and 3x47 μF for the TPS63806 capacitors are recommended.

It is important that the effective capacitance is given according to the recommended value in [Section 8.3](#). In general, consider DC bias effects resulting in less effective capacitance. The choice of the output capacitance is mainly a trade-off between size and transient behavior since higher capacitance reduces transient response overshoot and undershoot and increases transient response time. [Table 10-4](#) lists possible output capacitors.

There is no upper limit for the output capacitance value.

Table 10-4. List of Recommended Capacitors⁽¹⁾

CAPACITOR [μF]	VOLTAGE RATING [V]	ESR [m Ω]	PART NUMBER	MANUFACTURER	SIZE (METRIC)
22	6.3	10	GRM188R60J226MEA0	Murata	0603 (1608)
22	6.3	10	GRM187R61A226ME15	Murata	0603 (1608)
22	10	40	GRM188R61A226ME15	Murata	0603 (1608)
22	10	10	GRM187R60J226ME15	Murata	0603 (1608)
47	6.3	43	GRM188R60J476ME15	Murata	0603 (1608)
47	6.3	43	GRM219R60J476ME44	Murata	0805 (2012)

(1) See [Third-party Products Disclaimer](#).

10.2.2.4 Input Capacitor Selection

A 10 µF input capacitor is recommended to improve line transient behavior of the regulator and EMI behavior of the total power supply circuit. An X5R or X7R ceramic capacitor placed as close as possible to the VIN and PGND pins of the IC is recommended. This capacitance can be increased without limit. If the input supply is located more than a few inches from the TPS63805, TPS63806, and TPS63807 converter, additional bulk capacitance can be required in addition to the ceramic bypass capacitors. An electrolytic or tantalum capacitor with a value of 47 µF is a typical choice.

Table 10-5. List of Recommended Capacitors⁽¹⁾

CAPACITOR [µF]	VOLTAGE RATING [V]	ESR [mΩ]	PART NUMBER	MANUFACTURER	SIZE (METRIC)
10	6.3	10	GRM188R60J106ME84	Murata	0603 (1608)
10	10	40	GRM188R61A106ME69	Murata	0603 (1608)
22	6.3	10	GRM188R60J226MEA0	Murata	0603 (1608)

10.2.2.5 Setting The Output Voltage

The output voltage is set by an external resistor divider. The resistor divider must be connected between VOUT, FB, and GND. The feedback voltage is 500 mV nominal. The low-side resistor R2 (between FB and GND) must not exceed 100 kΩ. The high-side resistor (between FB and VOUT) R1 is calculated by [Equation 3](#).

$$R1 = R2 \times \left(\frac{V_{OUT}}{V_{FB}} - 1 \right) \quad (3)$$

where

- $V_{FB} = 500 \text{ mV}$

Table 10-6. Resistor Selection for Typ. Voltages

V _O [V]	R1 [kΩ]	R2 [kΩ]
2.5	365	91
3.3	511	91
3.6	562	91
5	806	91

10.2.3 Application Curves

Table 10-7. Components for Application Characteristic Curves⁽¹⁾

REFERENCE	DESCRIPTION	PART NUMBER	MANUFACTURER	COMMENT
L1	0.47µH, 4 mm x 4 mm x 1.5 mm, 5.4 A, 7.6 mΩ	XFL4015-471ME	Coilcraft	
C1	10 µF, 0603, Ceramic Capacitor, ±20%, 6.3 V	GRM188R60J106ME84	Murata	
C2	TPS63805 1x 22 µF, 0603, Ceramic Capacitor, ±20%, 10 V	GRM188R61A226ME15	Murata	TPS63805/TPS63807, V _O ≤ 3.6 V
C2	TPS63806 2x 47 µF, 0603, Ceramic Capacitor, ±20%, 6.3 V	GRM188R60J476ME15	Murata	TPS63806, V _O ≤ 3.6 V
C2	TPS63805 2x 22 µF, 0603, Ceramic Capacitor, ±20%, 10 V	GRM188R61A226ME15	Murata	TPS63805/TPS63807, V _O > 3.6 V
C2	TPS63806 3x 47 µF, 0603, Ceramic Capacitor, ±20%, 6.3 V	GRM188R60J476ME15	Murata	TPS63806, V _O > 3.6 V
R1	511 kΩ, 0603 Resistor, 1%, 100 mW	Standard	Standard	V _O = 3.3 V
R1	562 kΩ, 0603 Resistor, 1%, 100 mW	Standard	Standard	V _O = 3.6 V
R1	806 kΩ, 0603 Resistor, 1%, 100 mW	Standard	Standard	V _O = 5 V
R2	91 kΩ, 0603 Resistor, 1%, 100 mW	Standard	Standard	

Table 10-7. Components for Application Characteristic Curves ⁽¹⁾ (continued)

REFERENCE	DESCRIPTION	PART NUMBER	MANUFACTURER	COMMENT
R3	100 kΩ, 0603 Resistor, 1%, 100 mW	Standard	Standard	

(1) See [Third-party Products Disclaimer](#).

Table 10-8. Typical Characteristics Curves

PARAMETER	CONDITIONS	FIGURE
Output Current Capability		
Typical Output Current Capability versus Input Voltage	$V_O = 3.3\text{ V}$, TPS63805/TPS63807	Figure 10-3
Typical Output Current Capability versus Input Voltage	$V_O = 3.3\text{ V}$, TPS63806	Figure 10-4
Switching Frequency (TPS63805, TPS63806,TPS63807)		
Typical Inductor Switching Frequency versus Input Voltage	$I_O = 0\text{ A}$, MODE = High	Figure 10-5
Typical Inductor Burst Frequency versus Output Current	$V_O = 3.3\text{ V}$	Figure 10-6
Efficiency (TPS63805/TPS63807)		
Efficiency versus Output Current (PFM/PWM)	$V_I = 2.5\text{ V to }4.2\text{ V}$, $V_O = 3.3\text{ V}$, MODE = Low	Figure 10-7
Efficiency versus Output Current (PWM only)	$V_I = 2.5\text{ V to }4.2\text{ V}$, $V_O = 3.3\text{ V}$, MODE = High	Figure 10-8
Efficiency versus Output Current (PFM/PWM)	$V_I = 1.8\text{ V to }5\text{ V}$, $V_O = 3.3\text{ V}$, MODE = Low	Figure 10-9
Efficiency versus Output Current (PWM only)	$V_I = 1.8\text{ V to }5\text{ V}$, $V_O = 3.3\text{ V}$, MODE = High	Figure 10-10
Efficiency versus. Input Voltage (PFM/PWM)	$V_O = 3.3\text{ V}$, MODE = Low	Figure 10-11
Efficiency versus Input Voltage (PWM only)	$I_O = 1\text{ A}$, MODE = High	Figure 10-12
Efficiency (TPS63806)		
Efficiency versus Output Current (PFM/PWM)	$V_I = 2.5\text{ V to }4.2$, $V_O = 3.3\text{ V}$, MODE = Low	Figure 10-13
Efficiency versus Output Current (PWM only)	$V_I = 2.5\text{ V to }4.2$, $V_O = 3.3\text{ V}$, MODE = High	Figure 10-14
Efficiency versus Output Current (PFM/PWM)	$V_I = 1.8\text{ V to }5$, $V_O = 3.3\text{ V}$, MODE = Low	Figure 10-15
Efficiency versus Output Current (PWM only)	$V_I = 2.5\text{ V to }5$, $V_O = 3.3\text{ V}$, MODE = High	Figure 10-18
Efficiency versus Input Voltage (PFM/PWM)	$V_O = 3.3\text{ V}$, MODE = Low	Figure 10-17
Efficiency versus Input Voltage (PWM only)	$I_O = 1\text{ A}$, MODE = High	Figure 10-18
Regulation Accuracy (TPS63805/TPS63807)		
Load Regulation, PWM Operation	$V_O = 3.3\text{ V}$, MODE = High	Figure 10-19
Load Regulation, PFM/PWM Operation	$V_O = 3.3\text{ V}$, MODE = Low	Figure 10-20
Line Regulation, PWM Operation	$I_O = 1\text{ A}$, MODE = High	Figure 10-21
Line Regulation, PFM/PWM Operation	$I_O = 1\text{ A}$, MODE = Low	Figure 10-22
Regulation Accuracy (TPS63806)		
Load Regulation, PWM Operation	$V_O = 3.3\text{ V}$, MODE = High	Figure 10-23
Load Regulation, PFM/PWM Operation	$V_O = 3.3\text{ V}$, MODE = Low	Figure 10-24
Line Regulation, PWM Operation	$I_O = 1\text{ A}$, MODE = High	Figure 10-25
Line Regulation, PFM/PWM Operation	$I_O = 1\text{ A}$, MODE = Low	Figure 10-26
Switching Waveforms (TPS63805, TPS63806,TPS63807)		
Switching Waveforms, PFM Boost Operation	$V_I = 2.3\text{ V}$, $V_O = 3.3\text{ V}$, MODE = Low	Figure 10-27
Switching Waveforms, PFM Buck-Boost Operation	$V_I = 3.3\text{ V}$, $V_O = 3.3\text{ V}$, MODE = Low	Figure 10-28
Switching Waveforms, PFM Buck Operation	$V_I = 4.3\text{ V}$, $V_O = 3.3\text{ V}$, MODE = Low	Figure 10-29
Switching Waveforms, PWM Boost Operation	$V_I = 2.3\text{ V}$, $V_O = 3.3\text{ V}$, MODE = High	Figure 10-30
Switching Waveforms, PWM Buck-Boost Operation	$V_I = 3.3\text{ V}$, $V_O = 3.3\text{ V}$, MODE = High	Figure 10-31
Switching Waveforms, PWM Buck Operation	$V_I = 4.3\text{ V}$, $V_O = 3.3\text{ V}$, MODE = High	Figure 10-32
Transient Performance (TPS63805/TPS63807)		
Load Transient, PFM/PWM Boost Operation	$V_I = 2.5\text{ V}$, $V_O = 3.3\text{ V}$, Load = 100 mA to 1A, MODE = Low	Figure 10-33
Load Transient, PFM/PWM Buck-Boost Operation	$V_I = 3.3\text{ V}$, $V_O = 3.3\text{ V}$, Load = 100 mA to 1A, MODE = Low	Figure 10-34
Load Transient, PFM/PWM Buck Operation	$V_I = 4.2\text{ V}$, $V_O = 3.3\text{ V}$, Load = 100 mA to 1A, MODE = Low	Figure 10-35
Load Transient, PWM Boost Operation	$V_I = 2.5\text{ V}$, $V_O = 3.3\text{ V}$, Load = 100 mA to 1A, MODE = High	Figure 10-36

Table 10-8. Typical Characteristics Curves (continued)

PARAMETER	CONDITIONS	FIGURE
Load Transient, PWM Buck-Boost Operation	$V_I = 3.3\text{ V}$, $V_O = 3.3\text{ V}$, Load = 100 mA to 1A, MODE = High	Figure 10-37
Load Transient, PWM Buck Operation	$V_I = 4.2\text{ V}$, $V_O = 3.3\text{ V}$, Load = 100 mA to 1A, MODE = High	Figure 10-38
Line Transient, PWM Operation	$V_I = 2.3\text{ V}$ to 4.3 V , $V_O = 3.3\text{ V}$, Load = 0.5 A, MODE = Low	Figure 10-39
Line Transient, PWM Operation	$V_I = 2.3\text{ V}$ to 4.3 V , $V_O = 3.3\text{ V}$, Load = 1 A, MODE = Low	Figure 10-40
Line Transient, PWM Operation	$V_I = 3\text{ V}$ to 3.6 V , $V_O = 3.3\text{ V}$, Load = 0.5 A, MODE = Low	Figure 10-41
Transient Performance (TPS63806)		
Load Transient, PFM/PWM Boost Operation	$V_I = 2.3\text{ V}$, $V_O = 3.3\text{ V}$, Load = 25% to 75%, MODE = Low	Figure 10-42
Load Transient, PFM/PWM Buck-Boost Operation	$V_I = 3.3\text{ V}$, $V_O = 3.3\text{ V}$, Load = 25% to 75%, MODE = Low	Figure 10-43
Load Transient, PFM/PWM Buck Operation	$V_I = 4.3\text{ V}$, $V_O = 3.3\text{ V}$, Load = 25% to 75%, MODE = Low	Figure 10-44
Load Transient, PWM Boost Operation	$V_I = 2.3\text{ V}$, $V_O = 3.3\text{ V}$, Load = 25% to 75%, MODE = High	Figure 10-45
Load Transient, PWM Buck-Boost Operation	$V_I = 3.3\text{ V}$, $V_O = 3.3\text{ V}$, Load = 25% to 75%, MODE = High	Figure 10-46
Load Transient, PWM Buck Operation	$V_I = 4.3\text{ V}$, $V_O = 3.3\text{ V}$, Load = 25% to 75%, MODE = High	Figure 10-47
Line Transient, PWM Operation	$V_I = 2.3\text{ V}$ to 4.3 V , $V_O = 3.3\text{ V}$, Load = 0.5 A, MODE = Low	Figure 10-48
Line Transient, PWM Operation	$V_I = 2.3\text{ V}$ to 4.3 V , $V_O = 3.3\text{ V}$, Load = 1 A, MODE = Low	Figure 10-49
Line Transient, PWM Operation	$V_I = 3\text{ V}$ to 3.6 V , $V_O = 3.3\text{ V}$, Load = 0.5 A, MODE = Low	Figure 10-50
Pulsed load, PWM Operation	$V_I = 2.8\text{ V}$, $V_O = 3.3\text{ V}$, Load = 50 mA to 5 A, with 1 MHz and 50% duty cycle, $t_r = 120\text{ ns}$, $t_f = 60\text{ ns}$, MODE = High	Figure 10-51
Pulsed load, PWM Operation	$V_I = 3.3\text{ V}$, $V_O = 3.3\text{ V}$, Load = 50 mA to 5 A, with 1 MHz and 50% duty cycle, $t_r = 120\text{ ns}$, $t_f = 60\text{ ns}$, MODE = High	Figure 10-52
Pulsed load, PWM Operation	$V_I = 4.2\text{ V}$, $V_O = 3.3\text{ V}$, Load = 50 mA to 5 A, with 1 MHz and 50% duty cycle, $t_r = 120\text{ ns}$, $t_f = 60\text{ ns}$, MODE = High	Figure 10-53
Start-up (TPS63805, TPS63806, TPS63807)		
Start-up Behavior from Rising Enable, PFM Operation	$V_I = 2.2\text{ V}$, $V_O = 3.3\text{ V}$, Load = 10 mA, MODE = Low	Figure 10-54
Start-up Behavior from Rising Enable, PWM Operation	$V_I = 2.2\text{ V}$, $V_O = 3.3\text{ V}$, Load = 10 mA, MODE = High	Figure 10-55

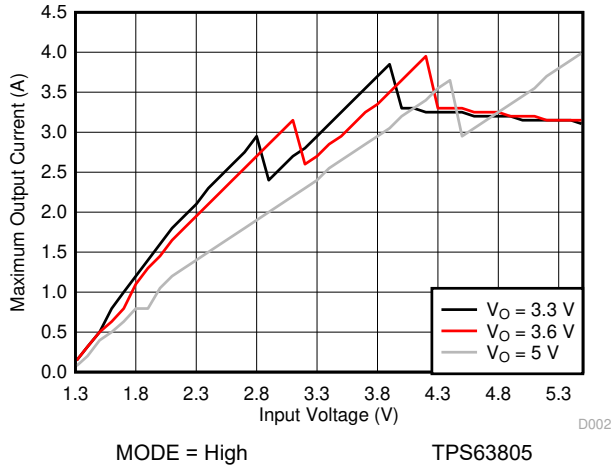

Figure 10-3. Typical Output Current Capability versus Input Voltage

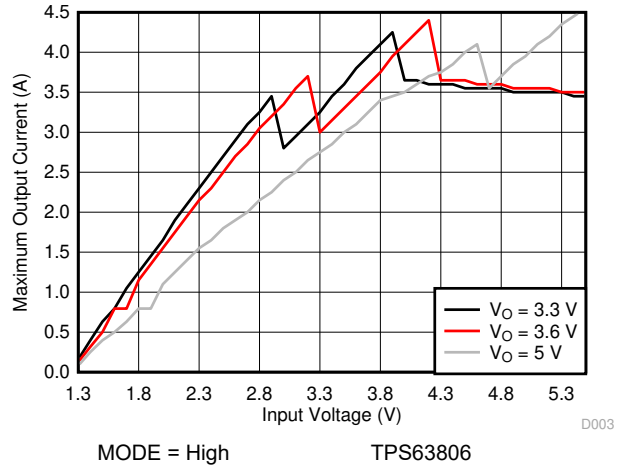

Figure 10-4. Typical Output Current Capability versus Input Voltage

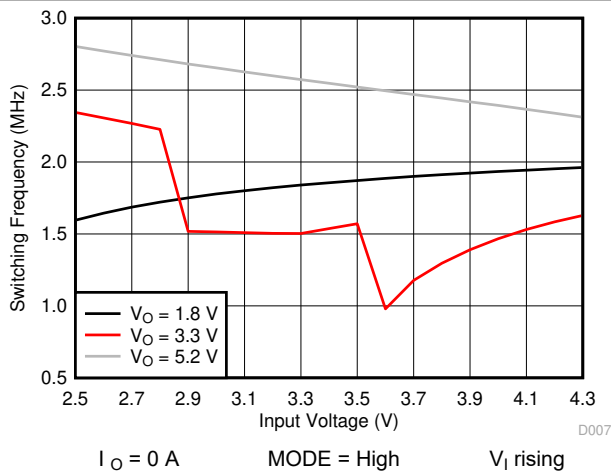

Figure 10-5. Typical Inductor Switching Frequency versus Input Voltage

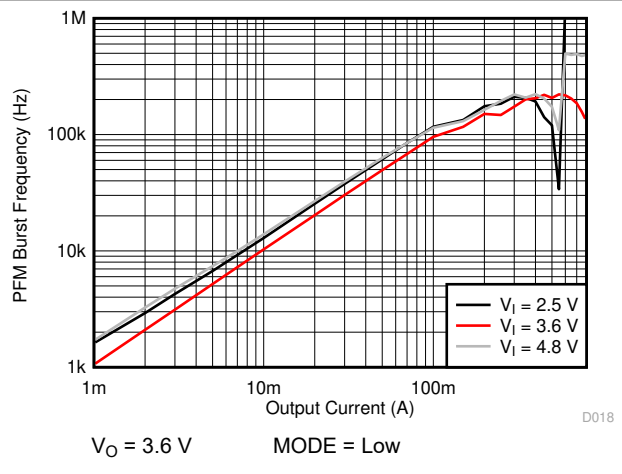

Figure 10-6. Typical Inductor Burst Frequency versus Output Current

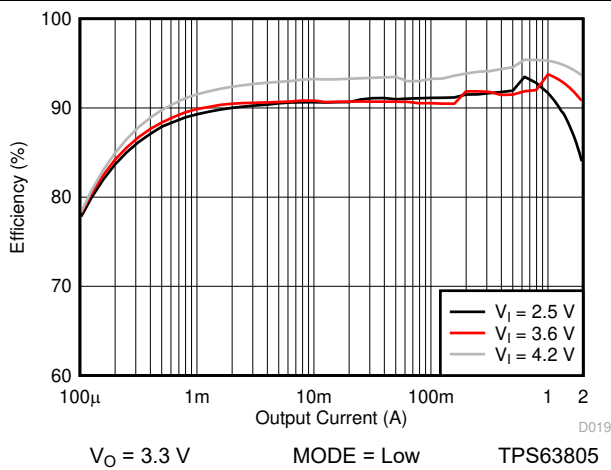

Figure 10-7. Efficiency versus Output Current (PFM/PWM)

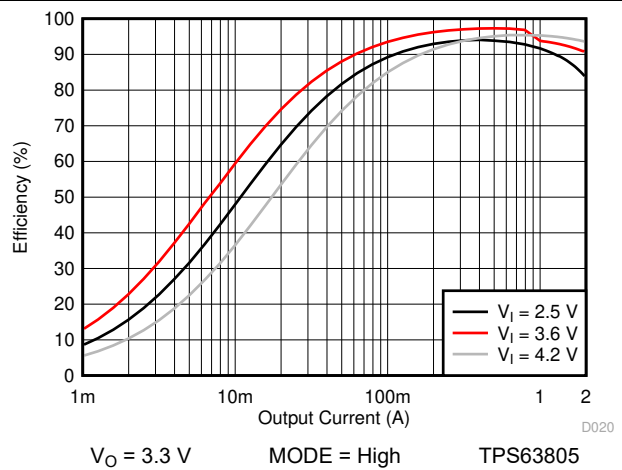

Figure 10-8. Efficiency versus Output Current (PWM Only)

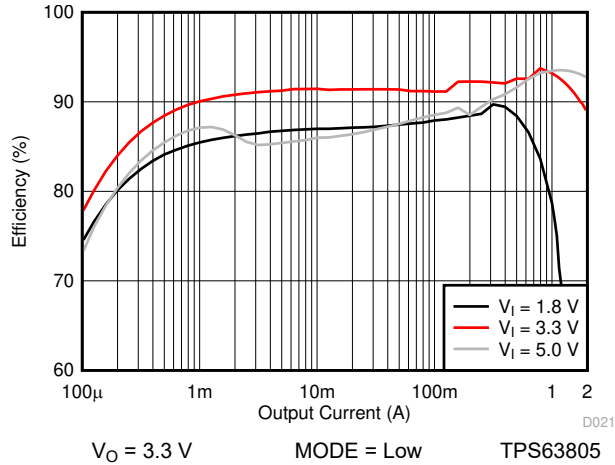

Figure 10-9. Efficiency versus Output Current (PFM/PWM)

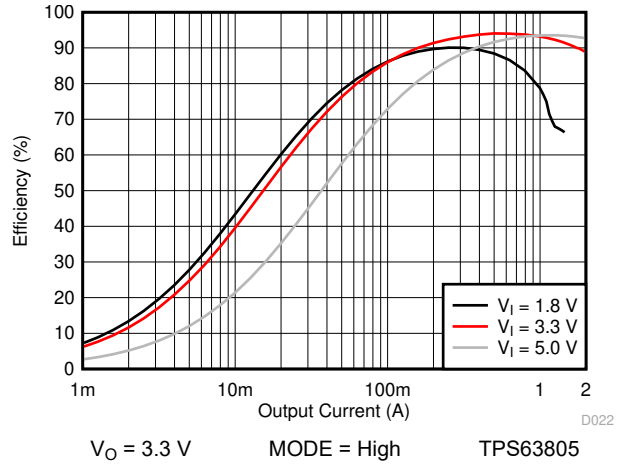

Figure 10-10. Efficiency versus Input Voltage (PWM Only)

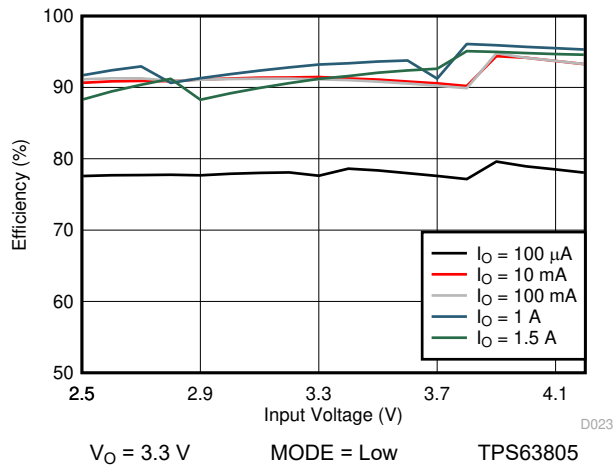

Figure 10-11. Efficiency versus Input Voltage (PFM/PWM)

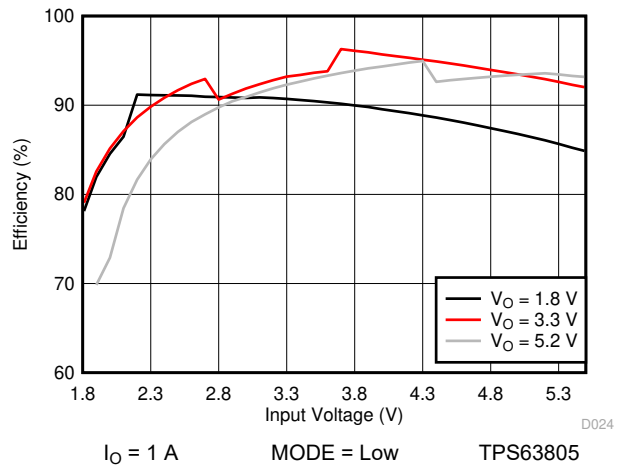

Figure 10-12. Efficiency versus Input Voltage (PWM Only)

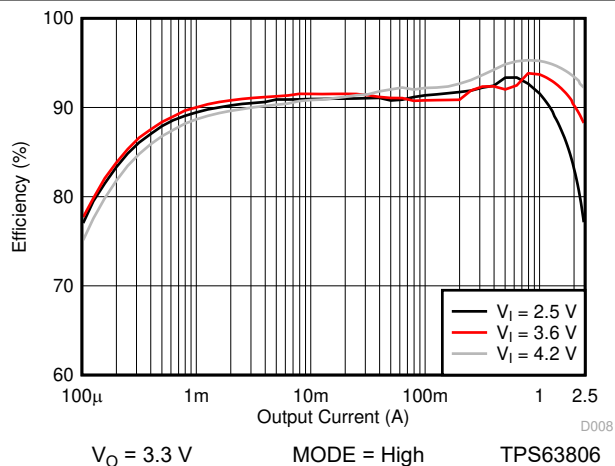

Figure 10-13. Efficiency versus Output Current (PFM/PWM)

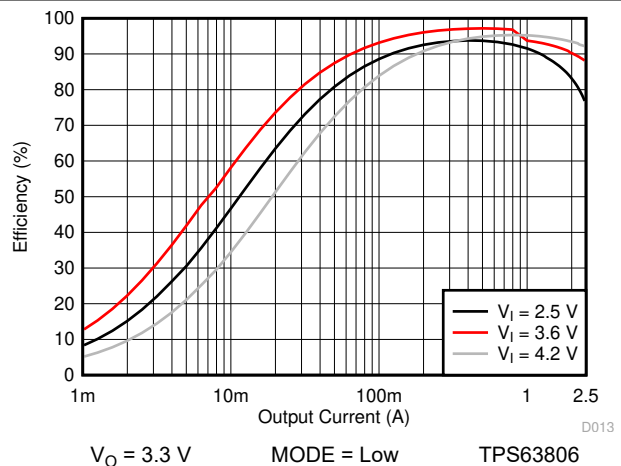

Figure 10-14. Efficiency versus Output Current (PWM Only)

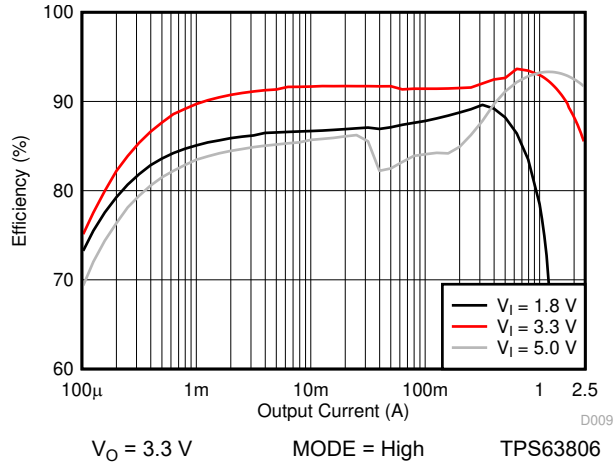

Figure 10-15. Efficiency versus Output Current (PFM/PWM)

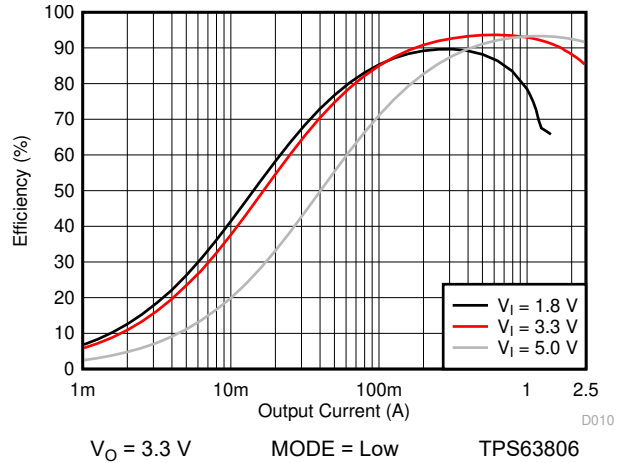

Figure 10-16. Efficiency versus Input Voltage (PWM Only)

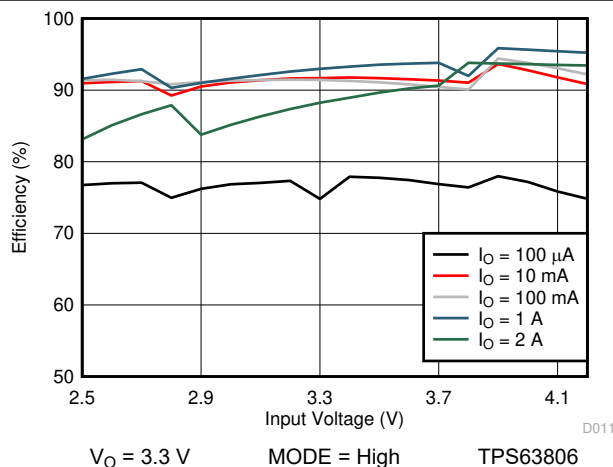

Figure 10-17. Efficiency versus Input Voltage (PFM/PWM)

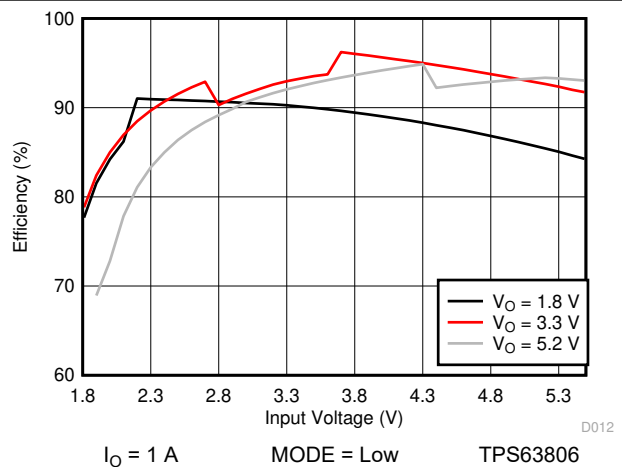

Figure 10-18. Efficiency versus Input Voltage (PWM Only)

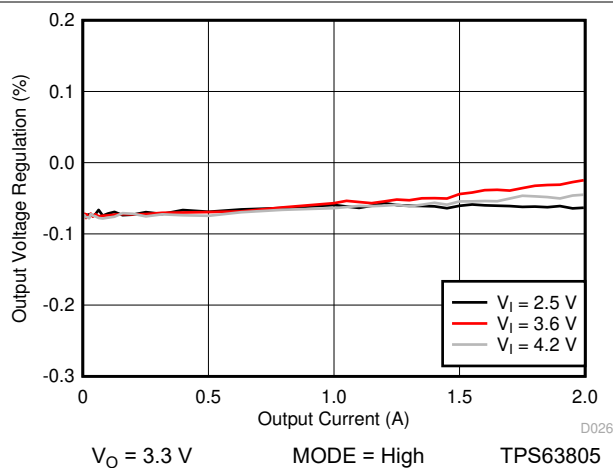

Figure 10-19. Load Regulation (PWM Only)

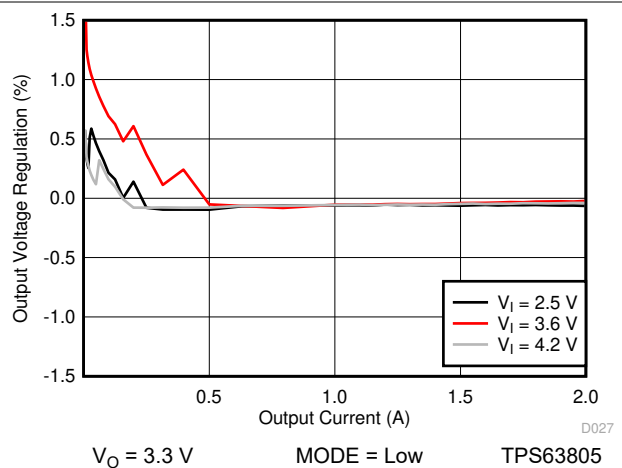

Figure 10-20. Load Regulation (PFM/PWM)

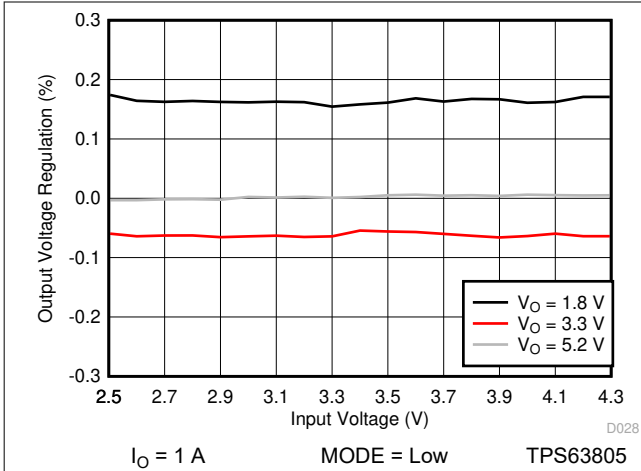

Figure 10-21. Line Regulation (PWM Only)

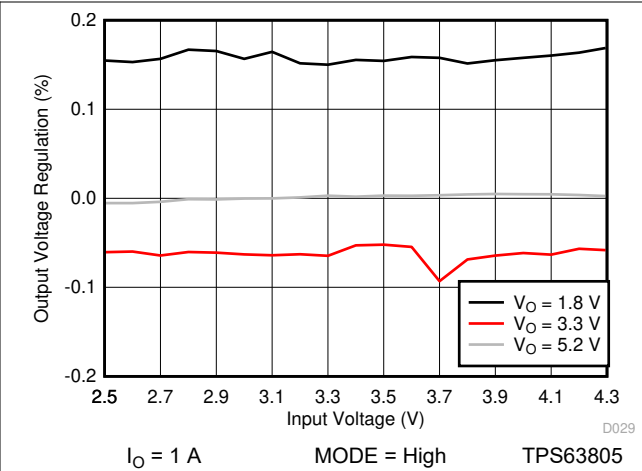

Figure 10-22. Line Regulation (PFM/PWM)

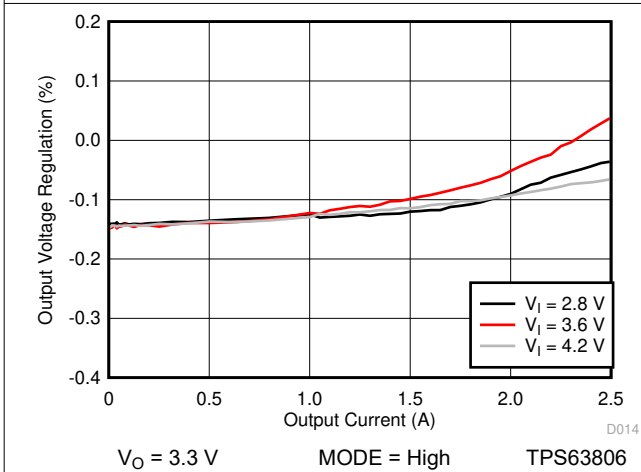

Figure 10-23. Load Regulation (PWM Only)

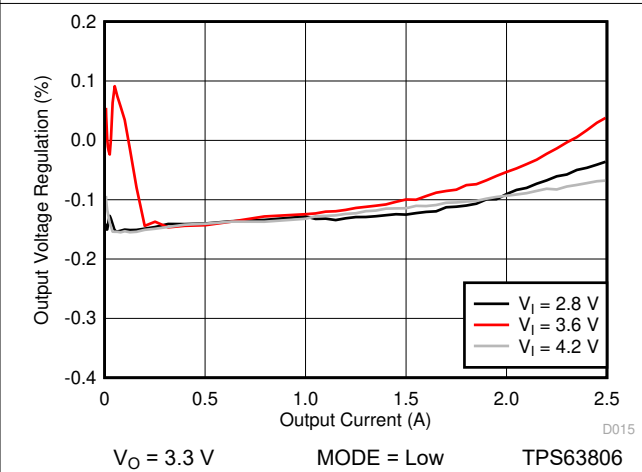

Figure 10-24. Load Regulation (PFM/PWM)

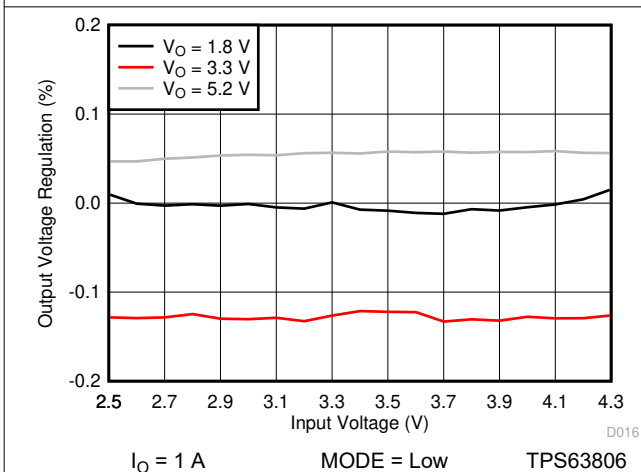

Figure 10-25. Line Regulation (PWM Only)

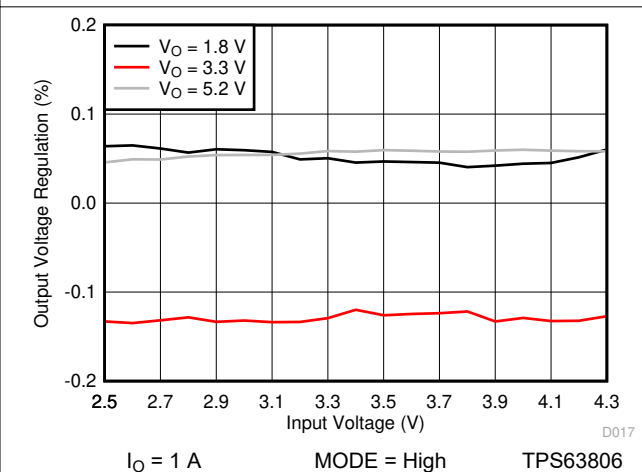
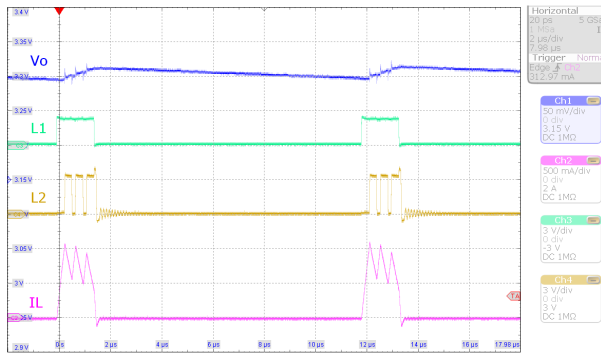
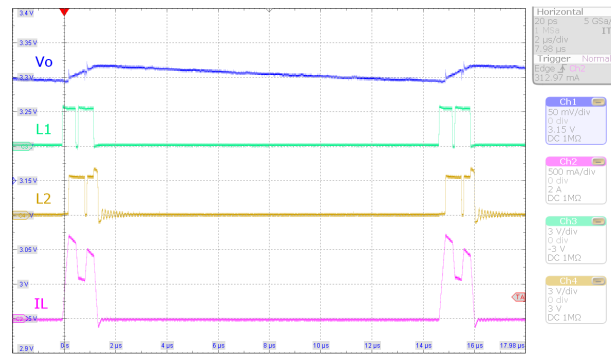

Figure 10-26. Line Regulation (PFM/PWM)



$V_I = 2.3\text{ V}, V_O = 3.3\text{ V}$
 $I_O = 40\text{ mA}$ MODE = Low

Figure 10-27. Switching Waveforms, PFM Boost Operation



$V_I = 3.3\text{ V}, V_O = 3.3\text{ V}$
 $I_O = 40\text{ mA}$ MODE = Low

Figure 10-28. Switching Waveforms, PFM Buck-Boost Operation

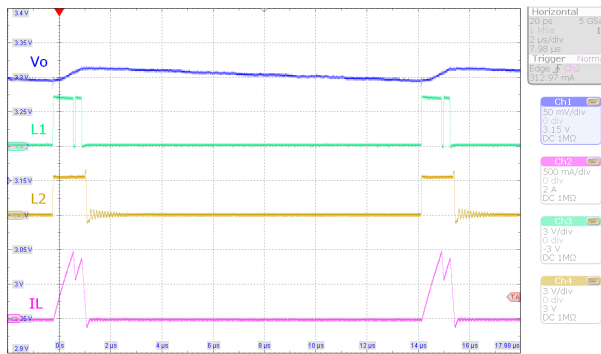

$V_I = 4.2\text{ V}, V_O = 3.3\text{ V}$ MODE = Low $I_O = 40\text{ mA}$

Figure 10-29. Switching Waveforms, PFM Buck Operation

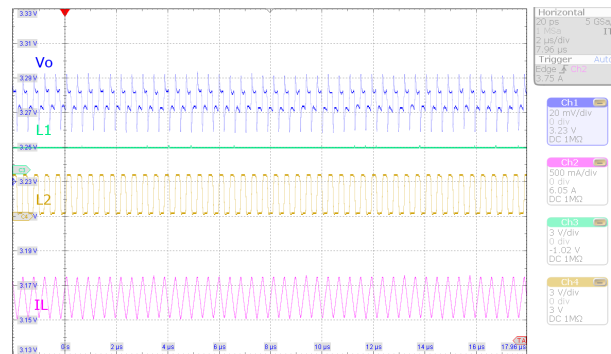

$V_I = 2.3\text{ V}, V_O = 3.3\text{ V}$
 $I_O = 2\text{ A}$ MODE = Low

Figure 10-30. Switching Waveforms, PWM Boost Operation

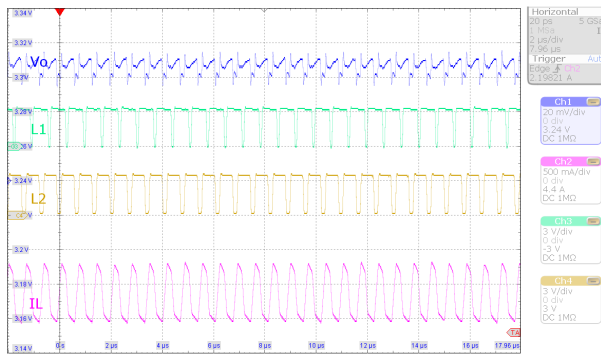

$V_I = 3.3\text{ V}, V_O = 3.3\text{ V}$
 $I_O = 2\text{ A}$ MODE = Low

Figure 10-31. Switching Waveforms, PWM Buck-Boost Operation

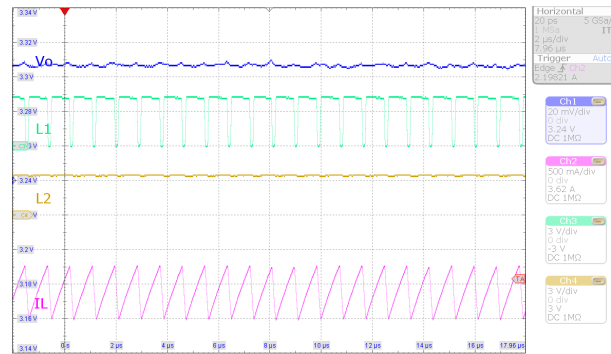

$V_I = 4.2\text{ V}, V_O = 3.3\text{ V}$
 $I_O = 2\text{ A}$ MODE = Low

Figure 10-32. Switching Waveforms, PWM Buck Operation

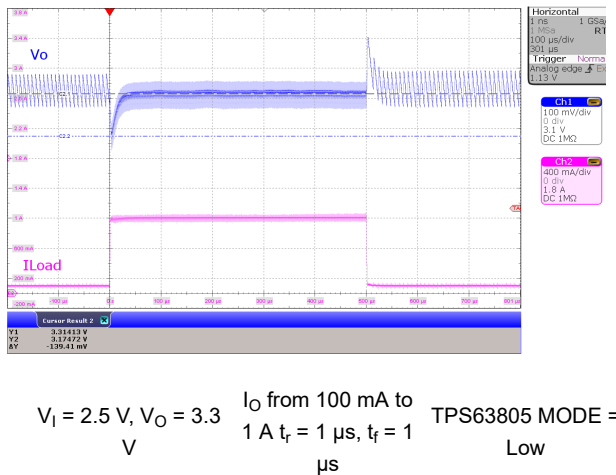

Figure 10-33. Load Transient, PFM/PWM Boost Operation

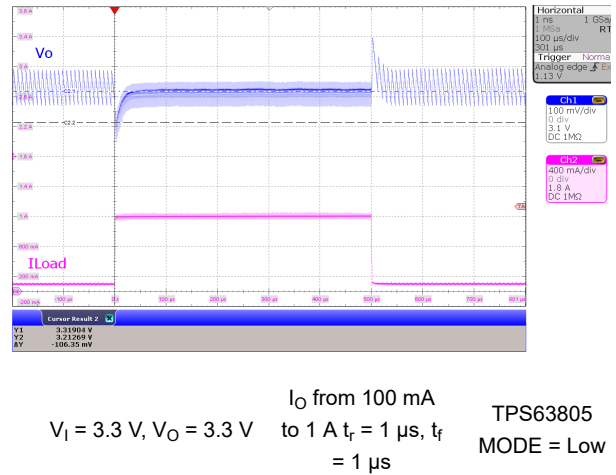

Figure 10-34. Load Transient, PFM/PWM Buck-Boost Operation

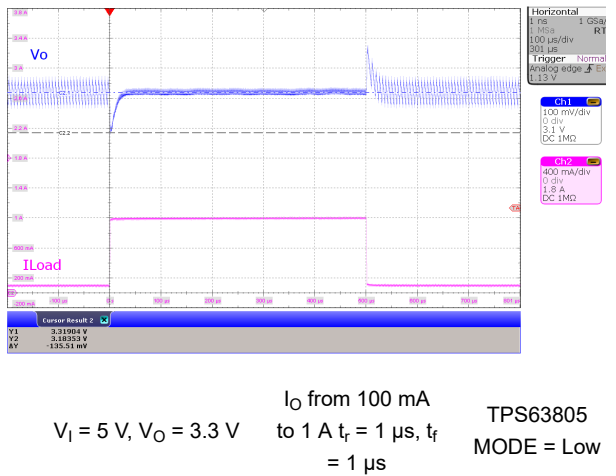

Figure 10-35. Load Transient, PFM/PWM Buck Operation

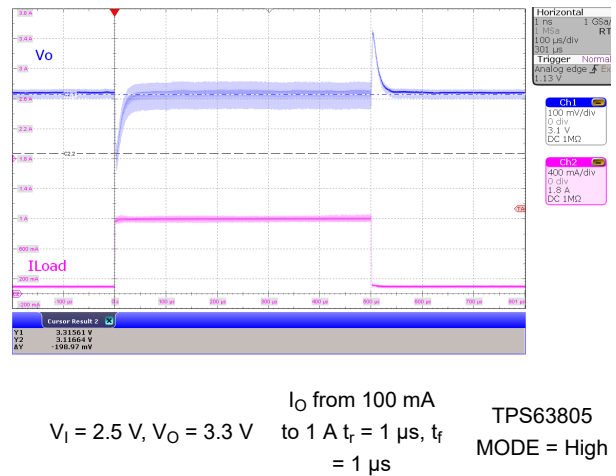

Figure 10-36. Load Transient, PWM Boost Operation

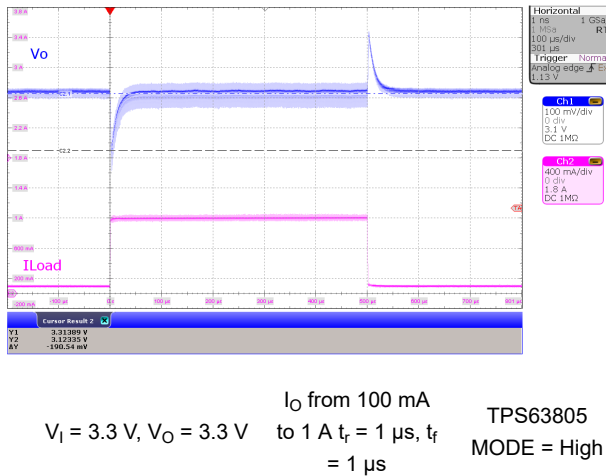

Figure 10-37. Load Transient, PWM Buck-Boost Operation

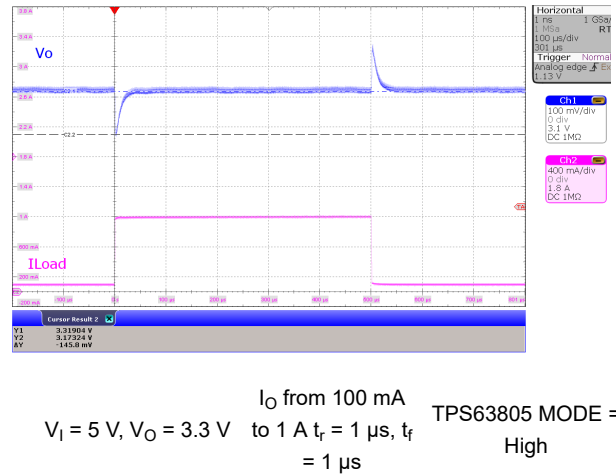
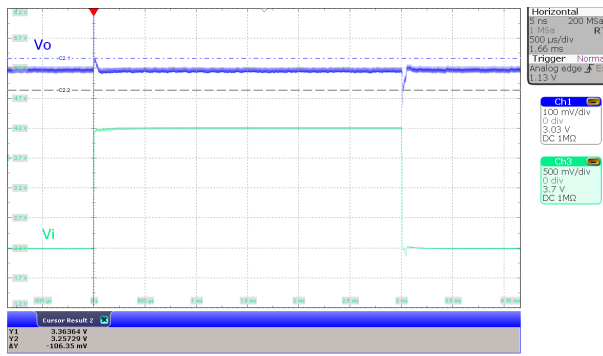
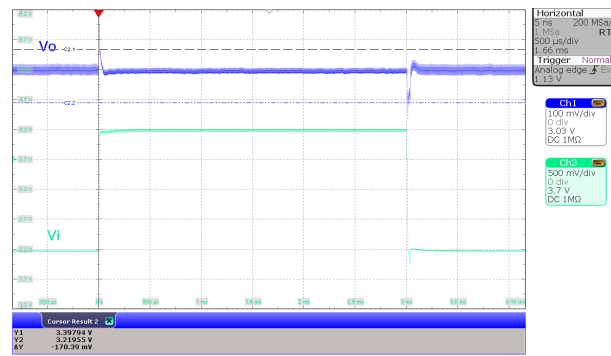

Figure 10-38. Load Transient, PWM Buck Operation



$I_O = 0.5\text{ A}$ V_I from 2.2 V to 4.2 V $t_r = 1\ \mu\text{s}$, $t_f = 1\ \mu\text{s}$ **TPS63805**
MODE = High

Figure 10-39. Line Transient, PWM Operation



$I_O = 1\text{ A}$ V_I from 2.2 V to 4.2 V $t_r = 1\ \mu\text{s}$, $t_f = 1\ \mu\text{s}$ **TPS63805**
MODE = High

Figure 10-40. Line Transient, PWM Operation

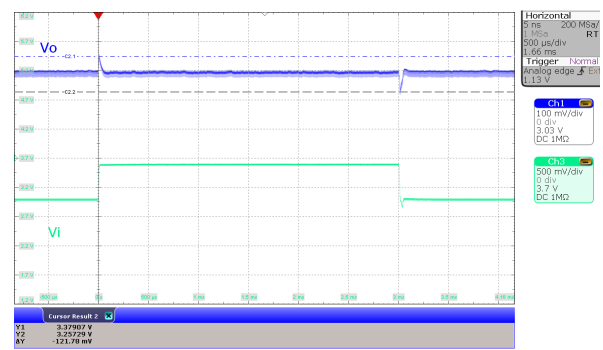

$I_O = 0.5\text{ A}$ V_I from 3 V to 3.6 V $t_r = 1\ \mu\text{s}$, $t_f = 1\ \mu\text{s}$ **TPS63805**
MODE = High

Figure 10-41. Line Transient, PWM Operation

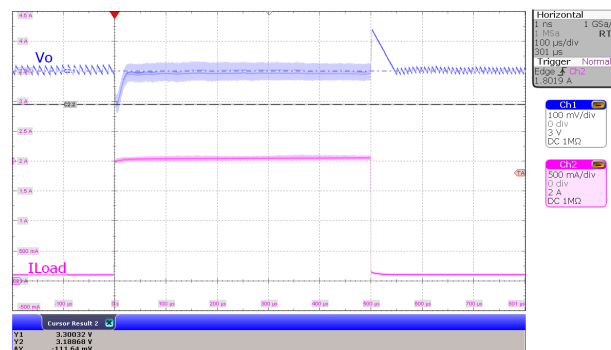

$V_I = 2.8\text{ V}$, $V_O = 3.3\text{ V}$ I_O from 100 mA to 2 A $t_r = 1\ \mu\text{s}$, $t_f = 1\ \mu\text{s}$ **TPS63806**
MODE = Low

Figure 10-42. Load Transient, PFM/PWM Boost Operation

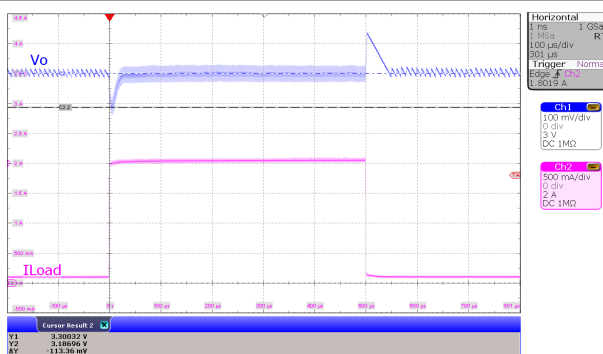

$V_I = 3.3\text{ V}$, $V_O = 3.3\text{ V}$ I_O from 100 mA to 2 A $t_r = 1\ \mu\text{s}$, $t_f = 1\ \mu\text{s}$ **TPS63806**
MODE = Low

Figure 10-43. Load Transient, PFM/PWM Buck-Boost Operation

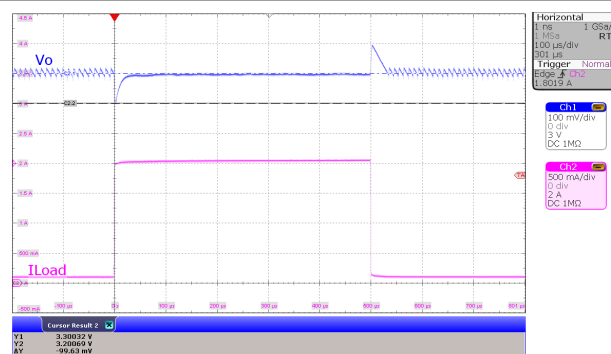

$V_I = 4.2\text{ V}$, $V_O = 3.3\text{ V}$ I_O from 100 mA to 2 A $t_r = 1\ \mu\text{s}$, $t_f = 1\ \mu\text{s}$ **TPS63806**
MODE = Low

Figure 10-44. Load Transient, PFM/PWM Buck Operation

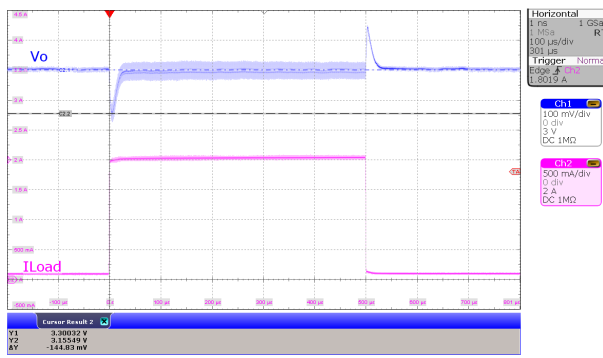

$V_I = 2.8\text{ V}$, $V_O = 3.3\text{ V}$ I_O from 100 mA to 2 A $t_r = 1\ \mu\text{s}$, $t_f = 1\ \mu\text{s}$ TPS63806 MODE = High

Figure 10-45. Load Transient, PWM Boost Operation

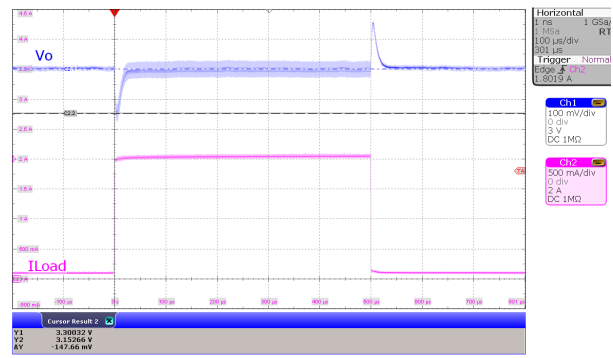

$V_I = 3.3\text{ V}$, $V_O = 3.3\text{ V}$ I_O 100 mA to 2 A $t_r = 1\ \mu\text{s}$, $t_f = 1\ \mu\text{s}$ TPS63806 MODE = High

Figure 10-46. Load Transient, PWM Buck-Boost Operation

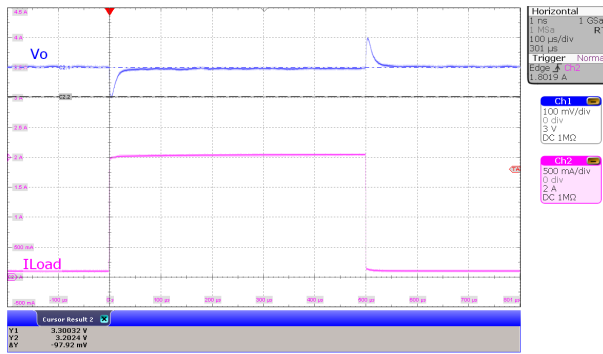

$V_I = 4.2\text{ V}$, $V_O = 3.3\text{ V}$ I_O 100 mA to 2 A $t_r = 1\ \mu\text{s}$, $t_f = 1\ \mu\text{s}$ TPS63806 MODE = High

Figure 10-47. Load Transient, PWM Buck Operation

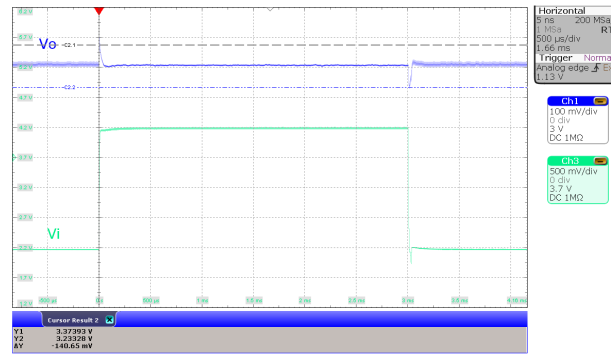

$I_O = 1\text{ A}$ V_I 2.2 V to 4.2 V $t_r = 1\ \mu\text{s}$, $t_f = 1\ \mu\text{s}$ TPS63806 MODE = High

Figure 10-48. Line Transient, PWM Operation

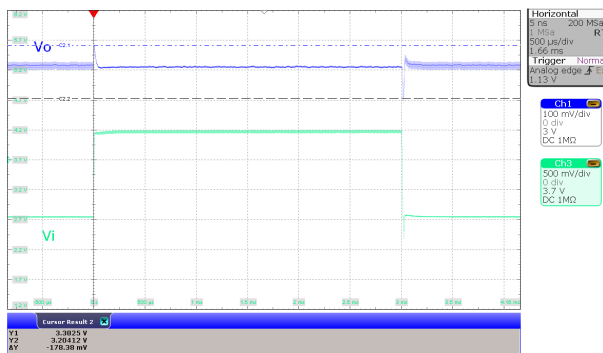

$I_O = 2\text{ A}$ V_I 2.2 V to 4.2 V $t_r = 1\ \mu\text{s}$, $t_f = 1\ \mu\text{s}$ TPS63806 MODE = High

Figure 10-49. Line Transient, PWM Operation

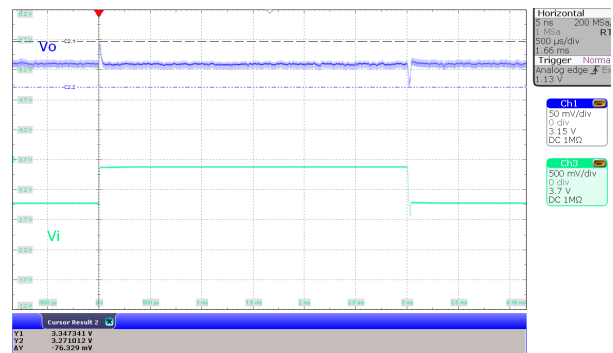

$I_O = 1\text{ A}$ V_I 3.0 V to 3.6 V $t_r = 1\ \mu\text{s}$, $t_f = 1\ \mu\text{s}$ TPS63806 MODE = High

Figure 10-50. Line Transient, PWM Operation

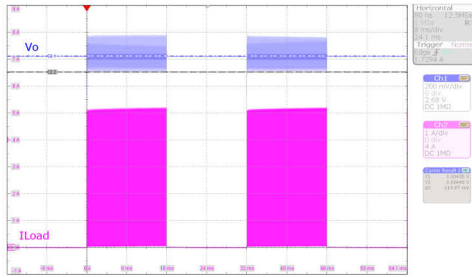

$V_I = 2.8\text{ V}, V_O = 3.3\text{ V}$ I_O 50 mA to 5 A with 1 MHz and 50% duty cycle $t_r = 120\text{ ns}, t_f = 60\text{ ns}$
TPS63806
MODE = High

Figure 10-51. Pulsed Load, PWM Operation

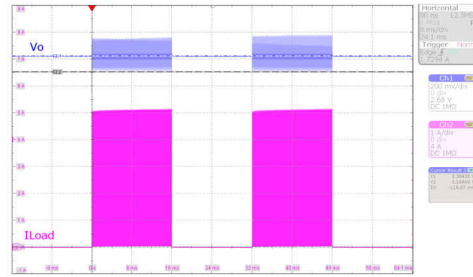

$V_I = 3.3\text{ V}, V_O = 3.3\text{ V}$ I_O 50 mA to 5 A with 1 MHz and 50% duty cycle $t_r = 120\text{ ns}, t_f = 60\text{ ns}$
TPS63806
MODE = High

Figure 10-52. Pulsed Load, PWM Operation

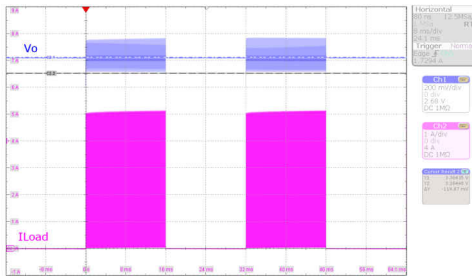

$V_I = 4.2\text{ V}, V_O = 3.3\text{ V}$ I_O 50 mA to 5 A with 1 MHz and 50% duty cycle $t_r = 120\text{ ns}, t_f = 60\text{ ns}$
TPS63806
MODE = High

Figure 10-53. Pulsed Load, PWM Operation

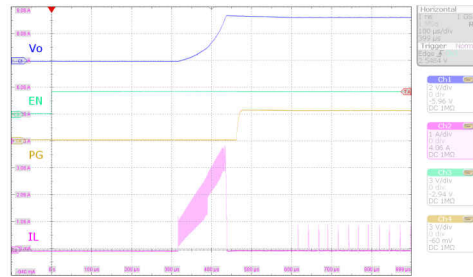

$V_I = 4.2\text{ V}, V_O = 3.3\text{ V}$ MODE = Low 100 mΩ resistive load

Figure 10-54. Start-up Behavior from Rising Enable, PFM Operation

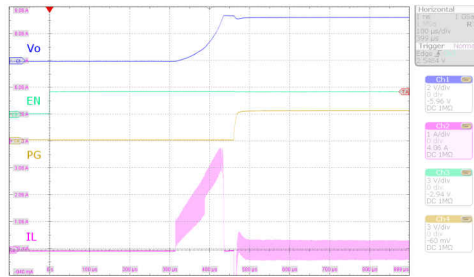

$V_I = 4.2\text{ V}, V_O = 3.3\text{ V}$ MODE = High 100 mΩ resistive load

Figure 10-55. Start-up Behavior from Rising Enable, PWM Operation

11 Power Supply Recommendations

The TPS63805, TPS63806, and TPS63807 device families have no special requirements for its input power supply. The input power supply output current needs to be rated according to the supply voltage, output voltage, and output current of the TPS63805, TPS63806, and TPS63807.

12 Layout

12.1 Layout Guidelines

The PCB layout is an important step to maintain the high performance of the TPS63805, TPS63806, and TPS63807 device.

1. Place input and output capacitors as close as possible to the IC. Traces need to be kept short. Route wide and direct traces to the input and output capacitor results in low trace resistance and low parasitic inductance.
2. Use a common ground node for power ground and a different one for control ground to minimize the effects of ground noise. Connect these ground nodes at any place close to one of the ground pins of the IC.
3. Use separate traces for the supply voltage of the power stage and the supply voltage of the analog stage.
4. The sense trace connected to FB is signal trace. Keep these traces away from L1 and L2 nodes.

12.2 Layout Example

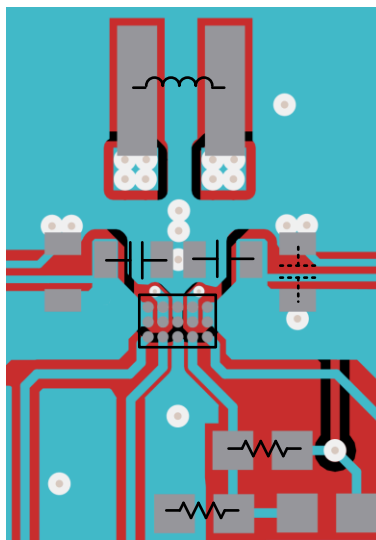

Figure 12-1. TPS63805, TPS63806, and TPS63807 Layout

13 Device and Documentation Support

13.1 Device Support

13.1.1 Third-Party Products Disclaimer

TI'S PUBLICATION OF INFORMATION REGARDING THIRD-PARTY PRODUCTS OR SERVICES DOES NOT CONSTITUTE AN ENDORSEMENT REGARDING THE SUITABILITY OF SUCH PRODUCTS OR SERVICES OR A WARRANTY, REPRESENTATION OR ENDORSEMENT OF SUCH PRODUCTS OR SERVICES, EITHER ALONE OR IN COMBINATION WITH ANY TI PRODUCT OR SERVICE.

13.1.2 Development Support

[QFN/SOP Package FAQs](#)

13.1.2.1 Custom Design With WEBENCH® Tools

[Click here](#) to create a custom design using the TPS63805/TPS63807 device with the WEBENCH® Power Designer. [Click here](#) to create a custom design using the TPS63806 device with the WEBENCH® Power Designer.

1. Start by entering the input voltage (V_{IN}), output voltage (V_{OUT}), and output current (I_{OUT}) requirements.
2. Optimize the design for key parameters such as efficiency, footprint, and cost using the optimizer dial.
3. Compare the generated design with other possible solutions from Texas Instruments.

The WEBENCH Power Designer provides a customized schematic along with a list of materials with real-time pricing and component availability.

In most cases, these actions are available:

- Run electrical simulations to see important waveforms and circuit performance
- Run thermal simulations to understand board thermal performance
- Export customized schematic and layout into popular CAD formats
- Print PDF reports for the design, and share the design with colleagues

Get more information about WEBENCH tools at www.ti.com/WEBENCH.

13.2 Receiving Notification of Documentation Updates

To receive notification of documentation updates, navigate to the device product folder on ti.com. Click on *Subscribe to updates* to register and receive a weekly digest of any product information that has changed. For change details, review the revision history included in any revised document.

13.3 Support Resources

[TI E2E™ support forums](#) are an engineer's go-to source for fast, verified answers and design help — straight from the experts. Search existing answers or ask your own question to get the quick design help you need.

Linked content is provided "AS IS" by the respective contributors. They do not constitute TI specifications and do not necessarily reflect TI's views; see TI's [Terms of Use](#).

13.4 Trademarks

TI E2E™ is a trademark of Texas Instruments.

All trademarks are the property of their respective owners.

13.5 Electrostatic Discharge Caution



This integrated circuit can be damaged by ESD. Texas Instruments recommends that all integrated circuits be handled with appropriate precautions. Failure to observe proper handling and installation procedures can cause damage.

ESD damage can range from subtle performance degradation to complete device failure. Precision integrated circuits may be more susceptible to damage because very small parametric changes could cause the device not to meet its published specifications.

13.6 Glossary

[TI Glossary](#) This glossary lists and explains terms, acronyms, and definitions.

14 Mechanical, Packaging, and Orderable Information

The following pages include mechanical, packaging, and orderable information. This information is the most current data available for the designated devices. This data is subject to change without notice and revision of this document. For browser-based versions of this data sheet, refer to the left-hand navigation.

PACKAGING INFORMATION

Orderable part number	Status (1)	Material type (2)	Package Pins	Package qty Carrier	RoHS (3)	Lead finish/ Ball material (4)	MSL rating/ Peak reflow (5)	Op temp (°C)	Part marking (6)
TPS63805YFFR	Active	Production	DSBGA (YFF) 15	3000 LARGE T&R	Yes	SNAGCU	Level-1-260C-UNLIM	-40 to 125	TPS63805
TPS63805YFFR.A	Active	Production	DSBGA (YFF) 15	3000 LARGE T&R	Yes	SNAGCU	Level-1-260C-UNLIM	-40 to 125	TPS63805
TPS63805YFFT	Active	Production	DSBGA (YFF) 15	250 SMALL T&R	Yes	SNAGCU	Level-1-260C-UNLIM	-40 to 125	TPS63805
TPS63805YFFT.A	Active	Production	DSBGA (YFF) 15	250 SMALL T&R	Yes	SNAGCU	Level-1-260C-UNLIM	-40 to 125	TPS63805
TPS63806YFFR	Active	Production	DSBGA (YFF) 15	3000 LARGE T&R	Yes	SNAGCU	Level-1-260C-UNLIM	-40 to 125	TPS63806
TPS63806YFFR.A	Active	Production	DSBGA (YFF) 15	3000 LARGE T&R	Yes	SNAGCU	Level-1-260C-UNLIM	-40 to 125	TPS63806
TPS63807YFFR	Active	Production	DSBGA (YFF) 15	3000 LARGE T&R	Yes	SNAGCU	Level-1-260C-UNLIM	-40 to 125	TPS63807
TPS63807YFFR.A	Active	Production	DSBGA (YFF) 15	3000 LARGE T&R	Yes	SNAGCU	Level-1-260C-UNLIM	-40 to 125	TPS63807

(1) **Status:** For more details on status, see our [product life cycle](#).

(2) **Material type:** When designated, preproduction parts are prototypes/experimental devices, and are not yet approved or released for full production. Testing and final process, including without limitation quality assurance, reliability performance testing, and/or process qualification, may not yet be complete, and this item is subject to further changes or possible discontinuation. If available for ordering, purchases will be subject to an additional waiver at checkout, and are intended for early internal evaluation purposes only. These items are sold without warranties of any kind.

(3) **RoHS values:** Yes, No, RoHS Exempt. See the [TI RoHS Statement](#) for additional information and value definition.

(4) **Lead finish/Ball material:** Parts may have multiple material finish options. Finish options are separated by a vertical ruled line. Lead finish/Ball material values may wrap to two lines if the finish value exceeds the maximum column width.

(5) **MSL rating/Peak reflow:** The moisture sensitivity level ratings and peak solder (reflow) temperatures. In the event that a part has multiple moisture sensitivity ratings, only the lowest level per JEDEC standards is shown. Refer to the shipping label for the actual reflow temperature that will be used to mount the part to the printed circuit board.

(6) **Part marking:** There may be an additional marking, which relates to the logo, the lot trace code information, or the environmental category of the part.

Multiple part markings will be inside parentheses. Only one part marking contained in parentheses and separated by a "-" will appear on a part. If a line is indented then it is a continuation of the previous line and the two combined represent the entire part marking for that device.

Important Information and Disclaimer:The information provided on this page represents TI's knowledge and belief as of the date that it is provided. TI bases its knowledge and belief on information provided by third parties, and makes no representation or warranty as to the accuracy of such information. Efforts are underway to better integrate information from third parties. TI has taken and continues to take reasonable steps to provide representative and accurate information but may not have conducted destructive testing or chemical analysis on incoming materials and chemicals. TI and TI suppliers consider certain information to be proprietary, and thus CAS numbers and other limited information may not be available for release.

In no event shall TI's liability arising out of such information exceed the total purchase price of the TI part(s) at issue in this document sold by TI to Customer on an annual basis.

TAPE AND REEL INFORMATION

QUADRANT ASSIGNMENTS FOR PIN 1 ORIENTATION IN TAPE



*All dimensions are nominal

Device	Package Type	Package Drawing	Pins	SPQ	Reel Diameter (mm)	Reel Width W1 (mm)	A0 (mm)	B0 (mm)	K0 (mm)	P1 (mm)	W (mm)	Pin1 Quadrant
TPS63805YFFR	DSBGA	YFF	15	3000	180.0	8.4	1.5	2.42	0.75	4.0	8.0	Q1
TPS63805YFFT	DSBGA	YFF	15	250	180.0	8.4	1.5	2.42	0.75	4.0	8.0	Q1
TPS63806YFFR	DSBGA	YFF	15	3000	180.0	8.4	1.5	2.42	0.75	4.0	8.0	Q1
TPS63807YFFR	DSBGA	YFF	15	3000	180.0	8.4	1.5	2.42	0.75	4.0	8.0	Q1

TAPE AND REEL BOX DIMENSIONS

*All dimensions are nominal

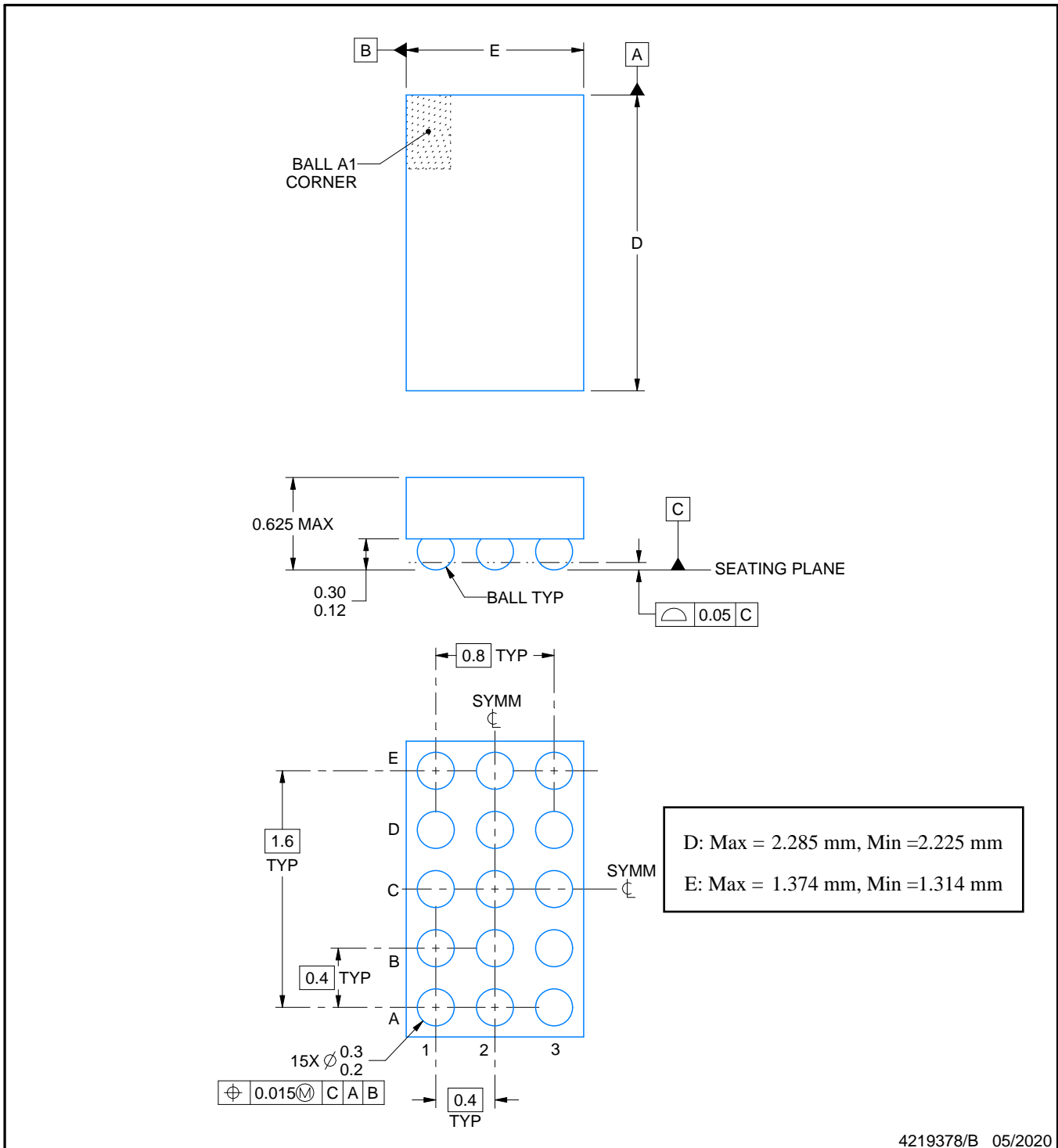
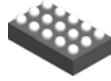
Device	Package Type	Package Drawing	Pins	SPQ	Length (mm)	Width (mm)	Height (mm)
TPS63805YFFR	DSBGA	YFF	15	3000	182.0	182.0	20.0
TPS63805YFFT	DSBGA	YFF	15	250	182.0	182.0	20.0
TPS63806YFFR	DSBGA	YFF	15	3000	182.0	182.0	20.0
TPS63807YFFR	DSBGA	YFF	15	3000	182.0	182.0	20.0



4219378/B 05/2020

NOTES:

1. All linear dimensions are in millimeters. Any dimensions in parenthesis are for reference only. Dimensioning and tolerancing per ASME Y14.5M.
2. This drawing is subject to change without notice.

EXAMPLE BOARD LAYOUT

YFF0015

DSBGA - 0.625 mm max height

DIE SIZE BALL GRID ARRAY

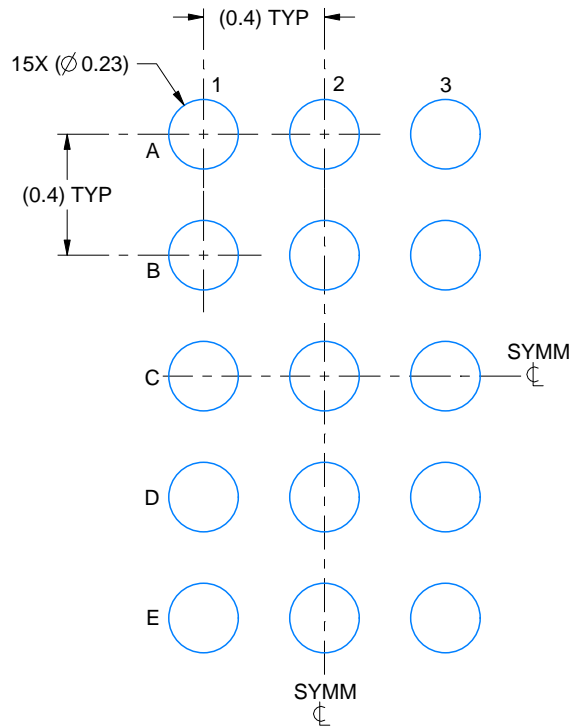

LAND PATTERN EXAMPLE
EXPOSED METAL SHOWN
SCALE:40X

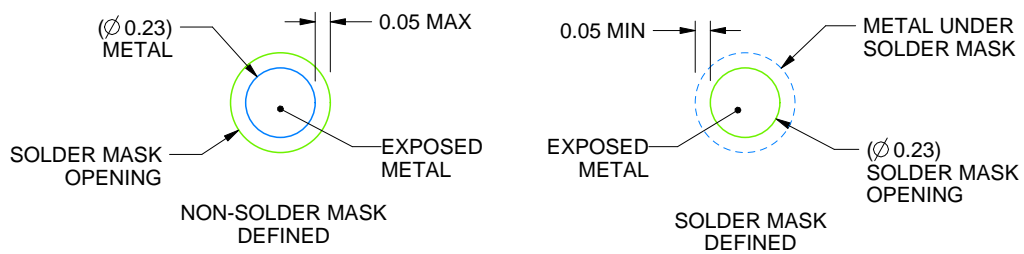

SOLDER MASK DETAILS
NOT TO SCALE

4219378/B 05/2020

NOTES: (continued)

- Final dimensions may vary due to manufacturing tolerance considerations and also routing constraints. For more information, see Texas Instruments literature number SNVA009 (www.ti.com/lit/snva009).

EXAMPLE STENCIL DESIGN

YFF0015

DSBGA - 0.625 mm max height

DIE SIZE BALL GRID ARRAY

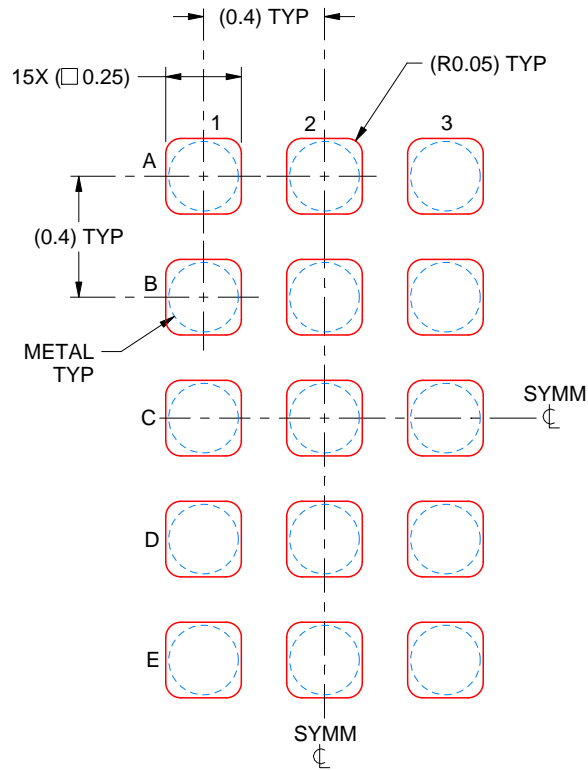

SOLDER PASTE EXAMPLE
BASED ON 0.1 mm THICK STENCIL
SCALE:40X

4219378/B 05/2020

NOTES: (continued)

4. Laser cutting apertures with trapezoidal walls and rounded corners may offer better paste release.

IMPORTANT NOTICE AND DISCLAIMER

TI PROVIDES TECHNICAL AND RELIABILITY DATA (INCLUDING DATASHEETS), DESIGN RESOURCES (INCLUDING REFERENCE DESIGNS), APPLICATION OR OTHER DESIGN ADVICE, WEB TOOLS, SAFETY INFORMATION, AND OTHER RESOURCES "AS IS" AND WITH ALL FAULTS, AND DISCLAIMS ALL WARRANTIES, EXPRESS AND IMPLIED, INCLUDING WITHOUT LIMITATION ANY IMPLIED WARRANTIES OF MERCHANTABILITY, FITNESS FOR A PARTICULAR PURPOSE OR NON-INFRINGEMENT OF THIRD PARTY INTELLECTUAL PROPERTY RIGHTS.

These resources are intended for skilled developers designing with TI products. You are solely responsible for (1) selecting the appropriate TI products for your application, (2) designing, validating and testing your application, and (3) ensuring your application meets applicable standards, and any other safety, security, regulatory or other requirements.

These resources are subject to change without notice. TI grants you permission to use these resources only for development of an application that uses the TI products described in the resource. Other reproduction and display of these resources is prohibited. No license is granted to any other TI intellectual property right or to any third party intellectual property right. TI disclaims responsibility for, and you fully indemnify TI and its representatives against any claims, damages, costs, losses, and liabilities arising out of your use of these resources.

TI's products are provided subject to [TI's Terms of Sale](#), [TI's General Quality Guidelines](#), or other applicable terms available either on ti.com or provided in conjunction with such TI products. TI's provision of these resources does not expand or otherwise alter TI's applicable warranties or warranty disclaimers for TI products. Unless TI explicitly designates a product as custom or customer-specified, TI products are standard, catalog, general purpose devices.

TI objects to and rejects any additional or different terms you may propose.

Copyright © 2025, Texas Instruments Incorporated

Last updated 10/2025