

150-mA LOW-NOISE LDO WITH IN-RUSH CURRENT CONTROL FOR USB APPLICATION

FEATURES

- 150-mA Low-Dropout Regulator
- Available in 2.5 V, 3.3 V
- Programmable Slew Rate Control
- Output Noise Typically 56 μV_{RMS}
- Only 17 μA Quiescent Current at 150 mA
- 1 μA Quiescent Current in Standby Mode
- Dropout Voltage Typically 150 mV at 150 mA (TPS78833)
- Over Current Limitation
- -40°C to 125°C Operating Junction Temperature Range
- 5-Pin SOT-23 (DBV) Package

DESCRIPTION

The TPS78825 and TPS78833 are very small (SOT-23) package, low-noise LDOs that regulate the output voltage to 2.5 V and 3.3 V with input voltage ranging from 2.7 V to an absolute maximum of 13.5 V. These devices output 150 mA with a peak current of 350 mA (typ). The TPS788xx family uses the SR pin to program the output voltage slew rate to control the in-rush current. This is specifically used in the USB application where large load capacitance is present at start-up. The TPS788xx devices use only 17 μA of quiescent current and exhibit only 56 μV_{RMS} of output voltage noise using a 10 μF output capacitor.

The usual PNP pass transistor has been replaced by a PMOS pass element. Because the PMOS pass element behaves as a low-value resistor, the dropout voltage is very low, typically 150 mV at 150 mA of load current, and is directly proportional to the load current.

The TPS788xx also features a logic-enabled sleep mode to shut down the regulator, reducing quiescent current to 1 μA typical at $T_J = 25^{\circ}\text{C}$.

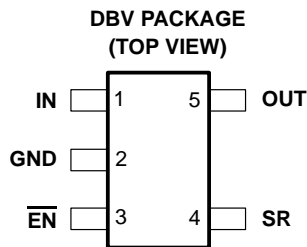

Please be aware that an important notice concerning availability, standard warranty, and use in critical applications of Texas Instruments semiconductor products and disclaimers thereto appears at the end of this data sheet.

PRODUCTION DATA information is current as of publication date. Products conform to specifications per the terms of Texas Instruments standard warranty. Production processing does not necessarily include testing of all parameters.

AVAILABLE OPTIONS

T _J	VOLTAGE	PACKAGE	PART NUMBER		SYMBOL
-40°C to 125°C	2.5 V	SOT-23 (DBV)	TPS78825DBVT†	TPS78825DBVR‡	PGZI
	3.3 V		TPS78833DBVT	TPS78833DBVR	PGTI

† The DBVT indicates tape and reel of 250 parts.

‡ The DBVR indicates tape and reel of 3000 parts.

functional block diagram

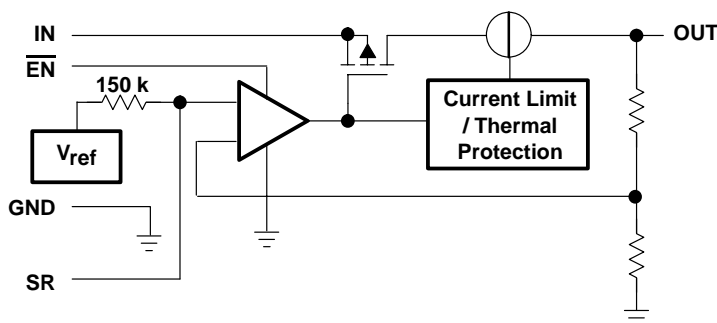

Terminal Functions

TERMINAL NAME	NO.	I/O	DESCRIPTION
EN	3	I	Active low enable
GND	2		Regulator ground
IN	1	I	The IN terminal is the input to the device.
OUT	5	O	The OUT terminal is the regulated output of the device.
SR	4	I	The SR terminal is used to control the in-rush current.

absolute maximum ratings over operating free-air temperature range (unless otherwise noted)§

Input voltage range (see Note 1)	-0.3 V to 13.5 V
Voltage range at EN	-0.3 V to V _I + 0.3 V
Voltage on OUT	7 V
Peak output current	Internally limited
ESD rating, HBM	2 kV
Continuous total power dissipation	See Dissipation Rating Table
Operating virtual junction temperature range, T _J	-40°C to 150°C
Operating ambient temperature range, T _A	-40°C to 85°C
Storage temperature range, T _{stg}	-65°C to 150°C

§ Stresses beyond those listed under “absolute maximum ratings” may cause permanent damage to the device. These are stress ratings only, and functional operation of the device at these or any other conditions beyond those indicated under “recommended operating conditions” is not implied. Exposure to absolute-maximum-rated conditions for extended periods may affect device reliability.

NOTE 1: All voltage values are with respect to network ground terminal.

DISSIPATION RATING TABLE

BOARD	PACKAGE	R _{θJC}	R _{θJA}	DERATING FACTOR ABOVE T _A = 25°C	T _A ≤ 25°C POWER RATING	T _A = 70°C POWER RATING	T _A = 85°C POWER RATING
Low K†	DBV	65.8°C/W	259°C/W	3.9 mW/°C	386 mW	212 mW	154 mW
High K#	DBV	65.8°C/W	180°C/W	5.6 mW/°C	555 mW	305 mW	222 mW

† The JEDEC Low K (1s) board design used to derive this data was a 3 inch x 3 inch, two layer board with 2 ounce copper traces on top of the board.

The JEDEC High K (2s2p) board design used to derive this data was a 3 inch x 3 inch, multilayer board with 1 ounce internal power and ground planes and 2 ounce copper traces on top and bottom of the board.

electrical characteristics over recommended operating free-air temperature range $\overline{EN} = 0$,
 $T_J = -40$ to 125 °C, $V_I = V_O(\text{typ}) + 1$ V, $I_O = 1$ mA, $C_O = 4.7$ μF , $C(\text{SR}) = 0.01$ μF (unless otherwise noted)

PARAMETER		TEST CONDITIONS	MIN	TYP	MAX	UNIT
V_I	Input voltage (see Note 2)		2.7		10	V
I_O	Continuous output current (see Note 3)		0		150	mA
T_J	Operating junction temperature		-40		125	°C
Output voltage	TPS78825	$T_J = 25^\circ\text{C}$		2.5		V
		$10 \mu\text{A} < I_O < 150 \text{ mA}, 3.5 \text{ V} < V_I < 10 \text{ V}$	2.425		2.575	
	TPS78833	$T_J = 25^\circ\text{C}$		3.3		
		$10 \mu\text{A} < I_O < 150 \text{ mA}, 3.8 \text{ V} < V_I < 10 \text{ V}$	3.201		3.399	
Quiescent current (GND current)	$10 \mu\text{A} < I_O < 450 \text{ mA}, T_J = 25^\circ\text{C}$			17		μA
	$10 \mu\text{A} < I_O < 150 \text{ mA}$				28	
Load regulation	$10 \mu\text{A} < I_O < 200 \text{ mA}, T_J = 25^\circ\text{C}$			12		mV
Output voltage line regulation ($\Delta V_O/V_O$) (see Note 5)	$V_O + 1 \text{ V} < V_I \leq 10 \text{ V}, T_J = 25^\circ\text{C}$			0.04		%V
	$V_O + 1 \text{ V} < V_I \leq 10 \text{ V}$				0.1	
Output noise voltage (TPS78833)	BW = 200 Hz to 100 kHz, $I_O = 150 \text{ mA}$, $T_J = 25^\circ\text{C}$, $C_O = 10 \mu\text{F}$, $C(\text{SR}) = 0.47 \mu\text{F}$			56		μV_{RMS}
Time, start-up (TPS78833)	$R_L = 22 \Omega$, $C_O = 10 \mu\text{F}$, $T_J = 25^\circ\text{C}$	$C(\text{byp}) = 0.01 \mu\text{F}$		10		ms
		$C(\text{byp}) = 0.1 \mu\text{F}$		50		
		$C(\text{byp}) = 0.47 \mu\text{F}$		300		
Output current limit	$V_O = 0 \text{ V}$ (see Note 4)			350	750	mA
Standby current	$EN = 0 \text{ V}, 2.7 \text{ V} < V_I < 10 \text{ V}$			1	2	μA
High level enable input voltage	$2.7 \text{ V} < V_I < 10 \text{ V}$		1.7			V
Low level enable input voltage	$2.7 \text{ V} < V_I < 10 \text{ V}$				0.9	V
Input current (EN)	$EN = 0$		-1		1	μA
Power supply ripple rejection	TPS78833	$f = 1 \text{ kHz}$, $T_J = 25^\circ\text{C}$, $C_O = 10 \mu\text{F}$	$C(\text{SL}) = 0.01 \mu\text{F}$, $I_O = 150 \text{ mA}$,	70		dB
Dropout voltage (see Note 6)	TPS78833	$I_O = 150 \text{ mA}, T_J = 25^\circ\text{C}$		150		mV
		$I_O = 150 \text{ mA}$			300	

NOTES: 2. To calculate the minimum input voltage for your maximum output current, use the following formula:

$$V_I(\text{min}) = V_O(\text{max}) + V_{\text{DO}}(\text{max load})$$

- Continuous output current and operating junction temperature are limited by internal protection circuitry, but it is not recommended that the device operate under conditions beyond those specified in this table for extended periods of time.
- The minimum IN operating voltage is 2.7 V or $V_O(\text{typ}) + 1$ V, whichever is greater. The maximum IN voltage is 5.5 V. The maximum output current is 200 mA.
- If $V_O \leq 2.5$ V then $V_{\text{Imin}} = 2.7$ V, $V_{\text{Imax}} = 5.5$ V:

$$\text{Line regulation (mV)} = (\%/V) \times \frac{V_O(V_{\text{Imax}} - 2.7 \text{ V})}{100} \times 1000$$

If $V_O > 2.5$ V then $V_{\text{Imin}} = V_O + 1$ V, $V_{\text{Imax}} = 5.5$ V.

- IN voltage equals $V_O(\text{typ}) - 100$ mV

TYPICAL CHARACTERISTICS

OUTPUT VOLTAGE
vs
LOAD CURRENT

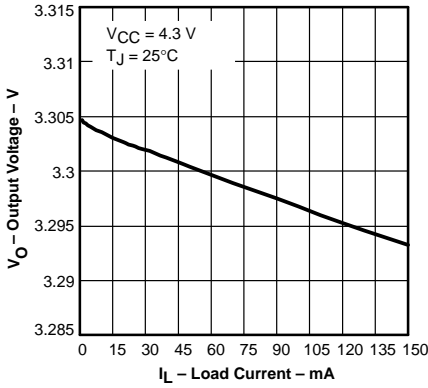

Figure 1

OUTPUT VOLTAGE
vs
FREE-AIR TEMPERATURE

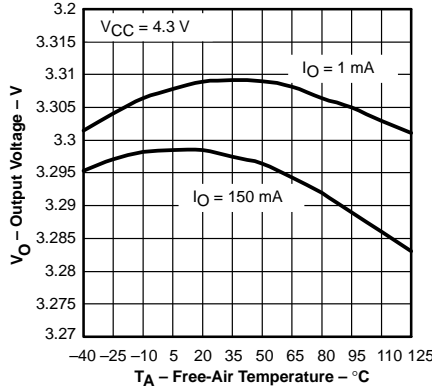

Figure 2

QUIESCENT CURRENT
vs
FREE-AIR TEMPERATURE

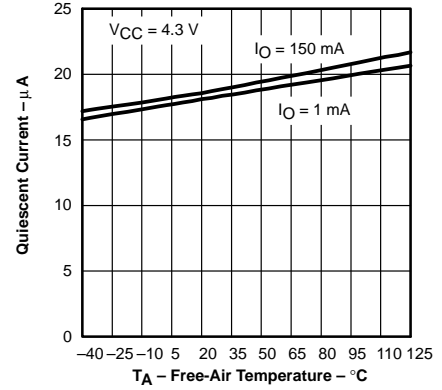

Figure 3

OUTPUT SPECTRAL NOISE DENSITY
vs
FREQUENCY

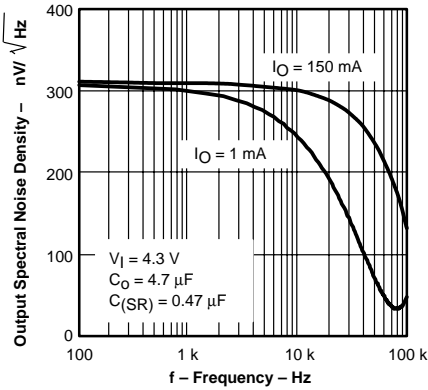

Figure 4

ROOT MEAN SQUARED OUTPUT NOISE
vs
SLEW RATE CAPACITANCE

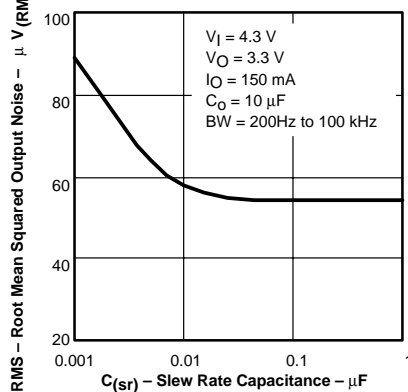

Figure 5

OUTPUT IMPEDANCE
vs
FREQUENCY

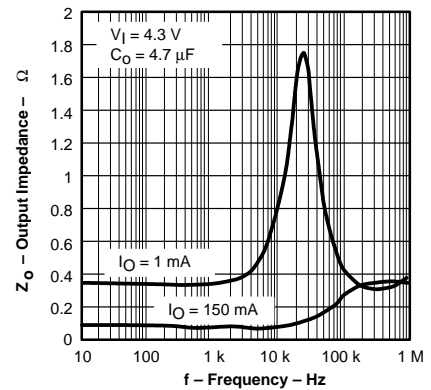

Figure 6

DROPOUT VOLTAGE
vs
FREE-AIR TEMPERATURE

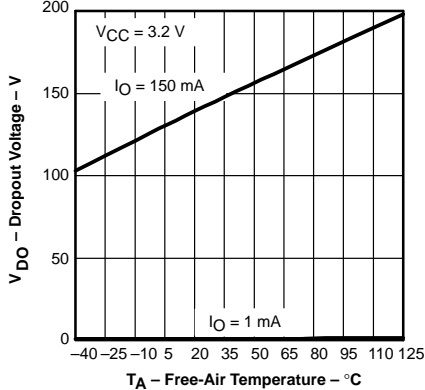

Figure 7

RIPPLE REJECTION
vs
FREQUENCY

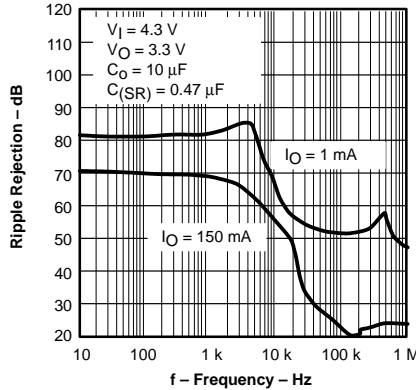

Figure 8

OUTPUT VOLTAGE, ENABLE VOLTAGE
vs
TIME (START-UP)

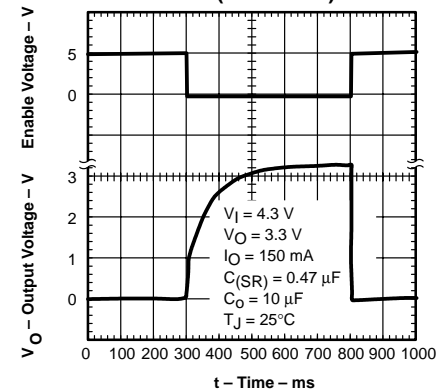

Figure 9

TYPICAL CHARACTERISTICS

OUTPUT VOLTAGE, ENABLE VOLTAGE
vs
TIME (START-UP)

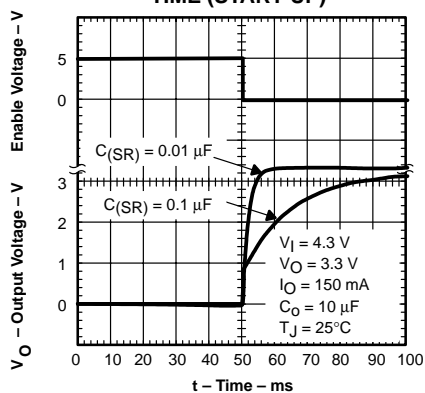

Figure 10

LINE TRANSIENT RESPONSE

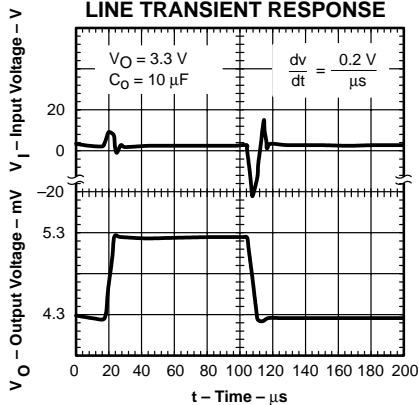

Figure 11

LOAD TRANSIENT RESPONSE



Figure 12

TYPICAL REGIONS OF STABILITY
EQUIVALENT SERIES RESISTANCE (ESR)
vs

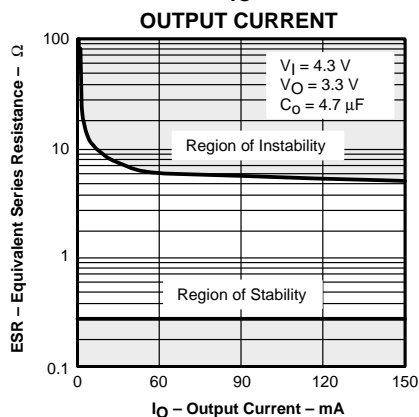

Figure 13

TYPICAL REGIONS OF STABILITY
EQUIVALENT SERIES RESISTANCE (ESR)
vs

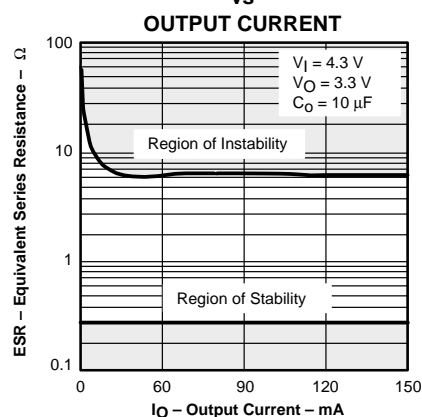

Figure 14

APPLICATION INFORMATION

The TPS788xx family of low-dropout (LDO) regulators has been optimized for use in battery-operated equipment. It features extremely low dropout voltages, low output noise, low quiescent current (17 μ A typically), and enable inputs to reduce supply currents to 1 μ A when the regulator is turned off. A typical application circuit is shown in Figure 15.

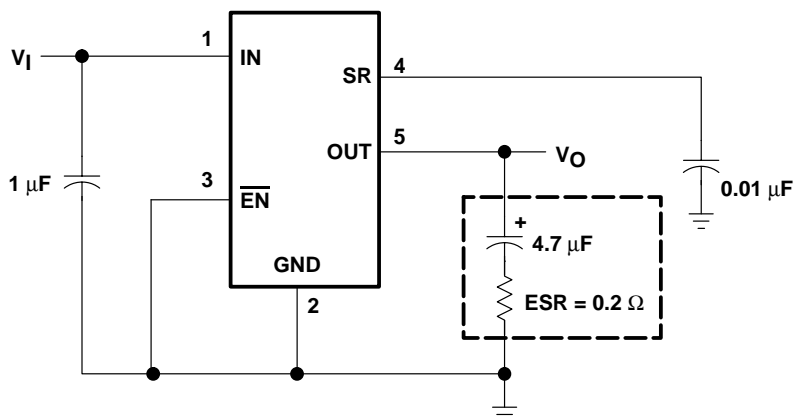

Figure 15. Typical Application Circuit

external capacitor requirements

Although not required, a 0.047- μ F or larger ceramic input bypass capacitor, connected between IN and GND and located close to the TPS788xx, is recommended to improve transient response and noise rejection. A higher-value electrolytic input capacitor may be necessary if large, fast-rise-time load transients are anticipated and the device is located several inches from the power source.

Like all low dropout regulators, the TPS788xx requires an output capacitor connected between OUT and GND to stabilize the internal control loop. The minimum recommended capacitance is 4.7 μ F. The ESR (equivalent series resistance) of the capacitor should be between 0.2 Ω and 10 Ω . to ensure stability. Capacitor values larger than 4.7 μ F are acceptable, and allow the use of smaller ESR values. Capacitances less than 4.7 μ F are not recommended because they require careful selection of ESR to ensure stability. Solid tantalum electrolytic, aluminum electrolytic, and multilayer ceramic capacitors are all suitable, provided they meet the requirements described above. Most of the commercially available 4.7 μ F surface-mount solid tantalum capacitors, including devices from Sprague, Kemet, and Nichico, meet the ESR requirements stated above. Multilayer ceramic capacitors may have very small equivalent series resistances and may thus require the addition of a low value series resistor to ensure stability.

CAPACITOR SELECTION

PART NO.	MFR.	VALUE	MAX ESR†	SIZE (H × L × W)†
T494B475K016AS	Kemet	4.7 μ F	1.5 Ω	1.9 × 3.5 × 2.8
195D106x0016x2T	Sprague	10 μ F	1.5 Ω	1.3 × 7.0 × 2.7
695D106x003562T	Sprague	10 μ F	1.3 Ω	2.5 × 7.6 × 2.5
TPSC475K035R0600	AVX	4.7 μ F	0.6 Ω	2.6 × 6.0 × 3.2

† Size is in mm. The ESR maximum resistance is in Ohms at 100 kHz and $T_A = 25^\circ\text{C}$. Contact the manufacturer for the minimum ESR values.

APPLICATION INFORMATION

external capacitor requirements (continued)

The external bypass capacitor, used in conjunction with an internal resistor to form a low-pass filter, should be a low ESR ceramic capacitor. For example, the TPS78833 exhibits only $56 \mu\text{V}_{\text{RMS}}$ of output voltage noise using a $0.01 \mu\text{F}$ ceramic bypass capacitor and a $10\text{-}\mu\text{F}$ ceramic output capacitor. Note that the output will start up slower as the bypass capacitance increases due to the RC time constant at the bypass pin that is created by the internal $150\text{-k}\Omega$ resistor and external capacitor.

power dissipation and junction temperature

Specified regulator operation is assured to a junction temperature of 125°C ; the maximum junction temperature should be restricted to 125°C under normal operating conditions. This restriction limits the power dissipation the regulator can handle in any given application. To ensure the junction temperature is within acceptable limits, calculate the maximum allowable dissipation, $P_{\text{D(max)}}$, and the actual dissipation, P_{D} , which must be less than or equal to $P_{\text{D(max)}}$.

The maximum-power-dissipation limit is determined using the following equation:

$$P_{\text{D(max)}} = \frac{T_{\text{Jmax}} - T_{\text{A}}}{R_{\theta\text{JA}}}$$

Where:

T_{Jmax} is the maximum allowable junction temperature.

$R_{\theta\text{JA}}$ is the thermal resistance junction-to-ambient for the package, see the dissipation rating table.

T_{A} is the ambient temperature.

The regulator dissipation is calculated using:

$$P_{\text{D}} = (V_{\text{I}} - V_{\text{O}}) \times I_{\text{O}}$$

Power dissipation resulting from quiescent current is negligible. Excessive power dissipation will trigger the thermal protection circuit.

regulator protection

The TPS788xx PMOS-pass transistor has a built-in back diode that conducts reverse current when the input voltage drops below the output voltage (e.g., during power down). Current is conducted from the output to the input and is not internally limited. If extended reverse voltage operation is anticipated, external limiting might be appropriate.

The TPS788xx features internal current limiting and thermal protection. During normal operation, the TPS78833 limits output current to approximately 350 mA . When current limiting engages, the output voltage scales back linearly until the overcurrent condition ends. While current limiting is designed to prevent gross device failure, care should be taken not to exceed the power dissipation ratings of the package. If the temperature of the device exceeds approximately 165°C , thermal-protection circuitry shuts it down. Once the device has cooled down to below approximately 140°C , regulator operation resumes.

PACKAGING INFORMATION

Orderable part number	Status (1)	Material type (2)	Package Pins	Package qty Carrier	RoHS (3)	Lead finish/ Ball material (4)	MSL rating/ Peak reflow (5)	Op temp (°C)	Part marking (6)
TPS78825DBVR	Active	Production	SOT-23 (DBV) 5	3000 LARGE T&R	Yes	NIPDAU	Level-1-260C-UNLIM	0 to 70	PGZI
TPS78825DBVR.A	Active	Production	SOT-23 (DBV) 5	3000 LARGE T&R	Yes	NIPDAU	Level-1-260C-UNLIM	0 to 70	PGZI
TPS78825DBVT	Active	Production	SOT-23 (DBV) 5	250 SMALL T&R	Yes	NIPDAU	Level-1-260C-UNLIM	0 to 70	PGZI
TPS78825DBVT.A	Active	Production	SOT-23 (DBV) 5	250 SMALL T&R	Yes	NIPDAU	Level-1-260C-UNLIM	0 to 70	PGZI
TPS78833DBVR	NRND	Production	SOT-23 (DBV) 5	3000 LARGE T&R	Yes	NIPDAU SN	Level-1-260C-UNLIM	0 to 70	PGTI
TPS78833DBVR.A	NRND	Production	SOT-23 (DBV) 5	3000 LARGE T&R	Yes	NIPDAU	Level-1-260C-UNLIM	0 to 70	PGTI
TPS78833DBVT	Active	Production	SOT-23 (DBV) 5	250 SMALL T&R	Yes	NIPDAU SN	Level-1-260C-UNLIM	0 to 70	PGTI
TPS78833DBVT.A	Active	Production	SOT-23 (DBV) 5	250 SMALL T&R	Yes	SN	Level-1-260C-UNLIM	0 to 70	PGTI

(1) **Status:** For more details on status, see our [product life cycle](#).

(2) **Material type:** When designated, preproduction parts are prototypes/experimental devices, and are not yet approved or released for full production. Testing and final process, including without limitation quality assurance, reliability performance testing, and/or process qualification, may not yet be complete, and this item is subject to further changes or possible discontinuation. If available for ordering, purchases will be subject to an additional waiver at checkout, and are intended for early internal evaluation purposes only. These items are sold without warranties of any kind.

(3) **RoHS values:** Yes, No, RoHS Exempt. See the [TI RoHS Statement](#) for additional information and value definition.

(4) **Lead finish/Ball material:** Parts may have multiple material finish options. Finish options are separated by a vertical ruled line. Lead finish/Ball material values may wrap to two lines if the finish value exceeds the maximum column width.

(5) **MSL rating/Peak reflow:** The moisture sensitivity level ratings and peak solder (reflow) temperatures. In the event that a part has multiple moisture sensitivity ratings, only the lowest level per JEDEC standards is shown. Refer to the shipping label for the actual reflow temperature that will be used to mount the part to the printed circuit board.

(6) **Part marking:** There may be an additional marking, which relates to the logo, the lot trace code information, or the environmental category of the part.

Multiple part markings will be inside parentheses. Only one part marking contained in parentheses and separated by a "-" will appear on a part. If a line is indented then it is a continuation of the previous line and the two combined represent the entire part marking for that device.

Important Information and Disclaimer: The information provided on this page represents TI's knowledge and belief as of the date that it is provided. TI bases its knowledge and belief on information provided by third parties, and makes no representation or warranty as to the accuracy of such information. Efforts are underway to better integrate information from third parties. TI has taken and continues to take reasonable steps to provide representative and accurate information but may not have conducted destructive testing or chemical analysis on incoming materials and chemicals. TI and TI suppliers consider certain information to be proprietary, and thus CAS numbers and other limited information may not be available for release.

In no event shall TI's liability arising out of such information exceed the total purchase price of the TI part(s) at issue in this document sold by TI to Customer on an annual basis.

TAPE AND REEL INFORMATION

QUADRANT ASSIGNMENTS FOR PIN 1 ORIENTATION IN TAPE

*All dimensions are nominal

Device	Package Type	Package Drawing	Pins	SPQ	Reel Diameter (mm)	Reel Width W1 (mm)	A0 (mm)	B0 (mm)	K0 (mm)	P1 (mm)	W (mm)	Pin1 Quadrant
TPS78825DBVR	SOT-23	DBV	5	3000	180.0	9.0	3.15	3.2	1.4	4.0	8.0	Q3
TPS78825DBVT	SOT-23	DBV	5	250	180.0	9.0	3.15	3.2	1.4	4.0	8.0	Q3
TPS78833DBVR	SOT-23	DBV	5	3000	180.0	8.4	3.2	3.2	1.4	4.0	8.0	Q3
TPS78833DBVT	SOT-23	DBV	5	250	180.0	8.4	3.2	3.2	1.4	4.0	8.0	Q3

TAPE AND REEL BOX DIMENSIONS



*All dimensions are nominal

Device	Package Type	Package Drawing	Pins	SPQ	Length (mm)	Width (mm)	Height (mm)
TPS78825DBVR	SOT-23	DBV	5	3000	182.0	182.0	20.0
TPS78825DBVT	SOT-23	DBV	5	250	182.0	182.0	20.0
TPS78833DBVR	SOT-23	DBV	5	3000	210.0	185.0	35.0
TPS78833DBVT	SOT-23	DBV	5	250	210.0	185.0	35.0

IMPORTANT NOTICE AND DISCLAIMER

TI PROVIDES TECHNICAL AND RELIABILITY DATA (INCLUDING DATASHEETS), DESIGN RESOURCES (INCLUDING REFERENCE DESIGNS), APPLICATION OR OTHER DESIGN ADVICE, WEB TOOLS, SAFETY INFORMATION, AND OTHER RESOURCES "AS IS" AND WITH ALL FAULTS, AND DISCLAIMS ALL WARRANTIES, EXPRESS AND IMPLIED, INCLUDING WITHOUT LIMITATION ANY IMPLIED WARRANTIES OF MERCHANTABILITY, FITNESS FOR A PARTICULAR PURPOSE OR NON-INFRINGEMENT OF THIRD PARTY INTELLECTUAL PROPERTY RIGHTS.

These resources are intended for skilled developers designing with TI products. You are solely responsible for (1) selecting the appropriate TI products for your application, (2) designing, validating and testing your application, and (3) ensuring your application meets applicable standards, and any other safety, security, regulatory or other requirements.

These resources are subject to change without notice. TI grants you permission to use these resources only for development of an application that uses the TI products described in the resource. Other reproduction and display of these resources is prohibited. No license is granted to any other TI intellectual property right or to any third party intellectual property right. TI disclaims responsibility for, and you fully indemnify TI and its representatives against any claims, damages, costs, losses, and liabilities arising out of your use of these resources.

TI's products are provided subject to [TI's Terms of Sale](#), [TI's General Quality Guidelines](#), or other applicable terms available either on [ti.com](#) or provided in conjunction with such TI products. TI's provision of these resources does not expand or otherwise alter TI's applicable warranties or warranty disclaimers for TI products. Unless TI explicitly designates a product as custom or customer-specified, TI products are standard, catalog, general purpose devices.

TI objects to and rejects any additional or different terms you may propose.

Copyright © 2026, Texas Instruments Incorporated

Last updated 10/2025