

TPS7B4259-Q1 Automotive, 150mA, 40V, Voltage Tracking LDO With PG

1 Features

- AEC-Q100 qualified for automotive applications:
 - Temperature grade 1: -40°C to $+125^{\circ}\text{C}$, T_A
 - Junction temperature: -40°C to $+150^{\circ}\text{C}$, T_J
- Wide input voltage range:
 - Absolute maximum range: -40V to 45V
 - Operating range: 3.3V to 40V
- Wide output voltage range: 2V to 40V
- Maximum output current: 150mA
- Very tight output-tracking tolerance: 6mV (max)
- Low dropout voltage: 250mV at 150mA
- Independent enable pin functionality
- Power-good functionality detects under- and overvoltage conditions
- Low quiescent current at light load: $55\mu\text{A}$
- Stable over a wide range of ceramic output capacitor values:
 - C_{OUT} range: $1\mu\text{F}$ to $100\mu\text{F}$
 - ESR range: $1\text{m}\Omega$ to 2Ω
- Integrated protection features:
 - Reverse current protection
 - Reverse polarity protection
 - Overtemperature protection
 - Protection against output short circuit to ground and supply
- Available in a low thermal resistance, 8-pin package:
 - HSOIC (DDA), $R_{\theta\text{JA}} = 48^{\circ}\text{C}/\text{W}$

2 Applications

- [Powertrain pressure sensors](#)
- [Powertrain temperature sensors](#)
- [Powertrain exhaust sensors](#)
- [Powertrain fluid concentration sensors](#)
- [Body control modules \(BCM\)](#)
- [Zone control modules \(ZCM\)](#)
- [HVAC control modules](#)

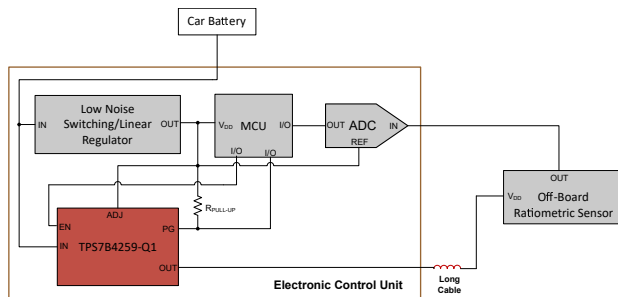

Typical Application

3 Description

The TPS7B4259-Q1 is a monolithic, integrated low-dropout voltage tracker. The device is available in an 8-pin HSOIC package. The TPS7B4259-Q1 is designed to reliably provide power to off-board sensors with a wire harness, even in harsh automotive environments. In such severe operating conditions, the cables in the harness are potentially exposed to various fault conditions, increasing the risk of failure. Such conditions include short to ground, short to battery, and overtemperature. The TPS7B4259-Q1 comes with integrated protection features against each of these fault conditions, as well as protection against reverse polarity. The device incorporates a topology containing two back-to-back P-channel metal-oxide semiconductor field-effect transistors (MOSFETs). This PMOS topology eliminates the need for an external diode that is otherwise required to prevent the flow of reverse current. The high 150mA current rating of the device potentially allows a single tracker to power multiple off-board sensors simultaneously. The device is designed to handle a 45V (absolute maximum) input voltage and survive the automotive load dump transient conditions.

The TPS7B4259-Q1 features an independent enable pin (EN) and power-good functionality that detects both under- and overvoltage fault conditions. By setting the EN input pin low, the TPS7B4259-Q1 switches to standby mode. In this mode the quiescent current consumption of the LDO is less than $3.8\mu\text{A}$ (max).

Package Information

| PART NUMBER | PACKAGE ⁽¹⁾ | PACKAGE SIZE ⁽²⁾ |
|--------------|------------------------|-----------------------------|
| TPS7B4259-Q1 | DDA (HSOIC, 8) | 6mm × 4.9mm |

- (1) For more information, see the [Mechanical, Packaging, and Orderable Information](#).
- (2) The package size (length × width) is a nominal value and includes pins, where applicable.



The TPS7B4259-Q1 provides a protective buffer to the ADC and microcontroller (MCU) against fault conditions, while securely transferring power to the off-board sensors. A reference voltage applied at the adjustable input pin (ADJ) is tracked with a very tight 6mV (max) tolerance at the OUT pin. This tolerance holds true for all variations across the specified line, load, and temperature values. For ratiometric sensors whose output is sampled by the ADC, this tight tracking tolerance is particularly beneficial. This tolerance verifies the error between the ADC full-scale reference and the sensor power supply voltage is minimal. The ratiometricity of the sensor measurement is thereby maintained.

If the ADC full-scale reference voltage equals the sensor supply voltage, connect the reference voltage directly to the ADJ pin. If the sensor supply is lower than the reference, use a resistive divider at the ADJ pin. This divider helps scale down the reference voltage (to a minimum of 2V) to match the sensor supply voltage.

Table of Contents

| | | | |
|--|----|--|----|
| 1 Features | 1 | 7 Application and Implementation | 20 |
| 2 Applications | 1 | 7.1 Application Information..... | 20 |
| 3 Description | 1 | 7.2 Typical Application..... | 21 |
| 4 Pin Configuration and Functions | 4 | 7.3 Power Supply Recommendations..... | 23 |
| 5 Specifications | 5 | 7.4 Layout..... | 24 |
| 5.1 Absolute Maximum Ratings..... | 5 | 8 Device and Documentation Support | 27 |
| 5.2 ESD Ratings..... | 5 | 8.1 Device Support..... | 27 |
| 5.3 Recommended Operating Conditions..... | 5 | 8.2 Documentation Support..... | 27 |
| 5.4 Thermal Information..... | 6 | 8.3 Receiving Notification of Documentation Updates.... | 27 |
| 5.5 Electrical Characteristics..... | 6 | 8.4 Support Resources..... | 27 |
| 5.6 Typical Characteristics..... | 8 | 8.5 Trademarks..... | 27 |
| 6 Detailed Description | 14 | 8.6 Electrostatic Discharge Caution..... | 27 |
| 6.1 Overview..... | 14 | 8.7 Glossary..... | 27 |
| 6.2 Functional Block Diagram..... | 14 | 9 Revision History | 27 |
| 6.3 Feature Description..... | 14 | 10 Mechanical, Packaging, and Orderable Information | 28 |
| 6.4 Device Functional Modes..... | 19 | | |

4 Pin Configuration and Functions

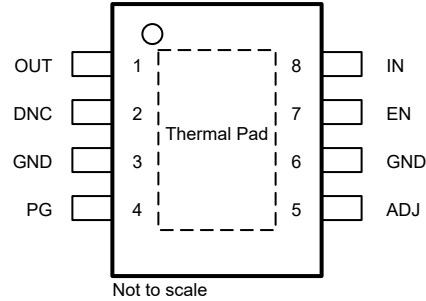

Figure 4-1. DDA Package, 8-Pin HSOIC (Top View)

Table 4-1. Pin Functions

| PIN | | TYPE | DESCRIPTION |
|-------------|------|------|--|
| NAME | DDA | | |
| ADJ | 5 | I | Adjustable input pin. Connect the external reference voltage to this pin, either directly or with a voltage divider for lower output voltages. This pin connects to the inverting input of the error amplifier internally. To compensate for line influences, place a 0.1µF capacitor close to this pin. |
| DNC | 2 | — | Do not connect a voltage source to this pin. Leave this pin floating or connect to GND to improve thermal performance. |
| EN | 7 | I | Enable pin. A low signal below V_{IL} disables the device, and a high signal above V_{IH} enables the device. Do not leave this pin floating. |
| GND | 3, 6 | G | GND pin. Connect this pin to a low impedance path to ground. |
| IN | 8 | I | Input power-supply voltage pin. For best transient response and to minimize input impedance, use the recommended value or larger ceramic capacitor from IN to GND. See the Recommended Operating Conditions table. Place the input capacitor as close to the input pin of the device as possible to compensate for line influences. See the Input and Output Capacitor Selection section for more details. |
| OUT | 1 | O | Regulated output voltage pin. A capacitor is required from OUT to GND for stability. Select a ceramic capacitor within the range of C_{OUT} values provided in the Recommended Operating Conditions table. Place this capacitor as close to output of the device as possible. See the Input and Output Capacitor Selection section for more details. |
| PG | 4 | O | Active-high, open-drain based power-good pin. Connect this pin to a positive voltage via a pullup resistor. After the device start-up sequence is completed, the voltage level on this pin helps assess if V_{OUT} is abnormal or within the expected range. A logic low level indicates that V_{OUT} has either fallen below or has exceeded the nominal value by the under- or overvoltage threshold, respectively. This feature helps identify possible fault conditions on the tracker output. V_{OUT} is the tracker output voltage. See the Power Good section for more details. |
| Thermal Pad | — | | Thermal pad. Connect the pad to GND for best possible thermal performance. |

5 Specifications

5.1 Absolute Maximum Ratings

over operating free-air temperature range (unless otherwise noted)⁽¹⁾

| | | MIN | MAX | UNIT |
|------------------------------------|--|------|-----|------|
| V _{IN} | Unregulated input pin voltage | -40 | 45 | V |
| V _{OUT} | Regulated output pin voltage | -5 | 45 | V |
| V _{IN} - V _{OUT} | Input-output differential | -45 | 45 | V |
| V _{EN} | Enable pin voltage | -40 | 45 | V |
| V _{PG} | Power-good pin voltage | -0.3 | 45 | V |
| V _{ADJ} | Adjustable reference input pin voltage | -40 | 45 | V |
| T _J | Operating junction temperature | -40 | 150 | °C |
| T _{stg} | Storage temperature | -65 | 150 | °C |

- (1) Operation outside the Absolute Maximum Ratings may cause permanent device damage. Absolute Maximum Ratings do not imply functional operation of the device at these or any other conditions beyond those listed under Recommended Operating Conditions. If used outside the Recommended Operating Conditions but within the Absolute Maximum Ratings, the device may not be fully functional, and this may effect the device reliability, functionality, performance, and shorten the device lifetime.

5.2 ESD Ratings

| | | | VALUE | UNIT | |
|--------------------|-------------------------|---|-------------|------|-------|
| V _(ESD) | Electrostatic discharge | Human-body model (HBM), per AEC Q100-002 ⁽¹⁾ | ±2500 | V | |
| | | Charged-device model (CDM), per AEC Q100-011 | All pins | | ±1000 |
| | | | Corner pins | | |

- (1) AEC Q100-002 indicates that HBM stressing shall be in accordance with the ANSI/ESDA/JEDEC JS-001 specification.

5.3 Recommended Operating Conditions

over operating free-air temperature range (unless otherwise noted)

| | | MIN | TYP | MAX | UNIT |
|------------------|-----------------------------------|-------|-----|-----|------|
| V _{IN} | Input voltage | 3.3 | | 40 | V |
| V _{OUT} | Output voltage | 2 | | 40 | V |
| I _{OUT} | Output current | 0 | | 150 | mA |
| V _{EN} | Enable pin voltage | 0 | | 40 | V |
| V _{ADJ} | Adjustable reference pin voltage | 2 | | 40 | V |
| V _{PG} | Power-good pin voltage | 0 | | 40 | V |
| C _{IN} | Input capacitor ⁽¹⁾ | | 1 | | µF |
| C _{OUT} | Output capacitor ⁽²⁾ | 1 | | 100 | µF |
| ESR | Output capacitor ESR requirements | 0.001 | | 2 | Ω |
| T _J | Operating junction temperature | -40 | | 150 | °C |

- (1) For robust EMI performance the minimum input capacitance recommended is 500nF.
(2) Effective output capacitance of 500nF minimum is required for stability.

5.4 Thermal Information

| THERMAL METRIC ^{(1) (2)} | | TPS7B4259-Q1 | |
|-----------------------------------|--|--------------|------|
| | | DDA (HSOIC) | UNIT |
| | | 8 PINS | |
| R _{θJA} | Junction-to-ambient thermal resistance | 48 | °C/W |
| R _{θJCTop} | Junction-to-case (top) thermal resistance | 71.6 | °C/W |
| R _{θJB} | Junction-to-board thermal resistance | 23.5 | °C/W |
| ψ _{JT} | Junction-to-top characterization parameter | 9.3 | °C/W |
| ψ _{JB} | Junction-to-board characterization parameter | 23.3 | °C/W |
| R _{θJCbott} | Junction-to-case (bottom) thermal resistance | 11.5 | °C/W |

- The thermal data is based on the JEDEC standard high-K board layout, JESD 51-7. This board is a two-signal, two-plane, four-layer board with 2-oz. copper on the external layers. The copper pad is soldered to the thermal land pattern. Incorporate correct attachment procedure.
- For more information about traditional and new thermal metrics, see the [Semiconductor and IC Package Thermal Metrics](#) application note.

5.5 Electrical Characteristics

specified at T_J = –40°C to +150°C, V_{IN} = 13.5V, I_{OUT} = 100μA, C_{OUT} = 1μF, C_{IN} = 1μF, V_{EN} = 2V and V_{ADJ} = 5V (unless otherwise noted); typical values are at T_J = 25°C

| PARAMETER | | TEST CONDITIONS | MIN | TYP | MAX | UNIT |
|-----------------------------|--|---|------|-----|------|-------------------|
| I _Q | Quiescent current | V _{IN} = 5.4V to 40V, I _{OUT} = 100μA, T _J = 25°C | | | 75 | μA |
| | | V _{IN} = 5.4V to 40V, I _{OUT} = 100μA, –40°C < T _J < 85°C | | | 80 | |
| | | V _{IN} = 5.4V to 40V, I _{OUT} = 100μA | | | 85 | |
| I _{GND} | Ground current | V _{IN} = 5.8V to 40V, I _{OUT} = 150mA | | | 2 | mA |
| I _{SHUTDOWN} | Shutdown supply current | V _{EN} = 0V | | | 3.8 | μA |
| I _{ADJ} | ADJ pin current | I _{OUT} = 100μA | | | 0.9 | μA |
| V _{UVLO (RISING)} | Rising input supply UVLO | V _{IN} rising, I _{OUT} = 5mA | 2.6 | 2.7 | 2.85 | V |
| V _{UVLO (FALLING)} | Falling input supply UVLO | V _{IN} falling, I _{OUT} = 5mA | 2.3 | 2.4 | 2.5 | V |
| V _{UVLO (HYST)} | V _{UVLO(IN)} hysteresis | | | 300 | | mV |
| ΔV _{OUT} | Output voltage tracking accuracy | V _{IN} = V _{OUT} + 0.8V to 40V, I _{OUT} = 100μA to 150mA ⁽¹⁾ | –6 | | 6 | mV |
| ΔV _{OUT (ΔVIN)} | Line regulation | V _{IN} = V _{OUT} + 0.8V to 40V, I _{OUT} = 100μA | –0.4 | | 0.4 | mV |
| ΔV _{OUT (ΔIOUT)} | Load regulation | V _{IN} = V _{OUT} + 0.8V, I _{OUT} = 100μA to 150mA ⁽¹⁾ | | | 1 | mV |
| V _{DO} | Dropout voltage | I _{OUT} = 150mA, V _{ADJ} ≥ 3.3V, V _{IN} = V _{ADJ} | | 250 | 470 | mV |
| I _{CL} | Output current limit | V _{IN} = V _{OUT} + 1.2V, V _{OUT} short to 90% × V _{ADJ} | 170 | 215 | 250 | mA |
| V _{PG UV-TH} | Power-good undervoltage threshold, V _{ADJ} - V _{OUT} | V _{OUT} decreasing, V _{IN} = V _{ADJ} = 5V, V _{IN} reducing | 40 | 80 | 120 | mV |
| V _{PG OV-TH} | Power-good overvoltage threshold, V _{OUT} - V _{ADJ} | V _{OUT} increasing, V _{IN} ≥ V _{ADJ/REF} + 0.5V | 40 | 80 | 120 | mV |
| V _{PG-HYST} | Power-good hysteresis | | | 25 | | mV |
| t _{PG} | Power-good reaction time | | 20 | 50 | 80 | μS |
| V _{PG, LOW} | Power-good output low voltage | I _{PG} = 1.8mA | | | 0.4 | V |
| I _{PG, LEAKAGE} | Power-good pin leakage current | V _{PG} = 5V | | | 0.25 | μA |
| V _{EN, OFF} | Device disable voltage range | | | | 0.8 | V |
| V _{EN, ON} | Device enable voltage range | | 1.8 | | | V |
| I _{EN} | Enable pin leakage current | V _{EN} = 5V | | | 1 | μA |
| PSRR | Power-supply ripple rejection | V _{RIPPLE} = 1V _{PP} , frequency = 100Hz, I _{OUT} ≥ 5mA | | 80 | | dB |
| V _n | Output noise voltage | V _{OUT} = 3.3V, I _{OUT} = 1mA, BW = 10Hz to 100KHz, a 5μV _{RMS} reference is used for this measurement | | 150 | | μV _{RMS} |
| I _{REV} | Reverse current at V _{IN} | V _{IN} = 0V, V _{OUT} = 32V | –0.7 | | 0.7 | μA |
| I _{REV-N1} | Reverse current at negative V _{IN} | V _{IN} = –20V, V _{OUT} = 20V | –1.2 | | 1.2 | μA |

5.5 Electrical Characteristics (continued)

specified at $T_J = -40^{\circ}\text{C}$ to $+150^{\circ}\text{C}$, $V_{IN} = 13.5\text{V}$, $I_{OUT} = 100\mu\text{A}$, $C_{OUT} = 1\mu\text{F}$, $C_{IN} = 1\mu\text{F}$, $V_{EN} = 2\text{V}$ and $V_{ADJ} = 5\text{V}$ (unless otherwise noted); typical values are at $T_J = 25^{\circ}\text{C}$

| PARAMETER | | TEST CONDITIONS | MIN | TYP | MAX | UNIT |
|--------------------|--------------------------------|-----------------|-----|-----|-----|--------------------|
| $T_{SD(SHUTDOWN)}$ | Junction shutdown temperature | | | 175 | | $^{\circ}\text{C}$ |
| $T_{SD(HYST)}$ | Hysteresis of thermal shutdown | | | 15 | | $^{\circ}\text{C}$ |

- (1) Because the power dissipation is potentially large, this specification is measured using pulse testing with a low duty cycle. See the thermal information table for more information on how much power the device dissipates while maintaining a junction temperature below 150°C .

5.6 Typical Characteristics

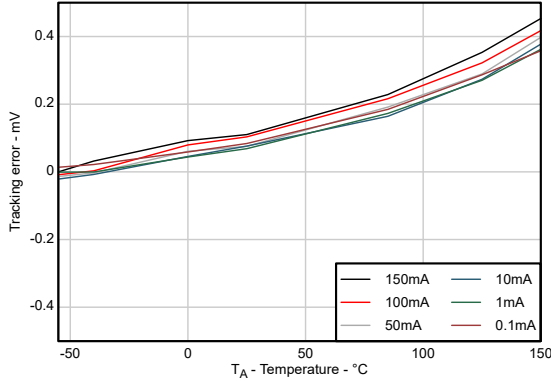

$V_{IN} = 13.5V, V_{ADJ} = 5V, V_{EN} = 2V$

Figure 5-1. Tracking Error vs Ambient Temperature

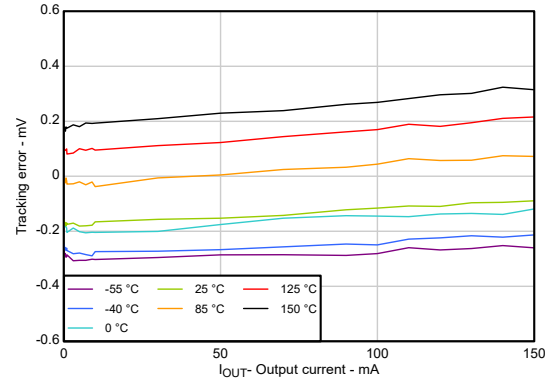

$V_{IN} = 13.5V, V_{ADJ} = 5V, V_{EN} = 2V$

Figure 5-2. Tracking Error vs Output Current

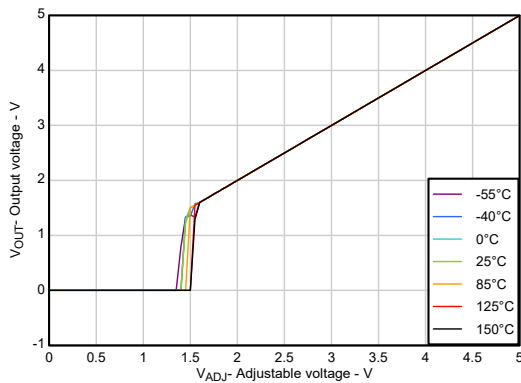

$V_{IN} = 13.5V, V_{EN} = 2V, I_{OUT} = 10mA$

Figure 5-3. Output Voltage vs Adjustable Reference Voltage

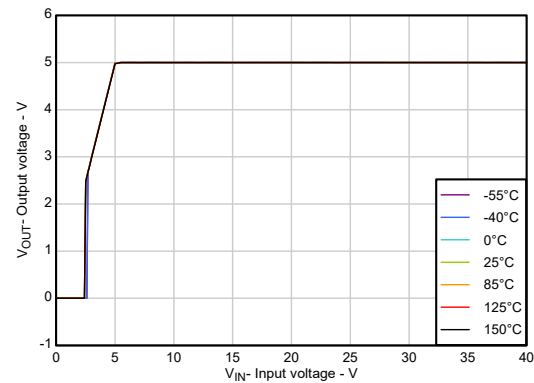

$V_{ADJ} = 5V, V_{EN} = 2V, I_{OUT} = 10mA$

Figure 5-4. Output Voltage vs Input Voltage

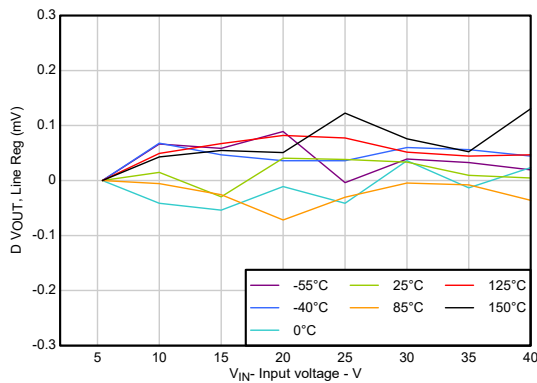

$V_{ADJ} = 5V, V_{EN} = 2V, I_{OUT} = 100\mu A$

Figure 5-5. Line Regulation

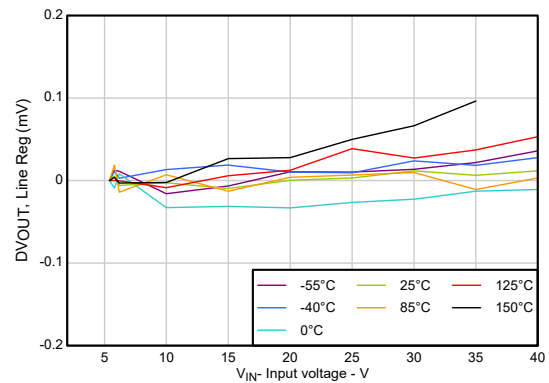

$V_{ADJ} = 5V, V_{EN} = 2V, I_{OUT} = 150mA$

Figure 5-6. Line Regulation

5.6 Typical Characteristics (continued)

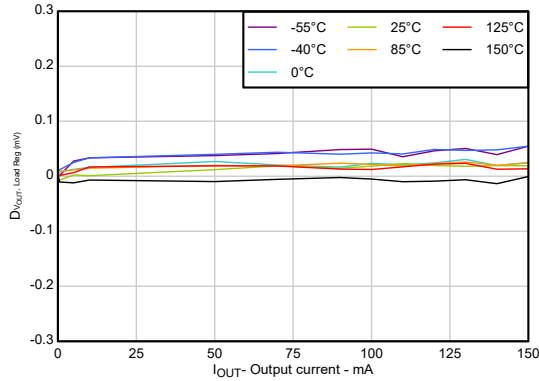

$V_{IN} = 13.5V, V_{ADJ} = 5V, V_{EN} = 2V$

Figure 5-7. Load Regulation

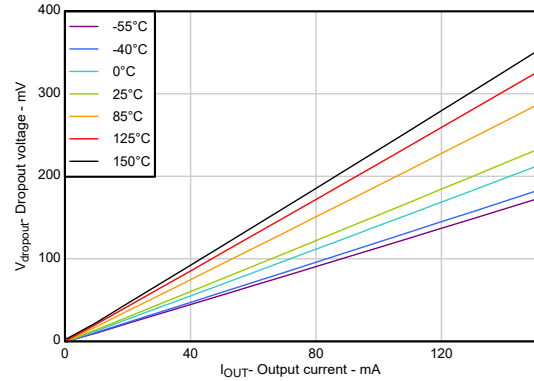

$V_{IN} = 5V, V_{ADJ} = 5V, V_{EN} = 2V$

Figure 5-8. Dropout Voltage vs Load Current

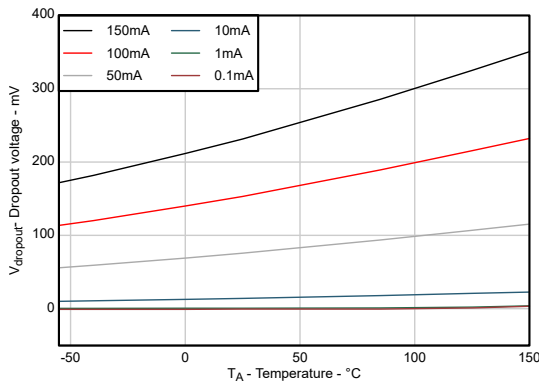

$V_{IN} = 5V, V_{ADJ} = 5V, V_{EN} = 2V$

Figure 5-9. Dropout Voltage vs Ambient Temperature

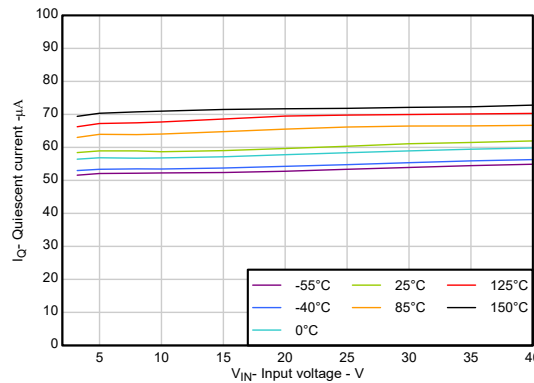

$V_{ADJ} = 2V, V_{EN} = 2V, I_{OUT} = 100\mu A$

Figure 5-10. Quiescent Current vs Input Voltage

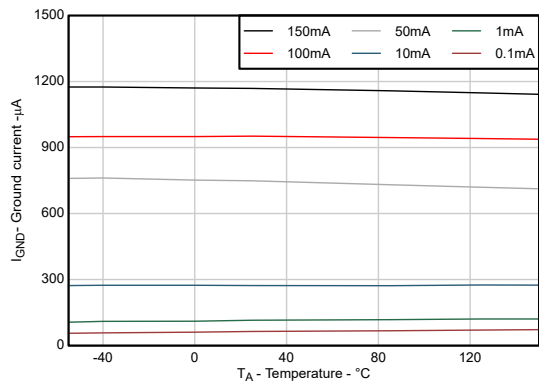

$V_{IN} = 13.5V, V_{ADJ} = 5V, V_{EN} = 2V$

Figure 5-11. Ground Current vs Ambient Temperature

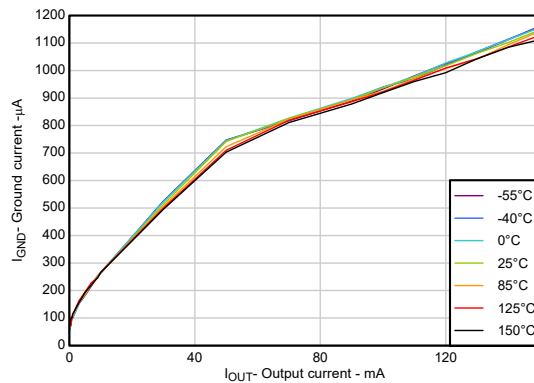

$V_{IN} = 13.5V, V_{ADJ} = 5V, V_{EN} = 2V$

Figure 5-12. Ground Current vs Output Current

5.6 Typical Characteristics (continued)

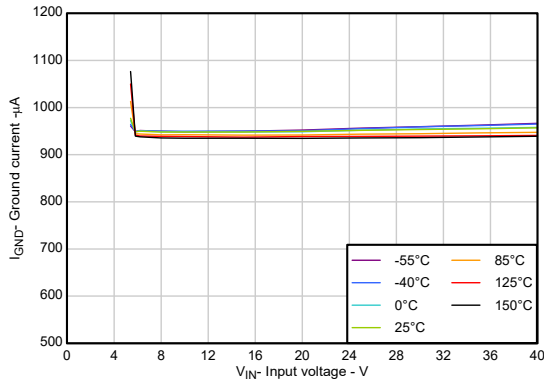

$V_{ADJ} = 5V, V_{EN} = 2V, I_{OUT} = 150mA$

Figure 5-13. Ground Current vs Input Voltage

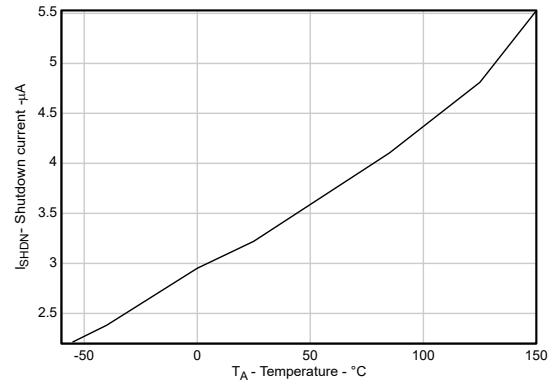

$V_{IN} = 13.5V, V_{ADJ} = 2V, V_{EN} = 0V$

Figure 5-14. Shutdown Current vs Ambient Temperature

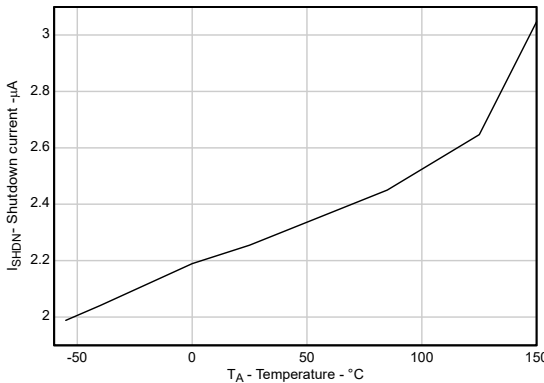

$V_{IN} = 13.5V, V_{ADJ} = 0V, V_{EN} = 2V$

Figure 5-15. Shutdown Current vs Ambient Temperature



$V_{IN} = 13.5V, V_{ADJ} = 5V, V_{EN} = 2V, V_{OUT} = 0.9 \times V_{OUT\ NOM}$

Figure 5-16. Current Limit vs Ambient Temperature

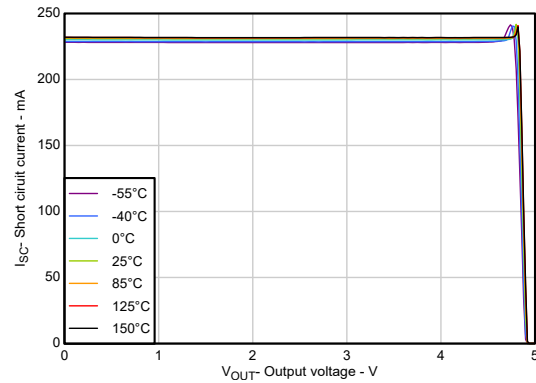

$V_{IN} = 13.5V, V_{ADJ} = 5V, V_{EN} = 2V$

Figure 5-17. Current Limit vs Output Voltage

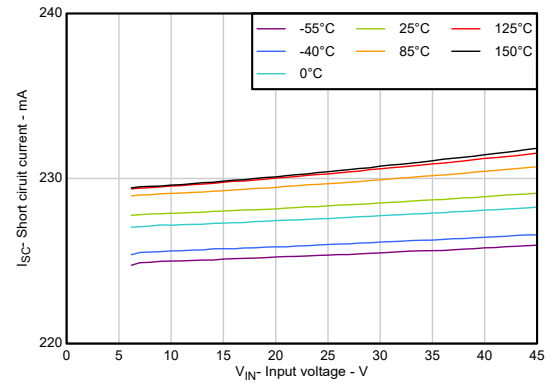

$V_{ADJ} = 5V, V_{EN} = 2V, V_{OUT} = 0.9 \times V_{OUT\ NOM}$

Figure 5-18. Current Limit vs Input Voltage

5.6 Typical Characteristics (continued)

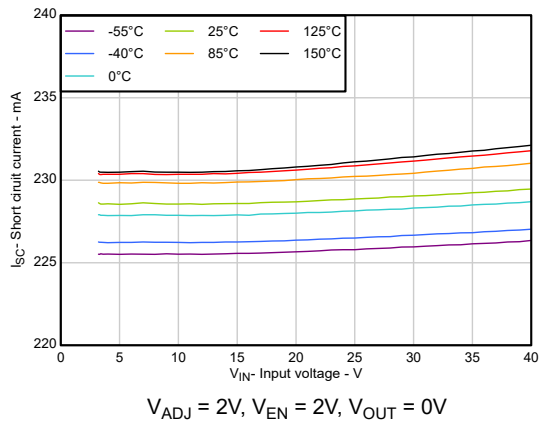

Figure 5-19. Current Limit vs Input Voltage

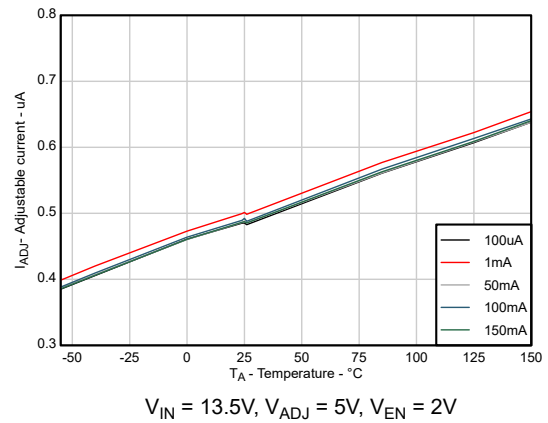

Figure 5-20. Adjustable Pin Leakage Current vs Ambient Temperature

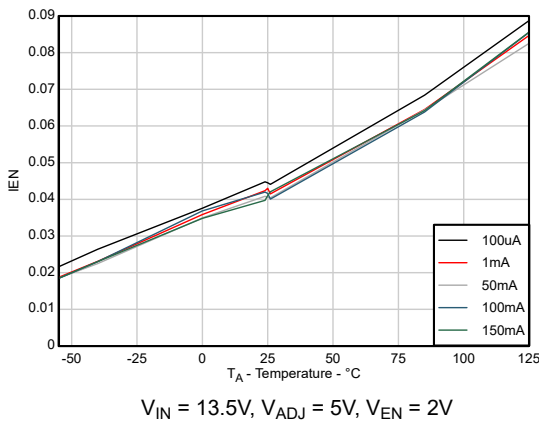

Figure 5-21. Enable Pin Leakage Current vs Ambient Temperature

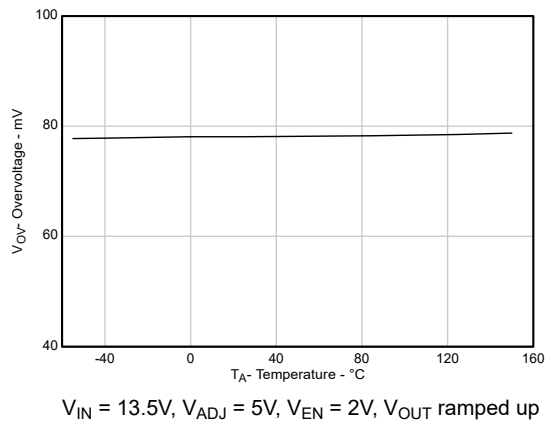

Figure 5-22. Overvoltage Trip Threshold vs Ambient Temperature

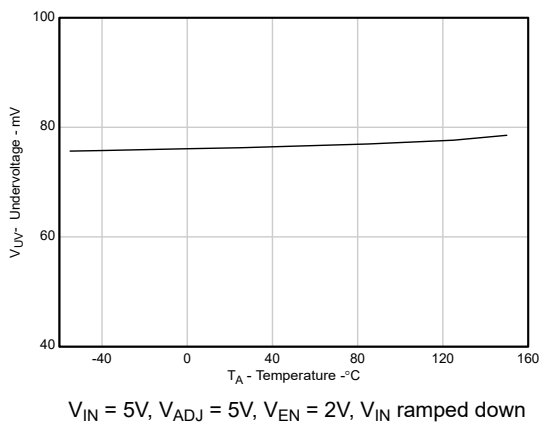

Figure 5-23. Undervoltage Trip Threshold vs Ambient Temperature

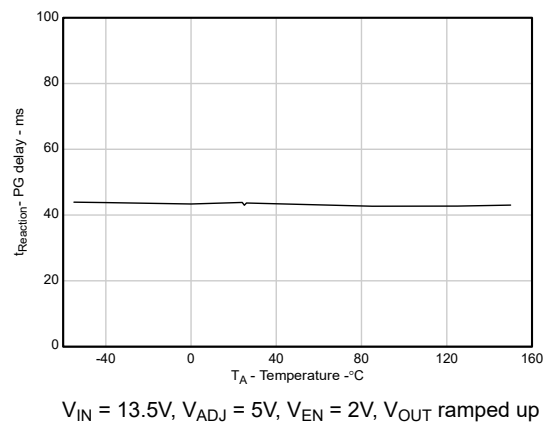
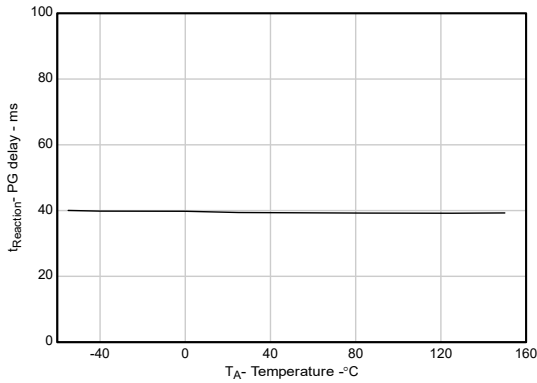

Figure 5-24. Overvoltage PG Trip Response Time vs Ambient Temperature

5.6 Typical Characteristics (continued)



$V_{IN} = 5V, V_{ADJ} = 5V, V_{EN} = 2V, V_{IN}$ ramped up

Figure 5-25. Undervoltage PG Trip Response Time vs Ambient Temperature

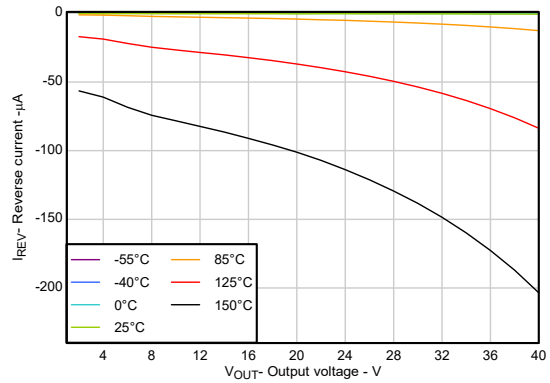

$V_{IN} = 0V, V_{ADJ} = 5V, V_{EN} = 2V$

Figure 5-26. Reverse Leakage Current vs Output Voltage

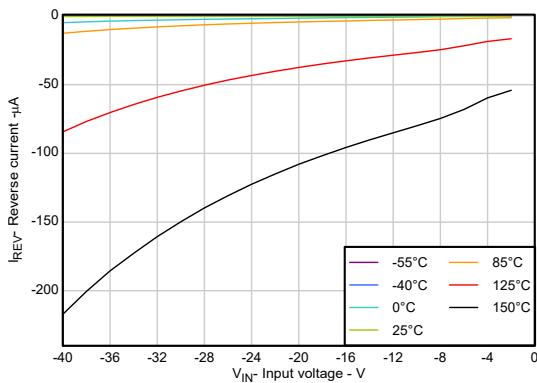

$V_{OUT} = 0V, V_{ADJ} = 5V, V_{EN} = 2V$

Figure 5-27. Reverse Leakage Current vs Input Voltage

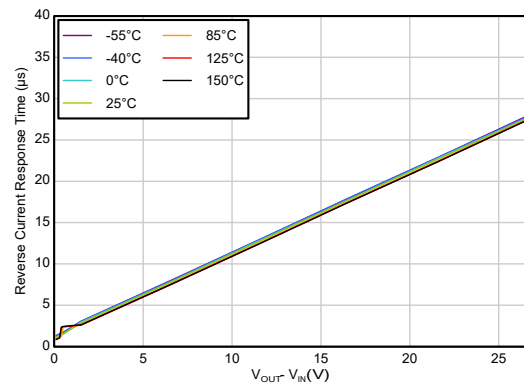

$V_{IN} = 13.5V, V_{ADJ} = 5V, V_{EN} = 2V$, simulation results

Figure 5-28. Reverse Current Protection Response Time vs Output-Input Differential Voltage

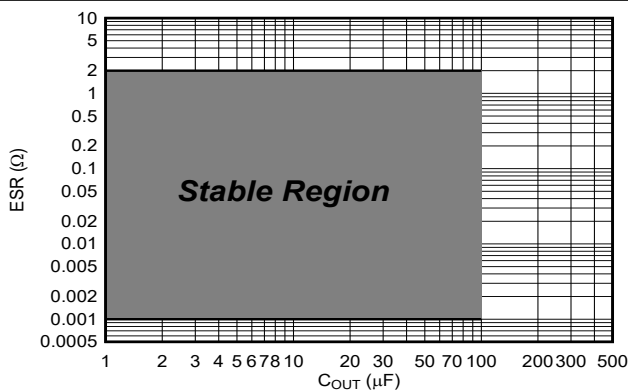

Stable region: $1m\Omega \leq ESR \leq 2\Omega, 1\mu F \leq C_{OUT} \leq 100\mu F$

Figure 5-29. ESR vs Load Capacitance

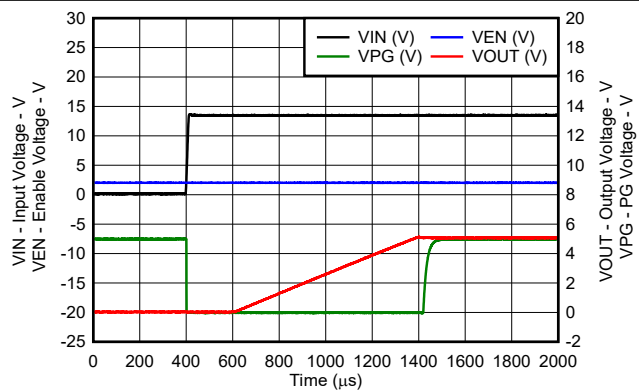

$V_{IN} = 0V$ to $13.5V$ at a rate of $1V/\mu s, V_{ADJ} = 5V, V_{EN} = 2V, C_{OUT} = 1\mu F, I_{OUT} = 150mA$

Figure 5-30. Start-Up Profile

5.6 Typical Characteristics (continued)

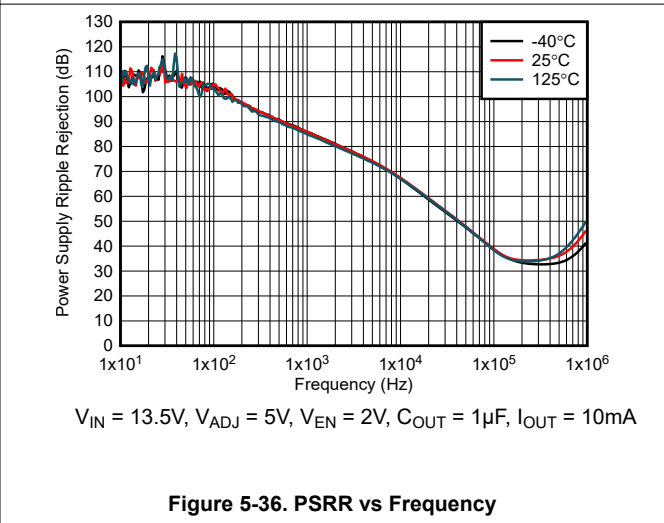
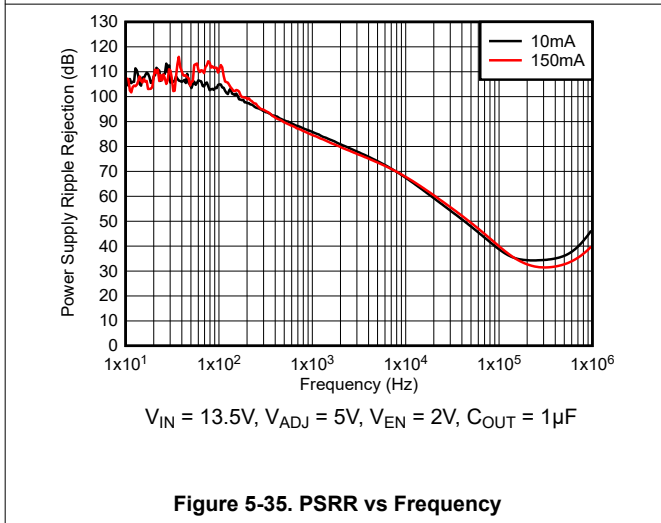
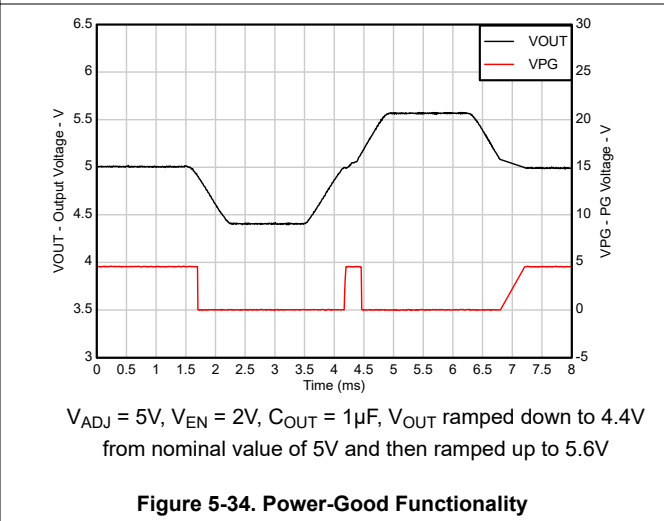
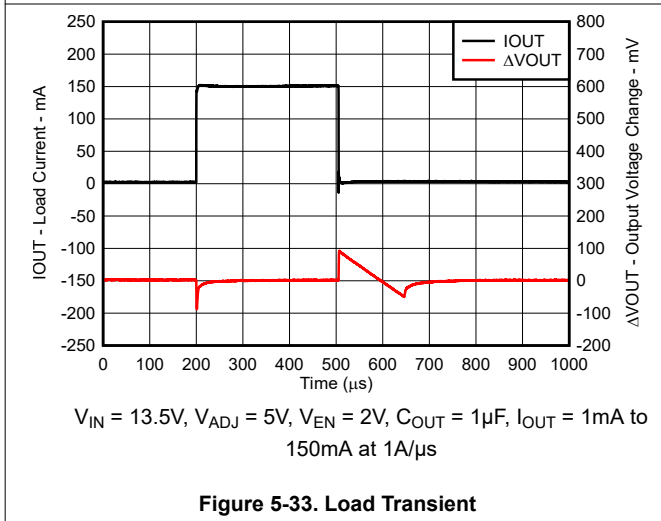
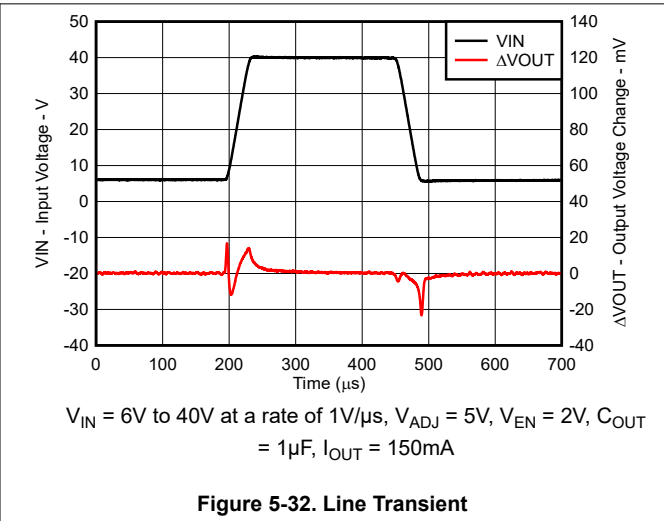
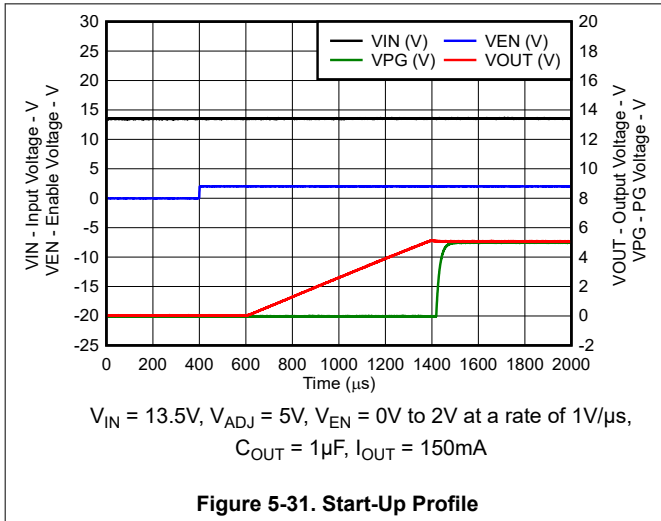

6 Detailed Description

6.1 Overview

The TPS7B4259-Q1 is an integrated, low-dropout (LDO) voltage tracker with ultra-low tracking tolerance. Because of the high risk of cable shorts when powering off-board sensors, multiple features are built into the LDO. These features protect against fault conditions resulting in short to battery, short to GND, and reverse current flow.

In addition, this device also features thermal shutdown protection, brick-wall current limiting, undervoltage lockout (UVLO), reverse polarity protection, and output under- and overvoltage detection.

6.2 Functional Block Diagram

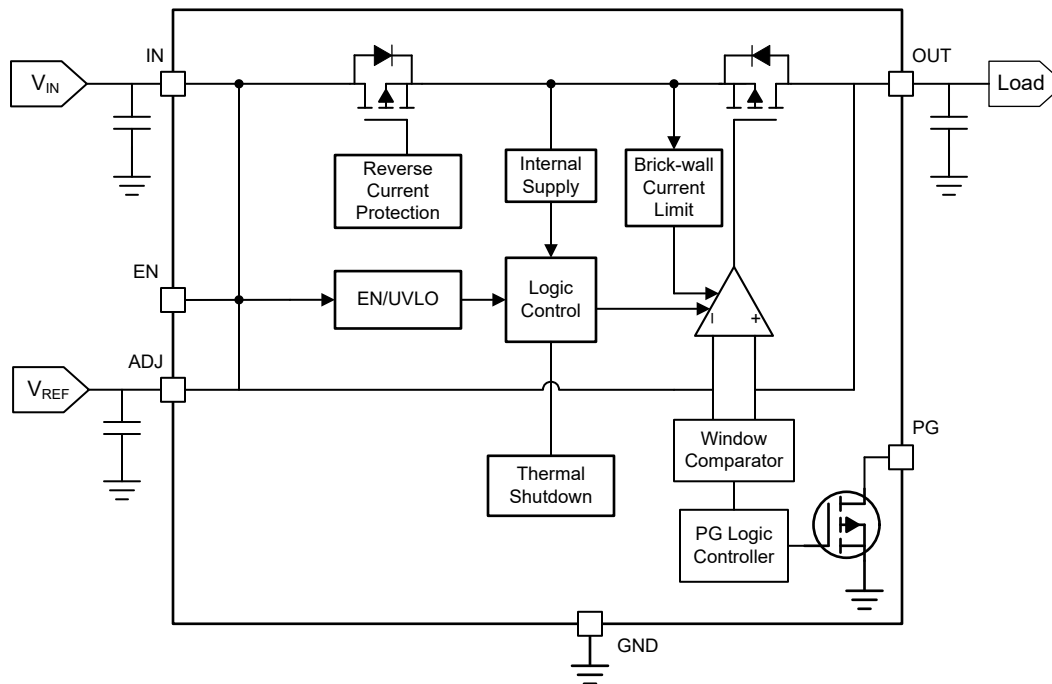

6.3 Feature Description

6.3.1 Tracker Output Voltage (V_{OUT})

Because this device is a tracking LDO, the output voltage equals (and tracks) the voltage provided to the ADJ pin. However, this functionality is conditional on sufficient voltage being provided to the IN pin ($\geq 3.3V$), ADJ pin ($\geq 2V$), and EN pin ($\geq 1.8V$). The LDO remains enabled as long as both V_{EN} and V_{ADJ} exceed $V_{EN, ON}$. The LDO is disabled when either V_{EN} or V_{ADJ} become less than $V_{EN, OFF}$. The values of $V_{EN, ON}$ and $V_{EN, OFF}$ are specified in the [Electrical Characteristics](#) table. The device has a soft-start feature incorporated, which allows the output voltage to rise linearly and limits the in-rush current at start-up. After start-up and attaining steady state, V_{OUT} remains within $\pm 6mV$ from the voltage set on V_{ADJ} over all specified operating conditions. V_{OUT} is the device output voltage and V_{ADJ} is the ADJ pin voltage.

6.3.1.1 Output Voltage Equal to Reference Voltage

Figure 6-1 shows the external reference voltage applied directly to the ADJ pin. Under these conditions, the LDO output voltage is equal to the reference voltage, as given in Equation 1.

$$V_{OUT} = V_{REF} \quad (1)$$

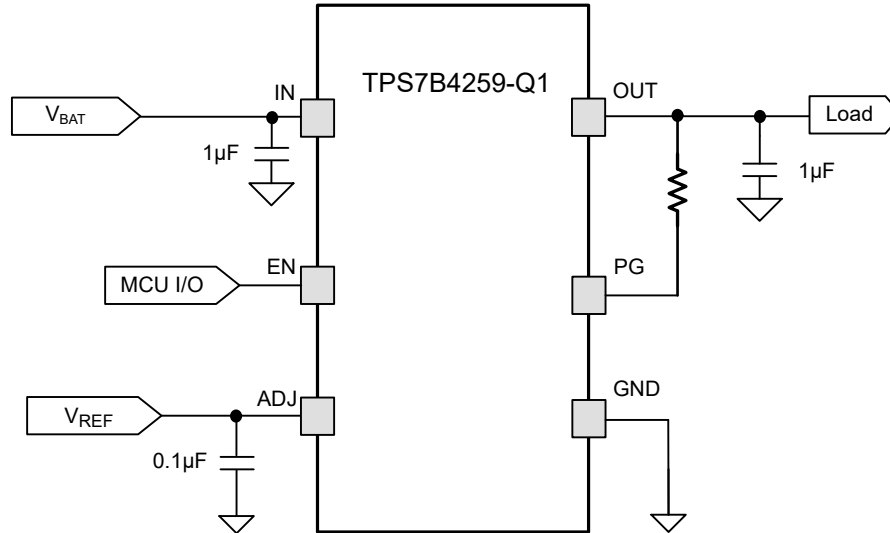

Figure 6-1. Tracker Output Voltage Equal to Reference Voltage

6.3.1.2 Output Voltage Less Than the Reference Voltage

Connecting an external resistor divider at the ADJ pin, as shown in Figure 6-2, helps generate an output voltage that is lower than the reference voltage. Verify both R_1 and R_2 are less than 100k Ω to minimize the error in voltage caused by the ADJ pin leakage current, I_{ADJ} . Equation 2 calculates V_{OUT} .

$$V_{OUT} = \frac{(V_{REF} \times R_2)}{R_1 + R_2} \quad (2)$$

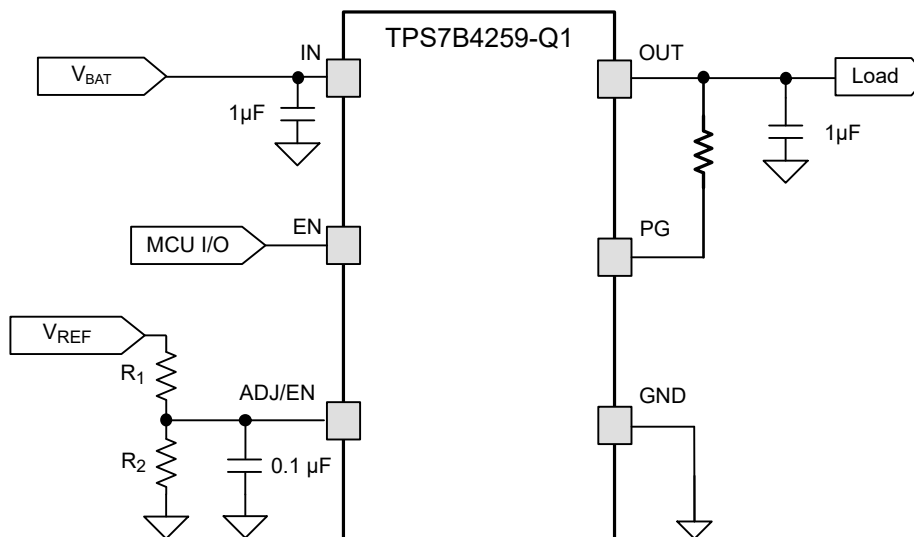

Figure 6-2. Tracker Output Voltage Less Than the Reference Voltage

6.3.2 Reverse Current Protection

The TPS7B4259-Q1 incorporates a back-to-back PMOS topology. This topology protects the device against fault conditions resulting in V_{OUT} being higher than V_{IN} and blocks the flow of reverse current. No damage occurs to the device if this fault condition occurs, provided the [Absolute Maximum Ratings](#) are not violated. This integrated protection feature eliminates the need for an external diode. The reverse current comparator typically responds to a reverse voltage condition in 10 μ s. The comparator along with the body diode of the blocking PMOS transistor, limits the reverse current (I_{REV}) to less than 1.5 μ A. The I_{REV} is specified in the [Electrical Characteristics](#) table.

6.3.3 Power Good

The TPS7B4259-Q1 has an open-drain based power-good pin that helps detect undervoltage and overvoltage fault conditions at the tracker output. Pull this pin up to a regulated rail ($V_{PULL-UP}$) with a pullup resistor. Use the V_{PG} range of values listed in the [Recommended Operating Conditions](#) table to determine the maximum value of the $V_{PULL-UP}$ regulated rail. Verify the input voltage V_{IN} is higher than $V_{UVLO (RISING)}$ for V_{PG} to have a valid value. V_{PG} is the voltage of the power-good pin.

The power-good feature helps monitor the output voltage and detect possible fault conditions. This functionality is conditional on sufficient voltage being provided to the IN, ADJ, and EN pins. See the [Recommended Operating Conditions](#) table for the correct operating voltage ranges at these pins. The PG pin is pulled to $V_{PULL-UP}$ when the tracker output voltage remains within the $V_{PG UV-TH}$ and $V_{PG OV-TH}$ values of V_{ADJ} .

Variations in V_{OUT} beyond the power-good switching thresholds lasting longer than t_{PG} takes the PG pin low to a voltage of $V_{PG} < V_{PG, LOW}$. Transients in V_{OUT} that last less than t_{PG} are not flagged as errors by the PG pin. V_{OUT} is the tracker output voltage. The PG pin remains low when the device is disabled ($V_{EN} < V_{EN, OFF}$), even if sufficient V_{IN} and V_{ADJ} are provided. The values of $V_{PG UV-TH}$, $V_{PG OV-TH}$, t_{PG} , and $V_{PG, LOW}$ are specified in the [Electrical Characteristics](#) table.

6.3.4 Undervoltage Lockout

The device has an internally fixed undervoltage lockout (UVLO) threshold. Undervoltage lockout activates when the input voltage V_{IN} drops below the undervoltage lockout level (see the $V_{UVLO (FALLING)}$ parameter in the [Electrical Characteristics](#) table). This activation makes sure the regulator is not latched into an unknown state during a low input supply voltage. If the input voltage has a negative transient that drops below the UVLO threshold, the regulator shuts down. The regulator powers up in the standard power-up sequence when the input voltage recovers to the required level. See the $V_{UVLO (RISING)}$ parameter in the [Electrical Characteristics](#) table).

6.3.5 Thermal Protection

Thermal protection disables the output when the junction temperature rises to approximately 175°C, which then allows the device to cool. This feature limits the thermal dissipation and rise in junction temperature within the regulator, thus protecting the regulator from damage as a result of overheating. When the junction temperature cools to approximately 160°C, the output circuitry enables. Although the device is enabled at such high temperatures, the device parameters and performance are specified up to a junction temperature of 150°C. Power dissipation, thermal resistance, and ambient temperature are the parameters that determine if the thermal protection circuit becomes enabled. When enabled, unless the power dissipation or the ambient temperature (or both) are reduced, the protection circuit continues to cycle between on and off states.

The internal protection circuitry of the TPS7B4259-Q1 is designed to protect against overload conditions. The circuitry is not intended to replace proper heat sinking. Continuously running the TPS7B4259-Q1 into thermal shutdown degrades device reliability.

6.3.6 Current Limit

The device has an internal current limit circuit that protects the device during overcurrent or shorting conditions. The current-limit circuit, as shown in Figure 6-3, is a brick-wall scheme. When the device is in current limit, the device sources I_{CL} and the output voltage is not regulated. In this scenario, the output voltage depends on the load impedance.

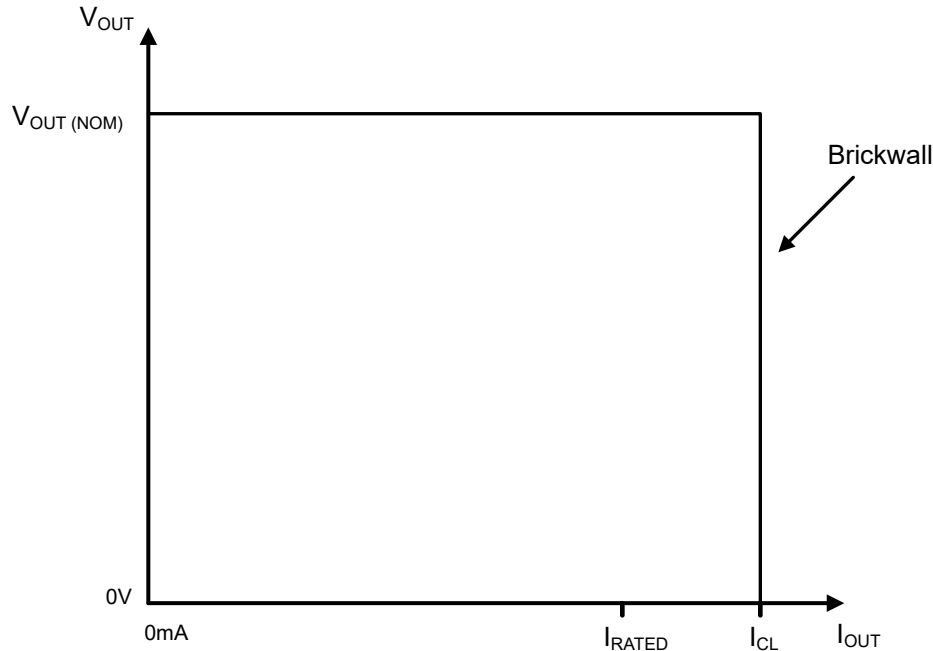

Figure 6-3. Brick-Wall Current-Limit Scheme

During current-limit events, the potential for high power dissipation exists because of the elevated current level and the increased input-to-output differential voltage ($V_{IN} - V_{OUT}$). If the heat dissipation is substantial, the device enters thermal shutdown. If the current-limit condition is not removed when the device turns back on after cooling, the device enters thermal shutdown again. This cycle continues until the current-limit condition is removed. The device survives this fault, but repeatedly operating in this mode degrades long-term reliability.

6.3.7 Output Short to Battery

Figure 6-4 describes a situation where the TPS7B4259-Q1 is powered directly by the battery, and the output shorts to the battery. The TPS7B4259-Q1 survives this fault condition and no damage occurs to the device if the absolute maximum ratings are not violated. Figure 6-5 describes a situation where the output shorts to the battery when the device is powered by a voltage source that is lower than V_{BAT} . In this example, the TPS7B4259-Q1 supply input voltage is set at 7V. The tracker output typically runs at 5V and the battery typically runs at 14V. The back-to-back PMOS topology helps limit the continuous reverse current flowing through V_{IN} to I_{REV} , as specified in the [Electrical Characteristics](#) table.

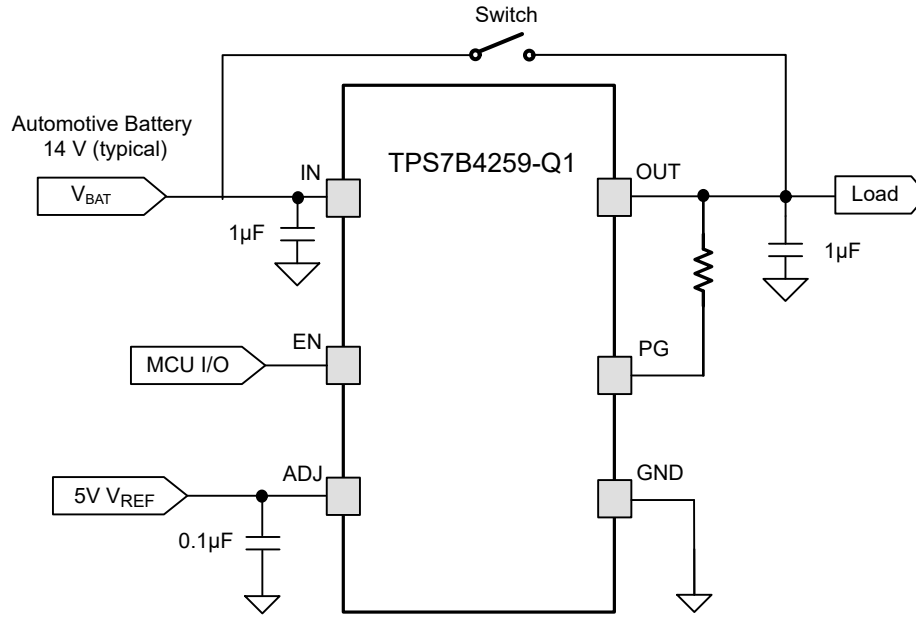

Figure 6-4. Tracker Output Short to Battery

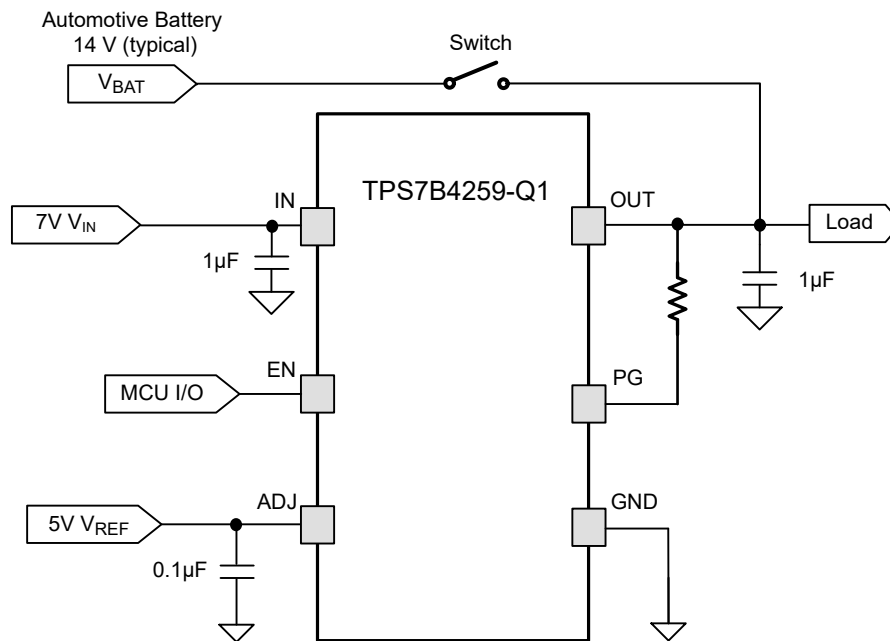

Figure 6-5. Tracker Output Voltage Higher Than Input Voltage

6.4 Device Functional Modes

Table 6-1 shows the conditions that lead to the different modes of operation. See the [Electrical Characteristics](#) table for parameter values.

Table 6-1. Device Functional Mode Comparison

| OPERATING MODE | PARAMETER ⁽¹⁾ | | | | |
|---|--|-------------------------|------------------------|-----------------------------|--------------------------|
| | V _{IN} | V _{ADJ} | V _{EN} | I _{OUT} | T _J |
| Normal operation | $V_{IN} > V_{OUT(Nom)} + V_{DO}$ and $V_{IN} \geq V_{IN(min)}$ | $V_{ADJ} > V_{EN, ON}$ | $V_{EN} > V_{EN, ON}$ | $I_{OUT} \leq I_{OUT(max)}$ | $T_J \leq 150^{\circ}C$ |
| Dropout operation | $V_{IN(min)} < V_{IN} < V_{OUT(nom)} + V_{DO}$ | $V_{ADJ} > V_{EN, ON}$ | $V_{EN} > V_{EN, ON}$ | $I_{OUT} \leq I_{OUT(max)}$ | $T_J < T_{SD(shutdown)}$ |
| Disabled (any true condition disables the device) | $V_{IN} < V_{UVLO}$ | $V_{ADJ} < V_{EN, OFF}$ | $V_{EN} < V_{EN, OFF}$ | Not applicable | $T_J > T_{SD(shutdown)}$ |

(1) The device turns on when V_{IN} is greater than V_{UVLO(RISING)} and both V_{ADJ} and V_{EN} are greater than the enable rising threshold V_{EN, ON}.

6.4.1 Normal Operation

The device output voltage V_{OUT(Nom)} tracks the reference voltage at the ADJ pin when the following conditions are met:

- The input voltage is at least 3.3V (V_{IN(min)}) and greater than the nominal output voltage plus the dropout voltage ($V_{IN} > V_{OUT(nom)} + V_{DO}$).
- The reference voltage at the ADJ pin and the enable pin voltage V_{EN} are both greater than the enable rising threshold V_{EN, ON}. The voltage on the ADJ pin stays stable at the appropriate V_{REF} value.
- The output current is less than I_{OUT(max)} (I_{OUT} ≤ 150mA).
- The device junction temperature does not exceed 150°C (T_J ≤ 150°C).

6.4.2 Dropout Operation

If the input voltage is lower than the nominal output voltage plus the specified dropout voltage, the device operates in dropout mode. In this mode, the output voltage tracks the input voltage. In this mode, the transient performance of the device becomes significantly degraded. During this mode, the pass transistor is driven fully on. Line or load transients in dropout potentially result in large output voltage deviations.

In the dropout state, the pass transistor of the tracker is driven into the ohmic or triode region. In this state, the input and output voltages are related as $V_{IN} < V_{OUT(NOM)} + V_{DO}$. If the tracker device enters dropout directly from normal regulation, the pass transistor transitions from saturation to the triode region. From such a scenario, if the input voltage returns to a value $V_{IN} > V_{OUT(NOM)} + V_{DO}$, the device exits dropout. The tracker takes a short period of time to pull the pass transistor back into saturation from the triode region. During this short time period when the device is exiting dropout, the output voltage potentially has a significant overshoot.

6.4.3 Operation With V_{IN} < 3.3V

For input voltages below 3.3V and above V_{UVLO (FALLING)}, the LDO continues to operate. However, certain internal circuits potentially do not have proper headroom to operate within specification. When the input voltage drops below V_{UVLO (FALLING)}, the device shuts off.

6.4.4 Disable With ADJ and EN Controls

Both the ADJ and EN pins are independently able to disable the device. Shutdown the output of the device by forcing either V_{ADJ} or V_{EN} to less than V_{EN, OFF}. When disabled, the pass transistor is turned off, the internal circuits are shutdown, and the LDO is in a low-power mode.

7 Application and Implementation

Note

Information in the following applications sections is not part of the TI component specification, and TI does not warrant its accuracy or completeness. TI's customers are responsible for determining suitability of components for their purposes, as well as validating and testing their design implementation to confirm system functionality.

7.1 Application Information

7.1.1 Dropout Voltage

Dropout voltage (V_{DO}) is defined as $V_{IN} - V_{OUT}$ when the pass transistor is fully on. V_{IN} is the input voltage and V_{OUT} is the output voltage. This condition arises when the input voltage falls to a point where the error amplifier drives the gate of the pass transistor to the rail. During this condition, there is no remaining headroom for the control loop to operate. At this operating point, the pass transistor is driven fully on. Dropout voltage directly specifies the minimum $V_{IN} - V_{OUT}$ differential the device requires to maintain a regulated output voltage. If the input voltage falls to less than the nominal output regulation, then the output voltage follows, minus the dropout voltage (V_{DO}).

In dropout mode, the output voltage is no longer regulated, and transient performance is severely degraded. The device loses PSRR, and load transients potentially cause large output voltage deviation.

For a CMOS regulator, the dropout voltage is determined by the drain-source on-state resistance ($R_{DS(ON)}$) of the pass transistor. Therefore, if the linear regulator operates at less than the maximum rated output current (I_{RATED}), the dropout voltage for that current scales accordingly. I_{RATED} is listed in the [Recommended Operating Conditions](#) table. The following equation calculates the $R_{DS(ON)}$ of the device.

$$R_{DS(ON)} = \frac{V_{DO}}{I_{RATED}} \quad (3)$$

7.1.2 Reverse Current

The TPS7B4259-Q1 incorporates reverse current protection that prevents damage from fault conditions that result in V_{OUT} being higher than V_{IN} . The reverse current comparator typically responds to a reverse voltage condition in 10 μ s. The comparator along with the body diode of the blocking PMOS transistor, limits the reverse current to less than 1.2 μ A. So long as the absolute maximum ratings are not violated, no damage occurs to the device.

7.2 Typical Application

Figure 7-1 shows a typical application circuit for the TPS7B4259-Q1.

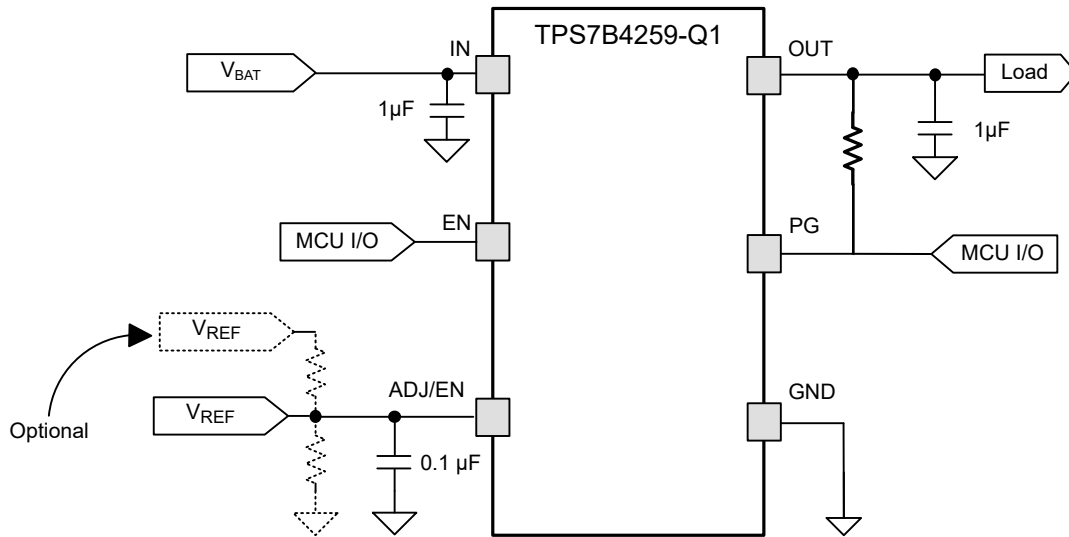

Figure 7-1. Typical Application Schematic

7.2.1 Design Requirements

Use the parameters listed in Table 7-1 for this design example.

Table 7-1. Design Parameters

| DESIGN PARAMETER | EXAMPLE VALUES |
|------------------------------|----------------|
| Input voltage | 3.3V to 40V |
| Adjustable reference voltage | 2V to 40V |
| Enable Voltage | 1.8V to 40V |
| Output voltage | 2V to 40V |
| Output current rating | 150mA |
| Output capacitor range | 1µF to 100µF |
| Output capacitor ESR range | 1mΩ to 2Ω |

7.2.2 Detailed Design Procedure

7.2.2.1 Input and Output Capacitor Selection

Depending on the end application, different values of external components are available. Some applications use a large output capacitor to support fast load steps. The large capacitor helps prevent a significant droop in output voltage, which otherwise results in a reset of downstream components. Use a low equivalent series resistance (ESR) ceramic capacitor with a dielectric of type X5R or X7R for better load transient response.

The TPS7B4259-Q1 requires an output capacitor of at least 1 μ F (500nF or larger capacitance) for stability and an ESR between 0.001 Ω and 2 Ω . Without the output capacitor, the regulator oscillates. For best transient performance, use X5R- and X7R-type ceramic capacitors because these capacitors have minimal variation in value and ESR over temperature. When choosing a capacitor for a specific application, be mindful of the DC bias characteristics for the capacitor. Higher output voltages cause a significant derating of the capacitor. For most applications, a low ESR, 10 μ F ceramic capacitor on the OUT pin is sufficient to provide excellent transient performance.

An input capacitor is not required for stability. However, good analog practice is to connect a capacitor (500nF or higher) between the GND and IN pin of the TPS7B4259-Q1. Some input supplies have a high impedance, thus placing the input capacitor on the input supply helps reduce input impedance. This capacitor counteracts reactive input sources and improves transient response, input ripple, and PSRR. If the input supply has high impedance over a large range of frequencies, use several input capacitors in parallel to lower the impedance over frequency. Use a higher-value capacitor if large, fast rise-time load transients are anticipated, or if the device is located several inches from the input power source.

7.2.3 Application Curves

The following images illustrate the functions of $R_{\theta JA}$ and ψ_{JB} versus copper area and thickness for the HSOIC-8 (DDA) package. These plots are generated with a 101.6mm \times 101.6mm \times 1.6mm printed circuit board (PCB) of two and four layers. For the 2-layer board, the bottom layer is a ground plane of constant size, and the top layer copper is connected to GND and varied. For the 4-layer board, the second layer is a ground plane of constant size and the third layer is a power plane of constant size. The top and bottom layers copper fills are connected to GND and varied at the same rate. For the 4-layer board, inner planes use 1oz copper thickness. Outer layers are simulated with both 1oz and 2oz copper thickness. A 3 \times 3 array of thermal vias with a 300 μ m drill diameter and 25 μ m copper plating is located underneath the device. The thermal vias connect the top layer, the bottom layer and, in the case of the 4-layer board, the first inner GND plane. [PowerPAD™ Thermally Enhanced Package application note](#) discusses the impact that thermal vias have on thermal performance.

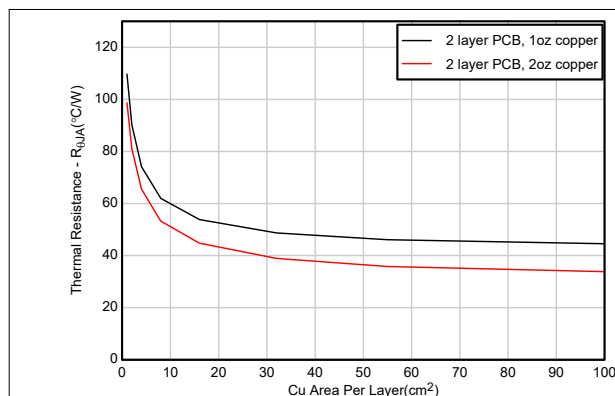

Figure 7-2. $R_{\theta JA}$ vs Copper Area (HSOIC-8 Package, 2 Layer PCB)

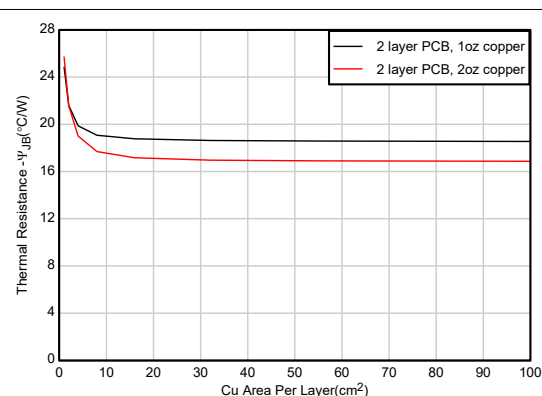
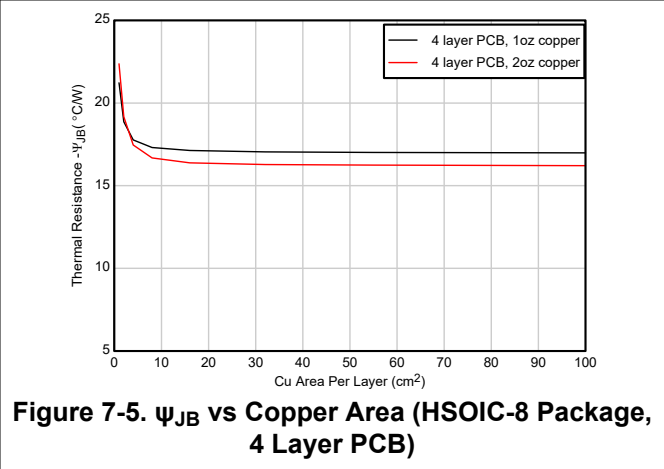
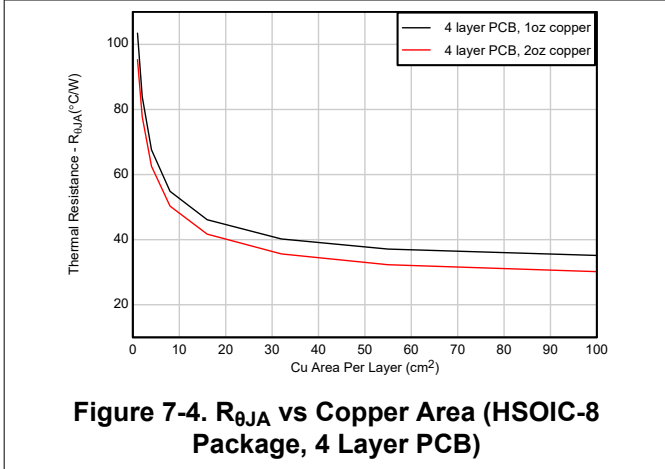

Figure 7-3. ψ_{JB} vs Copper Area (HSOIC-8 Package, 2 Layer PCB)



7.3 Power Supply Recommendations

The device is designed to operate from an input voltage supply range from 3.3V to 40V.

7.4 Layout

7.4.1 Layout Guidelines

For best overall performance, place all circuit components on the same side of the circuit board. Place these components as near as practical to the respective LDO pin connections. Place ground return connections of the input and output capacitor, as close as possible to the LDO ground pin. Use a wide, component-side, copper surface to make connections between the capacitor and pin. Using vias and long traces to the input and output capacitors is strongly discouraged and negatively affects system performance. Use a ground reference plane either embedded in the PCB or located on the bottom side of the PCB opposite the components. This reference plane helps improve accuracy of the output voltage and provide shielding from noise. This plane behaves similarly to a thermal plane to spread (or sink) heat from the LDO device when connected to the thermal pad. In most applications, this ground plane is necessary to meet thermal requirements.

7.4.1.1 Package Mounting

Solder-pad footprint recommendations for the TPS7B4259-Q1 are available at the end of this document and at www.ti.com.

7.4.1.2 Board Layout Recommendations to Improve PSRR and Noise Performance

To improve AC performance (such as PSRR, output noise, and transient response), design the board with separate ground planes for V_{IN} and V_{OUT} . Connect each ground plane only at the GND pin of the device. In addition, directly connect the ground connection for the output capacitor to the GND pin of the device.

Minimize equivalent series inductance (ESL) and ESR to maximize performance and provide stability. Place each capacitor as close as possible to the device and on the same side of the PCB as the regulator.

Do not place any capacitors on the opposite side of the PCB from where the regulator is installed. Using vias and long traces is strongly discouraged because of the negative impact on system performance. Vias and long traces potentially cause instability.

If possible, and to provide the maximum performance denoted in this document, use the same layout pattern used for the TPS7B4259-Q1 evaluation board. This evaluation board is available at www.ti.com.

7.4.1.3 Power Dissipation and Thermal Considerations

[Equation 4](#) calculates the device power dissipation.

$$P_D = I_{OUT} \times (V_{IN} - V_{OUT}) + I_Q \times V_{IN} \quad (4)$$

where:

- P_D = Continuous power dissipation
- I_{OUT} = Output current
- V_{IN} = Input voltage
- V_{OUT} = Output voltage
- I_Q = Quiescent current

Because I_Q is much less than I_{OUT} , ignore the $I_Q \times V_{IN}$ term in [Equation 4](#).

Calculate the junction temperature (T_J) with [Equation 5](#) for a device under operation at a given ambient air temperature (T_A).

$$T_J = T_A + (R_{\theta JA} \times P_D) \quad (5)$$

where:

- $R_{\theta JA}$ = Junction-to-junction-ambient air thermal impedance

[Equation 6](#) calculates a rise in junction temperature because of power dissipation.

$$\Delta T = T_J - T_A = (R_{\theta JA} \times P_D) \quad (6)$$

The maximum ambient air temperature (T_{AMAX}) at which the device operates is calculated with Equation 7 for a given maximum junction temperature (T_{JMAX}).

$$T_{AMAX} = T_{JMAX} - (R_{\theta JA} \times P_D) \quad (7)$$

7.4.1.4 Thermal Performance Versus Copper Area

The most used thermal resistance parameter $R_{\theta JA}$ is highly dependent on the heat-spreading capability built into the particular PCB design. $R_{\theta JA}$ therefore varies according to the total copper area, copper weight, and location of the planes. The $R_{\theta JA}$ recorded in the *Thermal Information* table is determined by the JEDEC standard (Figure 7-6), PCB, and copper-spreading area. This parameter is only used as a relative measure of package thermal performance. For a well-designed thermal layout, $R_{\theta JA}$ is actually the sum of $R_{\theta JCbot}$ plus the thermal resistance contribution by the PCB copper. $R_{\theta JCbot}$ is the package junction-to-case (bottom) thermal resistance, as given in the *Thermal Information* table.

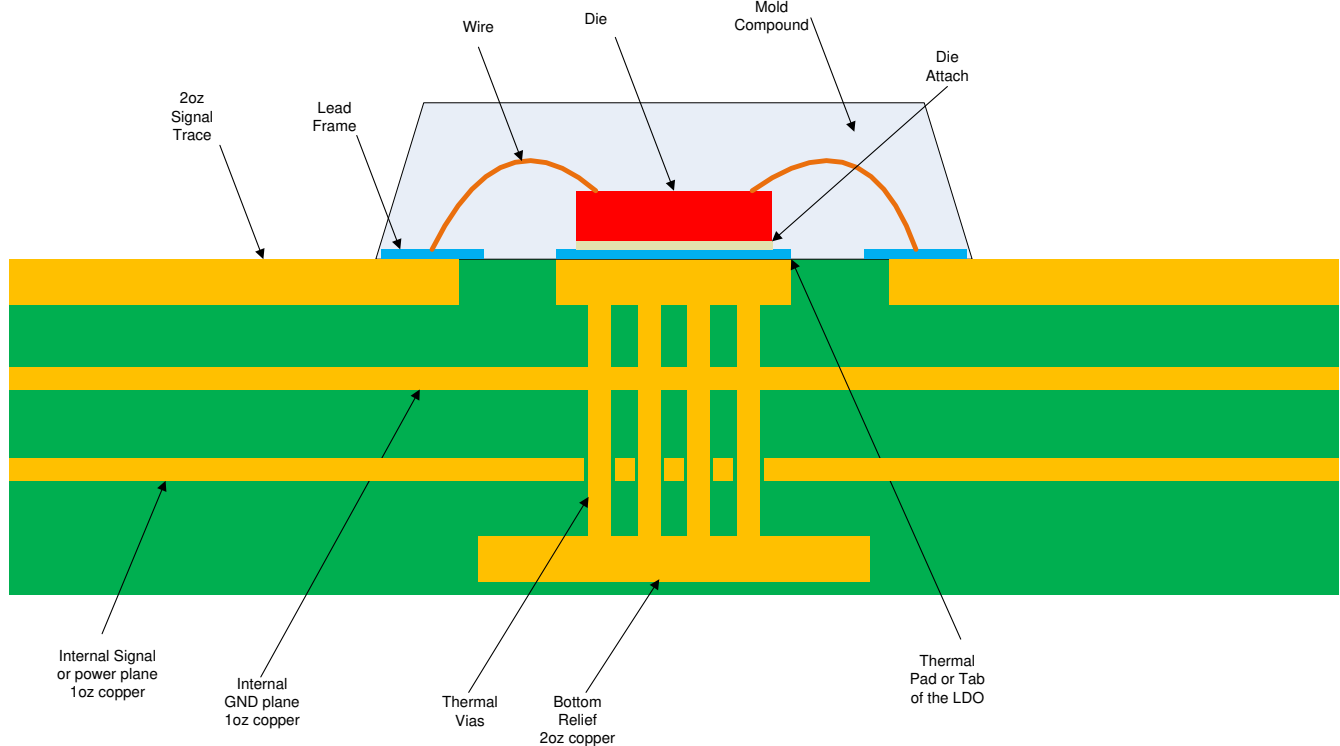

Figure 7-6. JEDEC Standard 2s2p PCB

7.4.2 Layout Example

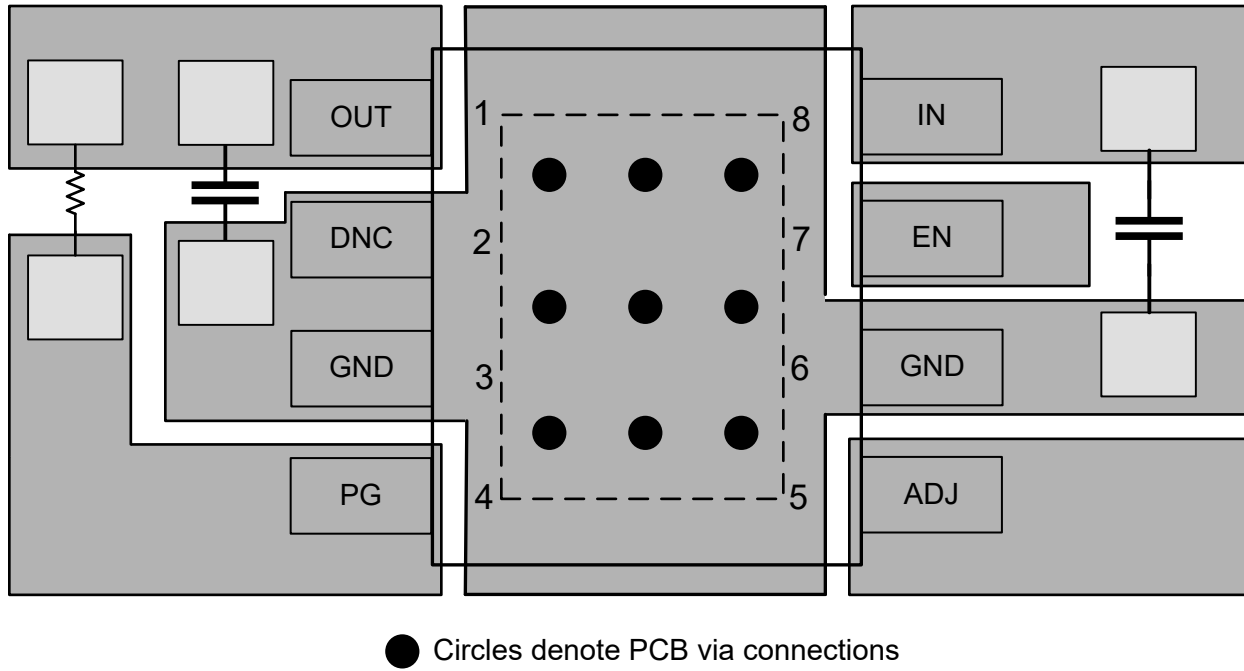

Figure 7-7. Layout Example

8 Device and Documentation Support

8.1 Device Support

8.1.1 Device Nomenclature

Table 8-1. Device Nomenclature

| PRODUCT ⁽¹⁾ | V _{OUT} |
|------------------------|---|
| TPS7B4259QDDARQ1 | In the HSOIC (DDA) package: Q indicates that this device is a grade-1 device in accordance with the AEC-Q100 standard. R is the packaging quantity. Q1 indicates that this device is an automotive grade (AEC-Q100) device. |

(1) For the most current package and ordering information see the Package Option Addendum at the end of this document, or visit the device product folder on www.ti.com.

8.2 Documentation Support

8.2.1 Related Documentation

For related documentation, see the following:

- Texas Instruments, [PowerPAD™ Thermally Enhanced Package application note](#)

8.3 Receiving Notification of Documentation Updates

To receive notification of documentation updates, navigate to the device product folder on ti.com. Click on *Notifications* to register and receive a weekly digest of any product information that has changed. For change details, review the revision history included in any revised document.

8.4 Support Resources

[TI E2E™ support forums](#) are an engineer's go-to source for fast, verified answers and design help — straight from the experts. Search existing answers or ask your own question to get the quick design help you need.

Linked content is provided "AS IS" by the respective contributors. They do not constitute TI specifications and do not necessarily reflect TI's views; see TI's [Terms of Use](#).

8.5 Trademarks

TI E2E™ is a trademark of Texas Instruments.
All trademarks are the property of their respective owners.

8.6 Electrostatic Discharge Caution



This integrated circuit can be damaged by ESD. Texas Instruments recommends that all integrated circuits be handled with appropriate precautions. Failure to observe proper handling and installation procedures can cause damage.

ESD damage can range from subtle performance degradation to complete device failure. Precision integrated circuits may be more susceptible to damage because very small parametric changes could cause the device not to meet its published specifications.

8.7 Glossary

[TI Glossary](#) This glossary lists and explains terms, acronyms, and definitions.

9 Revision History

NOTE: Page numbers for previous revisions may differ from page numbers in the current version.

| Changes from Revision * (May 2025) to Revision A (July 2025) | Page |
|---|------|
| • Changed document status from <i>Advance Information</i> to <i>Production Data</i> | 1 |

10 Mechanical, Packaging, and Orderable Information

The following pages include mechanical, packaging, and orderable information. This information is the most current data available for the designated devices. This data is subject to change without notice and revision of this document. For browser-based versions of this data sheet, refer to the left-hand navigation.

PACKAGING INFORMATION

| Orderable part number | Status (1) | Material type (2) | Package Pins | Package qty Carrier | RoHS (3) | Lead finish/ Ball material (4) | MSL rating/ Peak reflow (5) | Op temp (°C) | Part marking (6) |
|-----------------------------------|---------------|----------------------|--------------------------|-----------------------|-------------|--------------------------------------|-----------------------------------|--------------|---------------------|
| PTPS7B4259QDDARQ1 | Active | Preproduction | SO PowerPAD (DDA) 8 | 1 LARGE T&R | - | Call TI | Call TI | -40 to 125 | |
| TPS7B4259QDDARQ1 | Active | Production | SO PowerPAD (DDA) 8 | 3000 LARGE T&R | Yes | NIPDAU | Level-2-260C-1 YEAR | -40 to 125 | B4259F |

(1) **Status:** For more details on status, see our [product life cycle](#).

(2) **Material type:** When designated, preproduction parts are prototypes/experimental devices, and are not yet approved or released for full production. Testing and final process, including without limitation quality assurance, reliability performance testing, and/or process qualification, may not yet be complete, and this item is subject to further changes or possible discontinuation. If available for ordering, purchases will be subject to an additional waiver at checkout, and are intended for early internal evaluation purposes only. These items are sold without warranties of any kind.

(3) **RoHS values:** Yes, No, RoHS Exempt. See the [TI RoHS Statement](#) for additional information and value definition.

(4) **Lead finish/Ball material:** Parts may have multiple material finish options. Finish options are separated by a vertical ruled line. Lead finish/Ball material values may wrap to two lines if the finish value exceeds the maximum column width.

(5) **MSL rating/Peak reflow:** The moisture sensitivity level ratings and peak solder (reflow) temperatures. In the event that a part has multiple moisture sensitivity ratings, only the lowest level per JEDEC standards is shown. Refer to the shipping label for the actual reflow temperature that will be used to mount the part to the printed circuit board.

(6) **Part marking:** There may be an additional marking, which relates to the logo, the lot trace code information, or the environmental category of the part.

Multiple part markings will be inside parentheses. Only one part marking contained in parentheses and separated by a "-" will appear on a part. If a line is indented then it is a continuation of the previous line and the two combined represent the entire part marking for that device.

Important Information and Disclaimer: The information provided on this page represents TI's knowledge and belief as of the date that it is provided. TI bases its knowledge and belief on information provided by third parties, and makes no representation or warranty as to the accuracy of such information. Efforts are underway to better integrate information from third parties. TI has taken and continues to take reasonable steps to provide representative and accurate information but may not have conducted destructive testing or chemical analysis on incoming materials and chemicals. TI and TI suppliers consider certain information to be proprietary, and thus CAS numbers and other limited information may not be available for release.

In no event shall TI's liability arising out of such information exceed the total purchase price of the TI part(s) at issue in this document sold by TI to Customer on an annual basis.

TAPE AND REEL INFORMATION

QUADRANT ASSIGNMENTS FOR PIN 1 ORIENTATION IN TAPE

*All dimensions are nominal

| Device | Package Type | Package Drawing | Pins | SPQ | Reel Diameter (mm) | Reel Width W1 (mm) | A0 (mm) | B0 (mm) | K0 (mm) | P1 (mm) | W (mm) | Pin1 Quadrant |
|------------------|--------------|-----------------|------|------|--------------------|--------------------|---------|---------|---------|---------|--------|---------------|
| TPS7B4259QDDARQ1 | SO PowerPAD | DDA | 8 | 3000 | 330.0 | 12.5 | 6.4 | 5.2 | 2.1 | 8.0 | 12.0 | Q1 |

TAPE AND REEL BOX DIMENSIONS



*All dimensions are nominal

| Device | Package Type | Package Drawing | Pins | SPQ | Length (mm) | Width (mm) | Height (mm) |
|------------------|--------------|-----------------|------|------|-------------|------------|-------------|
| TPS7B4259QDDARQ1 | SO PowerPAD | DDA | 8 | 3000 | 340.5 | 338.1 | 20.6 |

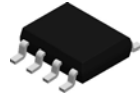

Images above are just a representation of the package family, actual package may vary.
Refer to the product data sheet for package details.

DDA0008B



PACKAGE OUTLINE

PowerPAD™ SOIC - 1.7 mm max height

PLASTIC SMALL OUTLINE

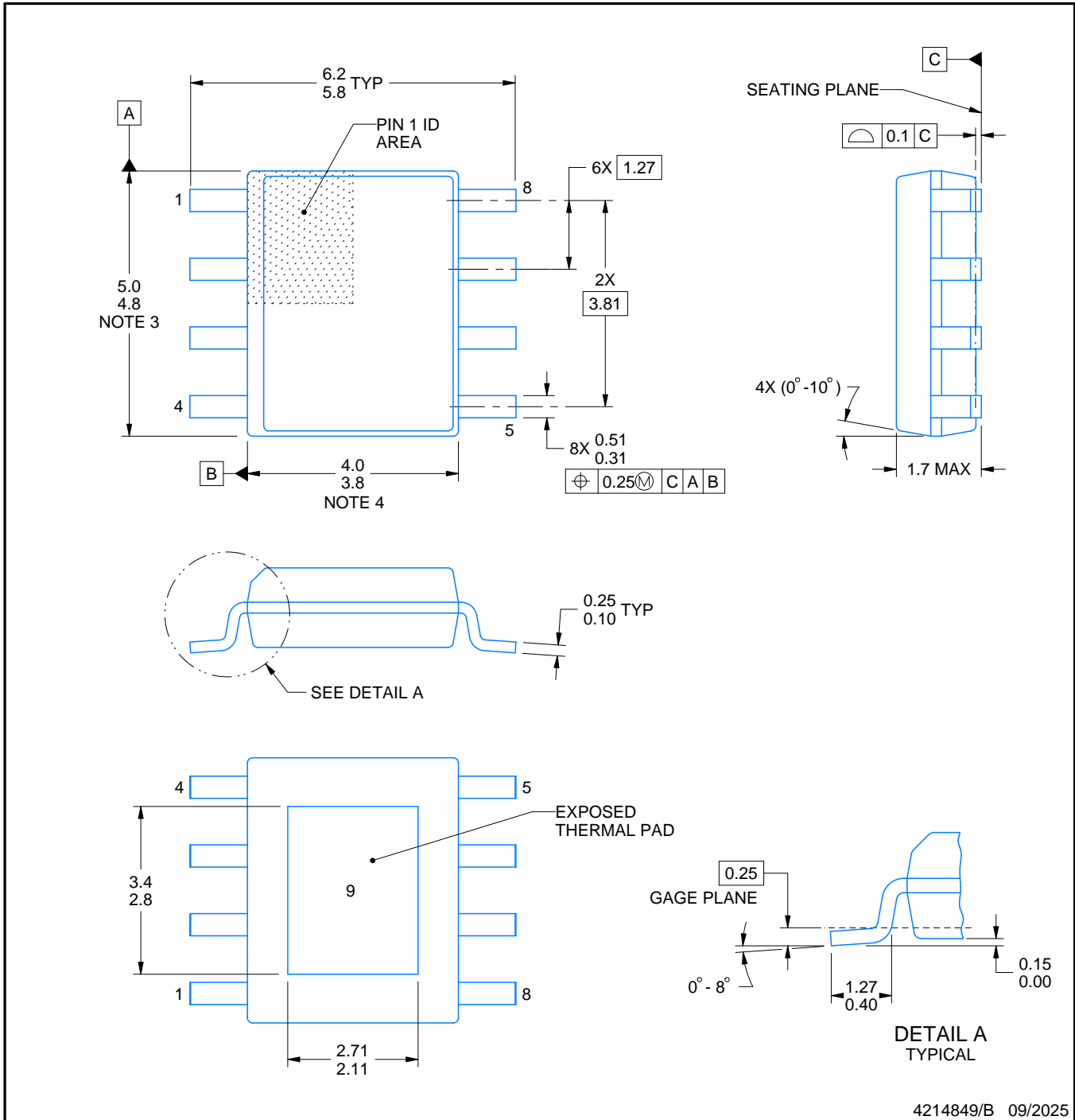

4214849/B 09/2025

NOTES:

PowerPAD is a trademark of Texas Instruments.

1. All linear dimensions are in millimeters. Any dimensions in parenthesis are for reference only. Dimensioning and tolerancing per ASME Y14.5M.
2. This drawing is subject to change without notice.
3. This dimension does not include mold flash, protrusions, or gate burrs. Mold flash, protrusions, or gate burrs shall not exceed 0.15 mm per side.
4. This dimension does not include interlead flash. Interlead flash shall not exceed 0.25 mm per side.
5. Reference JEDEC registration MS-012.

EXAMPLE BOARD LAYOUT

DDA0008B

PowerPAD™ SOIC - 1.7 mm max height

PLASTIC SMALL OUTLINE

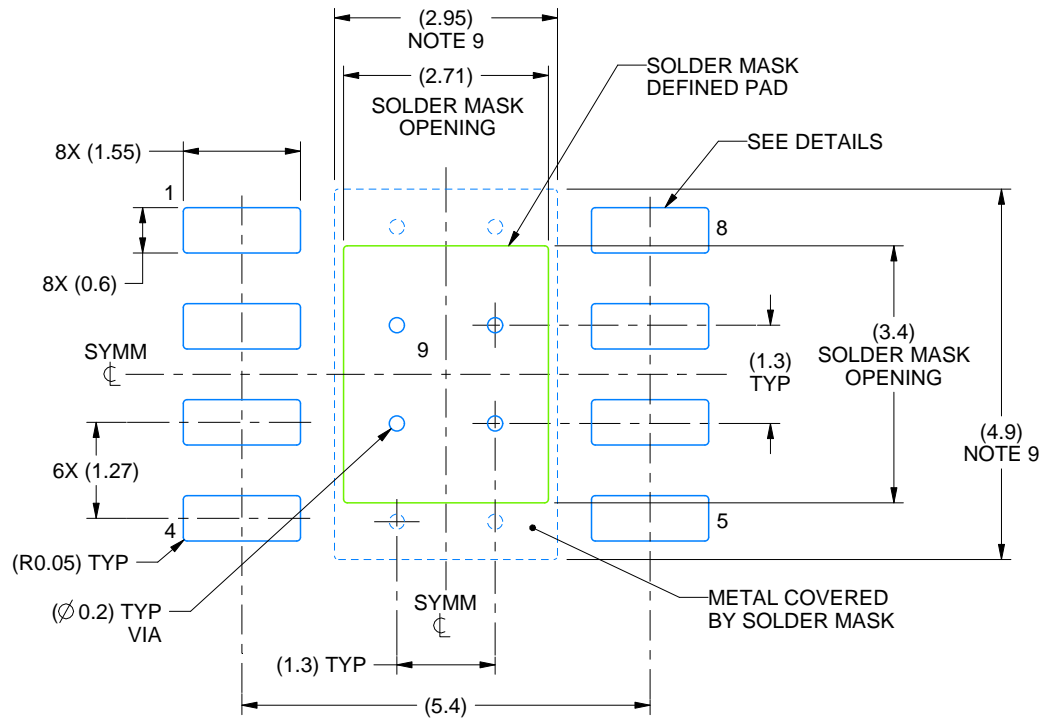

LAND PATTERN EXAMPLE
SCALE:10X

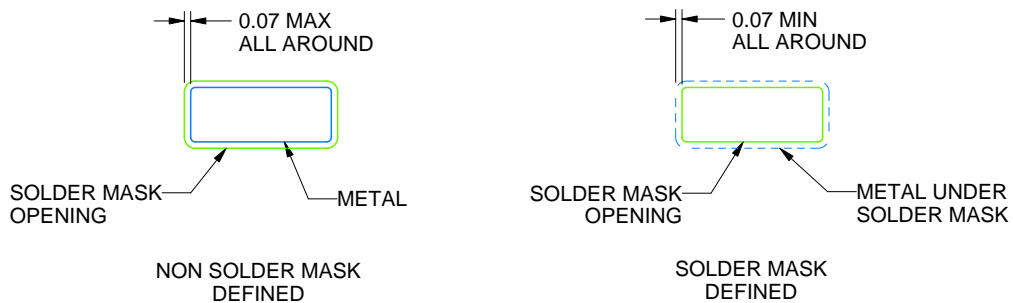

SOLDER MASK DETAILS
PADS 1-8

4214849/B 09/2025

NOTES: (continued)

6. Publication IPC-7351 may have alternate designs.
7. Solder mask tolerances between and around signal pads can vary based on board fabrication site.
8. This package is designed to be soldered to a thermal pad on the board. For more information, see Texas Instruments literature numbers SLMA002 (www.ti.com/lit/slma002) and SLMA004 (www.ti.com/lit/slma004).
9. Size of metal pad may vary due to creepage requirement.
10. Vias are optional depending on application, refer to device data sheet. If any vias are implemented, refer to their locations shown on this view. It is recommended that vias under paste be filled, plugged or tented.

EXAMPLE STENCIL DESIGN

DDA0008B

PowerPAD™ SOIC - 1.7 mm max height

PLASTIC SMALL OUTLINE

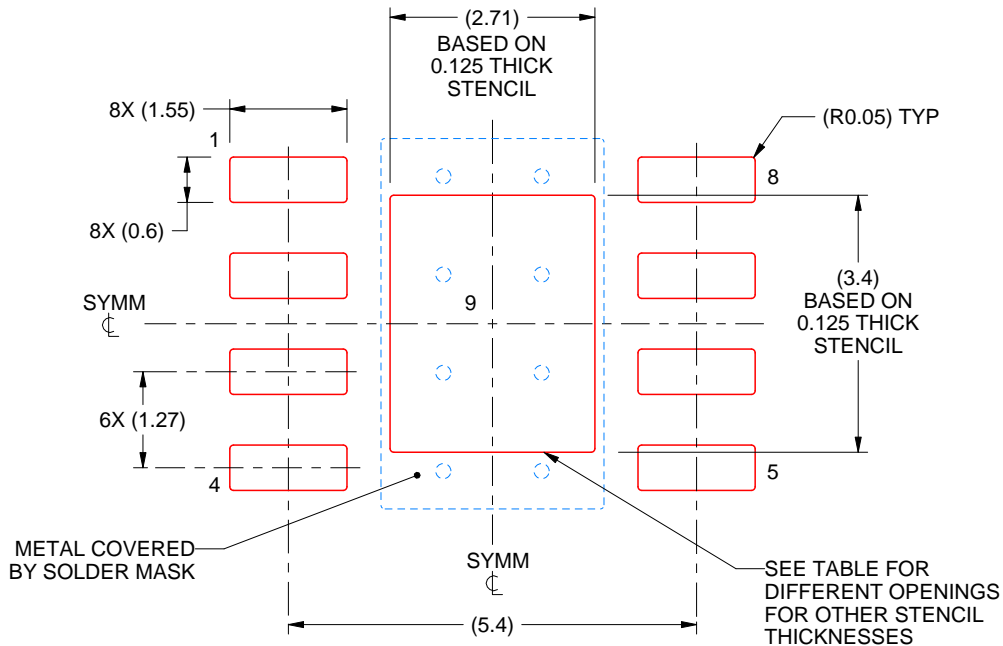

SOLDER PASTE EXAMPLE
EXPOSED PAD
100% PRINTED SOLDER COVERAGE BY AREA
SCALE:10X

| STENCIL THICKNESS | SOLDER STENCIL OPENING |
|-------------------|------------------------|
| 0.1 | 3.03 X 3.80 |
| 0.125 | 2.71 X 3.40 (SHOWN) |
| 0.150 | 2.47 X 3.10 |
| 0.175 | 2.29 X 2.87 |

4214849/B 09/2025

NOTES: (continued)

11. Laser cutting apertures with trapezoidal walls and rounded corners may offer better paste release. IPC-7525 may have alternate design recommendations.
12. Board assembly site may have different recommendations for stencil design.

IMPORTANT NOTICE AND DISCLAIMER

TI PROVIDES TECHNICAL AND RELIABILITY DATA (INCLUDING DATASHEETS), DESIGN RESOURCES (INCLUDING REFERENCE DESIGNS), APPLICATION OR OTHER DESIGN ADVICE, WEB TOOLS, SAFETY INFORMATION, AND OTHER RESOURCES "AS IS" AND WITH ALL FAULTS, AND DISCLAIMS ALL WARRANTIES, EXPRESS AND IMPLIED, INCLUDING WITHOUT LIMITATION ANY IMPLIED WARRANTIES OF MERCHANTABILITY, FITNESS FOR A PARTICULAR PURPOSE OR NON-INFRINGEMENT OF THIRD PARTY INTELLECTUAL PROPERTY RIGHTS.

These resources are intended for skilled developers designing with TI products. You are solely responsible for (1) selecting the appropriate TI products for your application, (2) designing, validating and testing your application, and (3) ensuring your application meets applicable standards, and any other safety, security, regulatory or other requirements.

These resources are subject to change without notice. TI grants you permission to use these resources only for development of an application that uses the TI products described in the resource. Other reproduction and display of these resources is prohibited. No license is granted to any other TI intellectual property right or to any third party intellectual property right. TI disclaims responsibility for, and you fully indemnify TI and its representatives against any claims, damages, costs, losses, and liabilities arising out of your use of these resources.

TI's products are provided subject to [TI's Terms of Sale](#), [TI's General Quality Guidelines](#), or other applicable terms available either on [ti.com](#) or provided in conjunction with such TI products. TI's provision of these resources does not expand or otherwise alter TI's applicable warranties or warranty disclaimers for TI products. Unless TI explicitly designates a product as custom or customer-specified, TI products are standard, catalog, general purpose devices.

TI objects to and rejects any additional or different terms you may propose.

Copyright © 2025, Texas Instruments Incorporated

Last updated 10/2025