

# TPS7E81-Q1 Automotive, 150mA, 40V, Ultra-Low I<sub>Q</sub> Low-Dropout Regulator

## 1 Features

- AEC-Q100 qualified for automotive applications:
  - Temperature grade 1: –40°C to +125°C, T<sub>A</sub>
  - Junction temperature: –40°C to +150°C, T<sub>J</sub>
- Input voltage range: 3.0V to 40V (42V max)
- Available output voltage options:
  - Fixed: 1.8V to 12V
  - Adjustable: 1.2V to 38V
- Output current: up-to 150mA
- ±1.2% accuracy across line, load and temperature
- Ultra-low I<sub>Q</sub>: 2.8µA at I<sub>OUT</sub> = 0mA
- Stable with 2.2µF or larger ceramic capacitors
  - ESR range: 0Ω to 1Ω
- Dropout voltage: 460mV (typical) at 150mA
- High PSRR:
  - 70dB at 1kHz
  - 45dB at 100kHz
- Over-current, Over-power and Over-temperature limiting
- Package:
  - 5-pin SOT-23 (DBV) [R<sub>θJA</sub>: 190.9°C/W]
  - 6-pin WSON (DRV) [R<sub>θJA</sub>: 90.2°C/W]
  - 8-pin HVSSOP (DGN) [R<sub>θJA</sub>: 58.5°C/W]

## 2 Applications

- [Automotive head units](#)
- [Hybrid, electric & powertrain systems](#)
- [Headlights](#)
- [Telematics control unit](#)
- [Body control module \(BCM\)](#)

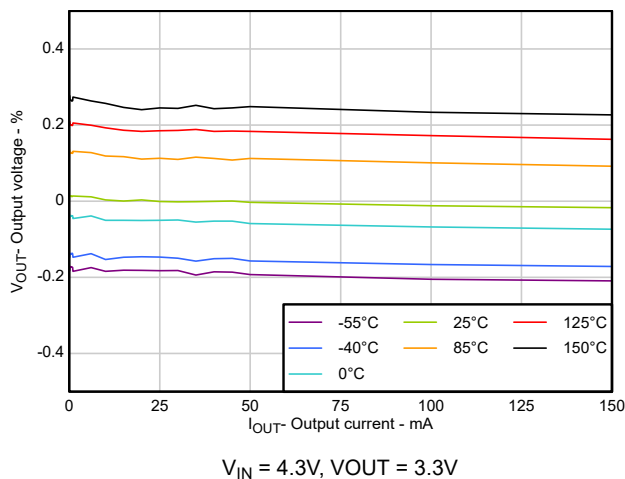

Figure 2-1. V<sub>OUT</sub> Accuracy vs I<sub>OUT</sub>

## 3 Description

The TPS7E81-Q1 low-dropout (LDO) linear voltage regulator is a low quiescent current device designed to connect to the battery in the automotive applications and supports wide input voltage range from 3V to 40V. The wide output range is from 1.2V to 38V for the adjustable configuration and 1.8V to 12V for the fixed configuration and up-to 150mA of load current. With only an 2.8µA quiescent current at no-load, the device is a good design for powering always-on components such as microcontrollers (MCUs), gate drivers and controller area network (CAN) transceivers in standby systems.

The TPS7E81-Q1 supports very tight DC accuracy of ±1.2% over line, load and temperature range. The device responds quickly to line and load transients and controls quiescent current in dropout operation.

The TPS7E81-Q1 has built-in protection mechanism for overcurrent, over-temperature and over-power delivery for reliable operation of the LDO. The TPS7E81-Q1 is stable with an output capacitor range of 2.2µF to 100µF.

The TPS7E81-Q1 is available in a 2.0mm × 2.0mm, 6-pin WSON (wetable flank) (DRV-WF), 3.0mm × 4.9mm, 8-pin HVSSOP (DGN) and 2.9mm × 2.8mm, 5-pin SOT-23 (DBV) package for fixed and adjustable outputs.

### Package Information

PART NUMBER	PACKAGE <sup>(1)</sup>	PACKAGE SIZE <sup>(2)</sup>
TPS7E81-Q1	DBV (SOT-23, 5)	2.9mm × 2.8mm
	DRV (WSON, 6)	2.0mm × 2.0mm
	DGN (HVSSOP, 8)	3.0mm × 4.9mm

- (1) For more information, see the [Section 10](#).
- (2) The package size (length × width) is a nominal value and includes pins, where applicable.



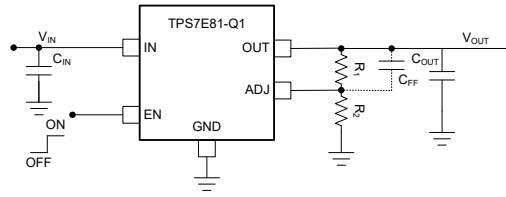

**Figure 3-1. Typical Application**

## Table of Contents

<b>1 Features</b> .....	<b>1</b>	<b>7 Application and Implementation</b> .....	<b>25</b>
<b>2 Applications</b> .....	<b>1</b>	7.1 Application Information.....	25
<b>3 Description</b> .....	<b>1</b>	7.2 Typical Application.....	29
<b>4 Pin Configuration and Functions</b> .....	<b>4</b>	7.3 Power Supply Recommendations.....	34
<b>5 Specifications</b> .....	<b>5</b>	7.4 Layout.....	34
5.1 Absolute Maximum Ratings.....	5	<b>8 Device and Documentation Support</b> .....	<b>36</b>
5.2 ESD Ratings.....	5	8.1 Device Support.....	36
5.3 Recommended Operating Conditions.....	5	8.2 Documentation Support.....	36
5.4 Thermal Information.....	6	8.3 Receiving Notification of Documentation Updates....	36
5.5 Electrical Characteristics.....	6	8.4 Support Resources.....	36
5.6 Typical Characteristics.....	8	8.5 Trademarks.....	36
<b>6 Detailed Description</b> .....	<b>18</b>	8.6 Electrostatic Discharge Caution.....	37
6.1 Overview.....	18	8.7 Glossary.....	37
6.2 Functional Block Diagrams.....	18	<b>9 Revision History</b> .....	<b>37</b>
6.3 Feature Description.....	20	<b>10 Mechanical, Packaging, and Orderable Information</b> .....	<b>37</b>
6.4 Device Functional Modes.....	23		

---

## 4 Pin Configuration and Functions

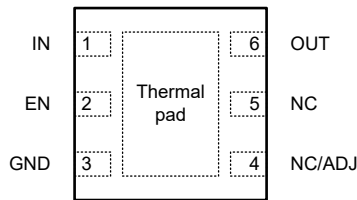

Figure 4-1. DRV Package (Fixed/ADJ), 6-Pin WSON (Top View)

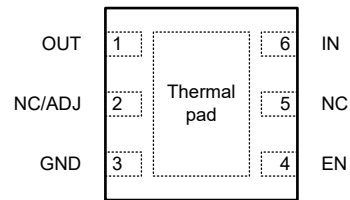

Figure 4-2. DRV Package, A-version (Fixed/ADJ), 6-Pin WSON (Top View)

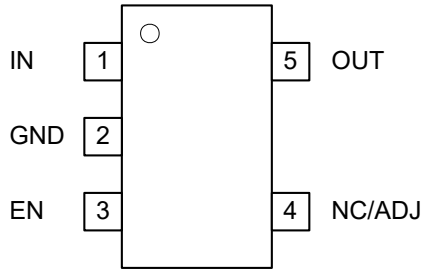

Figure 4-3. DBV Package, (Fixed/ADJ), 5-Pin SOT-23 (Top View)

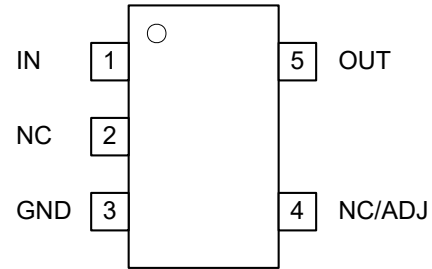

Figure 4-4. DBV Package, [A-version, w/o EN] (Fixed/ADJ), 5-Pin SOT-23 (Top View)

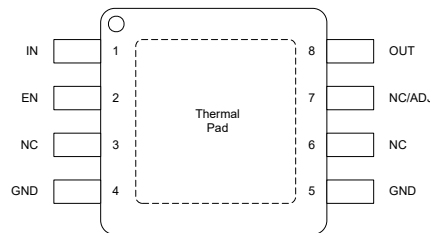

Figure 4-5. DGN Package (Fixed/ADJ), 8-Pin HVSSOP (Top View)

Table 4-1. Pin Functions

PIN		DESCRIPTION
NAME	TYPE	
GND	—	Ground pin.
IN	Input	Input supply pin. See the <a href="#">Recommended Operating Conditions</a> table and the <a href="#">Input and Output Capacitor Selection</a> section for more information.
OUT	Output	Output of the regulator. A capacitor is required from OUT to ground for stability. For best transient response, use the nominal recommended value or larger ceramic capacitor from OUT to ground; see the <a href="#">Recommended Operating Conditions</a> table and the <a href="#">Input and Output Capacitor Selection</a> section. Place the output capacitor as close to output of the device as possible.
EN	Input	Enable pin. Driving the enable pin high enables the device. Driving this pin low disables the device. High and low thresholds are listed in the <a href="#">Electrical Characteristics</a> table. This pin has a weak internal pullup and can be left floating to enable the device or the pin can be connected to the input pin. Refer to <a href="#">Enable (EN)</a> section.
ADJ	Input	When using the adjustable device, this pin sets the output voltage with the help of a feedback divider. In the adjustable configuration, this pin must be connected through a resistor divider to the output for the device to function.
NC	—	Not internally connected. Leave this pin open or connected to any potential. Tie this pin to ground for improved thermal performance.
Thermal pad		Thermal pad. Connect the pad to GND for the best possible thermal performance. See the <a href="#">Layout</a> section for more information.

## 5 Specifications

### 5.1 Absolute Maximum Ratings

over operating free-air temperature range (unless otherwise noted)<sup>(1)</sup>

		MIN	MAX	UNIT
Voltage	V <sub>IN</sub>	-0.3	42.0	V
	V <sub>OUT</sub> (for fixed device only)	-0.3	2 × V <sub>OUT(nom)</sub> or V <sub>IN</sub> + 0.3 or 15.0 (whichever is lower)	
	V <sub>OUT</sub> (for adjustable device only)	-0.3	V <sub>IN</sub> + 0.3 <sup>(2)</sup>	
	V <sub>ADJ</sub> (Feedback voltage)	-0.3	3.6	
	V <sub>EN</sub> (Enable voltage)	-0.3	42.0	
Current	I <sub>OUT</sub> (Output current)	Internally limited		mA
Temperature	T <sub>J</sub> , Operating junction	-55	150	°C
	T <sub>stg</sub> , Storage	-65	150	°C

- (1) Operation outside the *Absolute Maximum Ratings* may cause permanent device damage. *Absolute Maximum Ratings* do not imply functional operation of the device at these or any other conditions beyond those listed under *Recommended Operating Conditions*. If used outside the *Recommended Operating Conditions* but within the *Absolute Maximum Ratings*, the device may not be fully functional, and this may affect device reliability, functionality, performance, and shorten the device lifetime.
- (2) The absolute maximum rating is V<sub>IN</sub> + 0.3V or 42.0V, whichever is smaller.

### 5.2 ESD Ratings

			VALUE	UNIT	
V <sub>(ESD)</sub>	Electrostatic discharge	Human body model (HBM), per AEC Q100-002 <sup>(1)</sup>	±2000	V	
		Charged device model (CDM), per AEC Q100-011	Corner pins		±750
			Other pins		±750

- (1) AEC Q100-002 indicates that HBM stressing shall be in accordance with the ANSI/ESDA/JEDEC JS-001 specification.

### 5.3 Recommended Operating Conditions

over operating junction temperature range (unless otherwise noted)

		MIN	NOM	MAX	UNIT
V <sub>IN</sub>	Input supply voltage range	3.0		40	V
V <sub>OUT</sub>	Output voltage range (Fixed only) <sup>(1)</sup>	1.8		12	V
V <sub>OUT</sub>	Output voltage range (Adjustable only) <sup>(1)</sup>	1.2		38	V
V <sub>EN</sub>	Enable voltage range	0		40	V
I <sub>OUT</sub>	Output current	0		150	mA
C <sub>IN</sub>	Input capacitor <sup>(2)</sup>		0.47		μF
C <sub>OUT</sub>	Output capacitor <sup>(3)</sup>	2.2		100	μF
C <sub>ADJ</sub>	Parasitic ADJ to GND capacitor <sup>(4)</sup>			15	pF
C <sub>FF</sub>	Feed-forward capacitor <sup>(5)</sup>		10		nF
T <sub>J</sub>	Operating junction temperature	-40		150	°C

- (1) This output voltage range does not include device accuracy or accuracy of the feedback resistors.
- (2) An input capacitor is not required for LDO stability. However, an input capacitance with an effective value of 0.1 μF minimum is recommended to counteract the effect of source resistance and inductance, which can in some cases cause symptoms of system level instability such as ringing or oscillation, especially in the presence of load transients.
- (3) All capacitor values listed are the nominal value and the effective capacitance is assumed to derate up-to 50% of the nominal capacitor value.
- (4) The upper limit for the capacitor on the ADJ pin with respect to GND impacts the stable operation of the voltage regulator in adjustable configuration. For C<sub>ADJ</sub> capacitor higher than limits mentioned in *Recommended Operating Conditions* table, use C<sub>FF</sub> capacitor.

- (5) The  $C_{FF}$  capacitor improves transient, noise, and PSRR performance, but is not required for regulator stability. Using a higher capacitance  $C_{FF}$  is permissible but start-up time increases.

## 5.4 Thermal Information

THERMAL METRIC <sup>(1)</sup>		TPS7E81-Q1			UNIT
		DRV (WSON) <sup>(2)</sup>	DGN (HVSSOP) <sup>(2)</sup>	DBV (SOT-23) <sup>(2)</sup>	
		6 PINS	8 PINS	5 PINS	
$R_{\theta JA}$	Junction-to-ambient thermal resistance	90.2	58.5	190.9	°C/W
$R_{\theta JC(top)}$	Junction-to-case (top) thermal resistance	113.5	96.8	89.6	°C/W
$R_{\theta JB}$	Junction-to-board thermal resistance	55.7	32.4	60.0	°C/W
$\Psi_{JT}$	Junction-to-top characterization parameter	13.0	11.7	28.3	°C/W
$\Psi_{JB}$	Junction-to-board characterization parameter	55.3	32.4	59.7	°C/W
$R_{\theta JC(bot)}$	Junction-to-case (bottom) thermal resistance	30.6	12.6	n/a	°C/W

- (1) For more information about traditional and new thermal metrics, see the [Semiconductor and IC Package Thermal Metrics](#) application note.
- (2) Thermal performance results are based on the JEDEC standard of 2s2p PCB configuration. These thermal metric parameters are further improved by 35-55% based on thermally optimized PCB layout designs. See the analysis of the [Impact of board layout on LDO thermal performance](#) application note.

## 5.5 Electrical Characteristics

Over operating junction temperature range ( $T_J = -40^\circ\text{C}$  to  $+150^\circ\text{C}$ ),  $V_{IN} = 3.0\text{V}$  or  $V_{IN} = V_{OUT(nom)} + 0.5\text{V}$  (whichever is greater),  $I_{OUT} = 1\text{mA}$ ,  $V_{EN} = 2.0\text{V}$ ,  $C_{IN} = 1.0\mu\text{F}$ ,  $C_{OUT} = 2.2\mu\text{F}$ , unless otherwise noted. Typical values are at  $T_J = 25^\circ\text{C}$ .

PARAMETER		TEST CONDITIONS	MIN	TYP	MAX	UNIT
$V_{ADJ}$	ADJ (Feedback) voltage			1.2		V
$V_{UVLO+}$	Rising input supply UVLO	$V_{IN}$ rising		2.8	2.91	V
$V_{UVLO-}$	Falling input supply UVLO	$V_{IN}$ falling	2.6	2.7		V
$V_{UVLO(HYST)}$	$V_{UVLO}$ hysteresis			100		mV
$V_{OUT}$	Output voltage	$V_{IN} = V_{OUT} + 0.5\text{V}$ , $I_{OUT} = 1\text{mA}$ , $T_J = 25^\circ\text{C}$	-0.3		0.3	%
$V_{OUT}$	Output voltage	$V_{OUT} + 1.0\text{V} \leq V_{IN} \leq 40\text{V}$ , $I_{OUT} = 35\text{mA}$ , $T_J = 25^\circ\text{C}$	-0.7		0.7	%
		$V_{OUT} + 1.0\text{V} \leq V_{IN} \leq 40\text{V}$ , $I_{OUT} = 35\text{mA}$	-1.2		1.2	
		$1\text{mA} \leq I_{OUT} \leq 150\text{mA}$ , $1.0\text{V} \leq V_{IN} - V_{OUT} \leq 25\text{V}$	-1.2		1.2	
$\Delta V_{OUT}(\Delta V_{IN})$	Line regulation	$I_{OUT} = 1\text{mA}$ , $V_{OUT} + 0.5\text{V} \leq V_{IN} \leq 40\text{V}$			10	mV
$\Delta V_{OUT}(\Delta I_{OUT})$	Load regulation	$1\text{mA} \leq I_{OUT} \leq 150\text{mA}$ , $V_{IN} = V_{OUT} + 1.0\text{V}$ , $1.2\text{V} \leq V_{OUT} < 5.0\text{V}$			9	mV
		$1\text{mA} \leq I_{OUT} \leq 150\text{mA}$ , $V_{IN} = V_{OUT} + 1.0\text{V}$ , $5.0\text{V} \leq V_{OUT} < 12.0\text{V}$			18	mV
$\Delta\%V_{OUT}/\Delta I_{OUT}$	Load regulation	$1\text{mA} \leq I_{OUT} \leq 150\text{mA}$ , $V_{IN} = V_{OUT} + 1.0\text{V}$ , $12.0\text{V} \leq V_{OUT}$			1.0	%/A
$V_{DO}$	Dropout voltage	$I_{OUT} = 150\text{mA}$		0.46	0.85	V
		$I_{OUT} = 150\text{mA}$ , for adjustable		0.49	0.9	
$V_{DO}$	Dropout voltage	$I_{OUT} = 100\text{mA}$		0.3	0.55	V
		$I_{OUT} = 100\text{mA}$ , for adjustable		0.32	0.56	
$I_{LIM}$	Output current limit	$V_{OUT}$ forced at $0.9 \times V_{OUT(nom)}$ , $V_{IN} = V_{OUT(nom)} + 1.0\text{V}$	180	250	325	mA
$I_{SC}$	Short-circuit current limit	$R_{LOAD} = 20\text{m}\Omega$	10	30	55	mA
$I_{PLIMIT}$	Current limit at max headroom	$V_{IN} = 40\text{V}$ , $V_{OUT} = 1.2\text{V}$			15	mA
$V_{HEADROOM}$	Max headroom at full load	$V_{OUT} = 1.2\text{V}$			25	V
$I_{ADJ}$	ADJ (Feedback) current	$V_{IN} = 40\text{V}$			25	nA
$I_Q$	Quiescent current	$3.0\text{V} \leq V_{IN} \leq V_{OUT(nom)} - 0.2\text{V}$ , $I_{OUT} = 0\text{mA}$		12.5	25	$\mu\text{A}$
		$I_{OUT} = 0\text{mA}$		2.8	6.0	
		$V_{OUT} + 0.5\text{V} \leq V_{IN} \leq 40\text{V}$ , $I_{OUT} = 0\text{mA}$				

Over operating junction temperature range ( $T_J = -40^{\circ}\text{C}$  to  $+150^{\circ}\text{C}$ ),  $V_{IN} = 3.0\text{V}$  or  $V_{IN} = V_{OUT(nom)} + 0.5\text{V}$  (whichever is greater),  $I_{OUT} = 1\text{mA}$ ,  $V_{EN} = 2.0\text{V}$ ,  $C_{IN} = 1.0\mu\text{F}$ ,  $C_{OUT} = 2.2\mu\text{F}$ , unless otherwise noted. Typical values are at  $T_J = 25^{\circ}\text{C}$ .

PARAMETER		TEST CONDITIONS	MIN	TYP	MAX	UNIT
$I_{GND}$	Ground current	$I_{OUT} = 1\text{mA}$		16.5	25	$\mu\text{A}$
$I_{GND}$	Ground current	$V_{IN} = V_{OUT} + 1.0\text{V}$ , $I_{OUT} = 150\text{mA}$			370	$\mu\text{A}$
$I_{SHUTDOWN}$	Shutdown current	$V_{EN} = 0\text{V}$ , $T_J = 25^{\circ}\text{C}$		0.45		$\mu\text{A}$
		$V_{OUT} + 0.5\text{V} \leq V_{IN} \leq 40\text{V}$ , $V_{EN} = 0\text{V}$			1.5	
$T_{start-up}$	Start-up time	$V_{IN}$ , $V_{EN}$ tied together, $V_{IN}$ ramped to $V_{OUT(nom)} + 0.5\text{V}$ , $I_{OUT} = 0\text{mA}$		500		$\mu\text{s}$
$I_{EN}$	EN pin current	$0\text{V} \leq V_{EN} \leq 40\text{V}$ , $V_{IN}$ and $V_{EN}$ tied together			0.3	$\mu\text{A}$
		$0\text{V} \leq V_{IN} \leq 40\text{V}$ , $V_{EN} = 0\text{V}$		-0.5		
$V_{IL(EN)}$	EN pin low-level input voltage (disable device)				0.46	V
$V_{IH(EN)}$	EN pin high-level input voltage (enable device)		1.1			
$V_{HYST(EN)}$	EN pin hysteresis (enable device)			0.13		V
PSRR	Power-supply ripple rejection	$V_{IN} - V_{OUT} = 2.0\text{V}$ , $I_{OUT} = 150\text{mA}$ , $f = 100\text{kHz}$		45		dB
$V_n$	Output noise voltage	Bandwidth = 10Hz to 100kHz, $V_{IN} - V_{OUT} = 2.0\text{V}$ , $I_{OUT} = 150\text{mA}$		650		$\mu\text{VRMS}$
$T_{sd+}$	Thermal shutdown temperature increasing	Shutdown, temperature increasing	163			$^{\circ}\text{C}$
$T_{sd-}$	Thermal shutdown temperature decreasing	Reset, temperature decreasing	150			$^{\circ}\text{C}$
$R_{Discharge}$	Output discharge resistance	$V_{IN} = 3.0\text{V}$ , $V_{EN} = 0\text{V}$ , $T_J = 25^{\circ}\text{C}$ , $I_{OUT} = 1\text{mA}$		780		$\Omega$
$I_{SINK}$	Sink current on output	$V_{OUT} = V_{OUT(nom)} \times 1.05$ , $T_J = 25^{\circ}\text{C}$		3.3		mA

### 5.6 Typical Characteristics

At operating junction temperature  $T_J = 25^\circ\text{C}$ ,  $V_{IN} = 3.0\text{V}$  or  $V_{IN} = V_{OUT}(\text{nom}) + 0.5\text{V}$  (whichever is greater),  $V_{EN} = 2.0\text{V}$ ,  $C_{IN} = 1\mu\text{F}$ ,  $C_{OUT} = 2.2\mu\text{F}$ , and  $I_{OUT} = 1\text{mA}$  (unless otherwise noted)

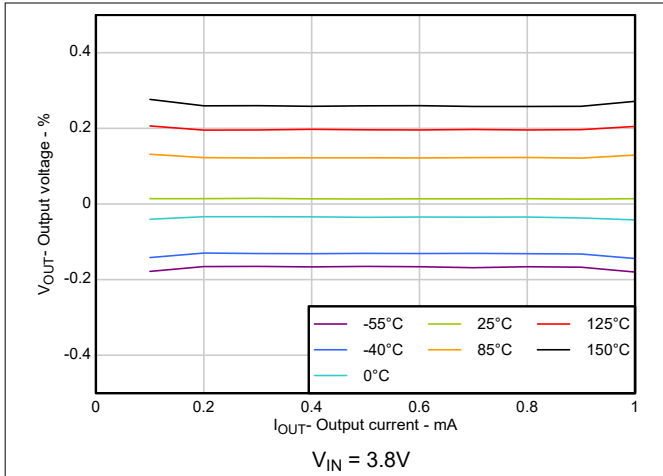

Figure 5-1.  $V_{OUT}$  Accuracy vs  $I_{OUT}$

$V_{IN} = 3.8\text{V}$

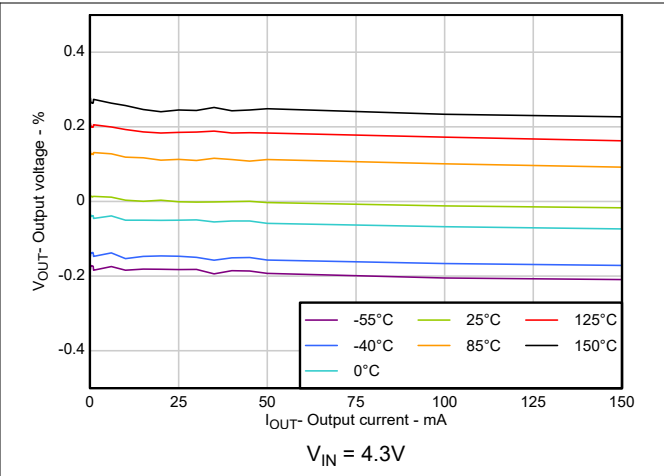

Figure 5-2.  $V_{OUT}$  Accuracy vs  $I_{OUT}$

$V_{IN} = 4.3\text{V}$

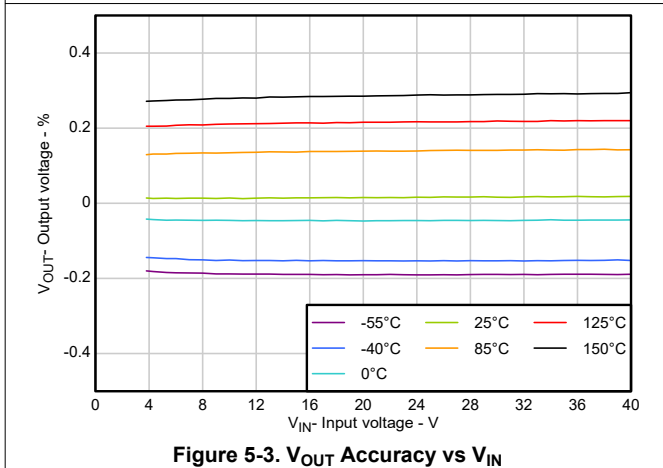

Figure 5-3.  $V_{OUT}$  Accuracy vs  $V_{IN}$

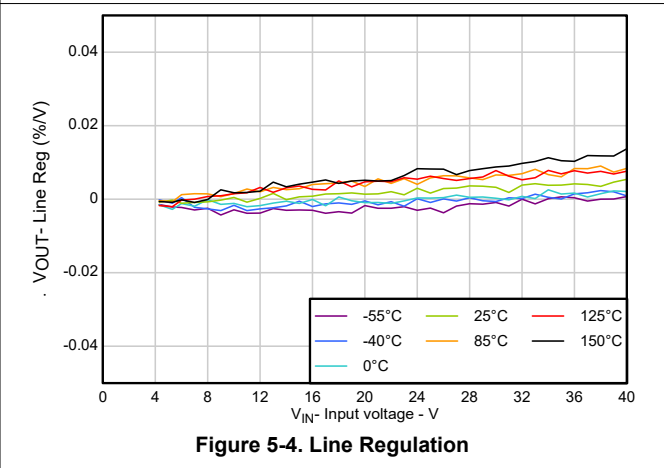

Figure 5-4. Line Regulation

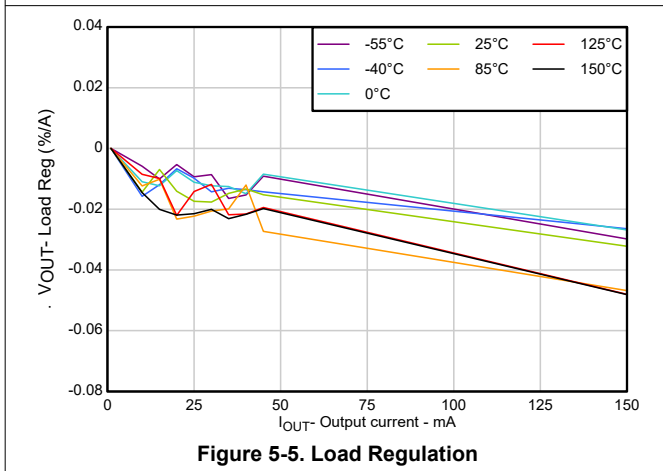

Figure 5-5. Load Regulation

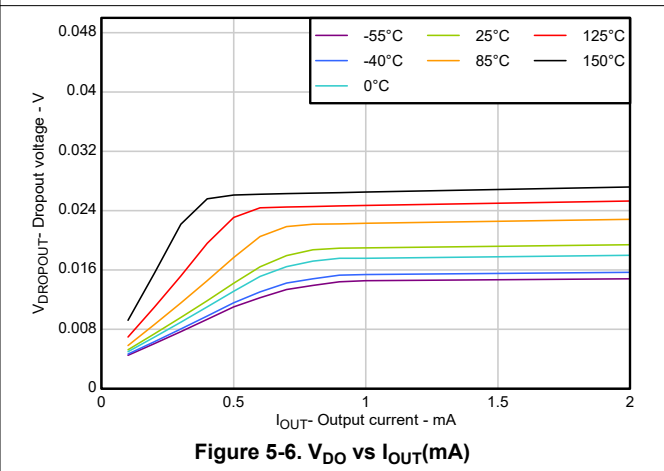
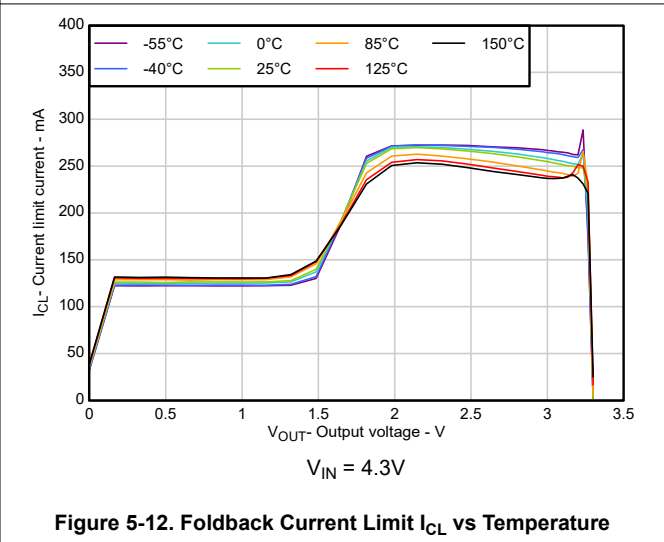
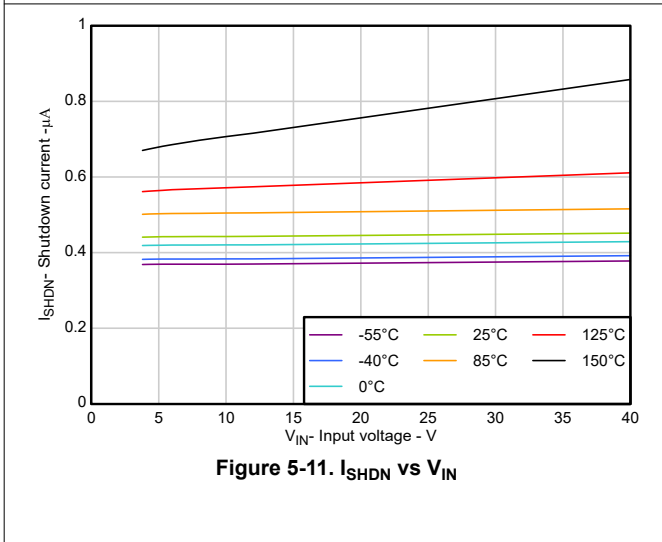
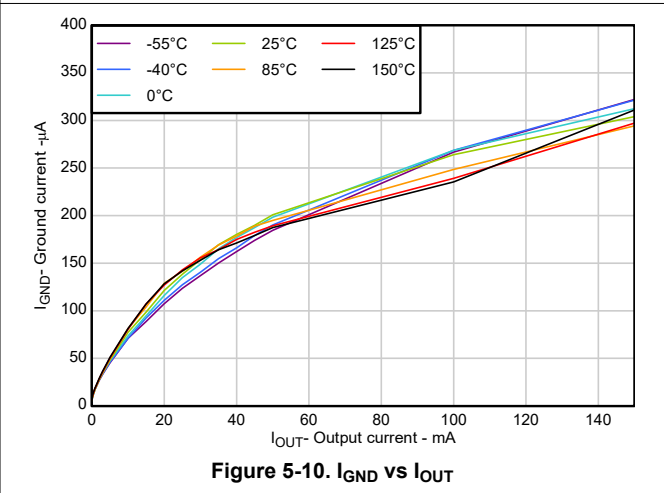
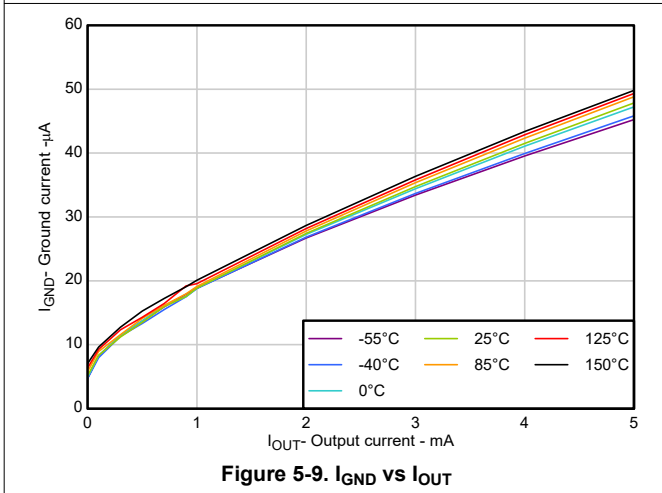
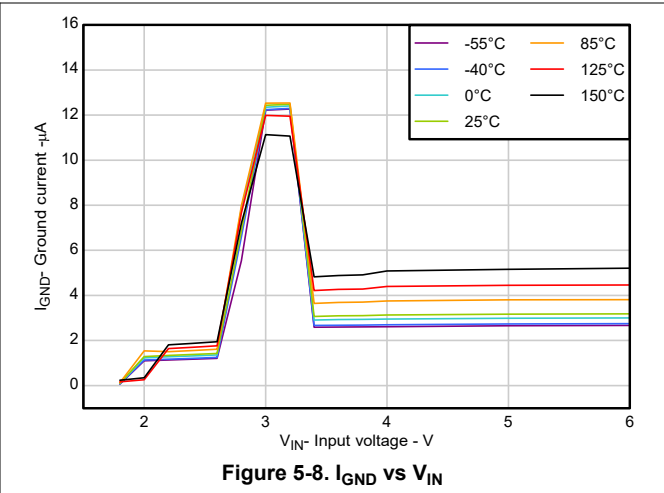
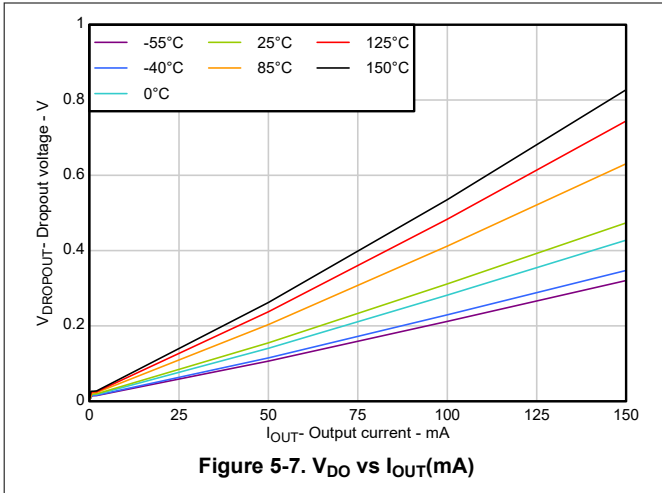

Figure 5-6.  $V_{DO}$  vs  $I_{OUT}(\text{mA})$

### 5.6 Typical Characteristics (continued)

At operating junction temperature  $T_J = 25^\circ\text{C}$ ,  $V_{IN} = 3.0\text{V}$  or  $V_{IN} = V_{OUT}(\text{nom}) + 0.5\text{V}$  (whichever is greater),  $V_{EN} = 2.0\text{V}$ ,  $C_{IN} = 1\mu\text{F}$ ,  $C_{OUT} = 2.2\mu\text{F}$ , and  $I_{OUT} = 1\text{mA}$  (unless otherwise noted)



### 5.6 Typical Characteristics (continued)

At operating junction temperature  $T_J = 25^\circ\text{C}$ ,  $V_{IN} = 3.0\text{V}$  or  $V_{IN} = V_{OUT}(\text{nom}) + 0.5\text{V}$  (whichever is greater),  $V_{EN} = 2.0\text{V}$ ,  $C_{IN} = 1\mu\text{F}$ ,  $C_{OUT} = 2.2\mu\text{F}$ , and  $I_{OUT} = 1\text{mA}$  (unless otherwise noted)

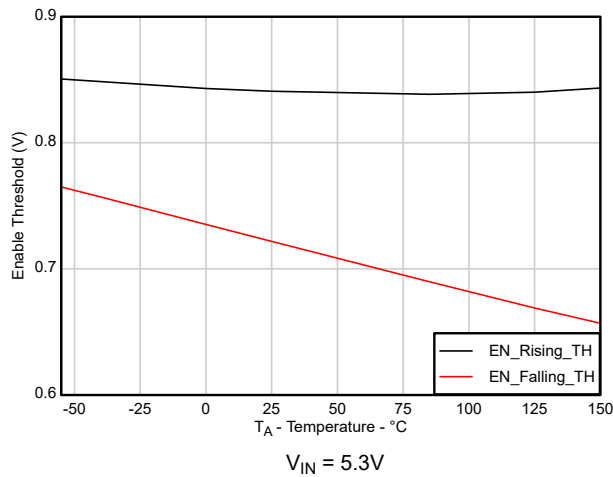

Figure 5-13. EN Threshold  $V_{IH(EN)}/V_{IL(EN)}$  vs Temperature

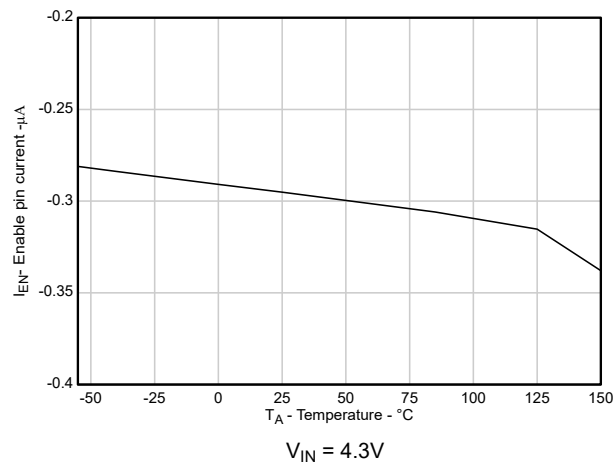

Figure 5-15. EN Leakage Current  $I_{EN}$  vs Temperature

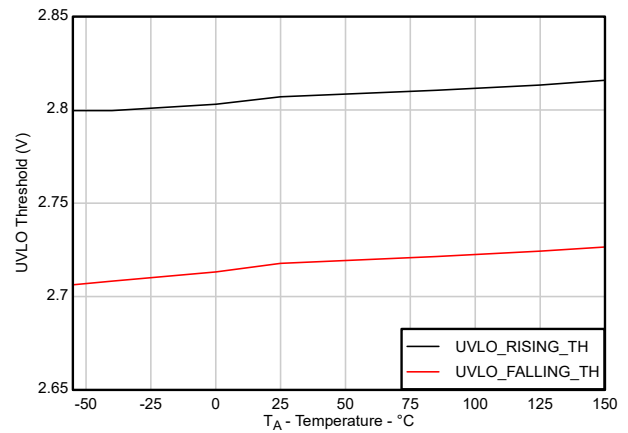

Figure 5-14. UVLO Threshold ( $V_{UVLO+}/V_{UVLO-}$ ) vs Temperature

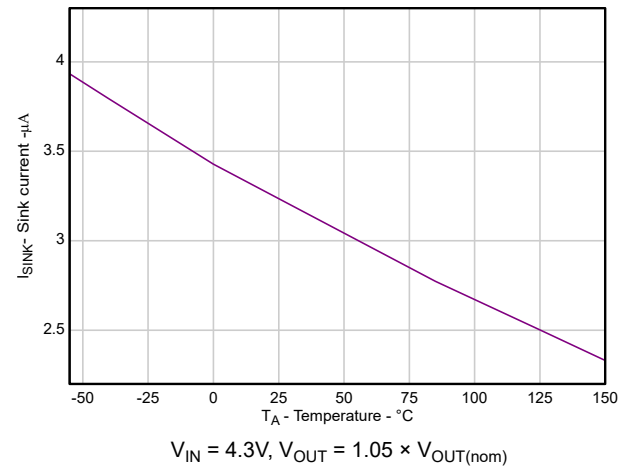
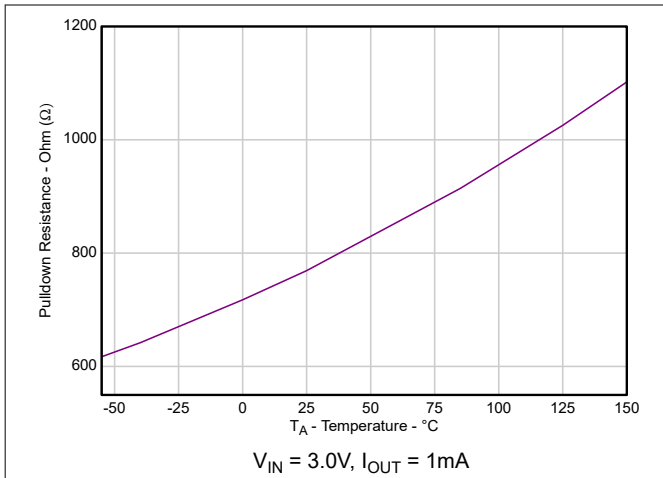

Figure 5-16. Sink Current on Output ( $I_{SINK}$ ) vs Temperature

### 5.6 Typical Characteristics (continued)

At operating junction temperature  $T_J = 25^\circ\text{C}$ ,  $V_{IN} = 3.0\text{V}$  or  $V_{IN} = V_{OUT}(\text{nom}) + 0.5\text{V}$  (whichever is greater),  $V_{EN} = 2.0\text{V}$ ,  $C_{IN} = 1\mu\text{F}$ ,  $C_{OUT} = 2.2\mu\text{F}$ , and  $I_{OUT} = 1\text{mA}$  (unless otherwise noted)



**Figure 5-17. Pull-down Resistance on Output ( $R_{\text{Discharge}}$ ) vs Temperature**

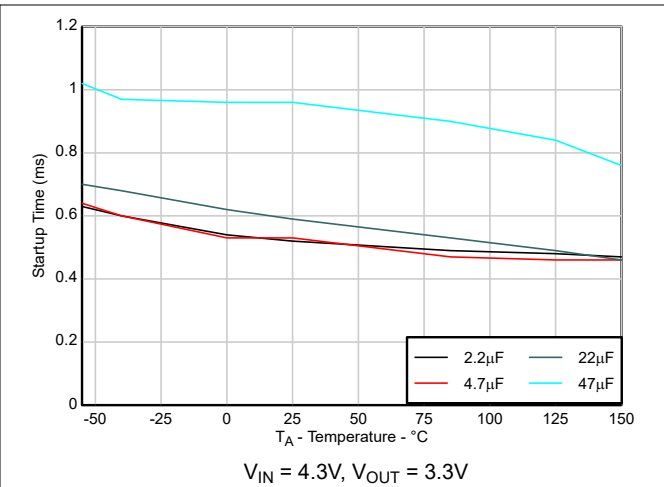

**Figure 5-18. Start-up Time vs  $C_{\text{OUT}}$**

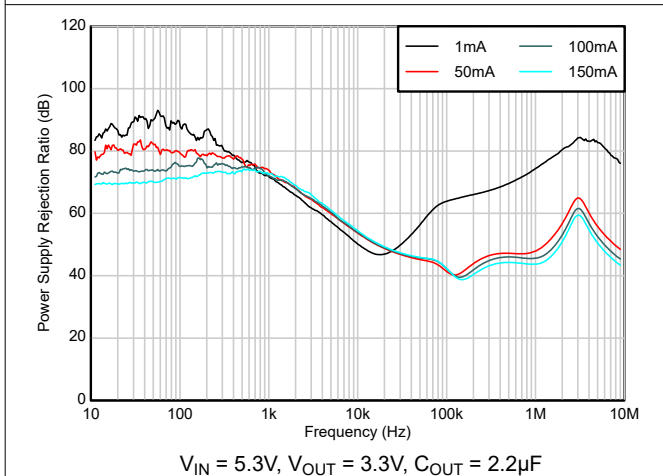

**Figure 5-19. PSRR vs  $I_{\text{OUT}}$**

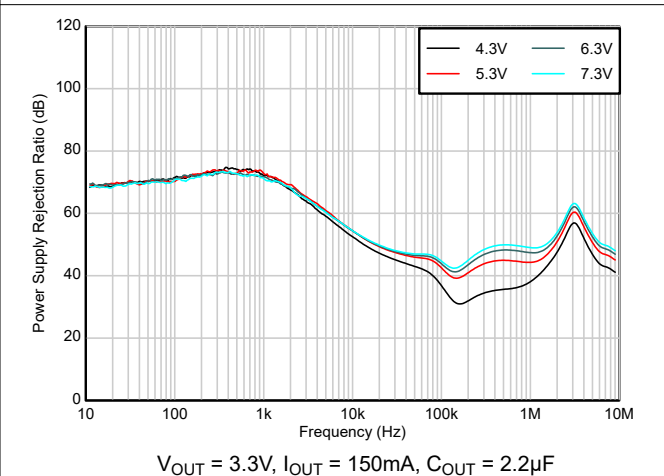

**Figure 5-20. PSRR vs  $V_{\text{IN}}$**

### 5.6 Typical Characteristics (continued)

At operating junction temperature  $T_J = 25^\circ\text{C}$ ,  $V_{IN} = 3.0\text{V}$  or  $V_{IN} = V_{OUT}(\text{nom}) + 0.5\text{V}$  (whichever is greater),  $V_{EN} = 2.0\text{V}$ ,  $C_{IN} = 1\mu\text{F}$ ,  $C_{OUT} = 2.2\mu\text{F}$ , and  $I_{OUT} = 1\text{mA}$  (unless otherwise noted)

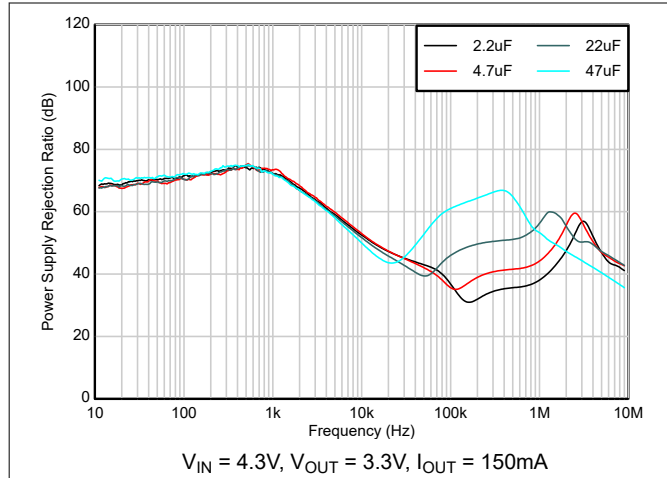

Figure 5-21. PSRR vs  $C_{OUT}$

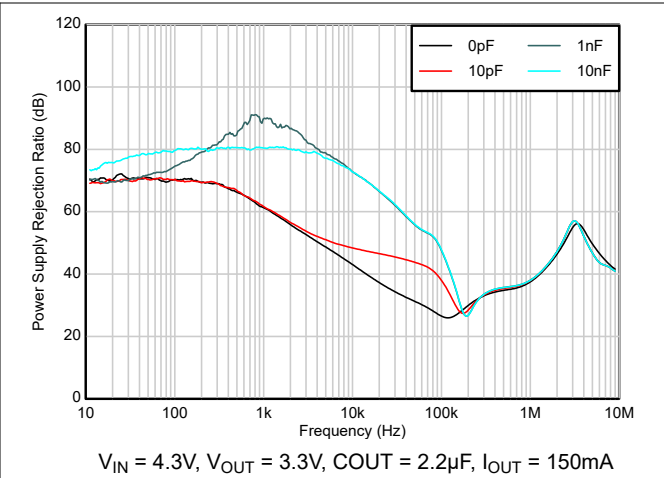

Figure 5-22. PSRR vs  $C_{FF}$

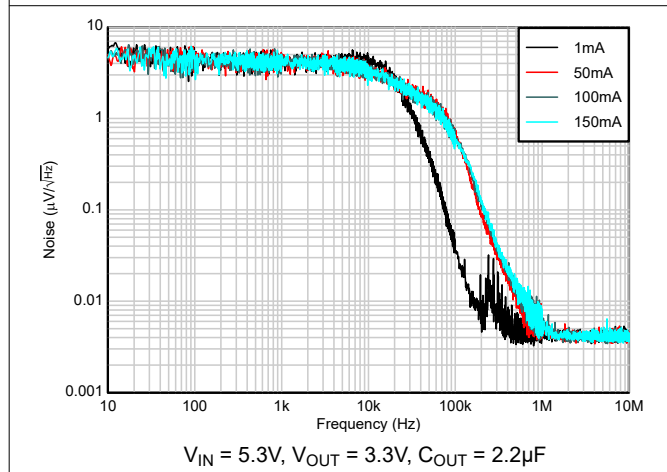

Figure 5-23. Noise vs  $I_{OUT}$

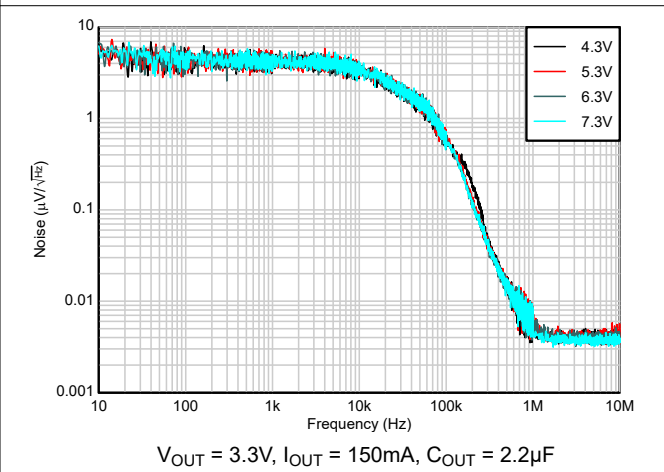

Figure 5-24. Noise vs  $V_{IN}$

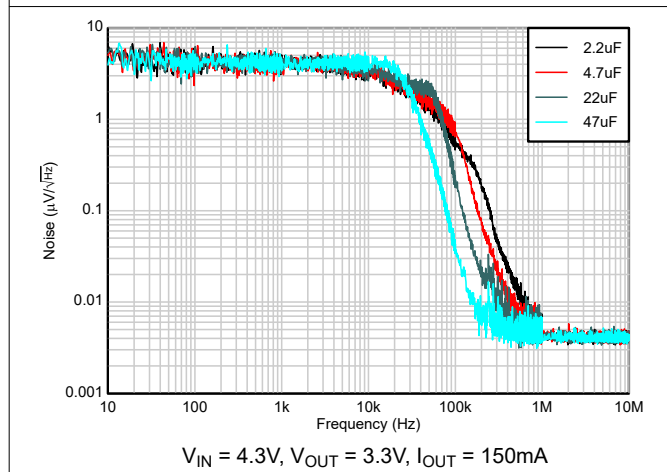

Figure 5-25. Noise vs  $C_{OUT}$

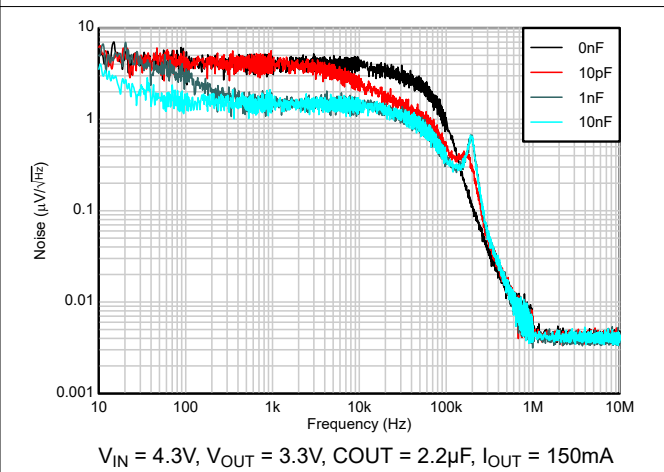
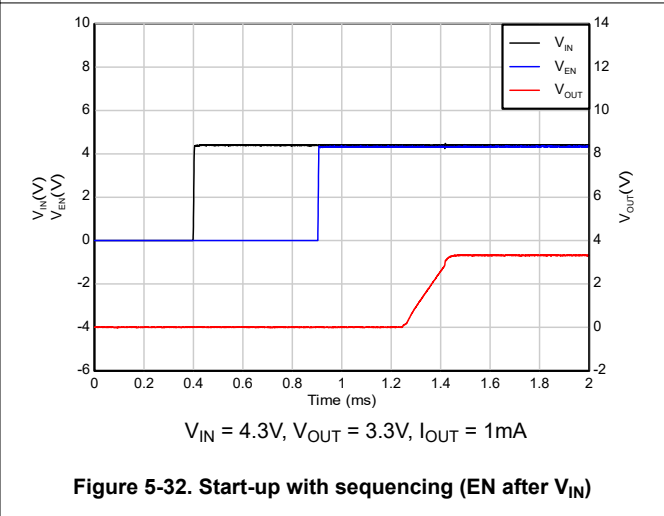
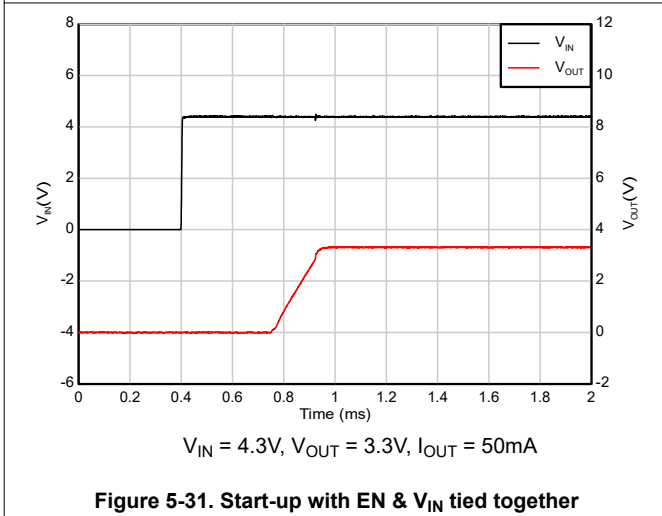
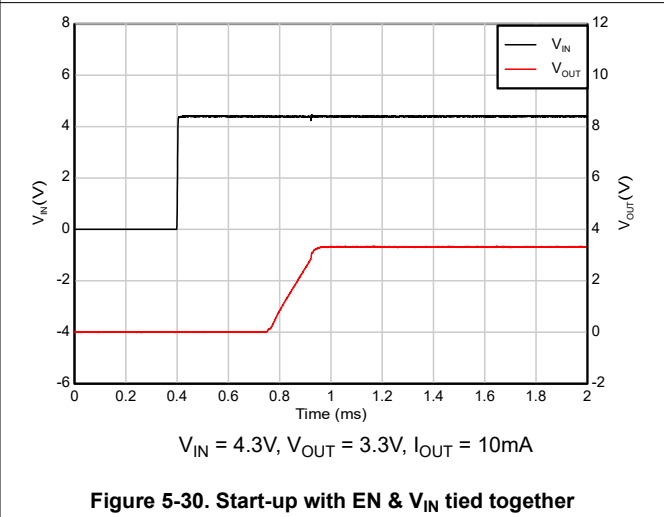
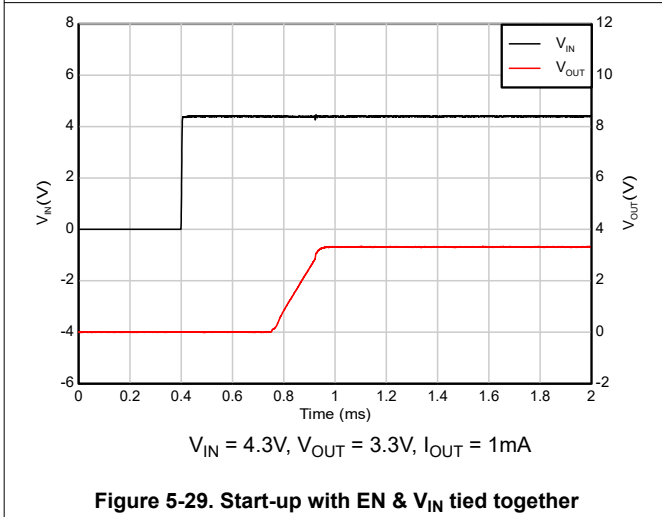
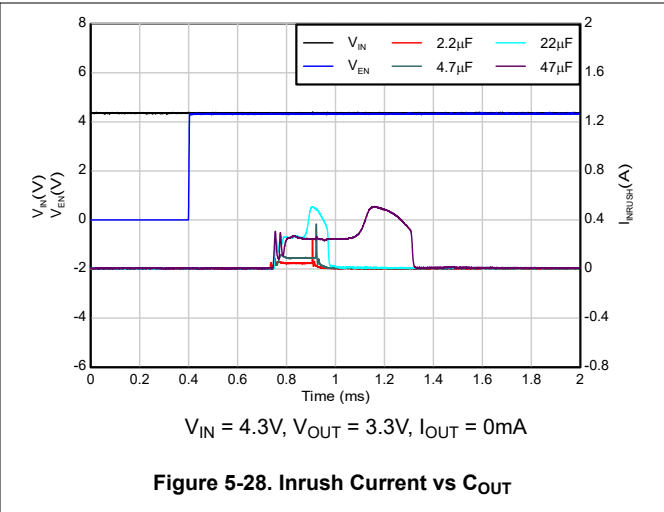
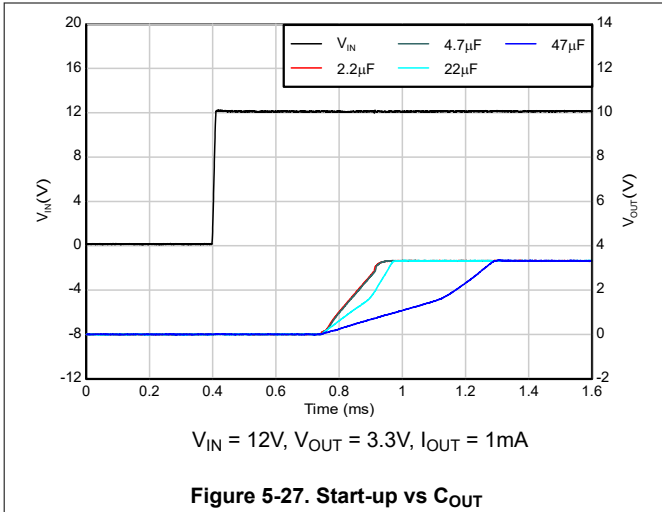

Figure 5-26. Noise vs  $C_{FF}$

### 5.6 Typical Characteristics (continued)

At operating junction temperature  $T_J = 25^\circ\text{C}$ ,  $V_{IN} = 3.0\text{V}$  or  $V_{IN} = V_{OUT}(\text{nom}) + 0.5\text{V}$  (whichever is greater),  $V_{EN} = 2.0\text{V}$ ,  $C_{IN} = 1\mu\text{F}$ ,  $C_{OUT} = 2.2\mu\text{F}$ , and  $I_{OUT} = 1\text{mA}$  (unless otherwise noted)



## 5.6 Typical Characteristics (continued)

At operating junction temperature  $T_J = 25^\circ\text{C}$ ,  $V_{IN} = 3.0\text{V}$  or  $V_{IN} = V_{OUT}(\text{nom}) + 0.5\text{V}$  (whichever is greater),  $V_{EN} = 2.0\text{V}$ ,  $C_{IN} = 1\mu\text{F}$ ,  $C_{OUT} = 2.2\mu\text{F}$ , and  $I_{OUT} = 1\text{mA}$  (unless otherwise noted)

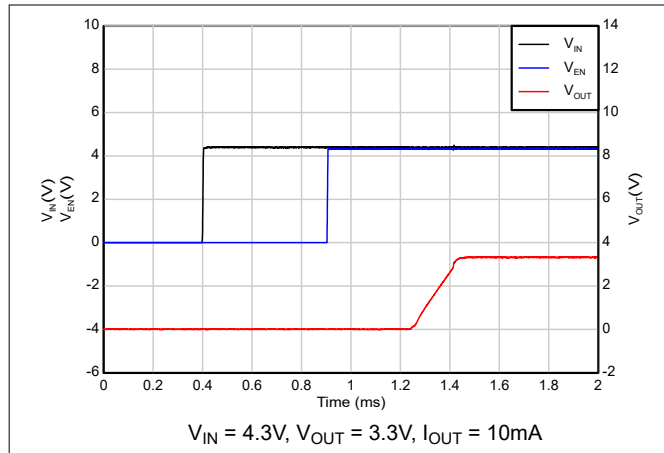

**Figure 5-33. Start-up with sequencing (EN after  $V_{IN}$ )**

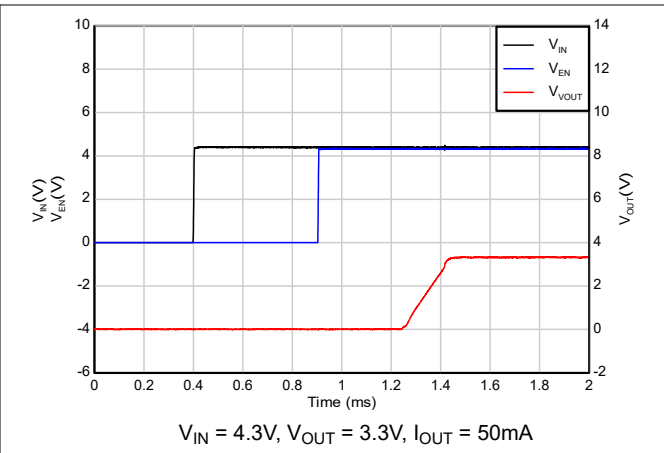

**Figure 5-34. Start-up with sequencing (EN after  $V_{IN}$ )**

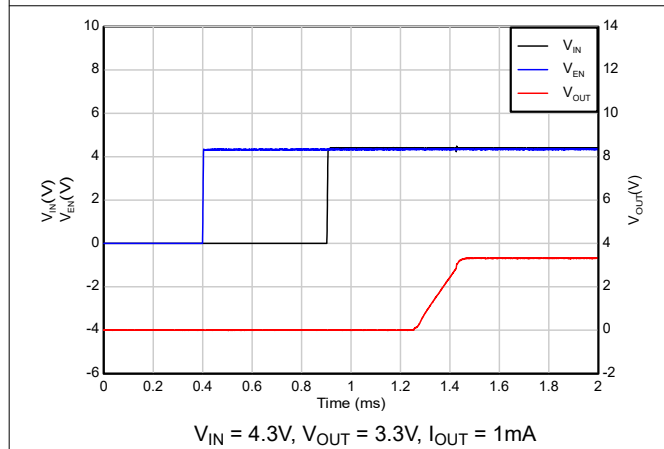

**Figure 5-35. Start-up with sequencing ( $V_{IN}$  after EN)**

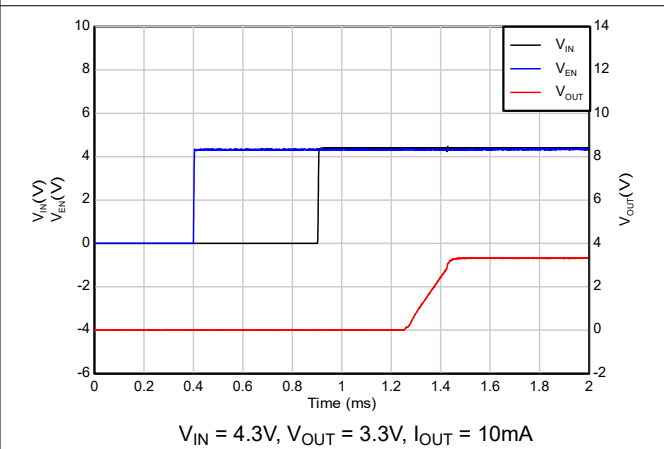

**Figure 5-36. Start-up with sequencing ( $V_{IN}$  after EN)**

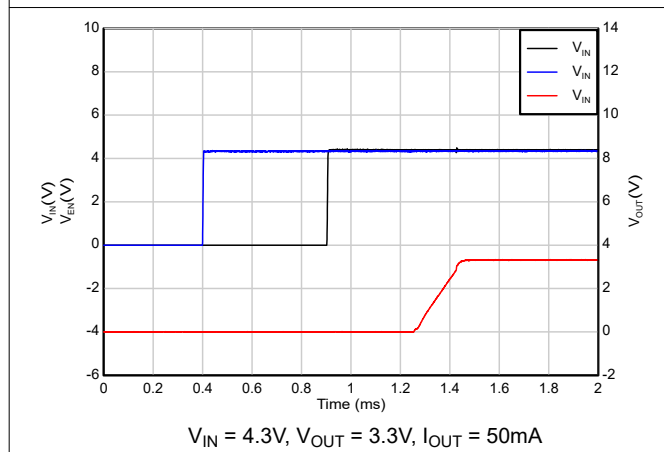

**Figure 5-37. Start-up with sequencing ( $V_{IN}$  after EN)**

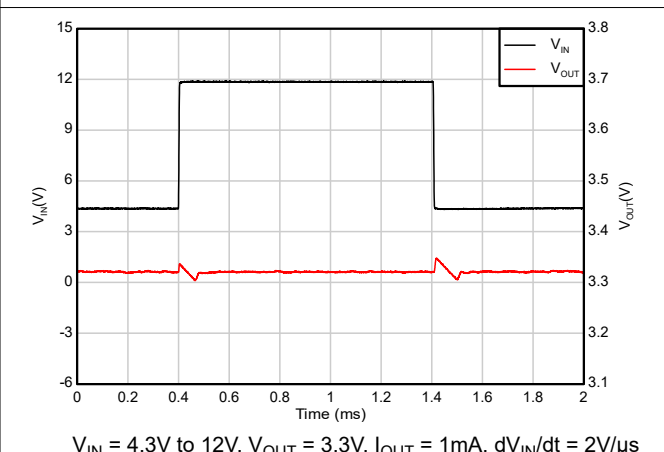

**Figure 5-38. Line Transient (4.3V to 12V)**

### 5.6 Typical Characteristics (continued)

At operating junction temperature  $T_J = 25^\circ\text{C}$ ,  $V_{IN} = 3.0\text{V}$  or  $V_{IN} = V_{OUT}(\text{nom}) + 0.5\text{V}$  (whichever is greater),  $V_{EN} = 2.0\text{V}$ ,  $C_{IN} = 1\mu\text{F}$ ,  $C_{OUT} = 2.2\mu\text{F}$ , and  $I_{OUT} = 1\text{mA}$  (unless otherwise noted)

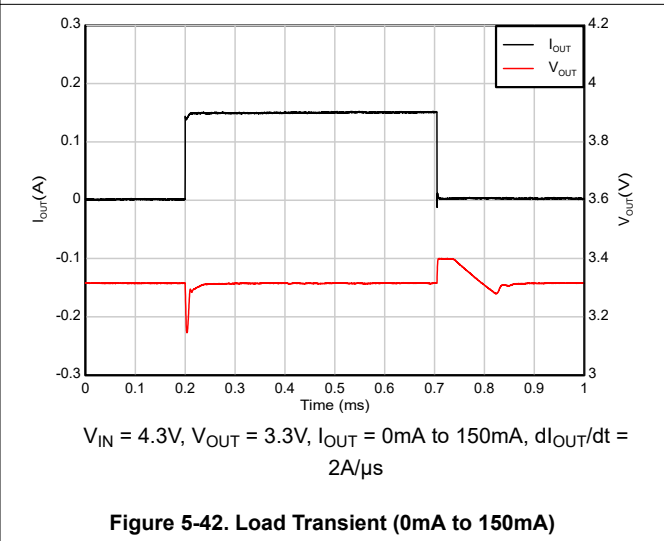
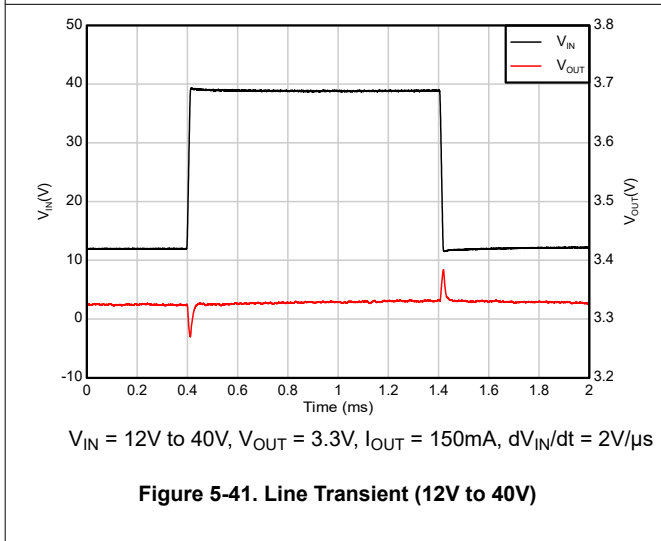
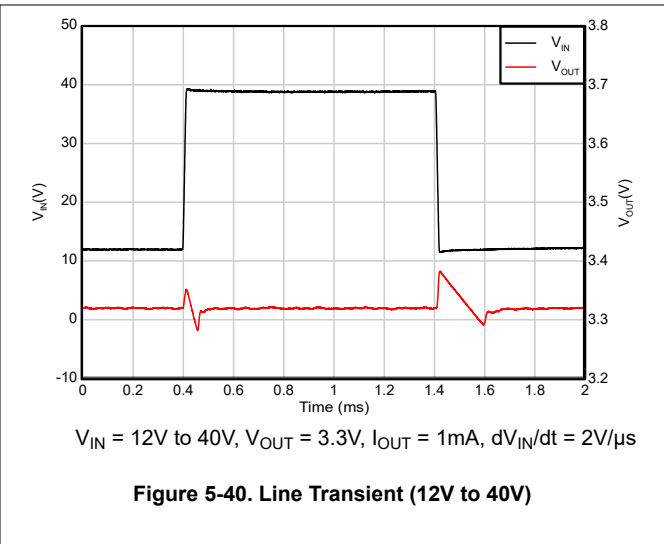
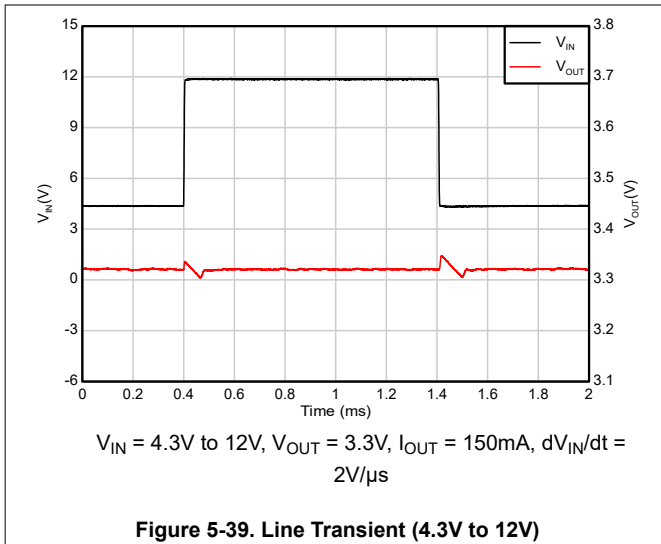

### 5.6 Typical Characteristics (continued)

At operating junction temperature  $T_J = 25^\circ\text{C}$ ,  $V_{IN} = 3.0\text{V}$  or  $V_{IN} = V_{OUT}(\text{nom}) + 0.5\text{V}$  (whichever is greater),  $V_{EN} = 2.0\text{V}$ ,  $C_{IN} = 1\mu\text{F}$ ,  $C_{OUT} = 2.2\mu\text{F}$ , and  $I_{OUT} = 1\text{mA}$  (unless otherwise noted)

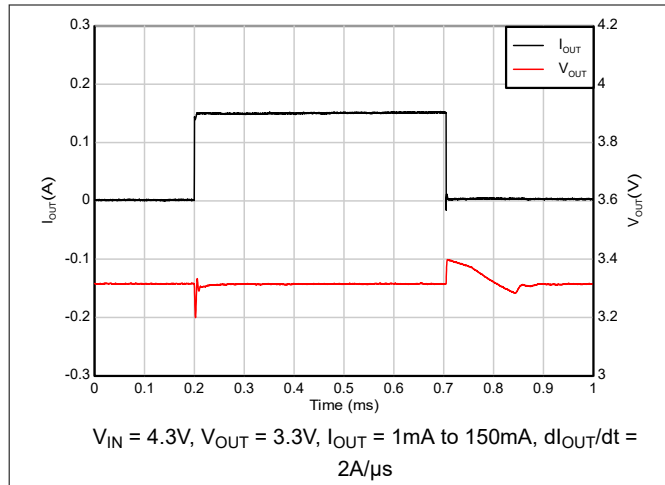

Figure 5-43. Load Transient (1mA to 150mA)

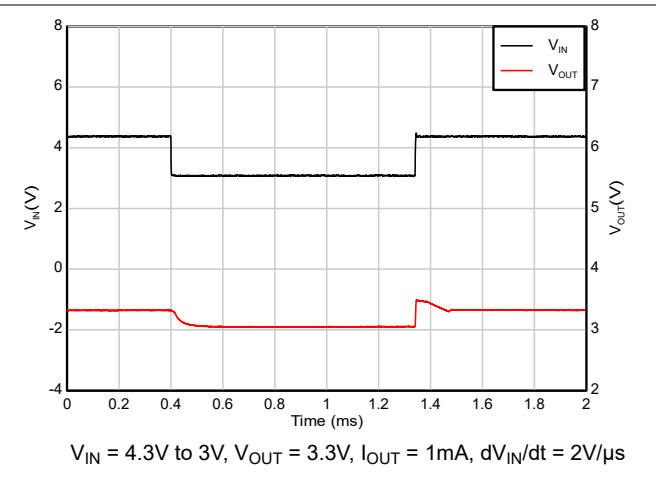

Figure 5-44. Dropout Recovery (4.3V to 3V)

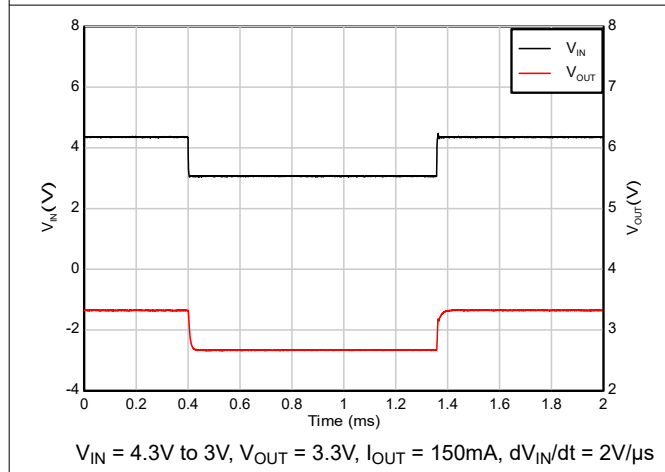

Figure 5-45. Dropout Recovery (4.3V to 3V)

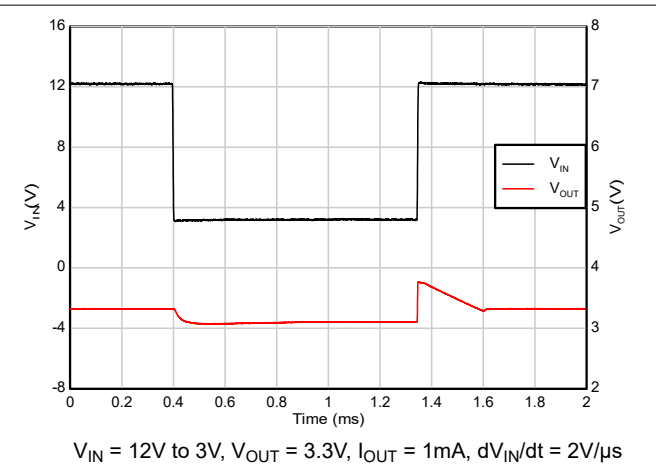

Figure 5-46. Dropout Recovery (12V to 3V)

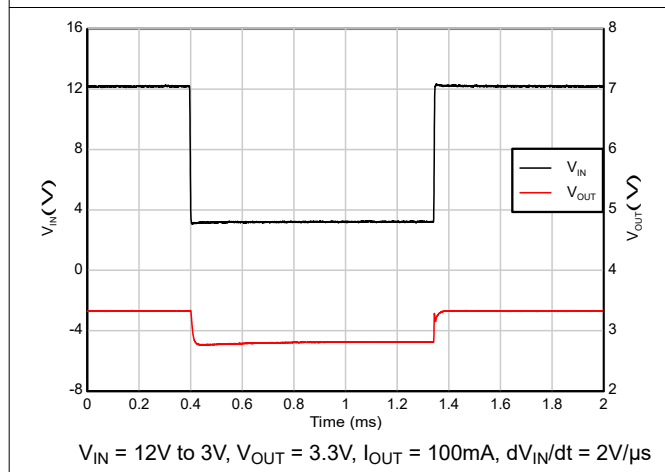

Figure 5-47. Dropout Recovery (12V to 3V)

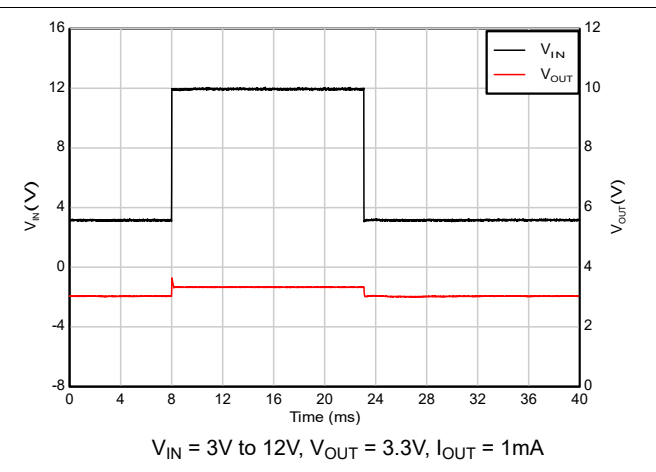
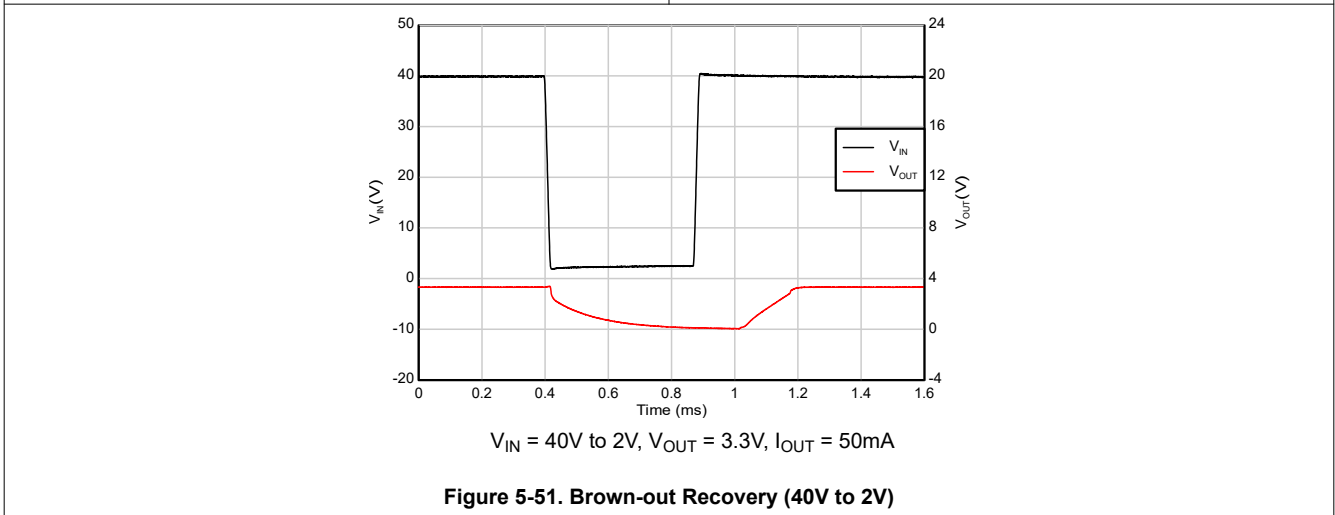
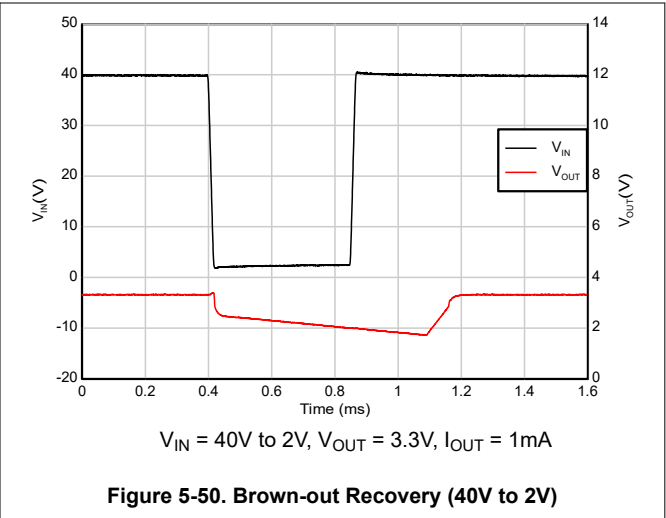
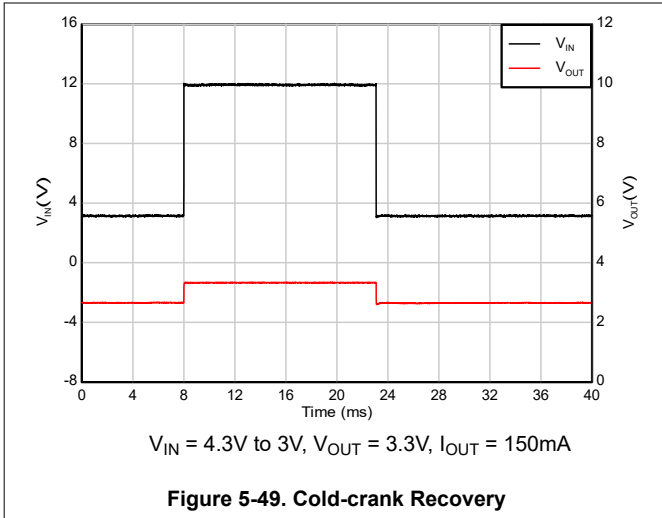

Figure 5-48. Cold-crank Recovery

### 5.6 Typical Characteristics (continued)

At operating junction temperature  $T_J = 25^\circ\text{C}$ ,  $V_{IN} = 3.0\text{V}$  or  $V_{IN} = V_{OUT}(\text{nom}) + 0.5\text{V}$  (whichever is greater),  $V_{EN} = 2.0\text{V}$ ,  $C_{IN} = 1\mu\text{F}$ ,  $C_{OUT} = 2.2\mu\text{F}$ , and  $I_{OUT} = 1\text{mA}$  (unless otherwise noted)



## 6 Detailed Description

### 6.1 Overview

The TPS7E81-Q1 low-dropout regulator (LDO) consumes ultra-low quiescent current ( $2.8\mu\text{A}$  typ) at no-load current. The device offers a wide input voltage range (3.0V to 40V) and wide output range (1.2V to 38V, in adjustable configuration) and supports up-to 150mA of load current. The device is stable with the output capacitor range of  $2.2\mu\text{F}$  to  $100\mu\text{F}$ .

The low quiescent current across the complete load current range and controlled  $I_{\text{Q}}$  in no-load dropout situations makes the TPS7E81-Q1 designed for powering battery-operated applications. The TPS7E81-Q1 has an internal soft-start mechanism that provides a uniform start-up with controlled inrush current. This LDO also has over-current (fold-back), over-power and thermal protection during a load-short or fault condition on the output for better reliability.

### 6.2 Functional Block Diagrams

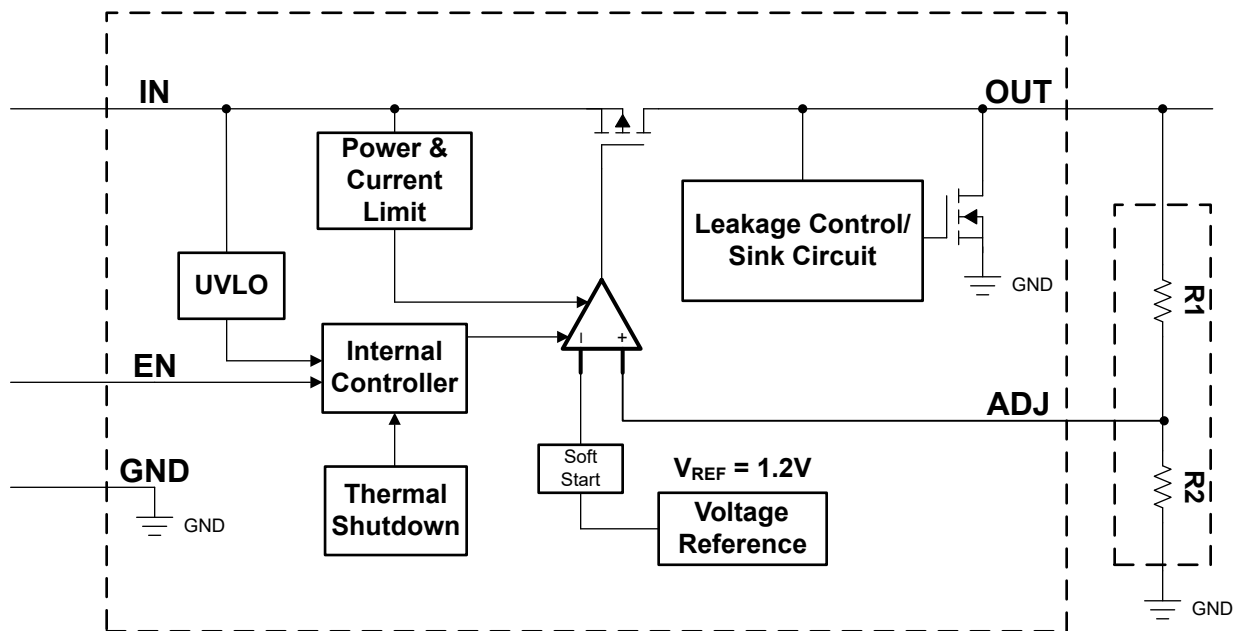

Figure 6-1. Functional Block Diagram: Adjustable Version

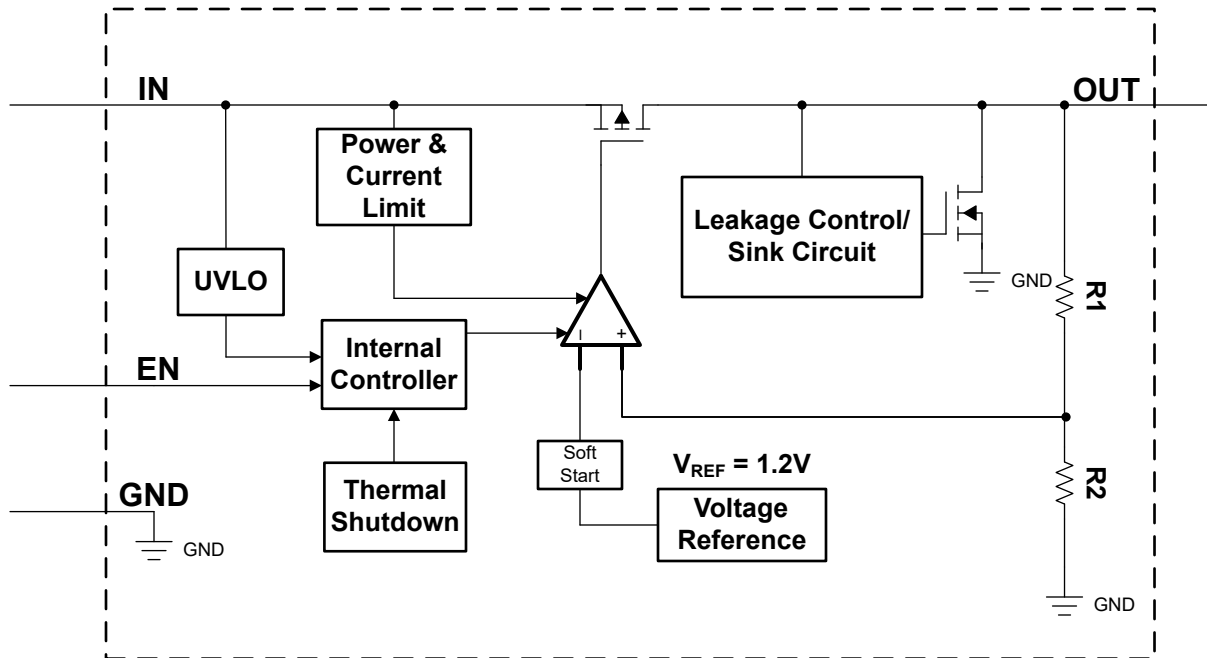

Figure 6-2. Functional Block Diagram: Fixed Version

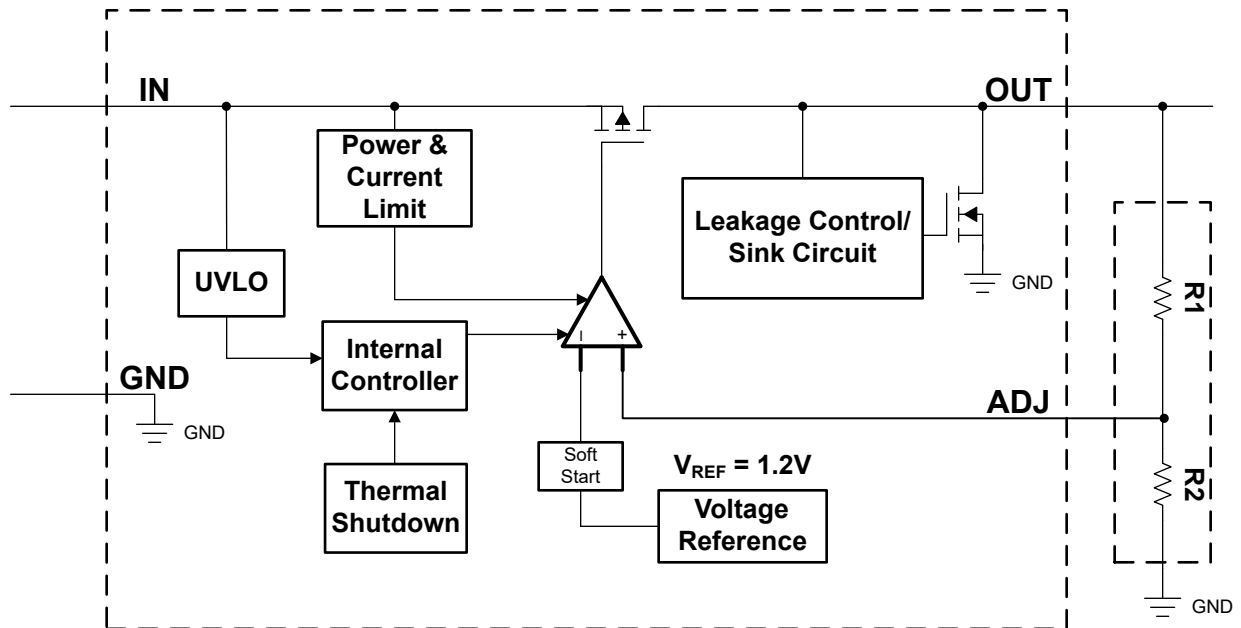

Figure 6-3. Functional Block Diagram: Adjustable Version (Without EN Functionality)

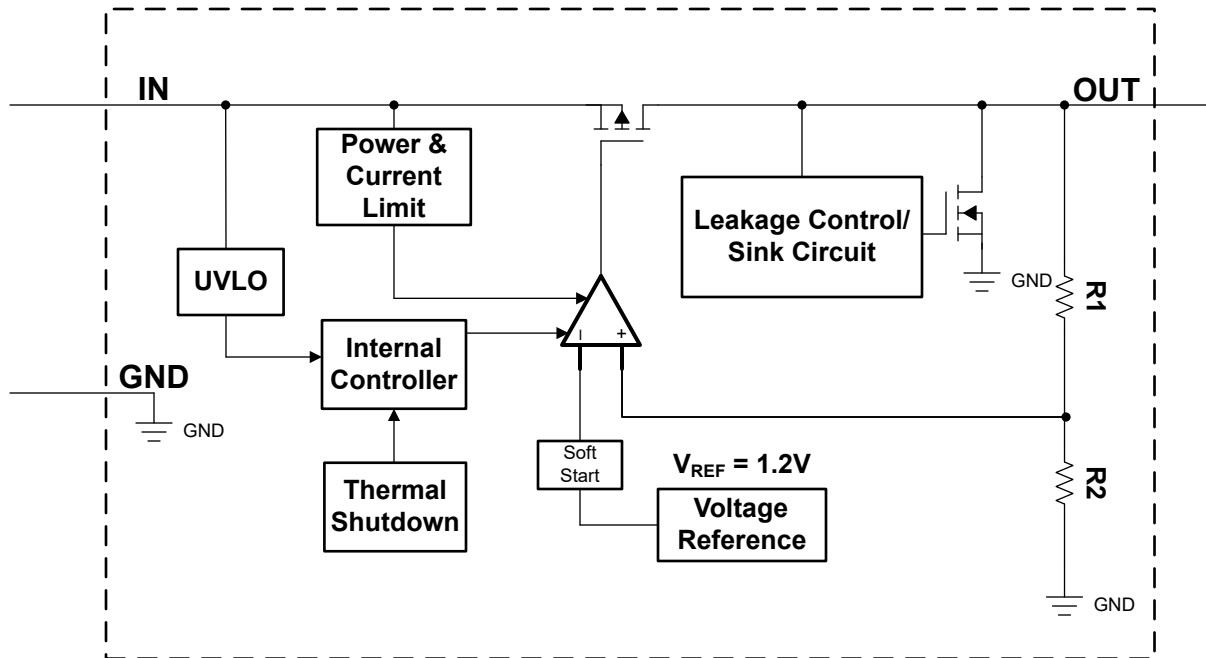

Figure 6-4. Functional Block Diagram: Fixed Version (Without EN Functionality)

## 6.3 Feature Description

### 6.3.1 Enable (EN)

The enable pin for the device is an active-high pin. The output voltage is enabled when the voltage of the enable pin is greater than the high-level input voltage ( $V_{IH}$ ) of the EN pin and disabled when the enable pin voltage is less than the low-level input voltage ( $V_{IL}$ ) of the EN pin. High and low thresholds are listed in the [Electrical Characteristics](#). If independent control of the output voltage is not needed, connect the enable pin to the input of the device.

The EN pin also has a weak internal pull-up and the EN pin can be left floating to enable the device. The internal pull-up current on the EN pin is captured in the [Electrical Characteristics](#) table as Enable pull-up current. However, care must be taken to verify that pin leakage (from board pollution or some other source) does not inadvertently pull this pin low. Leakage must be restricted to 25nA or less to avoid unintentional disabling of the device.

### 6.3.2 Dropout Voltage ( $V_{DO}$ )

Dropout voltage ( $V_{DO}$ ) is defined as  $V_{IN} - V_{OUT}$  at the rated output current ( $I_{RATED}$ ), where the pass transistor is fully on.  $V_{IN} - V_{OUT}$  is input voltage minus the output voltage.  $I_{RATED}$  is the maximum  $I_{OUT}$  listed in the [Recommended Operating Conditions](#) table. In dropout operation, the pass transistor is in the ohmic or triode region of operation, and acts as a switch. Dropout voltage indirectly specifies a minimum input voltage greater than the nominal programmed output voltage where the output voltage is expected to stay in regulation. If the input voltage falls to less than the value required to maintain output regulation, then the output voltage falls as well.

For a CMOS regulator, the dropout voltage is determined by the drain-source, on-state resistance ( $R_{DS(ON)}$ ) of the pass transistor. Therefore, if the linear regulator operates at less than the rated current, the dropout voltage for that current scales accordingly. [Equation 1](#) calculates the  $R_{DS(ON)}$  of the device.

$$R_{DS(ON)} = \frac{V_{DO}}{I_{RATED}} \quad (1)$$

### 6.3.3 Undervoltage Lockout

The device has an independent undervoltage lockout (UVLO) circuit that monitors the input voltage, allowing a controlled and consistent turn on and off of the output voltage. To prevent the device from turning off if the input drops during turn on, the UVLO has in-built hysteresis. The UVLO limits are specified in the [Electrical Characteristics](#) table.

### 6.3.4 Thermal Shutdown

The device contains a thermal shutdown protection circuit to disable the device when the junction temperature ( $T_J$ ) of the pass transistor rises to  $T_{SD+}$  (typical). Thermal shutdown hysteresis verifies that the device resets (turns on) when the temperature falls to  $T_{SD-}$  (typical).

The thermal time-constant of the semiconductor die is fairly short, thus the device can cycle on and off when thermal shutdown is reached until power dissipation is reduced. Power dissipation during startup can be high from large  $V_{IN} - V_{OUT}$  voltage drops across the device or from high inrush currents charging large output capacitors. Under some conditions, the thermal shutdown protection disables the device before startup completes.

For reliable operation, limit the junction temperature to the maximum listed in the [Recommended Operating Conditions](#) table. Operation above this maximum temperature causes the device to exceed the operational specifications. Although the internal protection circuitry of the device is designed to protect against thermal overall conditions, this circuitry is not intended to replace proper heat sinking. Continuously running the device into thermal shutdown or above the maximum recommended junction temperature reduces long-term reliability.

### 6.3.5 Foldback Current Limit

The device has an internal current limit circuit that protects the regulator during transient high-load current faults or shorting events. The current limit is a hybrid brickwall-foldback scheme. The current limit transitions from a brickwall scheme to a foldback scheme at the foldback voltage ( $V_{FOLDBACK}$ ). In a high-load current fault with the output voltage above  $V_{FOLDBACK}$ , the brickwall scheme limits the output current to the current limit ( $I_{CL}$ ). When the voltage drops below  $V_{FOLDBACK}$ , a foldback current limit activates that scales back the current as the output voltage approaches GND. When the output is shorted, the device supplies a typical current called the short-circuit current limit ( $I_{SC}$ ).  $I_{CL}$  and  $I_{SC}$  are listed in the [Electrical Characteristics](#) table.

The output voltage is not regulated when the device is in current limit. When a current limit event occurs, the device begins to heat up because of the increase in power dissipation. When the device is in brickwall current limit, the pass transistor dissipates power  $[(V_{IN} - V_{OUT}) \times I_{CL}]$ . When the device output is shorted and the output is below  $V_{FOLDBACK}$ , the pass transistor dissipates power  $[(V_{IN} - V_{OUT}) \times I_{SC}]$ . If thermal shutdown is triggered, the device turns off. After the device cools down, the internal thermal shutdown circuit turns the device back on. If the output current fault condition continues, the device cycles between current limit and thermal shutdown. For more information on current limits, see the [Know Your Limits application note](#).

Figure 6-5 shows a diagram of the foldback current limit.

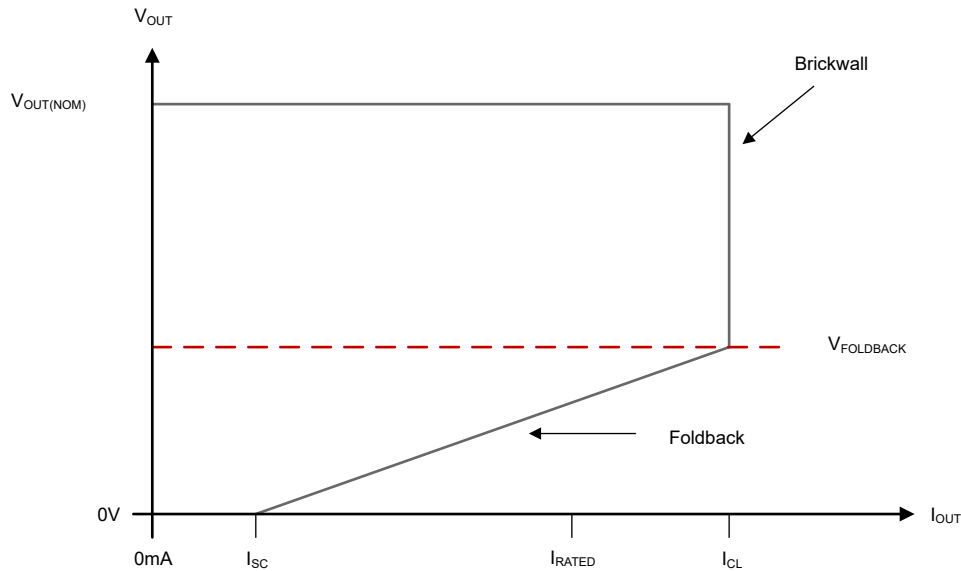

**Figure 6-5. Foldback Current Limit**

**6.3.6 Power Limit**

The device has an internal over-power limit circuit that limits the power dissipated across the LDO with-in the internal SOA (safe operating area) limits. The SOA limits for the LDO factors in safe operation for both silicon components, and bondwires used in packaging. These limits verify reliable operation of the device and prevent the device failure from overheating, breakdown, or other damaging effects.

The power dissipated ( $P_{Dissip}$ ) across the LDO is defined by voltage drop across LDO ( $V_{IN} - V_{OUT}$ ) and load current ( $I_L$ ) flowing through.

$$P_{Dissip} = (V_{IN} - V_{OUT}) \times I_{OUT} \tag{2}$$

The power limiting circuit, monitors both the voltage drop (headroom,  $V_{IN} - V_{OUT}$ ) across LDO and output load current ( $I_{OUT}$ ) flowing through. If  $P_{Dissip}$  crosses the defined SOA limits, the power limiting circuit, limits the load current ( $I_{OUT}$ ) flowing through. The output voltage is not regulated when the device is in Power limit operation. The maximum supported current ( $I_{PLIMIT}$ ) at full headroom ( $V_{IN} - V_{OUT} = 40V$ ) and Max supported headroom ( $V_{PHEADROOM}$ ) at full load current are captured in [Electrical Characteristics](#).

Figure 6-6 shows a diagram of the power limiting.

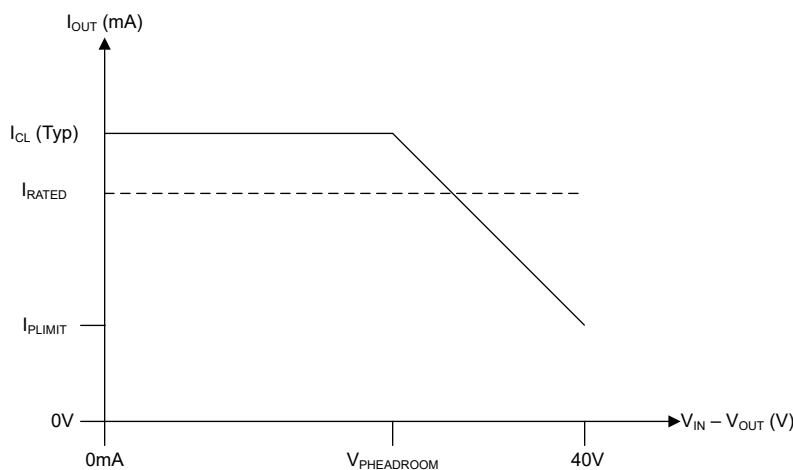

**Figure 6-6. Power Limiting**

### 6.3.7 Output Pulldown

The device has an output pulldown circuit.  $V_{OUT}$  pulldown sink to ground capability is listed in the [Electrical Characteristics](#) table. The output pulldown activates under the following conditions:

- $V_{EN} < V_{IL(EN)}$
- $1.0V < V_{IN} < V_{UVLO}$

The output pulldown resistance for this device is 750Ω typical. The pulldown resistance,  $V_{IL(EN)}$  and  $V_{UVLO}$  thresholds are listed in the [Electrical Characteristics](#) table.

Do not rely on the output pulldown circuit for discharging a large amount of output capacitance after the input supply has collapsed because reverse current can flow from the output to the input. This reverse current flow can cause damage to the device. See the [Reverse Current](#) section for more details.

## 6.4 Device Functional Modes

### 6.4.1 Device Functional Mode Comparison

The [Table 6-1](#) table shows the conditions that lead to the different modes of operation. See the [Electrical Characteristics](#) table for parameter values.

**Table 6-1. Device Functional Mode Comparison**

OPERATING MODE	PARAMETER			
	$V_{IN}$	$V_{EN}$	$I_{OUT}$	$T_J$
Normal operation	$V_{IN} > V_{OUT(nom)} + V_{DO}$ and $V_{IN} > V_{IN(min)}$	$V_{EN} > V_{EN(HI)}$	$I_{OUT} < I_{OUT(max)}$	$T_J < T_{SD(shutdown)}$
Dropout operation	$V_{IN(min)} < V_{IN} < V_{OUT(nom)} + V_{DO}$	$V_{EN} > V_{EN(HI)}$	$I_{OUT} < I_{OUT(max)}$	$T_J < T_{SD(shutdown)}$
Disabled (any true condition disables the device)	$V_{IN} < V_{UVLO}$	$V_{EN} < V_{EN(LOW)}$	Not applicable	$T_J > T_{SD(shutdown)}$

### 6.4.2 Normal Operation

The device regulates to the nominal output voltage under the following conditions:

- The input voltage is greater than the nominal output voltage plus the dropout voltage ( $V_{OUT(nom)} + V_{DO}$ )
- The headroom across the LDO ( $V_{IN} - V_{OUT}$ ) is less than  $V_{PHEADROOM}$  for required  $I_{OUT}$ , such that power limit is not engaged
- The output current is less than the current limit ( $I_{OUT} < I_{CL}$ )
- The device junction temperature is greater than  $-40^{\circ}C$  and less than  $+150^{\circ}C$
- The device junction temperature is less than the thermal shutdown temperature ( $T_J < T_{SD}$ )
- The enable voltage has previously exceeded the enable rising threshold voltage and has not yet decreased to less than the enable falling threshold

### 6.4.3 Dropout Operation

The device operates in dropout mode when the input voltage is lower than the nominal output voltage plus the specified dropout voltage. However, make sure all other conditions are met for normal operation. In dropout operation, the pass transistor is in the ohmic or triode region of operation, and acts as a switch. Because of this operation, the transient performance of the device becomes significantly degraded. Line or load transients in dropout potentially result in large output voltage deviations.

When the device is in a steady dropout state, the pass transistor is driven into the ohmic or triode region. This state is defined as when the device is in dropout, directly after being in a normal regulation state, but *not* during start up. During dropout,  $V_{IN} < V_{OUT(NOM)} + V_{DO}$ . When the input voltage returns to a value  $\geq V_{OUT(NOM)} + V_{DO}$ , the output voltage overshoots for a short period of time. During this time, the device pulls the pass transistor back into the linear region.  $V_{OUT(NOM)}$  is the nominal output voltage and  $V_{DO}$  is the dropout voltage.

#### **6.4.4 Disabled**

The output of the device can be shutdown by forcing the voltage of the enable pin to less than the maximum EN pin low-level input voltage (see the [Electrical Characteristics](#) table). When disabled, the pass transistor is turned off, internal circuits are shutdown, and the output voltage is actively discharged to ground by an internal discharge circuit from the output to ground.

## 7 Application and Implementation

### Note

Information in the following applications sections is not part of the TI component specification, and TI does not warrant its accuracy or completeness. TI's customers are responsible for determining suitability of components for their purposes, as well as validating and testing their design implementation to confirm system functionality.

### 7.1 Application Information

#### 7.1.1 Adjustable Device Feedback Resistor Selection

The adjustable-version device requires external feedback divider resistors to set the output voltage.  $V_{OUT}$  is set using the feedback divider resistors,  $R_1$  and  $R_2$ , according to the following equation:

$$V_{OUT} = V_{ADJ} \times (1 + R_1 / R_2) \quad (3)$$

$V_{ADJ}$  (or  $V_{FB}$ ) is the feedback voltage and refers to the voltage on the ADJ pin. During normal operation of the adjustable device, the device regulates such that the  $V_{ADJ}$  is equal to the device's internal reference voltage.

To ignore the ADJ pin current error term in the  $V_{OUT}$  equation, set the feedback divider current to 100x the ADJ pin current ( $I_{ADJ}$ ) listed in the [Electrical Characteristics](#) table. This setting provides the maximum feedback divider series resistance, as shown in the following equation:

$$R_1 + R_2 \leq V_{OUT} / (I_{ADJ} \times 100) \quad (4)$$

#### 7.1.2 Recommended Capacitor Types

The device is designed to be stable using low equivalent series resistance (ESR) ceramic capacitors at the input and output. Multilayer ceramic capacitors have become the industry standard for these types of applications and are recommended, but must be used with good judgment. Ceramic capacitors that employ X7R-, X5R-, and C0G-rated dielectric materials provide relatively good capacitive stability across temperature, whereas the use of Y5V-rated capacitors is discouraged because of large variations in capacitance.

Regardless of the ceramic capacitor type selected, the effective capacitance varies with operating voltage and temperature. As a general rule, expect the effective capacitance to decrease by as much as 50%. The input and output capacitors recommended in the [Recommended Operating Conditions](#) table account for an effective capacitance of approximately 50% of the nominal value.

#### 7.1.3 Input and Output Capacitor Selection

The TPS7E81-Q1 requires an output capacitor of 2.2 $\mu$ F or larger (1.0 $\mu$ F or larger capacitance) for stability and an equivalent series resistance (ESR) between 0.0 $\Omega$  and 1 $\Omega$ . For best transient performance, use X5R- and X7R-type ceramic capacitors because these capacitors have minimal variation in value and ESR over temperature. When choosing a capacitor for a specific application, be mindful of the DC bias characteristics for the capacitor. Higher output voltages cause a significant derating of the capacitor. For best performance, the maximum recommended output capacitance is 100 $\mu$ F.

Although an input capacitor is not required for stability, good analog design practice is to connect a capacitor from IN to GND. Some input supplies have a high impedance, thus placing the input capacitor on the input supply helps reduce the input impedance. This capacitor counteracts reactive input sources and improves transient response, input ripple, and PSRR. If the input supply has a high impedance over a large range of frequencies, several input capacitors can be used in parallel to lower the impedance over frequency. Use a higher-value capacitor if large, fast, rise-time load transients are anticipated, or if the device is located several inches from the input power source.

### 7.1.4 Reverse Current

Excessive reverse current can damage this device. Reverse current flows through the intrinsic body diode of the pass transistor instead of the normal conducting channel. At high magnitudes, this current flow degrades the long-term reliability of the device.

Conditions where reverse current can occur are outlined in this section, all of which can exceed the absolute maximum rating of  $V_{OUT} \leq V_{IN} + 0.3V$ .

- If the device has a large  $C_{OUT}$  and the input supply collapses with little or no load current
- The output is biased when the input supply is not established
- The output is biased above the input supply

If reverse current flow is expected in the application, external protection is recommended to protect the device. Reverse current is not limited in the device, so external limiting is required if extended reverse voltage operation is anticipated.

Figure 7-1 shows one approach for protecting the device.

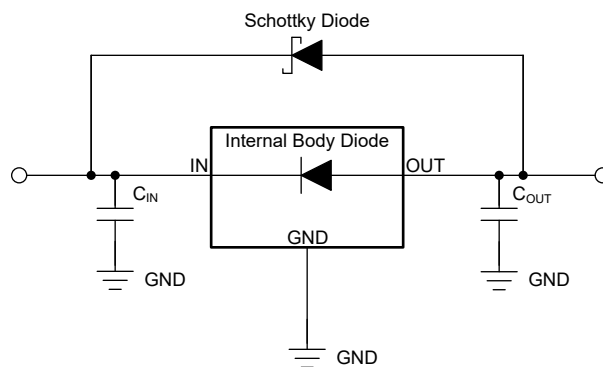

**Figure 7-1. Example Circuit for Reverse Current Protection Using a Schottky Diode**

### 7.1.5 Feed-Forward Capacitor

For the adjustable-voltage version device, a feed-forward capacitor ( $C_{FF}$ ) can be connected from the OUT pin to the ADJ pin.  $C_{FF}$  improves transient, noise, and PSRR performance, but is not required for regulator stability. Recommended  $C_{FF}$  values are listed in the [Recommended Operating Conditions](#) table. A higher capacitance  $C_{FF}$  can be used; however, the start-up time increases. For a detailed description of  $C_{FF}$  tradeoffs, see the [Pros and Cons of Using a Feedforward Capacitor with a Low-Dropout Regulator application note](#).

$C_{FF}$  and  $R_1$  form a zero in the loop gain at frequency  $f_z$ , while  $C_{FF}$ ,  $R_1$ , and  $R_2$  form a pole in the loop gain at frequency  $f_p$ .  $C_{FF}$  zero and pole frequencies can be calculated from the following equations:

$$f_z = 1 / (2 \times \pi \times C_{FF} \times R_1) \quad (5)$$

$$f_p = 1 / (2 \times \pi \times C_{FF} \times (R_1 \parallel R_2)) \quad (6)$$

### 7.1.6 Dropout Voltage

Dropout voltage ( $V_{DO}$ ) is defined as the input voltage minus the output voltage ( $V_{IN} - V_{OUT}$ ) at the rated output current ( $I_{RATED}$ ), where the pass transistor is fully on.  $I_{RATED}$  is the maximum  $I_{OUT}$  listed in the [Recommended Operating Conditions](#) table. The pass transistor is in the ohmic or triode region of operation, and acts as a switch. The dropout voltage indirectly specifies a minimum input voltage greater than the nominal programmed output voltage at which the output voltage is expected to stay in regulation. If the input voltage falls to less than the nominal output regulation, then the output voltage falls as well.

For a CMOS regulator, the dropout voltage is determined by the drain-source on-state resistance ( $R_{DS(ON)}$ ) of the pass transistor. Therefore, if the linear regulator operates at less than the rated current, the dropout voltage for that current scales accordingly. The following equation calculates the  $R_{DS(ON)}$  of the device.

$$R_{DS(ON)} = \frac{V_{DO}}{I_{RATED}} \quad (7)$$

### 7.1.7 Estimating Junction Temperature

The JEDEC standard now recommends using psi ( $\Psi$ ) thermal metrics to estimate the junction temperatures of the LDO when in-circuit on a typical PCB board application. These metrics are not thermal resistance parameters and instead offer a practical and relative way to estimate junction temperature. These psi metrics are determined to be significantly independent of the copper area available for heat-spreading. The [Thermal Information](#) table lists the primary thermal metrics, which are the junction-to-top characterization parameter ( $\Psi_{JT}$ ) and junction-to-board characterization parameter ( $\Psi_{JB}$ ). These parameters provide two methods for calculating the junction temperature ( $T_J$ ), as described in the following equations. Use the junction-to-top characterization parameter ( $\Psi_{JT}$ ) with the temperature at the center-top of device package ( $T_T$ ) to calculate the junction temperature. Use the junction-to-board characterization parameter ( $\Psi_{JB}$ ) with the PCB surface temperature 1mm from the device package ( $T_B$ ) to calculate the junction temperature.

$$T_J = T_T + \Psi_{JT} \times P_D \quad (8)$$

where:

- $P_D$  is the dissipated power
- $T_T$  is the temperature at the center-top of the device package

$$T_J = T_B + \Psi_{JB} \times P_D \quad (9)$$

where:

- $T_B$  is the PCB surface temperature measured 1mm from the device package and centered on the package edge

For detailed information on the thermal metrics and how to use them, see [Semiconductor and IC Package Thermal Metrics application note](#).

### 7.1.8 Power Dissipation ( $P_D$ )

Circuit reliability requires proper consideration of the device power dissipation, location of the circuit on the printed circuit board (PCB), and correct sizing of the thermal plane. Verify the PCB area around the regulator has few or no other heat-generating devices that cause added thermal stress.

To first-order approximation, power dissipation in the regulator depends on the input-to-output voltage difference and load conditions. The following equation calculates power dissipation ( $P_D$ ).

$$P_D = (V_{IN} - V_{OUT}) \times I_{OUT} \quad (10)$$

---

#### Note

Power dissipation is minimized, and thus greater efficiency achieved, by proper selection of the system voltage rails. Proper selection allows the minimum input-to-output voltage differential to be obtained. The low dropout of the device allows for maximum efficiency across a wide range of output voltages.

---

For devices with a thermal pad, the primary heat conduction path for the device package is through the thermal pad to the PCB. Solder the thermal pad to a copper pad area under the device. This pad area contains an array of plated vias that conduct heat to additional copper planes for increased heat dissipation.

The maximum power dissipation determines the maximum allowable ambient temperature ( $T_A$ ) for the device. Power dissipation and junction temperature are most often related by the  $R_{\theta JA}$  of the combined PCB and device package and the  $T_A$ .  $R_{\theta JA}$  is the junction-to-ambient thermal resistance and  $T_A$  is the temperature of the ambient air. The following equation describes this relationship.

$$T_J = T_A + (R_{\theta JA} \times P_D) \quad (11)$$

The following equation rearranges this relationship for output current.

$$I_{OUT} = (T_J - T_A) / [R_{\theta JA} \times (V_{IN} - V_{OUT})] \quad (12)$$

Thermal resistance ( $R_{\theta JA}$ ) is highly dependent on the heat-spreading capability built into the particular PCB design. This resistance therefore varies according to the total copper area, copper weight, and location of the planes. The junction-to-ambient thermal resistance listed in the [Thermal Information](#) table is determined by the JEDEC standard PCB and copper-spreading area.  $R_{\theta JA}$  is used as a relative measure of package thermal performance. For packages with thermal pad and a well-designed thermal layout,  $R_{\theta JA}$  is actually the sum of the package's  $R_{\theta JCbot}$  plus the thermal resistance contribution by the PCB copper.  $R_{\theta JCbot}$  is the junction-to-case (bottom) thermal resistance, as given in the [Thermal Information](#) table.

### 7.1.9 Power Dissipation Versus Ambient Temperature

Figure 7-2, Figure 7-3 and Figure 7-4 are based off of a JESD51-7 4-layer, high-K board. The allowable power dissipation is estimated using the following equation. As discussed in the [An empirical analysis of the impact of board layout on LDO thermal performance application note](#), thermal dissipation can be improved in the JEDEC high-K layout by adding top layer copper and increasing the number of thermal vias. If a good thermal layout is used, the allowable thermal dissipation can be improved by up to 50%.

$$T_A + R_{\theta JA} \times P_D \leq 150 \text{ } ^\circ\text{C} \quad (13)$$

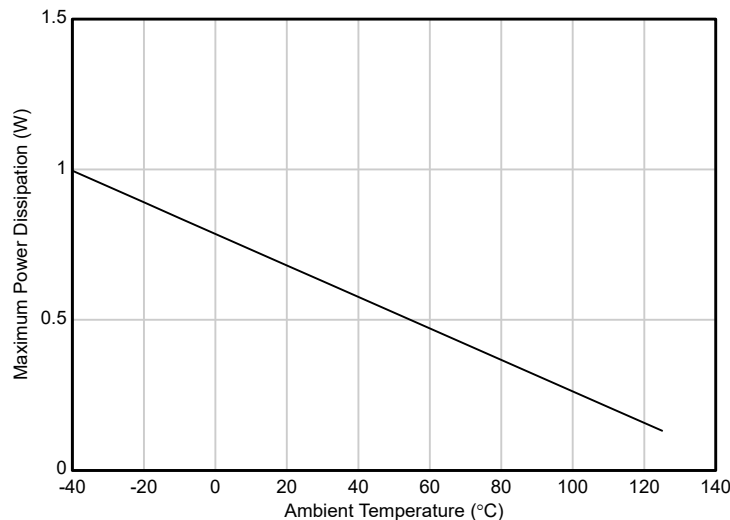
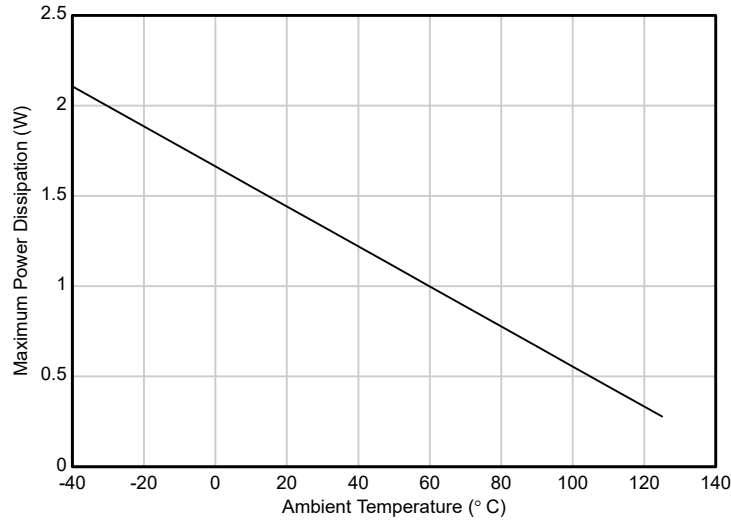
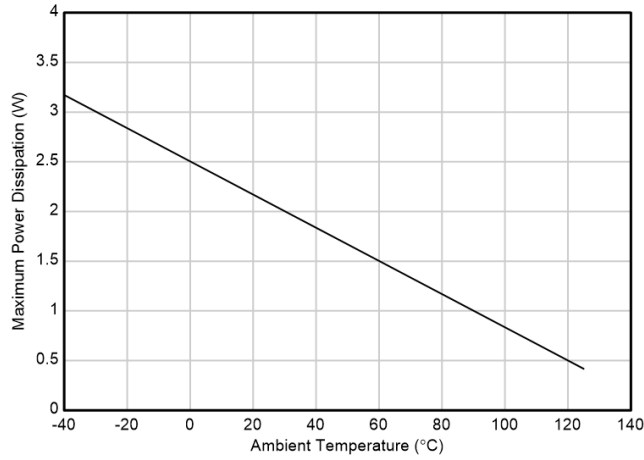

Figure 7-2. TPS7E81-Q1 (DBV) Allowable Power Dissipation

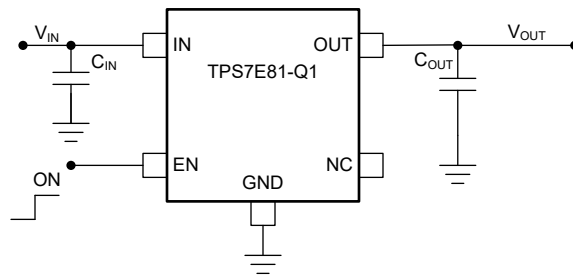

**Figure 7-3. TPS7E81-Q1 (DRV) Allowable Power Dissipation**

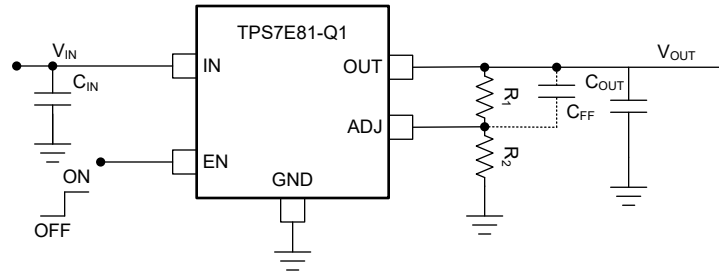

**Figure 7-4. TPS7E81-Q1 (DGN) Allowable Power Dissipation**

## 7.2 Typical Application



**Figure 7-5. Typical Application Circuit (Fixed-Voltage Version)**



**Figure 7-6. Adjustable LDO Regulator Programming**

NOTE: Dotted lines indicate an optional input capacitor and feed-forward capacitor. See the [Input and Output Capacitor Selection](#) and [Feed-Forward Capacitor](#) sections and the [Recommended Operating Conditions](#) table.

**Table 7-1. Adjustable Output Voltage for Resistors R<sub>1</sub> and R<sub>2</sub>**

OUTPUT VOLTAGE (V)	R <sub>1</sub> (MΩ)	R <sub>2</sub> (MΩ)
1.8	0.499	1
2.8	1.33	1
5.0	3.16	1

### 7.2.1 Design Requirements

Table 7-2 summarizes the design requirements for Figure 7-5.

**Table 7-2. Design Parameters**

PARAMETER	DESIGN REQUIREMENT
Input voltage	12V
Output voltage	5.0V
Output current	100mA

### 7.2.2 Choose Feedback Resistors

For this design example, V<sub>OUT</sub> is set to 3.3V. The following equations set the feedback divider resistors for the desired output voltage:

$$V_{OUT} = V_{ADJ} \times (1 + R_1 / R_2) \quad (14)$$

$$R_1 + R_2 \leq V_{OUT} / (I_{ADJ} \times 100) \quad (15)$$

For improved output accuracy, use Equation 15 and I<sub>ADJ</sub> = 10nA as listed in the [Electrical Characteristics](#) table to calculate the upper limit for series feedback resistance (R<sub>1</sub> + R<sub>2</sub> ≤ 3.3MΩ).

The control-loop error amplifier drives the ADJ pin to the same voltage as the internal reference (V<sub>ADJ</sub> = 1.2V, as listed in the [Electrical Characteristics](#) table). Use Equation 14 to determine the ratio of R<sub>1</sub> / R<sub>2</sub> = 1.75. Use this ratio and solve Equation 15 for R<sub>1</sub>. Now calculate the upper limit for R<sub>1</sub> ≤ 2.1MΩ. Select a standard value resistor for R<sub>1</sub> = 1.75MΩ.

Reference Equation 16 and solve for R<sub>2</sub>:

$$R_2 = R_1 / [(V_{OUT} / V_{ADJ}) - 1] \quad (16)$$

From Equation 16, R<sub>2</sub> = 1MΩ is determined. Select a standard value resistor for R<sub>2</sub> = 1MΩ. V<sub>OUT</sub> = 3.3V (as determined by Equation 16). Verify that the feedback divider current is greater than the minimum value in the [Recommended Operating Conditions](#) table.

The following equation calculates the feedback divider current.

$$I_{\text{FB\_Divider}} = V_{\text{OUT}} / (R_1 + R_2) \quad (17)$$

### 7.2.3 Application Curves

at operating junction temperature  $T_J = 25^\circ\text{C}$ ,  $V_{IN} = 3.0\text{V}$  or  $V_{IN} = V_{OUT}(\text{nom}) + 0.5\text{V}$  (whichever is greater),  $V_{EN} = 2.0\text{V}$ ,  $C_{IN} = 1\mu\text{F}$ ,  $C_{OUT} = 2.2\mu\text{F}$ , and  $I_{OUT} = 1\text{mA}$  (unless otherwise noted).

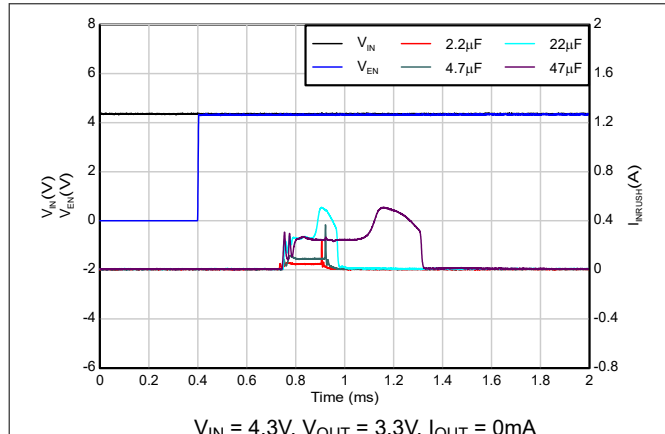

**Figure 7-7. Inrush Current vs  $C_{OUT}$**

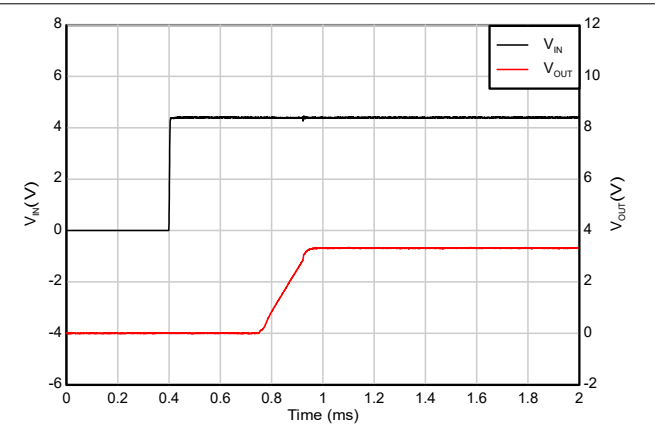

**Figure 7-8. Start-up with EN &  $V_{IN}$  tied together**

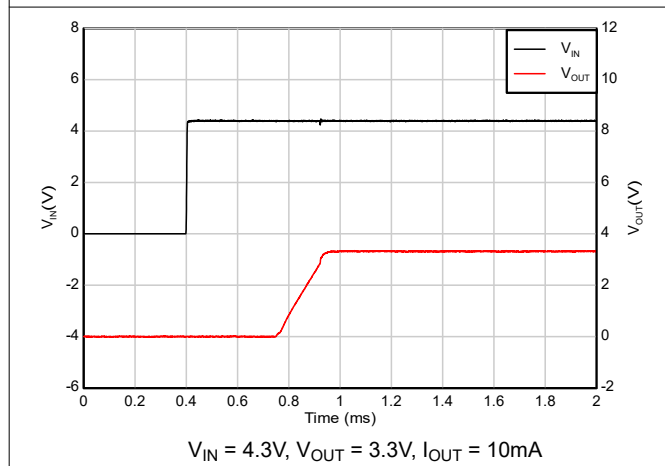

**Figure 7-9. Start-up with EN &  $V_{IN}$  tied together**

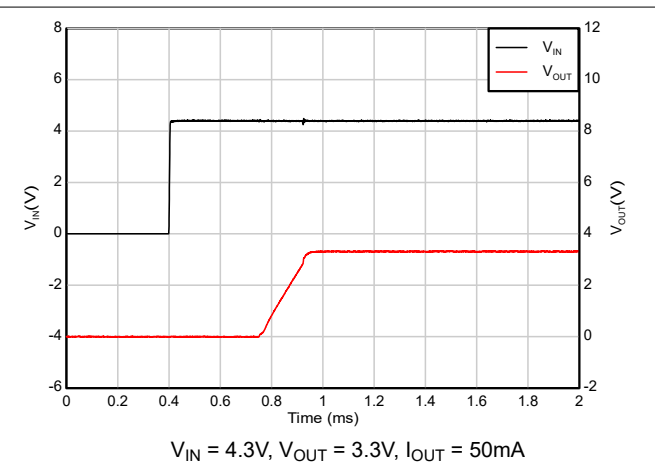

**Figure 7-10. Start-up with EN &  $V_{IN}$  tied together**

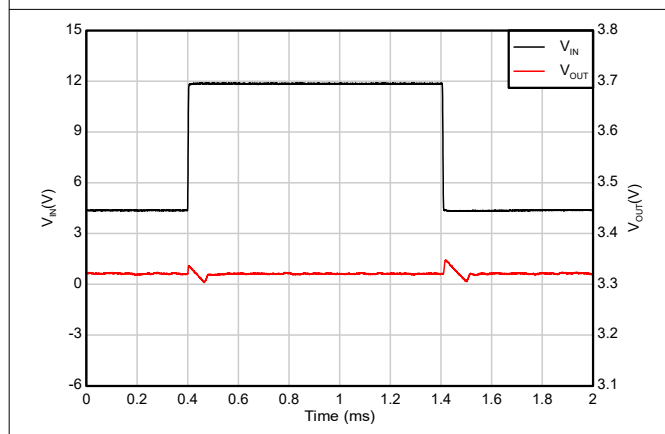

**Figure 7-11. Line Transient (4.3V to 12V)**

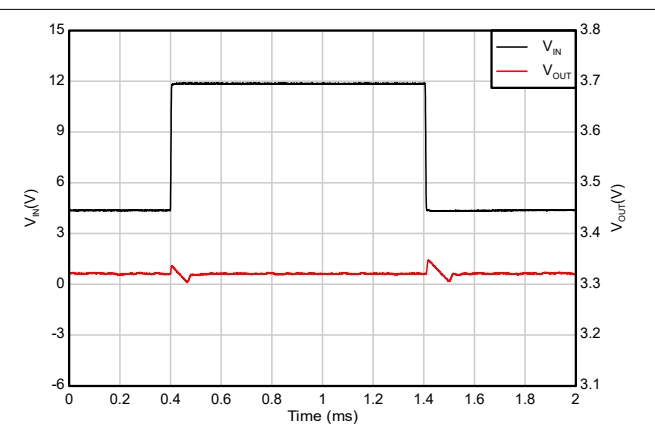

**Figure 7-12. Line Transient (4.3V to 12V)**

### 7.2.3 Application Curves (continued)

at operating junction temperature  $T_J = 25^\circ\text{C}$ ,  $V_{IN} = 3.0\text{V}$  or  $V_{IN} = V_{OUT}(\text{nom}) + 0.5\text{V}$  (whichever is greater),  $V_{EN} = 2.0\text{V}$ ,  $C_{IN} = 1\mu\text{F}$ ,  $C_{OUT} = 2.2\mu\text{F}$ , and  $I_{OUT} = 1\text{mA}$  (unless otherwise noted).

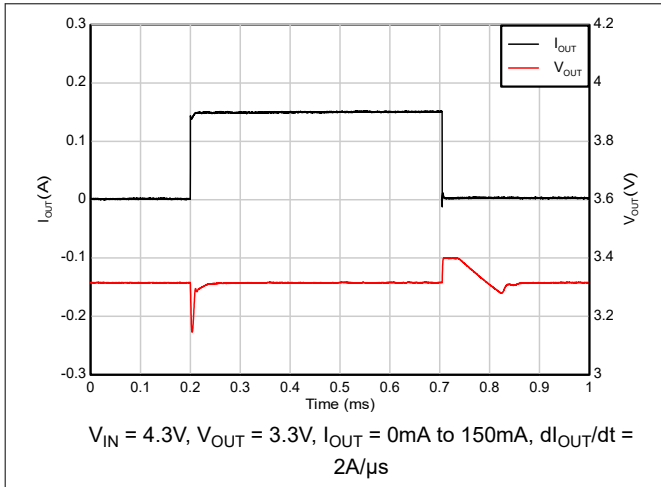

**Figure 7-13. Load Transient (0mA to 150mA)**

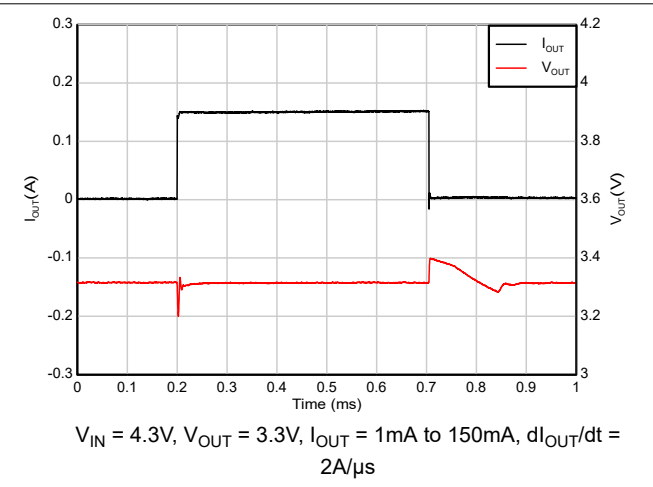

**Figure 7-14. Load Transient (1mA to 150mA)**

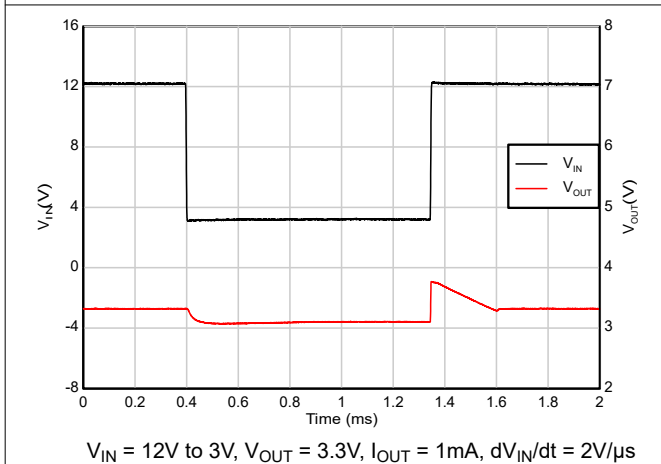

**Figure 7-15. Dropout Recovery (12V to 3V)**

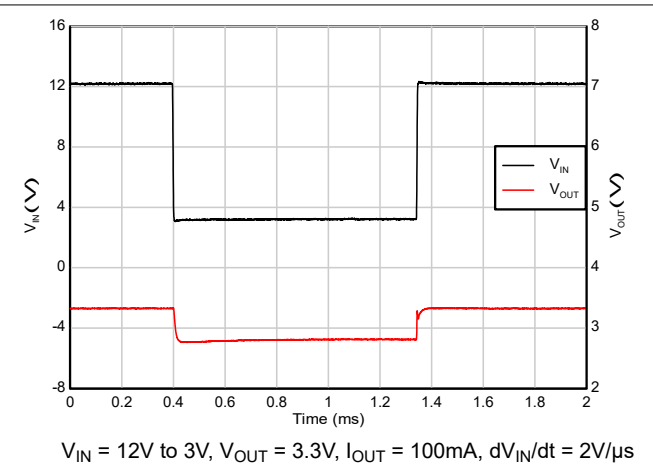

**Figure 7-16. Dropout Recovery (12V to 3V)**

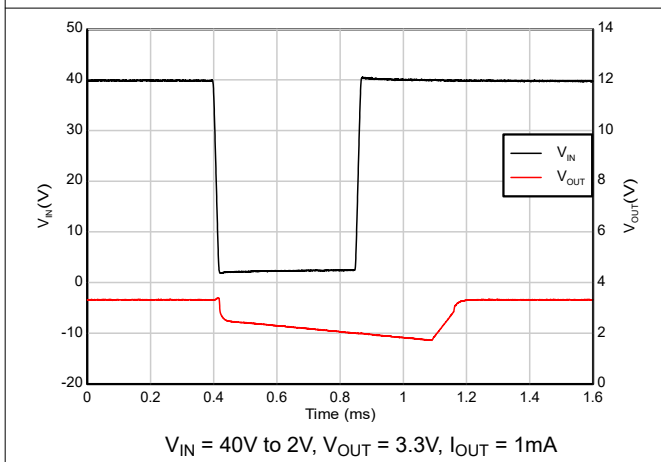

**Figure 7-17. Brown-out Recovery (40V to 2V)**

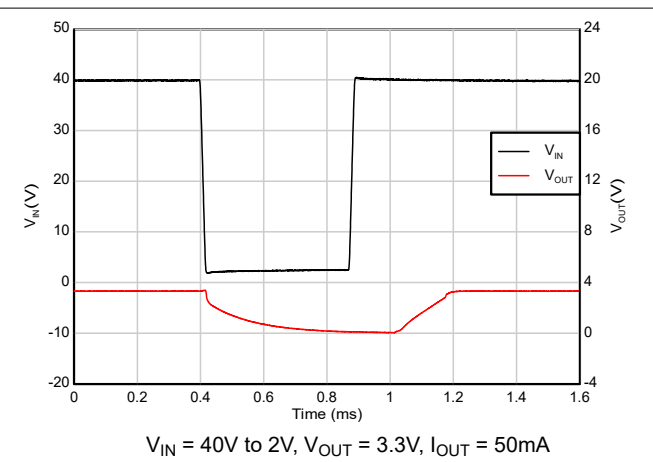

**Figure 7-18. Brown-out Recovery (40V to 2V)**

## 7.3 Power Supply Recommendations

The TPS7E81-Q1 is designed to operate from an input voltage supply range between 3.0V and 40V. The input voltage range provides adequate headroom for the device to have a regulated output. If the input supply is noisy, additional input capacitors with low ESR help improve output noise performance.

## 7.4 Layout

### 7.4.1 Layout Guidelines

For best overall performance, follow the guidelines in this section. Place all circuit components on the same side of the printed circuit board (PCB) and as near as practical to the respective LDO pin connections. Place ground return connections for the input and output capacitors as close to the GND pin as possible, using wide, component-side, copper planes. Do not use vias and long traces to create LDO circuit connections to the input capacitor, output capacitor, or resistor divider. This practice negatively affects system performance. This grounding and layout scheme minimizes inductive parasitics, and thereby reduces load current transients, minimizes noise, and increases circuit stability. A ground reference plane is also recommended and is embedded in the PCB or located on the bottom side of the PCB opposite the components. This reference plane serves to provide accuracy of the output voltage and shield the LDO from noise. To improve the thermal performance of the device, and to maximize the current output at high ambient temperature, spread the copper under the thermal pad as far as possible and place enough thermal vias on the copper under the thermal pad.

### 7.4.2 Layout Example

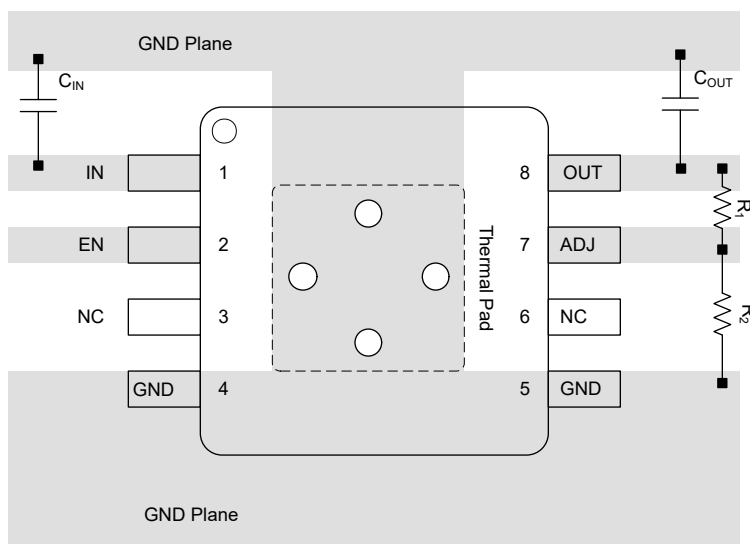
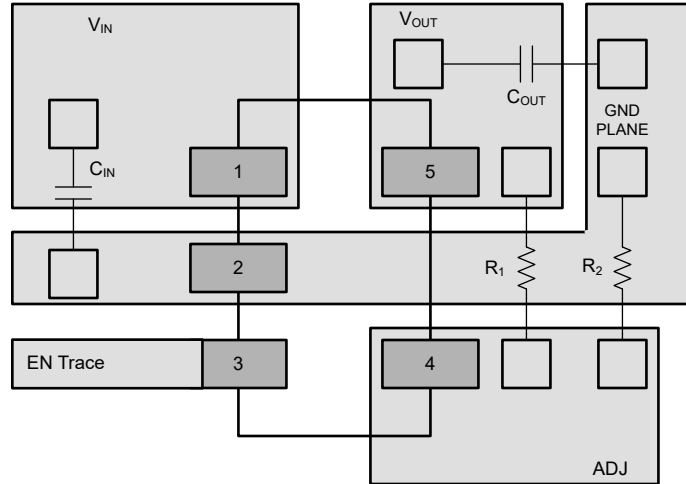
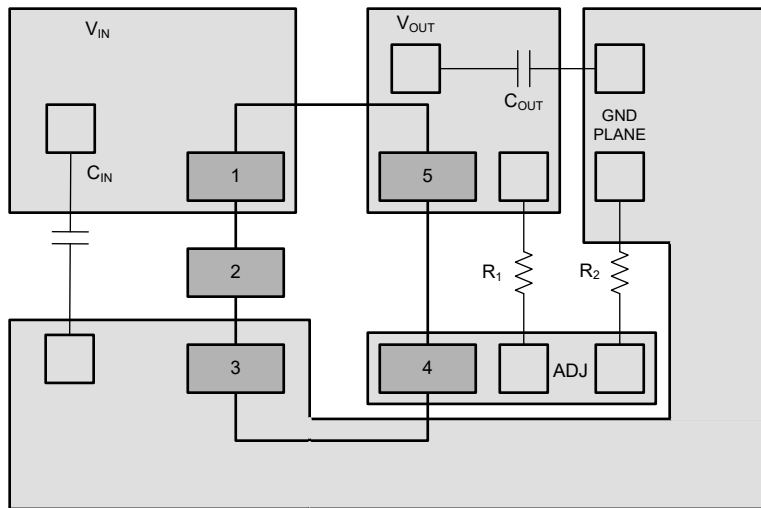

Figure 7-19. Example Layout for the DGN Package



**Figure 7-20. Example Layout for the DBV Package**



**Figure 7-21. Example Layout for the DBV-A (Without EN Functionality) Package**

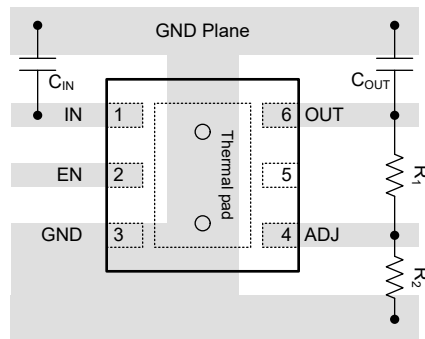

**Figure 7-22. Example Layout for the DRV Package**

## 8 Device and Documentation Support

### 8.1 Device Support

#### 8.1.1 Development Support

##### 8.1.1.1 Evaluation Module

An evaluation module (EVM) is available to assist in the initial circuit performance evaluation using the TPS7E81-Q1. The [Universal EVM](#) (and related [user's guide](#)) can be requested at the TI website through the product folders or purchased directly from [the TI eStore](#).

##### 8.1.1.2 Spice Models

Computer simulation of circuit performance using SPICE is often useful when analyzing the performance of analog circuits and systems. A SPICE model for the TPS7B92 is available through the product folders under *Tools & Software*.

#### 8.1.2 Device Nomenclature

**Table 8-1. Device Nomenclature**

PRODUCT <sup>(1)</sup>	V <sub>OUT</sub>
TPS7E81XX AQW yyy zQ1	<p><b>XX</b> is the nominal output voltage. (For example, 33 = 3.3V; 50 = 5.0V, and 01 = Adjustable).</p> <p><b>A</b> denotes different pinout for DRV package and denotes different functionality (without EN functionality) for DBV package.</p> <p><b>W</b> for wettable DRV package only.</p> <p><b>yyy</b> is the package designator.</p> <p><b>z</b> is the package quantity. R is for reel (3000 pieces).</p>

(1) For the most current package and ordering information see the Package Option Addendum at the end of this document, or see the TI website at [www.ti.com](#).

### 8.2 Documentation Support

#### 8.2.1 Related Documentation

For related documentation see the following:

- For more information on Low I<sub>Q</sub> LDOs, see the [Low Quiescent Current LDOs for Battery Connected Automotive Systems application note](#).
- Texas Instruments, [Universal Low-Dropout Linear Voltage Regulator \(LDO\) Evaluation Module user guide](#)

### 8.3 Receiving Notification of Documentation Updates

To receive notification of documentation updates, navigate to the device product folder on [ti.com](#). Click on *Notifications* to register and receive a weekly digest of any product information that has changed. For change details, review the revision history included in any revised document.

### 8.4 Support Resources

[TI E2E™ support forums](#) are an engineer's go-to source for fast, verified answers and design help — straight from the experts. Search existing answers or ask your own question to get the quick design help you need.

Linked content is provided "AS IS" by the respective contributors. They do not constitute TI specifications and do not necessarily reflect TI's views; see TI's [Terms of Use](#).

### 8.5 Trademarks

TI E2E™ is a trademark of Texas Instruments.

All trademarks are the property of their respective owners.

## 8.6 Electrostatic Discharge Caution



This integrated circuit can be damaged by ESD. Texas Instruments recommends that all integrated circuits be handled with appropriate precautions. Failure to observe proper handling and installation procedures can cause damage.

ESD damage can range from subtle performance degradation to complete device failure. Precision integrated circuits may be more susceptible to damage because very small parametric changes could cause the device not to meet its published specifications.

## 8.7 Glossary

[TI Glossary](#) This glossary lists and explains terms, acronyms, and definitions.

## 9 Revision History

NOTE: Page numbers for previous revisions may differ from page numbers in the current version.

<b>Changes from Revision A (December 2025) to Revision B (April 2026)</b>	<b>Page</b>
• Corrected thermal parameters for DGN package and typical dropout at 150mA.....	1
• Corrected the package dimensions for DGN package.....	1
• Changed pin name from FB to ADJ for VADJ parameter.....	5
• Changed pin name to ADJ from FB for CADJ parameter.....	5
• Corrected thermal metric details for DGN package.....	6
• Changed pin name to ADJ from FB.....	6
• Updated load regulation for better representation across the output range.....	6
• Updated load regulation for better representation across the output range.....	6
• Updated EN & UVLO Threshold plots for better readability.....	8
• Updated pin name to ADJ to FB for $V_{ADJ}$ and $I_{ADJ}$ parameters.....	25
• Corrected pin name to ADJ from FB in Feed-Forward Capacitor section.....	26
• Corrected pin name to ADJ from FB across <b>Choose Feedback Resistors</b> section.....	30
• Corrected pin name to ADJ from FB for <i>Layout Examples</i> .....	34
• Added details for latest app-note on Low $I_Q$ LDOs for Battery Connected Automotive systems.....	36

<b>Changes from Revision * (October 2025) to Revision A (December 2025)</b>	<b>Page</b>
• Updated the device status from Advanced to Production Data.....	1

## 10 Mechanical, Packaging, and Orderable Information

The following pages include mechanical, packaging, and orderable information. This information is the most current data available for the designated devices. This data is subject to change without notice and revision of this document. For browser-based versions of this data sheet, refer to the left-hand navigation.

**PACKAGING INFORMATION**

Orderable part number	Status (1)	Material type (2)	Package   Pins	Package qty   Carrier	RoHS (3)	Lead finish/ Ball material (4)	MSL rating/ Peak reflow (5)	Op temp (°C)	Part marking (6)
<a href="#">PTPS7E8101AQWDRVQ1</a>	Active	Preproduction	WSO (DRV)   6	3000   LARGE T&R	-	Call TI	Call TI	-40 to 150	
<a href="#">PTPS7E8101QWDRVRQ1</a>	Active	Preproduction	WSO (DRV)   6	3000   LARGE T&R	-	Call TI	Call TI	-40 to 150	
<a href="#">PTPS7E8150QWDRVRQ1</a>	Active	Preproduction	WSO (DRV)   6	3000   LARGE T&R	-	Call TI	Call TI	-40 to 150	
<a href="#">TPS7E8101AQDBVRQ1</a>	Active	Production	SOT-23 (DBV)   5	3000   LARGE T&R	Yes	NIPDAU	Level-1-260C-UNLIM	-40 to 150	3U3F
<a href="#">TPS7E8101QDBVRQ1</a>	Active	Production	SOT-23 (DBV)   5	3000   LARGE T&R	Yes	NIPDAU	Level-1-260C-UNLIM	-40 to 150	3TTF
<a href="#">TPS7E8125AQDBVRQ1</a>	Active	Production	SOT-23 (DBV)   5	3000   LARGE T&R	Yes	NIPDAU	Level-1-260C-UNLIM	-40 to 150	3U4F
<a href="#">TPS7E8125QDBVRQ1</a>	Active	Production	SOT-23 (DBV)   5	3000   LARGE T&R	Yes	NIPDAU	Level-1-260C-UNLIM	-40 to 150	3TUF
<a href="#">TPS7E8130AQDBVRQ1</a>	Active	Production	SOT-23 (DBV)   5	3000   LARGE T&R	Yes	NIPDAU	Level-1-260C-UNLIM	-40 to 150	3U5F
<a href="#">TPS7E8130QDBVRQ1</a>	Active	Production	SOT-23 (DBV)   5	3000   LARGE T&R	Yes	NIPDAU	Level-1-260C-UNLIM	-40 to 150	3TVF
<a href="#">TPS7E8133AQDBVRQ1</a>	Active	Production	SOT-23 (DBV)   5	3000   LARGE T&R	Yes	NIPDAU	Level-1-260C-UNLIM	-40 to 150	3U6F
<a href="#">TPS7E8133QDBVRQ1</a>	Active	Production	SOT-23 (DBV)   5	3000   LARGE T&R	Yes	NIPDAU	Level-1-260C-UNLIM	-40 to 150	3TWF
<a href="#">TPS7E8133QWDRVRQ1</a>	Active	Production	WSO (DRV)   6	3000   LARGE T&R	Yes	SN	Level-1-260C-UNLIM	-40 to 150	3T8H
<a href="#">TPS7E8150AQDBVRQ1</a>	Active	Production	SOT-23 (DBV)   5	3000   LARGE T&R	Yes	NIPDAU	Level-1-260C-UNLIM	-40 to 150	3U7F
<a href="#">TPS7E8150QDBVRQ1</a>	Active	Production	SOT-23 (DBV)   5	3000   LARGE T&R	Yes	NIPDAU	Level-1-260C-UNLIM	-40 to 150	3TXF
<a href="#">TPS7E8150QDGNRQ1</a>	Active	Production	HVSSOP (DGN)   8	2500   LARGE T&R	Yes	NIPDAU	Level-1-260C-UNLIM	-40 to 150	3THS

(1) **Status:** For more details on status, see our [product life cycle](#).

(2) **Material type:** When designated, preproduction parts are prototypes/experimental devices, and are not yet approved or released for full production. Testing and final process, including without limitation quality assurance, reliability performance testing, and/or process qualification, may not yet be complete, and this item is subject to further changes or possible discontinuation. If available for ordering, purchases will be subject to an additional waiver at checkout, and are intended for early internal evaluation purposes only. These items are sold without warranties of any kind.

(3) **RoHS values:** Yes, No, RoHS Exempt. See the [TI RoHS Statement](#) for additional information and value definition.

(4) **Lead finish/Ball material:** Parts may have multiple material finish options. Finish options are separated by a vertical ruled line. Lead finish/Ball material values may wrap to two lines if the finish value exceeds the maximum column width.

(5) **MSL rating/Peak reflow:** The moisture sensitivity level ratings and peak solder (reflow) temperatures. In the event that a part has multiple moisture sensitivity ratings, only the lowest level per JEDEC standards is shown. Refer to the shipping label for the actual reflow temperature that will be used to mount the part to the printed circuit board.

(6) **Part marking:** There may be an additional marking, which relates to the logo, the lot trace code information, or the environmental category of the part.

Multiple part markings will be inside parentheses. Only one part marking contained in parentheses and separated by a "-" will appear on a part. If a line is indented then it is a continuation of the previous line and the two combined represent the entire part marking for that device.

**Important Information and Disclaimer:** The information provided on this page represents TI's knowledge and belief as of the date that it is provided. TI bases its knowledge and belief on information provided by third parties, and makes no representation or warranty as to the accuracy of such information. Efforts are underway to better integrate information from third parties. TI has taken and continues to take reasonable steps to provide representative and accurate information but may not have conducted destructive testing or chemical analysis on incoming materials and chemicals. TI and TI suppliers consider certain information to be proprietary, and thus CAS numbers and other limited information may not be available for release.

In no event shall TI's liability arising out of such information exceed the total purchase price of the TI part(s) at issue in this document sold by TI to Customer on an annual basis.

**OTHER QUALIFIED VERSIONS OF TPS7E81-Q1 :**

- Catalog : [TPS7E81](#)

NOTE: Qualified Version Definitions:

- Catalog - TI's standard catalog product

**TAPE AND REEL INFORMATION**

**QUADRANT ASSIGNMENTS FOR PIN 1 ORIENTATION IN TAPE**

\*All dimensions are nominal

Device	Package Type	Package Drawing	Pins	SPQ	Reel Diameter (mm)	Reel Width W1 (mm)	A0 (mm)	B0 (mm)	K0 (mm)	P1 (mm)	W (mm)	Pin1 Quadrant
TPS7E8101AQDBVRQ1	SOT-23	DBV	5	3000	180.0	8.4	3.2	3.2	1.4	4.0	8.0	Q3
TPS7E8101QDBVRQ1	SOT-23	DBV	5	3000	180.0	8.4	3.2	3.2	1.4	4.0	8.0	Q3
TPS7E8125AQDBVRQ1	SOT-23	DBV	5	3000	180.0	8.4	3.2	3.2	1.4	4.0	8.0	Q3
TPS7E8125QDBVRQ1	SOT-23	DBV	5	3000	180.0	8.4	3.2	3.2	1.4	4.0	8.0	Q3
TPS7E8130AQDBVRQ1	SOT-23	DBV	5	3000	180.0	8.4	3.2	3.2	1.4	4.0	8.0	Q3
TPS7E8130QDBVRQ1	SOT-23	DBV	5	3000	180.0	8.4	3.2	3.2	1.4	4.0	8.0	Q3
TPS7E8133AQDBVRQ1	SOT-23	DBV	5	3000	180.0	8.4	3.2	3.2	1.4	4.0	8.0	Q3
TPS7E8133QDBVRQ1	SOT-23	DBV	5	3000	180.0	8.4	3.2	3.2	1.4	4.0	8.0	Q3
TPS7E8133QWDRVRQ1	WSON	DRV	6	3000	180.0	8.4	2.3	2.3	1.15	4.0	8.0	Q2
TPS7E8150AQDBVRQ1	SOT-23	DBV	5	3000	180.0	8.4	3.2	3.2	1.4	4.0	8.0	Q3
TPS7E8150QDBVRQ1	SOT-23	DBV	5	3000	180.0	8.4	3.2	3.2	1.4	4.0	8.0	Q3
TPS7E8150QDGNRQ1	HVSSOP	DGN	8	2500	330.0	12.4	5.3	3.4	1.4	8.0	12.0	Q1

**TAPE AND REEL BOX DIMENSIONS**

\*All dimensions are nominal

Device	Package Type	Package Drawing	Pins	SPQ	Length (mm)	Width (mm)	Height (mm)
TPS7E8101AQDBVRQ1	SOT-23	DBV	5	3000	210.0	185.0	35.0
TPS7E8101QDBVRQ1	SOT-23	DBV	5	3000	210.0	185.0	35.0
TPS7E8125AQDBVRQ1	SOT-23	DBV	5	3000	210.0	185.0	35.0
TPS7E8125QDBVRQ1	SOT-23	DBV	5	3000	210.0	185.0	35.0
TPS7E8130AQDBVRQ1	SOT-23	DBV	5	3000	210.0	185.0	35.0
TPS7E8130QDBVRQ1	SOT-23	DBV	5	3000	210.0	185.0	35.0
TPS7E8133AQDBVRQ1	SOT-23	DBV	5	3000	210.0	185.0	35.0
TPS7E8133QDBVRQ1	SOT-23	DBV	5	3000	210.0	185.0	35.0
TPS7E8133QWDRVRQ1	WSON	DRV	6	3000	210.0	185.0	35.0
TPS7E8150AQDBVRQ1	SOT-23	DBV	5	3000	210.0	185.0	35.0
TPS7E8150QDBVRQ1	SOT-23	DBV	5	3000	210.0	185.0	35.0
TPS7E8150QDGNRQ1	HVSSOP	DGN	8	2500	353.0	353.0	32.0

## GENERIC PACKAGE VIEW

**DGN 8**

**PowerPAD™ HVSSOP - 1.1 mm max height**

3 x 3, 0.65 mm pitch

SMALL OUTLINE PACKAGE

This image is a representation of the package family, actual package may vary.  
Refer to the product data sheet for package details.

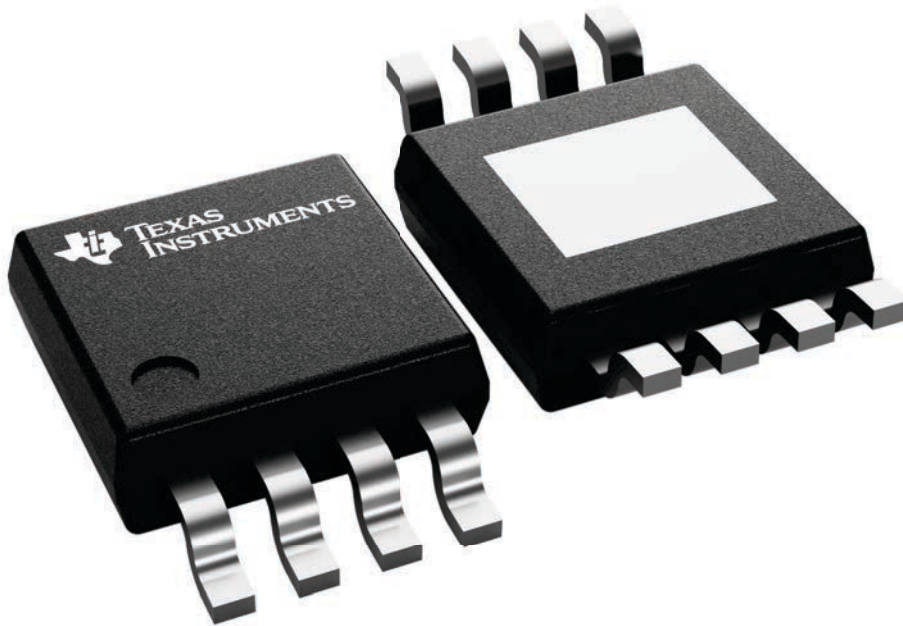

4225482/B

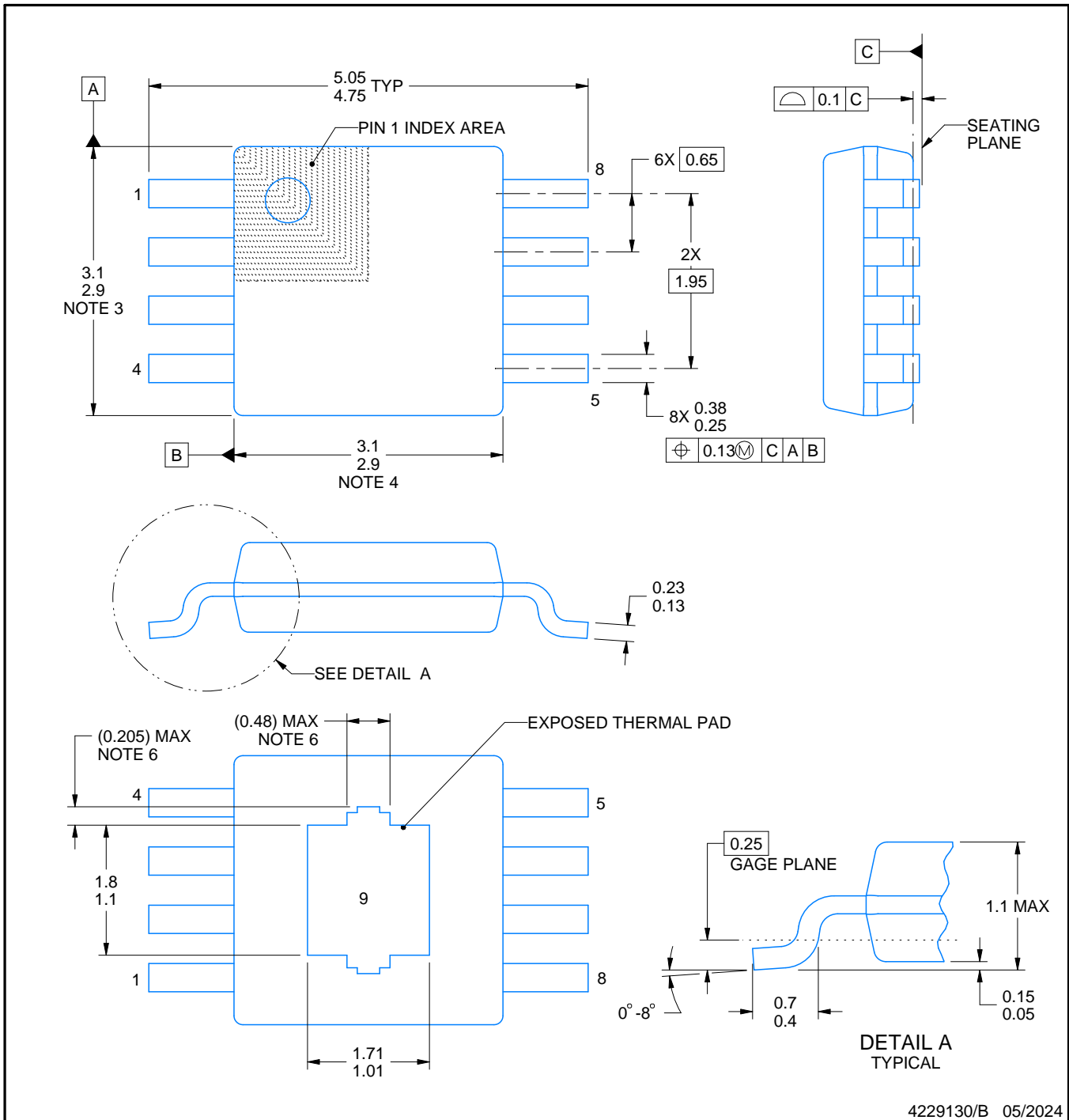
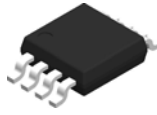

4229130/B 05/2024

NOTES:

PowerPAD is a trademark of Texas Instruments.

1. All linear dimensions are in millimeters. Any dimensions in parenthesis are for reference only. Dimensioning and tolerancing per ASME Y14.5M.
2. This drawing is subject to change without notice.
3. This dimension does not include mold flash, protrusions, or gate burrs. Mold flash, protrusions, or gate burrs shall not exceed 0.15 mm per side.
4. This dimension does not include interlead flash. Interlead flash shall not exceed 0.25 mm per side.
5. Reference JEDEC registration MO-187.
6. Features may differ or may not be present.



# EXAMPLE STENCIL DESIGN

DGN0008H

PowerPAD™ VSSOP - 1.1 mm max height

SMALL OUTLINE PACKAGE

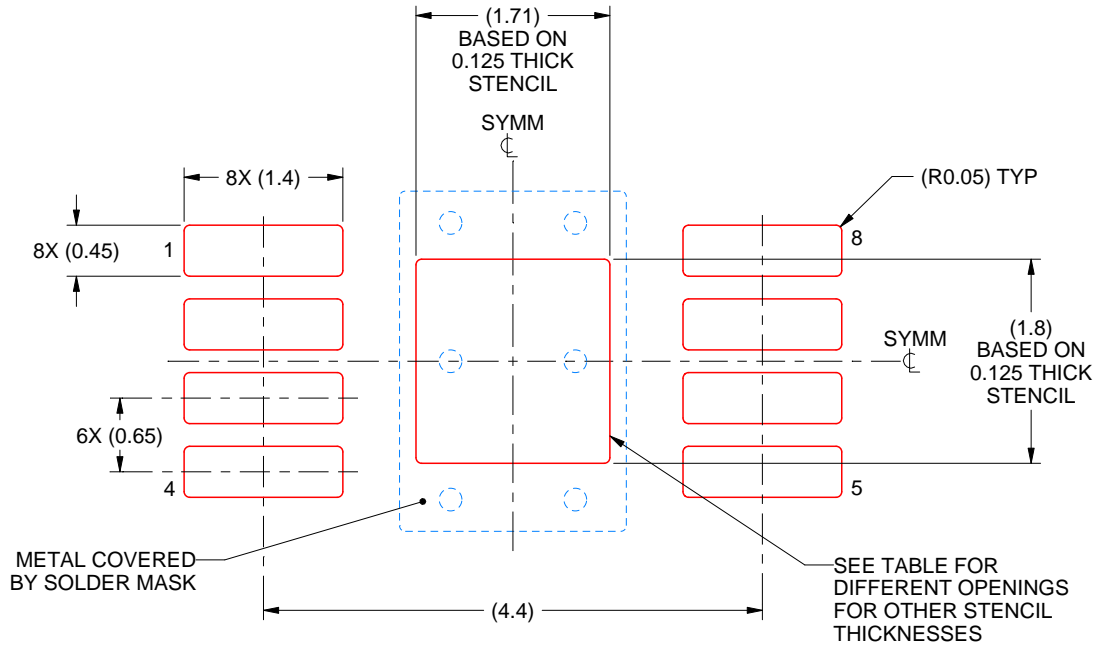

**SOLDER PASTE EXAMPLE**  
EXPOSED PAD 9:  
100% PRINTED SOLDER COVERAGE BY AREA  
SCALE: 15X

STENCIL THICKNESS	SOLDER STENCIL OPENING
0.1	1.91 X 2.01
0.125	1.71 X 1.80 (SHOWN)
0.15	1.56 X 1.64
0.175	1.45 X 1.52

4229130/B 05/2024

NOTES: (continued)

11. Laser cutting apertures with trapezoidal walls and rounded corners may offer better paste release. IPC-7525 may have alternate design recommendations.
12. Board assembly site may have different recommendations for stencil design.



# EXAMPLE BOARD LAYOUT

DBV0005A

SOT-23 - 1.45 mm max height

SMALL OUTLINE TRANSISTOR



LAND PATTERN EXAMPLE  
EXPOSED METAL SHOWN  
SCALE:15X

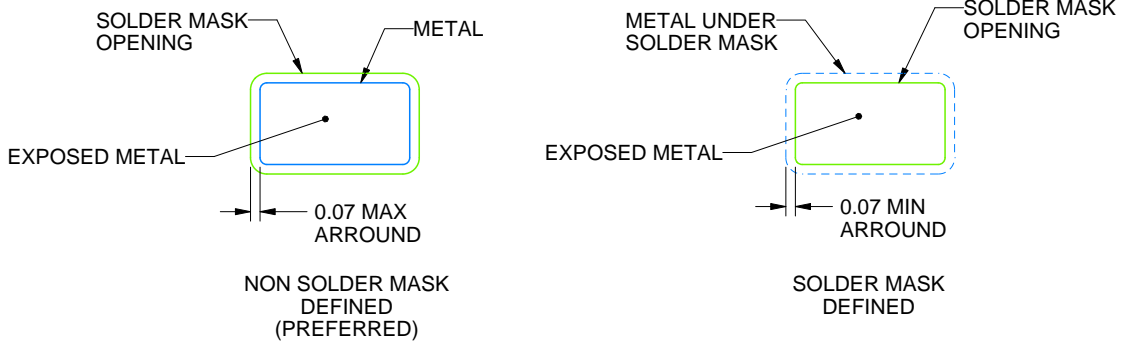

SOLDER MASK DETAILS

4214839/K 08/2024

NOTES: (continued)

- 6. Publication IPC-7351 may have alternate designs.
- 7. Solder mask tolerances between and around signal pads can vary based on board fabrication site.

# EXAMPLE STENCIL DESIGN

DBV0005A

SOT-23 - 1.45 mm max height

SMALL OUTLINE TRANSISTOR



SOLDER PASTE EXAMPLE  
BASED ON 0.125 mm THICK STENCIL  
SCALE:15X

4214839/K 08/2024

NOTES: (continued)

8. Laser cutting apertures with trapezoidal walls and rounded corners may offer better paste release. IPC-7525 may have alternate design recommendations.
9. Board assembly site may have different recommendations for stencil design.

## GENERIC PACKAGE VIEW

DRV 6

WSON - 0.8 mm max height

PLASTIC SMALL OUTLINE - NO LEAD

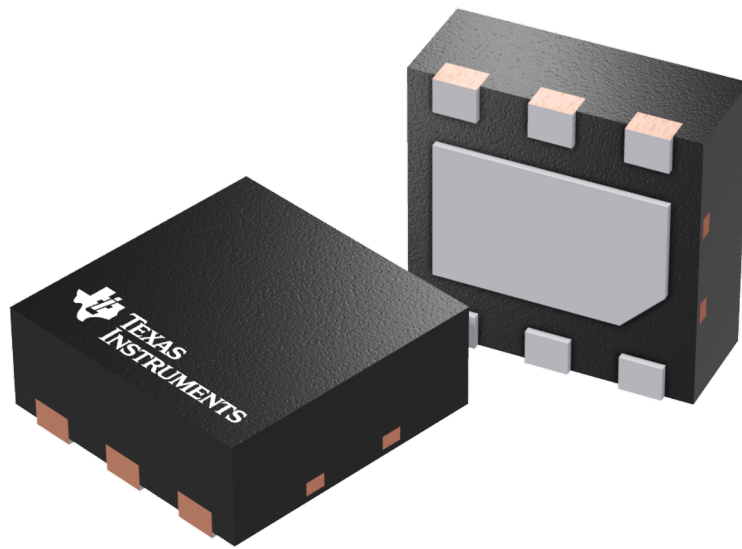

Images above are just a representation of the package family, actual package may vary.  
Refer to the product data sheet for package details.

4206925/F

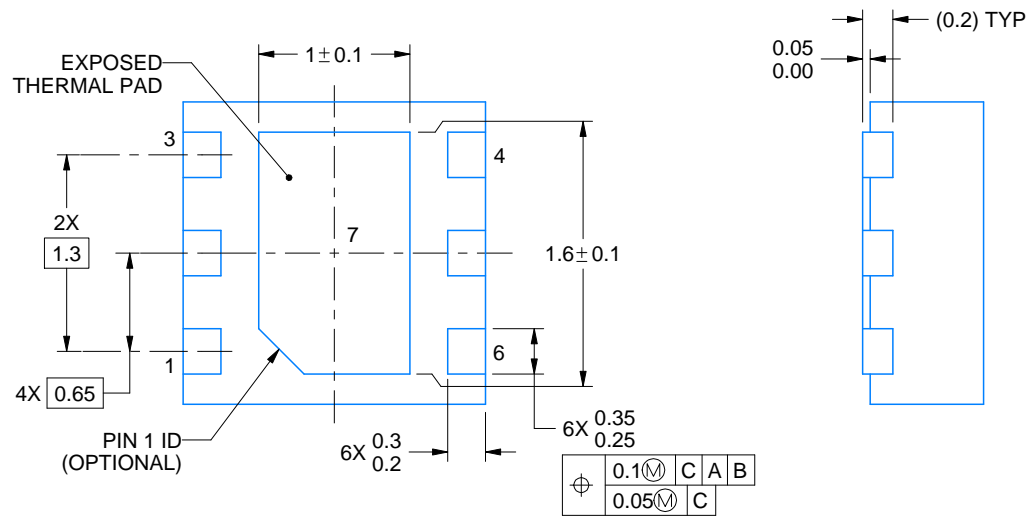
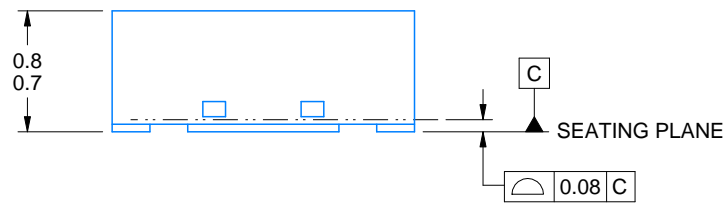
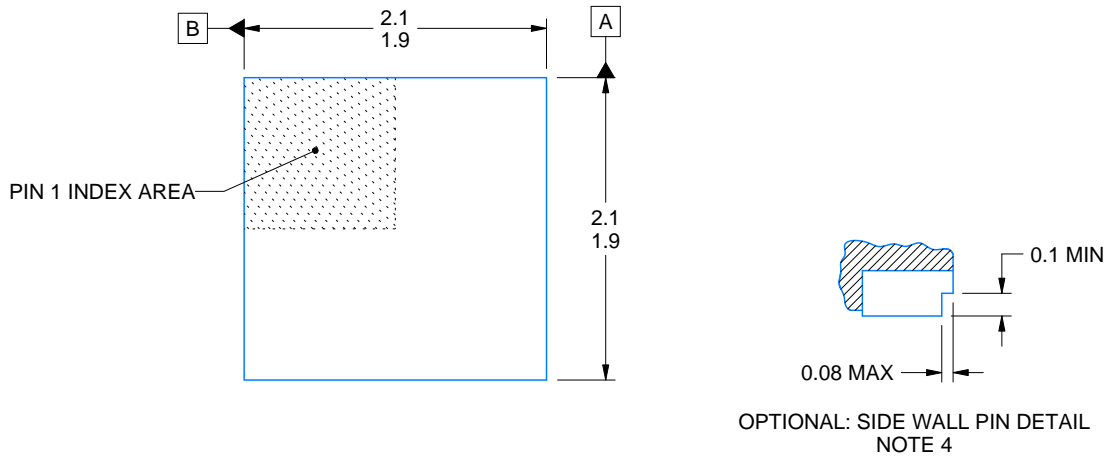
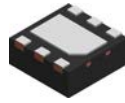

4222173/C 11/2025

NOTES:

1. All linear dimensions are in millimeters. Any dimensions in parenthesis are for reference only. Dimensioning and tolerancing per ASME Y14.5M.
2. This drawing is subject to change without notice.
3. The package thermal pad must be soldered to the printed circuit board for thermal and mechanical performance.
4. Minimum 0.1 mm solder wetting on pin side wall. Available for wettable flank version only.



# EXAMPLE STENCIL DESIGN

DRV0006A

WSON - 0.8 mm max height

PLASTIC SMALL OUTLINE - NO LEAD

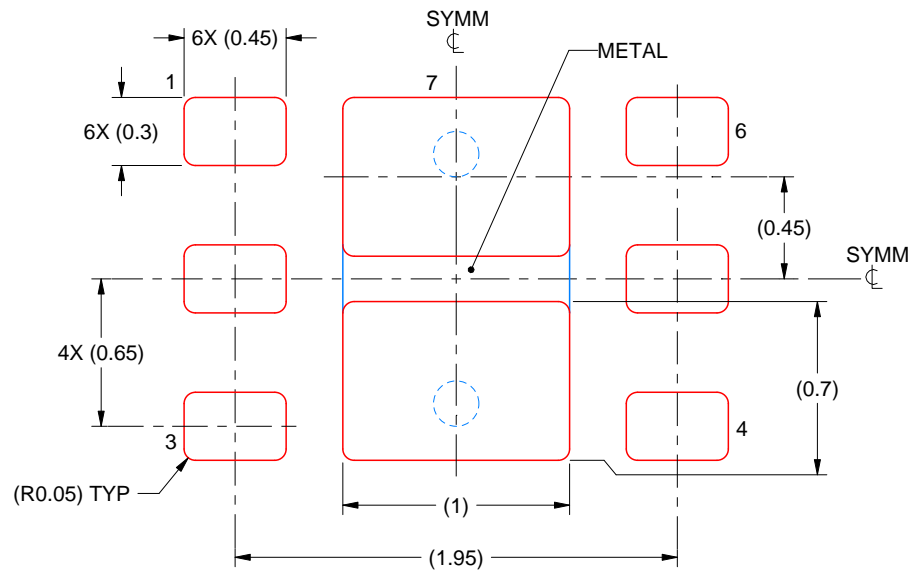

SOLDER PASTE EXAMPLE  
BASED ON 0.125 mm THICK STENCIL

EXPOSED PAD #7  
88% PRINTED SOLDER COVERAGE BY AREA UNDER PACKAGE  
SCALE:30X

4222173/C 11/2025

NOTES: (continued)

7. Laser cutting apertures with trapezoidal walls and rounded corners may offer better paste release. IPC-7525 may have alternate design recommendations.

## IMPORTANT NOTICE AND DISCLAIMER

TI PROVIDES TECHNICAL AND RELIABILITY DATA (INCLUDING DATASHEETS), DESIGN RESOURCES (INCLUDING REFERENCE DESIGNS), APPLICATION OR OTHER DESIGN ADVICE, WEB TOOLS, SAFETY INFORMATION, AND OTHER RESOURCES "AS IS" AND WITH ALL FAULTS, AND DISCLAIMS ALL WARRANTIES, EXPRESS AND IMPLIED, INCLUDING WITHOUT LIMITATION ANY IMPLIED WARRANTIES OF MERCHANTABILITY, FITNESS FOR A PARTICULAR PURPOSE OR NON-INFRINGEMENT OF THIRD PARTY INTELLECTUAL PROPERTY RIGHTS.

These resources are intended for skilled developers designing with TI products. You are solely responsible for (1) selecting the appropriate TI products for your application, (2) designing, validating and testing your application, and (3) ensuring your application meets applicable standards, and any other safety, security, regulatory or other requirements.

These resources are subject to change without notice. TI grants you permission to use these resources only for development of an application that uses the TI products described in the resource. Other reproduction and display of these resources is prohibited. No license is granted to any other TI intellectual property right or to any third party intellectual property right. TI disclaims responsibility for, and you fully indemnify TI and its representatives against any claims, damages, costs, losses, and liabilities arising out of your use of these resources.

TI's products are provided subject to [TI's Terms of Sale](#), [TI's General Quality Guidelines](#), or other applicable terms available either on [ti.com](http://ti.com) or provided in conjunction with such TI products. TI's provision of these resources does not expand or otherwise alter TI's applicable warranties or warranty disclaimers for TI products. Unless TI explicitly designates a product as custom or customer-specified, TI products are standard, catalog, general purpose devices.

TI objects to and rejects any additional or different terms you may propose.

Copyright © 2026, Texas Instruments Incorporated

Last updated 10/2025