

# TPSM83102 and TPSM83103 1.2A Output Current Buck-Boost Module

## 1 Features

- 1.6V to 5.5V input voltage range
  - Device input voltage > 1.65V for start-up
- 1V to 5.5V output voltage range(adjustable)
- High output current capability, 3A peak switch current
  - 1.5A output current for  $V_{IN} \geq 3V$ ,  $V_{OUT} = 3.3V$
  - 1.2A output current for  $V_{IN} \geq 2.7V$ ,  $V_{OUT} = 3.3V$
- High efficiency over the entire load range
  - 8 $\mu$ A typical quiescent current
  - Automatic power save mode and forced PWM mode configurable
- Peak current buck-boost mode architecture
  - Seamless mode transition
  - Forward and reverse current operation
  - Start-up into pre-biased outputs
  - Fixed-frequency operation with 2MHz switching
- Safety and robust operation features
  - Overcurrent protection and short-circuit protection
  - Integrated soft start with active ramp adoption
  - Overtemperature protection and overvoltage protection
  - True shutdown function with load disconnect
  - Forward and backward current limit
- Small solution size
  - 2.6mm × 2.0mm × 1.2mm(max) 8-pin  $\mu$ SiP package

## 2 Applications

- TWS
- System pre-regulator (smartphone, tablet, terminal, telematics)
- Point-of-load regulation (wired sensor, port/cable adapter, and dongle)
- Fingerprint, camera sensors (electronic smart lock, IP network camera)
- Voltage stabilizer (datacom, optical modules, cooling/heating)

## 3 Description

The TPSM83102 and TPSM83103 are constant frequency peak current mode control buck-boost converters in samll  $\mu$ SiP module package. It has a 3A peak current limit (typical) and 1.6V to 5.5V input voltage range, and provide a power supply solution for system pre-regulators and voltage stabilizers.

Depending on the input voltage, the TPSM83102 and TPSM83103 automatically operate in boost, buck, or in 3-cycle buck-boost mode when the input voltage is approximately equal to the output voltage. The transitions between modes happen at a defined duty cycle and avoid unwanted toggling within the modes to reduce output voltage ripple. 8 $\mu$ A quiescent current and power save mode power enable the highest efficiency for light to no-load conditions.

The device offers a very small solution size in  $\mu$ SiP module package.

### Package Information

Part Number	Package <sup>(1)</sup>	Body Size (NOM)
TPSM83102	$\mu$ SiP Module	2.6mm × 2.0mm × 1.2mm(max height)
TPSM83103	$\mu$ SiP Module	2.6mm × 2.0mm × 1.2mm(max height)

(1) For all available packages, see [Section 12](#).

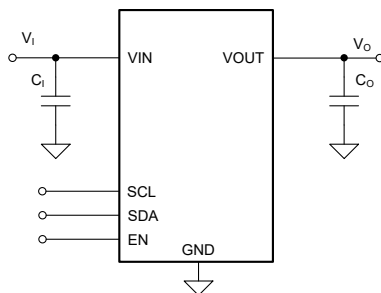

Typical Application

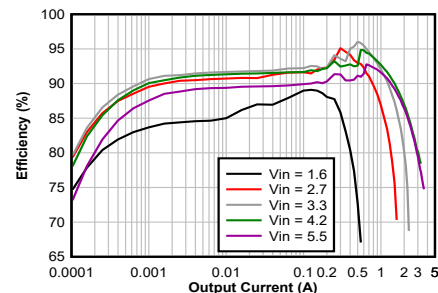

Efficiency vs Output Current ( $V_{OUT} = 3.3V$ )



## Table of Contents

<b>1 Features</b> .....	1	<b>8 Application and Implementation</b> .....	14
<b>2 Applications</b> .....	1	8.1 Application Information.....	14
<b>3 Description</b> .....	1	8.2 Typical Application.....	14
<b>4 Device Comparison Table</b> .....	3	<b>9 Layout</b> .....	20
<b>5 Pin Configuration and Functions</b> .....	3	9.1 Layout Guidelines.....	20
<b>6 Specifications</b> .....	4	9.2 Layout Example.....	20
6.1 Absolute Maximum Ratings.....	4	<b>10 Device and Documentation Support</b> .....	21
6.2 ESD Rating.....	4	10.1 Device Support .....	21
6.3 Recommended Operating Conditions.....	4	10.2 Receiving Notification of Documentation Updates..	21
6.4 Thermal Information.....	4	10.3 Support Resources.....	21
6.5 Electrical Characteristics .....	5	10.4 Trademarks.....	21
<b>7 Detailed Description</b> .....	6	10.5 Electrostatic Discharge Caution.....	21
7.1 Overview.....	6	10.6 Glossary.....	21
7.2 Functional Block Diagram.....	6	<b>11 Revision History</b> .....	22
7.3 Feature Description .....	6	<b>12 Mechanical, Packaging, and Orderable Information</b> .....	23
7.4 Device Functional Modes.....	8	12.1 Tape and Reel Information.....	23
7.5 Programming .....	8	12.2 Mechanical Data.....	25
7.6 Register Map.....	11		

## 4 Device Comparison Table

PART NUMBER	Default Setting of Internal EN <sup>(1)</sup>	I2C Peripheral Address
TPSM83102	CONVERTER_EN = 0	0x6A
TPSM831021	CONVERTER_EN = 0	0x68
TPSM831022	CONVERTER_EN = 0	0x69
TPSM831023	CONVERTER_EN = 0	0x6B
TPSM83103	CONVERTER_EN = 1	0x6A

(1) Refer to the register map.

## 5 Pin Configuration and Functions

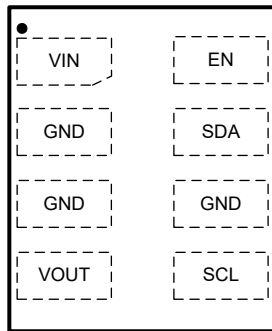

**Figure 5-1. 8-Pin SIU  $\mu$ SiP Module Package (Top View)**

**Table 5-1. Pin Functions**

PIN		I/O <sup>(1)</sup>	DESCRIPTION
NAME	NO.		
VIN	1	PWR	Supply input voltage
GND	2, 3, 6	PWR	Power ground
VOUT	4	PWR	Power stage output
SCL	5	I/O	I2C serial interface clock. Pull this pin up to the I2C bus voltage with a resistor or a current source.
SDA	7	I/O	I2C serial interface data. Pull this pin up to the I2C bus voltage with a resistor or a current source.
EN	8	I	Device enable. Set High to enable and Low to disable. It must not be left floating.

(1) PWR = power, I = input, I/O = input and output

## 6 Specifications

### 6.1 Absolute Maximum Ratings

over operating junction temperature range (unless otherwise noted)<sup>(1)</sup>

		MIN	MAX	UNIT
V <sub>I</sub>	Input voltage (VIN, VOUT, EN, SCL, SDA) <sup>(2)</sup>	-0.3	6.0	V
	Input voltage for less than 10 ns	-0.3	7	V
T <sub>J</sub>	Operating junction temperature	-40	150	°C
T <sub>stg</sub>	Storage temperature	-65	150	°C

- (1) Operation outside the Absolute Maximum Ratings may cause permanent device damage. Absolute Maximum Ratings do not imply functional operation of the device at these or any other conditions beyond those listed under Recommended Operating Conditions. If used outside the Recommended Operating Conditions but within the Absolute Maximum Ratings, the device may not be fully functional, and this may affect device reliability, functionality, performance, and shorten the device lifetime.
- (2) All voltage values are with respect to network ground terminal, unless otherwise noted.

### 6.2 ESD Rating

			VALUE	UNIT
V <sub>(ESD)</sub>	Electrostatic discharge	Human-body model (HBM), per ANSI/ESDA/JEDEC JS-001 <sup>(1)</sup>	±1000	V
		Charged-device model (CDM), per JEDEC specification JS-002 <sup>(2)</sup>	± 500	

- (1) JEDEC document JEP155 states that 500-V HBM allows safe manufacturing with a standard ESD control process.
- (2) JEDEC document JEP157 states that 250-V CDM allows safe manufacturing with a standard ESD control process.

### 6.3 Recommended Operating Conditions

over operating junction temperature (unless otherwise noted)

			MIN	NOM	MAX	UNIT
V <sub>I</sub>	Supply voltage		1.6		5.5	V
V <sub>O</sub>	Output voltage		1.0		5.5	V
C <sub>I</sub>	Effective Input capacitance	V <sub>I</sub> = 1.6 V to 5.5 V	4.2			μF
C <sub>O</sub>	Effective Output capacitance	1.2 V ≤ V <sub>O</sub> ≤ 3.6 V, nominal value at V <sub>O</sub> = 3.3 V	10.4	16.9	330	μF
		3.6 V < V <sub>O</sub> ≤ 5.5 V, nominal value at V <sub>O</sub> = 5 V	7.95	10.6	330	μF
L	Effective Inductance		0.7	1	1.3	μH
T <sub>J</sub>	Operating junction temperature range		-40		125	°C

### 6.4 Thermal Information

over operating free-air temperature range (unless otherwise noted)

THERMAL METRIC		TPSM83102 TPSM83103		UNIT
		uSiP-SIU		
		8		
R <sub>θJA</sub>	Junction-to-ambient thermal resistance	100		°C/W
R <sub>θJC(top)</sub>	Junction-to-case (top) thermal resistance	42.2		°C/W
R <sub>θJB</sub>	Junction-to-board thermal resistance	33.2		°C/W
Ψ <sub>JT</sub>	Junction-to-top characterization parameter	N/A		°C/W
Ψ <sub>JB</sub>	Junction-to-board characterization parameter	32.2		°C/W
R <sub>θJC(bot)</sub>	Junction-to-case (bottom) thermal resistance	N/A		°C/W

## 6.5 Electrical Characteristics

Over operating junction temperature range and recommended supply voltage range (unless otherwise noted). Typical values are at  $V_I = 3.8\text{ V}$ ,  $V_O = 3.3\text{ V}$  and  $T_J = 25^\circ\text{C}$  (unless otherwise noted).

PARAMETER		TEST CONDITIONS		MIN	TYP	MAX	UNIT	
<b>SUPPLY</b>								
$I_{SD}$	Shutdown current into VIN	$V_I = 3.8\text{ V}$ , $V_{(EN)} = 0\text{ V}$	$T_J = 25^\circ\text{C}$		0.5	0.9	$\mu\text{A}$	
$I_Q$	Quiescent current into VIN	$V_I = 2.2\text{ V}$ , $V_O = 3.3\text{ V}$ , $V_{(EN)} = 2.2\text{ V}$ , no switching			0.15	6.1	$\mu\text{A}$	
$I_Q$	Quiescent current into VOUT	$V_I = 2.2\text{ V}$ , $V_O = 3.3\text{ V}$ , $V_{(EN)} = 2.2\text{ V}$ , no switching			8		$\mu\text{A}$	
$V_{IT+}$	Positive-going UVLO threshold voltage			1.5	1.55	1.599	V	
$V_{IT-}$	Negative-going UVLO threshold voltage	During start-up		1.4	1.45	1.499	V	
$V_{hys}$	UVLO threshold voltage hysteresis			99			mV	
$V_{I(POR)T+}$	Positive-going POR threshold voltage	maximum of $V_I$ or $V_O$		1.25	1.45	1.65	V	
$V_{I(POR)T-}$	Negative-going POR threshold voltage			1.22	1.43	1.6	V	
<b>I/O SIGNALS</b>								
$V_{T+}$	Positive-going threshold voltage	EN, MODE		0.77	0.98	1.2	V	
$V_{T-}$	Negative-going threshold voltage	EN, MODE		0.5	0.66	0.76	V	
$V_{hys}$	Hysteresis voltage	EN, MODE			300		mV	
$I_{IH}$	High-level input current	(EN, MODE)	$V_{(EN)} = V_{(MODE)} = 1.5\text{ V}$ , no pullup resistor		$\pm 0.01$	$\pm 0.25$	$\mu\text{A}$	
$I_{IL}$	Low-level input current	(EN, MODE)	$V_{(EN)} = V_{(MODE)} = 0\text{ V}$ ,		$\pm 0.01$	$\pm 0.1$	$\mu\text{A}$	
	Input bias current	(EN, MODE)	$V_{(EN)} = 5.5\text{ V}$		$\pm 0.01$	$\pm 0.3$	$\mu\text{A}$	
<b>POWER SWITCH</b>								
$r_{DS(on)}$	On-state resistance	Q1	$V_I = 3.8\text{ V}$ , $V_O = 3.3\text{ V}$ , test current = 0.2 A		45		m $\Omega$	
		Q2			50		m $\Omega$	
		Q3			50		m $\Omega$	
		Q4			85		m $\Omega$	
<b>CURRENT LIMIT</b>								
$I_{L(PEAK)}$	Switch peak current limit <sup>(1)</sup>	Q1	$V_{in}=3.8\text{V}$ , $V_O = 3.3\text{ V}$	Output sourcing current	2.6	3	3.35	A
	PFM mode entry threshold (peak) current <sup>(1)</sup>		$I_O$ falling			145		mA
<b>OUTPUT</b>								
<b>CONTROL[FEEDBACK PIN]</b>								
<b>PROTECTION FEATURES</b>								
$V_{T+(OVP)}$	Positive-going OVP threshold voltage				5.55	5.75	5.95	V
$V_{T+(IVP)}$	Positive-going IVP threshold voltage				5.55	5.75	5.95	V
<b>TIMING PARAMETERS</b>								
$t_{d(EN)}$	Delay between a rising edge on the EN pin and the start of the output voltage ramp				0.87	1.5		ms
$t_{d(ramp)}$	Soft-start ramp time				6.42	7.55	8.68	ms
$f_{sw}$	Switching frequency				1.8	2	2.2	MHz

(1) Current limit production test are performed under DC conditions. The current limit in operation is somewhat higher and depending on propagation delay and the applied external components

## 7 Detailed Description

### 7.1 Overview

The TPSM83102 and TPSM83103 is a constant frequency peak current mode control buck-boost converter. The converter uses a fixed-frequency topology with approximately 2-MHz switching frequency. The modulation scheme has three clearly defined operation modes where the converters enter with defined thresholds over the full operation range of  $V_{IN}$  and  $V_{OUT}$ . The maximum output current is determined by the Q1 peak current limit, which is typically 3 A.

### 7.2 Functional Block Diagram

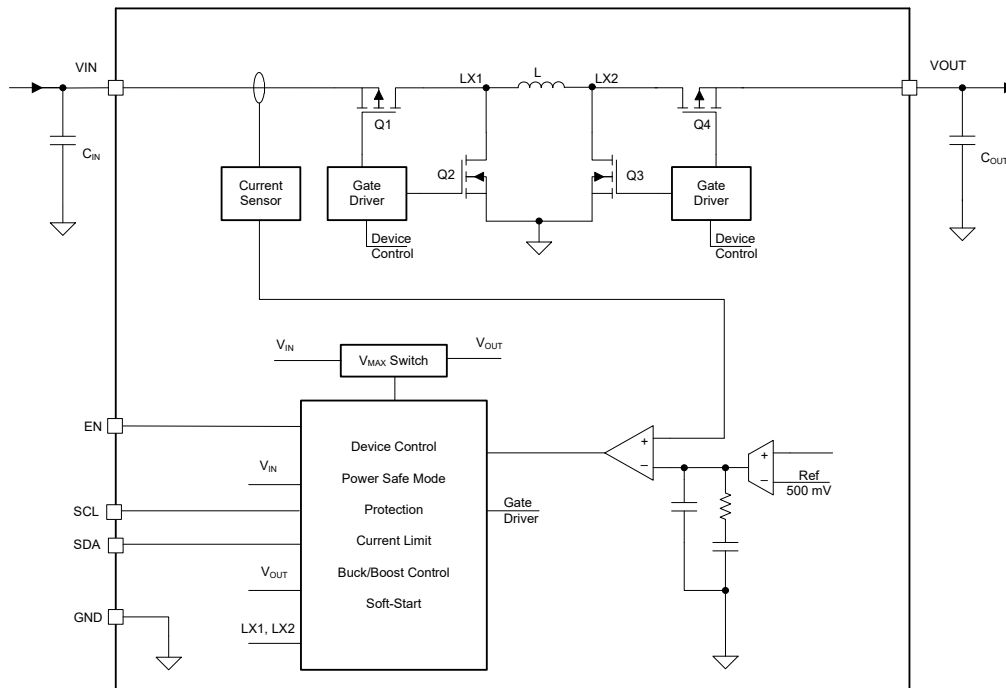

### 7.3 Feature Description

#### 7.3.1 Undervoltage Lockout (UVLO)

The input voltage of the VIN pin is continuously monitored if the device is not in shutdown mode. UVLO only stops or starts the converter operation. The UVLO does not impact the core logic of the device. UVLO avoids a brownout of the device during device operation. In case the supply voltage on the VIN pin is lower than the negative-going threshold of UVLO, the converter stops its operation. To avoid a false disturbance of the power conversion, the UVLO falling threshold logic signal is digitally de-glitched.

If the supply voltage on the VIN pin recovers to be higher than the UVLO rising threshold, the converter returns to operation. In this case, the soft-start procedure restarts faster than under start-up without a pre-biased output.

### 7.3.2 Enable and Soft Start

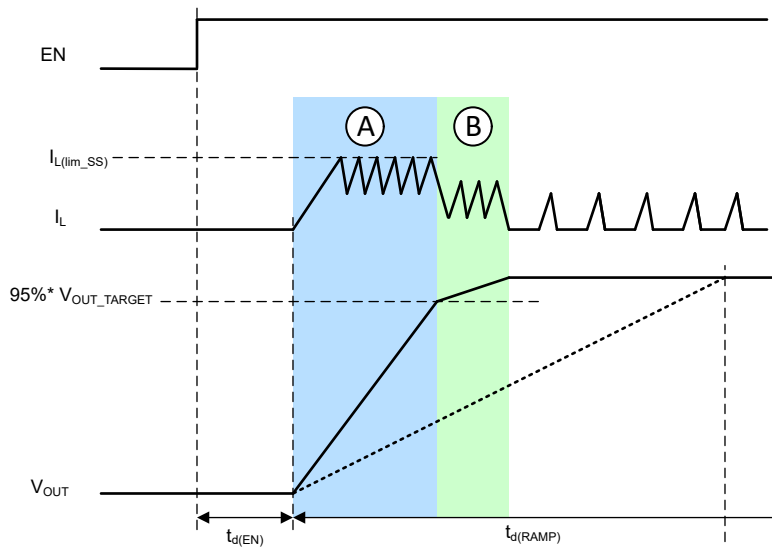

**Figure 7-1. Typical Soft-Start Behavior**

When the input voltage is above the UVLO rising threshold and the EN pin is pulled to a voltage above 1.2 V, the TPSM83102 and TPSM83103 are enabled and start up after a short delay time,  $t_{d(EN)}$ .

The devices have an inductor peak current clamp to limit the inrush current during start-up. When the minimum current clamp ( $I_{L(lim\_SS)}$ ) is lower than the current that is necessary to follow the voltage ramp, the current automatically increases to follow the voltage ramp. The minimum current limit ensures as fast as possible soft start if the capacitance is chosen lower than what the ramp time  $t_{d(RAMP)}$  was selected for.

In a typical start-up case as shown in [Figure 7-1](#) (low output load, typical output capacitance), the minimum current clamp limits the inrush current and charges the output capacitor. The output voltage then rises faster than the reference voltage ramp (see phase A in [Figure 7-1](#)). To avoid an output overshoot, the current clamp is deactivated when the output is close to the target voltage and follows the reference voltage ramp slew value given by the voltage ramp, which is finishing the start up (see phase B in [Figure 7-1](#)). The transition from the minimum current clamp operation is sensed by using the threshold  $95\% V_{out\_target}$ . After phase B, the output voltage is well regulated to the nominal target voltage. The current waveform depends on the output load and operation mode.

### 7.3.3 Adjustable Output Voltage

The output voltage is adjusted by the I2C control. Please refer to the part of "Programming" and "Register Map" for the Vout settings.

### 7.3.4 Reverse Current Operation

The device can support reverse current operation in FPWM mode (the current flows from VOUT pin to VIN pin). If the output feedback voltage on the FB pin is higher than the reference voltage, the converter regulation forces a current into the input capacitor. The reverse current operation is independent of the  $V_{IN}$  voltage or  $V_{OUT}$  voltage ratio, hence it is possible on all device operation modes boost, buck, or buck-boost.

### 7.3.5 Protection Features

The following sections describe the protection features of the device.

#### 7.3.5.1 Input Overvoltage Protection

The TPSM83102 and TPSM83103 have input overvoltage protection which avoids any damage to the device in case the current flows from the output to the input and the input source cannot sink current (for example, a diode in the supply path).

If forced PWM mode is active, the current can go negative until it reaches the sink current limit. Once the input voltage threshold,  $V_{T+(IVP)}$ , is reached on the VIN pin, the protection disables forced PWM mode and only allows current to flow from VIN to VOUT. After the input voltage drops under the input voltage protection threshold, forced PWM mode can be activated again.

### 7.3.5.2 Short Circuit Protection

The device features peak current limit performance at short circuit protection. Figure 7-2 shows a typical device behavior of an short/overload event of the short circuit protection.

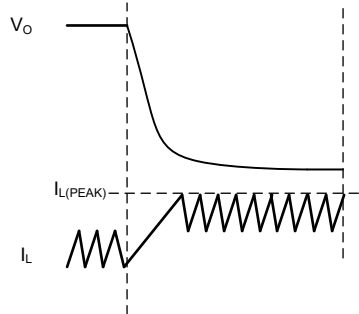

Figure 7-2. Typical Device Behavior During Short Circuit Protection

### 7.3.5.3 Thermal Shutdown

To avoid thermal damage of the device, the temperature of the die is monitored. The device stops operation once the sensed temperature rises over the thermal threshold. After the temperature drops below the thermal shutdown hysteresis, the converter returns to normal operation.

## 7.4 Device Functional Modes

The device has two functional modes: off and on. The device enters the on mode when the voltage on the VIN pin is higher than the UVLO threshold and a high logic level is applied to the EN pin. The device enters the off mode when the voltage on the VIN pin is lower than the UVLO threshold or a low logic level is applied to the EN pin.

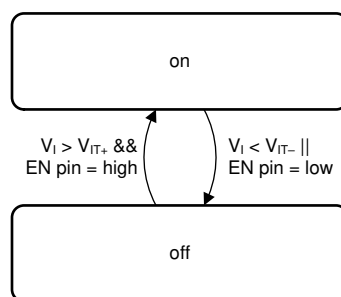

Figure 7-3. Device Functional Modes

## 7.5 Programming

### 7.5.1 Serial Interface Description

I<sup>2</sup>C is a 2-wire serial interface developed by Philips Semiconductor, now NXP Semiconductors (see [NXP Semiconductors, UM10204 – I<sup>2</sup>C-Bus Specification and User Manual](#)). The bus consists of a data line (SDA) and a clock line (SCL) with pullup structures. When the bus is idle, both SDA and SCL lines are pulled high. All the I<sup>2</sup>C-compatible devices connect to the I<sup>2</sup>C bus through open-drain I/O pins, SDA, and SCL. A controller device, usually a microcontroller or a digital signal processor, controls the bus. The controller is responsible for generating the SCL signal and device addresses. The controller also generates specific conditions that indicate



the START and STOP of data transfer. A peripheral device receives and transmits data on the bus under control of the controller device.

The device works as a peripheral and supports the following data transfer modes, as defined in the I<sup>2</sup>C-Bus Specification:

- Standard-mode (100 kbps)
- Fast-mode (400 kbps)
- Fast-mode Plus (1 Mbps)

The interface adds flexibility to the power supply solution, enabling most functions to be programmed to new values, depending on the instantaneous application requirements. Register contents remain intact as long as supply voltage remains above  $V_{IT+(POR)}$ .

The data transfer protocol for standard and fast modes is exactly the same, therefore, it is referred to as F/S-mode in this document. The device supports 7-bit addressing; 10-bit addressing and general call address are not supported. The device 7-bit address is 6Ah (01101010b).

To make sure that the I<sup>2</sup>C function in the device is correctly reset, it is recommended that the I<sup>2</sup>C controller initiates a STOP condition on the I<sup>2</sup>C bus after the initial power up of SDA and SCL pullup voltages.

### 7.5.2 Standard-, Fast-, and Fast-Mode Plus Protocol

The controller initiates a data transfer by generating a start condition. The start condition is when a high-to-low transition occurs on the SDA line while SCL is high, as shown in Figure 7-4. All I<sup>2</sup>C-compatible devices recognize a start condition.

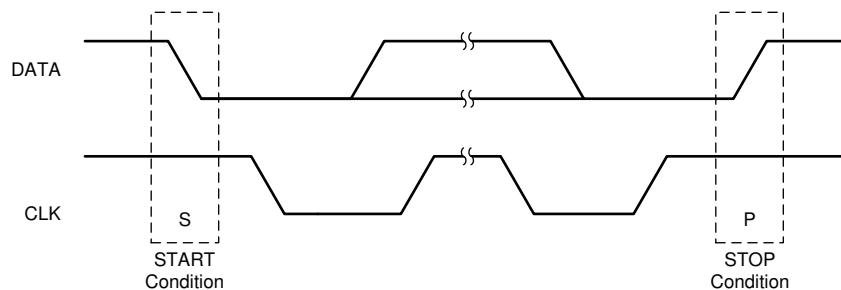

**Figure 7-4. START and STOP Conditions**

The controller then generates the SCL pulses and transmits the 7-bit address and the read/write direction bit, R/W, on the SDA line. During all transmissions, the controller ensures that data is valid. A valid data condition requires the SDA line to be stable during the entire high period of the clock pulse (see Figure 7-5). All devices recognize the address sent by the controller and compare it to their internal fixed addresses. Only the peripheral device with a matching address generates an acknowledge (see Figure 7-6) by pulling the SDA line low during the entire high period of the ninth SCL cycle. Upon detecting this acknowledge, the controller knows that communication link with a peripheral has been established.

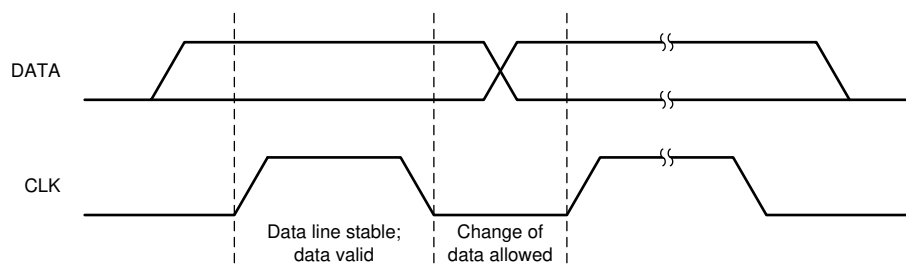

**Figure 7-5. Bit Transfer on the Serial Interface**

The controller generates further SCL cycles to either transmit data to the peripheral (R/W bit 1) or receive data from the peripheral (R/W bit 0). In either case, the receiver needs to acknowledge the data sent by the transmitter. An acknowledge signal can either be generated by the controller or by the peripheral, depending on which one is the receiver. 9-bit valid data sequences consisting of 8-bit data and 1-bit acknowledge can continue as long as necessary.

To signal the end of the data transfer, the controller generates a stop condition by pulling the SDA line from low to high while the SCL line is high (see Figure 7-4). This releases the bus and stops the communication link with the addressed peripheral. All I<sup>2</sup>C-compatible devices must recognize the stop condition. Upon the receipt of a stop condition, all devices know that the bus is released and they wait for a start condition followed by a matching address.

Attempting to read data from register addresses not listed in this section results in 00h being read out.

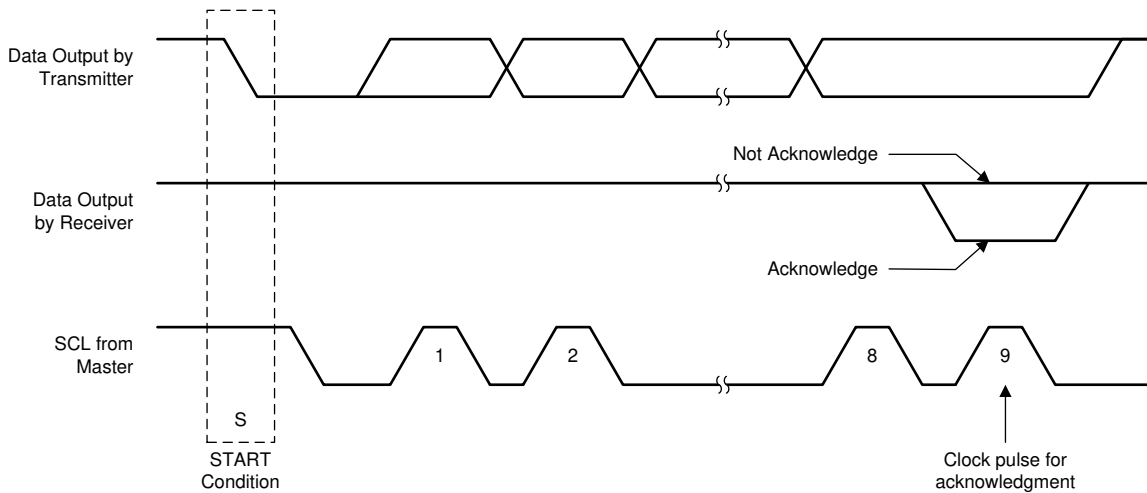

Figure 7-6. Acknowledge on the I<sup>2</sup>C Bus

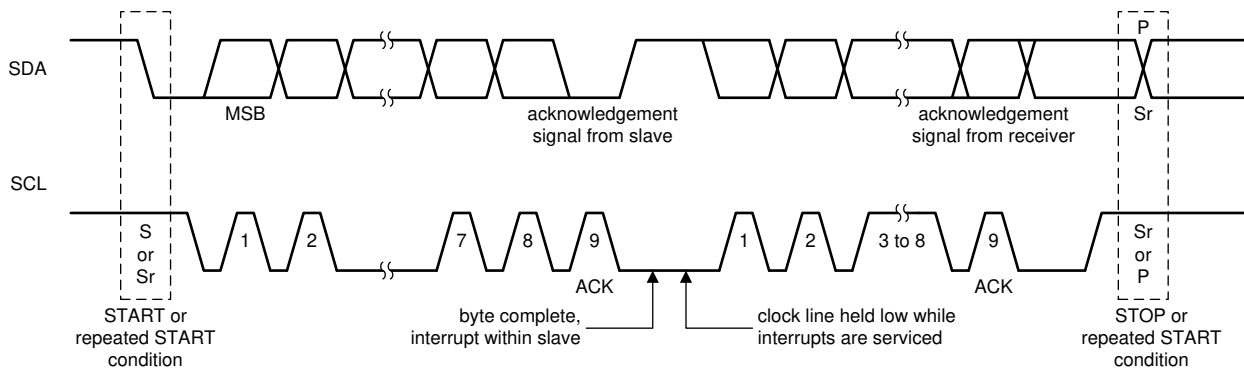

Figure 7-7. Bus Protocol

### 7.5.3 I<sup>2</sup>C Update Sequence

A single update requires the following:

- A start condition
- A valid I<sup>2</sup>C peripheral address
- A register address
- A data byte

To acknowledge the receipt of each byte, the device pulls the SDA line low during the high period of a single clock pulse. The device performs an update on the falling edge of the acknowledge signal that follows the last byte.

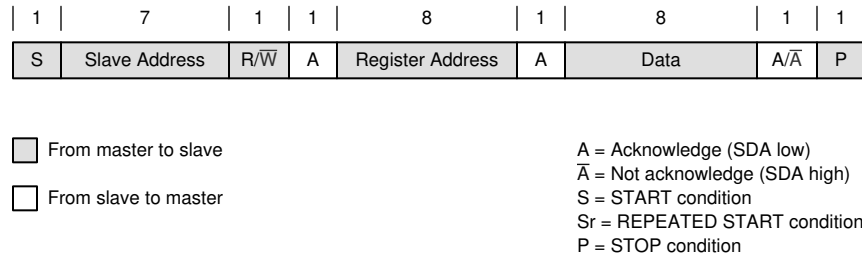

**Figure 7-8. “Write” Data Transfer Format in Standard, Fast, and Fast-Plus Modes**

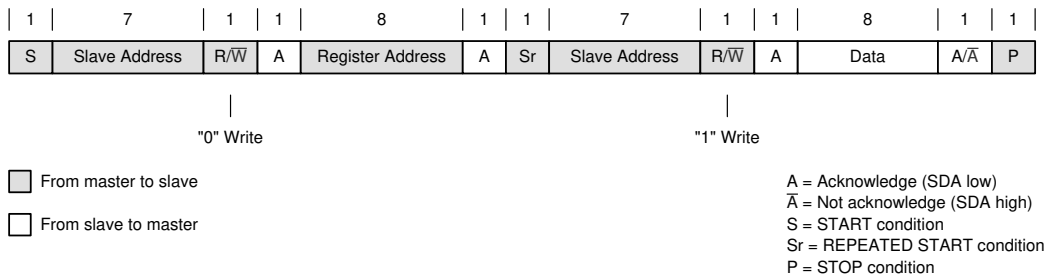

**Figure 7-9. “Read” Data Transfer Format in Standard, Fast, and Fast-Plus Modes**

## 7.6 Register Map

### 7.6.1 Register Description

#### 7.6.1.1 Register Map

**Table 7-1. Register Map**

ADDRESS	ACRONYM	REGISTER NAME	SECTION
0x02	CONTROL1	Control 1 Register	<a href="#">Go</a>
0x03	VOUT	VOUT Register	<a href="#">Go</a>
0x05	CONTROL2	Control 2 Register	<a href="#">Go</a>

#### 7.6.1.2 Register CONTROL1 (Register address: 0x02; Default: 0x08)

Return to [Register Map](#)

**Table 7-2. Register CONTROL1 Format**

7	6	5	4	3	2	1	0
NIL[3:0]				NIL	EN_SCP	NIL	CONVERTER_EN
R				R	R/W	R	R/W

LEGEND: R/W = Read/Write; R = Read only

SCP: Short Circuit Protection

**Table 7-3. Register CONTROL1 Field Descriptions**

Bit	Field	Type	Reset	Description
7:4	NIL	R	0b0000	Not used. During write operations data for these bits are ignored. During read operations 0 is returned
3	EN_FAST_DVS	R/W	0b1	Sets DVS to fast mode 0 : DISABLE, 1 : ENABLE
2	EN_SCP	R/W	0b0	Enable short circuit hiccup protection 0 : DISABLE, 1 : ENABLE
1	NIL	R	0b0	Not used.
0	CONVERTER_EN	R/W	0b0	Enable Converter ('AND'ed with EN-pin) 0 : DISABLE, 1 : ENABLE

**7.6.1.3 Register VOUT (Register address: 0x03; Default: 0x5C)**Return to [Register Map](#)**Table 7-4. Register VOUT Format**

7	6	5	4	3	2	1	0
VOUT[7 :0]							
R/W							

LEGEND: R/W = Read/Write

**Table 7-5. Register VOUT Field Descriptions**

Bit	Field	Type	Reset	Description
7:0	VOUT[7:0]	R/W	0x5C	These bits set the output voltage Output voltage = $1.000 + (\text{VOUT}[7 :0] \times 0.025)$ V when $0x00 \leq \text{VOUT}[7 :0] \leq 0xB4$ ; Output voltage = 5.5V when $0xB5 \leq \text{VOUT}[7 :0] \leq 0xFF$

**7.6.1.4 Register CONTROL2 (Register address: 0x05; Default: 0x45)**Return to [Register Map](#)**Table 7-6. Register CONTROL2 Format**

7	6	5	4	3	2	1	0
FPWM	FAST_RAMP_EN	EN_DISCH_VOUT[1:0]		CL_RAMP_MIN	TD_RAMP[2:0]		
R/W	R/W	R/W		R/W	R/W		

LEGEND: R/W = Read/Write

**Table 7-7. Register CONTROL2 Field Descriptions**

Bit	Field	Type	Reset	Description
7	FPWM	R/W	0b0	Force PWM operation 0 : DISABLE, 1 : ENABLE
6	FAST_RAMP_EN	R/W	0b1	Device can start-up faster then VOUT ramp 0 : DISABLE, 1 : ENABLE
5:4	EN_DISCH_VOUT[1:0]	R/W	0b00	Enable of BUBO Vout Discharge 00 : DISABLE 01 : SLOW (34mA) 10 : MEDIUM (67mA) 11 : FAST (100mA)
3	CL_RAMP_MIN	R/W	0b0	Define the minimum current limit during the soft start ramp 0 : Low (500mA) 1 : High (2x Low)
2:0	TD_RAMP[2:0]	R/W	0b101	Defines the ramp time for the Vo soft start ramp 000: 0.256ms 001: 0.512ms 010: 1.024ms 011: 1.920ms 100: 3.584ms 101: 7.552ms 110: 9.600ms 111: 24.320ms

## 8 Application and Implementation

### Note

Information in the following applications sections is not part of the TI component specification, and TI does not warrant its accuracy or completeness. TI's customers are responsible for determining suitability of components for their purposes, as well as validating and testing their design implementation to confirm system functionality.

### 8.1 Application Information

The TPSM83102 and TPSM83103 are a high-efficiency, low-quiescent current, buck-boost modules. The devices are suitable for applications needing a regulated output voltage from an input supply that can be higher or lower than the output voltage. The output voltage can be set from 1.0V to 5.5V conveniently by I2C.

### 8.2 Typical Application

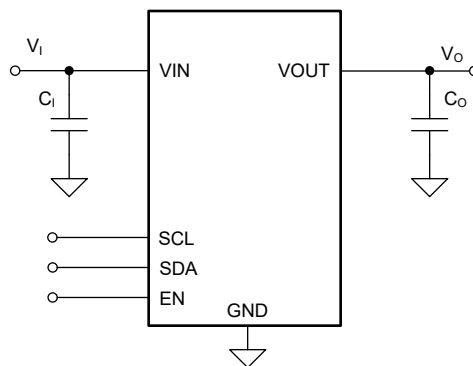

Figure 8-1. 3.3-V<sub>OUT</sub> Typical Application

#### 8.2.1 Design Requirements

The design parameters are listed in [Table 8-1](#).

Table 8-1. Design Parameters

PARAMETERS	VALUES
Input voltage	2.7 V to 4.3 V
Output voltage	3.3 V
Output current	1.5 A

#### 8.2.2 Detailed Design Procedure

The first step is the selection of the output filter components. To simplify this process, [Section 6.3](#) outlines minimum and maximum values for capacitance. Pay attention to the tolerance and derating when selecting nominal capacitance.

##### 8.2.2.1 Custom Design with WEBENCH Tools

[Click here](#) to create a custom design using the TPSM83102 and TPSM83103 devices with the WEBENCH® Power Designer.

1. Start by entering your  $V_{IN}$ ,  $V_{OUT}$  and  $I_{OUT}$  requirements.
2. Optimize your design for key parameters like efficiency, footprint or cost using the optimizer dial and compare this design with other possible solutions from Texas Instruments.
3. WEBENCH Power Designer provides you with a customized schematic along with a list of materials with real time pricing and component availability.
4. In most cases, you can:
  - Run electrical simulations to see important waveforms and circuit performance,

- Run thermal simulations to understand the thermal performance of your board,
  - Export your customized schematic and layout into popular CAD formats,
  - Print PDF reports for the design, and share your design with colleagues.
5. Get more information about WEBENCH tools at [www.ti.com/webench](http://www.ti.com/webench).

### 8.2.2.2 Output Capacitor Selection

For the output capacitor, use small ceramic capacitors placed as close as possible to the VOUT and PGND pins of the IC. The recommended nominal output capacitor value is a single 47µF. If, for any reason, the application requires the use of large capacitors that cannot be placed close to the IC, use a smaller ceramic capacitor in parallel to the large capacitor. and place the small capacitor as close as possible to the VOUT and PGND pins of the module.

It is important that the effective capacitance is given according to the recommended value in [Section 6.3](#). In general, consider DC bias effects resulting in less effective capacitance. The choice of the output capacitance is mainly a tradeoff between size and transient behavior as higher capacitance reduces transient response over/undershoot and increases transient response time. Possible output capacitors are listed in [Table 8-2](#).

**Table 8-2. List of Recommended Capacitors**

CAPACITOR VALUE [µF]	VOLTAGE RATING [V]	ESR [mΩ]	PART NUMBER	MANUFACTURER <sup>(1)</sup>	SIZE (METRIC)
47	6.3	10	GRM219R60J476ME44	Murata	0805 (2012)
47	10	40	CL10A476MQ8QRN	Semco	0603 (1608)

(1) See the [Section 10.1.1](#).

### 8.2.2.3 Input Capacitor Selection

A 22µF input capacitor is recommended to improve line transient behavior of the regulator and EMI behavior of the total power supply circuit. An X5R or X7R ceramic capacitor placed as close as possible to the VIN and PGND pins of the module is recommended. This capacitance can be increased without limit. If the input supply is located more than a few inches from the TPSM83102 or TPSM83103, additional bulk capacitance can be required in addition to the ceramic bypass capacitors. An electrolytic or tantalum capacitor with a value of 47µF is a typical choice.

**Table 8-3. List of Recommended Capacitors**

CAPACITOR VALUE [µF]	VOLTAGE RATING [V]	ESR [mΩ]	PART NUMBER	MANUFACTURER <sup>(1)</sup>	SIZE (METRIC)
22	6.3	43	GRM187R61A226ME15	Murata	0603 (1608)
10	10	40	GRM188R61A106ME69	Murata	0603 (1608)

(1) See the [Section 10.1.1](#).

### 8.2.2.4 Setting the Output Voltage

The output voltage is set by I2C. Please refer to the part of "Register Vout" for the detailed output voltage settings.

### 8.2.3 Application Curves

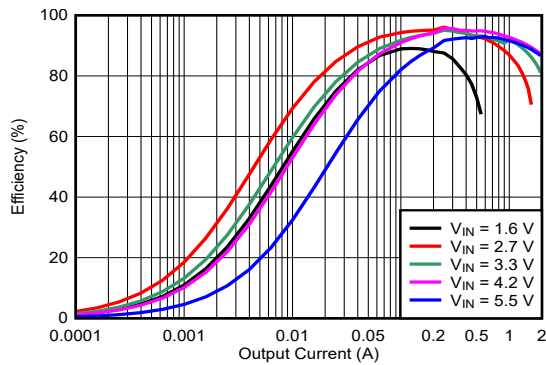

$V_{OUT} = 3.3V$        $MODE = High$

**Figure 8-2. Efficiency vs Output Current (FPWM)**

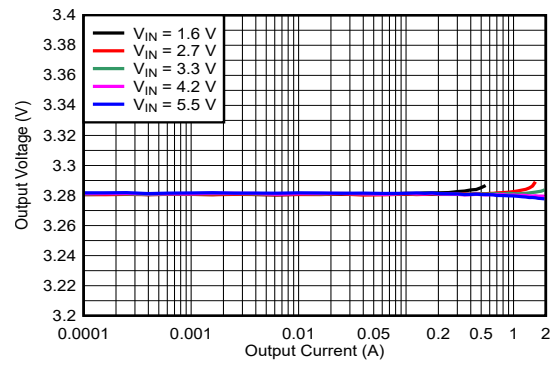

$V_{OUT} = 3.3V$        $MODE = High$

**Figure 8-3. Load Regulation (FPWM)**

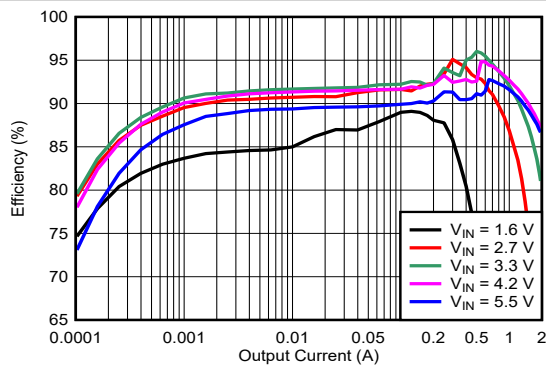

$V_{OUT} = 3.3V$        $MODE = Low$

**Figure 8-4. Efficiency vs Input Voltage (PFM)**

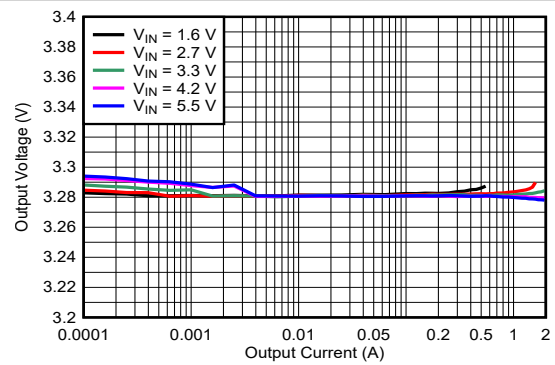

$V_O = 3.3V$        $MODE = High$

**Figure 8-5. Load Regulation (PFM)**

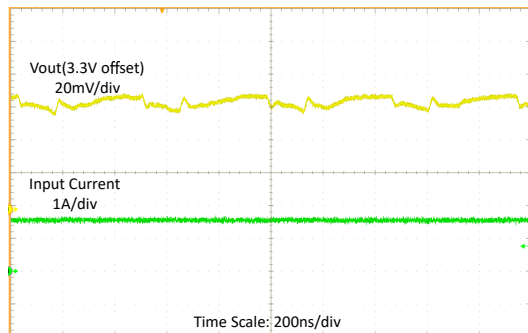

$V_{IN} = 2.7V, V_{OUT} = 3.3V$        $I_{OUT} = 1A, MODE = Low$

**Figure 8-6. Switching Waveforms, Boost Operation with 1A Load**

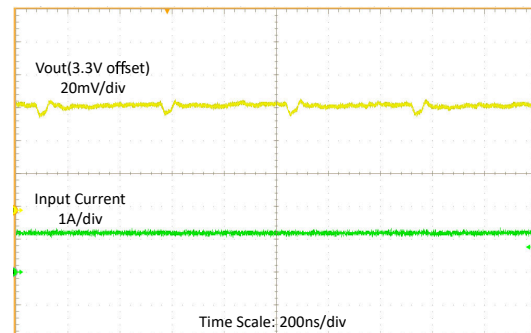

$V_{IN} = 3.3V, V_{OUT} = 3.3V$        $I_{OUT} = 1A, MODE = Low$

**Figure 8-7. Switching Waveforms with 1A Load**



### 8.2.3 Application Curves (continued)

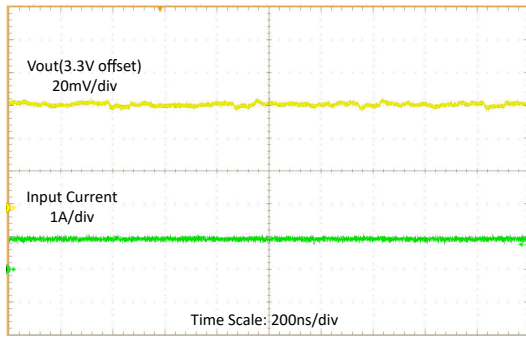

$V_{IN} = 4.3V$ ,  $V_{OUT} = 3.3V$   $I_{OUT} = 1A$ , MODE = Low

**Figure 8-8. Switching Waveforms, Buck Operation with 1A Load**

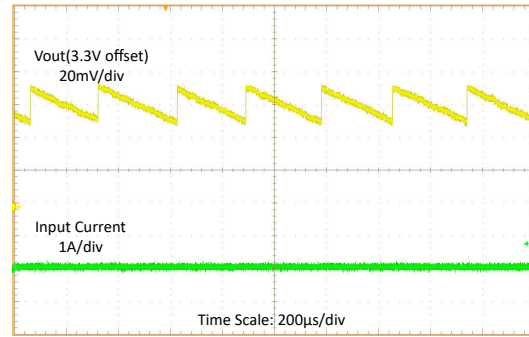

$V_{IN} = 3.6V$ ,  $V_{OUT} = 3.3V$   $I_{OUT} = 1mA$ , MODE = Low

**Figure 8-9. Switching Waveforms at 1mA Load**

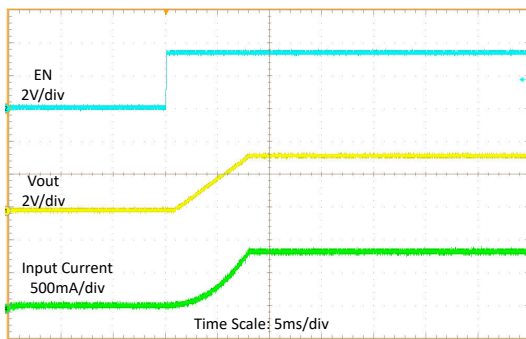

$V_{IN} = 3.6V$ ,  $V_{OUT} = 3.3V$   $R_{load} = 4\Omega$ , MODE = Low

**Figure 8-10. Start-Up by EN**

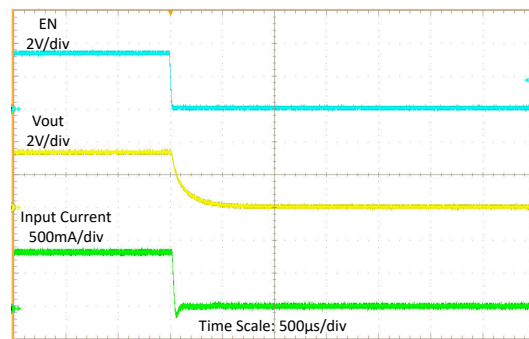

$V_{IN} = 3.6V$ ,  $V_{OUT} = 3.3V$   $R_{load} = 4\Omega$ , MODE = Low

**Figure 8-11. Shutdown by EN**

**8.2.3 Application Curves (continued)**

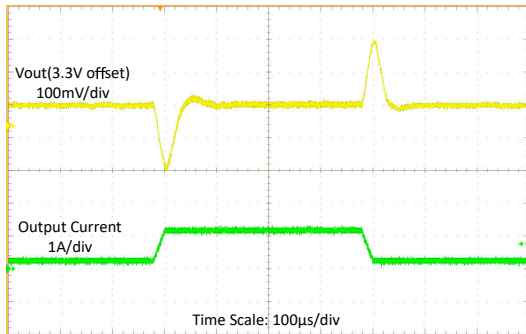

$V_{IN} = 2.7V, V_{OUT} = 3.3V$   $I_{OUT} = 100mA$  to 1A with 20µs slew rate

**Figure 8-12. Load Transient at 2.7V Input Voltage**

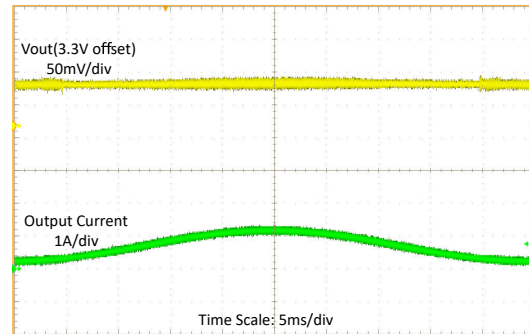

$V_{IN} = 2.7V, V_{OUT} = 3.3V$   $I_{OUT} = 100mA$  to 1A sweep

**Figure 8-13. Load Sweep at 2.7V Input Voltage**

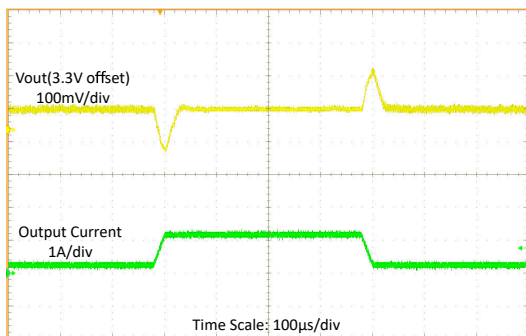

$V_{IN} = 3.6V, V_{OUT} = 3.3V$   $I_{OUT} = 100mA$  to 1A with 20µs slew rate

**Figure 8-14. Load Transient at 3.6-V Input Voltage**

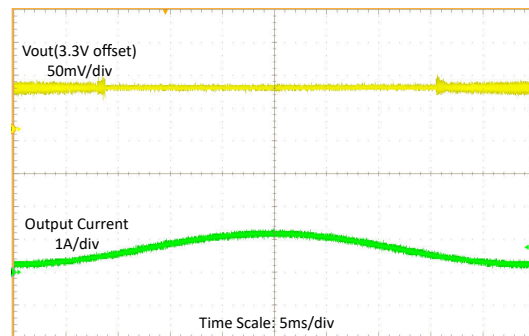

$V_{IN} = 3.6V, V_{OUT} = 3.3V$   $I_{OUT} = 100mA$  to 1A sweep

**Figure 8-15. Load Sweep at 3.6-V Input Voltage**

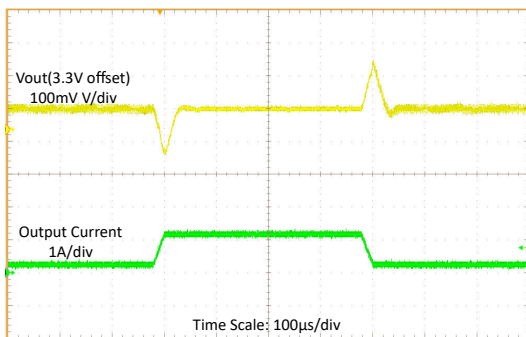

$V_{IN} = 4.3V, V_{OUT} = 3.3V$   $I_{OUT} = 100mA$  to 1A with 20µs slew rate

**Figure 8-16. Load Transient at 4.3-V Input Voltage**

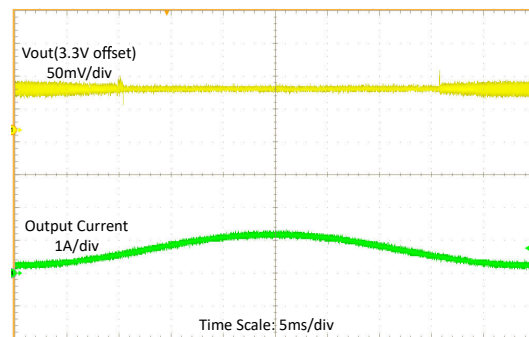

$V_{IN} = 4.3V, V_{OUT} = 3.3V$   $I_{OUT} = 100mA$  to 1A sweep

**Figure 8-17. Load Sweep at 4.3-V Input Voltage**

### 8.2.3 Application Curves (continued)

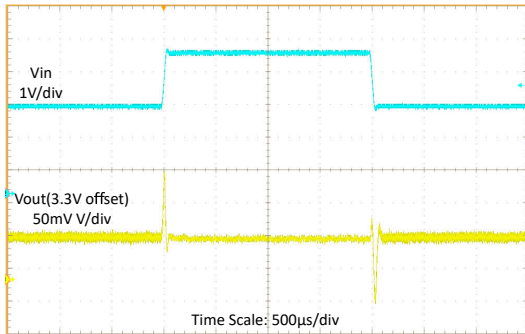

$V_{IN} = 2.7V$  to  $4.3V$  with  $20\mu s$  slew rate,  $V_{OUT} = 3.3V$

**Figure 8-18. Line Transient at 1-A Load Current**

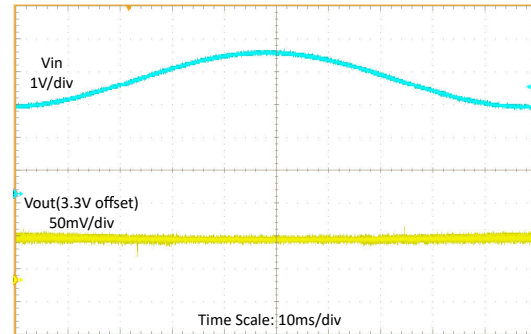

$V_{IN} = 2.7V$  to  $4.3V$  sweep,  $V_{OUT} = 3.3V$

**Figure 8-19. Line Sweep at 1-A Load Current**

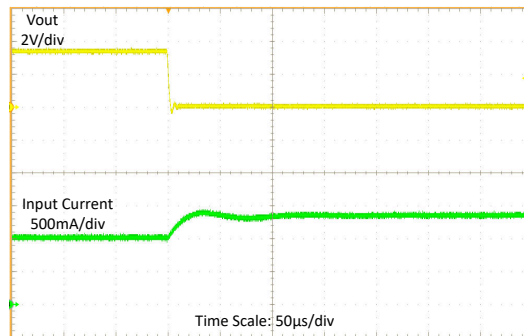

$V_{IN} = 3.6V$ ,  $V_{OUT} = 3.3V$

$I_{OUT} = 1A$ , FPWM

**Figure 8-20. Output Short Protection (Entry)**

**Table 8-4. Components for Application Characteristic Curves for  $V_{OUT} = 3.3V$**

REFERENCE	DESCRIPTION	PART NUMBER	MANUFACTURER <sup>(1)</sup>
U1	High Power Density 1.5A Buck-Boost Converter	TPSM83102 or TPSM83103	Texas Instruments
C1	22µF, 0603, Ceramic Capacitor, ±20%, 6.3V	GRM187R61A226ME15	Murata
C2	47µF, 0805, Ceramic Capacitor, ±20%, 6.3V	GRM219R60J476ME44	Murata

(1) See the [Section 10.1.1](#).

## 9 Layout

### 9.1 Layout Guidelines

The PCB layout is an important step to maintain the high performance of the TPSM83102 and TPSM83103 devices.

- Place input and output capacitors as close as possible to the IC. Traces need to be kept short. Route wide and direct traces to the input and output capacitors results in low trace resistance and low parasitic inductance.

### 9.2 Layout Example

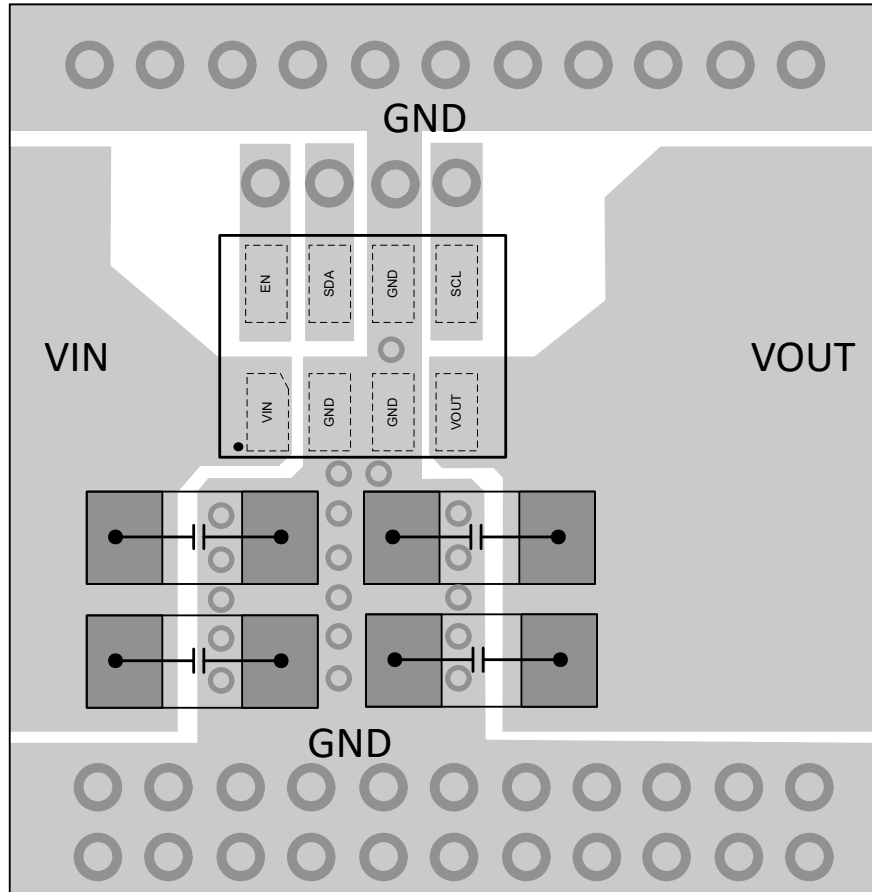

Figure 9-1. Layout Example

## 10 Device and Documentation Support

### 10.1 Device Support

#### 10.1.1 Third-Party Products Disclaimer

TI'S PUBLICATION OF INFORMATION REGARDING THIRD-PARTY PRODUCTS OR SERVICES DOES NOT CONSTITUTE AN ENDORSEMENT REGARDING THE SUITABILITY OF SUCH PRODUCTS OR SERVICES OR A WARRANTY, REPRESENTATION OR ENDORSEMENT OF SUCH PRODUCTS OR SERVICES, EITHER ALONE OR IN COMBINATION WITH ANY TI PRODUCT OR SERVICE.

#### 10.1.2 Development Support

##### 10.1.2.1 Custom Design with WEBENCH Tools

[Click here](#) to create a custom design using the TPSM83102 and TPSM83103 devices with the WEBENCH® Power Designer.

1. Start by entering your  $V_{IN}$ ,  $V_{OUT}$  and  $I_{OUT}$  requirements.
2. Optimize your design for key parameters like efficiency, footprint or cost using the optimizer dial and compare this design with other possible solutions from Texas Instruments.
3. WEBENCH Power Designer provides you with a customized schematic along with a list of materials with real time pricing and component availability.
4. In most cases, you can:
  - Run electrical simulations to see important waveforms and circuit performance,
  - Run thermal simulations to understand the thermal performance of your board,
  - Export your customized schematic and layout into popular CAD formats,
  - Print PDF reports for the design, and share your design with colleagues.
5. Get more information about WEBENCH tools at [www.ti.com/webench](http://www.ti.com/webench).

### 10.2 Receiving Notification of Documentation Updates

To receive notification of documentation updates, navigate to the device product folder on [ti.com](http://ti.com). Click on *Notifications* to register and receive a weekly digest of any product information that has changed. For change details, review the revision history included in any revised document.

### 10.3 Support Resources

[TI E2E™ support forums](#) are an engineer's go-to source for fast, verified answers and design help — straight from the experts. Search existing answers or ask your own question to get the quick design help you need.

Linked content is provided "AS IS" by the respective contributors. They do not constitute TI specifications and do not necessarily reflect TI's views; see TI's [Terms of Use](#).

### 10.4 Trademarks

TI E2E™ is a trademark of Texas Instruments.

WEBENCH® is a registered trademark of Texas Instruments.

All trademarks are the property of their respective owners.

### 10.5 Electrostatic Discharge Caution



This integrated circuit can be damaged by ESD. Texas Instruments recommends that all integrated circuits be handled with appropriate precautions. Failure to observe proper handling and installation procedures can cause damage.

ESD damage can range from subtle performance degradation to complete device failure. Precision integrated circuits may be more susceptible to damage because very small parametric changes could cause the device not to meet its published specifications.

### 10.6 Glossary

[TI Glossary](#) This glossary lists and explains terms, acronyms, and definitions.

## 11 Revision History

NOTE: Page numbers for previous revisions may differ from page numbers in the current version.

### Changes from Revision \* (August 2024) to Revision A (January 2025) Page

- Removed TPSM83103 from heading..... 1
- Removed Preview from TPSM83102..... 1

DATE	REVISION	NOTES
August 2024	*	Initial Release

## 12 Mechanical, Packaging, and Orderable Information

The following pages include mechanical, packaging, and orderable information. This information is the most current data available for the designated devices. This data is subject to change without notice and revision of this document. For browser-based versions of this data sheet, refer to the left-hand navigation.

### 12.1 Tape and Reel Information

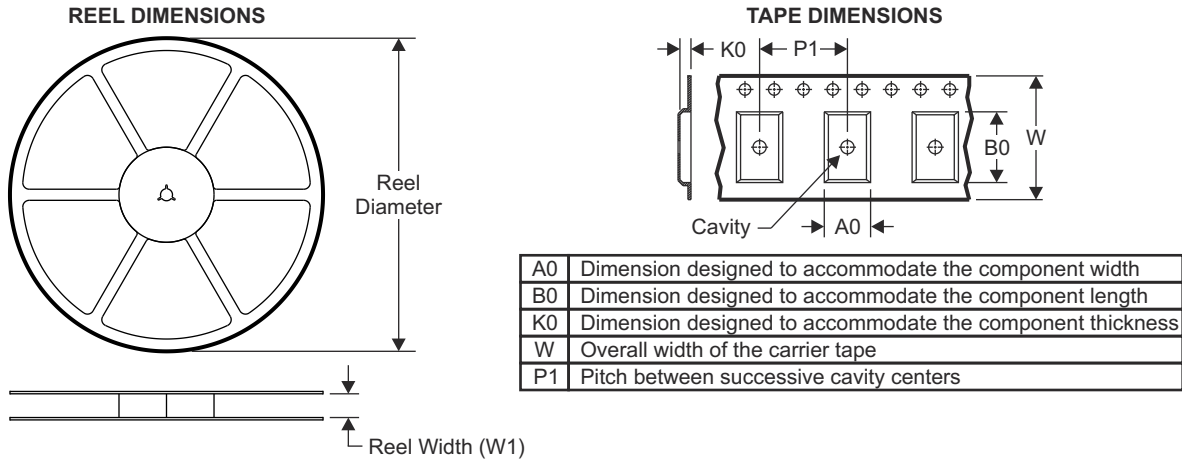

#### QUADRANT ASSIGNMENTS FOR PIN 1 ORIENTATION IN TAPE

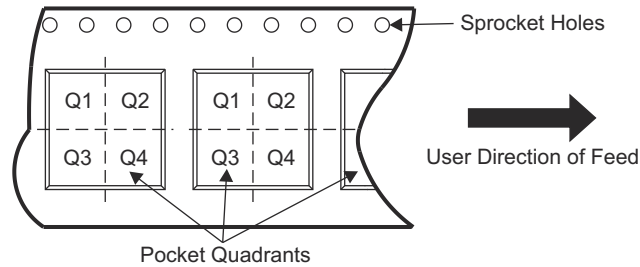

Device	Package Type	Package Drawing	Pins	SPQ	Reel Diameter (mm)	Reel Width W1 (mm)	A0 (mm)	B0 (mm)	K0 (mm)	P1 (mm)	W (mm)	Pin1 Quadrant
TPSM83103SIUR	μSiP	SIU	8	3000	330	12.4	2.3	2.9	1.35	8	12	Q1

**TAPE AND REEL BOX DIMENSIONS**

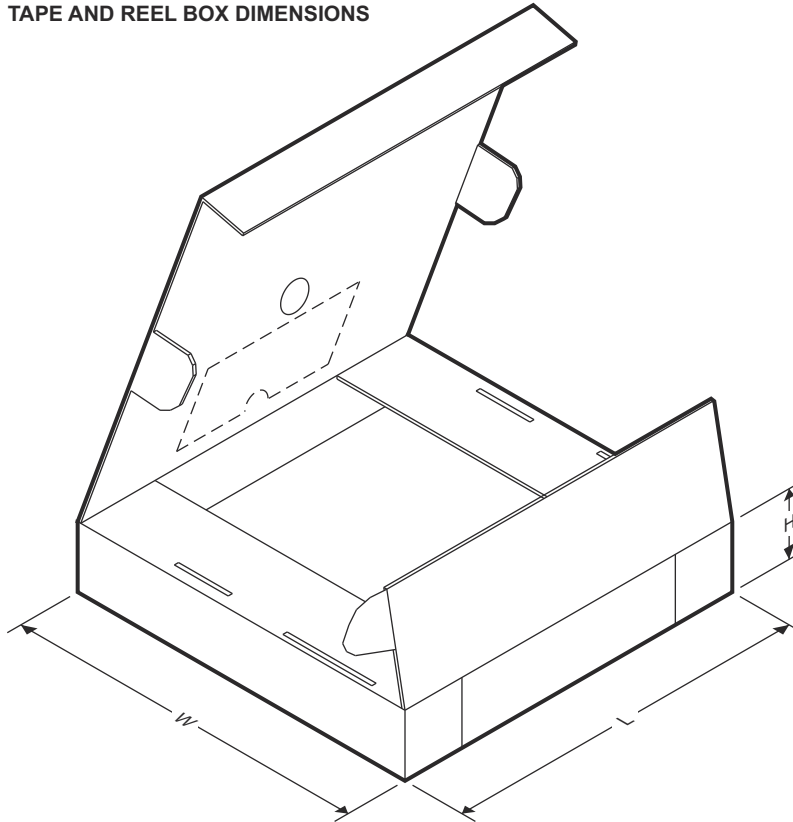

Device	Package Type	Package Drawing	Pins	SPQ	Length (mm)	Width (mm)	Height (mm)
TPSM83103SIUR	μSiP	SIU	8	3000	383	353	58



**12.2 Mechanical Data**

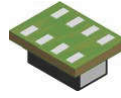

**SIU0008A**

**PACKAGE OUTLINE**

**MicroSiP™ - 1.2 mm max height**

MICRO SYSTEM IN PACKAGE

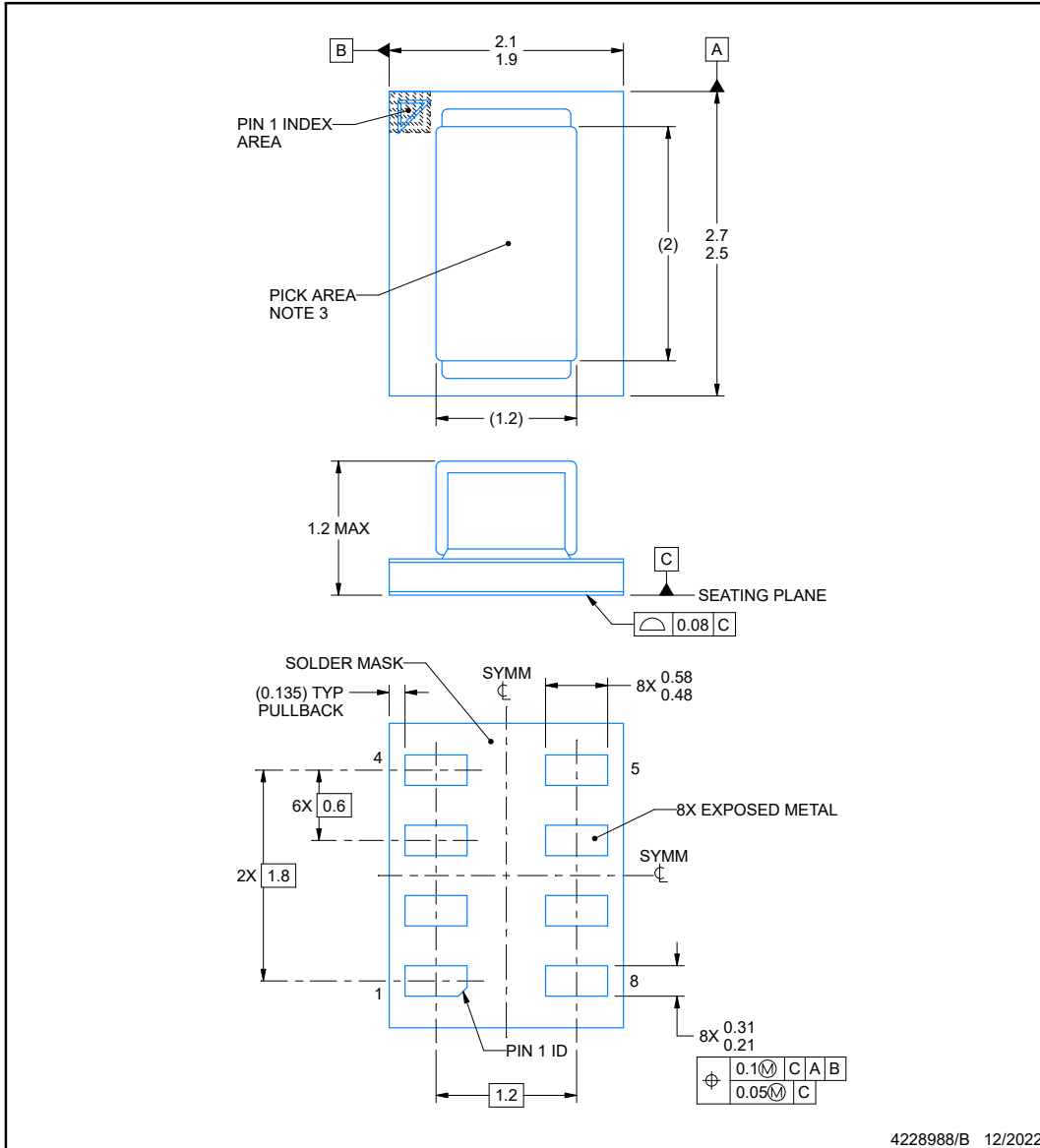

**NOTES:**

MicroSiP is a trademark of Texas Instruments

1. All linear dimensions are in millimeters. Any dimensions in parenthesis are for reference only. Dimensioning and tolerancing per ASME Y14.5M.
2. This drawing is subject to change without notice.
3. Pick and place nozzle  $\varnothing$  0.33 mm or smaller recommended.

## EXAMPLE BOARD LAYOUT

**SIU0008A**

**MicroSiP™ - 1.2 mm max height**

MICRO SYSTEM IN PACKAGE

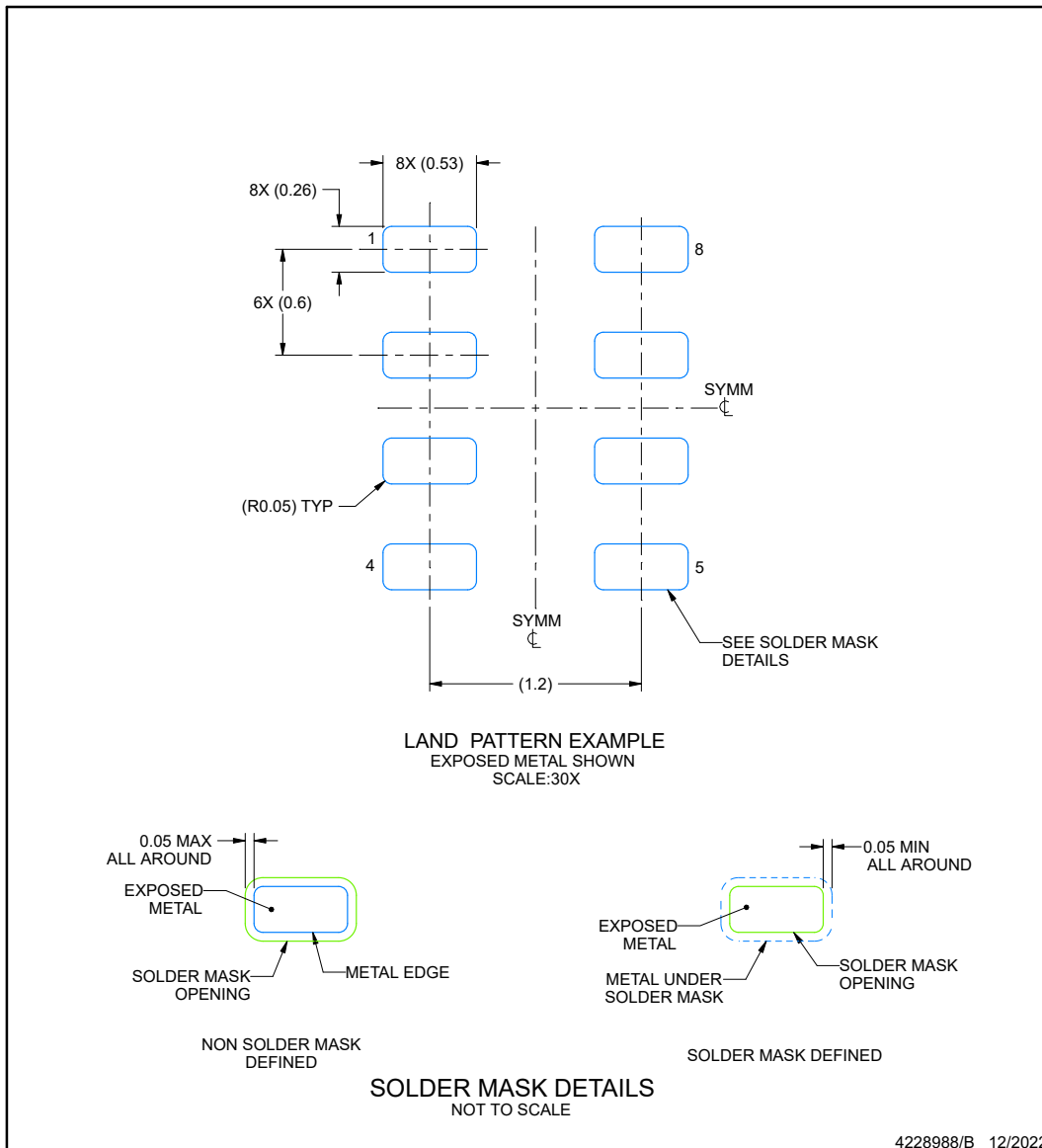

NOTES: (continued)

4. For more information, see Texas Instruments literature number SLUA271 ([www.ti.com/lit/slua271](http://www.ti.com/lit/slua271)).

## EXAMPLE STENCIL DESIGN

**SIU0008A**

**MicroSiP™ - 1.2 mm max height**

MICRO SYSTEM IN PACKAGE

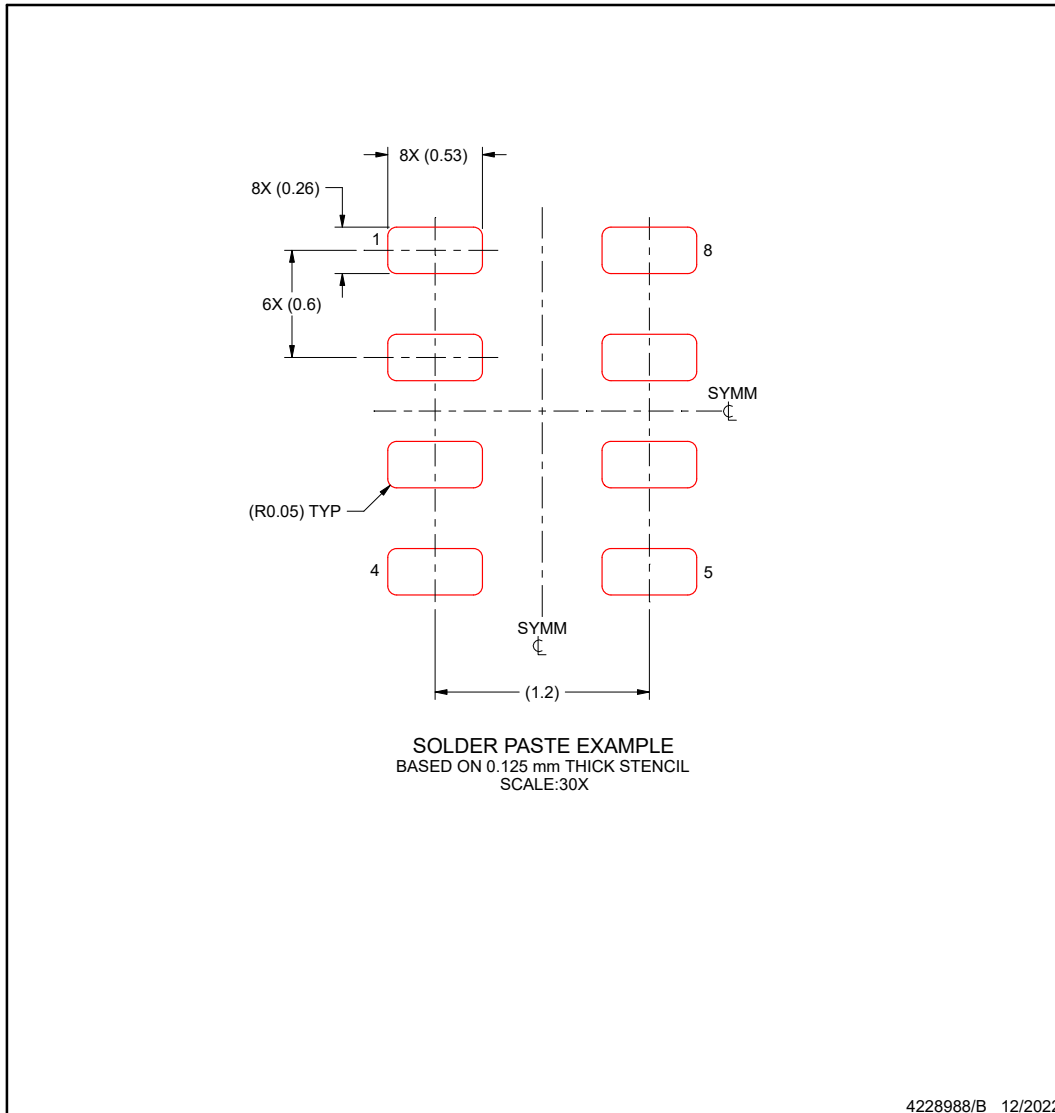

NOTES: (continued)

5. Laser cutting apertures with trapezoidal walls and rounded corners may offer better paste release. IPC-7525 may have alternate design recommendations.

**PACKAGING INFORMATION**

Orderable Device	Status (1)	Package Type	Package Drawing	Pins	Package Qty	Eco Plan (2)	Lead finish/ Ball material (6)	MSL Peak Temp (3)	Op Temp (°C)	Device Marking (4/5)	Samples
TPSM831021SIUR	ACTIVE	uSiP	SIU	8	3000	RoHS & Green	ENEPIG	Level-2-260C-1 YEAR	-40 to 125	3I8P HYBM831021	<a href="#">Samples</a>
TPSM831022SIUR	ACTIVE	uSiP	SIU	8	3000	RoHS & Green	ENEPIG	Level-2-260C-1 YEAR	-40 to 125	3I9P HYBM831022	<a href="#">Samples</a>
TPSM831023SIUR	ACTIVE	uSiP	SIU	8	3000	RoHS & Green	ENEPIG	Level-2-260C-1 YEAR	-40 to 125	3IAP HYBM831023	<a href="#">Samples</a>
TPSM83102SIUR	ACTIVE	uSiP	SIU	8	3000	RoHS & Green	ENEPIG	Level-2-260C-1 YEAR	-40 to 125	3EGL HYBM83102	<a href="#">Samples</a>
TPSM83103SIUR	ACTIVE	uSiP	SIU	8	3000	RoHS & Green	ENEPIG	Level-2-260C-1 YEAR	-40 to 125	3EHL HYBM83103	<a href="#">Samples</a>

(1) The marketing status values are defined as follows:

**ACTIVE:** Product device recommended for new designs.

**LIFEBUY:** TI has announced that the device will be discontinued, and a lifetime-buy period is in effect.

**NRND:** Not recommended for new designs. Device is in production to support existing customers, but TI does not recommend using this part in a new design.

**PREVIEW:** Device has been announced but is not in production. Samples may or may not be available.

**OBSELETE:** TI has discontinued the production of the device.

(2) **RoHS:** TI defines "RoHS" to mean semiconductor products that are compliant with the current EU RoHS requirements for all 10 RoHS substances, including the requirement that RoHS substance do not exceed 0.1% by weight in homogeneous materials. Where designed to be soldered at high temperatures, "RoHS" products are suitable for use in specified lead-free processes. TI may reference these types of products as "Pb-Free".

**RoHS Exempt:** TI defines "RoHS Exempt" to mean products that contain lead but are compliant with EU RoHS pursuant to a specific EU RoHS exemption.

**Green:** TI defines "Green" to mean the content of Chlorine (Cl) and Bromine (Br) based flame retardants meet JS709B low halogen requirements of <=1000ppm threshold. Antimony trioxide based flame retardants must also meet the <=1000ppm threshold requirement.

(3) MSL, Peak Temp. - The Moisture Sensitivity Level rating according to the JEDEC industry standard classifications, and peak solder temperature.

(4) There may be additional marking, which relates to the logo, the lot trace code information, or the environmental category on the device.

(5) Multiple Device Markings will be inside parentheses. Only one Device Marking contained in parentheses and separated by a "-" will appear on a device. If a line is indented then it is a continuation of the previous line and the two combined represent the entire Device Marking for that device.

(6) Lead finish/Ball material - Orderable Devices may have multiple material finish options. Finish options are separated by a vertical ruled line. Lead finish/Ball material values may wrap to two lines if the finish value exceeds the maximum column width.

**Important Information and Disclaimer:** The information provided on this page represents TI's knowledge and belief as of the date that it is provided. TI bases its knowledge and belief on information provided by third parties, and makes no representation or warranty as to the accuracy of such information. Efforts are underway to better integrate information from third parties. TI has taken and continues to take reasonable steps to provide representative and accurate information but may not have conducted destructive testing or chemical analysis on incoming materials and chemicals. TI and TI suppliers consider certain information to be proprietary, and thus CAS numbers and other limited information may not be available for release.

In no event shall TI's liability arising out of such information exceed the total purchase price of the TI part(s) at issue in this document sold by TI to Customer on an annual basis.

## IMPORTANT NOTICE AND DISCLAIMER

TI PROVIDES TECHNICAL AND RELIABILITY DATA (INCLUDING DATA SHEETS), DESIGN RESOURCES (INCLUDING REFERENCE DESIGNS), APPLICATION OR OTHER DESIGN ADVICE, WEB TOOLS, SAFETY INFORMATION, AND OTHER RESOURCES "AS IS" AND WITH ALL FAULTS, AND DISCLAIMS ALL WARRANTIES, EXPRESS AND IMPLIED, INCLUDING WITHOUT LIMITATION ANY IMPLIED WARRANTIES OF MERCHANTABILITY, FITNESS FOR A PARTICULAR PURPOSE OR NON-INFRINGEMENT OF THIRD PARTY INTELLECTUAL PROPERTY RIGHTS.

These resources are intended for skilled developers designing with TI products. You are solely responsible for (1) selecting the appropriate TI products for your application, (2) designing, validating and testing your application, and (3) ensuring your application meets applicable standards, and any other safety, security, regulatory or other requirements.

These resources are subject to change without notice. TI grants you permission to use these resources only for development of an application that uses the TI products described in the resource. Other reproduction and display of these resources is prohibited. No license is granted to any other TI intellectual property right or to any third party intellectual property right. TI disclaims responsibility for, and you will fully indemnify TI and its representatives against, any claims, damages, costs, losses, and liabilities arising out of your use of these resources.

TI's products are provided subject to [TI's Terms of Sale](#) or other applicable terms available either on [ti.com](https://www.ti.com) or provided in conjunction with such TI products. TI's provision of these resources does not expand or otherwise alter TI's applicable warranties or warranty disclaimers for TI products.

TI objects to and rejects any additional or different terms you may have proposed.

Mailing Address: Texas Instruments, Post Office Box 655303, Dallas, Texas 75265  
Copyright © 2025, Texas Instruments Incorporated