

# UCC5713x High-Speed, Low-Side Gate Drivers With Overcurrent Protection

## 1 Features

- Typical 3A sink 3A source output currents
- 500mV over-current protection (OCP) threshold
- Single pin for fault output and enable
- Programmable fault clear time and over current detection response time
- Absolute maximum VDD voltage: 30V
- Tight UVLO threshold for bias flexibility
- Typical 26ns propagation delay
- Self-protect driver with thermal shutdown function at 180°C
- Available in 5mm x 4mm SOIC-8 package
- Operating junction temperature range of -40°C to 150°C

## 2 Applications

- Digital controlled PFC
- Air conditioner
- Home Appliances
- Motor drives
- General purpose low-side gate drover for single-ended topologies

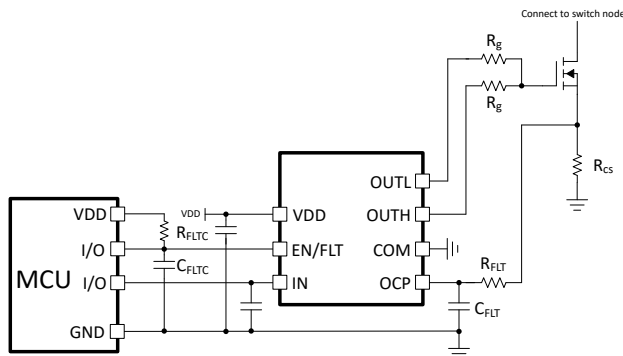

Simplified Application Diagram

## 3 Description

The UCC5713x is a single channel, high-performance, low-side gate driver capable of effectively driving MOSFET, IGBT and SiC power switches. The UCC5713x has a typical peak drive strength of 3A.

The UCC5713x provide the over current protection with the OCP pin. When the over current signal detected on the OCP pin, the internal circuit will pull down the EN/FLT pin to report fault and force the OUT to low stage. External pull up circuit on the EN/FLT is required during the normal operation of the driver. Pulling the EN/FLT low will disable the driver. The EN/FLT would also report the under voltage lock out (UVLO) fault on VDD and the over temperature fault. The UCC5713x provide both 8V and 12V UVLO option for SiC and IGBT applications.

### Device Information

| PART NUMBER | PACKAGE <sup>(1)</sup> | BODY SIZE (NOM) |
|-------------|------------------------|-----------------|
| UCC5713x    | D (SOIC 8)             | 5mm x 4mm       |

- (1) For all available packages, see the orderable addendum at the end of this data sheet.



## Table of Contents

|  |    |  |    |
|--|----|--|----|
| <b>1 Features</b> .....                        | 1  | 6.4 Device Functional Modes.....                                     | 16 |
| <b>2 Applications</b> .....                    | 1  | <b>7 Applications and Implementation</b> .....                       | 17 |
| <b>3 Description</b> .....                     | 1  | 7.1 Application Information.....                                     | 17 |
| <b>4 Pin Configuration and Functions</b> ..... | 3  | 7.2 Typical Application.....   | 18 |
| <b>5 Specifications</b> .....                  | 4  | 7.3 Power Supply Recommendations.....                                | 21 |
| 5.1 Absolute Maximum Ratings.....              | 4  | 7.4 Layout.....  | 21 |
| 5.2 ESD Ratings.....                           | 4  | <b>8 Device and Documentation Support</b> .....                      | 24 |
| 5.3 Recommended Operating Conditions.....      | 4  | 8.1 Third-Party Products Disclaimer.....                             | 24 |
| 5.4 Thermal Information.....                   | 4  | 8.2 Receiving Notification of Documentation Updates....              | 24 |
| 5.5 Electrical Characteristics.....            | 5  | 8.3 Support Resources.....   | 24 |
| 5.6 Switching Characteristics.....             | 6  | 8.4 Trademarks.....  | 24 |
| 5.7 Timing Diagrams.....                       | 7  | 8.5 Electrostatic Discharge Caution.....                             | 24 |
| 5.8 Typical Characteristics.....               | 8  | 8.6 Glossary.....  | 24 |
| <b>6 Detailed Description</b> .....            | 12 | <b>9 Revision History</b> .....                                      | 24 |
| 6.1 Overview.....                              | 12 | <b>10 Mechanical, Packaging, and Orderable<br/>Information</b> ..... | 24 |
| 6.2 Functional Block Diagram.....              | 12 |  |    |
| 6.3 Feature Description.....                   | 13 |  |    |

## 4 Pin Configuration and Functions

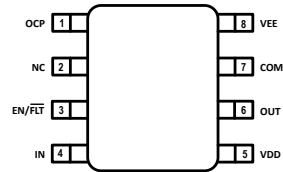

**Figure 4-1. UCC5713xB 8-Pin SOIC D Package Top View**

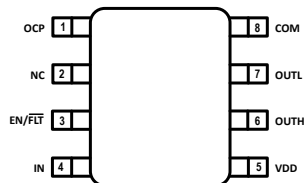

**Figure 4-2. UCC5713xC SOIC D Package Top View**

**Table 4-1. Pin Functions**

| NAME   | PIN       |           | TYPE <sup>(1)</sup> | DESCRIPTION                                     |
|--------|-----------|-----------|---------------------|---|
|        | UCC5713xB | UCC5713xC |                     |   |
| OCP    | 1         | 1         | I                   | Current sense input                             |
| NC     | 2         | 2         |                     | Not connected                                   |
| EN/FLT | 3         | 3         | I/O                 | Enable and fault report                         |
| IN     | 4         | 4         | I                   | Input of the driver                             |
| VDD    | 5         | 5         | P                   | Driver bias supply                              |
| OUT    | 6         | NA        | O                   | Output of the driver                            |
| OUTH   | NA        | 6         | O                   | Driver high output                              |
| OUTL   | NA        | 7         | O                   | Driver low output                               |
| COM    | 7         | 8         | G                   | Driver ground                                   |
| VEE    | 8         | NA        | P                   | Driver negative bias supply with respect to COM |

(1) I/O = Digital input/output, IA = Analog input, AO = Analog output, P = Power connection

## 5 Specifications

### 5.1 Absolute Maximum Ratings

All the voltages are with respect to COM. Over operating free-air temperature range (unless otherwise noted)<sup>(1)</sup>

|                     |  | MIN         | MAX     | UNIT |
|---------------------|--|-------------|---------|------|
| VDD-COM             | Positive power supply                      | -0.3        | 30      | V    |
| VDD-VEE             | Differential Power Supply (B version)      | -0.3        | 30      | V    |
| VEE-COM             | Negative Power Supply (B version)          | -18         | 0.3     | V    |
| OUT                 | Output signal DC voltage                   | COM/VEE-0.3 | VDD+0.3 | V    |
|                     | Output signal transient voltage for 200-ns | COM/VEE-2   | VDD+3   | V    |
| VOCP                | Voltage at current sense pin (OCP)         | -10         | 12      | V    |
| V <sub>IN</sub>     | IN signal DC voltage                       | -5          | 30      | V    |
| V <sub>EN/FLT</sub> | EN/FLT signal DC voltage                   | -0.3        | 30      | V    |
| T <sub>J</sub>      | Junction temperature                       | -40         | 150     | °C   |
| T <sub>stg</sub>    | Storage temperature                        | -65         | 150     | °C   |

- (1) Stresses beyond those listed under *Absolute Maximum Rating* may cause permanent damage to the device. These are stress ratings only, which do not imply functional operation of the device at these or any other conditions beyond those indicated under *Recommended Operating Condition*. Exposure to absolute-maximum-rated conditions for extended periods may affect device reliability.

### 5.2 ESD Ratings

|                    |                         |  | VALUE | UNIT |
|--------------------|-------------------------|--|-------|------|
| V <sub>(ESD)</sub> | Electrostatic discharge | Human body model (HBM), per ANSI/ESDA/ JEDEC JS-001 <sup>(1)</sup> | ±2000 | V    |
|                    |                         | Charged device model (CDM), per JEDEC specification JESD22-C101    | ±1000 |      |

- (1) JEDEC document JEP155 states that 500-V HBM allows safe manufacturing with a standard ESD control process.

### 5.3 Recommended Operating Conditions

All voltages are with reference to COM. Over operating free-air temperature range (unless otherwise noted)

|                     |   | MIN     | NOM | MAX | UNIT |
|---------------------|---|---------|-----|-----|------|
| VDD-COM             | Positive Power Supply (8V UVLO Option)  | 8.5     |     | 26  | V    |
| VDD-COM             | Positive Power Supply (12V UVLO Option) | 14.5    |     | 26  | V    |
| VDD-VEE             | Differential Power Supply (B version)   |         |     | 26  | V    |
| VEE-COM             | Negative Power Supply (B version)       | -15     |     | 0   | V    |
| V <sub>OUT</sub>    | Output Voltage                          | COM/VEE |     | VDD | V    |
| V <sub>OCP</sub>    | Voltage at current sense pin            | -5      |     | 10  | V    |
| V <sub>IN</sub>     | IN signal DC voltage                    | -2      |     | 26  | V    |
| V <sub>EN/FLT</sub> | EN signal DC voltage                    | 0       |     | 26  | V    |
| T <sub>J</sub>      | Junction temperature                    | -40     |     | 150 | °C   |

### 5.4 Thermal Information

| THERMAL METRIC <sup>(1)</sup> |   | UCC5713x |      |
|-------------------------------|---|----------|------|
|                               |   | D        |      |
|                               |   | 8 PINS   |      |
|                               |   |          | UNIT |
| R <sub>θJA</sub>              | Junction-to-ambient thermal resistance    | 126.6    | °C/W |
| R <sub>θJC(top)</sub>         | Junction-to-case (top) thermal resistance | 67.1     | °C/W |

## 5.4 Thermal Information (continued)

| THERMAL METRIC <sup>(1)</sup> |  | UCC5713x |  | UNIT |
|-------------------------------|--|----------|--|------|
|                               |  | D        |  |      |
|                               |  | 8 PINS   |  |      |
| R <sub>θJB</sub>              | Junction-to-board thermal resistance         | 75.8     |  | °C/W |
| Ψ <sub>JT</sub>               | Junction-to-top characterization parameter   | 15.9     |  | °C/W |
| Ψ <sub>JB</sub>               | Junction-to-board characterization parameter | 74.8     |  | °C/W |
| R <sub>θJC(bot)</sub>         | Junction-to-case (bottom) thermal resistance | na       |  | °C/W |

(1) For more information about traditional and new thermal metrics, see the [Semiconductor and IC Package Thermal Metrics](#) application report.

## 5.5 Electrical Characteristics

VDD = 15 V, VEE = 0 V, 1-μF capacitor from VDD to COM, 1-μF capacitor from VEE to COM, T<sub>J</sub> = -40°C to +150°C, CL = 0 pF, unless otherwise noted.

| PARAMETER                                    |  | TEST CONDITIONS  | MIN  | TYP  | MAX  | UNIT |
|--|--|--|------|------|------|------|
| <b>SUPPLY CURRENTS</b>                       |  |  |      |      |      |      |
| I <sub>VDDQ</sub>                            | VDD quiescent supply current                           | V <sub>IN</sub> = 3.3 V, EN = 5V, VDD = 6.5 V                      |      |      | 1.3  | mA   |
| I <sub>VDD</sub>                             | VDD static supply current                              | V <sub>IN</sub> = 3.3 V, EN = 5 V                                  |      | 0.7  | 1.5  | mA   |
| I <sub>VDD</sub>                             | VDD static supply current                              | V <sub>IN</sub> = 0 V, EN = 5 V                                    |      | 0.7  | 1.1  | mA   |
| I <sub>VEEQ</sub>                            | VEE static supply current                              | V <sub>IN</sub> = 0 V, EN = 5 V, VEE = -10 V                       |      |      | 1.1  | mA   |
| I <sub>VDDO</sub>                            | VDD dynamic operating current                          | f <sub>SW</sub> = 1MHz, EN = 5 V, VDD=15 V, C <sub>L</sub> =1.8 nF |      |      | 30   | mA   |
| I <sub>DIS</sub>                             | VDD disable current                                    | V <sub>IN</sub> = 3.3 V, EN = 0 V                                  |      | 0.8  | 1.1  | mA   |
| <b>VDD UNDERVOLTAGE THRESHOLDS AND DELAY</b> |  |  |      |      |      |      |
| V <sub>VDD_ON</sub>                          | VDD UVLO Rising Threshold                              | 8 V UVLO Option  | 7.65 | 8    | 8.35 | V    |
| V <sub>VDD_OFF</sub>                         | VDD UVLO Falling Threshold                             |  | 6.65 | 7    | 7.35 | V    |
| V <sub>VDD_HYS</sub>                         | VDD UVLO Threshold Hysteresis                          |  |      | 1    |      | V    |
| t <sub>UVLO2FLT</sub>                        | Propagation delay from UVLO to $\overline{\text{FLT}}$ |  |      | 2    |      | μs   |
| V <sub>VDD_ON</sub>                          | VDD UVLO Rising Threshold                              | 12 V UVLO Option   | 12.8 | 13.5 | 14.2 | V    |
| V <sub>VDD_OFF</sub>                         | VDD UVLO Falling Threshold                             |  | 11.8 | 12.5 | 13.2 | V    |
| V <sub>VDD_HYS</sub>                         | VDD UVLO Threshold Hysteresis                          |  |      | 1    |      | V    |
| <b>IN, EN/FLT</b>                            |  |  |      |      |      |      |
| V <sub>INH</sub>                             | Input High Threshold Voltage                           |  | 1.8  | 2.2  | 2.6  | V    |
| V <sub>INL</sub>                             | Input Low Threshold Voltage                            |  | 0.8  | 1.2  | 1.6  | V    |
| V <sub>IN_HYS</sub>                          | Input-threshold Hysteresis                             |  |      | 1    |      | V    |
| R <sub>IND</sub>                             | IN Pin Pull Down Resistance                            |  |      | 115  |      | kΩ   |
| V <sub>ENH</sub>                             | Enable High Threshold Voltage                          |  | 1.8  | 2.2  | 2.6  | V    |
| V <sub>ENL</sub>                             | Enable Low Threshold Voltage                           |  | 0.8  | 1.2  | 1.6  | V    |
| V <sub>EN_HYS</sub>                          | Enable Threshold Hysteresis                            |  |      | 1    |      | V    |
| R <sub>ENU</sub>                             | EN Pin Pull Up Resistance                              |  |      | 2    |      | MΩ   |
| I <sub>FLTth</sub>                           | $\overline{\text{FLT}}$ threshold                      | V <sub>FLT-sink</sub> = 400 mV, T <sub>j</sub> =25 °C              | 18   |      |      | mA   |
| <b>OC DETECTION</b>                          |  |  |      |      |      |      |
| V <sub>OCTH</sub>                            | OC detection threshold, referenced to GND (UCC5713X)   | 500 mV option  | 474  | 500  | 526  | mV   |
| V <sub>OCTL</sub>                            | OC release threshold, referenced to GND (UCC5713X)     | 500 mV option  | 463  | 488  | 513  | mV   |
| t <sub>OCFIL</sub> <sup>(1)</sup>            | OC deglitch filter ( 8V-UVLO version)                  |  |      | 70   |      | ns   |

## 5.5 Electrical Characteristics (continued)

VDD = 15 V, VEE = 0 V, 1- $\mu$ F capacitor from VDD to COM, 1- $\mu$ F capacitor from VEE to COM, TJ = -40°C to +150°C, CL = 0 pF, unless otherwise noted.

| PARAMETER                           |  | TEST CONDITIONS  | MIN | TYP | MAX | UNIT     |
|-------------------------------------|--|--|-----|-----|-----|----------|
| t <sub>OCFIL</sub> <sup>(1)</sup>   | OC deglitch filter (12V-UVLO version)                                      |  |     | 190 |     | ns       |
| t <sub>OC2OUT</sub> <sup>(1)</sup>  | OC propagation delay to 90% of OUT (8V-UVLO version)                       |  |     | 115 | 145 | ns       |
| t <sub>OC2OUT</sub> <sup>(1)</sup>  | OC propagation delay to 90% of OUT (12V-UVLO version)                      |  |     | 230 | 350 | ns       |
| t <sub>OC2FLT</sub> <sup>(1)</sup>  | OC propagation delay to 90% of EN/FLT low(8V-UVLO version)                 |  |     | 115 | 150 | ns       |
| t <sub>OC2FLT</sub> <sup>(1)</sup>  | OC propagation delay to 90% of EN/FLT low(12V-UVLO version)                |  |     | 220 | 320 | ns       |
| t <sub>OCLEB</sub> <sup>(1)</sup>   | OC Leading edge blanking time( 8V-UVLO version)                            |  |     | 60  | 80  | ns       |
| t <sub>OCLEB</sub> <sup>(1)</sup>   | OC Leading edge blanking time( 12V-UVLO version)                           |  |     | 180 | 250 | ns       |
| <b>OVERTEMPERATURE PROTECTION</b>   |  |  |     |     |     |          |
| T <sub>SD</sub> <sup>(1)</sup>      | Overtemperature threshold  |  |     | 180 |     | °C       |
| T <sub>HYS</sub> <sup>(1)</sup>     | Overtemperature protection hysteresis                                      |  |     | 30  |     | °C       |
| t <sub>OTP2FLT</sub> <sup>(1)</sup> | Propagation delay from overtemperature shutdown to $\overline{\text{FLT}}$ | Over temperature shutdown to 90% of $\overline{\text{FLT}}$ , CI=10 pF |     | 8   |     | us       |
| <b>OUTPUT DRIVER STAGE</b>          |  |  |     |     |     |          |
| I <sub>SRCPK</sub> <sup>(1)</sup>   | Peak Output Source Current   | C <sub>VDD</sub> = 10 $\mu$ F, C <sub>L</sub> = 0.1 $\mu$ F, f = 1 kHz |     | -3  |     | A        |
| I <sub>SNKPK</sub> <sup>(1)</sup>   | Peak Output Sink Current   | C <sub>VDD</sub> = 10 $\mu$ F, C <sub>L</sub> = 0.1 $\mu$ F, f = 1 kHz |     | 3   |     | A        |
| R <sub>OH</sub>                     | Pull up resistance   | I <sub>OUT</sub> = -500 mA   |     | 5   |     | $\Omega$ |
| R <sub>OL</sub>                     | Pull down resistance   | I <sub>OUT</sub> = 50 mA   |     | 1   |     | $\Omega$ |

(1) Parameter are not tested in production

## 5.6 Switching Characteristics

VDD = 15 V, VEE = 0 V, 1- $\mu$ F capacitor from VDD to COM, 1- $\mu$ F capacitor from VEE to COM, TJ = -40°C to +150°C, CL = 0 pF, unless otherwise noted. <sup>(1)</sup>

| PARAMETER           |   | TEST CONDITIONS   | MIN | TYP | MAX | UNIT |
|---------------------|---|---|-----|-----|-----|------|
| t <sub>R</sub>      | Output Rise Time                                    | C <sub>L</sub> =1.8 nF, 10% to 90%, Vin = 0 to 3.3 V  |     | 8   | 18  | ns   |
| t <sub>F</sub>      | Output Fall Time                                    | C <sub>L</sub> =1.8 nF, 90% to 10%, Vin = 0 to 3.3 V  |     | 14  | 32  | ns   |
| t <sub>D2</sub>     | Propagation Delay – Input falling to output falling | C <sub>L</sub> =1.8 nF, from 1 V falling on Vin to 90% of output fall, Vin=0 - 3.3 V, Fsw=500 kHz, 50% duty cycle |     | 28  | 50  | ns   |
| t <sub>D1</sub>     | Propagation Delay – Input rising to output rising   | C <sub>L</sub> =1.8 nF, from 2 V rising on Vin to 10% of output rise, Vin=0 - 3.3 V, Fsw=500 kHz, 50% duty cycle  |     | 26  | 50  | ns   |
| t <sub>PD_DIS</sub> | DIS Response Delay                                  | C <sub>L</sub> =1.8 nF, from 1 V falling on EN to 90% of output fall, EN=0 - 3.3 V                                |     | 27  | 45  | ns   |
| t <sub>PWD</sub>    | Pulse Width Distortion                              | Input Pulse Width = 100 ns, 500 kHz<br> t <sub>D2_1</sub> - t <sub>D1_1</sub>                                     | -10 |     | 10  | ns   |

(1) Switching parameters are not tested in production.

## 5.7 Timing Diagrams

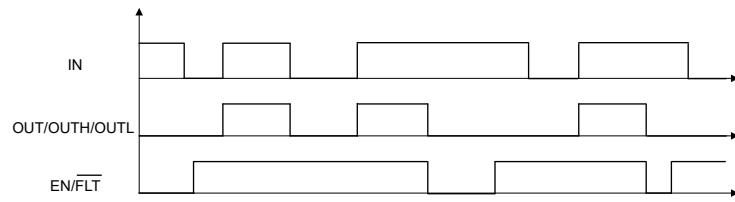

**Figure 5-1. Input/Output/Enable Timing Diagram, IN = PWM**

## 5.8 Typical Characteristics

Unless otherwise specified, VDD=15V, VEE=0V, IN=3.3V, EN=5V, T<sub>J</sub> = 25 °C, No load

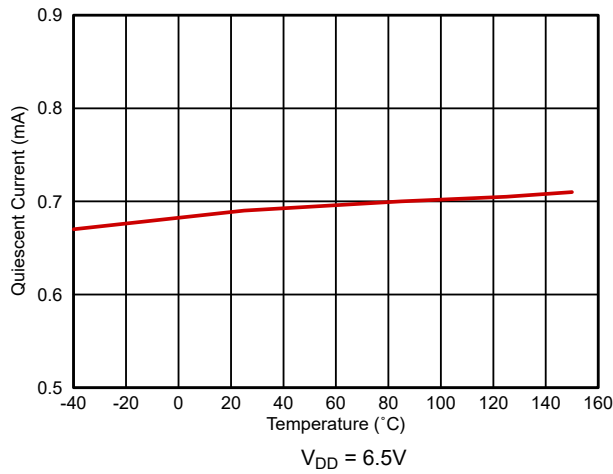

Figure 5-2. Quiescent Current

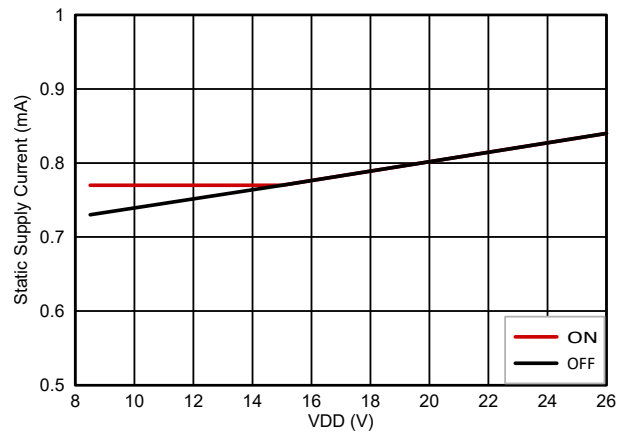

Figure 5-3. Operating Static Supply Current

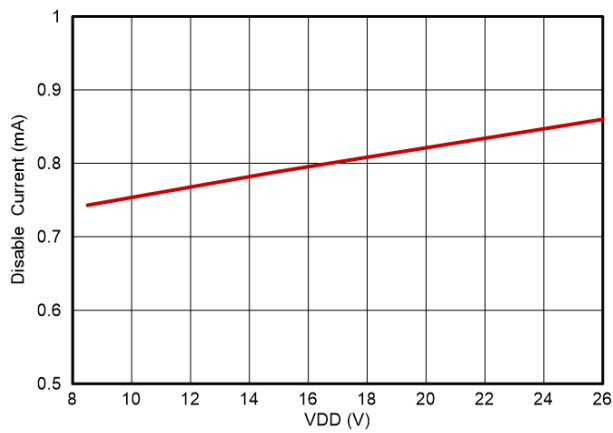

Figure 5-4. Disable Current

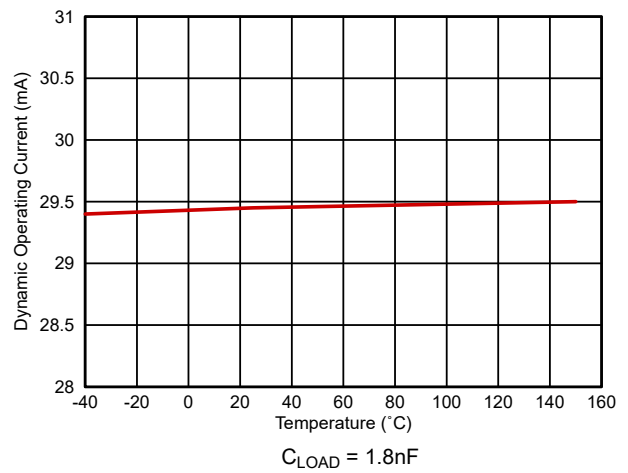

Figure 5-5. Operating Supply Current

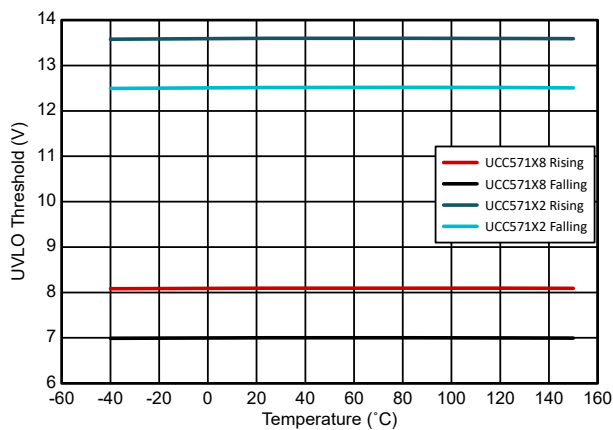

Figure 5-6. UVLO Threshold

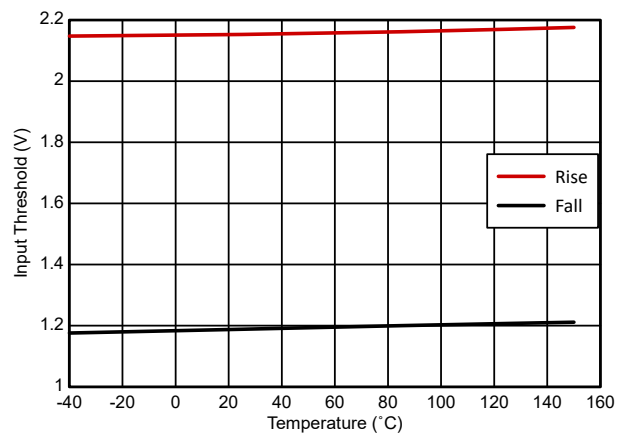
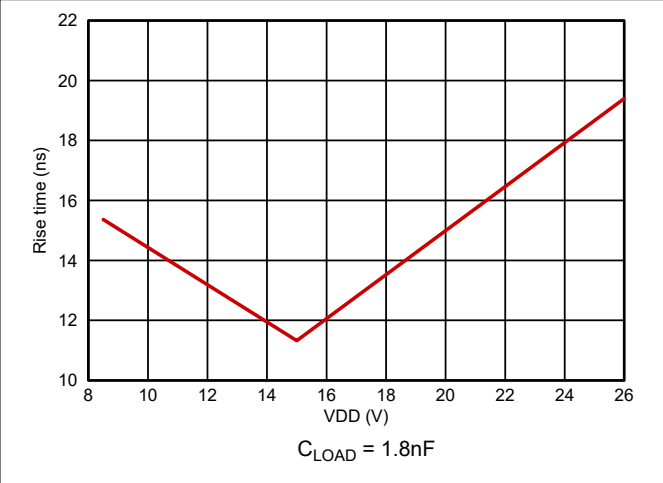
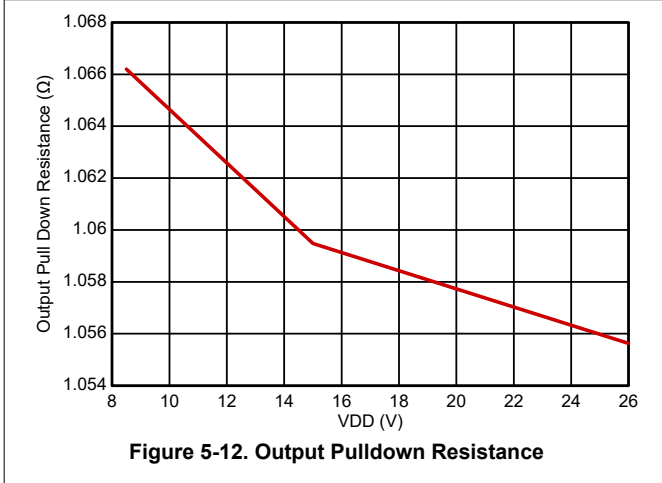
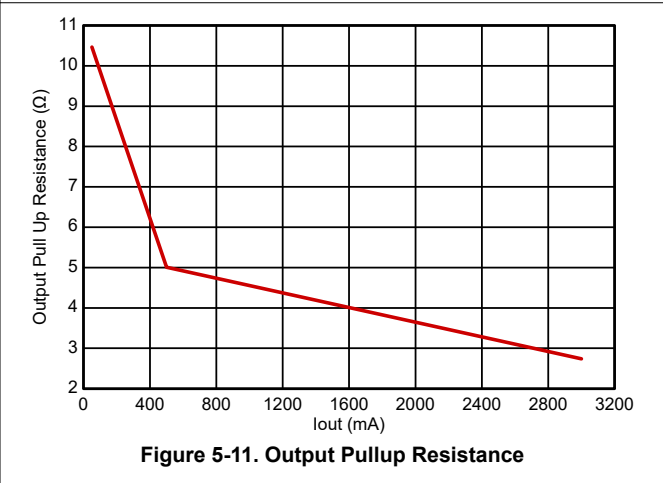
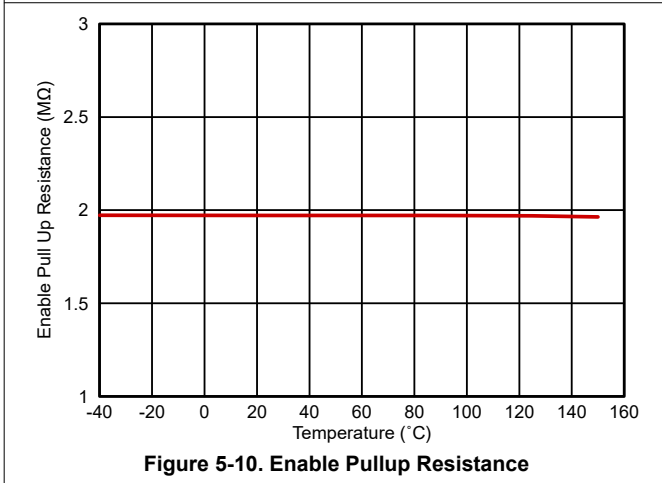
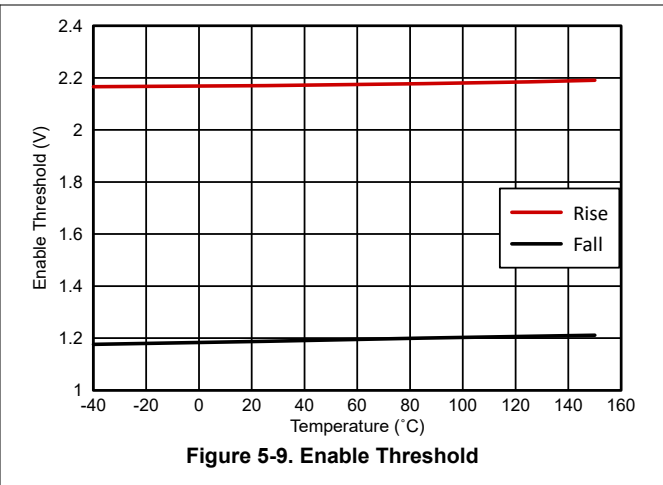
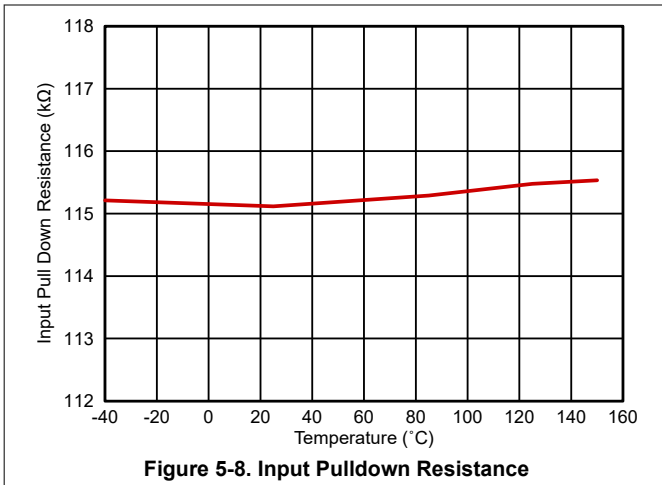

Figure 5-7. Input Threshold



### 5.8 Typical Characteristics (continued)

Unless otherwise specified, VDD=15V, VEE=0V, IN=3.3V, EN=5V, T<sub>J</sub> = 25 °C, No load



## 5.8 Typical Characteristics (continued)

Unless otherwise specified, VDD=15V, VEE=0V, IN=3.3V, EN=5V, T<sub>J</sub> = 25 °C, No load

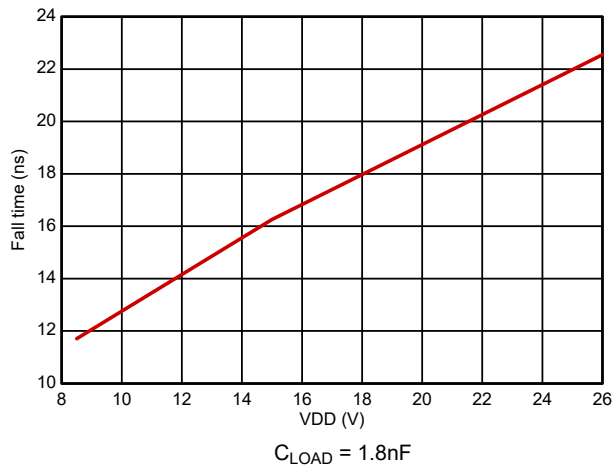

Figure 5-14. Output Fall Time

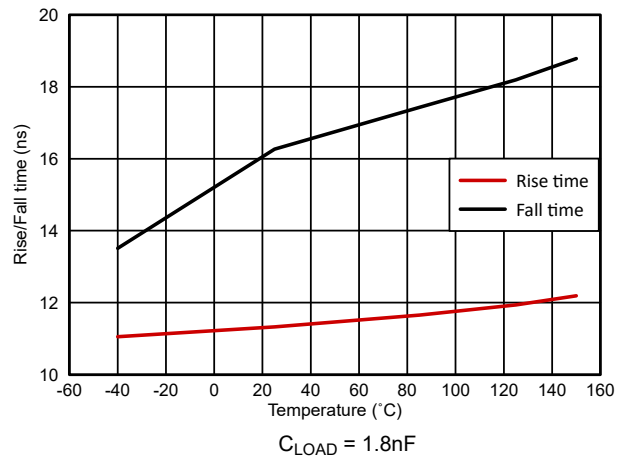

Figure 5-15. Output Rise and Fall Time

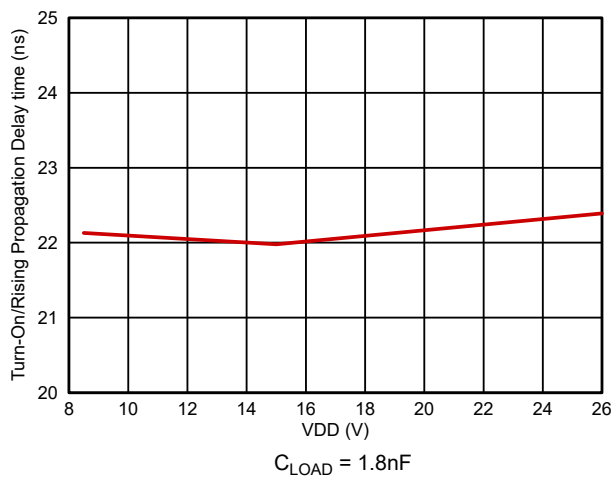

Figure 5-16. Input to Output Rising (Turnon) Propagation Delay

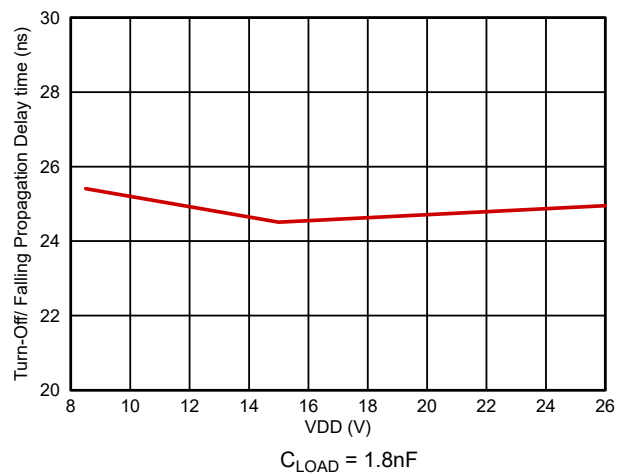

Figure 5-17. Input to Output Falling (Turnoff) Propagation Delay

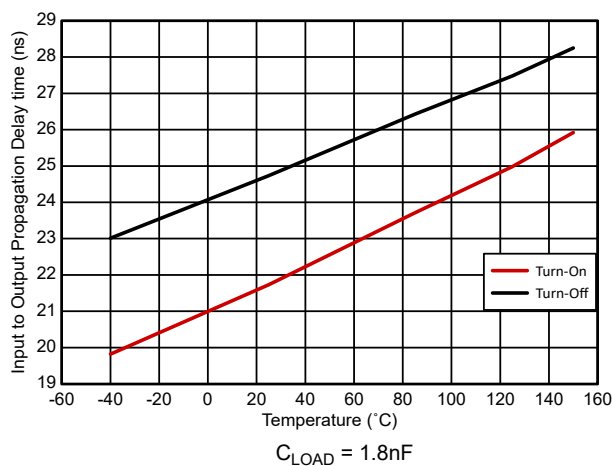

Figure 5-18. Input Propagation Delay

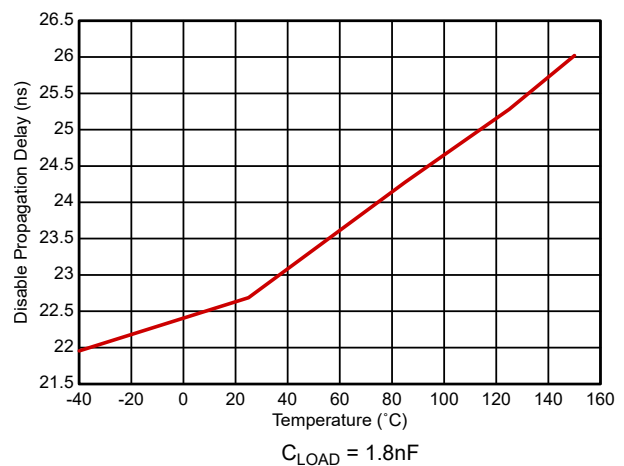

Figure 5-19. Disable Propagation Delay

### 5.8 Typical Characteristics (continued)

Unless otherwise specified, VDD=15V, VEE=0V, IN=3.3V, EN=5V, T<sub>J</sub> = 25 °C, No load

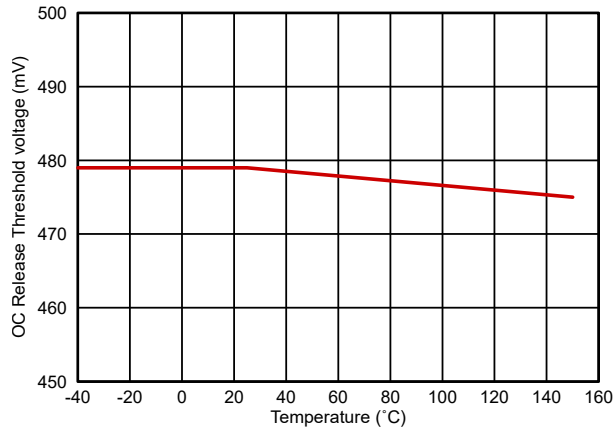

Figure 5-20. OC Release Threshold

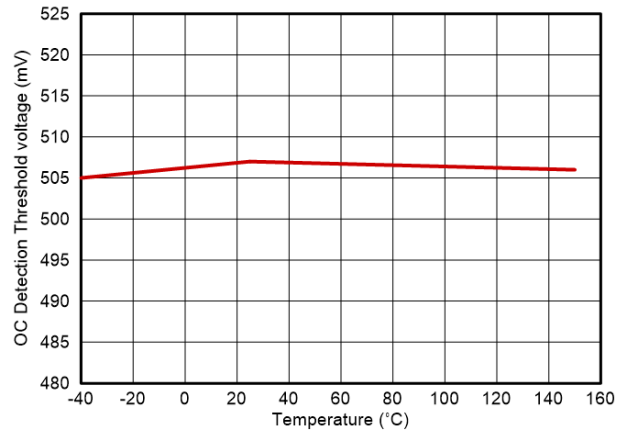

Figure 5-21. OC Detection Threshold

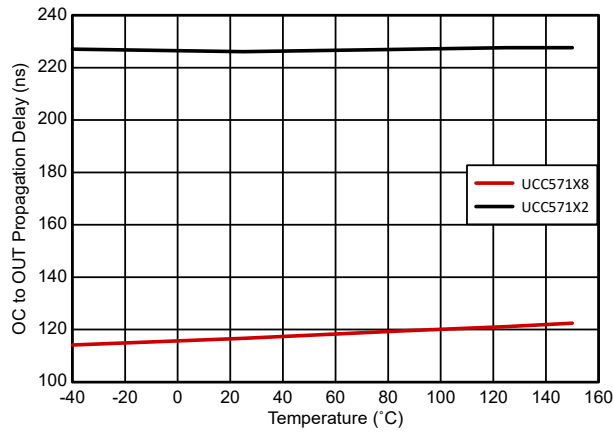

Figure 5-22. OC to Output Propagation Delay

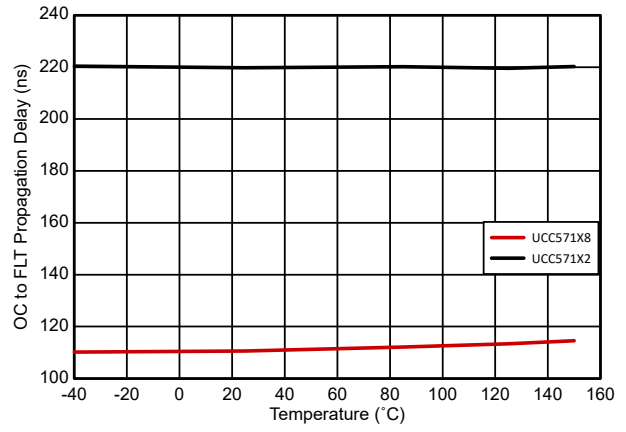

Figure 5-23. OC to Fault Propagation Delay

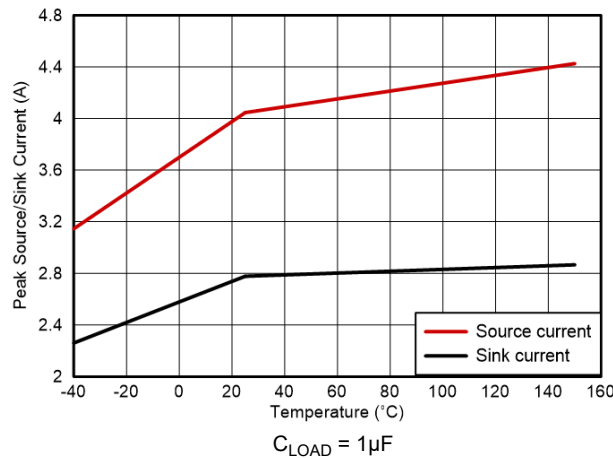

Figure 5-24. Peak Source and Sink Current

## 6 Detailed Description

### 6.1 Overview

The UCC5713x device is a single-channel, high-speed, gate driver capable of effectively driving MOSFET, SiC MOSFET, and IGBT power switches with 3A source and 3A sink (symmetrical drive) peak current. The driver has a good transient handling capability on its output due to reverse currents, as well as rail-to-rail drive capability and small propagation delay, typically 26ns. The device has the over current detection and fault reporting function to the low voltage side DSP/MCU. When the over current signal detected on the OCP pin, the internal circuit will pull down the EN/ $\overline{\text{FLT}}$  pin to report fault and force the OUT to low stage.

The input threshold of UCC5713x is compatible to TTL low-voltage logic, which is fixed and independent of VDD supply voltage. The driver can also work with CMOS based controllers as long as the threshold requirement is met. The 1V typical hysteresis offers excellent noise immunity.

Externall pull up circur on the EN/ $\overline{\text{FLT}}$  is required during the normal operation of the driver. Pulling the EN/ $\overline{\text{FLT}}$  low will disable the driver. The EN/ $\overline{\text{FLT}}$  would also report the under voltage lock out (UVLO) fault on VDD and the over temperature fault.

### 6.2 Functional Block Diagram

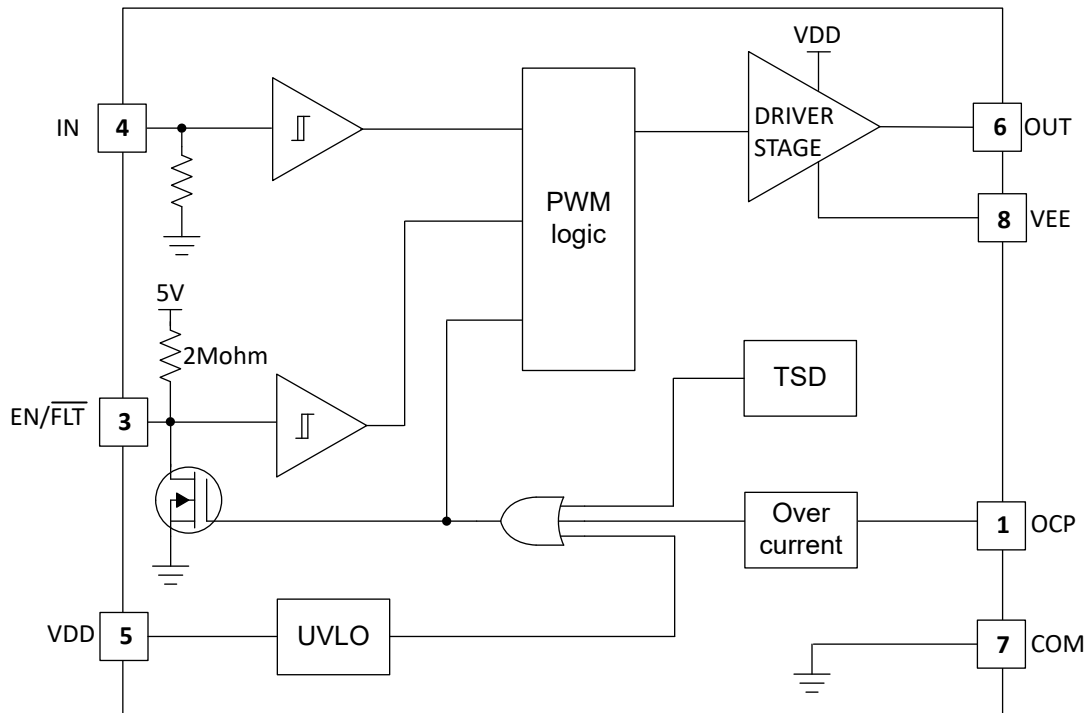
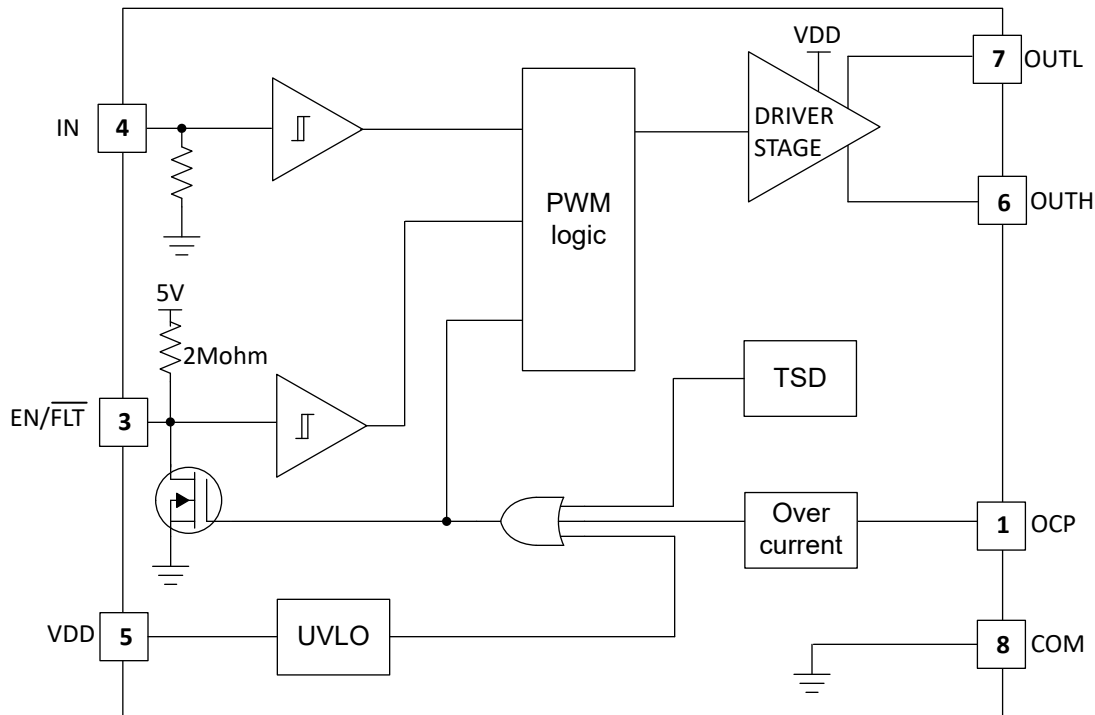

Figure 6-1. UCC5713xB Simplified Functional Block Diagram



**Figure 6-2. UCC5713xC Simplified Functional Block Diagram**

## 6.3 Feature Description

### 6.3.1 Input Stage

The inputs of the UCC5713x device are compatible with TTL based threshold logic and the inputs are independent of the VDD supply voltage. Wider hysteresis (typically 1V) offers enhanced noise immunity compared to traditional TTL logic implementations. This device also features tight control of the input pin threshold voltage levels which eases system design considerations and ensures stable operation across temperature.

The device features an important protection function wherein, whenever the input pin is in a floating condition, the output is held in the low state. This is achieved with internal pulldown resistors on the input pins as shown in the simplified functional block diagrams. In some applications, due to difference in bias supply sequencing, different ICs power-up at different times. This may cause output of the controller to be in tri-state. This output of the controller gets connected to the input of the driver IC. If the driver IC does not have a pulldown resistor then the output of the driver may go high erroneously and damage the switching power device.

The input stage of the driver should preferably be driven by a signal with a short rise or fall time. Caution must be exercised whenever the driver is used with slowly varying input signals, especially in situations where the device is located in a separate daughter board or PCB layout has long input connection traces:

- High  $dI/dt$  current from the driver output coupled with board layout parasitics can cause ground bounce. Because the device features just one COM pin which may be referenced to the power ground, this may interfere with the differential voltage between Input pins and COM and trigger an unintended change of output state. Because of fast 26ns propagation delay, this can ultimately result in high-frequency oscillations, which increases power dissipation and poses risk of damage.
- 1V Input threshold hysteresis boosts noise immunity compared to most other industry standard drivers.

An external resistance is highly recommended between the output of the driver and the power device instead of adding delays on the input signal. This also limits the rise or fall times to the power device which reduces the EMI. The external resistor has the additional benefit of reducing part of the gate charge related power dissipation in the gate driver device package and transferring it into the external resistor itself.

Finally, because of the unique input structure that allows negative voltage capability on the input caution must be used and limit the input pin slew rate less than 1V/ns.

### 6.3.2 Enable/Fault (EN/FLT)

The EN/FLT pin of the UCC5713x can report a fault signal to the DSP/MCU with the adjustable fault clear time. When a fault is detected through the OCP pin, internal TSD, or the UVLO, the EN/FLT pin is pulled down to COM internally. The EN/FLT pin will stay low until the fault is removed and the internal pulldown FET turns off, the voltage on the pin charged up with external pull-up voltage. The  $t_{FLT}$  is determined by the exponential charging characteristics of the capacitor where the time constant is set by  $R_{FLT}$  and  $C_{FLT}$  as shown in [Simplified Application Diagram](#), the  $R_{FLT}$  is pulled up to external VDD.  $C_{FLT}$  is connected from EN/FLT to COM. EN/FLT is weakly pulled up to 5V internally through a  $R_{ENU}$ . The  $t_{FLT}$  can be calculated by the formula below if it is pullup to 5V rail.

$$t_{FLT} = - \left( \frac{R_{FLT} \times R_{ENU}}{R_{FLT} + R_{ENU}} \right) \times C_{FLT} \times \ln \left( 1 - \frac{V_{ENH}}{V_{DD}} \right) \quad (1)$$

The UCC5713x provides an enable function that can allow shutdown or enable the output. When the EN/FLT is pulled up above the  $V_{ENH}$ , the output is following IN, when it is pulled down below  $V_{ENL}$ , the output will stay low. The relationship for input, output and enable can be found in [Timing Diagram](#).

### 6.3.3 Driver Stage

The device has a  $\pm 3A$  peak drive strength and is suitable for driving Si MOSFET/IGBT/SiC. The driver features an important safety function wherein, when the input pins are in a floating condition, the output is held in the LOW state. The driver has rail-to-rail output by implementing an NMOS pull-up with intrinsic bootstrap gate drive. Under DC conditions, a PMOS is used to keep OUT tied to VDD as shown in the following figure. The low pullup impedance of the NMOS results in strong drive strength during the turn-on transient, which shortens the charging time of the input capacitance of the power semiconductor and reduces the turn on switching loss.

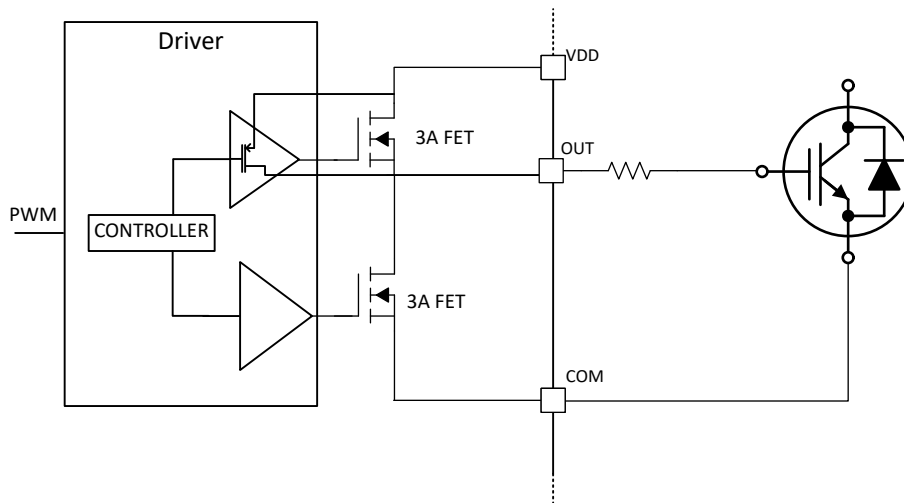
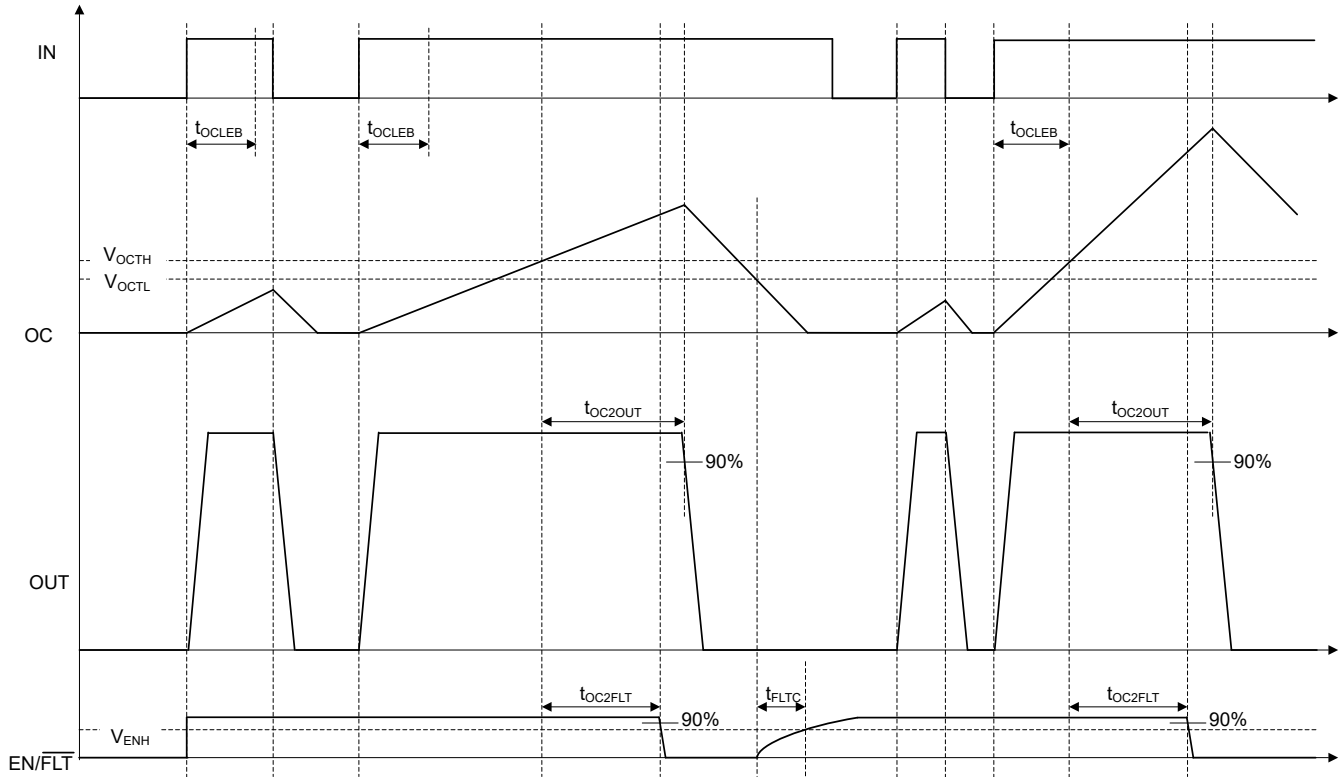

Figure 6-3. Gate Driver Output Stage

### 6.3.4 Overcurrent (OC) Protection

The UCC5713x implements a fast overcurrent protection feature to protect the MOSFET/IGBT from catastrophic breakdown during a fault through the OCP pin. The voltage at OCP pin sensed the voltage drop across the current sense resistor. The pin can handle up to -10V negative DC voltage. The relationship for input, output and enable can be found in [OC Protection Timing Diagram](#) shows the typical operating conditions for the OC protection. The device features an internal leading edge blanking time  $t_{OCLEB}$  that is activated at each rising edge of the input. During the  $t_{OCLEB}$ , the driver will disable overcurrent fault detection. For noisy systems, additional RC filter is recommended to avoid the false fault report. After the device exits  $t_{OCLEB}$  and the OCP pin

voltage is above  $V_{OC_{TH}}$ , the OUT will go low after  $t_{OC2OUT}$  and the  $EN/\overline{FLT}$  will be pulled down. Once the OCP pin voltage goes above  $V_{OC_{TL}}$ , the  $EN/\overline{FLT}$  is pulled up and the OUT stays low until the next input raising edge.



**Figure 6-4. OC Protection Timing Diagram**

### 6.3.5 Thermal Shutdown

The UCC5713x devices provides the thermal shutdown function that can protect the driver when the internal temperature goes above threshold. When the it excess the overtemperature threshold, the  $EN/\overline{FLT}$  will be pulled low after the  $t_{OTP2FLT}$  propagation delay. The device will active again once the temperature falls below the threshold after  $t_{FLTC}$ .

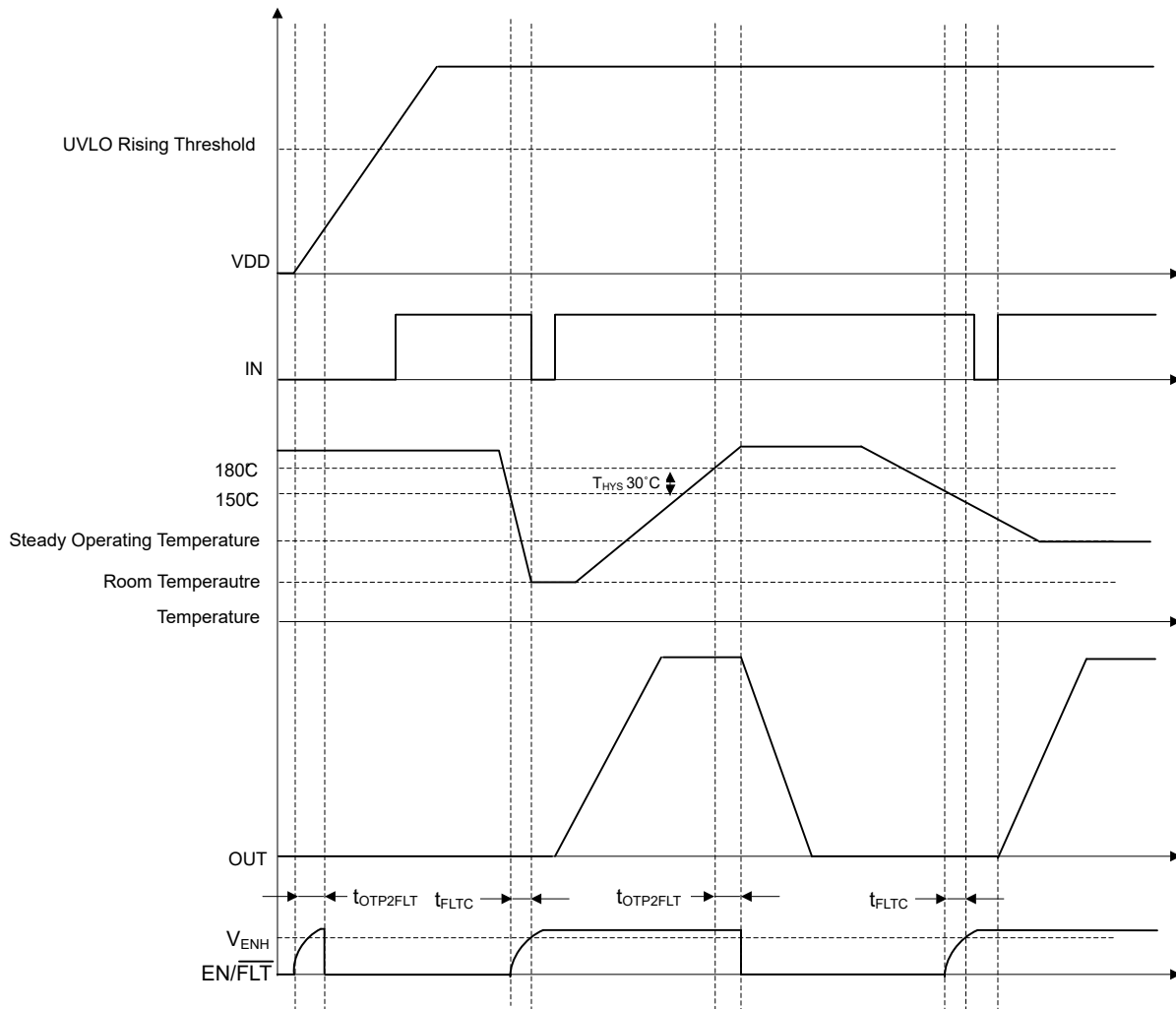

Figure 6-5. Thermal Shutdown Timing Diagram

## 6.4 Device Functional Modes

The UCC5713x devices operate in normal mode and UVLO mode (see [Section 7.2.1.2.1](#) section for information on UVLO operation). In normal mode, the table below shows the output state in different states of the device and the input pins.

Table 6-1. UCC5713xB Truth Table

| IN  | EN/FLT | OCP <sup>(1)</sup> | UVLO <sup>(2)</sup> | INTERNAL TSD <sup>(3)</sup> | OUT |
|-----|--------|--------------------|---------------------|-----------------------------|-----|
| H   | H      | L                  | L                   | L                           | H   |
| L   | H      | L                  | L                   | L                           | L   |
| Any | L      | H                  | Any                 | Any                         | L   |
| Any | L      | Any                | H                   | Any                         | L   |
| Any | L      | Any                | Any                 | H                           | L   |

Table 6-2. UCC5713xC Truth Table

| IN | EN/FLT | OCP <sup>(1)</sup> | UVLO <sup>(2)</sup> | INTERNAL TSD <sup>(3)</sup> | OUTH           | OUTL           |
|----|--------|--------------------|---------------------|-----------------------------|----------------|----------------|
| H  | H      | L                  | L                   | L                           | H              | High-impedance |
| L  | H      | L                  | L                   | L                           | High-impedance | L              |



**Table 6-2. UCC5713xC Truth Table (continued)**

| IN  | EN/FLT | OCP <sup>(1)</sup> | UVLO <sup>(2)</sup> | INTERNAL TSD <sup>(3)</sup> | OUTH           | OUTL |
|-----|--------|--------------------|---------------------|-----------------------------|----------------|------|
| Any | L      | H                  | Any                 | Any                         | High-impedance | L    |
| Any | L      | Any                | H                   | Any                         | High-impedance | L    |
| Any | L      | Any                | Any                 | H                           | High-impedance | L    |

(1) H refers to the over current protection is triggered.

(2) H refers to the UVLO protection is triggered.

(3) H refers to the thermal shutdown protection is triggered.

## 7 Applications and Implementation

### Note

Information in the following applications sections is not part of the TI component specification, and TI does not warrant its accuracy or completeness. TI's customers are responsible for determining suitability of components for their purposes, as well as validating and testing their design implementation to confirm system functionality.

### 7.1 Application Information

High-current gate driver devices are required in switching power applications for a variety of reasons. To enable fast switching of power devices and reduce associated switching power losses, a powerful gate driver can be employed between the PWM output of controllers or signal isolation devices and the gates of the power semiconductor devices. Further, gate drivers are indispensable when sometimes it is just not feasible to have the PWM controller directly drive the gates of the switching devices. The situation will be often encountered because the PWM signal from a digital controller or signal isolation device is often a 3.3V or 5V logic signal which is not capable of effectively turning on a power switch. A level-shifting circuitry is needed to boost the logic-level signal to the gate-drive voltage in order to fully turn on the power device and minimize conduction losses. Traditional buffer drive circuits based on NPN/PNP bipolar, (or P- N-channel MOSFET), transistors in totem-pole arrangement, being emitter follower configurations, prove inadequate for this because they lack level-shifting capability and low-drive voltage protection. Gate drivers effectively combine both the level-shifting, buffer drive and UVLO functions. Gate drivers also find other needs such as minimizing the effect of switching noise by locating the high-current driver physically close to the power switch, driving gate-drive transformers and controlling floating power device gates, reducing power dissipation and thermal stress in controllers by moving gate charge power losses into itself.

The UCC5713x is very flexible in this role with a strong drive current capability and wide recommended supply voltage range from UVLO to 26V. This allows the driver to be used in 5V bias logic level very high frequency MOSFET applications, 12V MOSFET applications, 20V and -5V (relative to Source) SiC FET applications, 15V and -8V (relative to Emitter) IGBT applications and many others.

These requirements, coupled with the need for low propagation delays and availability in compact, and low-inductance packages with good thermal capability, make gate driver devices such as the UCC5713x extremely important components in switching power combining benefits of high-performance, low cost, low component count, board space reduction and simplified system design.

## 7.2 Typical Application

### 7.2.1 Driving MOSFET/IGBT/SiC MOSFET

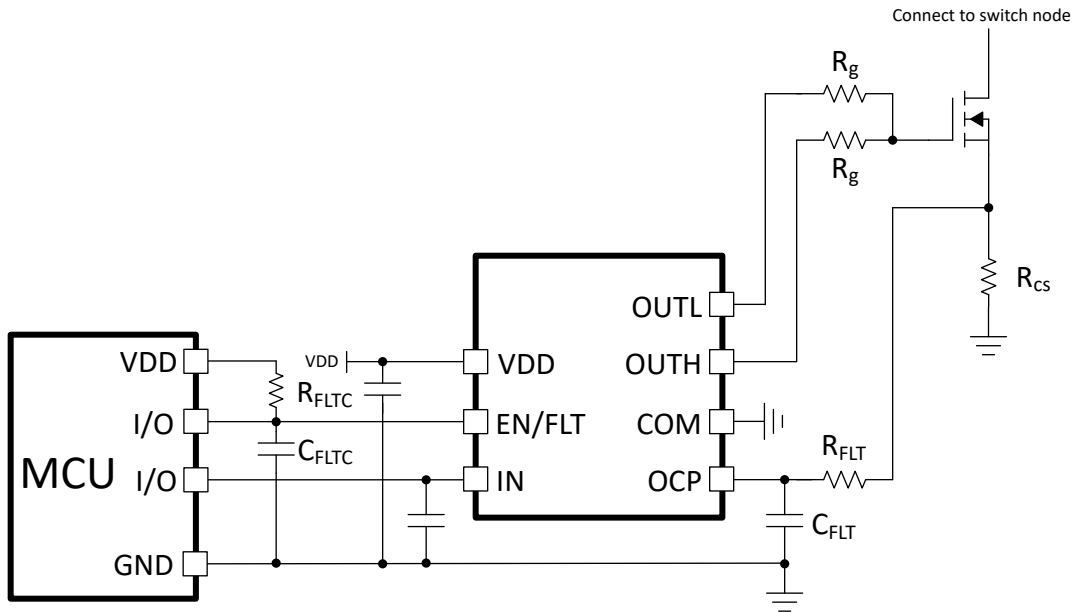

Figure 7-1. Driving a MOSFET/IGBT/SiC MOSFET

#### 7.2.1.1 Design Requirements

When selecting the gate driver device for an end application, some design considerations must be evaluated in order to make the most appropriate selection. Following are some of the design parameters that should be used when selecting the gate driver device for an end application: input-to-output configuration, the input threshold type, bias supply voltage levels, peak source and sink currents, availability of independent enable and disable functions, propagation delay, power dissipation, and package type. See the example design parameters and requirements in [Table 7-1](#).

Table 7-1. Design Parameters

| DESIGN PARAMETER            | EXAMPLE VALUE |
|-----------------------------|---------------|
| Input to output logic       | Non-inverting |
| Input threshold type        | TTL           |
| Bias supply voltage levels  | +18V          |
| Negative output low voltage | N/A           |
| Enable function             | Yes           |
| Disable function            | N/A           |
| Propagation delay           | <30ns         |
| Power dissipation           | <1W           |
| Package type                | SOIC-8        |

#### 7.2.1.2 Detailed Design Procedure

##### 7.2.1.2.1 VDD Undervoltage Lockout

The UCC57132 device provides an undervoltage lockout threshold of 12V and the UCC57138 device provides an undervoltage lockout threshold of 8V. The device's hysteresis range helps to avoid any chattering due to the presence of noise on the bias supply. 1V of typical UVLO hysteresis is expected. There is no significant driver output turnon delay due to the UVLO feature, and 2 $\mu$ s of UVLO delay is expected. The UVLO turn-off delay is also minimized as much as possible. The UVLO delay is designed to minimize chattering that may occur due

to very fast transients that may appear on VDD. When the bias supply is below UVLO thresholds, the outputs are held actively low irrespective of the state of the input pins. When exit the UVLO, the EN/FLT is charged by external pull up circuit. The fault clear time is depended on the time constant of the  $R_{FLT}$  and  $C_{FLT}$ . After exit the UVLO longer than the fault clear time the OUT follow the IN after the first raising edge of the IN.

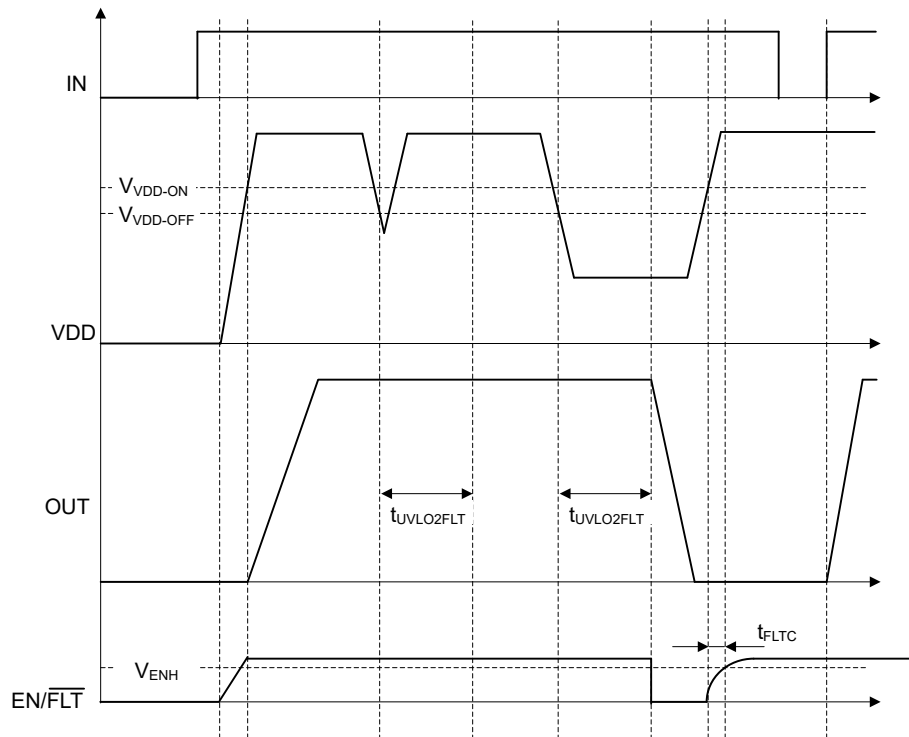

**Figure 7-2. UVLO Timing Diagram**

#### 7.2.1.2.2 Power Dissipation

Power dissipation of the gate driver has two portions as shown in equation below:

$$P_{DISS} = P_{DC} + P_{SW} \quad (2)$$

The DC portion of the power dissipation is  $P_{DC} = I_Q \times V_{DD}$  where  $I_Q$  is the quiescent current for the driver. The quiescent current is the current consumed by the device to bias all internal circuits such as input stage, reference voltage, logic circuits, protections, and so on, and any current associated with switching of internal devices when the driver output changes state (such as charging and discharging of internal parasitic capacitances, parasitic shoot-through). The UCC5713x contains internal logic to minimize any shoot-through (PMOS to NMOS and vice versa) in the output driver stage. Thus, the effect of the  $P_{DC}$  on the total power dissipation within the gate driver can be assumed to be negligible. In practice this is the power consumed by driver when its output is disconnected from the gate of power switch.

As explained in earlier sections, the output stage of the gate driver is based on PMOS and NMOS. These NMOS and PMOS are designed in such a way that they offer very low resistance during switching. And therefore they have very low drop-out. The power dissipated in the gate driver package during switching ( $P_{SW}$ ) depends on the following factors:

- Gate charge required of the power device (usually a function of the drive voltage  $V_G$ , which is very close to input bias supply voltage  $V_{DD}$  due to low  $V_{OX}$  drop-out)
- Switching frequency
- Power MOSFET internal and external gate resistor

When a driver device is tested with a discrete, capacitive load it is a fairly simple matter to calculate the power that is required from the bias supply. The energy that must be transferred from the bias supply to charge the capacitor is given by:

$$E_G = \frac{1}{2} C_{LOAD} V_{DD}^2 \quad (3)$$

where

- $C_{LOAD}$  is load capacitor and  $V_{DD}$  is bias voltage feeding the driver.

There is an equal amount of energy dissipated when the capacitor is discharged. During turnoff the energy stored in capacitor is fully dissipated in drive circuit. This leads to a total power loss during switching cycle given by the following:

$$P_G = C_{LOAD} V_{DD}^2 f_{sw} \quad (4)$$

where

- $f_{sw}$  is the switching frequency

The switching load presented by a power FET and IGBT can be converted to an equivalent capacitance by examining the gate charge required to switch the device. This gate charge includes the effects of the input capacitance plus the added charge needed to swing the drain voltage of the power device as it switches between the ON and OFF states. Most manufacturers provide specifications of typical and maximum gate charge, in nC, to switch the device under specified conditions. Using the gate charge  $Q_g$ , one can determine the power that must be dissipated when charging a capacitor. This is done by using the equivalence,  $Q_g = C_{LOAD} V_{DD}$ , to provide the following equation for power:

$$P_G = C_{LOAD} V_{DD}^2 f_{sw} = Q_g V_{DD} f_{sw} \quad (5)$$

This power  $P_G$  is dissipated in the resistive elements of the circuit when the MOSFET and IGBT is being turned on or off. Half of the total power is dissipated when the load capacitor is charged during turnon, and the other half is dissipated when the load capacitor is discharged during turn-off. When no external gate resistor is employed between the driver IC and MOSFET/IGBT, this power is completely dissipated inside the driver IC. With the use of external gate drive resistors, the power dissipation is shared between the internal resistance of driver and external gate resistor in accordance to the ratio of the resistances (more power dissipated in the higher resistance component). Based on this simplified analysis, the driver power dissipation during switching is calculated as shown in following equation. This primarily applies to those applications where total external gate resistor is significantly large to limit the peak current of the gate driver.

$$P_{SW} = 0.5 \times Q_g \times V_{DD} \times f_{sw} \left( \frac{R_{OFF}}{(R_{OFF} + R_{GATE})} + \frac{R_{ON}}{(R_{ON} + R_{GATE})} \right) \quad (6)$$

where

- $R_{OFF} = R_{OL}$  and  $R_{ON}$  (effective resistance of pullup structure)

### 7.2.1.3 Application Curves

The figures below show the typical switching characteristics of the UCC5713x device with a 1nF capacitor load.

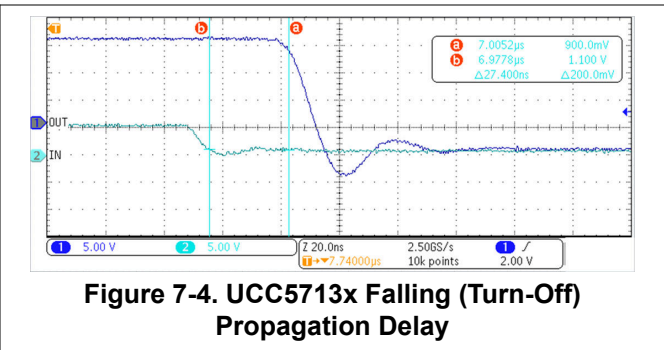
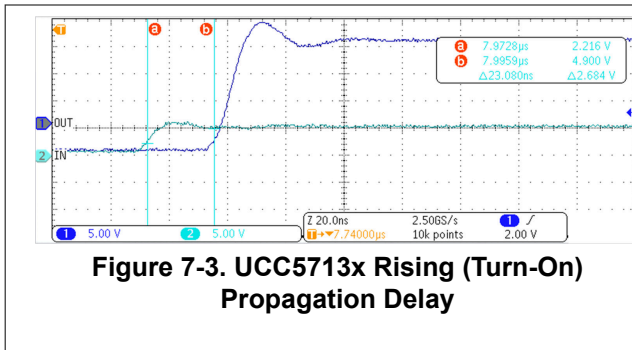

### 7.3 Power Supply Recommendations

The bias supply voltage range for which the UCC5713x devices are recommended to operate is from UVLO to 26V. The lower end of this range is governed by the internal UVLO protection feature on the VDD pin supply circuit blocks. Whenever the driver is in UVLO condition when the VDD pin voltage is below the  $V_{(ON)}$  supply start threshold, this feature holds the output low, regardless of the status of the inputs. The upper end of this range is driven by the 26V recommended maximum voltage rating of the VDD pin of the device. The absolute maximum voltage for the VDD pin is 30V.

The UVLO protection feature also involves a hysteresis function. This means that when the VDD pin bias voltage has exceeded the threshold voltage and device begins to operate, and if the voltage drops, then the device continues to deliver normal functionality unless the voltage drop exceeds the hysteresis specification. Therefore, ensuring that, while operating at or near the UVLO, the voltage ripple on the auxiliary power supply output is smaller than the hysteresis specification of the device is important to avoid triggering device shutdown.

During system shutdown, the device operation continues until the VDD pin voltage has dropped below the VDD UVLO falling threshold which must be accounted for while evaluating system shutdown timing design requirements. Likewise, at system start-up, the device does not begin operation until the VDD pin voltage has exceeded above the VDD UVLO rising threshold. The quiescent current consumed by the internal circuit blocks of the device is supplied through the VDD pin. Although this fact is well known, recognizing that the charge for source current pulses delivered by the OUT pin is also supplied through the same VDD pin is important. As a result, every time a current is sourced out of the output pin (OUT), a corresponding current pulse is delivered into the device through the VDD pin. Thus ensuring that local bypass capacitors are provided between the VDD and COM pins and located as close to the device as possible for the purpose of decoupling is important. A low-ESR, ceramic surface-mount capacitor is needed. TI recommends having two capacitors; a 100nF ceramic surface-mount capacitor placed less than 1mm from the VDD pin of the device and another ceramic surface-mount capacitor of few microfarads added in parallel. Similarly, for the VEE pin in the UCC5713xB, the 100nF and 1µF capacitor is recommended.

If the gate driver is placed far from the switching power device such as MOSFET then that may create large inductive loop. Large inductive loop may cause excessive ringing on any and all pins of the gate driver. This may result in stress exceeding device recommended rating. Therefore, it is recommended to place the gate driver as close to the switching power device as possible. It is also advisable to use an external gate resistor to damp any ringing due to the high switching currents and board parasitic elements.

### 7.4 Layout

#### 7.4.1 Layout Guidelines

Proper PCB layout is extremely important in a high-current, fast-switching circuit to provide appropriate device operation and design robustness. The UCC5713x gate driver incorporates short propagation delays and powerful output stages capable of delivering large current peaks with very fast rise and fall times at the gate of power switch to facilitate voltage transitions very quickly. Very high  $di/dt$  can cause unacceptable ringing if the trace lengths and impedances are not well controlled. The following circuit layout guidelines are recommended when designing with these high-speed drivers.

- Place the driver device as close as possible to power device to minimize the length of high-current traces between the driver output pins and the gate of the power switch device.
- Place the bypass capacitors between VDD pin and the COM pin as close to the driver pins as possible to minimize trace length for improved noise filtering. TI recommends having two capacitors; a 100nF ceramic surface-mount capacitor placed less than 1mm from the VDD pin of the device and another ceramic surface-mount capacitor of few microfarads added in parallel. These capacitors support high peak current being drawn from VDD during turnon of power switch. The use of low inductance surface-mount components such as chip capacitors is highly recommended.
- The turnon and turn-off current loop paths (driver device, power switch and VDD bypass capacitor) should be minimized as much as possible in order to keep the stray inductance to a minimum. High di/dt is established in these loops at two instances – during turnon and turn-off transients, which induces significant voltage transients on the output pins of the driver device and gate of the power switch.
- Wherever possible, parallel the source and return traces of a current loop, taking advantage of flux cancellation
- Separate power traces and signal traces, such as output and input signals.
- To minimize switch node transients and ringing, adding some gate resistance and/or snubbers on the power devices may be necessary. These measures may also reduce EMI.
- Star-point grounding is a good way to minimize noise coupling from one current loop to another. The COM of the driver should be connected to the other circuit nodes such as source of power switch, ground of PWM controller, and so forth, at a single point. The connected paths should be as short as possible to reduce inductance and be as wide as possible to reduce resistance.
- Use a ground plane to provide noise shielding. Fast rise and fall times at OUT pin may corrupt the input signals during transitions. The ground plane must not be a conduction path for any current loop. Instead the ground plane should be connected to the star-point with one trace to establish the ground potential. In addition to noise shielding, the ground plane can help in power dissipation as well.
- Place OCP filter capacitor to the driver OCP pin as close as possible. Also minimize the current sense loop will help with noise immunity. The sense resistor should be placed close to the IGBT emitter or source of the MOSFET to decrease the parasitic inductance. A low ESL film resistor is recommended for sense resistor.

### 7.4.2 Layout Example

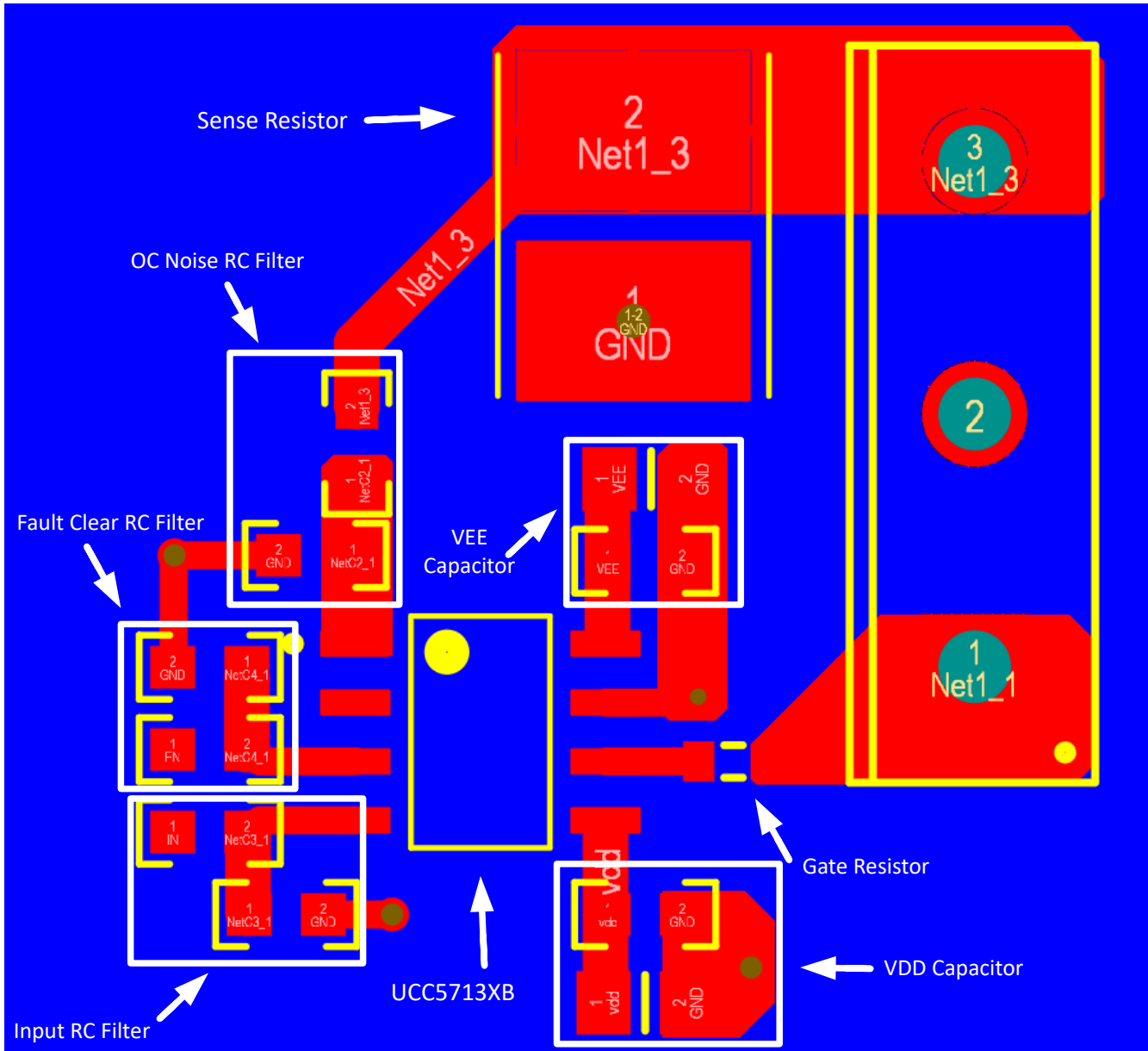

Figure 7-5. Layout Example: UCC5713x

### 7.4.3 Thermal Consideration

The useful range of a driver is greatly affected by the drive power requirements of the load and the thermal characteristics of the package. In order for a gate driver to be useful over a particular temperature range the package must allow for the efficient removal of the heat produced while keeping the junction temperature within rated limits. The thermal metrics for the driver package is summarized in the Thermal Characteristics section of the datasheet. For detailed information regarding the thermal information table, refer to [IC Package Thermal Metrics Application Note \(SPRA953\)](#).

## 8 Device and Documentation Support

### 8.1 Third-Party Products Disclaimer

TI'S PUBLICATION OF INFORMATION REGARDING THIRD-PARTY PRODUCTS OR SERVICES DOES NOT CONSTITUTE AN ENDORSEMENT REGARDING THE SUITABILITY OF SUCH PRODUCTS OR SERVICES OR A WARRANTY, REPRESENTATION OR ENDORSEMENT OF SUCH PRODUCTS OR SERVICES, EITHER ALONE OR IN COMBINATION WITH ANY TI PRODUCT OR SERVICE.

### 8.2 Receiving Notification of Documentation Updates

To receive notification of documentation updates, navigate to the device product folder on [ti.com](http://ti.com). Click on *Notifications* to register and receive a weekly digest of any product information that has changed. For change details, review the revision history included in any revised document.

### 8.3 Support Resources

[TI E2E™ support forums](#) are an engineer's go-to source for fast, verified answers and design help — straight from the experts. Search existing answers or ask your own question to get the quick design help you need.

Linked content is provided "AS IS" by the respective contributors. They do not constitute TI specifications and do not necessarily reflect TI's views; see TI's [Terms of Use](#).

### 8.4 Trademarks

TI E2E™ is a trademark of Texas Instruments.  
All trademarks are the property of their respective owners.

### 8.5 Electrostatic Discharge Caution



This integrated circuit can be damaged by ESD. Texas Instruments recommends that all integrated circuits be handled with appropriate precautions. Failure to observe proper handling and installation procedures can cause damage.

ESD damage can range from subtle performance degradation to complete device failure. Precision integrated circuits may be more susceptible to damage because very small parametric changes could cause the device not to meet its published specifications.

### 8.6 Glossary

[TI Glossary](#) This glossary lists and explains terms, acronyms, and definitions.

## 9 Revision History

NOTE: Page numbers for previous revisions may differ from page numbers in the current version.

| DATE        | REVISION | NOTES           |
|-------------|----------|-----------------|
| August 2025 | *        | Initial Release |

## 10 Mechanical, Packaging, and Orderable Information

The following pages include mechanical, packaging, and orderable information. This information is the most current data available for the designated devices. This data is subject to change without notice and revision of this document. For browser-based versions of this data sheet, refer to the left-hand navigation.



**PACKAGING INFORMATION**

| Orderable part number       | Status<br>(1) | Material type<br>(2) | Package   Pins | Package qty   Carrier | RoHS<br>(3) | Lead finish/<br>Ball material<br>(4) | MSL rating/<br>Peak reflow<br>(5) | Op temp (°C) | Part marking<br>(6) |
|-----------------------------|---------------|----------------------|----------------|-----------------------|-------------|--------------------------------------|-----------------------------------|--------------|---------------------|
| <a href="#">UCC57132BDR</a> | Active        | Production           | SOIC (D)   8   | 2500   LARGE T&R      | Yes         | NIPDAU                               | Level-1-260C-UNLIM                | -40 to 125   | UC132B              |
| <a href="#">UCC57138CDR</a> | Active        | Production           | SOIC (D)   8   | 2500   LARGE T&R      | Yes         | NIPDAU                               | Level-1-260C-UNLIM                | -40 to 125   | UC138C              |

(1) **Status:** For more details on status, see our [product life cycle](#).

(2) **Material type:** When designated, preproduction parts are prototypes/experimental devices, and are not yet approved or released for full production. Testing and final process, including without limitation quality assurance, reliability performance testing, and/or process qualification, may not yet be complete, and this item is subject to further changes or possible discontinuation. If available for ordering, purchases will be subject to an additional waiver at checkout, and are intended for early internal evaluation purposes only. These items are sold without warranties of any kind.

(3) **RoHS values:** Yes, No, RoHS Exempt. See the [TI RoHS Statement](#) for additional information and value definition.

(4) **Lead finish/Ball material:** Parts may have multiple material finish options. Finish options are separated by a vertical ruled line. Lead finish/Ball material values may wrap to two lines if the finish value exceeds the maximum column width.

(5) **MSL rating/Peak reflow:** The moisture sensitivity level ratings and peak solder (reflow) temperatures. In the event that a part has multiple moisture sensitivity ratings, only the lowest level per JEDEC standards is shown. Refer to the shipping label for the actual reflow temperature that will be used to mount the part to the printed circuit board.

(6) **Part marking:** There may be an additional marking, which relates to the logo, the lot trace code information, or the environmental category of the part.

Multiple part markings will be inside parentheses. Only one part marking contained in parentheses and separated by a "~" will appear on a part. If a line is indented then it is a continuation of the previous line and the two combined represent the entire part marking for that device.

**Important Information and Disclaimer:**The information provided on this page represents TI's knowledge and belief as of the date that it is provided. TI bases its knowledge and belief on information provided by third parties, and makes no representation or warranty as to the accuracy of such information. Efforts are underway to better integrate information from third parties. TI has taken and continues to take reasonable steps to provide representative and accurate information but may not have conducted destructive testing or chemical analysis on incoming materials and chemicals. TI and TI suppliers consider certain information to be proprietary, and thus CAS numbers and other limited information may not be available for release.

In no event shall TI's liability arising out of such information exceed the total purchase price of the TI part(s) at issue in this document sold by TI to Customer on an annual basis.

**OTHER QUALIFIED VERSIONS OF UCC57132, UCC57138 :**

- Automotive : [UCC57132-Q1](#), [UCC57138-Q1](#)

NOTE: Qualified Version Definitions:

- Automotive - Q100 devices qualified for high-reliability automotive applications targeting zero defects

**TAPE AND REEL INFORMATION**

**QUADRANT ASSIGNMENTS FOR PIN 1 ORIENTATION IN TAPE**

\*All dimensions are nominal

| Device      | Package Type | Package Drawing | Pins | SPQ  | Reel Diameter (mm) | Reel Width W1 (mm) | A0 (mm) | B0 (mm) | K0 (mm) | P1 (mm) | W (mm) | Pin1 Quadrant |
|-------------|--------------|-----------------|------|------|--------------------|--------------------|---------|---------|---------|---------|--------|---------------|
| UCC57132BDR | SOIC         | D               | 8    | 2500 | 330.0              | 12.5               | 6.4     | 5.2     | 2.1     | 8.0     | 12.0   | Q1            |
| UCC57138CDR | SOIC         | D               | 8    | 2500 | 330.0              | 12.5               | 6.4     | 5.2     | 2.1     | 8.0     | 12.0   | Q1            |

**TAPE AND REEL BOX DIMENSIONS**

\*All dimensions are nominal

| Device      | Package Type | Package Drawing | Pins | SPQ  | Length (mm) | Width (mm) | Height (mm) |
|-------------|--------------|-----------------|------|------|-------------|------------|-------------|
| UCC57132BDR | SOIC         | D               | 8    | 2500 | 353.0       | 353.0      | 32.0        |
| UCC57138CDR | SOIC         | D               | 8    | 2500 | 340.5       | 338.1      | 20.6        |



D0008A

# PACKAGE OUTLINE

SOIC - 1.75 mm max height

SMALL OUTLINE INTEGRATED CIRCUIT



4214825/C 02/2019

NOTES:

1. Linear dimensions are in inches [millimeters]. Dimensions in parenthesis are for reference only. Controlling dimensions are in inches. Dimensioning and tolerancing per ASME Y14.5M.
2. This drawing is subject to change without notice.
3. This dimension does not include mold flash, protrusions, or gate burrs. Mold flash, protrusions, or gate burrs shall not exceed  $.006$  [0.15] per side.
4. This dimension does not include interlead flash.
5. Reference JEDEC registration MS-012, variation AA.

# EXAMPLE BOARD LAYOUT

D0008A

SOIC - 1.75 mm max height

SMALL OUTLINE INTEGRATED CIRCUIT



LAND PATTERN EXAMPLE  
 EXPOSED METAL SHOWN  
 SCALE:8X



SOLDER MASK DETAILS

4214825/C 02/2019

NOTES: (continued)

- 6. Publication IPC-7351 may have alternate designs.
- 7. Solder mask tolerances between and around signal pads can vary based on board fabrication site.

# EXAMPLE STENCIL DESIGN

D0008A

SOIC - 1.75 mm max height

SMALL OUTLINE INTEGRATED CIRCUIT



SOLDER PASTE EXAMPLE  
BASED ON .005 INCH [0.125 MM] THICK STENCIL  
SCALE:8X

4214825/C 02/2019

NOTES: (continued)

8. Laser cutting apertures with trapezoidal walls and rounded corners may offer better paste release. IPC-7525 may have alternate design recommendations.
9. Board assembly site may have different recommendations for stencil design.

## IMPORTANT NOTICE AND DISCLAIMER

TI PROVIDES TECHNICAL AND RELIABILITY DATA (INCLUDING DATASHEETS), DESIGN RESOURCES (INCLUDING REFERENCE DESIGNS), APPLICATION OR OTHER DESIGN ADVICE, WEB TOOLS, SAFETY INFORMATION, AND OTHER RESOURCES "AS IS" AND WITH ALL FAULTS, AND DISCLAIMS ALL WARRANTIES, EXPRESS AND IMPLIED, INCLUDING WITHOUT LIMITATION ANY IMPLIED WARRANTIES OF MERCHANTABILITY, FITNESS FOR A PARTICULAR PURPOSE OR NON-INFRINGEMENT OF THIRD PARTY INTELLECTUAL PROPERTY RIGHTS.

These resources are intended for skilled developers designing with TI products. You are solely responsible for (1) selecting the appropriate TI products for your application, (2) designing, validating and testing your application, and (3) ensuring your application meets applicable standards, and any other safety, security, regulatory or other requirements.

These resources are subject to change without notice. TI grants you permission to use these resources only for development of an application that uses the TI products described in the resource. Other reproduction and display of these resources is prohibited. No license is granted to any other TI intellectual property right or to any third party intellectual property right. TI disclaims responsibility for, and you fully indemnify TI and its representatives against any claims, damages, costs, losses, and liabilities arising out of your use of these resources.

TI's products are provided subject to [TI's Terms of Sale](#), [TI's General Quality Guidelines](#), or other applicable terms available either on [ti.com](http://ti.com) or provided in conjunction with such TI products. TI's provision of these resources does not expand or otherwise alter TI's applicable warranties or warranty disclaimers for TI products. Unless TI explicitly designates a product as custom or customer-specified, TI products are standard, catalog, general purpose devices.

TI objects to and rejects any additional or different terms you may propose.

Copyright © 2025, Texas Instruments Incorporated

Last updated 10/2025