

ABSTRACT

This user's guide describes the characteristics, operation, and use of the TMAG5170 evaluation module (EVM). This EVM is designed to evaluate the performance of the TMAG5170. Throughout this document, the terms evaluation board, evaluation module, and EVM are synonymous with the TMAG5170UEVM. This document includes a schematic, reference printed circuit board (PCB) layouts, and a complete bill of materials (BOM).

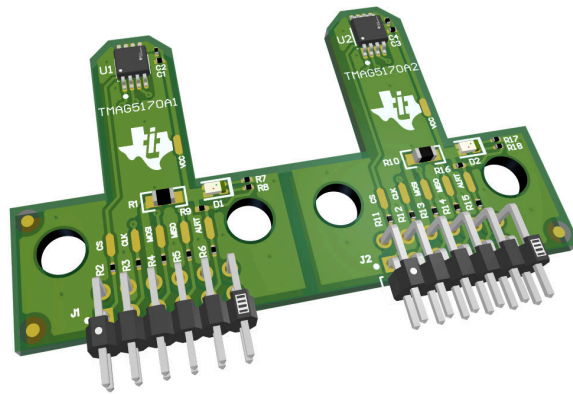

Table of Contents

1 Trademarks	1
2 Overview	2
2.1 Kit Contents.....	2
2.2 Related Documentation From Texas Instruments.....	2
3 Hardware	3
3.1 Features.....	3
4 Operation	3
4.1 Quick Start Setup.....	3
4.2 EVM Operation.....	4
5 Schematics, PCB Layout, and Bill of Materials	10
5.1 Schematics.....	10
5.2 PCB Layout.....	12
5.3 Bill of Materials.....	14
6 Revision History	15

1 Trademarks

All trademarks are the property of their respective owners.

2 Overview

The TMAG5170 is a 3-axis linear Hall effect sensor. This device integrates three independent Hall sensors in X, Y, and Z axes. A precision analog signal-chain along with integrated 12-bit ADC digitizes the measured analog magnetic field values. The device can be configured further to select one of three magnetic field ranges that suits the magnet strength and component placements during system calibration.

Table 2-1. TMAG5170 Device Summary

PRODUCT	SENSITIVITY RANGE OPTIONS
TMAG5170A1	±25 mT, ±50 mT, ±100 mT
TMAG5170A2	±75 mT, ±150 mT, ±300 mT

2.1 Kit Contents

Table 2-2 lists the contents of the EVM kit. Contact the nearest [Texas Instruments Product Information Center](#) if any component is missing.

Table 2-2. Kit Contents

ITEM	QUANTITY
TMAG5170UEVM	1
Rotate and push 3D print module	1
Handheld magnet	1

2.2 Related Documentation From Texas Instruments

This user's guide is available from the TI website under literature number [SBAU350](#). Any letter appended to the literature number corresponds to the document revision that is current at the time of the writing of this document. Newer revisions are available from [www.ti.com](#) or the Texas Instruments' Literature Response Center at (800) 477-8924 or the Product Information Center at (972) 644-5580. When ordering, identify the document by both title and literature number. Table 2-3 lists documentation related to the EVM. Click the links in Table 2-3 for further information. The device name links to the product web folder on [www.ti.com](#). The literature number links to the document PDF.

Table 2-3. Related Documentation

DOCUMENT TITLE	DOCUMENT LITERATURE NUMBER
TMAG5170 data sheet	SBASAF4
TMAG5170-Q1 data sheet	SBAS934
TI-SCB User's Guide	SLAU839
TMAG5170 EVM Quick Start Video	–

3 Hardware

The EVM is an easy-to-use platform for evaluating the main features and performance of the TMAG5170. The EVM includes a graphical user interface (GUI) used to read and write registers, as well as view and save measurement results. Also included is a 3D printed Rotate & Push Module to test the common functions of angle measurement and push button with a single device.

The EVM is intended to provide basic functional evaluation of the devices. The layout is not intended to be a model for the target circuit, nor is it laid out for electromagnetic compatibility (EMC) testing. The EVM has both sensitivity variations of the TMAG5170 installed, and may be broken into two separate boards as needed. It is intended to interface with the [TI-SCB](#), but may be used stand-alone if desired.

3.1 Features

- Snap Apart PCB for evaluation of both TMAG5170A1 and TMAG5170A2 sensitivities
- GUI support to read and write device registers, as well as view and save measurement results
- 3D print rotate and push module
- Detachable EVM for custom use cases
- Conveniently powered from a common micro-USB connector

4 Operation

4.1 Quick Start Setup

The following instructions describe how to set up and use the EVM.

1. Download and install this driver: <http://www.ti.com/lit/zip/sbac253>
2. Attach the EVM to the Sensor Control Board (TI-SCB) (see [Figure 4-1](#)).
3. Connect the EVM to a PC using a USB cable.
 - a. Insert the micro USB cable into the TI-SCB Controller onboard USB receptacle J2.
 - b. Plug the other end of the USB cable into a PC.
4. Access the GUI from the below link in either Chrome or Firefox:
 - a. TMAG5170EVM GUI: https://dev.ti.com/gallery/view/PositionSensing/TMAG5170UEVM_GUI/
5. Configure the device through the register map settings:
 - a. Set OPERATING_MODE within the DEVICE_CONFIG register to "Active Measure Mode" (0b101)
 - b. Set MAG_CH_EN within the SENSOR_CONFIG register to "XYZ" (0b0111)
6. Navigate to the *Plots* panel and click *Collect Data*
7. Apply a magnetic field to the sensor by doing one of the following:
 - a. Wave the included handheld magnet around the sensor.
 - b. Use the Rotate & Push Module by attaching it to the EVM (see [Figure 4-10](#)). For more details on how to use this module, see [Section 4.2.2](#).
8. Observe the outputs in the GUI. See [Section 4.2.1.3](#) for more info on GUI setup and operation.

4.2 EVM Operation

To use the EVM with the included TI-SCB Controller, connect the EVM as shown in [Figure 4-1](#).

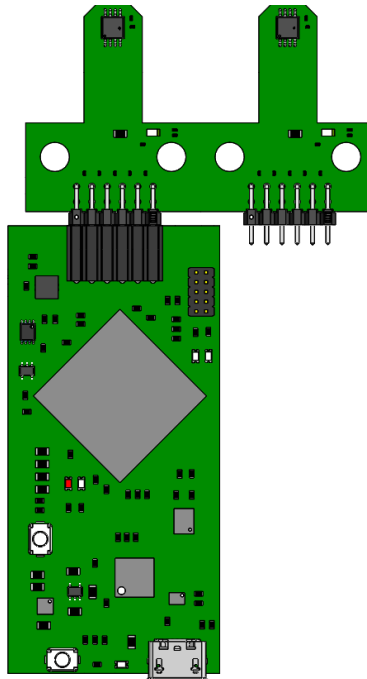

Figure 4-1. EVM on TI-SCB Controller

It is optional to snap apart the TMAG5170UEVM to separate the TMAG5170A1 and TMAG5170A2 halves. This may be done by flexing the PCB at the indicated boundary below

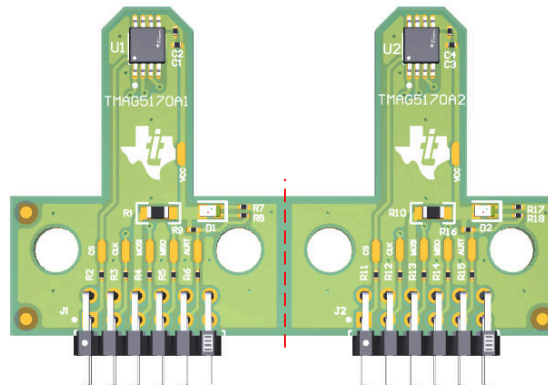

Figure 4-2. TMAG5170UEVM Snap Apart Edge

4.2.1 Setup

4.2.1.1 Driver Installation

Download and install this driver: <http://www.ti.com/lit/zip/sbac253>. This is a one-time step per computer. Unzip the folder and run the .exe file with administrator privileges.

4.2.1.2 Firmware

The GUI is capable of loading firmware onto the TI-SCB as described in [Section 4.2.1.3.1](#). Firmware updates will be pushed through the GUI (requires driver installation). Downloaded offline GUIs may check for GUI/Firmware updates depending on the version.

4.2.1.2.1 Firmware Debug

If the firmware gets corrupted or must be manually reinstalled for any reason, follow these steps to reinstall the firmware. This is demonstrated in the [TMAG5170 EVM Quick Start Video](#).

1. Configure the MCU on the TI-SCB Controller to be in Device Firmware Update (DFU) Mode.
 - a. It is possible that the MCU has already entered DFU mode. If so, the GUI will notify you and try to update the firmware to the latest version after the GUI is connected to the PC.
 - b. DFU mode can be entered manually through one of the following methods while the TI-SCB Controller is powered on:
 - Through software:
 - Send the command 'bsl' on the TI-SCB's USB Serial (COM) port.
 - Through the hardware:
 - Ensure TI-SCB is connected to the PC through a USB
 - Short the two test points near PK1 and PK2 of the header pins (see [Figure 4-3](#)) with a pair of tweezers (or wire) while pressing the RESET button.

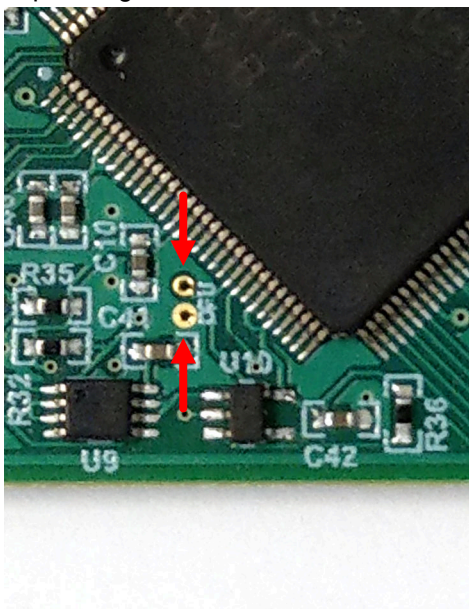

Figure 4-3. Test Points Used to Enter DFU Mode Manually

- c. LEDs D1 and D2 will be off if successful
2. With the MCU in DFU mode, the user can upload the firmware through one of the following methods:
 - Through the GUI:
 - In the *File* menu, select *Program Device*
 - The firmware update will initiate
 - After the GUI re-initializes, the TI-SCB should automatically connect
 - Through the USB Bootstrap Loader (BSL) scripser tool and batch file:
 - Download the firmware package and BSL scripser tool from the EVM page, or use the links below.
 - TMAG5170EVM: <http://www.ti.com/lit/zip/sbac268>
 - Unzip the firmware folder and run the .bat file.
 - If the firmware programming was unsuccessful, TI recommends to try repeating the above steps while using a different USB port on the machine.

4.2.1.3 GUI Setup and Usage

Access the GUI from the below link in either Chrome or Firefox:

- TMAG5170EVM GUI: https://dev.ti.com/gallery/view/PositionSensing/TMAG5170UEVM_GUI/

4.2.1.3.1 Initial Setup

To set up the GUI the first time, follow the below instructions:

1. Make sure that the above mentioned driver was installed successfully to ensure that everything works properly and that the GUI can update the EVM firmware, if necessary.
2. With the EVM/TI-SCB Controller unit plugged to the PC, go to the GUI link provided above.
3. To launch the GUI from the web browser, click the *GUI Composer* application to open the *GUI Composer* window (see [Figure 4-4](#)).

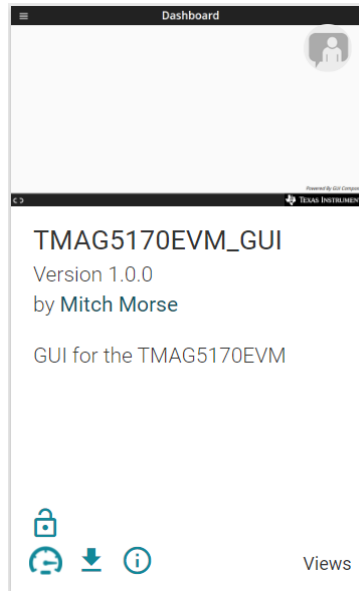

Figure 4-4. GUI Composer Application Window

- a. For first-time GUI Composer setup, follow the prompts to download the **TI Cloud Agent** and browser extension shown in [Figure 4-5](#). These prompts will appear after you close the README.md dialog.

TI Cloud Agent Installation

Hardware interaction requires additional one time set up. Please perform the actions listed below and try your operation again. (What's this?)

- Step 1: **INSTALL** browser extension
- Step 2: **DOWNLOAD** and install the TI Cloud Agent Application
- Help. I already did this

FINISH

Figure 4-5. TI Cloud Agent

4. Optionally, the GUI can be downloaded for offline use by clicking the  icon in the *GUI Composer* window shown in [Figure 4-4](#).

4.2.1.3.2 GUI Operation

To operate the GUI, follow these steps:

1. Connect to and launch the GUI as described in [Section 4.2.1.3.1](#).
2. With the EVM connected to the GUI, close the README.md file page. The text near the bottom-left hand corner of the GUI should read *Hardware Connected* (see [Figure 4-6](#)).

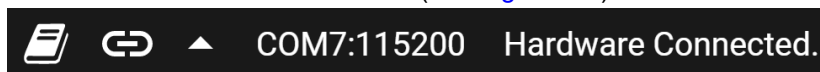

Figure 4-6. Hardware Connected

- a. If *Hardware Connected* does not show in the bottom-left hand corner of the GUI, check different hardware COM ports under *Options >> Serial Port* (see [Figure 4-7](#)).

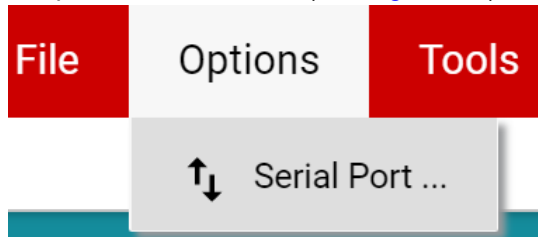



Figure 4-7. Change Serial Port

- b. If the hardware still does not connect, make sure you are using the correct GUI/EVM combination.
3. Click the *Registers* icon shown in [Figure 4-8](#) (also available on the left side menu) to view the register map, and change device settings, and enable automatic register read. For questions about a register or register bit field, select the  icon. For more questions about registers, check the data sheet.



Registers

Low level register read and write operations

Figure 4-8. Registers Page Icon

4. Click the *Plots* icon to view and save graphical data from the results registers (see [Figure 4-9](#)). This is also available on the left-side menu.



Plots

Plots for device outputs

Figure 4-9. Plots Page Icon

4.2.2 Rotate and Push Demo

To use the rotate and push demo:

1. Attach the Rotate & Push Module to the EVM as shown in [Figure 4-10](#).

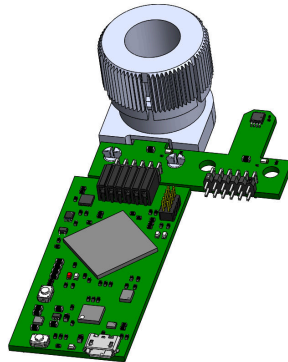

Figure 4-10. Rotate & Push Module on EVM

2. In the GUI register page:
 - a. Make sure that the DEVICE_CONFIG → OPERATING_MODE says (*TRIGGER_MODE Active*).
 - b. Make sure that SYSTEM_CONFIG → TRIGGER_MODE is set to the default value.
 - c. Under the SENSOR_CONFIG register:
 - i. Make sure both the x and y channels are enabled (MAG_CH_EN).
 - ii. Set X_RANGE and Y_RANGE to $\pm 100\text{mT}$ for A1 versions, and $\pm 133\text{mT}$ for A2 versions.
 - iii. Optional: Set ANGLE_EN to X-Y angle calculation.
 - d. At the top of the register map, set *Auto Read* to *As fast as possible*.
3. Go to the *Rotate & Push* tab inside the plots page (see [Figure 4-11](#)).

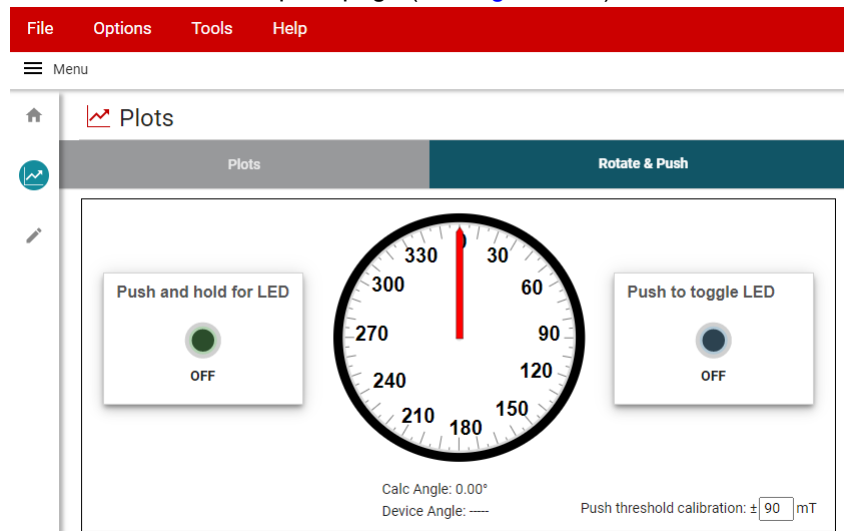

Figure 4-11. Rotate & Push GUI Page

4. If the push button LEDs are not triggering at every angle or trigger when they are not supposed to, calibrate the module by doing the following:
 - a. With the settings set to run the demo, slowly rotate the module 360° and use the plots page to record the absolute value of the minimum and maximum magnetic field measurements (in mT) for both the X and Y channels.
 - b. Adjust the *Push threshold calibration* value found in the *Rotate & Push* tab to be about 3-5mT larger than the maximum value recorded above.

4.2.3 Direct EVM Serial Communication

If desired, you can directly communicate with the TI-SCB without the use of the GUI through the USB serial (COM) port. Simply send the desired command string over the serial port and receive the results. This is useful for interfacing the EVM with custom setups/scripts/GUIs. To read and write registers, follow the below format:

- Read register format: rreg ADR
 - Where ADR is the address in hex, and rreg is always lower case
 - Register addresses can be in upper or lower case, and do not need to be led by '0x'. The 0 padding register addresses is also optional. For example, to read register address 0xA, some valid commands include:
 - rreg a
 - rreg 0A
 - rreg 0x0A
 - When '0x' is used, the 'x' must be lower case.
 - For the above example, the EVM would return the results in JSON format

```

{"acknowledge": "rreg 0x0A"}

{"register": {"address": 10, "value": 65488}}

{"evm_state": "idle"}
          
```
- Write register format: wreg ADR VAL
 - where ADR and VAL are in hex, and wreg is always lower case
 - Register addresses and values can be in upper or lower case, and do not need to be led by '0x'. The 0 padding register addresses and values is also optional. For example, to write register address 0x1 with the value 0x01c0, some valid commands include:
 - wreg 1 1c0
 - wreg 01 0x1c0
 - wreg 0x01 0x01C0
 - When '0x' is used, the 'x' must be lower case.
 - For the above example, the EVM would return the results in JSON format:

```

{"acknowledge": "wreg 0x01 0x01C0"}

{"console": "Writing 0x1c0 to SENSOR_CONFIG register"}

{"evm_state": "idle"}
          
```

5 Schematics, PCB Layout, and Bill of Materials

Note

Board layouts are not to scale. These figures are intended to show how the board is laid out. The figures are not intended to be used for manufacturing EVM PCBs.

5.1 Schematics

Figure 5-1 and Figure 5-2 show the schematic of the EVM. Figure 5-1 shows the circuitry for the EVM, and Figure 5-2 shows the mechanical components included with the EVM.

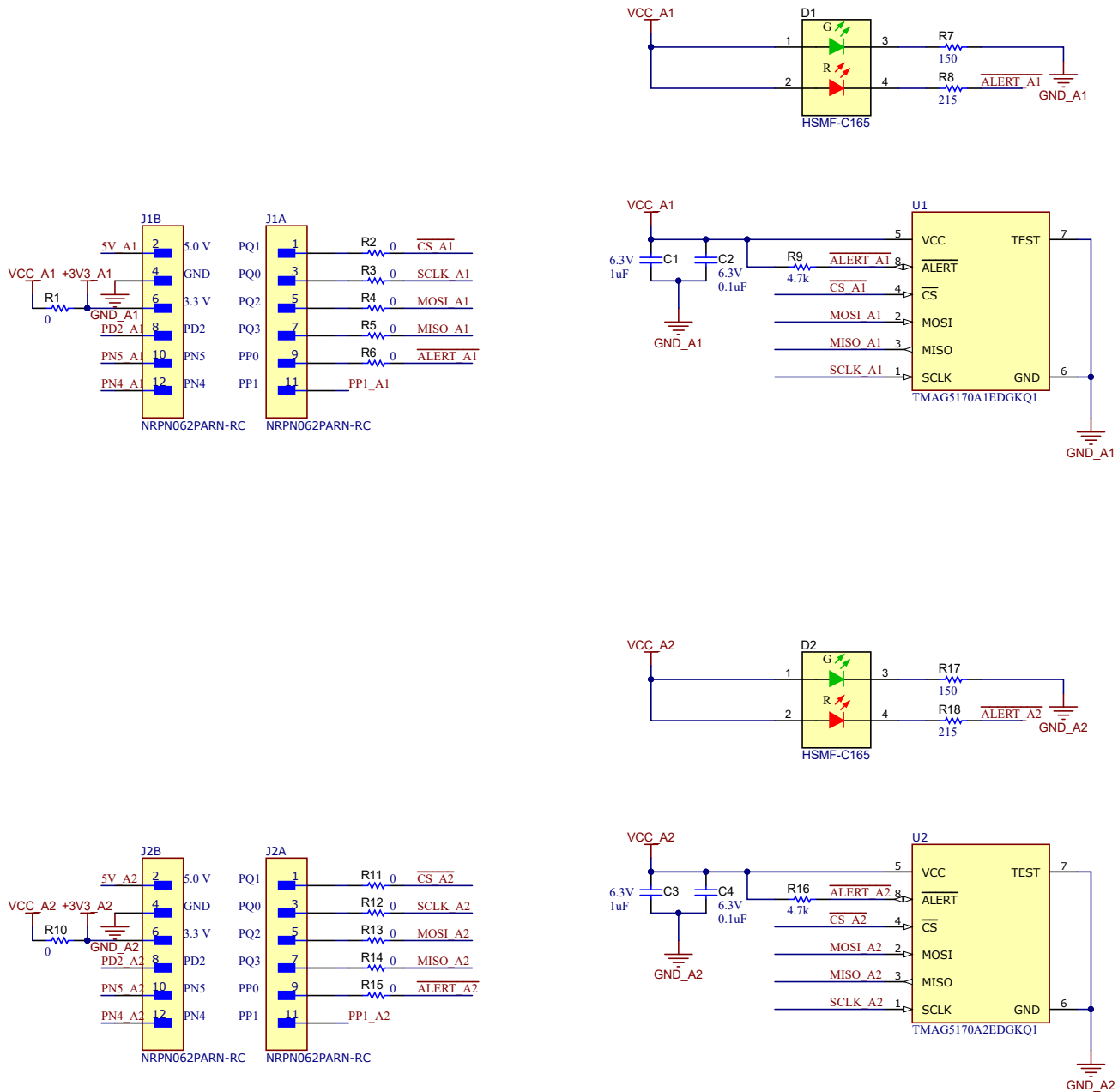

Figure 5-1. TMAG5170UEVM Schematic

H1 MECH SENS077	H2 MECH 6612041	H3 MECH D2X0	H4 MECH D82DIA	H5 MECH Rotate&PushModule	H6 MECH PC038-750-4500-SST-0598-C-N-IN
------------------------------	------------------------------	---------------------------	-----------------------------	--	---



PCB Number: SENS083
PCB Rev: A

PCB
LOGO
Texas Instruments



PCB
LOGO
WEEE logo

PCB
LOGO
Texas Instruments



PCB
LOGO
WEEE logo

Figure 5-2. Hardware Schematic

5.2 PCB Layout

Figure 5-3 through Figure 5-6 show the PCB layers of the EVM.

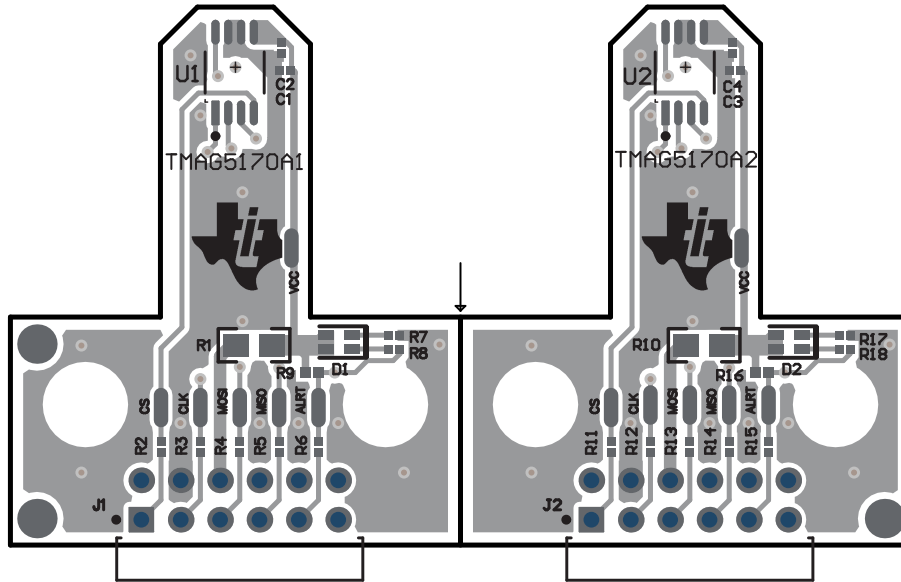

Figure 5-3. Top View

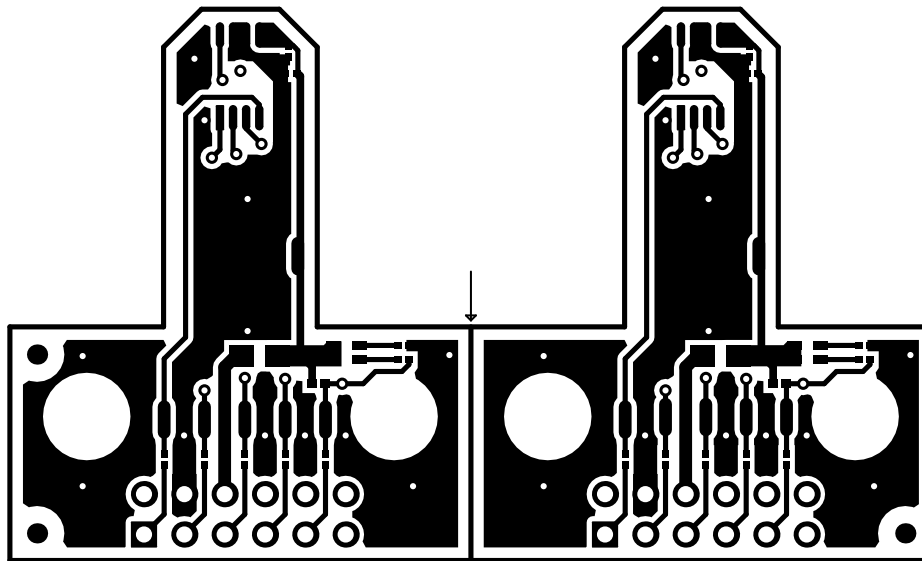

Figure 5-4. Top Layer

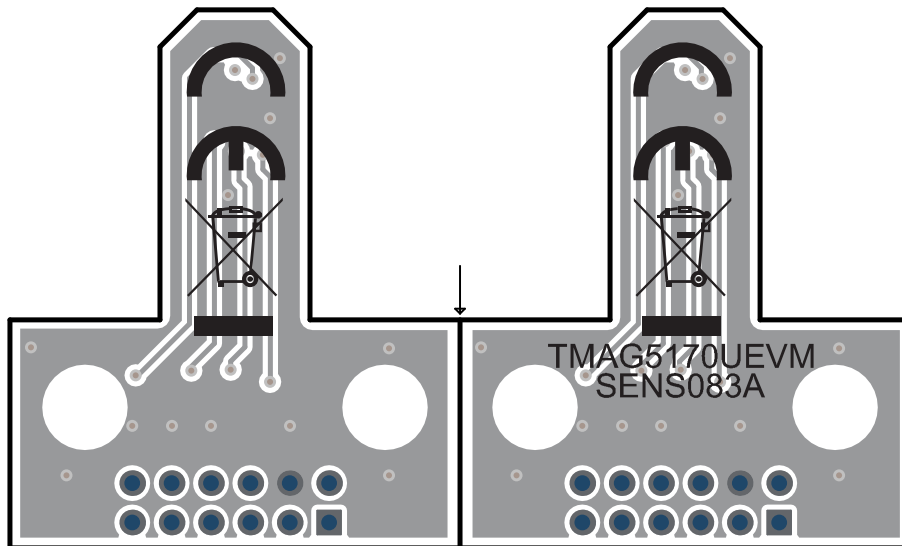

Figure 5-5. Bottom View

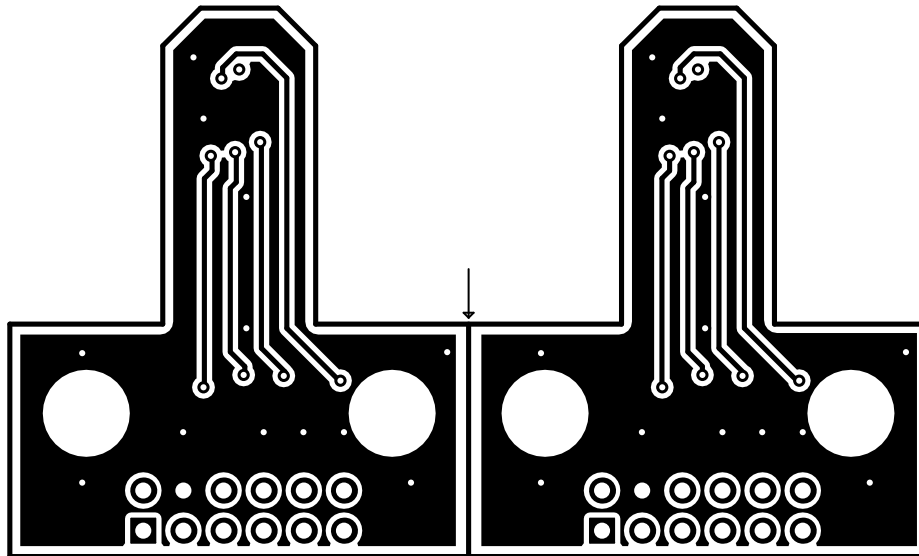

Figure 5-6. Bottom Layer

5.3 Bill of Materials

Table 5-1 provides the parts list for the EVM.

Table 5-1. Bill of Materials

Designator	Quantity	Value	Description	Package Reference	Part Number	Manufacturer
!PCB1	1		Printed Circuit Board		SENS083	Any
C1, C3	2	1uF	CAP, CERM, 1 uF, 6.3 V, +/- 20%, X5R, 0201	0201	GRM033R60J105MEA2D	MuRata
C2, C4	2	0.1uF	CAP, CERM, 0.1 uF, 6.3 V, +/- 10%, X5R, 0201	0201	GRM033R60J104KE19D	MuRata
D1, D2	2	Rg	LED, Rg, SMD	1.6x0.8mm	HSMF-C165	Avago
H1	1		Kitting Item: D2X0, 1/8" dia. x 1" thick, N42 magnet		D2X0	K&J Magnetics
H2	1		Kitting Item: D82DIA, 1/2" dia. x 1/8" thick, N42 diametric magnet		D82DIA	K&J Magnetics
H3	1		Kitting Item: Plastic module to test rotate and push setup.		Rotate&PushModule	Stratasys
H4	1		Spring for Rotate and Push Module https://www.thespringstore.com/pc038-750-4500-sst-0598-c-n-in.html		PC038-750-4500-SST-0598-C-N-IN	Access Spring
J1, J2	2			HDR12	NRPN062PARN-RC	Sullins Connector Solutions
R1, R10	2	0	RES, 0, 5%, 0.1 W, AEC-Q200 Grade 0, 0603	0603	CRCW06030000Z0EA	Vishay-Dale
R2, R3, R4, R5, R6, R11, R12, R13, R14, R15	10	0	RES, 0, 5%, 0.05 W, 0201	0201	CRCW02010000Z0ED	Vishay-Dale
R7, R17	2	150	RES, 150, 5%, 0.05 W, 0201	0201	RC0201JR-07150RL	Yageo America
R8, R18	2	215	RES, 215, 1%, 0.05 W, 0201	0201	RC0201FR-07215RL	Yageo America
R9, R16	2	4.7k	RES, 4.7 k, 5%, 0.05 W, 0201	0201	RC0201JR-7D4K7L	Yageo America
U1	1		Automotive, 3D high-precision linear Hall effect sensor with SPI bus interface 8-VSSOP -40 to 150	VSSOP8	TMAG5170A1E DGKQ1	Texas Instruments
U2	1		Automotive, 3D high-precision linear Hall effect sensor with SPI bus interface 8-VSSOP -40 to 150	VSSOP8	TMAG5170A2E DGKQ1	Texas Instruments

6 Revision History

NOTE: Page numbers for previous revisions may differ from page numbers in the current version.

Changes from Revision B (August 2022) to Revision C (February 2024) Page

- Changed GUI hyperlink in the *Quick Start Setup* section.....3
- Changed GUI hyperlink in the *GUI Setup and Usage* section.....6

Changes from Revision A (February 2022) to Revision B (August 2022) Page

- Added *TMAG5170 EVM Quick Start Video* links to the *Related Documentation* table..... 2
- Added steps to the *Quick Start Setup* instructions..... 3
- Changed the *Firmware Debug* instructions..... 5

Changes from Revision * (September 2021) to Revision A (February 2022) Page

- Updated the *Kit Contents* to reflect removal of the [TI-SCB](#), which is now available independently from this device..... 2
- Added [TI-SCB](#) User's Guide links to the *Related Documentation* table..... 2
- Changed *Hardware* section..... 3
- Changed *Firmware* section..... 4
- Changed hyperlink in the *GUI Setup and Usage* section..... 6
- Changed *Bill of Materials* table..... 14

STANDARD TERMS FOR EVALUATION MODULES

1. *Delivery:* TI delivers TI evaluation boards, kits, or modules, including any accompanying demonstration software, components, and/or documentation which may be provided together or separately (collectively, an "EVM" or "EVMs") to the User ("User") in accordance with the terms set forth herein. User's acceptance of the EVM is expressly subject to the following terms.
 - 1.1 EVMs are intended solely for product or software developers for use in a research and development setting to facilitate feasibility evaluation, experimentation, or scientific analysis of TI semiconductor products. EVMs have no direct function and are not finished products. EVMs shall not be directly or indirectly assembled as a part or subassembly in any finished product. For clarification, any software or software tools provided with the EVM ("Software") shall not be subject to the terms and conditions set forth herein but rather shall be subject to the applicable terms that accompany such Software
 - 1.2 EVMs are not intended for consumer or household use. EVMs may not be sold, sublicensed, leased, rented, loaned, assigned, or otherwise distributed for commercial purposes by Users, in whole or in part, or used in any finished product or production system.
2. *Limited Warranty and Related Remedies/Disclaimers:*
 - 2.1 These terms do not apply to Software. The warranty, if any, for Software is covered in the applicable Software License Agreement.
 - 2.2 TI warrants that the TI EVM will conform to TI's published specifications for ninety (90) days after the date TI delivers such EVM to User. Notwithstanding the foregoing, TI shall not be liable for a nonconforming EVM if (a) the nonconformity was caused by neglect, misuse or mistreatment by an entity other than TI, including improper installation or testing, or for any EVMs that have been altered or modified in any way by an entity other than TI, (b) the nonconformity resulted from User's design, specifications or instructions for such EVMs or improper system design, or (c) User has not paid on time. Testing and other quality control techniques are used to the extent TI deems necessary. TI does not test all parameters of each EVM. User's claims against TI under this Section 2 are void if User fails to notify TI of any apparent defects in the EVMs within ten (10) business days after delivery, or of any hidden defects with ten (10) business days after the defect has been detected.
 - 2.3 TI's sole liability shall be at its option to repair or replace EVMs that fail to conform to the warranty set forth above, or credit User's account for such EVM. TI's liability under this warranty shall be limited to EVMs that are returned during the warranty period to the address designated by TI and that are determined by TI not to conform to such warranty. If TI elects to repair or replace such EVM, TI shall have a reasonable time to repair such EVM or provide replacements. Repaired EVMs shall be warranted for the remainder of the original warranty period. Replaced EVMs shall be warranted for a new full ninety (90) day warranty period.

WARNING

Evaluation Kits are intended solely for use by technically qualified, professional electronics experts who are familiar with the dangers and application risks associated with handling electrical mechanical components, systems, and subsystems.

User shall operate the Evaluation Kit within TI's recommended guidelines and any applicable legal or environmental requirements as well as reasonable and customary safeguards. Failure to set up and/or operate the Evaluation Kit within TI's recommended guidelines may result in personal injury or death or property damage. Proper set up entails following TI's instructions for electrical ratings of interface circuits such as input, output and electrical loads.

NOTE:

EXPOSURE TO ELECTROSTATIC DISCHARGE (ESD) MAY CAUSE DEGRADATION OR FAILURE OF THE EVALUATION KIT; TI RECOMMENDS STORAGE OF THE EVALUATION KIT IN A PROTECTIVE ESD BAG.

3 Regulatory Notices:

3.1 United States

3.1.1 Notice applicable to EVMs not FCC-Approved:

FCC NOTICE: This kit is designed to allow product developers to evaluate electronic components, circuitry, or software associated with the kit to determine whether to incorporate such items in a finished product and software developers to write software applications for use with the end product. This kit is not a finished product and when assembled may not be resold or otherwise marketed unless all required FCC equipment authorizations are first obtained. Operation is subject to the condition that this product not cause harmful interference to licensed radio stations and that this product accept harmful interference. Unless the assembled kit is designed to operate under part 15, part 18 or part 95 of this chapter, the operator of the kit must operate under the authority of an FCC license holder or must secure an experimental authorization under part 5 of this chapter.

3.1.2 For EVMs annotated as FCC – FEDERAL COMMUNICATIONS COMMISSION Part 15 Compliant:

CAUTION

This device complies with part 15 of the FCC Rules. Operation is subject to the following two conditions: (1) This device may not cause harmful interference, and (2) this device must accept any interference received, including interference that may cause undesired operation.

Changes or modifications not expressly approved by the party responsible for compliance could void the user's authority to operate the equipment.

FCC Interference Statement for Class A EVM devices

NOTE: This equipment has been tested and found to comply with the limits for a Class A digital device, pursuant to part 15 of the FCC Rules. These limits are designed to provide reasonable protection against harmful interference when the equipment is operated in a commercial environment. This equipment generates, uses, and can radiate radio frequency energy and, if not installed and used in accordance with the instruction manual, may cause harmful interference to radio communications. Operation of this equipment in a residential area is likely to cause harmful interference in which case the user will be required to correct the interference at his own expense.

FCC Interference Statement for Class B EVM devices

NOTE: This equipment has been tested and found to comply with the limits for a Class B digital device, pursuant to part 15 of the FCC Rules. These limits are designed to provide reasonable protection against harmful interference in a residential installation. This equipment generates, uses and can radiate radio frequency energy and, if not installed and used in accordance with the instructions, may cause harmful interference to radio communications. However, there is no guarantee that interference will not occur in a particular installation. If this equipment does cause harmful interference to radio or television reception, which can be determined by turning the equipment off and on, the user is encouraged to try to correct the interference by one or more of the following measures:

- Reorient or relocate the receiving antenna.
- Increase the separation between the equipment and receiver.
- Connect the equipment into an outlet on a circuit different from that to which the receiver is connected.
- Consult the dealer or an experienced radio/TV technician for help.

3.2 Canada

3.2.1 For EVMs issued with an Industry Canada Certificate of Conformance to RSS-210 or RSS-247

Concerning EVMs Including Radio Transmitters:

This device complies with Industry Canada license-exempt RSSs. Operation is subject to the following two conditions:

(1) this device may not cause interference, and (2) this device must accept any interference, including interference that may cause undesired operation of the device.

Concernant les EVMs avec appareils radio:

Le présent appareil est conforme aux CNR d'Industrie Canada applicables aux appareils radio exempts de licence. L'exploitation est autorisée aux deux conditions suivantes: (1) l'appareil ne doit pas produire de brouillage, et (2) l'utilisateur de l'appareil doit accepter tout brouillage radioélectrique subi, même si le brouillage est susceptible d'en compromettre le fonctionnement.

Concerning EVMs Including Detachable Antennas:

Under Industry Canada regulations, this radio transmitter may only operate using an antenna of a type and maximum (or lesser) gain approved for the transmitter by Industry Canada. To reduce potential radio interference to other users, the antenna type and its gain should be so chosen that the equivalent isotropically radiated power (e.i.r.p.) is not more than that necessary for successful communication. This radio transmitter has been approved by Industry Canada to operate with the antenna types listed in the user guide with the maximum permissible gain and required antenna impedance for each antenna type indicated. Antenna types not included in this list, having a gain greater than the maximum gain indicated for that type, are strictly prohibited for use with this device.

Concernant les EVMs avec antennes détachables

Conformément à la réglementation d'Industrie Canada, le présent émetteur radio peut fonctionner avec une antenne d'un type et d'un gain maximal (ou inférieur) approuvé pour l'émetteur par Industrie Canada. Dans le but de réduire les risques de brouillage radioélectrique à l'intention des autres utilisateurs, il faut choisir le type d'antenne et son gain de sorte que la puissance isotrope rayonnée équivalente (p.i.r.e.) ne dépasse pas l'intensité nécessaire à l'établissement d'une communication satisfaisante. Le présent émetteur radio a été approuvé par Industrie Canada pour fonctionner avec les types d'antenne énumérés dans le manuel d'usage et ayant un gain admissible maximal et l'impédance requise pour chaque type d'antenne. Les types d'antenne non inclus dans cette liste, ou dont le gain est supérieur au gain maximal indiqué, sont strictement interdits pour l'exploitation de l'émetteur.

3.3 Japan

3.3.1 *Notice for EVMs delivered in Japan:* Please see http://www.tij.co.jp/lstds/ti_ja/general/eStore/notice_01.page 日本国内に輸入される評価用キット、ボードについては、次のところをご覧ください。

<https://www.ti.com/ja-jp/legal/notice-for-evaluation-kits-delivered-in-japan.html>

3.3.2 *Notice for Users of EVMs Considered "Radio Frequency Products" in Japan:* EVMs entering Japan may not be certified by TI as conforming to Technical Regulations of Radio Law of Japan.

If User uses EVMs in Japan, not certified to Technical Regulations of Radio Law of Japan, User is required to follow the instructions set forth by Radio Law of Japan, which includes, but is not limited to, the instructions below with respect to EVMs (which for the avoidance of doubt are stated strictly for convenience and should be verified by User):

1. Use EVMs in a shielded room or any other test facility as defined in the notification #173 issued by Ministry of Internal Affairs and Communications on March 28, 2006, based on Sub-section 1.1 of Article 6 of the Ministry's Rule for Enforcement of Radio Law of Japan,
2. Use EVMs only after User obtains the license of Test Radio Station as provided in Radio Law of Japan with respect to EVMs, or
3. Use of EVMs only after User obtains the Technical Regulations Conformity Certification as provided in Radio Law of Japan with respect to EVMs. Also, do not transfer EVMs, unless User gives the same notice above to the transferee. Please note that if User does not follow the instructions above, User will be subject to penalties of Radio Law of Japan.

【無線電波を送信する製品の開発キットをお使いになる際の注意事項】 開発キットの中には技術基準適合証明を受けていないものがあります。技術適合証明を受けていないものご使用に際しては、電波法遵守のため、以下のいずれかの措置を取っていただく必要がありますのでご注意ください。

1. 電波法施行規則第6条第1項第1号に基づく平成18年3月28日総務省告示第173号で定められた電波暗室等の試験設備でご使用いただく。
2. 実験局の免許を取得後ご使用いただく。
3. 技術基準適合証明を取得後ご使用いただく。

なお、本製品は、上記の「ご使用にあたっての注意」を譲渡先、移転先に通知しない限り、譲渡、移転できないものとします。

上記を遵守頂けない場合は、電波法の罰則が適用される可能性があることをご留意ください。日本テキサス・イ

ンスツルメンツ株式会社

東京都新宿区西新宿 6 丁目 2 4 番 1 号

西新宿三井ビル

3.3.3 *Notice for EVMs for Power Line Communication:* Please see http://www.tij.co.jp/lstds/ti_ja/general/eStore/notice_02.page

電力線搬送波通信についての開発キットをお使いになる際の注意事項については、次のところをご覧ください。 <https://www.ti.com/ja-jp/legal/notice-for-evaluation-kits-for-power-line-communication.html>

3.4 European Union

3.4.1 *For EVMs subject to EU Directive 2014/30/EU (Electromagnetic Compatibility Directive):*

This is a class A product intended for use in environments other than domestic environments that are connected to a low-voltage power-supply network that supplies buildings used for domestic purposes. In a domestic environment this product may cause radio interference in which case the user may be required to take adequate measures.

-
4. *EVM Use Restrictions and Warnings:*
 - 4.1 EVMS ARE NOT FOR USE IN FUNCTIONAL SAFETY AND/OR SAFETY CRITICAL EVALUATIONS, INCLUDING BUT NOT LIMITED TO EVALUATIONS OF LIFE SUPPORT APPLICATIONS.
 - 4.2 User must read and apply the user guide and other available documentation provided by TI regarding the EVM prior to handling or using the EVM, including without limitation any warning or restriction notices. The notices contain important safety information related to, for example, temperatures and voltages.
 - 4.3 *Safety-Related Warnings and Restrictions:*
 - 4.3.1 User shall operate the EVM within TI's recommended specifications and environmental considerations stated in the user guide, other available documentation provided by TI, and any other applicable requirements and employ reasonable and customary safeguards. Exceeding the specified performance ratings and specifications (including but not limited to input and output voltage, current, power, and environmental ranges) for the EVM may cause personal injury or death, or property damage. If there are questions concerning performance ratings and specifications, User should contact a TI field representative prior to connecting interface electronics including input power and intended loads. Any loads applied outside of the specified output range may also result in unintended and/or inaccurate operation and/or possible permanent damage to the EVM and/or interface electronics. Please consult the EVM user guide prior to connecting any load to the EVM output. If there is uncertainty as to the load specification, please contact a TI field representative. During normal operation, even with the inputs and outputs kept within the specified allowable ranges, some circuit components may have elevated case temperatures. These components include but are not limited to linear regulators, switching transistors, pass transistors, current sense resistors, and heat sinks, which can be identified using the information in the associated documentation. When working with the EVM, please be aware that the EVM may become very warm.
 - 4.3.2 EVMs are intended solely for use by technically qualified, professional electronics experts who are familiar with the dangers and application risks associated with handling electrical mechanical components, systems, and subsystems. User assumes all responsibility and liability for proper and safe handling and use of the EVM by User or its employees, affiliates, contractors or designees. User assumes all responsibility and liability to ensure that any interfaces (electronic and/or mechanical) between the EVM and any human body are designed with suitable isolation and means to safely limit accessible leakage currents to minimize the risk of electrical shock hazard. User assumes all responsibility and liability for any improper or unsafe handling or use of the EVM by User or its employees, affiliates, contractors or designees.
 - 4.4 User assumes all responsibility and liability to determine whether the EVM is subject to any applicable international, federal, state, or local laws and regulations related to User's handling and use of the EVM and, if applicable, User assumes all responsibility and liability for compliance in all respects with such laws and regulations. User assumes all responsibility and liability for proper disposal and recycling of the EVM consistent with all applicable international, federal, state, and local requirements.
 5. *Accuracy of Information:* To the extent TI provides information on the availability and function of EVMs, TI attempts to be as accurate as possible. However, TI does not warrant the accuracy of EVM descriptions, EVM availability or other information on its websites as accurate, complete, reliable, current, or error-free.
 6. *Disclaimers:*
 - 6.1 EXCEPT AS SET FORTH ABOVE, EVMS AND ANY MATERIALS PROVIDED WITH THE EVM (INCLUDING, BUT NOT LIMITED TO, REFERENCE DESIGNS AND THE DESIGN OF THE EVM ITSELF) ARE PROVIDED "AS IS" AND "WITH ALL FAULTS." TI DISCLAIMS ALL OTHER WARRANTIES, EXPRESS OR IMPLIED, REGARDING SUCH ITEMS, INCLUDING BUT NOT LIMITED TO ANY EPIDEMIC FAILURE WARRANTY OR IMPLIED WARRANTIES OF MERCHANTABILITY OR FITNESS FOR A PARTICULAR PURPOSE OR NON-INFRINGEMENT OF ANY THIRD PARTY PATENTS, COPYRIGHTS, TRADE SECRETS OR OTHER INTELLECTUAL PROPERTY RIGHTS.
 - 6.2 EXCEPT FOR THE LIMITED RIGHT TO USE THE EVM SET FORTH HEREIN, NOTHING IN THESE TERMS SHALL BE CONSTRUED AS GRANTING OR CONFERRING ANY RIGHTS BY LICENSE, PATENT, OR ANY OTHER INDUSTRIAL OR INTELLECTUAL PROPERTY RIGHT OF TI, ITS SUPPLIERS/LICENSORS OR ANY OTHER THIRD PARTY, TO USE THE EVM IN ANY FINISHED END-USER OR READY-TO-USE FINAL PRODUCT, OR FOR ANY INVENTION, DISCOVERY OR IMPROVEMENT, REGARDLESS OF WHEN MADE, CONCEIVED OR ACQUIRED.
 7. *USER'S INDEMNITY OBLIGATIONS AND REPRESENTATIONS.* USER WILL DEFEND, INDEMNIFY AND HOLD TI, ITS LICENSORS AND THEIR REPRESENTATIVES HARMLESS FROM AND AGAINST ANY AND ALL CLAIMS, DAMAGES, LOSSES, EXPENSES, COSTS AND LIABILITIES (COLLECTIVELY, "CLAIMS") ARISING OUT OF OR IN CONNECTION WITH ANY HANDLING OR USE OF THE EVM THAT IS NOT IN ACCORDANCE WITH THESE TERMS. THIS OBLIGATION SHALL APPLY WHETHER CLAIMS ARISE UNDER STATUTE, REGULATION, OR THE LAW OF TORT, CONTRACT OR ANY OTHER LEGAL THEORY, AND EVEN IF THE EVM FAILS TO PERFORM AS DESCRIBED OR EXPECTED.
-

8. *Limitations on Damages and Liability:*

8.1 *General Limitations.* IN NO EVENT SHALL TI BE LIABLE FOR ANY SPECIAL, COLLATERAL, INDIRECT, PUNITIVE, INCIDENTAL, CONSEQUENTIAL, OR EXEMPLARY DAMAGES IN CONNECTION WITH OR ARISING OUT OF THESE TERMS OR THE USE OF THE EVMS , REGARDLESS OF WHETHER TI HAS BEEN ADVISED OF THE POSSIBILITY OF SUCH DAMAGES. EXCLUDED DAMAGES INCLUDE, BUT ARE NOT LIMITED TO, COST OF REMOVAL OR REINSTALLATION, ANCILLARY COSTS TO THE PROCUREMENT OF SUBSTITUTE GOODS OR SERVICES, RETESTING, OUTSIDE COMPUTER TIME, LABOR COSTS, LOSS OF GOODWILL, LOSS OF PROFITS, LOSS OF SAVINGS, LOSS OF USE, LOSS OF DATA, OR BUSINESS INTERRUPTION. NO CLAIM, SUIT OR ACTION SHALL BE BROUGHT AGAINST TI MORE THAN TWELVE (12) MONTHS AFTER THE EVENT THAT GAVE RISE TO THE CAUSE OF ACTION HAS OCCURRED.

8.2 *Specific Limitations.* IN NO EVENT SHALL TI'S AGGREGATE LIABILITY FROM ANY USE OF AN EVM PROVIDED HEREUNDER, INCLUDING FROM ANY WARRANTY, INDEMNITY OR OTHER OBLIGATION ARISING OUT OF OR IN CONNECTION WITH THESE TERMS, , EXCEED THE TOTAL AMOUNT PAID TO TI BY USER FOR THE PARTICULAR EVM(S) AT ISSUE DURING THE PRIOR TWELVE (12) MONTHS WITH RESPECT TO WHICH LOSSES OR DAMAGES ARE CLAIMED. THE EXISTENCE OF MORE THAN ONE CLAIM SHALL NOT ENLARGE OR EXTEND THIS LIMIT.

9. *Return Policy.* Except as otherwise provided, TI does not offer any refunds, returns, or exchanges. Furthermore, no return of EVM(s) will be accepted if the package has been opened and no return of the EVM(s) will be accepted if they are damaged or otherwise not in a resalable condition. If User feels it has been incorrectly charged for the EVM(s) it ordered or that delivery violates the applicable order, User should contact TI. All refunds will be made in full within thirty (30) working days from the return of the components(s), excluding any postage or packaging costs.

10. *Governing Law:* These terms and conditions shall be governed by and interpreted in accordance with the laws of the State of Texas, without reference to conflict-of-laws principles. User agrees that non-exclusive jurisdiction for any dispute arising out of or relating to these terms and conditions lies within courts located in the State of Texas and consents to venue in Dallas County, Texas. Notwithstanding the foregoing, any judgment may be enforced in any United States or foreign court, and TI may seek injunctive relief in any United States or foreign court.

Mailing Address: Texas Instruments, Post Office Box 655303, Dallas, Texas 75265
Copyright © 2023, Texas Instruments Incorporated

IMPORTANT NOTICE AND DISCLAIMER

TI PROVIDES TECHNICAL AND RELIABILITY DATA (INCLUDING DATA SHEETS), DESIGN RESOURCES (INCLUDING REFERENCE DESIGNS), APPLICATION OR OTHER DESIGN ADVICE, WEB TOOLS, SAFETY INFORMATION, AND OTHER RESOURCES "AS IS" AND WITH ALL FAULTS, AND DISCLAIMS ALL WARRANTIES, EXPRESS AND IMPLIED, INCLUDING WITHOUT LIMITATION ANY IMPLIED WARRANTIES OF MERCHANTABILITY, FITNESS FOR A PARTICULAR PURPOSE OR NON-INFRINGEMENT OF THIRD PARTY INTELLECTUAL PROPERTY RIGHTS.

These resources are intended for skilled developers designing with TI products. You are solely responsible for (1) selecting the appropriate TI products for your application, (2) designing, validating and testing your application, and (3) ensuring your application meets applicable standards, and any other safety, security, regulatory or other requirements.

These resources are subject to change without notice. TI grants you permission to use these resources only for development of an application that uses the TI products described in the resource. Other reproduction and display of these resources is prohibited. No license is granted to any other TI intellectual property right or to any third party intellectual property right. TI disclaims responsibility for, and you will fully indemnify TI and its representatives against, any claims, damages, costs, losses, and liabilities arising out of your use of these resources.

TI's products are provided subject to [TI's Terms of Sale](#) or other applicable terms available either on [ti.com](https://www.ti.com) or provided in conjunction with such TI products. TI's provision of these resources does not expand or otherwise alter TI's applicable warranties or warranty disclaimers for TI products.

TI objects to and rejects any additional or different terms you may have proposed.

Mailing Address: Texas Instruments, Post Office Box 655303, Dallas, Texas 75265
Copyright © 2024, Texas Instruments Incorporated