

INA901-SP Total Ionizing Dose (TID) Report



ABSTRACT

This report discusses the results of the Total Ionizing Dose (TID) testing for the QML Class V certified Texas Instruments INA901-SP.

The study was done to determine TID effects under the low dose rate (LDR) up to 50 krad(Si). The results show that all samples were fully functional after being exposed up to 50 krad(Si).

Table of Contents

1 Device Information	2
1.1 Product Description.....	2
1.2 Device Details.....	2
2 Total Dose Test Setup	2
2.1 Test Overview.....	2
2.2 Test Description and Facilities.....	2
2.3 Test Setup Details.....	2
2.4 Test Configuration and Conditions.....	3
3 TID Characterization Results	4
3.1 Device Spec Table.....	4
4 Applicable and Reference Documents	5
4.1 Applicable Documents.....	5
4.2 Reference Documents.....	5
A Total Ionizing Dose LDR Report	6

Trademarks

All other trademarks are the property of their respective owners.

1 Device Information

1.1 Product Description

The INA901-SP is a voltage-output, current-sense amplifier that can sense drops across shunt resistors at common-mode voltages from -15 V to 65 V , independent of the supply voltage. INA901-SP pinouts readily enable filtering.

The INA901-SP is available with a gain of 20 V/V . The 130-kHz bandwidth simplifies use in current control loops.

The INA901-SP operate from a single 2.7-V to 16-V supply, drawing $700\text{ }\mu\text{A}$ (typical) of supply current. The devices are specified over the extended operating temperature range of $-55\text{ }^{\circ}\text{C}$ to $125\text{ }^{\circ}\text{C}$ and are offered in an 8-pin CFP package.

1.2 Device Details

Table 1-1 lists the device information used in the initial TID LDR characterization.

Table 1-1. Device and Exposure Details

TID LDR Details: up to 50 krad(Si)	
TI Device Number	INA901-SP
Package	CFP
Technology	LBC-SOI
Quantity Tested	22
Lot Accept/Reject	Devices functional up to 50 krad(Si)
LDR Radiation Facility	VPT Rad
LDR Dose Level	50 krad(Si)
LDR Dose Rate	0.01 rad(Si)/s
LDR Radiation Source	^{60}Co gamma cell

2 Total Dose Test Setup

2.1 Test Overview

The INA901-SP was tested according to MIL-STD-883, Test Method 1019.9. For this testing, Condition D was used. For this test, the product was irradiated up to the target radiation level and then put through full electrical parametric testing on the production Automated Test Equipment (ATE). The device was functional and passed all parametric tests.

2.2 Test Description and Facilities

The INA901-SP LDR exposure was performed on biased and unbiased devices in a ^{60}Co gamma cell under a 10-mrad(Si)/s exposure rate. The dose rate of the irradiator used in the exposure ranges from $< 10\text{ mrad(Si)/s}$ to a maximum of approximately 65 rad(Si)/s is determined by the distance from the source. For the LDR (10 mrad(Si)/s) exposure, the test box was positioned approximately 2 m from the source. The exposure boards are housed in a lead-aluminum box (as specified in MIL-STD-883 TM 1019.9) to harden the gamma spectrum and minimize dose enhancement effects. The irradiator calibration is maintained by Logmire Laboratories using Thermoluminescence Dosimeters (TLDs) traceable to the National Institute of Standards and Technology (NIST) and the dosimetry was verified using TLDs prior to the radiation exposures. After exposure, the devices were returned to TI Dallas for a full post radiation electrical evaluation using Texas Instruments production Automated Test Equipment (ATE). ATE guard band test limits are set within SMD electrical limits to ensure a minimum Cpk and test error margin based on initial qualification and characterization data.

2.3 Test Setup Details

The devices under LDR exposure were tested in a biased condition as described in the following section.

2.3.1 Biased

Figure 2-1 depicts the bias diagram used in biased LDR testing.

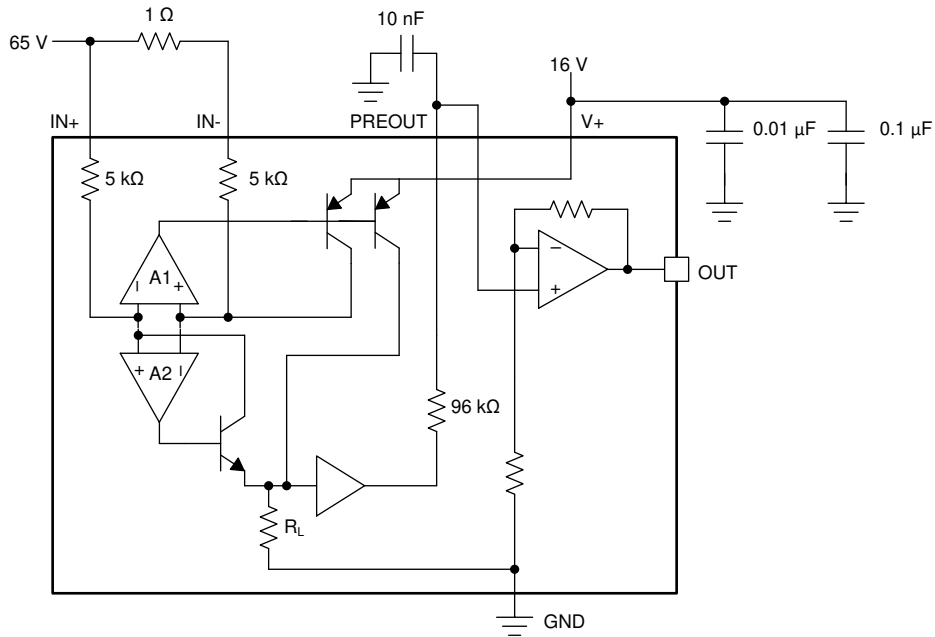

Figure 2-1. Bias Diagram

2.4 Test Configuration and Conditions

LDR devices were stressed at 50 krad(Si).

LDR Biased Device Information	
50 krad(Si)	
1, 2, 3, 4, 5, 6, 7, 8, 9, 10, 11, 12, 13, 14, 15, 16, 17, 18, 19, 20, 21, 22	

3 TID Characterization Results

Devices were functional after being exposed to 50 krad(Si). Full results are listed in [Appendix A](#).

3.1 Device Spec Table

[Table 3-1](#) lists the device data sheet along with the corresponding ATE test that accompanies it.

Table 3-1. INA901-SP Spec Table

PARAMETER	TEST CONDITION	MIN	TYP	MAX	UNIT	TEST NUMBER
INPUT						
Common-mode rejection ratio	VIN+ = -16 V to 65 V	80	120		dB	5.1
Offset voltage			±0.5	±2.5	mV	3.1
Vos vs Power-Supply			5	250	µV/V	4.0
Input bias current, Vin-pin			±8	±16	µA	7.0
OUTPUT						
Total gain error	VSENSE = 20 mV to 100 mV		±0.2%	±1.5%		3.0
Total output error			±0.75%	±3%		3.2
VOLTAGE OUTPUT						
Swing to V+ Power-Supply Rail			(V+)-0.05	(V+)-0.2	V	6.1
Swing to GND			VGND +0.003	VGND +0.05	V	6.0
POWER SUPPLY						
Quiescent Current	VOUT = 2 V		700	900	µA	2.4

4 Applicable and Reference Documents

4.1 Applicable Documents

For applicable documentation, see the following:

- Texas Instruments, [INA901-SP radiation hardened, –15-V to 65-V common mode, unidirectional current-shunt monitor data sheet](#)
- Texas Instruments, [Single-event effects test report for INA901-SP current sense amplifier radiation report](#)

4.2 Reference Documents

Texas Instruments total ionizing dose radiation (total dose) test procedure follows the standards put forth in MIL-STD-883 TM 1019. The document can be found at the DLA website.

A Total Ionizing Dose LDR Report

This appendix provides the INA901-SP TID LDR report.

TID Report-LDR
INA901

TID Report-LDR INA901

2.1_IQM				
Test Site				
Tester				
Test Number				
Unit	uA	uA		
Max Limit	450	450		
Min Limit	32	32		
Krad	Serial #	PRE TID_full	POST TID_full	Delta
0	_corr	202.947	202.947	0.000
50	1_50	183.454	308.101	-124.647
50	2_50	182.789	200.029	-17.240
50	3_60	189.660	261.479	-71.819
50	4_50	226.795	309.100	-82.305
50	5_50	188.645	183.557	5.088
50	6_50	213.024	340.300	-127.276
50	7_50	224.752	171.538	53.214
50	8_50	211.243	269.612	-58.369
50	9_50	191.263	209.799	-18.536
50	10_50	253.338	271.942	-18.604
50	11_50	232.092	276.315	-44.223
50	12_50	277.395	313.139	-35.744
50	13_50	191.200	302.320	-111.120
50	14_50	199.833	263.534	-63.701
50	15_50	218.168	257.296	-39.128
50	16_50	170.092	241.979	-71.887
50	17_50	179.681	221.812	-42.131
50	18_50	169.701	173.122	-3.421
50	19_50	188.595	291.691	-103.096
50	20_50	181.002	267.435	-86.433
50	21_50	192.512	315.344	-122.832
50	22_50	166.006	243.032	-77.026
100	23_100	275.186	283.954	-8.768
100	24_100	265.413	354.550	-89.137
100	25_100	171.051	341.421	-170.370
100	26_100	166.596	1263.677	-1097.081
	Max	277.395	1263.677	53.214
	Average	204.164	301.445	-97.281
	Min	166.006	171.538	-1097.081
	Std Dev	32.896	199.058	205.995

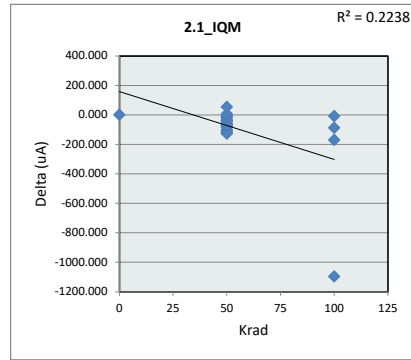

2.1_IQM		
Test Site		
Tester		
Test Number		
Max Limit	450	uA
Min Limit	32	uA
Krad	0	50
LL	32.000	32.000
Min	202.947	171.538
Average	202.947	258.749
Max	202.947	340.300
UL	450.000	450.000

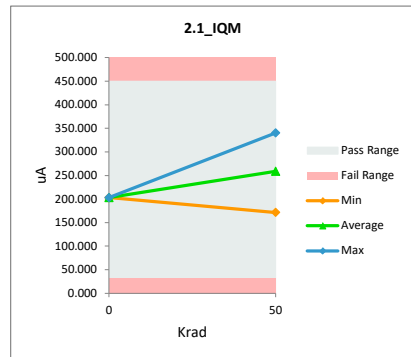

TID Report-LDR INA901

3.0_GE				
Test Site				
Tester				
Test Number				
Unit	%	%		
Max Limit	1.45	1.45		
Min Limit	-1.45	-1.45		
Krad	Serial #	PRE TID_full	POST TID_full	Delta
0	corr	-0.234	-0.234	0.000
50	1_50	-0.077	-0.335	0.258
50	2_50	-0.088	-0.315	0.227
50	3_60	-0.409	-0.316	-0.094
50	4_50	0.361	0.092	0.269
50	5_50	0.055	-0.870	0.925
50	6_50	0.179	-0.581	0.760
50	7_50	-0.276	-0.743	0.467
50	8_50	0.255	-1.307	1.562
50	9_50	0.225	-0.398	0.623
50	10_50	-0.099	-0.784	0.685
50	11_50	-0.194	-0.666	0.472
50	12_50	-0.419	-0.080	-0.338
50	13_50	0.110	-0.110	0.219
50	14_50	-0.744	-0.453	-0.291
50	15_50	-0.332	-0.712	0.381
50	16_50	-0.535	0.008	-0.542
50	17_50	0.039	-0.572	0.611
50	18_50	-0.144	-0.623	0.479
50	19_50	-0.103	-1.154	1.051
50	20_50	-0.328	-0.632	0.304
50	21_50	-0.553	-0.429	-0.124
50	22_50	-0.106	-0.878	0.772
Max		0.361	0.092	1.562
Average		-0.149	-0.526	0.377
Min		-0.744	-1.307	-0.542
Std Dev		0.280	0.352	0.486

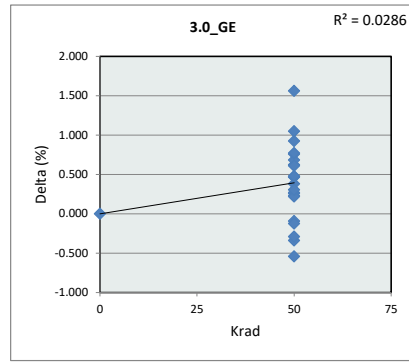

3.0_GE		
Test Site		
Tester		
Test Number		
Max Limit	1.45	%
Min Limit	-1.45	%
Krad	0	50
LL	-1.450	-1.450
Min	-0.234	-1.307
Average	-0.234	-0.539
Max	-0.234	0.092
UL	1.450	1.450

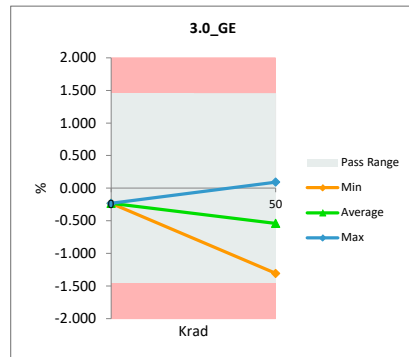

TID Report-LDR
INA901

3.1_VOS				
Test Site				
Tester				
Test Number				
Unit		mV	mV	
Max Limit		3.449	3.449	
Min Limit		-3.449	-3.449	
Krad	Serial #	PRE TID_full	POST TID_full	Delta
0	_corr	0.575	0.575	0.000
50	1_50	-0.098	1.109	-1.208
50	2_50	-0.155	0.125	-0.280
50	3_60	0.568	0.364	0.204
50	4_50	0.260	1.074	-0.815
50	5_50	-0.506	-0.252	-0.255
50	6_50	0.879	1.109	-0.229
50	7_50	-0.481	-0.429	-0.052
50	8_50	-0.120	0.647	-0.768
50	9_50	0.568	-0.282	0.850
50	10_50	1.045	0.503	0.542
50	11_50	0.746	0.272	0.474
50	12_50	0.545	0.885	-0.341
50	13_50	0.430	0.987	-0.557
50	14_50	0.525	0.704	-0.178
50	15_50	0.800	0.484	0.316
50	16_50	0.398	-0.046	0.445
50	17_50	-0.208	0.161	-0.370
50	18_50	-1.137	-0.332	-0.805
50	19_50	0.460	0.997	-0.537
50	20_50	0.310	0.386	-0.076
50	21_50	0.384	0.875	-0.491
50	22_50	-0.349	0.628	-0.977
	Max	1.045	1.109	0.850
	Average	0.236	0.458	-0.222
	Min	-1.137	-0.429	-1.208
	Std Dev	0.530	0.489	0.526

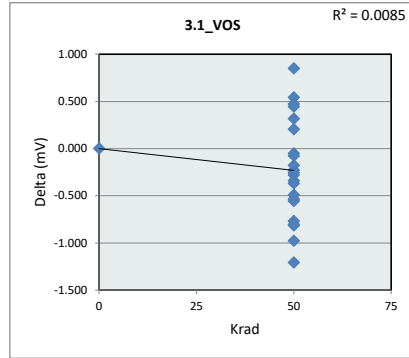

3.1_VOS		
Test Site		
Tester		
Test Number		
Max Limit	3.449	mV
Min Limit	-3.449	mV
Krad	0	50
LL	-3.449	-3.449
Min	0.575	-0.429
Average	0.575	0.453
Max	0.575	1.109
UL	3.449	3.449

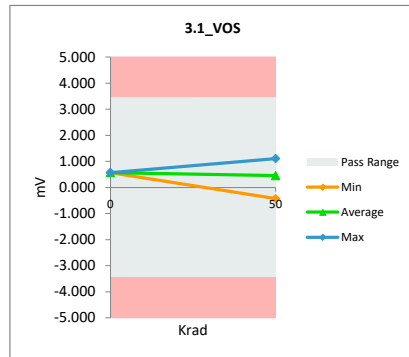

TID Report-LDR
INA901

3.2_TOE				
Test Site				
Tester				
Test Number				
Unit	%	%		
Max Limit	2.95	2.95		
Min Limit	-2.95	-2.95		
Krad	Serial #	PRE TID_full	POST TID_full	Delta
0	_corr	0.285	0.285	0.000
50	1_50	-0.166	0.663	-0.829
50	2_50	-0.228	-0.202	-0.026
50	3_60	0.105	0.012	0.092
50	4_50	0.598	1.062	-0.464
50	5_50	-0.403	-1.087	0.684
50	6_50	0.977	0.417	0.560
50	7_50	-0.709	-1.121	0.412
50	8_50	0.147	-0.714	0.861
50	9_50	0.741	-0.650	1.390
50	10_50	0.845	-0.328	1.173
50	11_50	0.480	-0.417	0.897
50	12_50	0.073	0.718	-0.645
50	13_50	0.499	0.780	-0.281
50	14_50	-0.268	0.181	-0.448
50	15_50	0.391	-0.274	0.665
50	16_50	-0.173	-0.034	-0.139
50	17_50	-0.150	-0.424	0.275
50	18_50	-1.171	-0.917	-0.253
50	19_50	0.312	-0.251	0.563
50	20_50	-0.048	-0.283	0.235
50	21_50	-0.205	0.357	-0.563
50	22_50	-0.421	-0.309	-0.112
	Max	0.977	1.062	1.390
	Average	0.066	-0.110	0.176
	Min	-1.171	-1.121	-0.829
	Std Dev	0.513	0.598	0.603

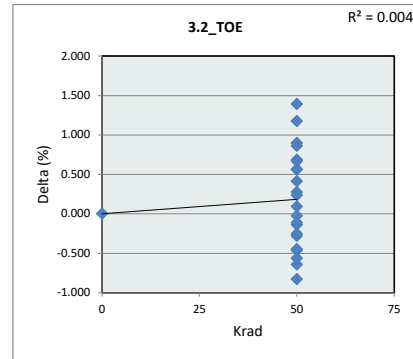

3.2_TOE		
Test Site		
Tester		
Test Number		
Max Limit	2.95	%
Min Limit	-2.95	%
Krad	0	50
LL	-2.950	-2.950
Min	0.285	-1.121
Average	0.285	-0.128
Max	0.285	1.062
UL	2.950	2.950

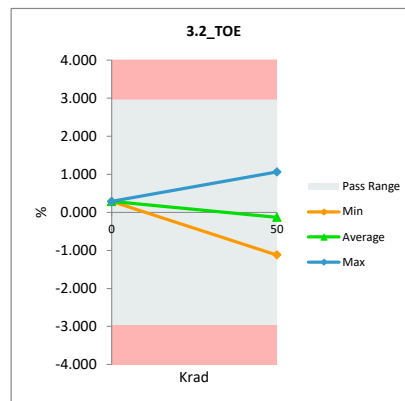

TID Report-LDR INA901

4.0_Psr				
Test Site				
Tester				
Test Number				
Unit	uV/V	uV/V		
Max Limit	250	250		
Min Limit	-250	-250		
Krad	Serial #	PRE TID_full	POST TID_full	Delta
0	corr	3.085	3.085	0.000
50	1_50	1.981	14.725	-12.744
50	2_50	1.395	23.040	-21.645
50	3_60	3.990	17.344	-13.354
50	4_50	3.267	30.212	-26.945
50	5_50	2.630	22.962	-20.332
50	6_50	4.267	16.820	-12.553
50	7_50	2.378	22.021	-19.643
50	8_50	3.243	23.606	-20.363
50	9_50	5.171	22.428	-17.257
50	10_50	4.815	22.314	-17.499
50	11_50	5.231	11.103	-5.872
50	12_50	4.820	16.495	-11.675
50	13_50	3.710	29.654	-25.944
50	14_50	6.163	23.230	-17.067
50	15_50	4.969	23.124	-18.155
50	16_50	4.120	19.523	-15.403
50	17_50	3.856	26.821	-22.965
50	18_50	0.874	26.802	-25.928
50	19_50	3.917	31.840	-27.923
50	20_50	4.811	22.435	-17.624
50	21_50	3.648	23.216	-19.568
50	22_50	5.439	41.242	-35.803
	Max	6.163	41.242	0.000
	Average	3.817	22.350	-18.533
	Min	0.874	3.085	-35.803
	Std Dev	1.335	7.569	7.590

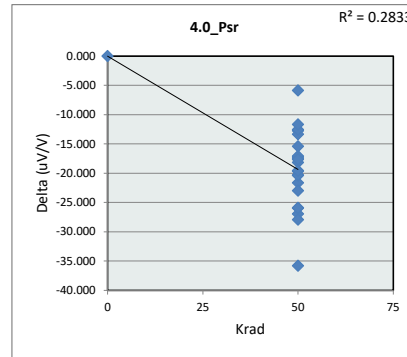

4.0_Psr		
Test Site		
Tester		
Test Number		
Max Limit	250	uV/V
Min Limit	-250	uV/V
Krad	0	50
LL	-250.000	-250.000
Min	3.085	11.103
Average	3.085	23.225
Max	3.085	41.242
UL	250.000	250.000

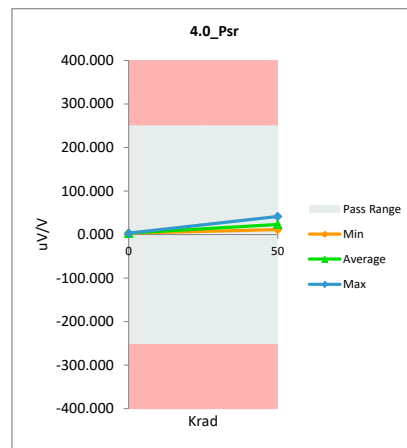

TID Report-LDR INA901

5.0_CmrH		
Test Site		
Tester		
Test Number		
Unit	dB	dB
Max Limit	180	180
Min Limit	80	80

Krad	Serial #	PRE TID_full	POST TID_full	Delta
0	_corr	134.566	134.566	0.000
50	1_50	121.958	108.881	13.077
50	2_50	122.718	109.954	12.764
50	3_60	129.281	99.594	29.687
50	4_50	126.265	114.677	11.588
50	5_50	121.490	101.359	20.131
50	6_50	138.428	112.784	25.644
50	7_50	122.332	105.268	17.064
50	8_50	126.629	103.731	22.898
50	9_50	132.147	107.843	24.304
50	10_50	131.887	104.325	27.562
50	11_50	137.749	115.499	22.250
50	12_50	129.580	104.688	24.892
50	13_50	126.224	107.095	19.129
50	14_50	145.055	99.185	45.870
50	15_50	135.484	105.621	29.863
50	16_50	134.394	118.641	15.753
50	17_50	128.226	103.024	25.202
50	18_50	121.759	104.821	16.938
50	19_50	133.463	101.876	31.587
50	20_50	137.262	113.577	23.685
50	21_50	129.552	99.588	29.964
50	22_50	134.387	117.858	16.529
	Max	145.055	134.566	45.870
	Average	130.471	108.455	22.017
	Min	121.490	99.185	0.000
	Std Dev	6.308	8.155	9.060

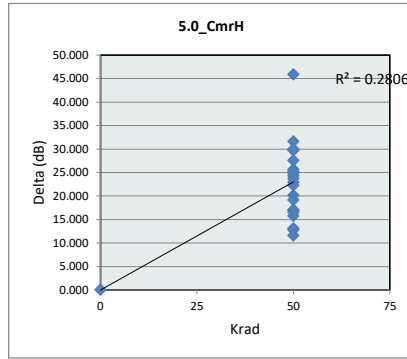

5.0_CmrH		
Test Site		
Tester		
Test Number		
Max Limit	180	dB
Min Limit	80	dB
Krad	0	50
LL	80.000	80.000
Min	134.566	99.185
Average	134.566	107.268
Max	134.566	118.641
UL	180.000	180.000

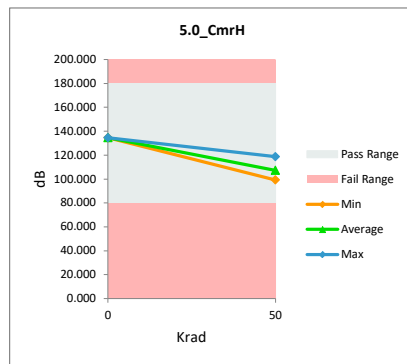

TID Report-LDR
INA901

5.1_CmrF				
Test Site				
Tester				
Test Number				
Unit	dB	dB		
Max Limit	180	180		
Min Limit	80	80		
Krad	Serial #	PRE TID_full	POST TID_full	Delta
0	_corr	109.803	109.803	0.000
50	1_50	98.129	106.049	-7.920
50	2_50	100.358	111.244	-10.886
50	3_60	108.527	100.471	8.056
50	4_50	99.781	121.355	-21.574
50	5_50	120.448	101.539	18.909
50	6_50	105.952	112.091	-6.139
50	7_50	105.881	115.717	-9.836
50	8_50	106.559	101.338	5.221
50	9_50	101.360	99.923	1.437
50	10_50	113.972	104.084	9.888
50	11_50	112.761	114.334	-1.573
50	12_50	113.161	105.668	7.493
50	13_50	108.732	106.455	2.277
50	14_50	106.124	98.147	7.977
50	15_50	106.513	104.049	2.464
50	16_50	115.717	112.237	3.480
50	17_50	107.051	101.191	5.860
50	18_50	141.686	102.344	39.342
50	19_50	113.434	103.351	10.083
50	20_50	101.731	103.767	-2.036
50	21_50	107.020	104.069	2.951
50	22_50	116.570	109.873	6.697
Max		141.686	121.355	39.342
Average		109.620	106.483	3.138
Min		98.129	98.147	-21.574
Std Dev		9.060	5.870	11.661

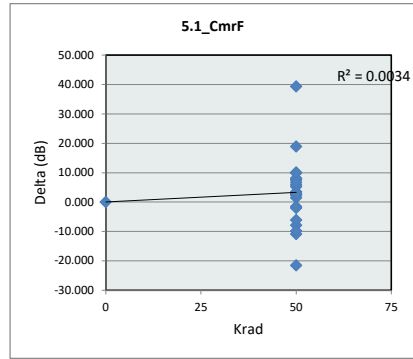

5.1_CmrF		
Test Site		
Tester		
Test Number		
Max Limit	180	dB
Min Limit	80	dB
Krad	0	50
LL	80.000	80.000
Min	109.803	98.147
Average	109.803	106.332
Max	109.803	121.355
UL	180.000	180.000

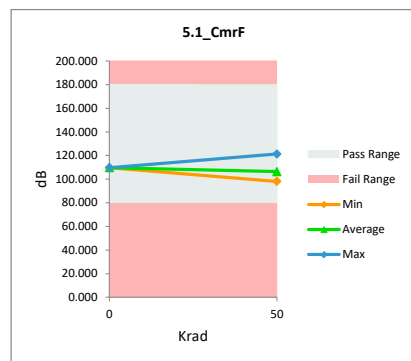

TID Report-LDR
INA901

6.2_SwGnd				
Krad	Serial #	PRE TID_full	POST TID_full	Delta
0	_corr	0.004	0.004	0.000
50	1_50	0.003	0.015	-0.012
50	2_50	0.003	0.007	-0.004
50	3_60	0.004	0.007	-0.003
50	4_50	0.002	0.010	-0.008
50	5_50	0.005	0.005	0.000
50	6_50	0.003	0.005	-0.002
50	7_50	0.001	0.004	-0.003
50	8_50	0.002	0.003	-0.001
50	9_50	0.001	0.007	-0.006
50	10_50	0.003	0.009	-0.006
50	11_50	0.003	0.007	-0.004
50	12_50	0.004	0.010	-0.006
50	13_50	0.003	0.008	-0.005
50	14_50	0.003	0.009	-0.006
50	15_50	0.005	0.010	-0.005
50	16_50	0.001	0.007	-0.006
50	17_50	0.003	0.008	-0.005
50	18_50	0.004	0.008	-0.004
50	19_50	0.004	0.011	-0.007
50	20_50	0.002	0.009	-0.007
50	21_50	0.003	0.007	-0.004
50	22_50	0.002	0.005	-0.003
	Max	0.005	0.015	0.000
	Average	0.003	0.008	-0.005
	Min	0.001	0.003	-0.012
	Std Dev	0.001	0.003	0.003

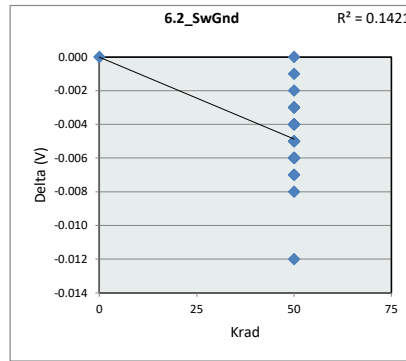

6.2_SwGnd		
Test Site		
Tester		
Test Number		
Max Limit	0.05	V
Min Limit	0	V
Krad	0	50
LL	0.000	0.000
Min	0.004	0.003
Average	0.004	0.008
Max	0.004	0.015
UL	0.050	0.050

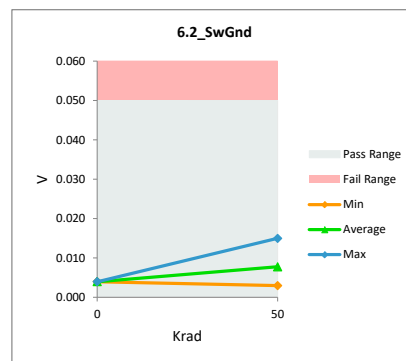

TID Report-LDR
INA901

6.3_SwVcc				
Test Site				
Tester				
Test Number				
Unit	V	V		
Max Limit	2.696	2.696		
Min Limit	2.504	2.504		
Krad	Serial #	PRE TID_full	POST TID_full	Delta
0	_corr	2.643	2.643	0.000
50	1_50	2.640	2.604	0.036
50	2_50	2.641	2.596	0.045
50	3_60	2.652	2.577	0.075
50	4_50	2.648	2.607	0.041
50	5_50	2.647	2.583	0.064
50	6_50	2.653	2.619	0.034
50	7_50	2.643	2.589	0.054
50	8_50	2.646	2.599	0.047
50	9_50	2.654	2.595	0.059
50	10_50	2.645	2.609	0.036
50	11_50	2.641	2.621	0.020
50	12_50	2.640	2.602	0.038
50	13_50	2.640	2.606	0.034
50	14_50	2.642	2.588	0.054
50	15_50	2.647	2.608	0.039
50	16_50	2.647	2.615	0.032
50	17_50	2.642	2.587	0.055
50	18_50	2.649	2.594	0.055
50	19_50	2.640	2.613	0.027
50	20_50	2.641	2.620	0.021
50	21_50	2.640	2.600	0.040
50	22_50	2.640	2.584	0.056
100	23_100	2.645	2.552	0.093
100	24_100	2.642	2.548	0.094
100	25_100	2.650	2.534	0.116
100	26_100	2.642	2.548	0.094
	Max	2.654	2.643	0.116
	Average	2.644	2.594	0.050
	Min	2.640	2.534	0.000
	Std Dev	0.004	0.025	0.026

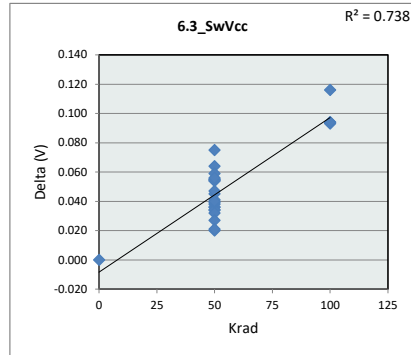

6.3_SwVcc		
Test Site		
Tester		
Test Number		
Max Limit	2.696	V
Min Limit	2.504	V
Krad	0	50
LL	2.504	2.504
Min	2.643	2.577
Average	2.643	2.601
Max	2.643	2.621
UL	2.696	2.696



TID Report-LDR
INA901

7.0_Ib				
Test Site				
Tester				
Test Number				
Unit	uA	uA		
Max Limit	16	16		
Min Limit	0	0		
Krad	Serial #	PRE TID_full	POST TID_full	Delta
0	_corr	7.724	7.724	0.000
50	1_50	8.424	7.087	1.337
50	2_50	8.427	7.645	0.782
50	3_60	6.726	8.241	-1.515
50	4_50	7.803	7.291	0.512
50	5_50	7.566	8.166	-0.600
50	6_50	6.633	7.947	-1.314
50	7_50	7.918	7.992	-0.074
50	8_50	7.933	7.668	0.265
50	9_50	6.950	8.046	-1.096
50	10_50	7.310	8.179	-0.869
50	11_50	7.924	8.500	-0.576
50	12_50	8.672	7.629	1.043
50	13_50	8.031	7.194	0.837
50	14_50	7.856	8.000	-0.144
50	15_50	7.359	6.886	0.473
50	16_50	6.918	7.509	-0.591
50	17_50	7.695	8.029	-0.334
50	18_50	7.397	7.033	0.364
50	19_50	8.355	6.788	1.567
50	20_50	8.040	8.714	-0.674
50	21_50	8.135	8.482	-0.347
50	22_50	8.053	7.393	0.660
100	23_100	7.277	6.871	0.406
100	24_100	7.869	7.006	0.863
100	25_100	6.622	7.464	-0.842
100	26_100	8.146	9.811	-1.665
	Max	8.672	9.811	1.567
	Average	7.695	7.752	-0.057
	Min	6.622	6.788	-1.665
	Std Dev	0.567	0.679	0.873

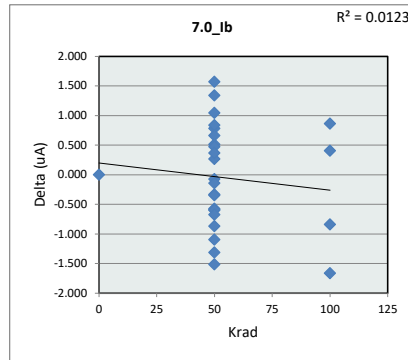

7.0_Ib		
Test Site		
Tester		
Test Number		
Max Limit	16	uA
Min Limit	0	uA
Krad	0	50
LL	0.000	0.000
Min	7.724	6.788
Average	7.724	7.746
Max	7.724	8.714
UL	16.000	16.000

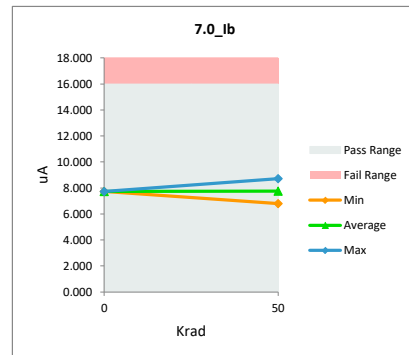

IMPORTANT NOTICE AND DISCLAIMER

TI PROVIDES TECHNICAL AND RELIABILITY DATA (INCLUDING DATA SHEETS), DESIGN RESOURCES (INCLUDING REFERENCE DESIGNS), APPLICATION OR OTHER DESIGN ADVICE, WEB TOOLS, SAFETY INFORMATION, AND OTHER RESOURCES "AS IS" AND WITH ALL FAULTS, AND DISCLAIMS ALL WARRANTIES, EXPRESS AND IMPLIED, INCLUDING WITHOUT LIMITATION ANY IMPLIED WARRANTIES OF MERCHANTABILITY, FITNESS FOR A PARTICULAR PURPOSE OR NON-INFRINGEMENT OF THIRD PARTY INTELLECTUAL PROPERTY RIGHTS.

These resources are intended for skilled developers designing with TI products. You are solely responsible for (1) selecting the appropriate TI products for your application, (2) designing, validating and testing your application, and (3) ensuring your application meets applicable standards, and any other safety, security, regulatory or other requirements.

These resources are subject to change without notice. TI grants you permission to use these resources only for development of an application that uses the TI products described in the resource. Other reproduction and display of these resources is prohibited. No license is granted to any other TI intellectual property right or to any third party intellectual property right. TI disclaims responsibility for, and you will fully indemnify TI and its representatives against, any claims, damages, costs, losses, and liabilities arising out of your use of these resources.

TI's products are provided subject to [TI's Terms of Sale](#) or other applicable terms available either on [ti.com](#) or provided in conjunction with such TI products. TI's provision of these resources does not expand or otherwise alter TI's applicable warranties or warranty disclaimers for TI products.

TI objects to and rejects any additional or different terms you may have proposed.

Mailing Address: Texas Instruments, Post Office Box 655303, Dallas, Texas 75265
Copyright © 2022, Texas Instruments Incorporated