

## TPS7A10 300-mA, Low $V_{IN}$ , Low $V_{OUT}$ , Ultra-Low Dropout Regulator

### 1 Features

- Ultra-Low Input Voltage Range: 0.75 V to 3.3 V
- Ultra-Low Dropout for Minimum Power Loss:
  - 70 mV (Maximum) at 300 mA ( $V_{OUT} > 1.0$  V), YKA Package
- Low Quiescent Current:
  - $V_{IN} I_Q = 1.6$   $\mu$ A (Typical)
  - $V_{BIAS} I_Q = 6$   $\mu$ A (Typical)
- 1.5% Accuracy over Load, Line, and Temperature
- High PSRR: 60 dB at 1 kHz
- Available in Fixed-Output Voltages:
  - 0.5 V to 3.0 V (in 50-mV Steps)
- $V_{BIAS}$  Range: 1.7 V to 5.5 V
- Packages:
  - 0.74-mm  $\times$  1.09-mm WCSP-5
  - 1.50-mm  $\times$  1.50-mm WSON-6
- Built-In Soft Start With Monotonic  $V_{OUT}$  Rise
- Active Output Discharge

### 2 Applications

- Smart Watch, Fitness Trackers
- Wireless Headphones and Earbuds
- Camera Modules
- Smart Phones and Tablets
- Portable Medical Devices

### 3 Description

The TPS7A10 is an ultra-small, low quiescent current, low-dropout regulator (LDO) that can source 300 mA with an outstanding ac performance (load and line transient responses). This device has an input range of 0.75 V to 3.3 V, and output range of 0.5 V to 3.0 V with a very high accuracy of 1.5% over load, line and temperature. This performance is ideal for powering the lower core voltages of the modern MCUs and analog sensors.

The main power path is through  $V_{IN}$  and can be connected to a power supply as low as 70 mV above the output voltage. This device supports very low input voltages with the use of an additional  $V_{BIAS}$  rail that is used to power the internal circuitry of the LDO. Both  $V_{IN}$  and  $V_{BIAS}$  consume very low quiescent current of 1.6  $\mu$ A and 6  $\mu$ A, respectively. The low  $I_Q$  and ultra-low dropout features helps in increasing the efficiency of the solution in the power-sensitive applications. For example,  $V_{IN}$  can be an output of a high-efficiency, DC/DC step-down regulator, and the  $V_{BIAS}$  pin can be connected to a rechargeable battery.

The TPS7A10 is equipped with an active pull-down circuit to quickly discharge the output when disabled, and provides a known start-up state.

The TPS7A10 is available in an ultra-small, 5-pin DSBGA (YKA) package that makes the device suitable for space-constrained applications. The device is also available in a 6-pin WSON (DSE) package.

#### Device Information<sup>(1)</sup>

PART NUMBER	PACKAGE	BODY SIZE (NOM)
TPS7A10	WSON (6)	1.50 mm $\times$ 1.50 mm
	DSBGA (5)	0.74 mm $\times$ 1.09 mm (0.35-mm pitch)

(1) For all available packages, see the package option addendum at the end of the data sheet.

#### Dropout vs $I_{OUT}$ and Temperature, YKA Package

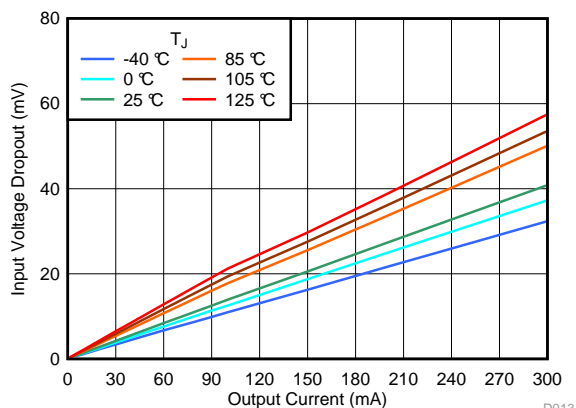

D013

#### Typical Application Circuit

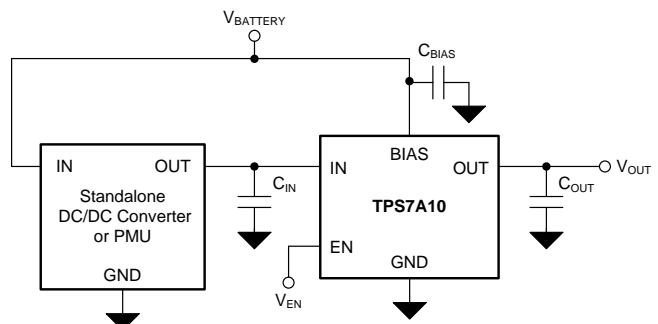

## Table of Contents

<b>1 Features</b> .....	<b>1</b>	<b>8 Application and Implementation</b> .....	<b>18</b>
<b>2 Applications</b> .....	<b>1</b>	8.1 Application Information.....	18
<b>3 Description</b> .....	<b>1</b>	8.2 Typical Application .....	22
<b>4 Revision History</b> .....	<b>2</b>	<b>9 Power Supply Recommendations</b> .....	<b>24</b>
<b>5 Pin Configuration and Functions</b> .....	<b>3</b>	<b>10 Layout</b> .....	<b>24</b>
<b>6 Specifications</b> .....	<b>4</b>	10.1 Layout Guidelines .....	24
6.1 Absolute Maximum Ratings .....	4	10.2 Layout Examples.....	24
6.2 ESD Ratings.....	4	<b>11 Device and Documentation Support</b> .....	<b>25</b>
6.3 Recommended Operating Conditions.....	4	11.1 Device Support .....	25
6.4 Thermal Information .....	4	11.2 Documentation Support .....	25
6.5 Electrical Characteristics.....	5	11.3 Receiving Notification of Documentation Updates	25
6.6 Typical Characteristics .....	7	11.4 Community Resources.....	25
<b>7 Detailed Description</b> .....	<b>14</b>	11.5 Trademarks .....	25
7.1 Overview .....	14	11.6 Electrostatic Discharge Caution.....	26
7.2 Functional Block Diagram .....	14	11.7 Glossary .....	26
7.3 Feature Description.....	15	<b>12 Mechanical, Packaging, and Orderable</b>	
7.4 Device Functional Modes.....	17	<b>Information</b> .....	<b>26</b>

## 4 Revision History

NOTE: Page numbers for previous revisions may differ from page numbers in the current version.

Changes from Revision A (June 2018) to Revision B	Page
• Added <i>YKA Package</i> to sub-bullet of <i>Ultra-Low Dropout for Minimum Power Loss</i> bullet in <i>Features</i> .....	1
• Added last sentence to <i>Description</i> section .....	1
• Changed WSON (DSE) package from Advanced Information to Production Data (active) .....	1
• Added <i>YKA Package</i> to title of <i>Dropout vs I<sub>OUT</sub> and Temperature, YKA Package</i> figure .....	1
• Added <i>YKA Package</i> to captions of <i>Output Accuracy Over Temperature, YKA Package</i> and <i>Output Accuracy Over Temperature, YKA Package</i> figures .....	7
• Added <i>Output Accuracy Over Temperature, DSE Package</i> and <i>Output Accuracy Over Temperature, DSE Package</i> figures .....	7
• Added <i>YKA Package</i> to caption of <i>Dropout vs I<sub>OUT</sub> and Temperature, YKA Package</i> figure.....	7
• Added <i>Dropout vs I<sub>OUT</sub> and Temperature, DSE Package</i> figure .....	8

Changes from Original (March 2018) to Revision A	Page
• Changed from Advanced Information to Production Data (active).....	1

## 5 Pin Configuration and Functions

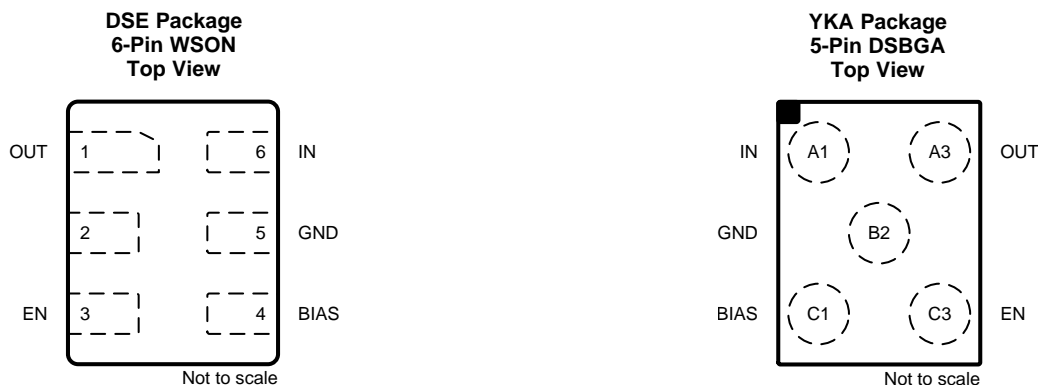

### Pin Functions

NAME	PIN		I/O	DESCRIPTION
	DSE	YKA		
IN	6	A1	I	Input pin. For best transient response and to minimize input impedance, use the recommended or larger value ceramic capacitor from IN to ground, as listed in the <a href="#">Recommended Operation Conditions</a> . Place the input capacitor as close as possible to input of the device.
OUT	1	A3	O	Regulated output pin. A capacitor is required from OUT to ground for stability. For best transient response, use larger than the minimum recommended value ceramic capacitor. Follow the recommended capacitor value as listed in the <a href="#">Recommended Operation Conditions</a> . Place the output capacitor as close as possible to output of the device.
GND	5	B2	—	Ground pin. This pin must be connected to ground.
BIAS	4	C1	I	BIAS pin. This pin enables the use of low-input voltage, low-output voltage conditions, (LILO). For best response, use the recommended or larger value ceramic capacitor from BIAS to ground as listed in the <a href="#">Recommended Operation Conditions</a> . Place the bias capacitor as close as possible to input of the device.
EN	3	C3	I	Enable pin. Driving this pin to logic high enables the device. Driving this pin to logic low disables the device. If enable functionality is not required, this pin must be connected to IN or BIAS; however, connecting EN to IN is only acceptable if the $V_{IN}$ voltage is greater than 0.9 V.

## 6 Specifications

### 6.1 Absolute Maximum Ratings

over operating free-air temperature range unless otherwise noted.<sup>(1)</sup>

		MIN	MAX	UNIT
Voltage	Supply, $V_{IN}$	-0.3	3.6	V
	Enable, $V_{EN}$	-0.3	6.0	
	Bias, $V_{BIAS}$	-0.3	6.0	
	Output, $V_{OUT}$	-0.3	$V_{IN} + 0.3$ <sup>(2)</sup>	
Current	Maximum output current	Internally limited		A
Temperature	Operating junction temperature, $T_J$	-40	150	°C
	Storage temperature, $T_{stg}$	-65	150	°C

- (1) Stresses beyond those listed under *Absolute Maximum Ratings* may cause permanent damage to the device. These are stress ratings only, which do not imply functional operation of the device at these or any other conditions beyond those indicated under *Recommended Operating Conditions*. Exposure to absolute-maximum-rated conditions for extended periods may affect device reliability.
- (2) The absolute maximum rating is 3.6 or ( $V_{IN} + 0.3$ ), whichever is less.

### 6.2 ESD Ratings

			VALUE	UNIT
$V_{(ESD)}$	Electrostatic discharge	Human-body model (HBM), per ANSI/ESDA/JEDEC JS-001 <sup>(1)</sup>	±1000	V
		Charged-device model (CDM), per JEDEC specification JESD22-C101 <sup>(2)</sup>	±500	

- (1) JEDEC document JEP155 states that 500-V HBM allows safe manufacturing with a standard ESD control process.
- (2) JEDEC document JEP157 states that 250-V CDM allows safe manufacturing with a standard ESD control process.

### 6.3 Recommended Operating Conditions

over operating junction temperature range (unless otherwise noted).

		MIN	NOM	MAX	UNIT
$V_{IN}$	Input voltage	0.75		3.3	V
$V_{BIAS}$	Bias voltage	1.7		5.5	V
$V_{OUT}$	Output voltage	0.5		3.0	V
$I_{OUT}$	Peak output current	0		300	mA
$C_{IN}$	Input capacitor	2.2			μF
$C_{BIAS}$	Bias capacitor		0.1		μF
$C_{OUT}$ <sup>(1)</sup>	Output capacitor	2.2		22	μF
$T_J$	Operating junction temperature	-40		125	°C

- (1) Maximum ESR must be lower than 250 mΩ

### 6.4 Thermal Information

THERMAL METRIC <sup>(1)</sup>		TPS7A10		UNIT
		DSE (WSON)	YKA (WSCP)	
		6 PINS	5 PINS	
$R_{\theta JA}$	Junction-to-ambient thermal resistance	188.8	169.4	°C/W
$R_{\theta JC(top)}$	Junction-to-case (top) thermal resistance	82.9	1.1	°C/W
$R_{\theta JB}$	Junction-to-board thermal resistance	101.0	55.4	°C/W
$\Psi_{JT}$	Junction-to-top characterization parameter	6.6	1.7	°C/W
$\Psi_{JB}$	Junction-to-board characterization parameter	100.4	55.6	°C/W
$R_{\theta JC(bot)}$	Junction-to-case (bottom) thermal resistance	N/A	N/A	°C/W

- (1) For more information about traditional and new thermal metrics, see [Semiconductor and IC Package Thermal Metrics](#).

## 6.5 Electrical Characteristics

over  $T_J = -40^{\circ}\text{C}$  to  $+125^{\circ}\text{C}$ ,  $V_{IN} = V_{OUT(NOM)} + 0.5\text{ V}$ ,  $V_{BIAS} = V_{OUT(NOM)} + 1.4\text{ V}$ ,  $I_{OUT} = 1\text{ mA}$ ,  $V_{EN} = 1.0\text{ V}$ ,  $C_{IN} = 2.2\text{ }\mu\text{F}$ ,  $C_{OUT} = 2.2\text{ }\mu\text{F}$ , and  $C_{BIAS} = 0.1\text{ }\mu\text{F}$  ( unless otherwise noted); all typical values are at  $T_J = 25^{\circ}\text{C}$  .

PARAMETER		TEST CONDITIONS	MIN	TYP	MAX	UNIT
	Nominal Accuracy	$T_J = 25^{\circ}\text{C}$	-0.5		0.5	
	Accuracy over temperature	$-20^{\circ}\text{C} \leq T_J \leq 85$ , DSE package $V_{OUT(NOM)} + 0.5\text{ V} \leq V_{IN} \leq 3.3\text{ V}$ , $V_{OUT(NOM)} + 1.4\text{ V} \leq V_{BIAS} \leq 5.5\text{ V}$ , $1\text{ mA} \leq I_{OUT} \leq 300\text{ mA}$	-1.25		1.25	%
		$-40^{\circ}\text{C} \leq T_J \leq 85$ , YKA package $V_{OUT(NOM)} + 0.5\text{ V} \leq V_{IN} \leq 3.3\text{ V}$ , $V_{OUT(NOM)} + 1.4\text{ V} \leq V_{BIAS} \leq 5.5\text{ V}$ , $1\text{ mA} \leq I_{OUT} \leq 300\text{ mA}$	-1.25		1.25	
		$-40^{\circ}\text{C} \leq T_J \leq 125$ , DSE and YKA package $V_{OUT(NOM)} + 0.5\text{ V} \leq V_{IN} \leq 3.3\text{ V}$ , $V_{OUT(NOM)} + 1.4\text{ V} \leq V_{BIAS} \leq 5.5\text{ V}$ , $1\text{ mA} \leq I_{OUT} \leq 300\text{ mA}$	-1.5		1.5	
$\Delta V_{OUT} / \Delta V_{IN}$	$V_{IN}$ line regulation	$V_{OUT(NOM)} + 0.5\text{ V} \leq V_{IN} \leq 3.3\text{ V}$		0.001		%/V
$\Delta V_{OUT} / \Delta V_{BIAS}$	$V_{BIAS}$ line regulation	$V_{OUT(NOM)} + 1.4\text{ V} \leq V_{BIAS} \leq 5.5\text{ V}$		0.03		%/V
$\Delta V_{OUT} / \Delta I_{OUT}$	Load regulation	$0.1\text{ mA} \leq I_{OUT} \leq 300\text{ mA}$		0.2		%/A
$I_{Q(BIAS)}$	Bias pin current	$T_J = 25^{\circ}\text{C}$ , $I_{OUT} = 0\text{ mA}$	3	6	8	$\mu\text{A}$
		$-40^{\circ}\text{C} < T_J < 85^{\circ}\text{C}$ , $I_{OUT} = 0\text{ mA}$			11	
		$I_{OUT} = 0\text{ mA}$			14	
		$I_{OUT} = 300\text{ mA}$			60	
$I_{Q(IN)}$	Input pin current <sup>(1)</sup>	$T_J = 25^{\circ}\text{C}$ , $I_{OUT} = 0\text{ mA}$		1.6	2.1	$\mu\text{A}$
		$-40^{\circ}\text{C} < T_J < 85^{\circ}\text{C}$ , $I_{OUT} = 0\text{ mA}$			2.3	
		$I_{OUT} = 0\text{ mA}$			2.6	
		$I_{OUT} = 300\text{ mA}$			9	
$I_{SHDN(BIAS)}$	$V_{BIAS}$ shutdown current	$-40^{\circ}\text{C} < T_J < 85^{\circ}\text{C}$ , $V_{IN} = 3.3\text{ V}$ , $V_{BIAS} = 5.5\text{ V}$ , $V_{EN} \leq 0.4\text{ V}$			400	nA
		$-40^{\circ}\text{C} < T_J < 125^{\circ}\text{C}$ , $V_{IN} = 3.3\text{ V}$ , $V_{BIAS} = 5.5\text{ V}$ , $V_{EN} \leq 0.4\text{ V}$			1200	
$I_{SHDN(IN)}$	$V_{IN}$ shutdown current	$-40^{\circ}\text{C} < T_J < 85^{\circ}\text{C}$ , $V_{IN} = 3.3\text{ V}$ , $V_{BIAS} = 5.5\text{ V}$ , $V_{EN} \leq 0.4\text{ V}$			1	$\mu\text{A}$
		$-40^{\circ}\text{C} < T_J < 125^{\circ}\text{C}$ , $V_{IN} = 3.3\text{ V}$ , $V_{BIAS} = 5.5\text{ V}$ , $V_{EN} \leq 0.4\text{ V}$			3	
$I_{CL}$	Output current limit	$V_{OUT} = 0.9 \times V_{OUT(NOM)}$ , YKA package	325	450	600	mA
		$V_{OUT} = 0.9 \times V_{OUT(NOM)}$ , DSE package	350	450	625	mA
$I_{SC}$	Short circuit current limit	$V_{OUT} = 0\text{ V}$		150		mA
$V_{DO(IN)}$	$V_{IN}$ dropout voltage <sup>(2)</sup>	$V_{IN} = V_{OUT(NOM)} - 0.1\text{ V}$ , $I_{OUT} = 300\text{ mA}$ , YKA package		40	70	mV
		$V_{IN} = V_{OUT(NOM)} - 0.1\text{ V}$ , $I_{OUT} = 300\text{ mA}$ , DSE package		55	90	
$V_{DO(BIAS)}$	$V_{BIAS}$ dropout voltage <sup>(2)</sup>	$I_{OUT} = 300\text{ mA}$		0.85	1.05	V
		$I_{OUT} = 150\text{ mA}$		0.75	0.95	

(1) This current flowing from  $V_{IN}$  to GND.

(2) Dropout is not measured for  $V_{OUT} < 1.0\text{ V}$

**Electrical Characteristics (continued)**

over  $T_J = -40^{\circ}\text{C}$  to  $+125^{\circ}\text{C}$ ,  $V_{IN} = V_{OUT(NOM)} + 0.5\text{ V}$ ,  $V_{BIAS} = V_{OUT(NOM)} + 1.4\text{ V}$ ,  $I_{OUT} = 1\text{ mA}$ ,  $V_{EN} = 1.0\text{ V}$ ,  $C_{IN} = 2.2\text{ }\mu\text{F}$ ,  $C_{OUT} = 2.2\text{ }\mu\text{F}$ , and  $C_{BIAS} = 0.1\text{ }\mu\text{F}$  ( unless otherwise noted); all typical values are at  $T_J = 25^{\circ}\text{C}$  .

PARAMETER		TEST CONDITIONS	MIN	TYP	MAX	UNIT
$V_{IN}$ PSRR	$V_{IN}$ power-supply rejection ratio	f = 1 kHz, $V_{OUT} = 1.1\text{ V}$ , $I_{OUT} = 50\text{ mA}$		60		dB
		f = 100 kHz, $V_{OUT} = 1.1\text{ V}$ , $I_{OUT} = 50\text{ mA}$		36		
		f = 1 MHz, $V_{OUT} = 1.1\text{ V}$ , $I_{OUT} = 50\text{ mA}$		32		
		f = 1.5 MHz, $V_{OUT} = 1.1\text{ V}$ , $I_{OUT} = 50\text{ mA}$		35		
$V_{BIAS}$ PSRR	$V_{BIAS}$ power-supply rejection ratio	f = 1 kHz, $V_{OUT} = 1.1\text{ V}$ , $I_{OUT} = 300\text{ mA}$		60		dB
		f = 100 kHz, $V_{OUT} = 1.1\text{ V}$ , $I_{OUT} = 300\text{ mA}$		40		
		f = 1 MHz, $V_{OUT} = 1.1\text{ V}$ , $I_{OUT} = 300\text{ mA}$		35		
$V_n$	Output voltage noise	Bandwidth = 10 Hz to 100 kHz, $V_{OUT} = 1.0\text{ V}$ , $I_{OUT} = 50\text{ mA}$		93.9		$\mu\text{V}_{\text{RMS}}$
$V_{UVLO(BIAS)}$	Bias supply UVLO	$V_{BIAS}$ rising	1.46	1.54	1.63	V
		$V_{BIAS}$ falling	1.35	1.44	1.55	
$V_{UVLO\_HYST(BIAS)}$	Bias supply hysteresis	$V_{BIAS}$ hysteresis		80		mV
$V_{UVLO(IN)}$	Input supply UVLO	$V_{IN}$ rising	645	675	710	mV
		$V_{IN}$ falling	565	600	640	mV
$V_{UVLO\_HYST(IN)}$	Input supply hysteresis	$V_{IN}$ hysteresis		75		mV
$t_{STR}$	Start-up time <sup>(3)</sup>			525	1200	$\mu\text{s}$
$V_{HI(EN)}$	EN pin logic high voltage		0.9			V
$V_{LO(EN)}$	EN pin logic low voltage				0.4	V
$I_{EN}$	EN pin current	EN = 5.5 V		10		nA
$R_{PULLDOWN}$	Pulldown resistor	$V_{BIAS} = 3.3\text{ V}$ , P version only		120		$\Omega$
$T_{SD}$	Thermal shutdown temperature	Shutdown, temperature rising		160		$^{\circ}\text{C}$
		Reset, temperature falling		145		

(3) Start-up time = time from EN assertion to  $0.95 \times V_{OUT(NOM)}$ .

### 6.6 Typical Characteristics

at  $T_J = -40\text{ }^\circ\text{C}$  to  $+125\text{ }^\circ\text{C}$ ,  $V_{IN} = V_{OUT(NOM)} + 0.5\text{ V}$ ,  $V_{BIAS} = V_{OUT(NOM)} + 1.4\text{ V}$ ,  $I_{OUT} = 1\text{ mA}$ ,  $V_{EN} = V_{IN}$ ,  $C_{IN} = 2.2\text{ }\mu\text{F}$ ,  $C_{OUT} = 2.2\text{ }\mu\text{F}$ , and  $C_{BIAS} = 0.1\text{ }\mu\text{F}$  (unless otherwise noted); typical values are at  $T_J = 25\text{ }^\circ\text{C}$

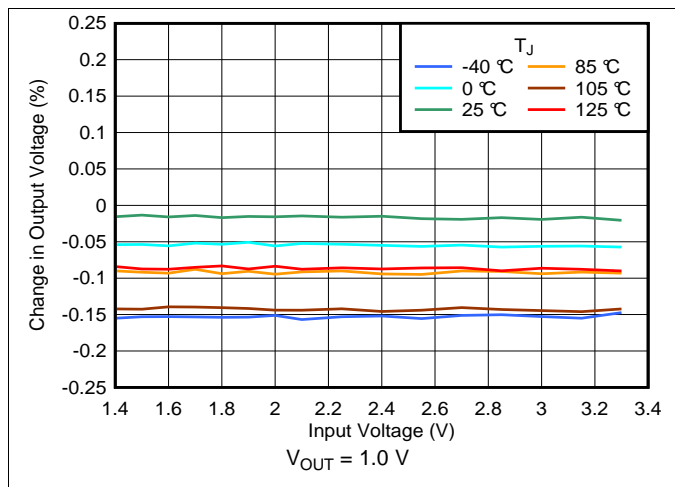

Figure 1. Output Accuracy Over Temperature, YKA Package

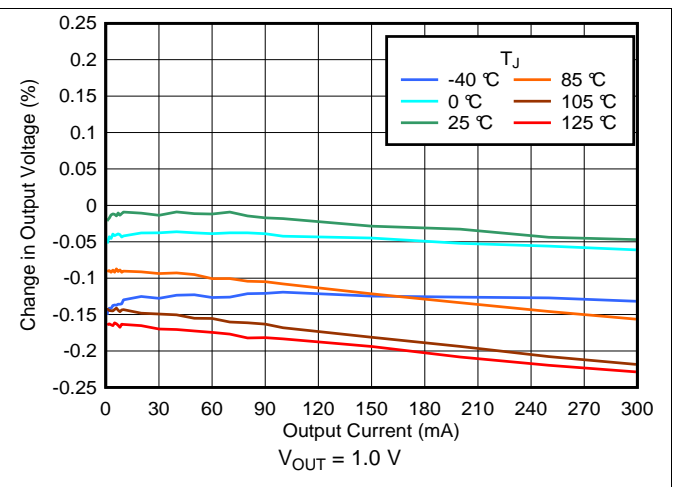

Figure 2. Output Accuracy Over Temperature, YKA Package

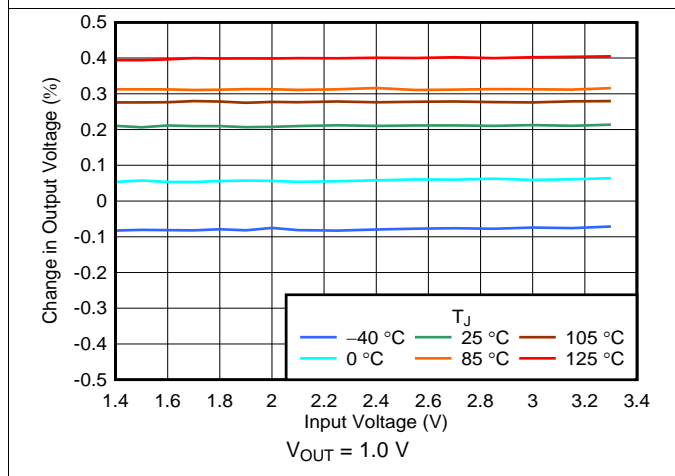

Figure 3. Output Accuracy Over Temperature, DSE Package

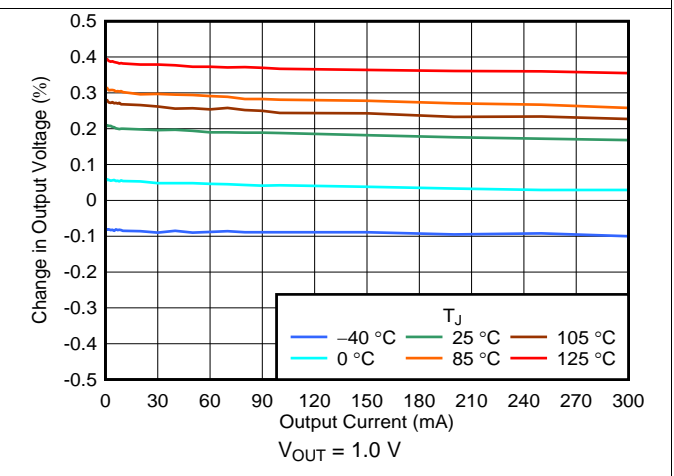

Figure 4. Output Accuracy Over Temperature, DSE Package

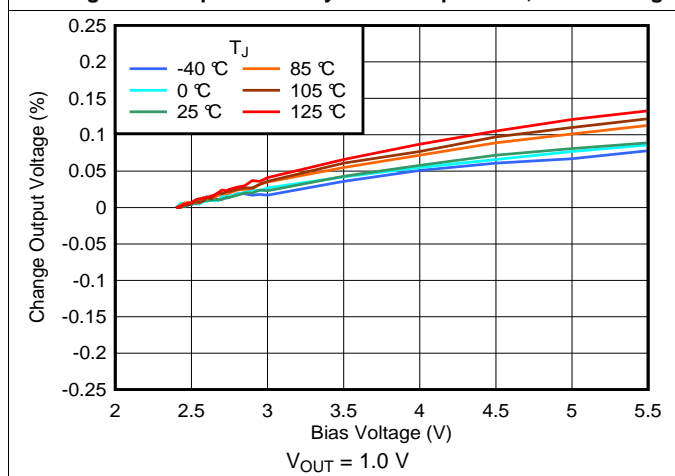

Figure 5. Output Accuracy Over Temperature and  $V_{BIAS}$

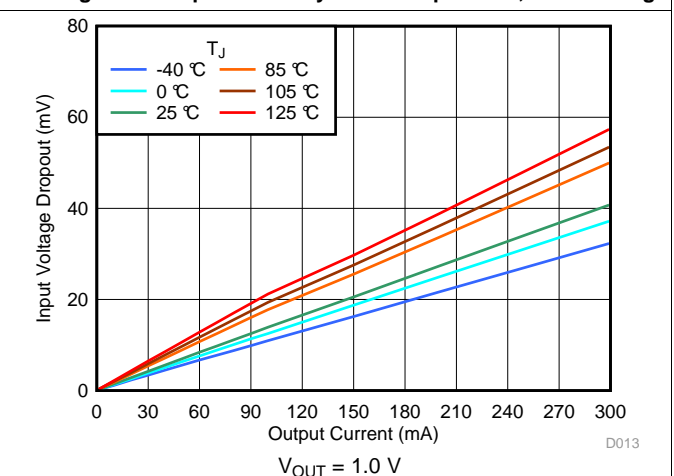

Figure 6. Dropout vs  $I_{OUT}$  and Temperature, YKA Package

Typical Characteristics (continued)

at  $T_J = -40\text{ }^\circ\text{C}$  to  $+125\text{ }^\circ\text{C}$ ,  $V_{IN} = V_{OUT(NOM)} + 0.5\text{ V}$ ,  $V_{BIAS} = V_{OUT(NOM)} + 1.4\text{ V}$ ,  $I_{OUT} = 1\text{ mA}$ ,  $V_{EN} = V_{IN}$ ,  $C_{IN} = 2.2\text{ }\mu\text{F}$ ,  $C_{OUT} = 2.2\text{ }\mu\text{F}$ , and  $C_{BIAS} = 0.1\text{ }\mu\text{F}$  (unless otherwise noted); typical values are at  $T_J = 25\text{ }^\circ\text{C}$

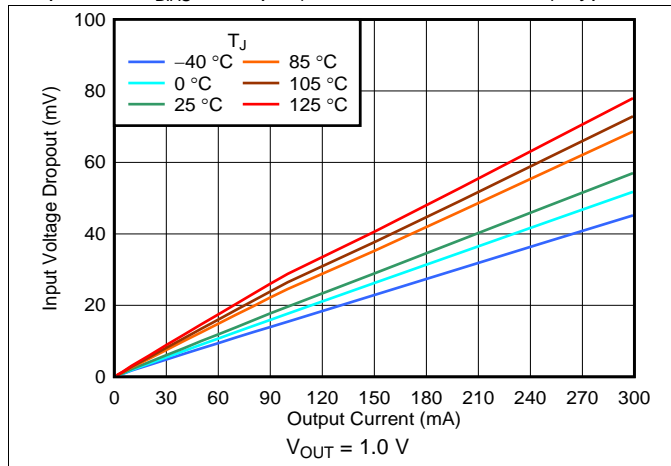

Figure 7. Dropout vs  $I_{OUT}$  and Temperature, DSE Package

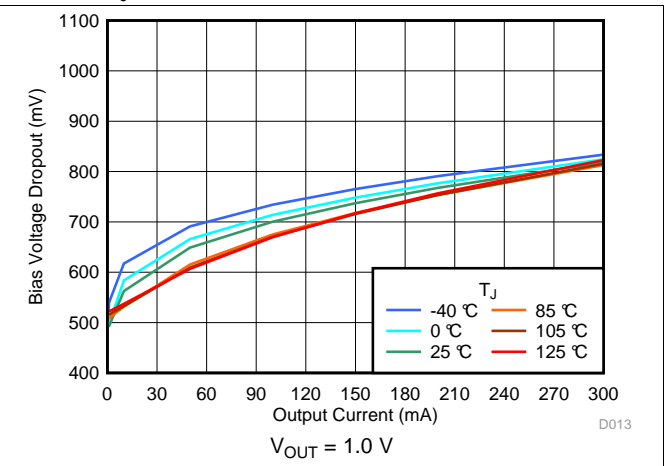

Figure 8. Dropout vs  $V_{BIAS}$  and Temperature

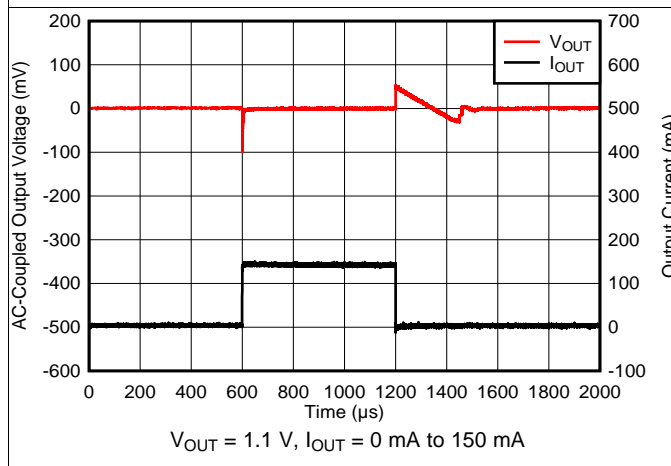

Figure 9.  $I_{OUT}$  Transient

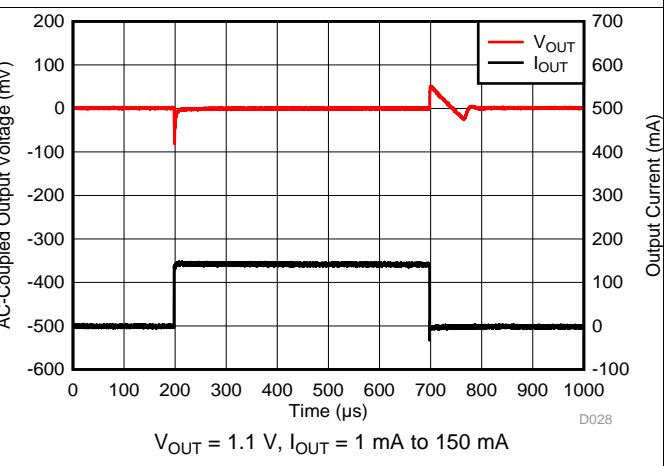

Figure 10.  $I_{OUT}$  Transient

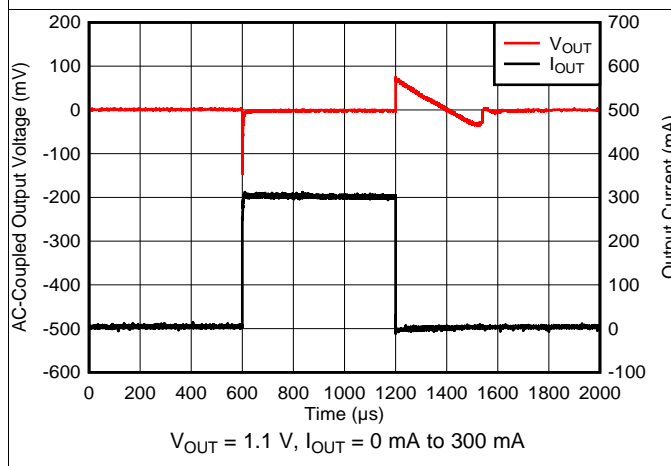

Figure 11.  $I_{OUT}$  Transient

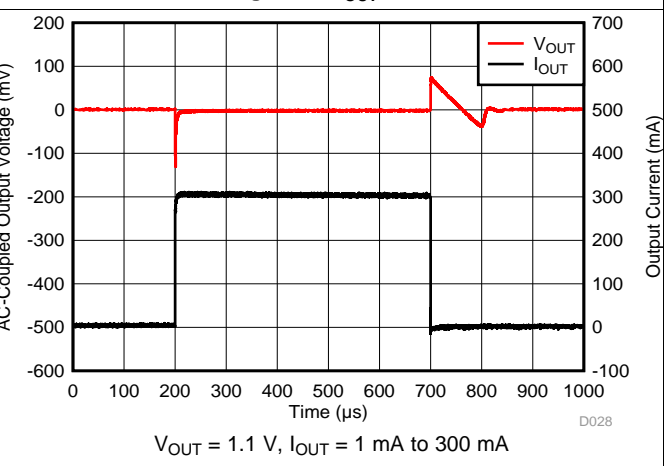

Figure 12.  $I_{OUT}$  Transient



Typical Characteristics (continued)

at  $T_J = -40\text{ }^\circ\text{C}$  to  $+125\text{ }^\circ\text{C}$ ,  $V_{IN} = V_{OUT(NOM)} + 0.5\text{ V}$ ,  $V_{BIAS} = V_{OUT(NOM)} + 1.4\text{ V}$ ,  $I_{OUT} = 1\text{ mA}$ ,  $V_{EN} = V_{IN}$ ,  $C_{IN} = 2.2\text{ }\mu\text{F}$ ,  $C_{OUT} = 2.2\text{ }\mu\text{F}$ , and  $C_{BIAS} = 0.1\text{ }\mu\text{F}$  (unless otherwise noted); typical values are at  $T_J = 25\text{ }^\circ\text{C}$

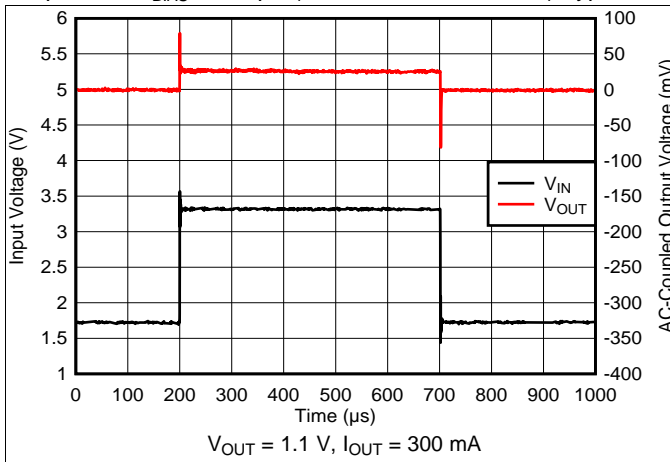

Figure 13.  $V_{IN}$  Transient

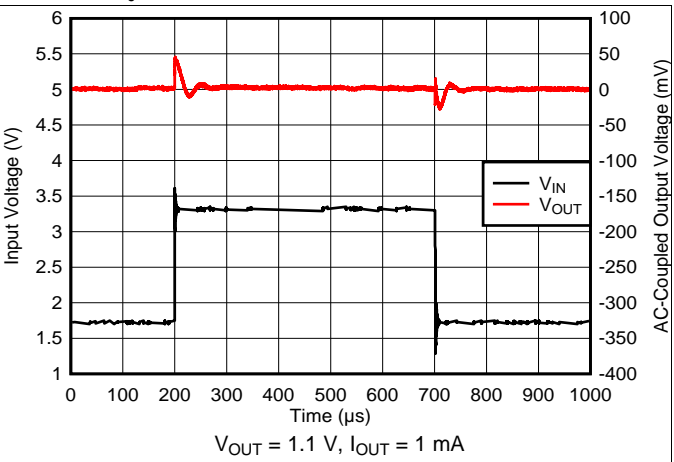

Figure 14.  $V_{IN}$  Transient

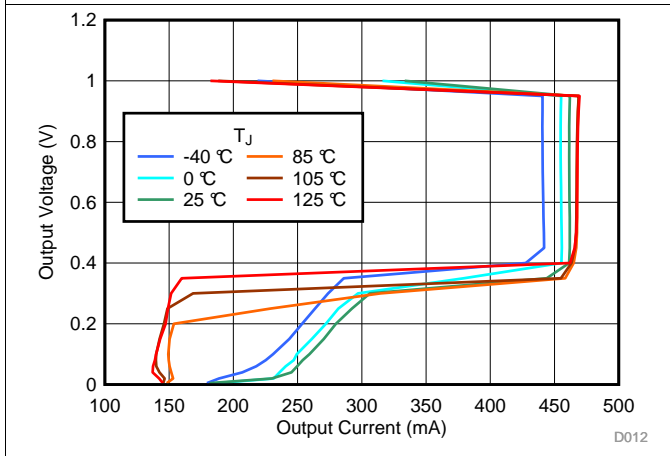

Figure 15. Foldback Current Limit Over Temperature

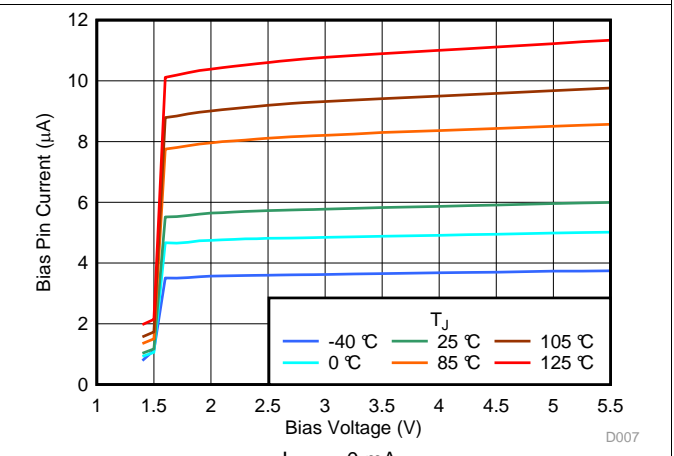

Figure 16.  $I_Q (V_{BIAS})$  Over Temperature

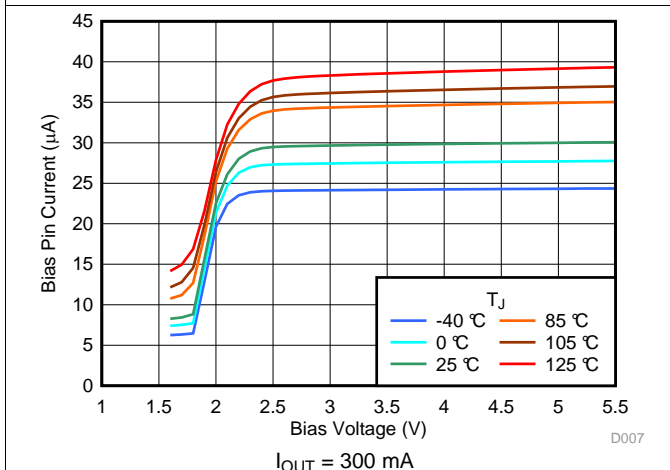

Figure 17.  $I_Q (V_{BIAS})$  Over Temperature

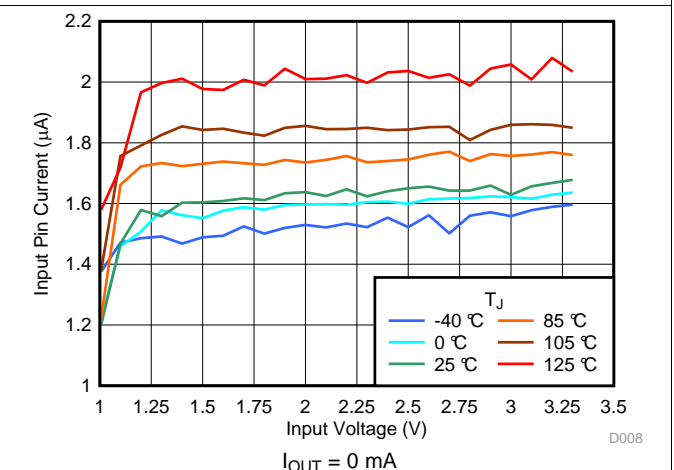
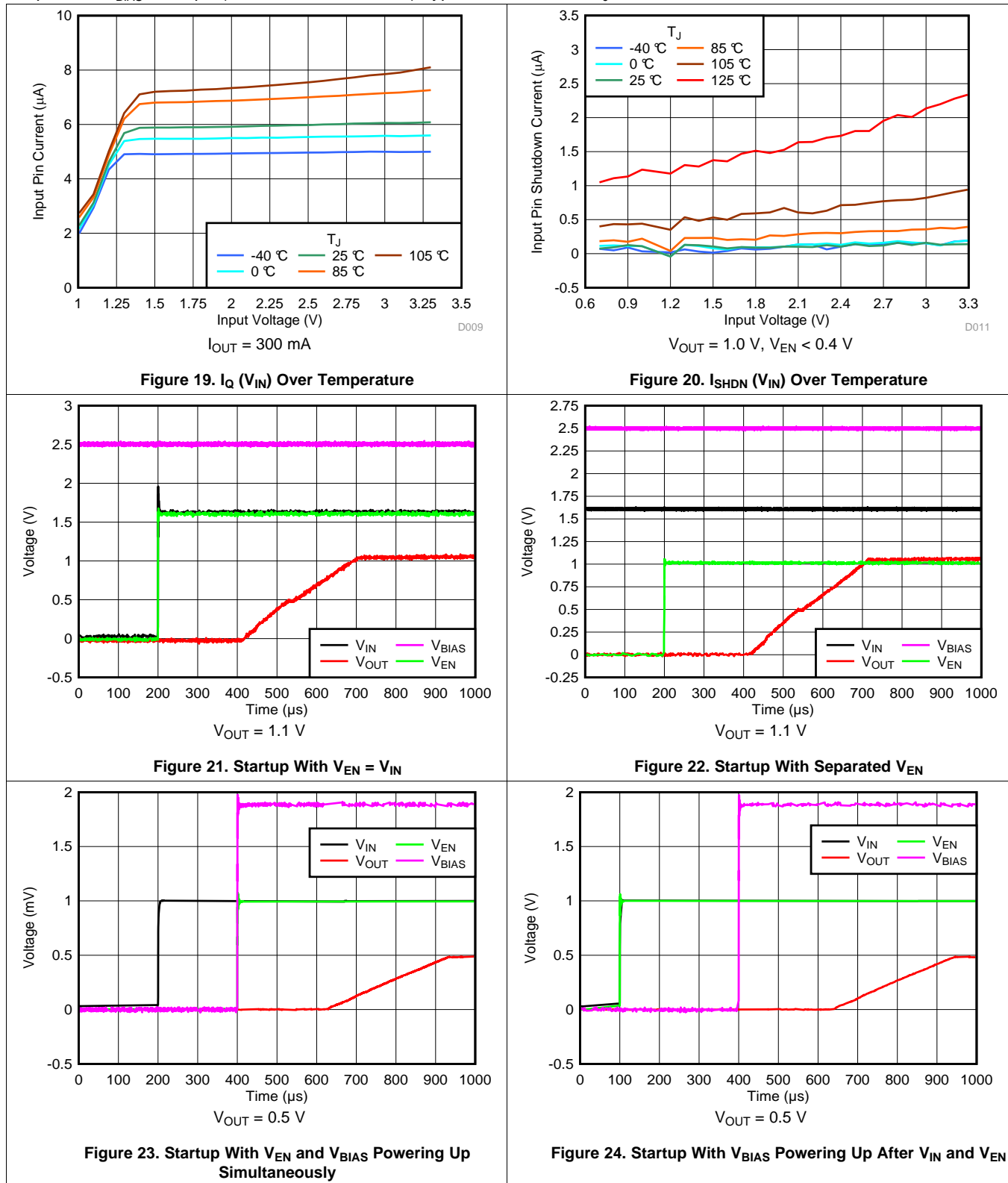

Figure 18.  $I_Q (V_{IN})$  Over Temperature

### Typical Characteristics (continued)

at  $T_J = -40\text{ }^\circ\text{C}$  to  $+125\text{ }^\circ\text{C}$ ,  $V_{IN} = V_{OUT(NOM)} + 0.5\text{ V}$ ,  $V_{BIAS} = V_{OUT(NOM)} + 1.4\text{ V}$ ,  $I_{OUT} = 1\text{ mA}$ ,  $V_{EN} = V_{IN}$ ,  $C_{IN} = 2.2\text{ }\mu\text{F}$ ,  $C_{OUT} = 2.2\text{ }\mu\text{F}$ , and  $C_{BIAS} = 0.1\text{ }\mu\text{F}$  (unless otherwise noted); typical values are at  $T_J = 25\text{ }^\circ\text{C}$



Typical Characteristics (continued)

at  $T_J = -40\text{ }^\circ\text{C}$  to  $+125\text{ }^\circ\text{C}$ ,  $V_{IN} = V_{OUT(NOM)} + 0.5\text{ V}$ ,  $V_{BIAS} = V_{OUT(NOM)} + 1.4\text{ V}$ ,  $I_{OUT} = 1\text{ mA}$ ,  $V_{EN} = V_{IN}$ ,  $C_{IN} = 2.2\text{ }\mu\text{F}$ ,  $C_{OUT} = 2.2\text{ }\mu\text{F}$ , and  $C_{BIAS} = 0.1\text{ }\mu\text{F}$  (unless otherwise noted); typical values are at  $T_J = 25\text{ }^\circ\text{C}$

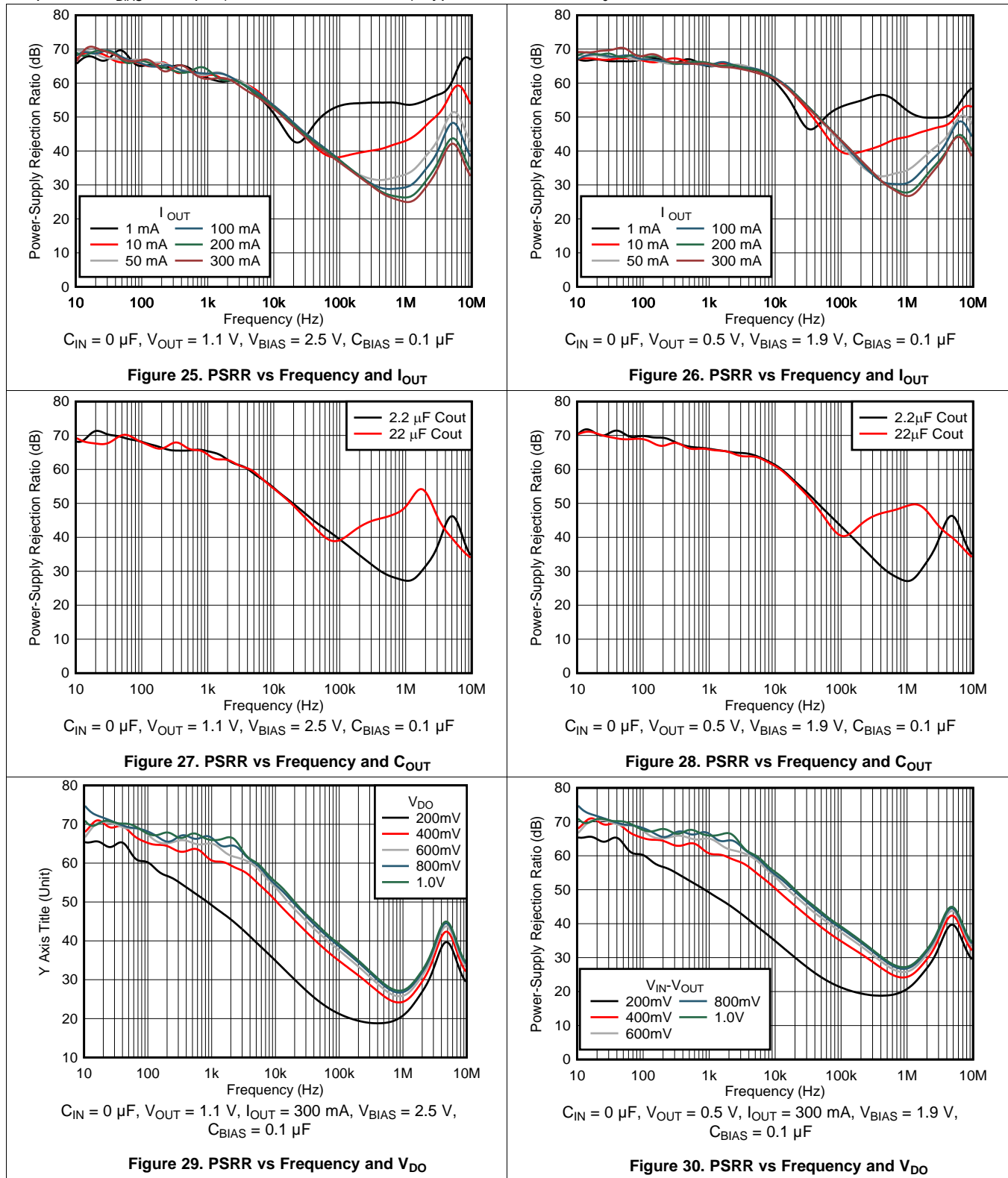

Typical Characteristics (continued)

at  $T_J = -40\text{ }^\circ\text{C}$  to  $+125\text{ }^\circ\text{C}$ ,  $V_{IN} = V_{OUT(NOM)} + 0.5\text{ V}$ ,  $V_{BIAS} = V_{OUT(NOM)} + 1.4\text{ V}$ ,  $I_{OUT} = 1\text{ mA}$ ,  $V_{EN} = V_{IN}$ ,  $C_{IN} = 2.2\text{ }\mu\text{F}$ ,  $C_{OUT} = 2.2\text{ }\mu\text{F}$ , and  $C_{BIAS} = 0.1\text{ }\mu\text{F}$  (unless otherwise noted); typical values are at  $T_J = 25\text{ }^\circ\text{C}$

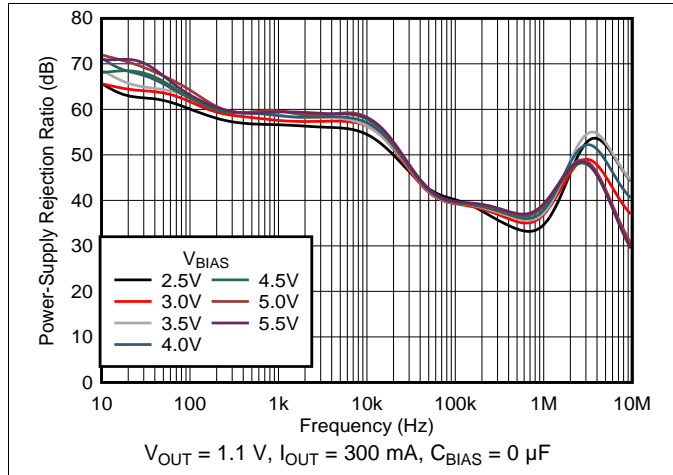

Figure 31.  $V_{BIAS}$  PSRR vs Frequency and  $V_{BIAS}$

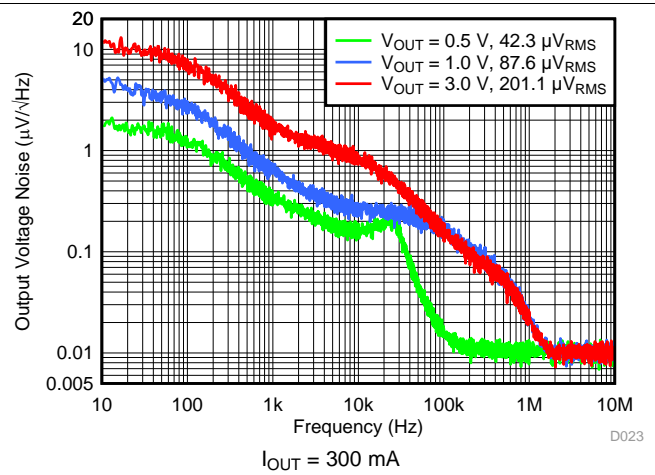

Figure 32. Output Noise vs Frequency and  $V_{OUT}$

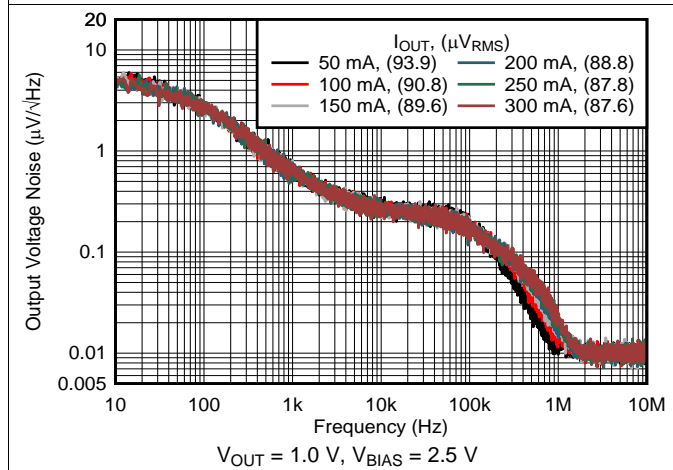

Figure 33. Output Noise vs Frequency and  $I_{OUT}$

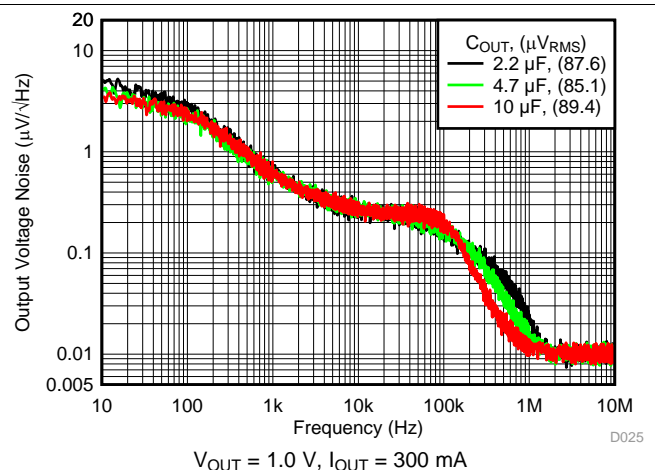

Figure 34. Output Noise vs Frequency and  $C_{OUT}$

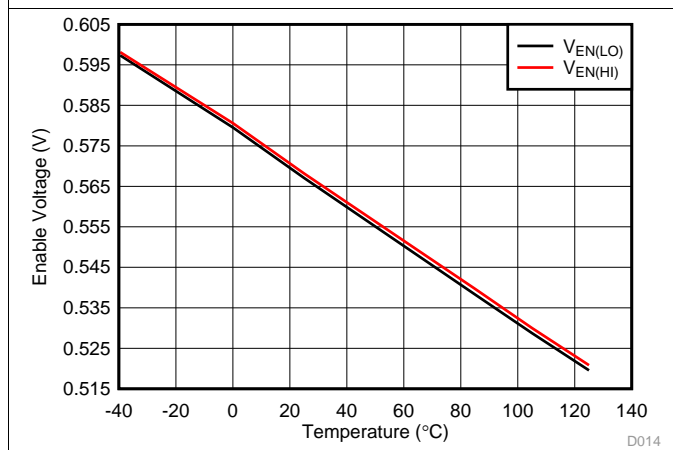

Figure 35. Enable High and Low Thresholds vs Temperature

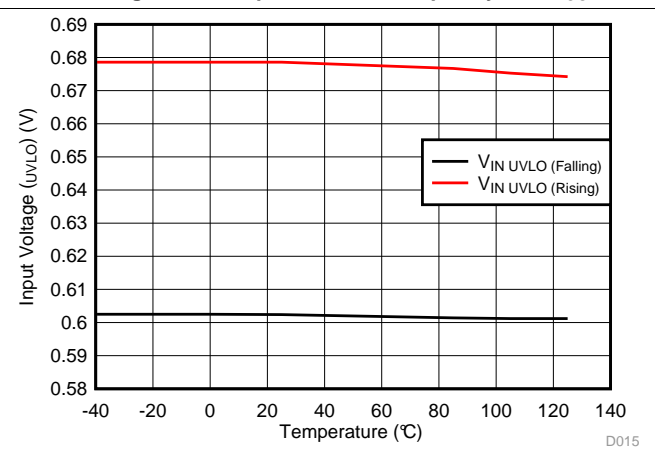
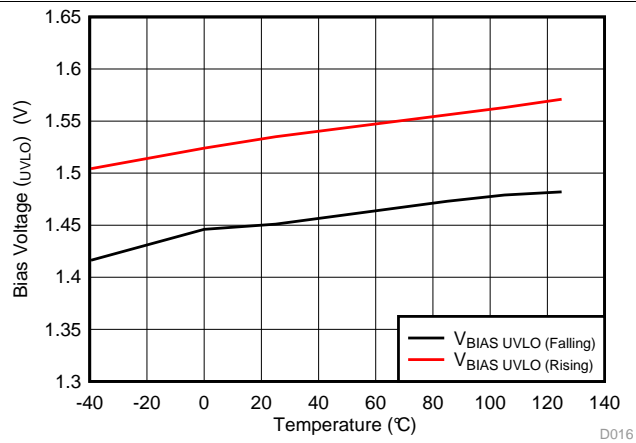

Figure 36.  $V_{UVLO(IN)}$  Rising and Falling Thresholds vs Temperature

**Typical Characteristics (continued)**

at  $T_J = -40\text{ }^\circ\text{C}$  to  $+125\text{ }^\circ\text{C}$ ,  $V_{IN} = V_{OUT(NOM)} + 0.5\text{ V}$ ,  $V_{BIAS} = V_{OUT(NOM)} + 1.4\text{ V}$ ,  $I_{OUT} = 1\text{ mA}$ ,  $V_{EN} = V_{IN}$ ,  $C_{IN} = 2.2\text{ }\mu\text{F}$ ,  $C_{OUT} = 2.2\text{ }\mu\text{F}$ , and  $C_{BIAS} = 0.1\text{ }\mu\text{F}$  (unless otherwise noted); typical values are at  $T_J = 25\text{ }^\circ\text{C}$



**Figure 37.  $V_{UVLO(BIAS)}$  Rising and Falling Thresholds vs Temperature**

## 7 Detailed Description

### 7.1 Overview

The TPS7A10 is a low input, ultra-low dropout, and low quiescent current linear regulator that is optimized for excellent transient performance. These characteristics make the device ideal for most battery-powered applications. The implementation of the BIAS pin on the TPS7A10 vastly improves efficiency of low-voltage output applications by allowing the use of a preregulated, low-voltage input supply that offers sub-band-gap output voltages. The high power-supply rejection ratio (PSRR), low noise, low ground pin current, and ultra-small packaging make this device suitable for ultra-portable applications. This device also offers high output voltage accuracy of 1.5% over the recommended junction temperature range.

### 7.2 Functional Block Diagram

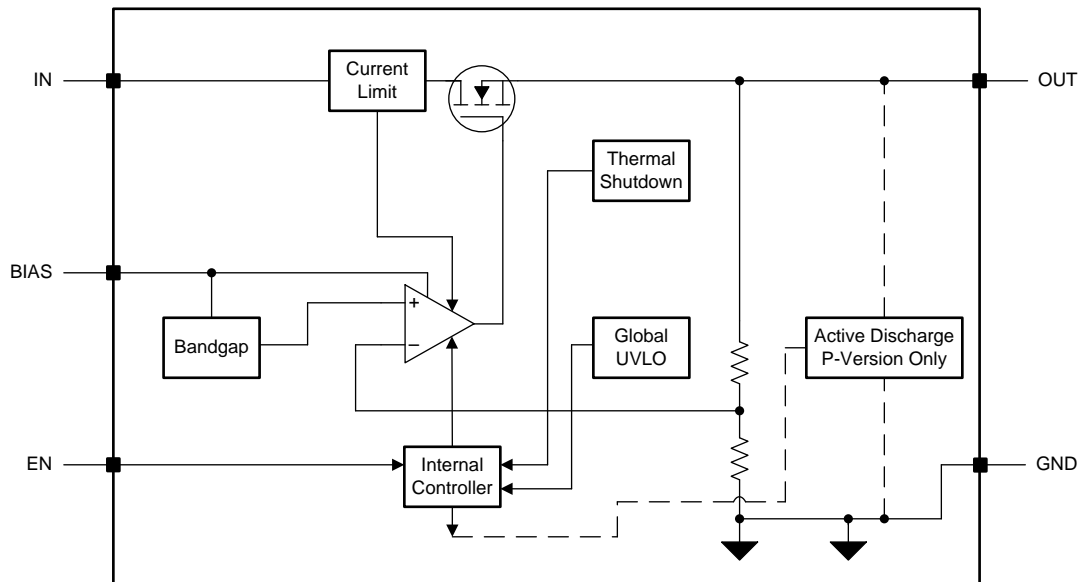

## 7.3 Feature Description

### 7.3.1 Excellent Transient Response

The TPS7A10 responds quickly to a transient on the input supply (line transient) or the output current (load transient) that results from the device high input impedance and low output impedance across frequency. This same capability also means that the device has a high power-supply rejection ratio (PSRR) and low internal noise floor ( $e_n$ ). The low-dropout regulator (LDO) approximates an ideal power supply in ac (small-signal) and dc (large-signal) conditions.

The choice of external component values optimizes the small- and large-signal response; see the [Input and Output Capacitor Requirements](#) section for proper selection.

### 7.3.2 Global Undervoltage Lockout (UVLO)

The TPS7A10 uses two undervoltage lockout (UVLO) circuits: one on the BIAS pin and one on the IN pin to prevent the device from turning on before both  $V_{BIAS}$  and  $V_{IN}$  rise above their lockout voltages. The two UVLO signals are connected internally through an AND gate, as shown in [Figure 38](#). This internal connection allows the device to be turned off when either rail is below its lockout voltage.

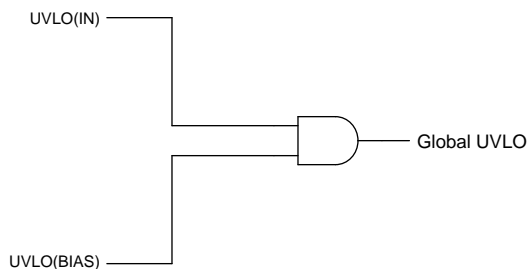

**Figure 38. Global UVLO circuit**

### 7.3.3 Active Discharge

The active discharge option (P version only) have internal pulldown MOSFET that connects a 120-Ω resistor to ground when the device is disabled in order to actively discharge the output voltage. The active discharge circuit is activated by driving the enable pin to logic low to disable the device, or when the device is in thermal shutdown.

The discharge time after disabling the device depends on the output capacitance ( $C_{OUT}$ ) and the load resistance ( $R_L$ ) in parallel with the 120-Ω pulldown resistor. [Equation 1](#) calculates the discharge time constant:

$$\tau = \frac{120 \cdot R_L}{120 + R_L} \cdot C_{OUT} \quad (1)$$

Do not rely on the active discharge circuit for discharging a large amount of output capacitance after the input supply collapses because reverse current can possibly flow from the output to the input. This reverse current flow can cause damage to the device. Limit reverse current to no more than 5% of the device-rated current.

### 7.3.4 Enable

The enable pin for this device is active high. The output of the device is turned on when the enable pin voltage is greater than the EN pin logic high voltage, and the output of the device is turned off when the enable pin voltage is less than the EN pin voltage logic low .

The EN pin can be tied to the IN pin, the BIAS pin, or can be driven separately to enable and disable the device; however, connecting the EN pin to the IN pin is only acceptable if the  $V_{IN}$  voltage is greater than 0.9 V.

## Feature Description (continued)

### 7.3.5 Sequencing Requirement

The  $V_{IN}$ ,  $V_{BIAS}$ , and  $V_{EN}$  voltages can be sequenced in any order without causing damage to the device. The start up is always monotonic regardless of the sequencing order or the ramp rates of IN, BIAS, and EN pins. For optimum device performance, have  $V_{BIAS}$  present before enabling the device in any sequence order between  $V_{IN}$  and  $V_{EN}$  because the device internal circuitry is powered off the  $V_{BIAS}$ , refer to [Recommended Operating Conditions](#) for proper voltage ranges of  $V_{IN}$ ,  $V_{BIAS}$ , and  $V_{EN}$ .

### 7.3.6 Internal Foldback Current Limit

The internal foldback current limit circuit is used to protect the LDO against high-load current faults or shorting events. The foldback mechanism lowers the current limit as the output voltage decreases, and limits power dissipation during short-circuit events while still allowing for the device to operate at the rated output current; see [Figure 15](#).

For example, when  $V_{OUT}$  is 90% of  $V_{OUT(nom)}$ , the current limit is  $I_{CL}$  (typical); however, if  $V_{OUT}$  is forced to 0 V, the current limit is  $I_{SC}$  (typical).

In many LDOs, the foldback current limit can prevent start up into a constant-current load or a negatively-biased output. A *brick-wall* current limit is when there is an abrupt current stop after the current limit is reached. The foldback mechanism for this device goes into a *brick-wall* current limit when  $V_{OUT} > 500$  mV (typical), thus limiting current to  $I_{CL}$  (typical). When  $V_{OUT}$  is approximately 0 V, current is limited to  $I_{SC}$  (typical) in order to provide normal start up into a variety of loads.

Thermal shutdown can activate during a current-limit event because of the high power dissipation typically found in these conditions. To provide proper operation of the current limit, minimize the inductances to the input and load. Continuous operation in current limit is not recommended.

### 7.3.7 Thermal Shutdown

The device contains a thermal shutdown protection circuit to disable the device when the thermal junction temperature ( $T_J$ ) of the main pass-FET rises to the thermal shutdown temperature ( $T_{SD}$ ) for shutdown listed in the [Electrical Characteristics](#). Thermal shutdown hysteresis makes sure that the LDO resets again (turns on) when the temperature falls to the  $T_{SD}$  for reset.

The thermal time constant of the semiconductor die is fairly short, and thus the device may cycle on and off when thermal shutdown is reached until the power dissipation is reduced.

For reliable operation, limit the junction temperature to a maximum of 125°C. Operation above 125°C causes the device to exceed the operational specifications. Although the internal protection circuitry of the device is designed to protect against thermal overload conditions, this circuitry is not intended to replace proper heat sinking. Continuously running the device into thermal shutdown or above a junction temperature of 125°C reduces long-term reliability.

A fast start up when  $T_J > T_{SD}$  for reset causes the device thermal shutdown to assert at  $T_{SD}$  for reset, and prevents the device from turning on until the junction temperature is reduced below  $T_{SD}$  for reset.



## 7.4 Device Functional Modes

The device has the following modes of operation:

- Normal operation: The device regulates to the nominal output voltage.
- Dropout operation: The pass element operates as a resistor and the output voltage is set as  $V_{IN} - V_{DO}$ .
- Disabled: The output of the device is disabled and the discharge circuit is activated.

Table 1 shows the conditions that lead to the different modes of operation.

**Table 1. Device Functional Mode Comparison**

OPERATING MODE	PARAMETER				
	$V_{IN}$	$V_{BIAS}$	$V_{EN}$	$I_{OUT}$	$T_J$
Normal mode	$V_{IN} > V_{OUT(nom)} + V_{DO}$ and $V_{IN} > V_{IN(min)}$	$V_{BIAS} > V_{OUT} + 1.05\text{ V}$	$V_{EN} > V_{HI(EN)}$	$I_{OUT} < I_{CL}$	$T_J < T_{SD}$ for shutdown
Dropout mode	$V_{IN(min)} < V_{IN} < V_{OUT(nom)} + V_{DO}$	$V_{BIAS} < V_{OUT} + 1.05\text{ V}$	$V_{EN} > V_{HI(EN)}$	$I_{OUT} < I_{CL}$	$T_J < T_{SD}$ for shutdown
Disabled mode (any true condition disables the device)	$V_{IN} < V_{UVLO(IN)}$	$V_{BIAS} < V_{BIAS(UVLO)}$	$V_{EN} < V_{LO(EN)}$	—	$T_J > T_{SD}$ for shutdown

### 7.4.1 Normal Mode

The device regulates the output to the nominal output voltage when all normal mode conditions in Table 1 are met.

### 7.4.2 Dropout Mode

The device is not in regulation, and the output voltage tracks the input voltage minus the voltage drop across the pass element of the device. In this mode, PSRR and the noise performance of the device are significantly degraded.

### 7.4.3 Disable Mode

In this mode, the pass element is turned off, the internal circuits are shut down, and the output voltage is actively discharged to ground by an internal resistor.

## 8 Application and Implementation

### NOTE

Information in the following applications sections is not part of the TI component specification, and TI does not warrant its accuracy or completeness. TI's customers are responsible for determining suitability of components for their purposes. Customers should validate and test their design implementation to confirm system functionality.

### 8.1 Application Information

Successfully implementing an LDO in an application depends on the application requirements. This section discusses key device features and the best implementation to achieve a reliable design.

#### 8.1.1 Recommended Capacitor Types

The device is designed to be stable using low equivalent series resistance (ESR) ceramic capacitors at the input, output, and BIAS pins. Multilayer ceramic capacitors are the industry standard for these types of applications, but must be used with good judgment. Ceramic capacitors that use X7R-, X5R-, and COG-rated dielectric materials provide relatively good capacitive stability across temperature. Avoid Y5V-rated capacitors because of large variations in capacitance.

Regardless of the ceramic capacitor type selected, ceramic capacitance varies with operating voltage and temperature. As a rule of thumb, assume that effective capacitance decreases by as much as 50%. The input, output, and bias capacitors recommended in the [Recommended Operating Conditions](#) table account for an effective capacitance of approximately 50% of the nominal value.

#### 8.1.2 Input and Output Capacitor Requirements

A minimum 2.2- $\mu$ F ceramic capacitor at the input is required for stability. A minimum 2.2- $\mu$ F ceramic capacitor with a maximum ESR value of less than 250 m $\Omega$  at the output is also required for stability. The input capacitor counteracts reactive input sources and improves transient response, input ripple, and PSRR. A higher-value input capacitor may be necessary if large, fast rise-time load or line transients are anticipated, or if the device is located several inches from the input power source. Dynamic performance of the device is improved with the use of an output capacitor larger than the minimum value specified in the [Recommended Operating Conditions](#) table.

Although a bias capacitor is not required, connect a 0.1- $\mu$ F ceramic capacitor from BIAS to GND for best analog design practice. This capacitor counteracts reactive bias sources if the source impedance is not sufficiently low.

Place the input, output, and bias capacitors as close as possible to the device to minimize traces parasitics.

## Application Information (continued)

### 8.1.3 Load Transient Response

The load-step transient response is the output voltage response by the LDO to a step in load current while output voltage regulation is maintained. See [Figure 9](#), [Figure 10](#), [Figure 11](#), and [Figure 12](#) for typical load transient response. There are two key transitions during a load transient response: the transition from a light to a heavy load, and the transition from a heavy to a light load. The regions in [Figure 39](#) are broken down as described in this section. Regions A, E, and H are where the output voltage is in steady-state operation.

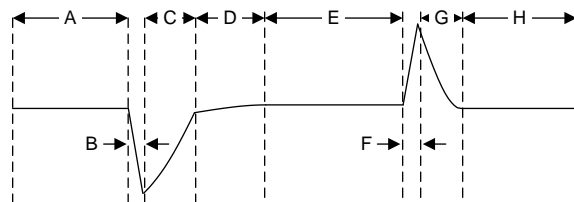

**Figure 39. Load Transient Waveform**

During transitions from a light load to a heavy load:

- The initial voltage dip is a result of the depletion of the output capacitor charge and parasitic impedance to the output capacitor (region B)
- Recovery from the dip results from the LDO increasing the sourcing current, and leads to output voltage regulation (region C)

During transitions from a heavy load to a light load:

- The initial voltage rise results from the LDO sourcing a large current, and leads to the output capacitor charge to increase (region F)
- Recovery from the rise results from the LDO decreasing the sourcing current in combination with the load discharging the output capacitor (region G)

A larger output capacitance reduces the peaks during a load transient, but slows down the response time of the device. A larger dc load also reduces the peaks because the amplitude of the transition is lowered, and a higher current discharge path is provided for the output capacitor.

### 8.1.4 Dropout Voltage

Generally, dropout voltage refers to the minimum voltage difference between the input and output voltage ( $V_{DO} = V_{IN} - V_{OUT}$ ) that is required for regulation. When  $V_{IN} - V_{OUT}$  drops below the required  $V_{DO}$  for the given load current, the device functions as a resistive switch and does not regulate output voltage. Dropout voltage is proportional to the output current because the device is operating as a resistive switch.

Dropout voltage is affected by the drive strength of the pass-element gate. This drive strength is nonlinear with respect to  $V_{IN}$  on this device.

### 8.1.5 Behavior During Transition From Dropout Into Regulation

Some applications may have transients that place this device into dropout, especially when this device can be powered from a battery with relatively high ESR. The load transient saturates the output stage of the error amplifier when the pass element is driven fully on, making the pass element function like a resistor from  $V_{IN}$  to  $V_{OUT}$ . The error amplifier response time to this load transient is limited because the error amplifier must first recover from saturation and then place the pass element back into active mode. During this time,  $V_{OUT}$  overshoots because the pass element is functioning as a resistor from  $V_{IN}$  to  $V_{OUT}$ .

When  $V_{IN}$  ramps up slowly for start-up, the slow ramp-up voltage may place the device in dropout. As with many other LDOs, the output can overshoot on recovery from this condition. However, this condition is easily avoided through the use of the enable signal.

If operating under these conditions, apply a higher dc load or increase the output capacitance to reduce the overshoot. These solutions provide a path to dissipate the excess charge.

## Application Information (continued)

### 8.1.6 Undervoltage Lockout Circuit Operation

The  $V_{IN}$  UVLO circuit makes sure that the device remains disabled before the input supply reaches the minimum operational voltage range. The  $V_{IN}$  UVLO circuit also makes sure that the device shuts down when the input supply collapses. Similarly, the  $V_{BIAS}$  UVLO circuit makes sure that the device stays disabled before the bias supply reaches the minimum operational voltage range. The  $V_{BIAS}$  UVLO circuit also makes sure that the device shuts down when the bias supply collapses.

Figure 40 depicts the UVLO circuit response to various input or bias voltage events. This figure can be separated into the following parts:

- Region A: The device does not start until the input or bias voltage reaches the UVLO rising threshold.
- Region B: Normal operation, regulating device
- Region C: Brownout event above the UVLO falling threshold (UVLO rising threshold – UVLO hysteresis). The output may fall out of regulation, but the device is still enabled.
- Region D: Normal operation, regulating device
- Region E: Brownout event below the UVLO falling threshold. The device is disabled in most cases, and the output falls as a result of the load and active discharge circuit. The device is re-enabled when the UVLO rising threshold is reached, and a normal start-up follows.
- Region F: Normal operation followed by the input or bias falling to the UVLO falling threshold
- Region G: The device is disabled as the input or bias voltages fall below the UVLO falling threshold to 0 V. The output falls as a result of the load and active discharge circuit.

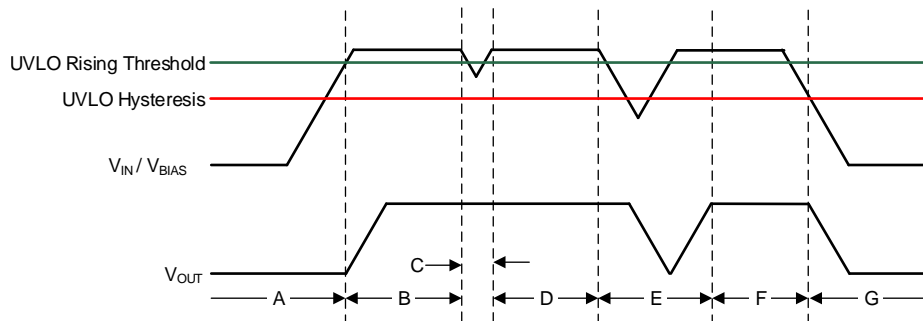

Figure 40. Typical  $V_{IN}$  or  $V_{BIAS}$  UVLO Circuit Operation

### 8.1.7 Power Dissipation ( $P_D$ )

Circuit reliability demands that proper consideration be given to device power dissipation, location of the circuit on the printed circuit board (PCB), and correct sizing of the thermal plane. The PCB area around the regulator must be as free as possible of other heat-generating devices that cause added thermal stresses.

Equation 2 calculates the maximum allowable power dissipation for the device in a given package:

$$P_{D-MAX} = [(T_J - T_A) / R_{\theta JA}] \quad (2)$$

Equation 3 represents the actual power being dissipated in the device:

$$P_D = (I_{GND} + I_{OUT}) \times (V_{IN} - V_{OUT}) \quad (3)$$

Power dissipation can be minimized, and thus greater efficiency achieved, by proper selection of the system voltage rails. Proper selection allows the minimum input-to-output voltage differential to be obtained. The low dropout of the TPS7A10 allows for maximum efficiency across a wide range of output voltages.

The main heat conduction path for the device depends on the ambient temperature and the thermal resistance across the various interfaces between the die junction and ambient air.

### Application Information (continued)

The maximum power dissipation determines the maximum allowable junction temperature ( $T_J$ ) for the device. According to Equation 4, maximum power dissipation and junction temperature are most often related by the junction-to-ambient thermal resistance ( $R_{\theta JA}$ ) of the combined PCB and device package and the temperature of the ambient air ( $T_A$ ). The equation is rearranged in Equation 5 for output current.

$$T_J = T_A + (R_{\theta JA} \times P_D) \tag{4}$$

$$I_{OUT} = (T_J - T_A) / [R_{\theta JA} \times (V_{IN} - V_{OUT})] \tag{5}$$

Unfortunately, this thermal resistance ( $R_{\theta JA}$ ) is highly dependent on the heat-spreading capability built into the particular PCB design, and therefore varies according to the total copper area, copper weight, and location of the planes. The  $R_{\theta JA}$  recorded in the *Thermal Information* table is determined by the JEDEC standard, PCB, and copper-spreading area, and is only used as a relative measure of package thermal performance.

#### 8.1.7.1 Estimating Junction Temperature

The JEDEC standard recommends the use of psi ( $\Psi$ ) thermal metrics to estimate the junction temperatures of the LDO when in-circuit on a typical PCB board application. These metrics are not strictly speaking thermal resistances, but rather offer practical and relative means of estimating junction temperatures. These psi metrics are determined to be significantly independent of the copper-spreading area. The key thermal metrics ( $\Psi_{JT}$  and  $\Psi_{JB}$ ) are used in accordance with Equation 6 and are given in the *Thermal Information* table.

$$\Psi_{JT} : T_J = T_T + \Psi_{JT} \times P_D \text{ and } \Psi_{JB} : T_J = T_B + \Psi_{JB} \times P_D$$

where:

- $P_D$  is the power dissipated as explained in Equation 3
  - $T_T$  is the temperature at the center-top of the device package
  - $T_B$  is the PCB surface temperature measured 1 mm from the device package and centered on the package edge
- (6)

#### 8.1.7.2 Recommended Area for Continuous Operation

The operational area of an LDO is limited by the dropout voltage, output current, junction temperature, and input voltage. The recommended area for continuous operation for a linear regulator is shown in Figure 41, and can be separated into the following regions:

- Dropout voltage limits the minimum differential voltage between the input and the output ( $V_{IN} - V_{OUT}$ ) at a given output current level.
- The rated output currents limits the maximum recommended output current level. Exceeding this rating causes the device to fall out of specification.
- The rated junction temperature limits the maximum junction temperature of the device. Exceeding this rating causes the device to fall out of specification and reduces long-term reliability.
  - Equation 5 provides the shape of the slope. The slope is nonlinear because the maximum rated junction temperature of the LDO is controlled by the power dissipation across the LDO, thus when  $V_{IN} - V_{OUT}$  increases, the output current must decrease.
- The rated input voltage range governs both the minimum and maximum of  $V_{IN} - V_{OUT}$ .

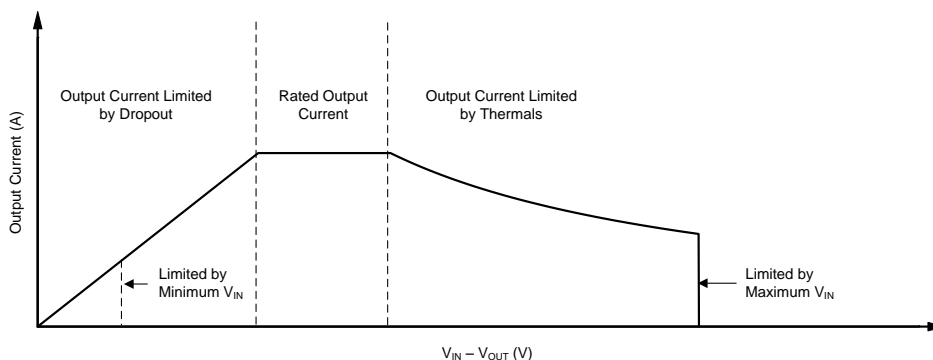

**Figure 41. Region Description of Continuous Operation Regime**

## 8.2 Typical Application

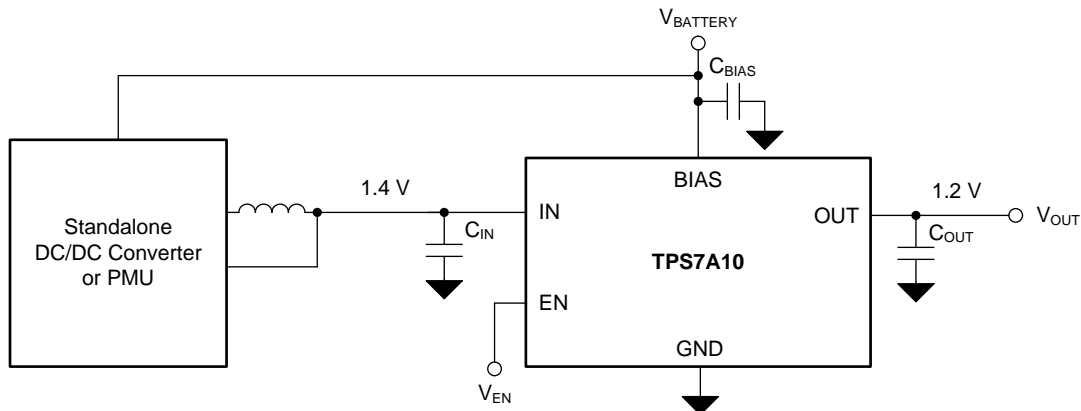

**Figure 42. Supplying a Clean DC Voltage**

### 8.2.1 Design Requirements

Table 2 summarizes the design requirements for Figure 42.

**Table 2. Design Parameters**

DESIGN PARAMETER	EXAMPLE VALUE
$V_{IN}$	1.4 V
$V_{BIAS}$	2.7 V
$V_{OUT}$	1.2 V
$I_{OUT}$	10-mA typical, 300-mA peak
Maximum ambient temperature	65°C

### 8.2.2 Detailed Design Procedure

For this design example, the 1.2-V, fixed-version TPS7A1012 device is selected. Use a 4.7- $\mu$ F input capacitor to minimize transient currents drawn from the DC/DC converter. Use a 4.7- $\mu$ F output capacitor for optimized load transient response. The dropout voltage ( $V_{DO}$ ) is kept within the TPS7A10 dropout voltage specification for the 1.2-V output voltage option in order to keep the device in regulation under all load and temperature conditions for this design. The high-PSRR and low-noise measurements for this design example are given in the [Thermal Dissipation](#) section.

#### 8.2.2.1 Input Current

During normal operation, the input current to the LDO is approximately equal to the output current of the LDO. During startup, the input current is higher as a result of the inrush current charging the output capacitor. Use Equation 7 to calculate the current through the input.

$$I_{OUT(t)} = \left[ \frac{C_{OUT} \times dV_{OUT}(t)}{dt} \right] + \left[ \frac{V_{OUT}(t)}{R_{LOAD}} \right]$$

where:

- $V_{OUT}(t)$  is the instantaneous output voltage of the turnon ramp
- $dV_{OUT}(t) / dt$  is the slope of the  $V_{OUT}$  ramp
- $R_{LOAD}$  is the resistive load impedance

(7)

### 8.2.2.2 Thermal Dissipation

The junction temperature can be determined using the junction-to-ambient thermal resistance ( $R_{\theta JA}$ ) and the total power dissipation ( $P_D$ ). Use Equation 8 to calculate the power dissipation. As Equation 9 shows, multiply  $P_D$  by  $R_{\theta JA}$  and add the ambient temperature ( $T_A$ ) to calculate the junction temperature ( $T_J$ ).

$$P_D = (I_{GND} + I_{OUT}) \times (V_{IN} - V_{OUT}) \tag{8}$$

$$T_J = R_{\theta JA} \times P_D + T_A \tag{9}$$

If the ( $T_{J(MAX)}$ ) value does not exceed 125°C, use Equation 10 to calculate the maximum ambient temperature. Equation 11 calculates the maximum ambient temperature with a value of 99.59°C.

$$T_{A(MAX)} = T_{J(MAX)} - R_{\theta JA} \times P_D \tag{10}$$

$$T_{A(MAX)} = 125^\circ\text{C} - 169.4 \times (1.4\text{ V} - 1.2\text{ V}) \times (0.3\text{ A}) = 114.84^\circ\text{C} \tag{11}$$

### 8.2.3 Application Curve

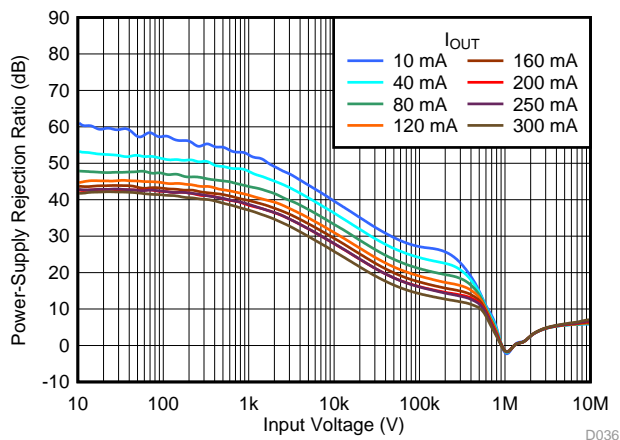

$V_{IN} = 1.4\text{ V}$ ,  $V_{OUT} = 1.2\text{ V}$ ,  $V_{BIAS} = 2.7\text{ V}$ ,  
 $C_{IN} = 4.7\ \mu\text{F}$ ,  $C_{OUT} = 4.7\ \mu\text{F}$ ,  $C_{BIAS} = 0.1\ \mu\text{F}$

**Figure 43. PSRR vs Frequency and  $I_{OUT}$**

## 9 Power Supply Recommendations

This device is designed to operate from an input supply voltage range of 0.75 V to 3.3 V, and a bias supply voltage range of 1.7 V to 5.5 V. The input and bias supplies must be well regulated and free of spurious noise. To make sure that the output voltage is well regulated and dynamic performance is optimum, the input supply must be at least  $V_{OUT(nom)} + 0.5\text{ V}$  and  $V_{BIAS} = V_{OUT(nom)} + 1.05\text{ V}$ .

## 10 Layout

### 10.1 Layout Guidelines

For correct printed circuit board (PCB) layout, follow these guidelines:

- Place input, output, and bias capacitors as close to the device as possible.
- Use copper planes for device connections to optimize thermal performance.
- Place thermal vias around the device to distribute heat.

### 10.2 Layout Examples

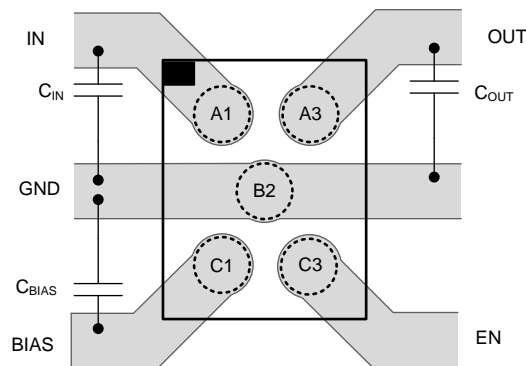

Figure 44. Recommended Layout for the YKA Package

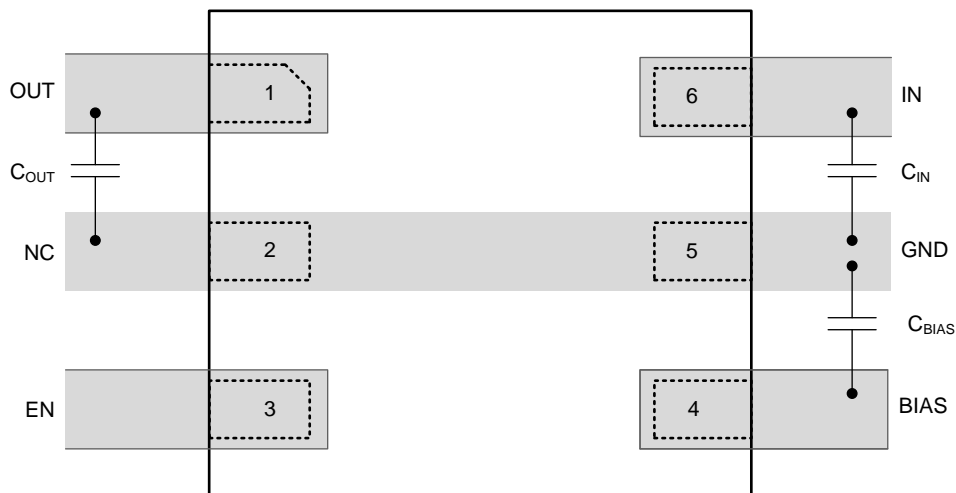

Figure 45. Recommended Layout for the DSE Package



## 11 Device and Documentation Support

### 11.1 Device Support

#### 11.1.1 Development Support

##### 11.1.1.1 Evaluation Module

An evaluation module (EVM) is available to assist in the initial circuit performance evaluation using the TPS7A10. The [TPS7A10EVM](#) can be requested at the Texas Instruments website through the product folders or purchased directly from the [TI eStore](#).

##### 11.1.1.2 Spice Model

Spice models for this device are available through the for the TPS7A10 product folder under the [Tool and Software](#) tab.

#### 11.1.2 Device Nomenclature

**Table 3. Device Nomenclature<sup>(1)(2)</sup>**

PRODUCT	V <sub>OUT</sub>
TPS7A10xx(x)yyyz	<p><b>xx(x)</b> is the nominal output voltage. For output voltages with a resolution of 50 mV, two digits are used in the ordering number; otherwise, three digits are used (for example, 28 = 2.8 V; 125 = 1.25 V).</p> <p><b>yyy</b> is the package designator.</p> <p><b>z</b> is the package quantity. R is for reel, T is for tape.</p>

- (1) For the most current package and ordering information see the Package Option Addendum at the end of this document, or visit the device product folder on [www.ti.com](http://www.ti.com).
- (2) Output voltages from 0.5 V to 3.0 V in 50-mV increments are available. Contact the factory for details and availability.

### 11.2 Documentation Support

#### 11.2.1 Related Documentation

For related documentation see the following:

- Texas Instruments, [TPS7A10EVM-004 Evaluation Module user's guide](#)
- Texas Instruments, [Using New Thermal Metrics application report](#)
- Texas Instruments, [AN-1112 DSBGA Wafer Level Chip Scale Package application report](#)

#### 11.3 Receiving Notification of Documentation Updates

To receive notification of documentation updates, navigate to the device product folder on ti.com. In the upper right corner, click on *Alert me* to register and receive a weekly digest of any product information that has changed. For change details, review the revision history included in any revised document.

#### 11.4 Community Resources

The following links connect to TI community resources. Linked contents are provided "AS IS" by the respective contributors. They do not constitute TI specifications and do not necessarily reflect TI's views; see TI's [Terms of Use](#).

**TI E2E™ Online Community** *TI's Engineer-to-Engineer (E2E) Community*. Created to foster collaboration among engineers. At e2e.ti.com, you can ask questions, share knowledge, explore ideas and help solve problems with fellow engineers.

**Design Support** *TI's Design Support* Quickly find helpful E2E forums along with design support tools and contact information for technical support.

#### 11.5 Trademarks

E2E is a trademark of Texas Instruments.

All other trademarks are the property of their respective owners.

## 11.6 Electrostatic Discharge Caution



These devices have limited built-in ESD protection. The leads should be shorted together or the device placed in conductive foam during storage or handling to prevent electrostatic damage to the MOS gates.

## 11.7 Glossary

[SLYZ022](#) — *TI Glossary*.

This glossary lists and explains terms, acronyms, and definitions.

## 12 Mechanical, Packaging, and Orderable Information

The following pages include mechanical, packaging, and orderable information. This information is the most current data available for the designated devices. This data is subject to change without notice and revision of this document. For browser-based versions of this data sheet, refer to the left-hand navigation.

**PACKAGING INFORMATION**

Orderable Device	Status (1)	Package Type	Package Drawing	Pins	Package Qty	Eco Plan (2)	Lead finish/ Ball material (6)	MSL Peak Temp (3)	Op Temp (°C)	Device Marking (4/5)	Samples
TPS7A1006PDSER	ACTIVE	WSON	DSE	6	3000	RoHS & Green	NIPDAUAG	Level-1-260C-UNLIM	-40 to 125	EF	<a href="#">Samples</a>
TPS7A1006PDSET	ACTIVE	WSON	DSE	6	250	RoHS & Green	NIPDAUAG	Level-1-260C-UNLIM	-40 to 125	EF	<a href="#">Samples</a>
TPS7A1006PYKAR	ACTIVE	DSBGA	YKA	5	12000	RoHS & Green	SNAGCU	Level-1-260C-UNLIM	-40 to 125	T	<a href="#">Samples</a>
TPS7A1008PDSER	ACTIVE	WSON	DSE	6	3000	RoHS & Green	NIPDAUAG	Level-1-260C-UNLIM	-40 to 125	E2	<a href="#">Samples</a>
TPS7A1008PDSET	ACTIVE	WSON	DSE	6	250	RoHS & Green	NIPDAUAG	Level-1-260C-UNLIM	-40 to 125	E2	<a href="#">Samples</a>
TPS7A1008PYKAR	ACTIVE	DSBGA	YKA	5	12000	RoHS & Green	SNAGCU	Level-1-260C-UNLIM	-40 to 125	A	<a href="#">Samples</a>
TPS7A10105PDSER	ACTIVE	WSON	DSE	6	3000	RoHS & Green	NIPDAUAG	Level-1-260C-UNLIM	-40 to 125	DZ	<a href="#">Samples</a>
TPS7A10105PDSET	ACTIVE	WSON	DSE	6	250	RoHS & Green	NIPDAUAG	Level-1-260C-UNLIM	-40 to 125	DZ	<a href="#">Samples</a>
TPS7A10105PYKAR	ACTIVE	DSBGA	YKA	5	12000	RoHS & Green	SNAGCU	Level-1-260C-UNLIM	-40 to 125	C	<a href="#">Samples</a>
TPS7A1010PDSER	ACTIVE	WSON	DSE	6	3000	RoHS & Green	NIPDAUAG	Level-1-260C-UNLIM	-40 to 125	E1	<a href="#">Samples</a>
TPS7A1010PDSET	ACTIVE	WSON	DSE	6	250	RoHS & Green	NIPDAUAG	Level-1-260C-UNLIM	-40 to 125	E1	<a href="#">Samples</a>
TPS7A1010PYKAR	ACTIVE	DSBGA	YKA	5	12000	RoHS & Green	SNAGCU	Level-1-260C-UNLIM	-40 to 125	B	<a href="#">Samples</a>
TPS7A1011PDSER	ACTIVE	WSON	DSE	6	3000	RoHS & Green	NIPDAUAG	Level-1-260C-UNLIM	-40 to 125	DX	<a href="#">Samples</a>
TPS7A1011PDSET	ACTIVE	WSON	DSE	6	250	RoHS & Green	NIPDAUAG	Level-1-260C-UNLIM	-40 to 125	DX	<a href="#">Samples</a>
TPS7A1011PYKAR	ACTIVE	DSBGA	YKA	5	12000	RoHS & Green	SNAGCU	Level-1-260C-UNLIM	-40 to 125	D	<a href="#">Samples</a>
TPS7A1012PDSER	ACTIVE	WSON	DSE	6	3000	RoHS & Green	NIPDAUAG	Level-1-260C-UNLIM	-40 to 125	DW	<a href="#">Samples</a>
TPS7A1012PDSET	ACTIVE	WSON	DSE	6	250	RoHS & Green	NIPDAUAG	Level-1-260C-UNLIM	-40 to 125	DW	<a href="#">Samples</a>
TPS7A1012PYKAR	ACTIVE	DSBGA	YKA	5	12000	RoHS & Green	SNAGCU	Level-1-260C-UNLIM	-40 to 125	E	<a href="#">Samples</a>
TPS7A1015PDSER	ACTIVE	WSON	DSE	6	3000	RoHS & Green	NIPDAUAG	Level-1-260C-UNLIM	-40 to 125	DV	<a href="#">Samples</a>
TPS7A1015PDSET	ACTIVE	WSON	DSE	6	250	RoHS & Green	NIPDAUAG	Level-1-260C-UNLIM	-40 to 125	DV	<a href="#">Samples</a>

Orderable Device	Status (1)	Package Type	Package Drawing	Pins	Package Qty	Eco Plan (2)	Lead finish/ Ball material (6)	MSL Peak Temp (3)	Op Temp (°C)	Device Marking (4/5)	Samples
TPS7A1015PYKAR	ACTIVE	DSBGA	YKA	5	12000	RoHS & Green	SNAGCU	Level-1-260C-UNLIM	-40 to 125	F	<a href="#">Samples</a>
TPS7A1018PDSER	ACTIVE	WSON	DSE	6	3000	RoHS & Green	NIPDAUAG	Level-1-260C-UNLIM	-40 to 125	DU	<a href="#">Samples</a>
TPS7A1018PDSET	ACTIVE	WSON	DSE	6	250	RoHS & Green	NIPDAUAG	Level-1-260C-UNLIM	-40 to 125	DU	<a href="#">Samples</a>
TPS7A1018PYKAR	ACTIVE	DSBGA	YKA	5	12000	RoHS & Green	SNAGCU	Level-1-260C-UNLIM	-40 to 125	G	<a href="#">Samples</a>
TPS7A1025PDSER	ACTIVE	WSON	DSE	6	3000	RoHS & Green	NIPDAUAG	Level-1-260C-UNLIM	-40 to 125	DT	<a href="#">Samples</a>
TPS7A1025PDSET	ACTIVE	WSON	DSE	6	250	RoHS & Green	NIPDAUAG	Level-1-260C-UNLIM	-40 to 125	DT	<a href="#">Samples</a>
TPS7A1025PYKAR	ACTIVE	DSBGA	YKA	5	12000	RoHS & Green	SNAGCU	Level-1-260C-UNLIM	-40 to 125	H	<a href="#">Samples</a>
TPS7A1028PDSER	ACTIVE	WSON	DSE	6	3000	RoHS & Green	NIPDAUAG	Level-1-260C-UNLIM	-40 to 125	DS	<a href="#">Samples</a>
TPS7A1028PDSET	ACTIVE	WSON	DSE	6	250	RoHS & Green	NIPDAUAG	Level-1-260C-UNLIM	-40 to 125	DS	<a href="#">Samples</a>
TPS7A1028PYKAR	ACTIVE	DSBGA	YKA	5	12000	RoHS & Green	SNAGCU	Level-1-260C-UNLIM	-40 to 125	I	<a href="#">Samples</a>
TPS7A1030PDSER	ACTIVE	WSON	DSE	6	3000	RoHS & Green	NIPDAUAG	Level-1-260C-UNLIM	-40 to 125	DR	<a href="#">Samples</a>
TPS7A1030PDSET	ACTIVE	WSON	DSE	6	250	RoHS & Green	NIPDAUAG	Level-1-260C-UNLIM	-40 to 125	DR	<a href="#">Samples</a>
TPS7A1030PYKAR	ACTIVE	DSBGA	YKA	5	12000	RoHS & Green	SNAGCU	Level-1-260C-UNLIM	-40 to 125	J	<a href="#">Samples</a>

(1) The marketing status values are defined as follows:

**ACTIVE:** Product device recommended for new designs.

**LIFEBUY:** TI has announced that the device will be discontinued, and a lifetime-buy period is in effect.

**NRND:** Not recommended for new designs. Device is in production to support existing customers, but TI does not recommend using this part in a new design.

**PREVIEW:** Device has been announced but is not in production. Samples may or may not be available.

**OBSELETE:** TI has discontinued the production of the device.

(2) **RoHS:** TI defines "RoHS" to mean semiconductor products that are compliant with the current EU RoHS requirements for all 10 RoHS substances, including the requirement that RoHS substance do not exceed 0.1% by weight in homogeneous materials. Where designed to be soldered at high temperatures, "RoHS" products are suitable for use in specified lead-free processes. TI may reference these types of products as "Pb-Free".

**RoHS Exempt:** TI defines "RoHS Exempt" to mean products that contain lead but are compliant with EU RoHS pursuant to a specific EU RoHS exemption.

**Green:** TI defines "Green" to mean the content of Chlorine (Cl) and Bromine (Br) based flame retardants meet JS709B low halogen requirements of <=1000ppm threshold. Antimony trioxide based flame retardants must also meet the <=1000ppm threshold requirement.

- (3) MSL, Peak Temp. - The Moisture Sensitivity Level rating according to the JEDEC industry standard classifications, and peak solder temperature.
- (4) There may be additional marking, which relates to the logo, the lot trace code information, or the environmental category on the device.
- (5) Multiple Device Markings will be inside parentheses. Only one Device Marking contained in parentheses and separated by a "~" will appear on a device. If a line is indented then it is a continuation of the previous line and the two combined represent the entire Device Marking for that device.
- (6) Lead finish/Ball material - Orderable Devices may have multiple material finish options. Finish options are separated by a vertical ruled line. Lead finish/Ball material values may wrap to two lines if the finish value exceeds the maximum column width.

**Important Information and Disclaimer:**The information provided on this page represents TI's knowledge and belief as of the date that it is provided. TI bases its knowledge and belief on information provided by third parties, and makes no representation or warranty as to the accuracy of such information. Efforts are underway to better integrate information from third parties. TI has taken and continues to take reasonable steps to provide representative and accurate information but may not have conducted destructive testing or chemical analysis on incoming materials and chemicals. TI and TI suppliers consider certain information to be proprietary, and thus CAS numbers and other limited information may not be available for release.

In no event shall TI's liability arising out of such information exceed the total purchase price of the TI part(s) at issue in this document sold by TI to Customer on an annual basis.

**TAPE AND REEL INFORMATION**

**QUADRANT ASSIGNMENTS FOR PIN 1 ORIENTATION IN TAPE**

\*All dimensions are nominal

Device	Package Type	Package Drawing	Pins	SPQ	Reel Diameter (mm)	Reel Width W1 (mm)	A0 (mm)	B0 (mm)	K0 (mm)	P1 (mm)	W (mm)	Pin1 Quadrant
TPS7A1006PDSEER	WSO	DSE	6	3000	180.0	8.4	1.83	1.83	0.89	4.0	8.0	Q2
TPS7A1006PDSET	WSO	DSE	6	250	180.0	8.4	1.83	1.83	0.89	4.0	8.0	Q2
TPS7A1006PYKAR	DSBGA	YKA	5	12000	180.0	8.4	0.9	1.25	0.48	2.0	8.0	Q1
TPS7A1008PDSEER	WSO	DSE	6	3000	180.0	8.4	1.83	1.83	0.89	4.0	8.0	Q2
TPS7A1008PDSET	WSO	DSE	6	250	180.0	8.4	1.83	1.83	0.89	4.0	8.0	Q2
TPS7A1008PYKAR	DSBGA	YKA	5	12000	180.0	8.4	0.9	1.25	0.48	2.0	8.0	Q1
TPS7A10105PDSEER	WSO	DSE	6	3000	180.0	8.4	1.83	1.83	0.89	4.0	8.0	Q2
TPS7A10105PDSET	WSO	DSE	6	250	180.0	8.4	1.83	1.83	0.89	4.0	8.0	Q2
TPS7A10105PYKAR	DSBGA	YKA	5	12000	180.0	8.4	0.9	1.25	0.48	2.0	8.0	Q1
TPS7A1010PDSEER	WSO	DSE	6	3000	180.0	8.4	1.83	1.83	0.89	4.0	8.0	Q2
TPS7A1010PDSET	WSO	DSE	6	250	180.0	8.4	1.83	1.83	0.89	4.0	8.0	Q2
TPS7A1010PYKAR	DSBGA	YKA	5	12000	180.0	8.4	0.9	1.25	0.48	2.0	8.0	Q1
TPS7A1011PDSEER	WSO	DSE	6	3000	180.0	8.4	1.83	1.83	0.89	4.0	8.0	Q2
TPS7A1011PDSET	WSO	DSE	6	250	180.0	8.4	1.83	1.83	0.89	4.0	8.0	Q2
TPS7A1011PYKAR	DSBGA	YKA	5	12000	180.0	8.4	0.9	1.25	0.48	2.0	8.0	Q1
TPS7A1012PDSEER	WSO	DSE	6	3000	180.0	8.4	1.83	1.83	0.89	4.0	8.0	Q2

Device	Package Type	Package Drawing	Pins	SPQ	Reel Diameter (mm)	Reel Width W1 (mm)	A0 (mm)	B0 (mm)	K0 (mm)	P1 (mm)	W (mm)	Pin1 Quadrant
TPS7A1012PDSET	WSON	DSE	6	250	180.0	8.4	1.83	1.83	0.89	4.0	8.0	Q2
TPS7A1012PYKAR	DSBGA	YKA	5	12000	180.0	8.4	0.9	1.25	0.48	2.0	8.0	Q1
TPS7A1015PDSE	WSON	DSE	6	3000	180.0	8.4	1.83	1.83	0.89	4.0	8.0	Q2
TPS7A1015PDSET	WSON	DSE	6	250	180.0	8.4	1.83	1.83	0.89	4.0	8.0	Q2
TPS7A1015PYKAR	DSBGA	YKA	5	12000	180.0	8.4	0.9	1.25	0.48	2.0	8.0	Q1
TPS7A1018PDSE	WSON	DSE	6	3000	180.0	8.4	1.83	1.83	0.89	4.0	8.0	Q2
TPS7A1018PDSET	WSON	DSE	6	250	180.0	8.4	1.83	1.83	0.89	4.0	8.0	Q2
TPS7A1018PYKAR	DSBGA	YKA	5	12000	180.0	8.4	0.9	1.25	0.48	2.0	8.0	Q1
TPS7A1025PDSE	WSON	DSE	6	3000	180.0	8.4	1.83	1.83	0.89	4.0	8.0	Q2
TPS7A1025PDSET	WSON	DSE	6	250	180.0	8.4	1.83	1.83	0.89	4.0	8.0	Q2
TPS7A1025PYKAR	DSBGA	YKA	5	12000	180.0	8.4	0.9	1.25	0.48	2.0	8.0	Q1
TPS7A1028PDSE	WSON	DSE	6	3000	180.0	8.4	1.83	1.83	0.89	4.0	8.0	Q2
TPS7A1028PDSET	WSON	DSE	6	250	180.0	8.4	1.83	1.83	0.89	4.0	8.0	Q2
TPS7A1028PYKAR	DSBGA	YKA	5	12000	180.0	8.4	0.9	1.25	0.48	2.0	8.0	Q1
TPS7A1030PDSE	WSON	DSE	6	3000	180.0	8.4	1.83	1.83	0.89	4.0	8.0	Q2
TPS7A1030PDSET	WSON	DSE	6	250	180.0	8.4	1.83	1.83	0.89	4.0	8.0	Q2
TPS7A1030PYKAR	DSBGA	YKA	5	12000	180.0	8.4	0.9	1.25	0.48	2.0	8.0	Q1

**TAPE AND REEL BOX DIMENSIONS**



\*All dimensions are nominal

Device	Package Type	Package Drawing	Pins	SPQ	Length (mm)	Width (mm)	Height (mm)
TPS7A1006PDSER	WSON	DSE	6	3000	183.0	183.0	20.0
TPS7A1006PDSET	WSON	DSE	6	250	183.0	183.0	20.0
TPS7A1006PYKAR	DSBGA	YKA	5	12000	182.0	182.0	20.0
TPS7A1008PDSER	WSON	DSE	6	3000	183.0	183.0	20.0
TPS7A1008PDSET	WSON	DSE	6	250	183.0	183.0	20.0
TPS7A1008PYKAR	DSBGA	YKA	5	12000	182.0	182.0	20.0
TPS7A10105PDSER	WSON	DSE	6	3000	183.0	183.0	20.0
TPS7A10105PDSET	WSON	DSE	6	250	183.0	183.0	20.0
TPS7A10105PYKAR	DSBGA	YKA	5	12000	182.0	182.0	20.0
TPS7A1010PDSER	WSON	DSE	6	3000	183.0	183.0	20.0
TPS7A1010PDSET	WSON	DSE	6	250	183.0	183.0	20.0
TPS7A1010PYKAR	DSBGA	YKA	5	12000	182.0	182.0	20.0
TPS7A1011PDSER	WSON	DSE	6	3000	183.0	183.0	20.0
TPS7A1011PDSET	WSON	DSE	6	250	183.0	183.0	20.0
TPS7A1011PYKAR	DSBGA	YKA	5	12000	182.0	182.0	20.0
TPS7A1012PDSER	WSON	DSE	6	3000	183.0	183.0	20.0
TPS7A1012PDSET	WSON	DSE	6	250	183.0	183.0	20.0
TPS7A1012PYKAR	DSBGA	YKA	5	12000	182.0	182.0	20.0

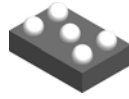

Device	Package Type	Package Drawing	Pins	SPQ	Length (mm)	Width (mm)	Height (mm)
TPS7A1015PDSER	WSON	DSE	6	3000	183.0	183.0	20.0
TPS7A1015PDSET	WSON	DSE	6	250	183.0	183.0	20.0
TPS7A1015PYKAR	DSBGA	YKA	5	12000	182.0	182.0	20.0
TPS7A1018PDSER	WSON	DSE	6	3000	183.0	183.0	20.0
TPS7A1018PDSET	WSON	DSE	6	250	183.0	183.0	20.0
TPS7A1018PYKAR	DSBGA	YKA	5	12000	182.0	182.0	20.0
TPS7A1025PDSER	WSON	DSE	6	3000	183.0	183.0	20.0
TPS7A1025PDSET	WSON	DSE	6	250	183.0	183.0	20.0
TPS7A1025PYKAR	DSBGA	YKA	5	12000	182.0	182.0	20.0
TPS7A1028PDSER	WSON	DSE	6	3000	183.0	183.0	20.0
TPS7A1028PDSET	WSON	DSE	6	250	183.0	183.0	20.0
TPS7A1028PYKAR	DSBGA	YKA	5	12000	182.0	182.0	20.0
TPS7A1030PDSER	WSON	DSE	6	3000	183.0	183.0	20.0
TPS7A1030PDSET	WSON	DSE	6	250	183.0	183.0	20.0
TPS7A1030PYKAR	DSBGA	YKA	5	12000	182.0	182.0	20.0

YKA0005



# PACKAGE OUTLINE

## DSBGA - 0.4 mm max height

DIE SIZE BALL GRID ARRAY

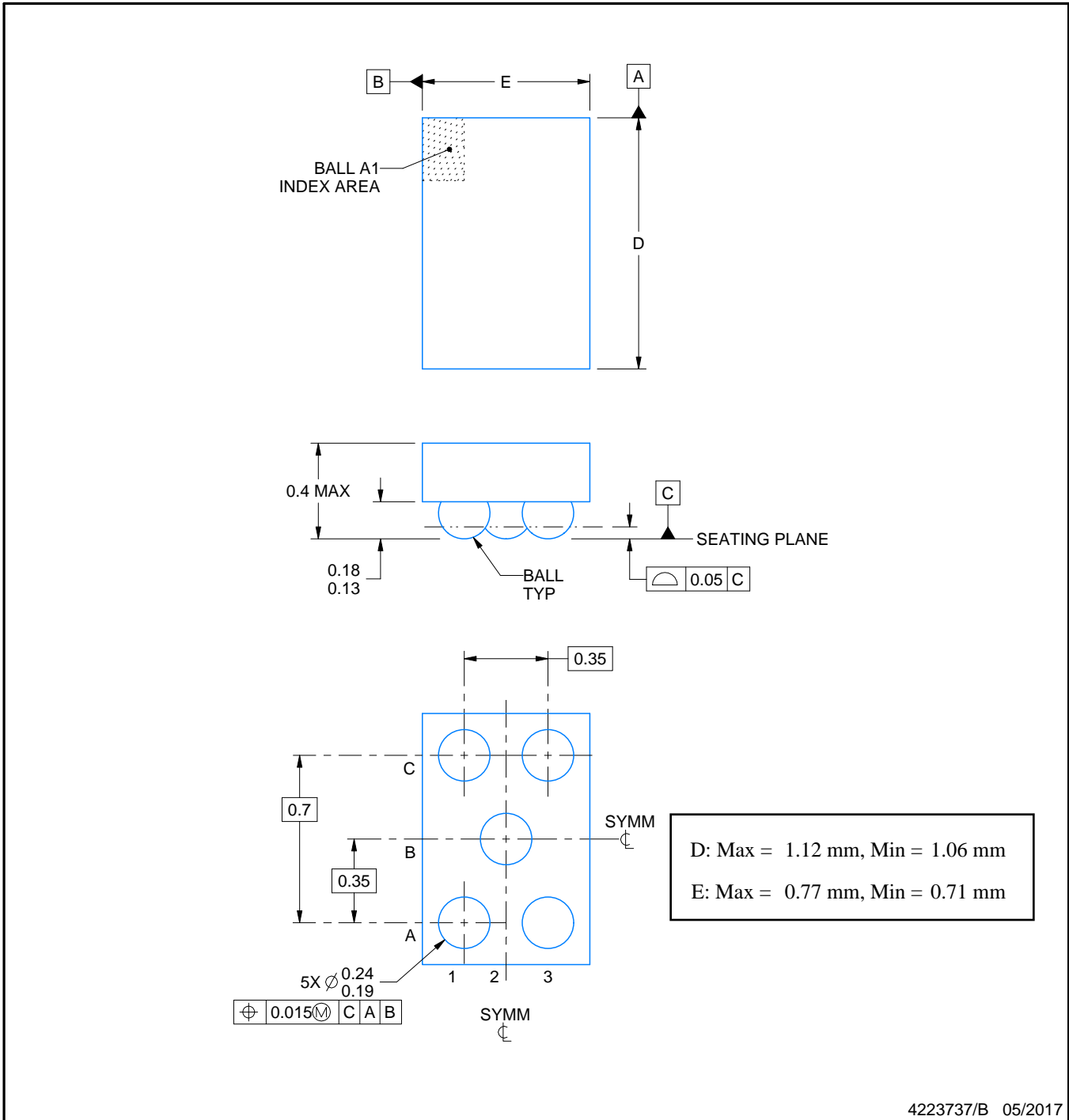

NOTES:

NanoFree is a trademark of Texas Instruments.

1. All linear dimensions are in millimeters. Any dimensions in parenthesis are for reference only. Dimensioning and tolerancing per ASME Y14.5M.
2. This drawing is subject to change without notice.
3. NanoFree™ package configuration.

# EXAMPLE BOARD LAYOUT

YKA0005

DSBGA - 0.4 mm max height

DIE SIZE BALL GRID ARRAY

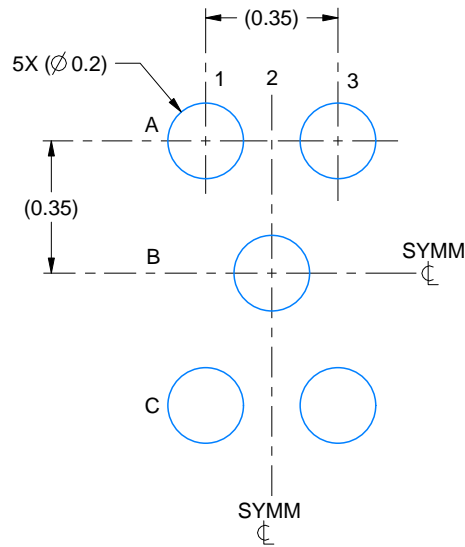

LAND PATTERN EXAMPLE  
EXPOSED METAL SHOWN  
SCALE:50X

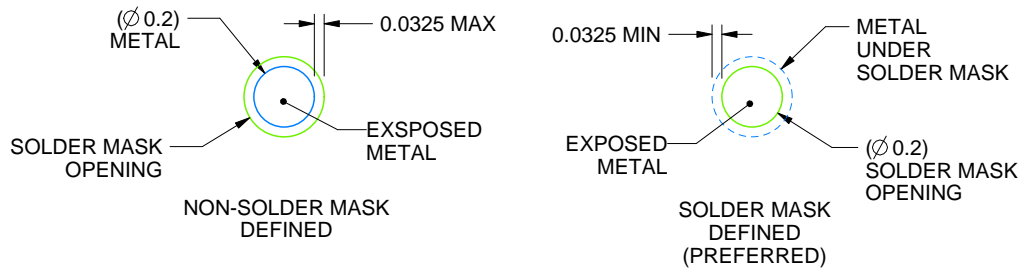

SOLDER MASK DETAILS  
NOT TO SCALE

4223737/B 05/2017

NOTES: (continued)

- Final dimensions may vary due to manufacturing tolerance considerations and also routing constraints. For more information, see Texas Instruments literature number SNVA009 ([www.ti.com/lit/snva009](http://www.ti.com/lit/snva009)).

# EXAMPLE STENCIL DESIGN

YKA0005

DSBGA - 0.4 mm max height

DIE SIZE BALL GRID ARRAY

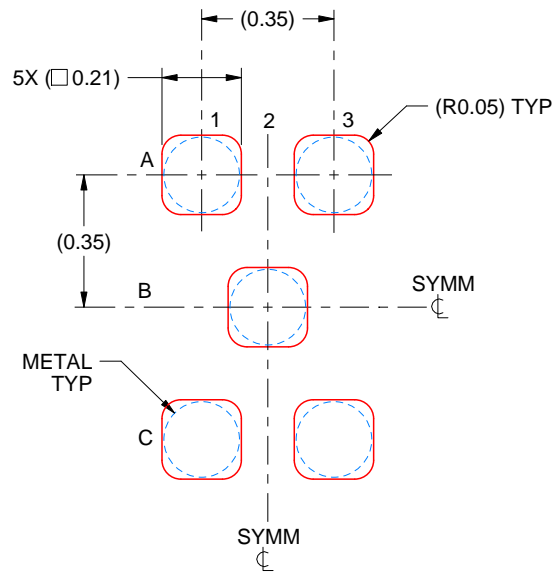

SOLDER PASTE EXAMPLE  
BASED ON 0.075 mm - 0.1 mm THICK STENCIL  
SCALE:50X

4223737/B 05/2017

NOTES: (continued)

5. Laser cutting apertures with trapezoidal walls and rounded corners may offer better paste release.

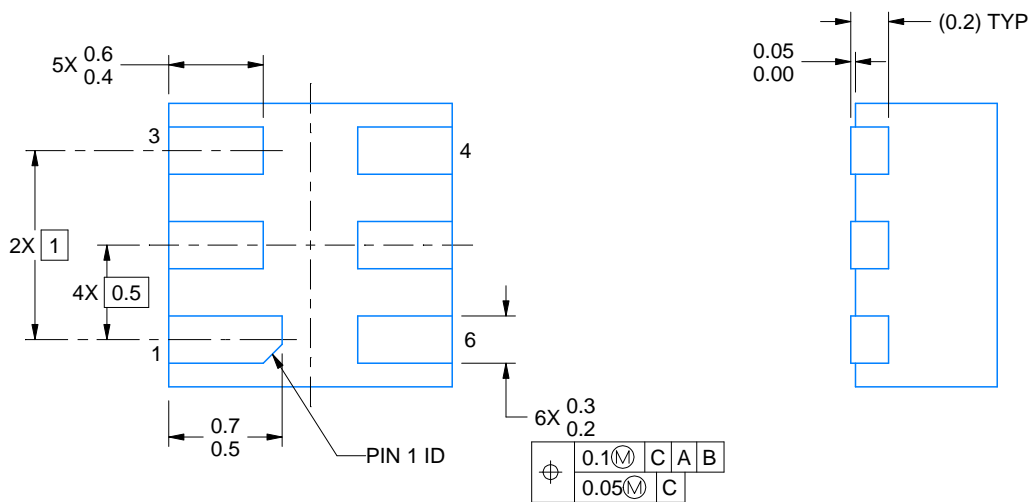
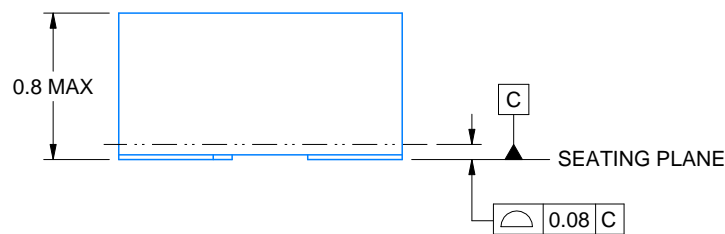
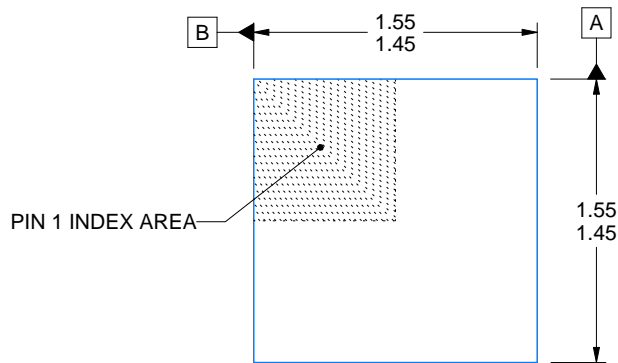

4220552/B 01/2024

NOTES:

1. All linear dimensions are in millimeters. Any dimensions in parenthesis are for reference only. Dimensioning and tolerancing per ASME Y14.5M.
2. This drawing is subject to change without notice.

# EXAMPLE BOARD LAYOUT

DSE0006A

WSON - 0.8 mm max height

PLASTIC SMALL OUTLINE - NO LEAD

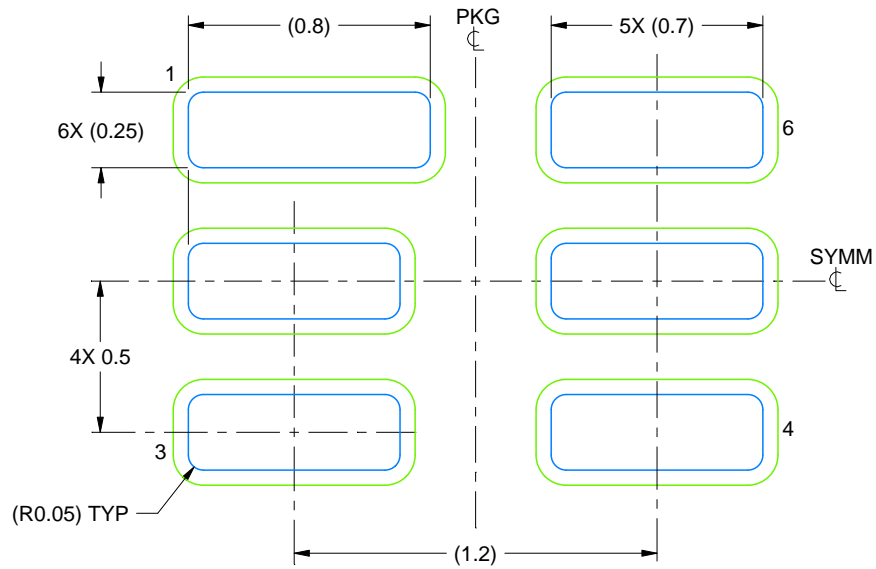

LAND PATTERN EXAMPLE  
SCALE:40X

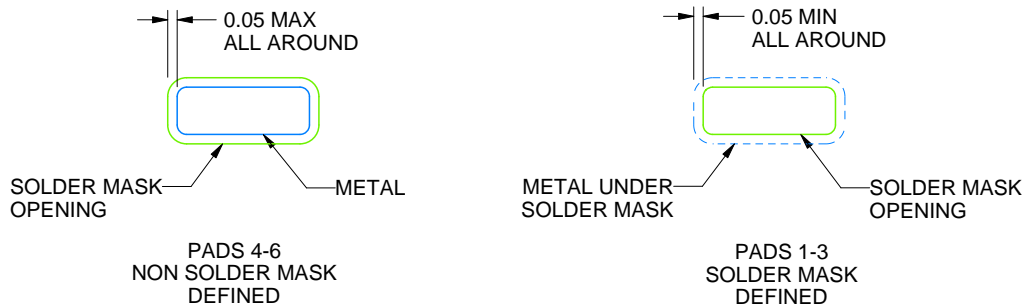

SOLDER MASK DETAILS

4220552/B 01/2024

NOTES: (continued)

3. For more information, see Texas Instruments literature number SLUA271 ([www.ti.com/lit/slua271](http://www.ti.com/lit/slua271)).

# EXAMPLE STENCIL DESIGN

DSE0006A

WSON - 0.8 mm max height

PLASTIC SMALL OUTLINE - NO LEAD

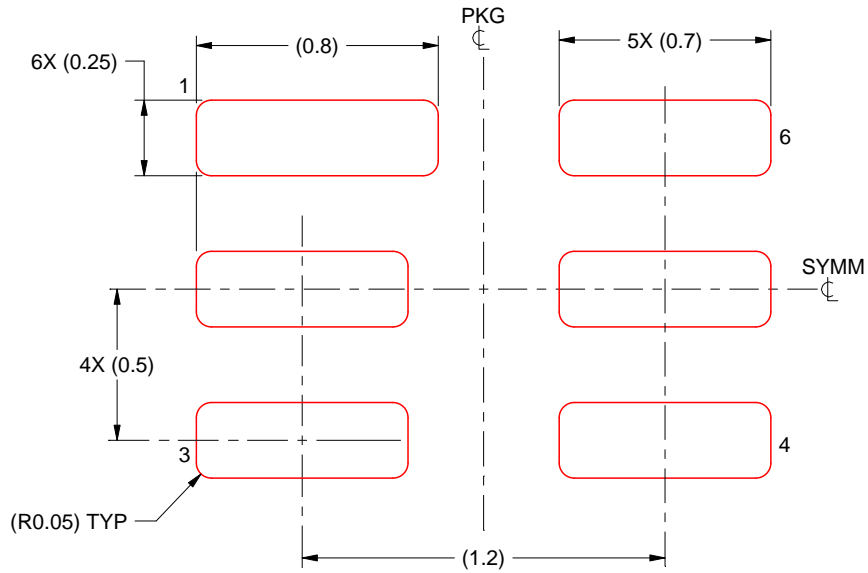

SOLDER PASTE EXAMPLE  
BASED ON 0.125 mm THICK STENCIL  
SCALE:40X

NOTES: (continued)

4. Laser cutting apertures with trapezoidal walls and rounded corners may offer better paste release. IPC-7525 may have alternate design recommendations.

## IMPORTANT NOTICE AND DISCLAIMER

TI PROVIDES TECHNICAL AND RELIABILITY DATA (INCLUDING DATA SHEETS), DESIGN RESOURCES (INCLUDING REFERENCE DESIGNS), APPLICATION OR OTHER DESIGN ADVICE, WEB TOOLS, SAFETY INFORMATION, AND OTHER RESOURCES "AS IS" AND WITH ALL FAULTS, AND DISCLAIMS ALL WARRANTIES, EXPRESS AND IMPLIED, INCLUDING WITHOUT LIMITATION ANY IMPLIED WARRANTIES OF MERCHANTABILITY, FITNESS FOR A PARTICULAR PURPOSE OR NON-INFRINGEMENT OF THIRD PARTY INTELLECTUAL PROPERTY RIGHTS.

These resources are intended for skilled developers designing with TI products. You are solely responsible for (1) selecting the appropriate TI products for your application, (2) designing, validating and testing your application, and (3) ensuring your application meets applicable standards, and any other safety, security, regulatory or other requirements.

These resources are subject to change without notice. TI grants you permission to use these resources only for development of an application that uses the TI products described in the resource. Other reproduction and display of these resources is prohibited. No license is granted to any other TI intellectual property right or to any third party intellectual property right. TI disclaims responsibility for, and you will fully indemnify TI and its representatives against, any claims, damages, costs, losses, and liabilities arising out of your use of these resources.

TI's products are provided subject to [TI's Terms of Sale](#) or other applicable terms available either on [ti.com](https://www.ti.com) or provided in conjunction with such TI products. TI's provision of these resources does not expand or otherwise alter TI's applicable warranties or warranty disclaimers for TI products.

TI objects to and rejects any additional or different terms you may have proposed.

Mailing Address: Texas Instruments, Post Office Box 655303, Dallas, Texas 75265

Copyright © 2025, Texas Instruments Incorporated