

Stable Light Source for Calibration of TI Ambient Light Sensors



Description

The LIGHTSOURCE01EVM is a stable uniform light source used for the calibration of ambient light sensors (ALS) and color sensors. This light source is designed to be used in production environments to calibrate and test final products containing TI light sensors. This stabilized light source can be used to simulate sunset (4200K CCT) and noon (6400K CCT) lighting modes. The light source serves is uniform and constant with less than $\pm 1\%$ variation in light output over time, and less than $\pm 1\%$ variation in uniformity on a 1 inch diameter area. The illuminance level and modes can be adjusted using the light source EVM GUI on ti.com.

Features

1. Small-form factor
2. Stable and uniform calibration light source
3. USB hardware interface
4. EVM GUI
5. $< \pm 1\%$ light output variation



Figure 1-1. LIGHTSOURCE01EVM

1 Evaluation Module Overview

1.1 Introduction

This user's guide describes the characteristics, operation, and use of the light source evaluation module (LIGHTSOURCE01EVM). This user's guide details how to set up the light source including mounting of the light source and requirements for performing calibration such as creating a dark enclosure to block outside light. The guide also covers how to operate the light source including installation of the provided control software and serial command structure for using the light source with custom automation routines. Throughout this document, the terms evaluation board, evaluation module, and EVM are synonymous with the light source EVM (LIGHTSOURCE01EVM). This document also includes the mechanical drawings and parts list for the EVM.

1.2 Kit Contents

[LIGHTSOURCE01EVM Kit Contents](#) summarizes the contents of the LIGHTSOURCE01EVM kit. [Table 1-1](#) shows the included hardware and [Figure 1-1](#) shows the items contained in the box. Contact the nearest [Texas Instruments Product Information Center](#) if any component is missing. TI highly recommends to check the Light Sensor product folder on the TI web site at www.ti.com for the latest versions of the released software.

Table 1-1. LIGHTSOURCE01EVM Kit Contents

Item	Quantity
LIGHTSOURCE01EVM	1
MicroUSB Cable	1



Figure 1-1. LIGHTSOURCE01EVM Kit Contents

1.3 Specifications

Table 1-2. LIGHTSOURCE01EVM Specifications Table

Specification	Test Conditions	Value	Unit
Irradiance 12 inches From Source	Minimum, Noon, and Sunset Setting	600	Lux
	Maximum, Noon Setting	2000	Lux
	Maximum, Sunset Setting	1500	Lux
Correlated Color Temperature (CCT)	Noon Setting	6400	Kelvin
	Sunset Setting	4200	Kelvin
Uniformity 12 Inches From Source	1-Inch Diameter Spot Size, Lux and CCT	±1	%
Light Source Stability	Maximum Light Level, Noon and Sunset Setting	±1	%

The LIGHTSOURCE01EVM is able to replicate sunset and noon lighting spectra. Refer to the following figure for the spectral response of the light source for the sunset and noon modes.

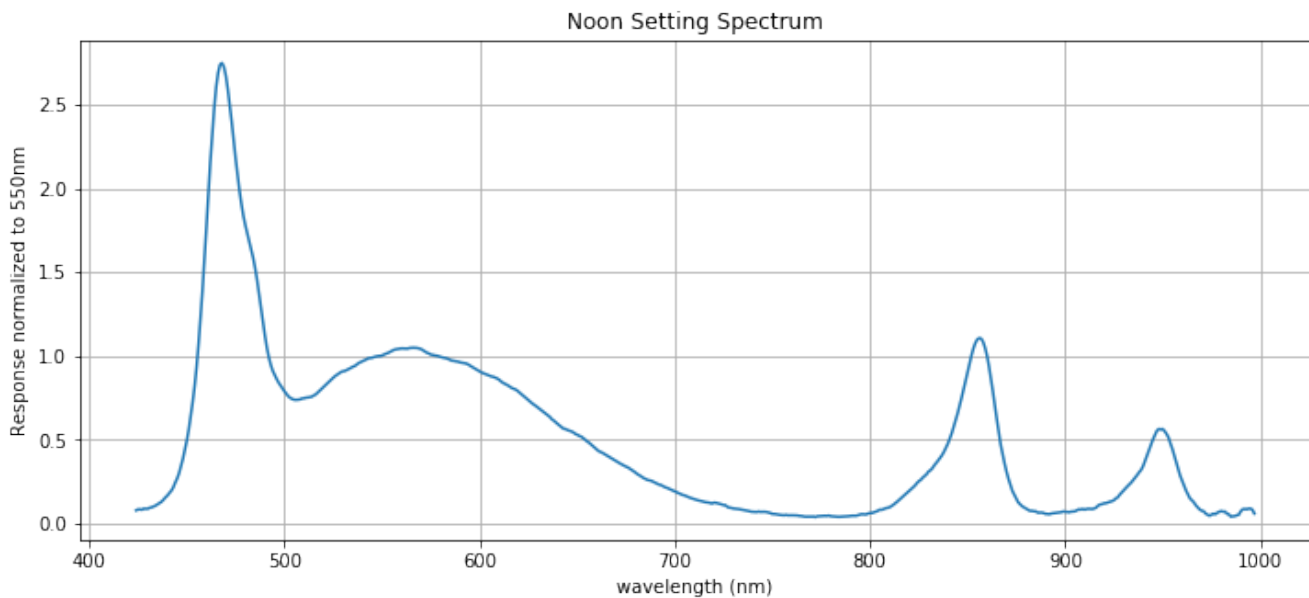

Figure 1-2. Noon Spectral Response

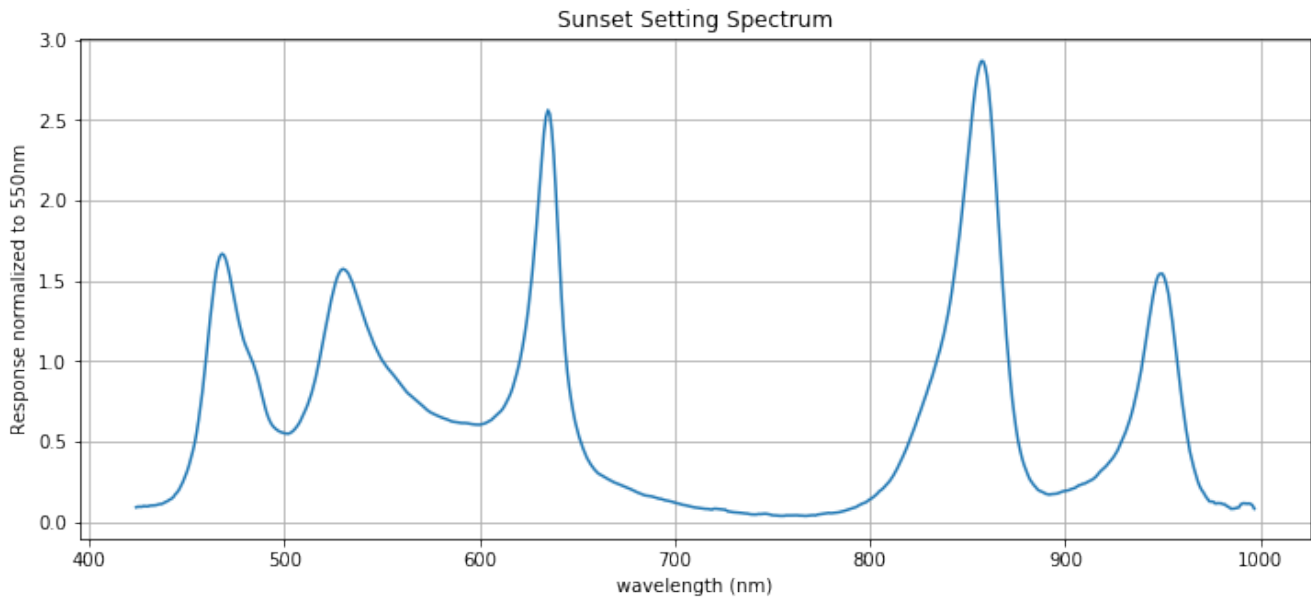

Figure 1-3. Sunset Spectral Response

For both spectra, the EVM is highly stable, with variations in output at maximum intensity kept to $<\pm 1\%$.

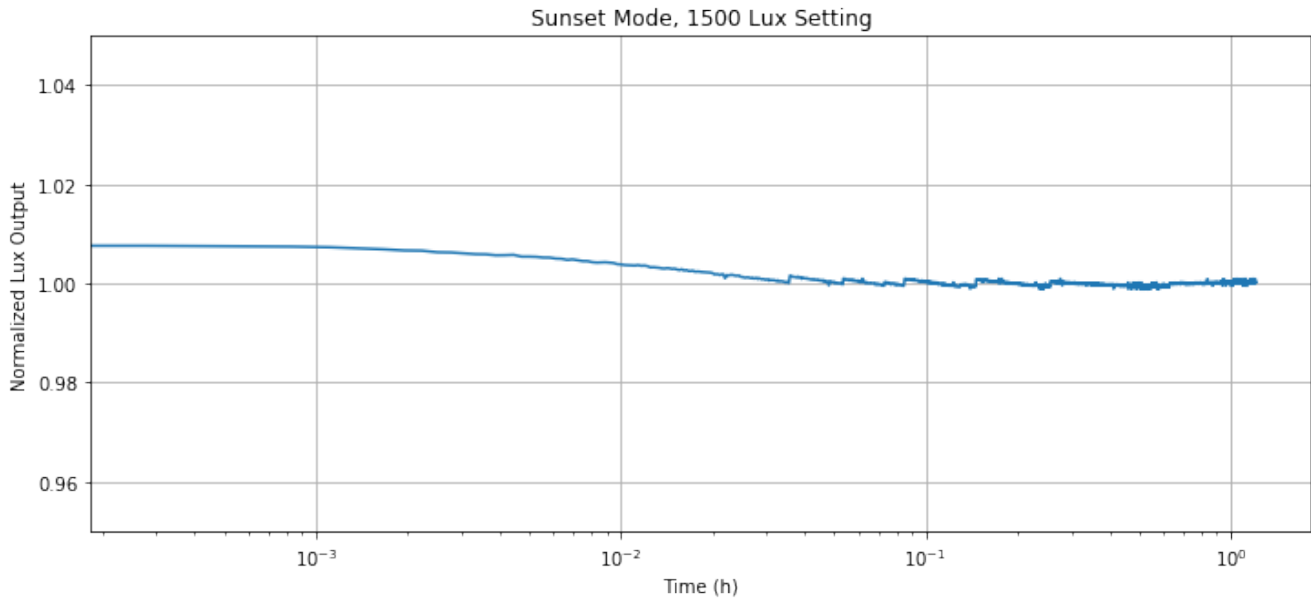

Figure 1-4. Sunset Source Stability

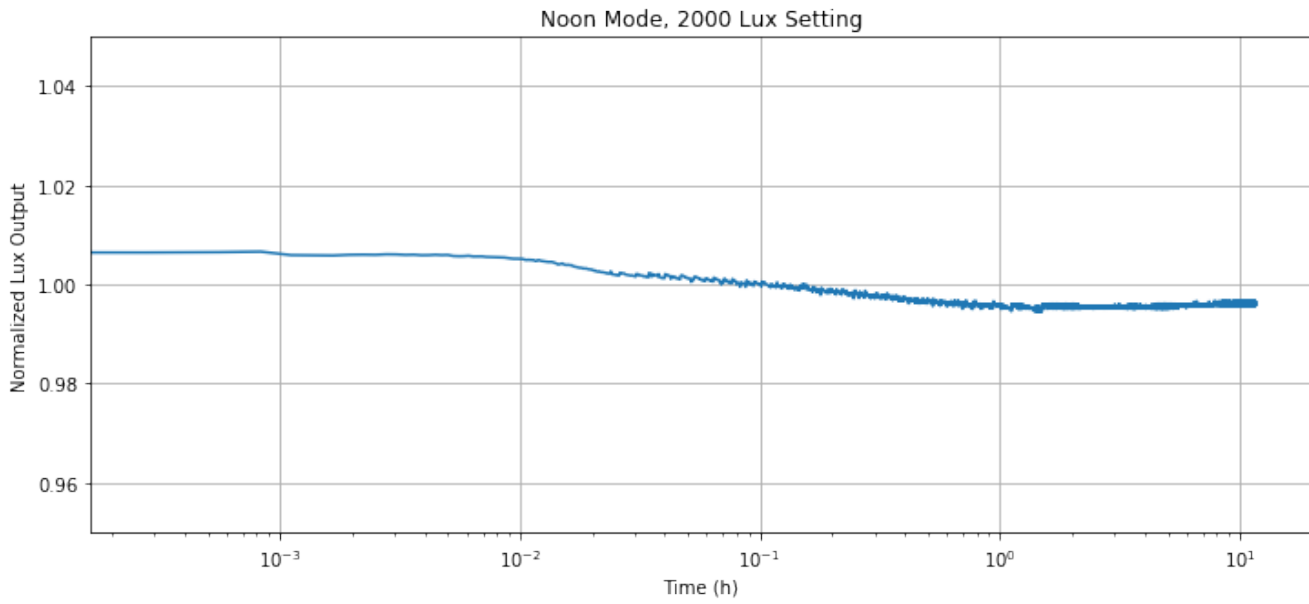

Figure 1-5. Noon Source Stability

The light source also maintains high uniformity, with $\pm 1\%$ variation for a 1 inch diameter spot 12 inches away from the source. This means that the light intensity across the entire spot is consistent, with minimal variation from the center of the spot to the edges. This high uniformity is designed for the calibration of ALS and color sensors, which demand a highly stable and uniform light source.

2 Quick Start Guide

This quick start guide covers both the hardware and software setup for the LIGHTSOURCE01EVM, as well as the instructions for calibrating our OPTxxx light sensors. This guide describes the initial steps to verify that the user can easily configure and use the EVM.

2.1 Hardware Setup

The computer runs the graphical user interface (GUI) software that communicates with the LIGHTSOURCE01EVM over a USB connection. The LIGHTSOURCE01EVM board has a microUSB port and ships with the microUSB cable. The user has to provide the power supply, as the EVM does not ship with a power supply already included. To get started, connect the AC cord to the AC/DC adapter and make the connection from the EVM to a power outlet. Then, plug the microUSB cable to the LIGHTSOURCE01EVM and make the connection to your computer. The hardware connections are shown in [Figure 2-1](#). When plugging in the power and USB cords, plug in the power cord first.

The power supply MUST be 15V only. The calibration light source does not work otherwise. Additionally, must supply up to 3A and have a barrel connector. The outer diameter, inner diameter, and barrel length must be 5.5mm, 2.1mm, and 9.5mm respectively.



Figure 2-1. USB and Power Connections

The LIGHTSOURCE01EVM receives serial commands from the computer that control the brightness of the LEDs and the lighting mode. The EVM ships fully contained, so no assembly is required from the user.

2.2 Software Setup

2.2.1 Hardware Requirements

The LIGHTSOURCE01EVM software has been tested on the Windows 11® operating system (OS) with United States regional settings. The software functions correctly on other Windows XP, Windows Vista, Windows 7, Windows 8, and Windows 10.

2.2.2 Software Installation

The LIGHTSOURCE01EVM software is available through the Light Sensor Product Folder on the TI web site (www.ti.com). To install this software on the computer, navigate to the LIGHTSOURCE01EVM software, which is linked on every light sensor IC product page. Open the installer directory. Launch the installation file, *LIGHTSOURCE01EVM_GUI.exe*.

The OPTEVM software then begins the installation process, as shown in [Figure 2-2](#).

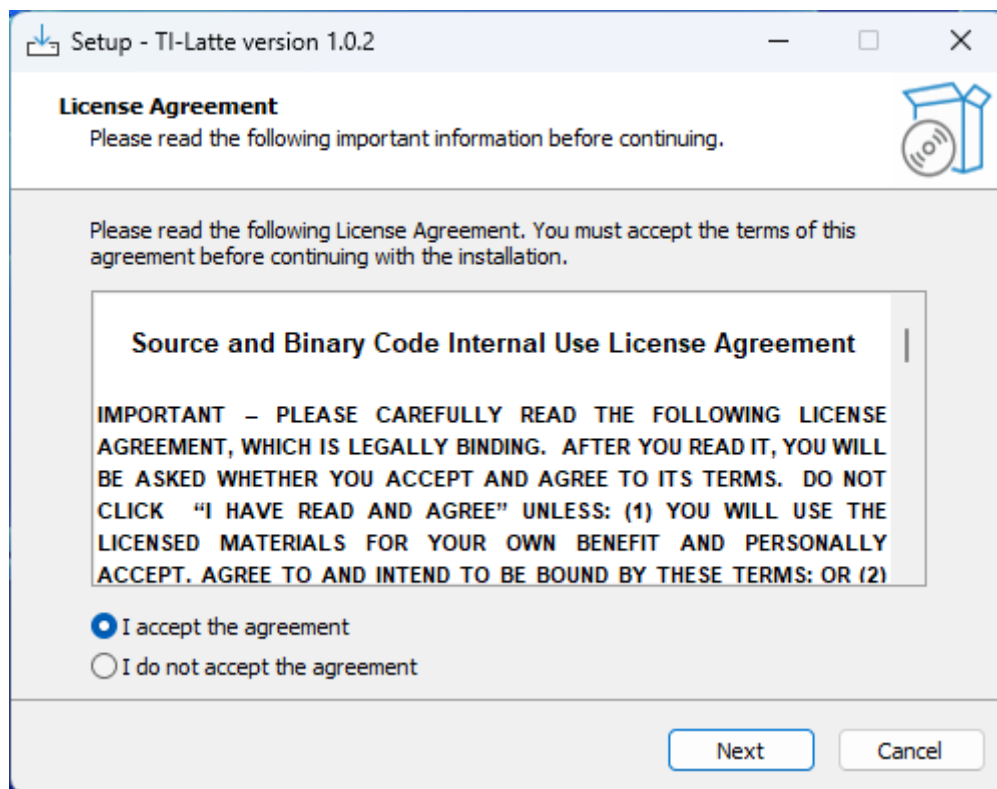

Figure 2-2. LIGHTSOURCE01EVM Software-Installation Launch

Follow the prompts as shown in [Figure 2-3](#) through [Figure 2-5](#) to install the OPTEVM software.

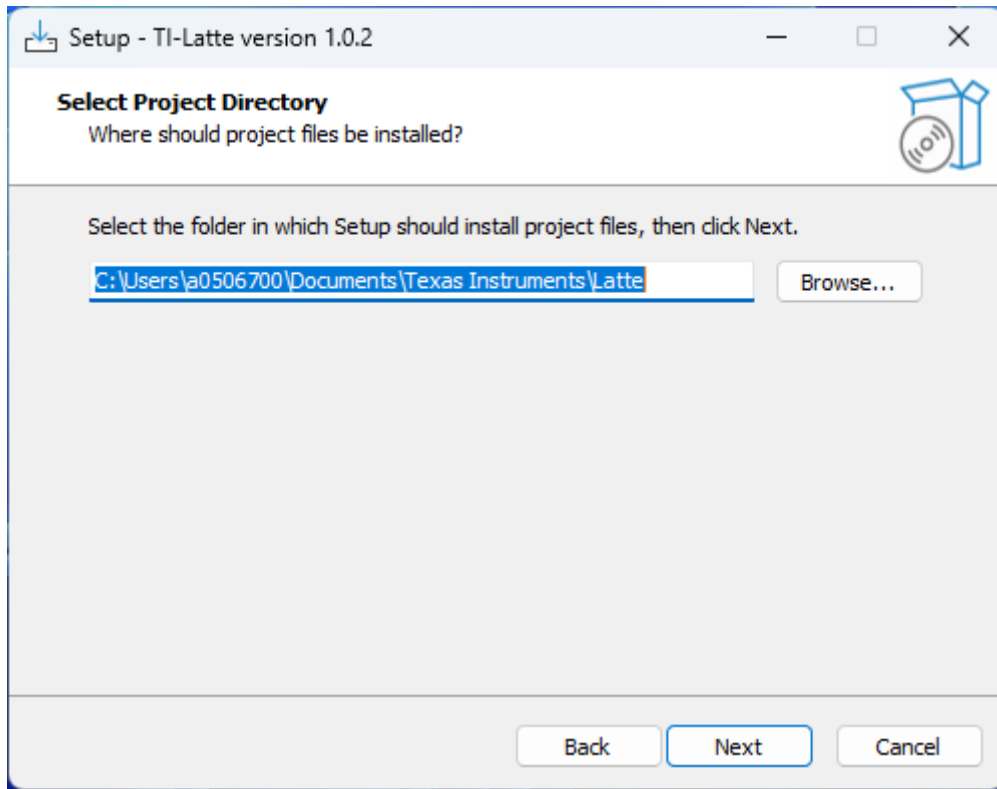

Figure 2-3. Select Project Directory

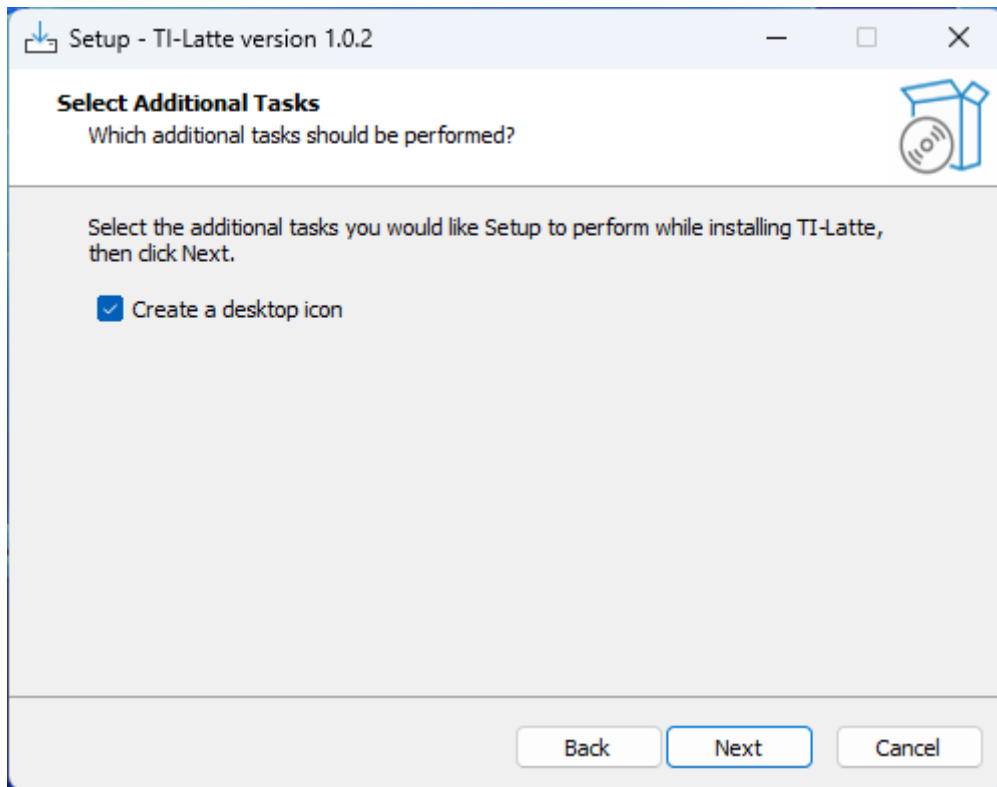

Figure 2-4. Create Desktop Icon

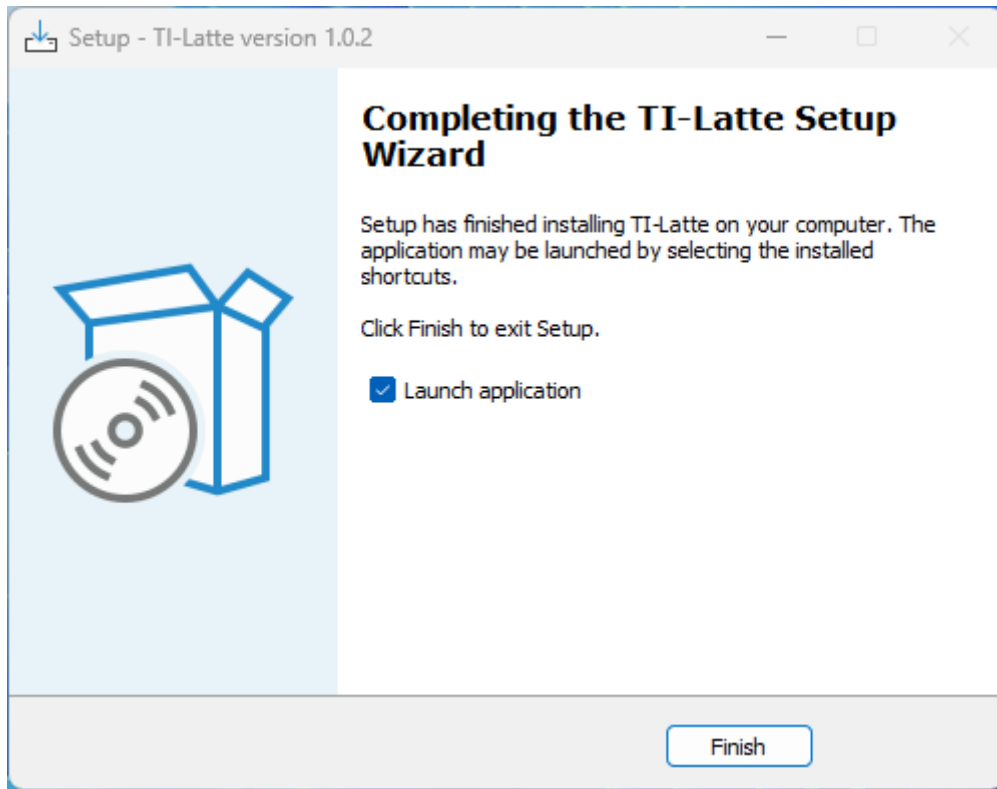

Figure 2-5. Launch Application

2.2.3 Launching the LIGHTSOURCE01EVM Software

With the LIGHTSOURCE01EVM properly connected, launch the Latte LIGHTSOURCE01EVM GUI software from the Windows *Start* menu. The software launches with a screen shown in [Figure 2-6](#).

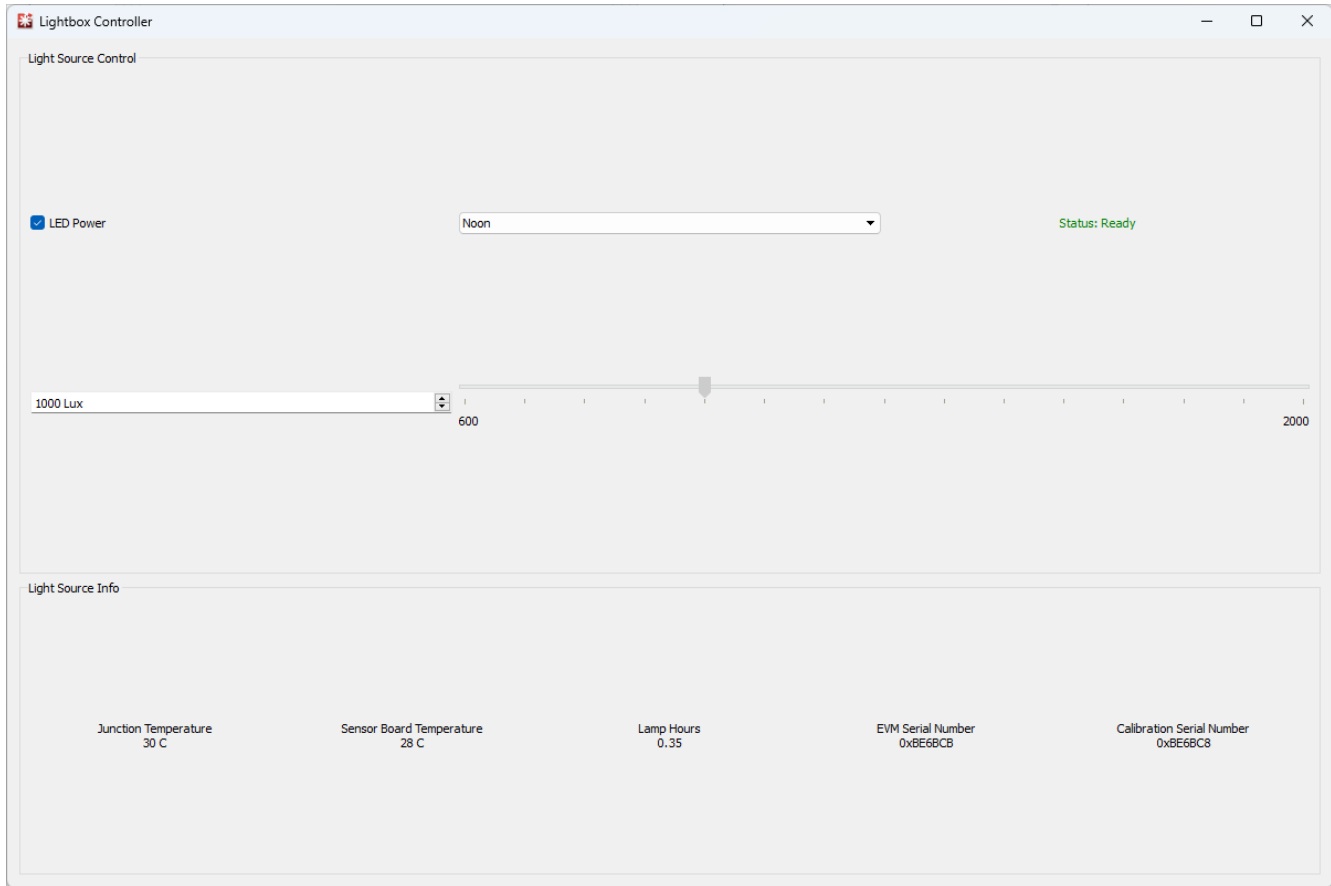

Figure 2-6. LIGHTSOURCE01EVM Main Operating Screen

If the message shown in [Figure 2-7](#) appears when the LIGHTSOURCE01 GUI software is launched, the EVM is not detected.

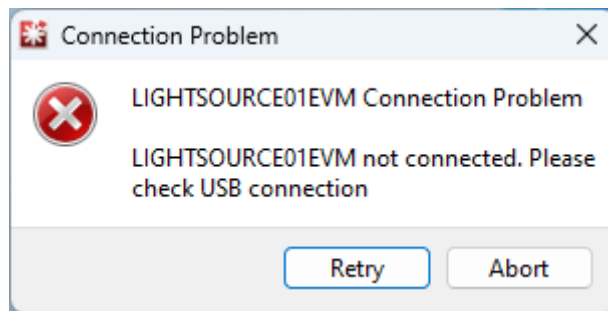

Figure 2-7. Hardware Error Message

Check the USB connection and that the LIGHTSOURCE01EVM appears in the device manager. The EVM must occupy two COM ports: one for control and the other for data. The control port serves to send a receive the serial commands, while the data port is used for the actual transfer of data to and from the device. Refer to the following figure for an example of what the device manager must look like when connecting the device.

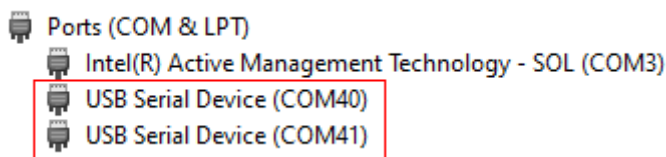

Figure 2-8. COM Ports

If you are using Windows 7, or if the Windows device manager shows 2 USB Serial Devices under as other devices when the EVM is plugged in instead of COM ports, refer to [Section 7.1](#).

2.2.4 Software Operation

This section discusses how to operate the LIGHTSOURCE01EVM software. The GUI has a primary window that is used to configure and read from the LIGHTSOURCE01EVM, along with a scripts window that can be used to automate the function of the calibration light source. Basic GUI functionality and a description of the tabs are also presented in this section.

2.2.4.1 LIGHTSOURCE01 GUI

When opened, the LIGHTSOURCE01EVM GUI, provides the Light Source Control panel to the user, where the characteristics of the light source can be adjusted.

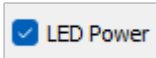

Figure 2-9. Light Source Control Panel

Clicking the LED Power box, , switches the power source on and off.

To change the LIGHTSOURCE01EVM from sunset to noon modes, click on the drop-down menu and select the desired mode.

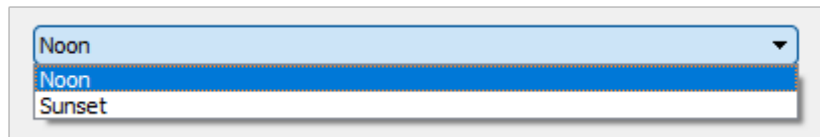

Figure 2-10. Mode Drop-Down Menu

To adjust the brightness level, you can enter a lux value into the value box or click the up or down arrows to increment or decrement the illuminance level.

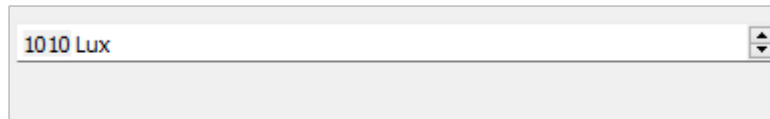

Figure 2-11. Lux Value Box

The second panel includes information about the light source, such as the temperature read from the on-board temperature sensors, listed as junction and sensor board temperatures. Additionally, the lamp hours, EVM serial number, and calibration serial number are also listed.

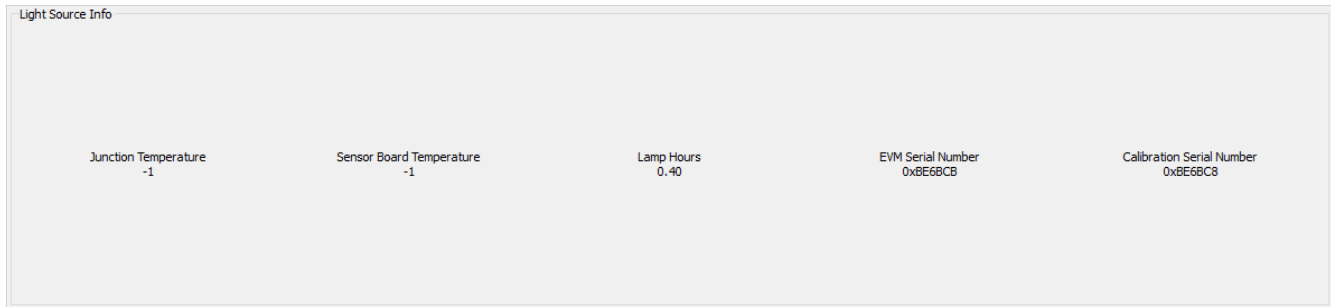

Figure 2-12. Light Source Info Panel

For a more detailed software guide, refer to [Section 3](#).

2.3 LIGHTSOURCE01EVM Light Sensor Calibration

Calibrating light sensors is crucial for providing accurate and reliable measurements across various lighting conditions. When working with production line calibration for optical sensors, calibrate the sensor before moving on to system-level calibration. This initial calibration consists of fine-tuning the response of the sensor, correcting for any variations due to manufacturing tolerances. At the system level, there are several situations where the sensor reading is different from the light incident on the system and compensation is required, such as dark cover glass, cutouts in the product case, diffusers, light pipes, lenses, and more. For similar instances, the sensor must again be calibrated to meet the requirements of the system and offset any system-level differences such as the percent transmission of the dark cover glass. The LIGHTSOURCE01EVM is specifically designed to provide a uniform and stable light source for both device-level and system-level calibration.

2.3.1 Mounting and Setup

To begin calibration using the LIGHTSOURCE01EVM, fix the EVM on to a mounting fixture. The EVM has a rail mount on the bottom, which can be used to screw the device on to the test setup. For more information on the dimensions of the mounting fixture, please refer to the [Section 5](#).

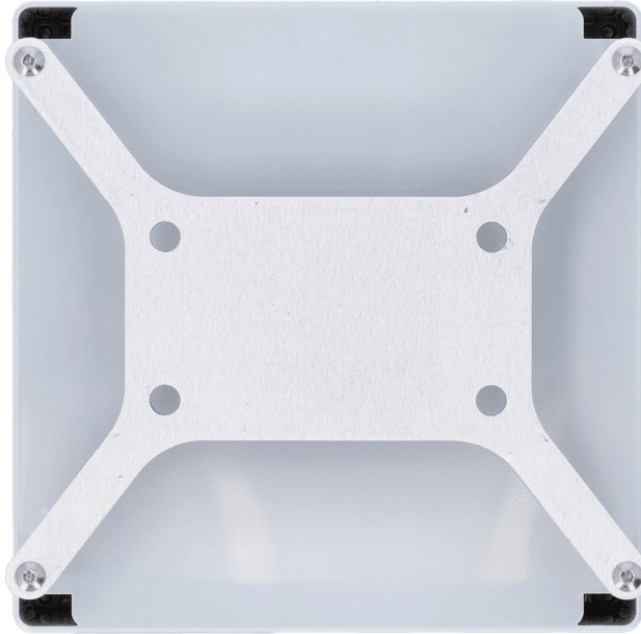

Figure 2-13. Rail Mount

Below is an example of a mounting fixture that can be used to fix the EVM in place.

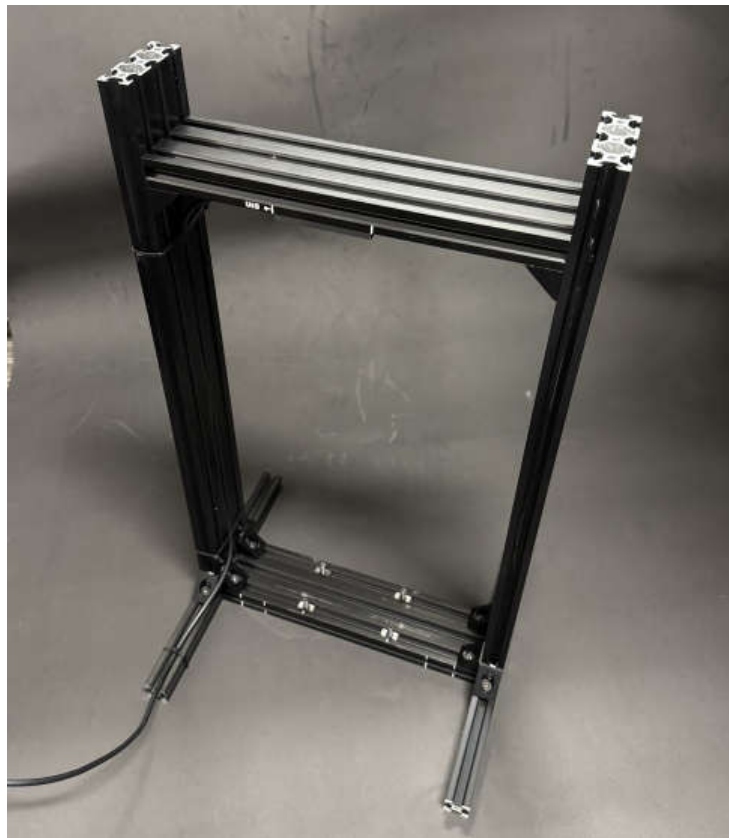

Figure 2-14. Mounting Fixture

The EVM can then be screwed on using the screws at the bottom such as in the figure below.

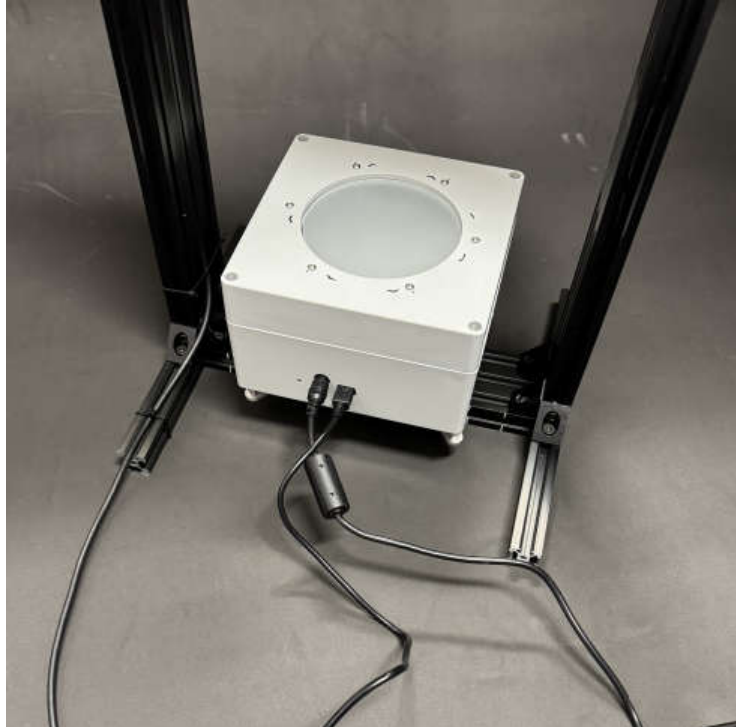

Figure 2-15. LIGHTSOURCE01EVM Mounted

2.3.2 Calibration Procedure

The light illuminating the sensor area is known because the LIGHTSOURCE01EVM can provide a constant and stable output. This information can be used to determine the compensation factor of each unit, where the compensation factor is the lux from the light source divided by the lux read by the sensor. On a production line, the compensation factor can then be stored for each unit in a form of non-volatile memory.

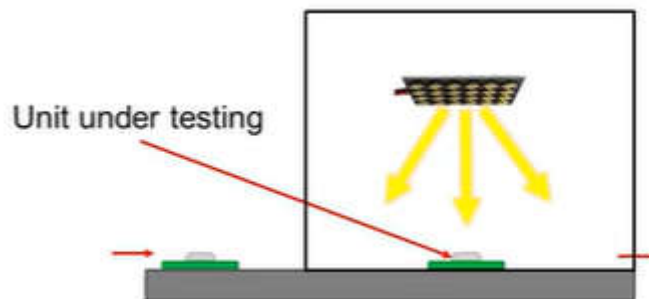

Figure 2-16. Production Line Calibration

This is also done on the system-level, where implementing dark cover glass and other optical devices like lenses, diffusers, and light guides is desirable in a design. A compensation factor can be calculated in a similar manner to what is obtained for device-level calibration. For more information, see also the [Precision labs series: Ambient light sensors](#) web page.

3 Software

This section describes the more advanced software features of the LIGHTSOURCE01EVM, such as using the additional Latte windows and using serial commands to control the light source.

3.1 Scripts Window

When Latte is launched, the GUI window appears front and center. However, there is a second window that is minimized at launch. This is the scripts window and exposes some of the commands used in the GUI. This window can be used to create scripts for automating production line calibration.

3.1.1 Hidden IDE Window

The Latte program runs a number of python scripts in the background to capture and display data from the EVM. For advanced users or users that require more flexibility when using the LIGHTSOURCE01EVM, these Python scripts are available in an integrated development environment (IDE) window that is minimized when TI-Latte is launched. The IDE window allows advanced users to customize the existing scripts or write new scripts. By automating and executing scripts within this window, repetitive tasks can be automated. Examples of these automation include adjusting the lighting level of the production line, as well as calibrating the sensors for sunset (4200K CCT) and noon (6400K CCT) lighting conditions.

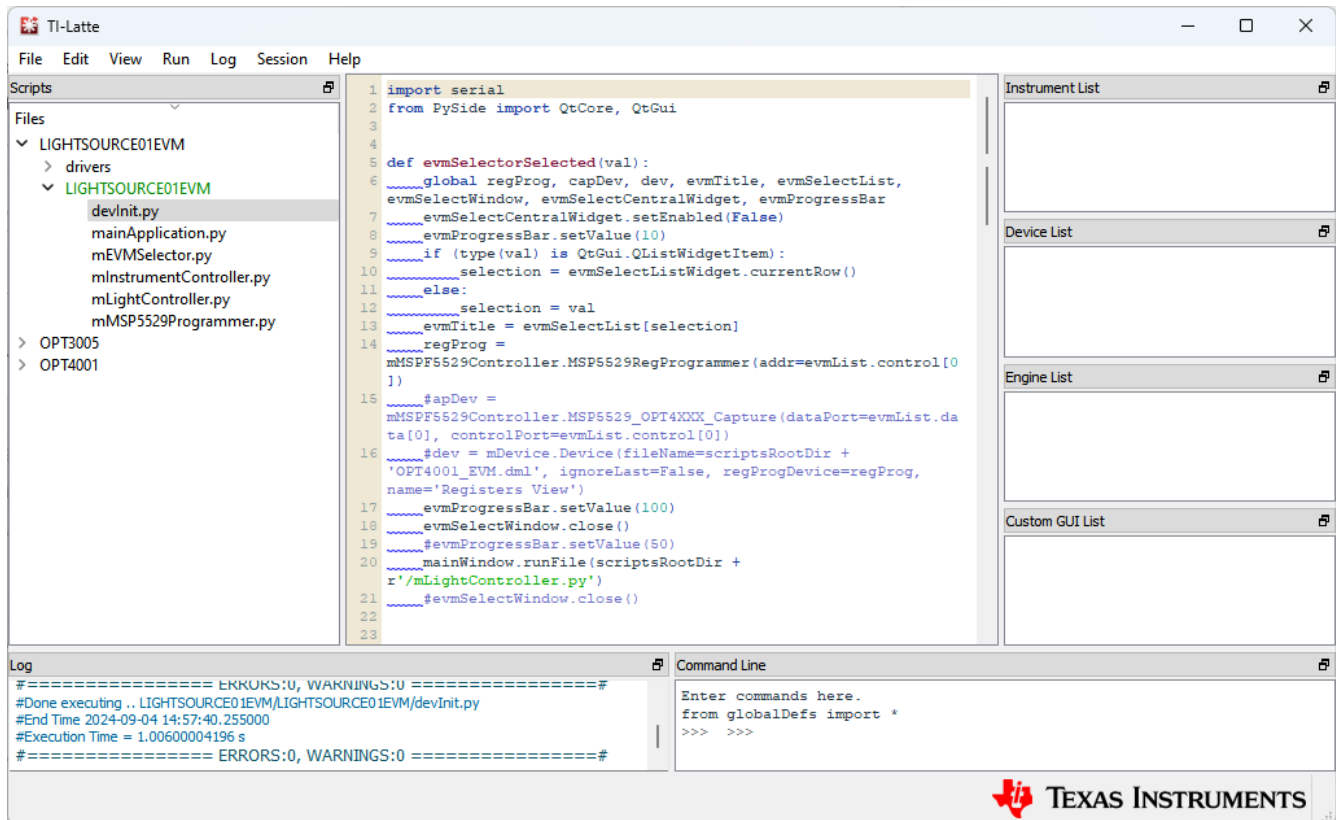

Figure 3-1. IDE Window

3.1.2 devInit.py

Open the `devInit.py` script by clicking on the corresponding file in the light sensor folder on the left side of the screen. This displays the contents of the script on the center of the window. With `devInit.py` still selected in TI-Latte, click `Run>Buffer` from the top menu bar of TI-Latte (or press F5) to run the script. Once completed, the live view GUI is opened in a new window. More details on the live view GUI are given in the following section. Additional info is also displayed in the log window in the lower left-hand corner of the main window.

3.1.3 *mLightController.py*

A live view GUI window is launched when running the `devInit.py` script. The GUI is created in the `launchGUI.py` example script. When running `devInit.py`, the `mLightController.py` script is automatically run. However, if the GUI window is closed, then the window can be re-launched by directly running the `mLightController.py` script. To do this, select the `mLightController.py` script and click `Run>Buffer` or press `F5`.

4 Serial Commands

When working with the LIGHTSOURCE01EVM, you have the flexibility to control the device using either the command line in the Scripts window of the GUI or through a terminal application. Both methods allow you to send serial commands to the EVM, allowing more precise control.

4.1 Latte Command Line

Within the Latte scripts window, you can also send serial commands directly through the command line without having to open the GUI window. To send a command, simply use the syntax `regProg._controller.sendPacket('command')`, where 'command' is the specific instruction that you want to send. The full list of commands is shown in

4.2 Terminal Application

If you prefer not to use the LIGHTSOURCE01EVM GUI, you can easily control the device through serial commands using a terminal application using a terminal application like Tera Term. After connecting to the correct COM port, you can send specific commands to the device to perform various functions. This method offers an alternative for controlling the characteristics of the light source without needing to use the Latte software. See for the full list of commands

4.3 List of Commands

Note

Before running these commands, configure COM port to 9600 baud, 8 data bits, no parity, 1 stop bit.

Table 4-1. LIGHTSOURCE01EVM Serial Commands

Command	Definition	Inputs
HWR?		Returns "C" if talking to control port, "D" if talking to data port. Must be connected to the control port to send commands and receive responses. The data port is unused.
LEDP<0/1/?>	LED Power	0: Turns off LEDs 1: Turns on LEDs ?: Returns 0 if LEDs off and update loop stopped, 1 if LEDs are on and update loop is running
LEDS<0/1/?>	LED Set	0: Sets LEDs to Noon mode 1: Sets LEDs to Sunset mode ?: Returns 0 if LEDs in Noon mode, 1 if LEDs in Sunset mode
LEDR?	LED Status	Returns 0 if LED output is settling, 1 if LED output is stable within $\pm 1\%$ of target irradiance
LEDL<value/?>	LED Lux	Sets LED target lux. Value is 4 digit hex (XXXX). Minimum lux setting is 0x0258. Maximum lux for Noon is 0x07D0. Maximum lux for Sunset is 0x05DC. ?: Returns the lux value in 4 digit hex
LED<TT/TF/?>	LED Temperature	TT: Returns 4 digit hex of temperature sensor readouts. First 2 digits are LED driver junction temperature in Celsius. Last 2 digits are the average of 4 temperature sensors' temperature in Celsius TF: Returns 0 if no temperature fault and 1 if temperature fault. Temperature fault occurs if junction temperature is greater than 80C or any of the temperature sensors are greater than 70C. Fault is cleared if junction temperature is less than 70C and all temperature sensors are reading less than 60C. Fault turns off LEDs and prevents LEDs from turning back on.
LEDI<S/C/?>	LED Box Serial Number LED Calibration Serial Number	S: Box serial number read C: Calibration serial number read
LEDH?	LED Lamp Hours	LED lamp hour query. Returns time LEDs have been on in 0.3 second increments. Return value is 16 digit hex.

5 Hardware Design Files

5.1 CAD Drawings

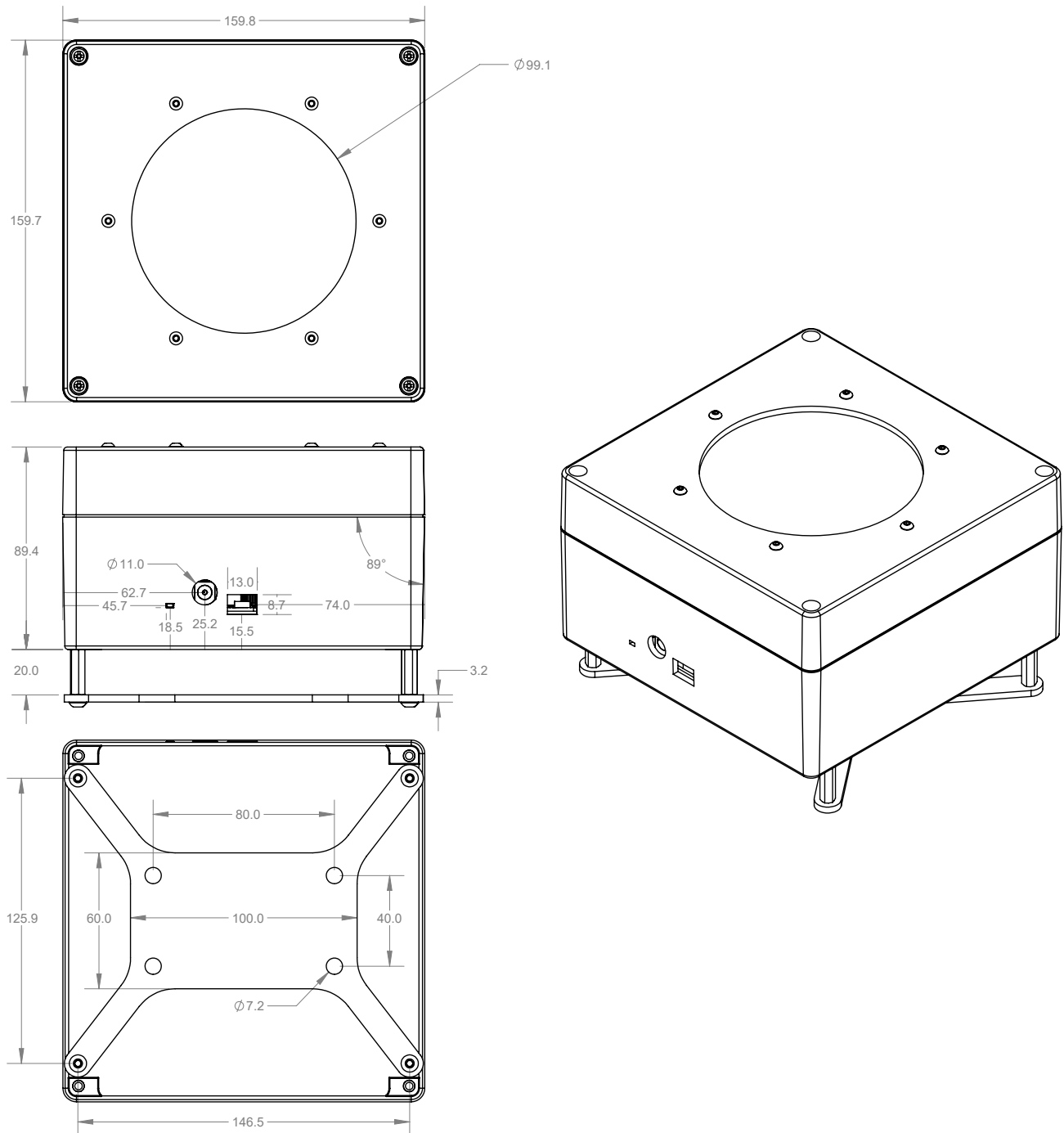

Figure 5-1. EVM CAD Drawing

6 Compliance Information

6.1 Compliance and Certifications

This EVM is in conformance with the EU harmonization legislation. See also, the [LIGHTSOURCE01EVM EU Declaration of Conformity \(DoC\)](#) certificate.

7 Additional Information

7.1 Troubleshooting

7.1.1 Microsoft Windows 7 Manual Driver Installation

This section outlines the manual driver installation process. If the user is using Windows 7 or if the Windows device manager shows 2 USB Serial Devices under as *other devices* when the EVM is plugged in instead of COM ports as shown in [Figure 7-1](#), then use the following steps. If two *USB Serial Device* devices show up as COM ports automatically (as is the case with Windows 10), then this section can be skipped.



Figure 7-1. LIGHTSOURCE01EVM on Microsoft® Windows® 7 With Drivers Not Installed

1. Open the device manager.

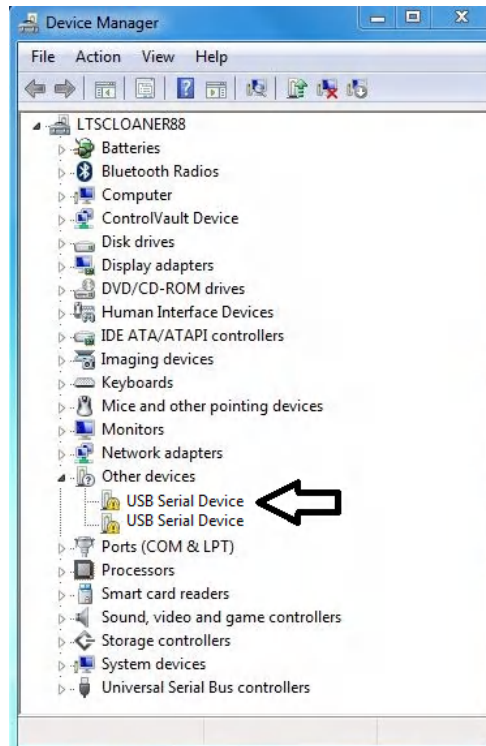

2. Right click on *USB Serial Device* and select Properties.

3. Click the *Update Driver* button.

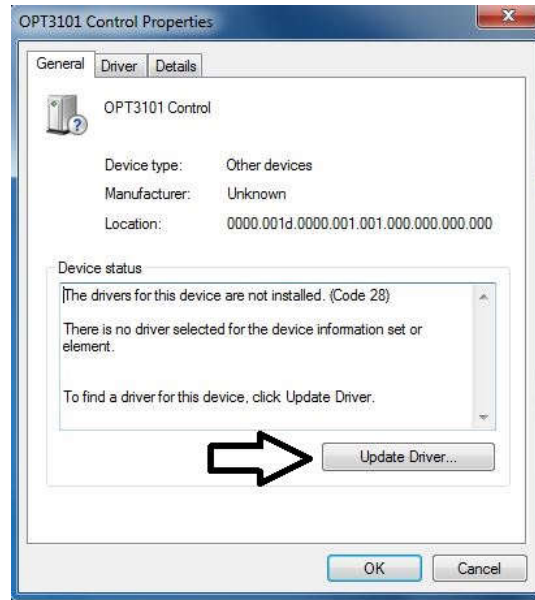

4. Click *Browse my computer for driver software*

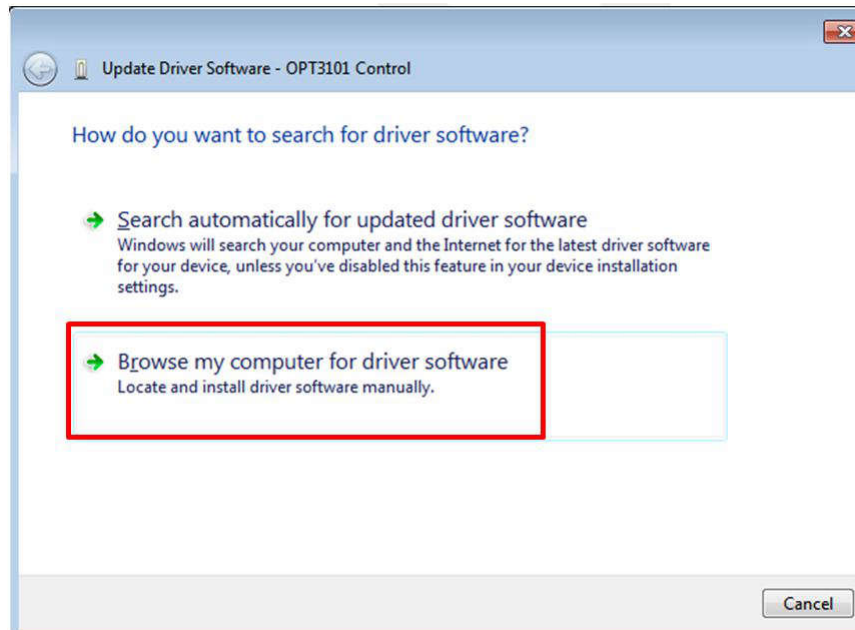

5. Click *Let me pick from a list of device drivers on my computer*.

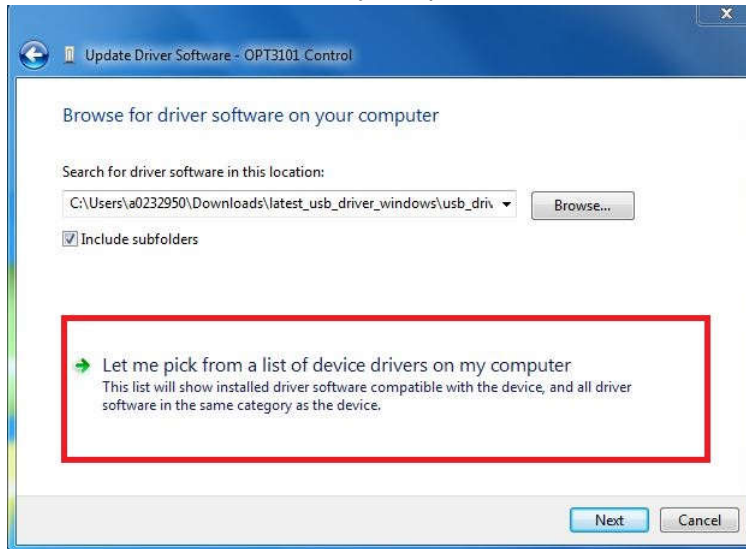

6. Select *Show All Devices* and click the *Next* button.

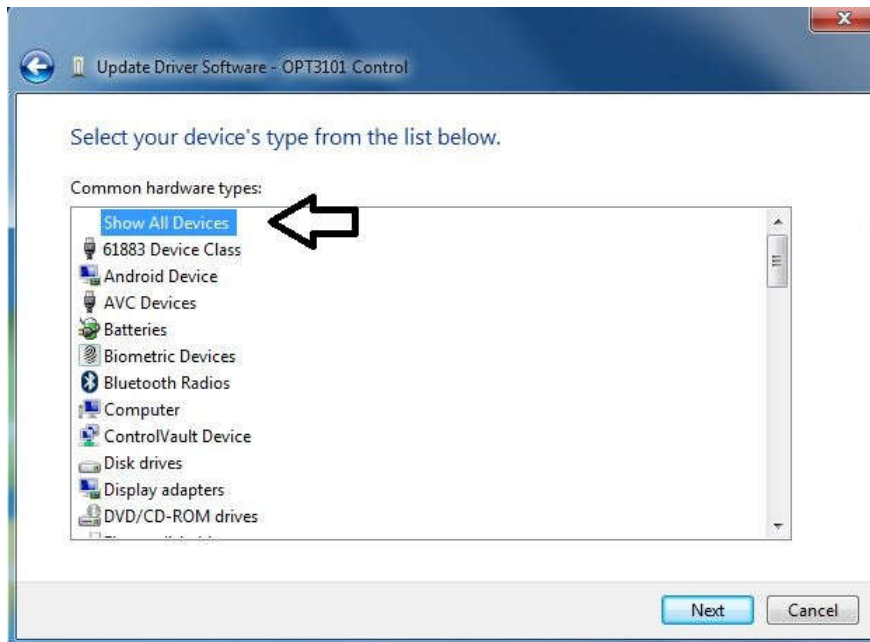

- Click the *Have Disk* button.

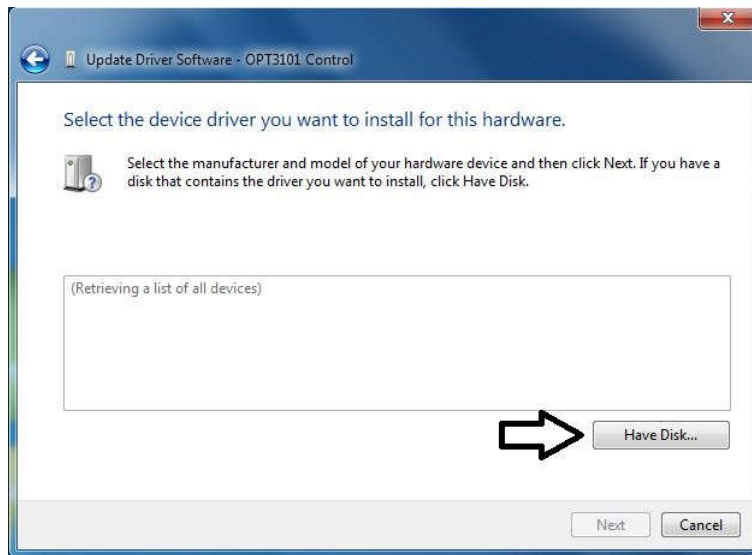

- Click the *Browse* button.

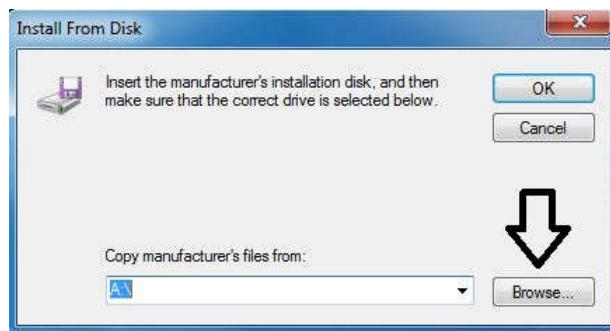

- Navigate to "C:\Users*username*\Documents\Texas Instruments\Latte\projects\OPT3004\drivers" and select MSP430_CDC. Click the *Open* button.

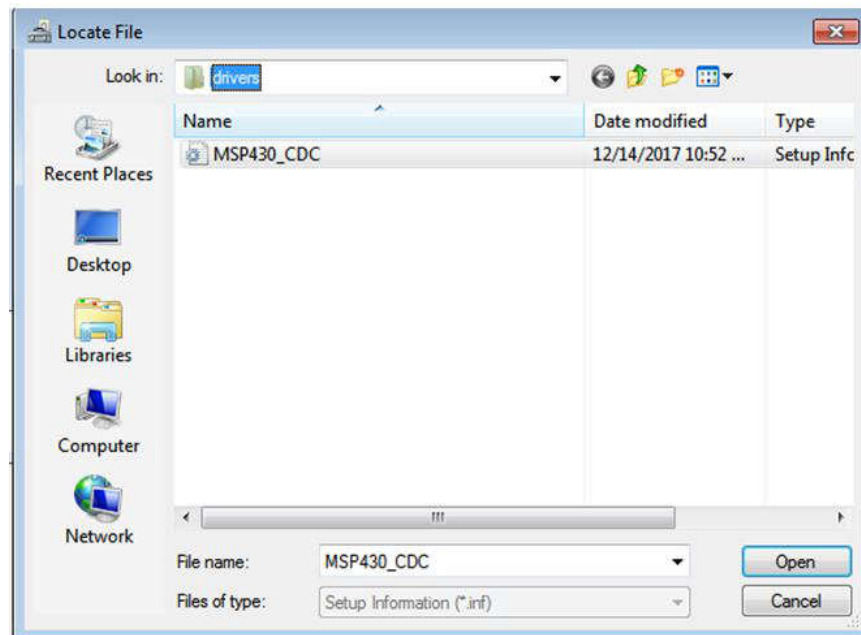

10. Click the OK button



11. Select the first USB serial device and click the Next button.

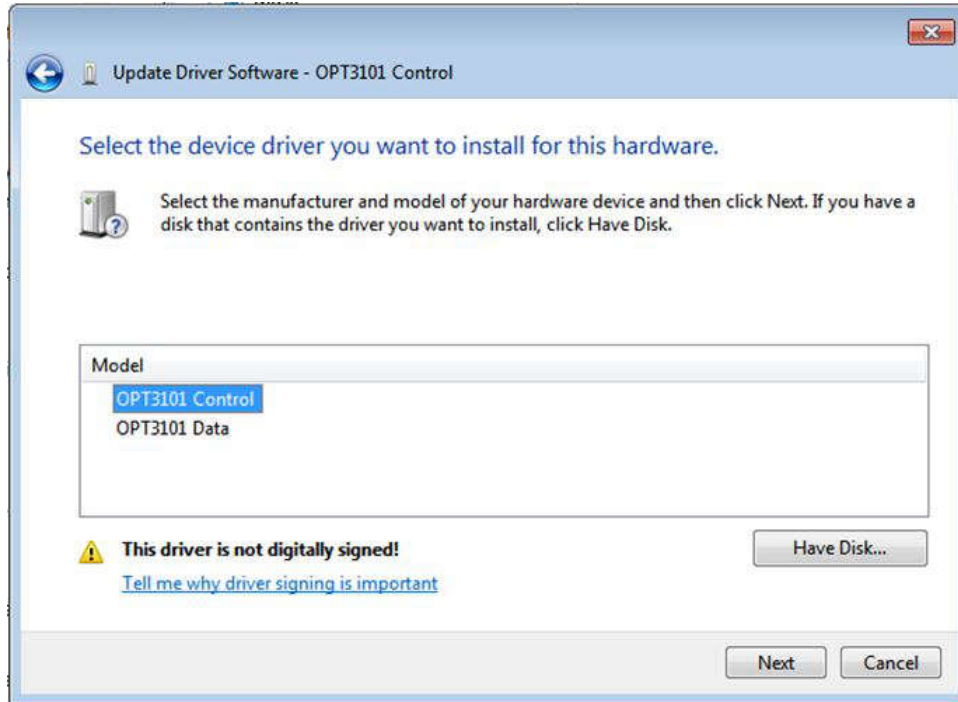

12. Click the Yes button.



13. The driver now installs properly.

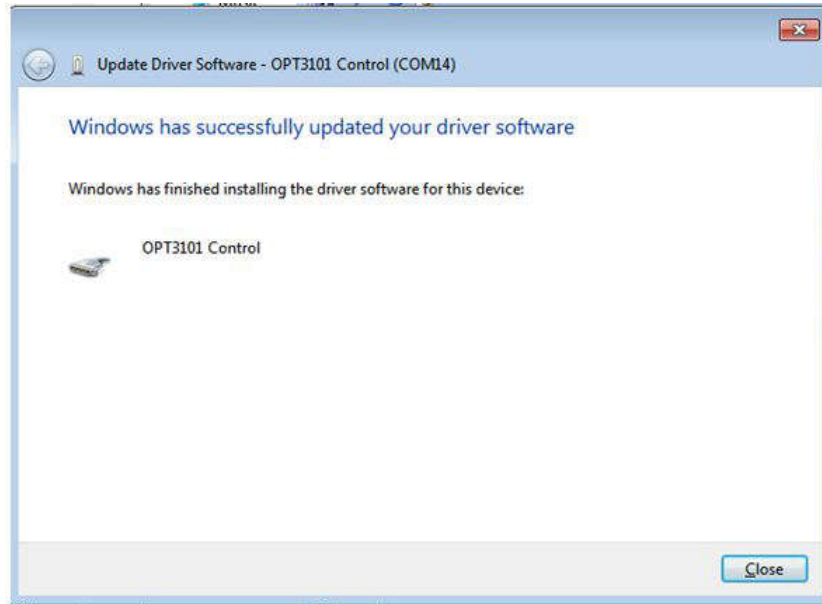

14. Repeat this process (steps 1 to 13) for the second *USB Serial Device*. All steps are the same except for step 2 and step 11. In step 2, make sure to right-click the second *USB Serial Device*. Likewise, on step 11 make sure to select the second *USB Serial Device* when installing the driver as the following figure shows.

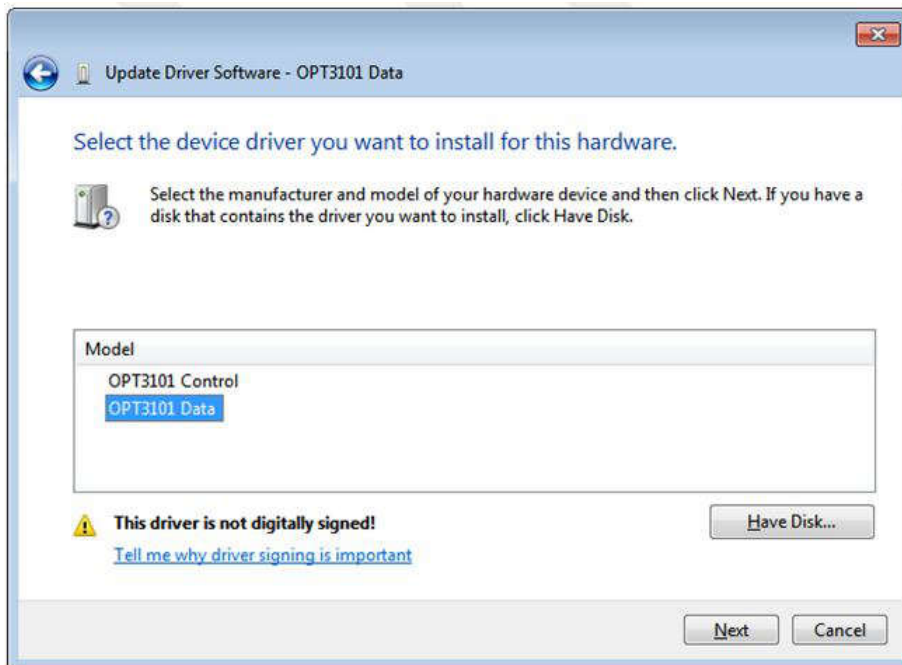

15. When the driver is installed, the user sees the following message.

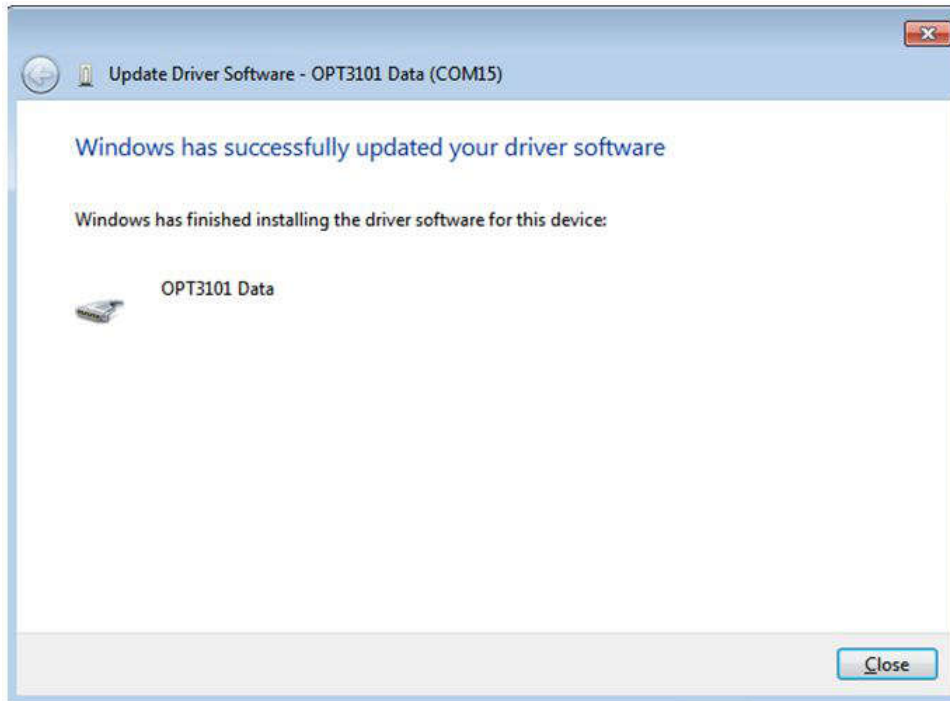

16. The two *USB Serial Device* devices appear in the device manager under Ports (COM & LPT) as the following image shows.

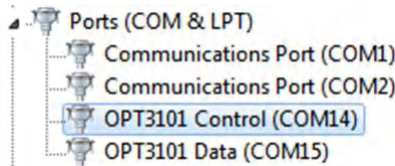

7.2 Trademarks

Windows 11®, Microsoft®, and Windows® are registered trademarks of Microsoft Corporation. All trademarks are the property of their respective owners.

8 Revision History

NOTE: Page numbers for previous revisions may differ from page numbers in the current version.

Changes from Revision * (September 2024) to Revision A (November 2024)	Page
• Updated the numbering format for tables, figures, and cross-references throughout the document.....	1
• Updated the <i>Noon Spectraland Sunset Spectral</i> graphs in the <i>Specifications</i> section.....	3

IMPORTANT NOTICE AND DISCLAIMER

TI PROVIDES TECHNICAL AND RELIABILITY DATA (INCLUDING DATA SHEETS), DESIGN RESOURCES (INCLUDING REFERENCE DESIGNS), APPLICATION OR OTHER DESIGN ADVICE, WEB TOOLS, SAFETY INFORMATION, AND OTHER RESOURCES "AS IS" AND WITH ALL FAULTS, AND DISCLAIMS ALL WARRANTIES, EXPRESS AND IMPLIED, INCLUDING WITHOUT LIMITATION ANY IMPLIED WARRANTIES OF MERCHANTABILITY, FITNESS FOR A PARTICULAR PURPOSE OR NON-INFRINGEMENT OF THIRD PARTY INTELLECTUAL PROPERTY RIGHTS.

These resources are intended for skilled developers designing with TI products. You are solely responsible for (1) selecting the appropriate TI products for your application, (2) designing, validating and testing your application, and (3) ensuring your application meets applicable standards, and any other safety, security, regulatory or other requirements.

These resources are subject to change without notice. TI grants you permission to use these resources only for development of an application that uses the TI products described in the resource. Other reproduction and display of these resources is prohibited. No license is granted to any other TI intellectual property right or to any third party intellectual property right. TI disclaims responsibility for, and you will fully indemnify TI and its representatives against, any claims, damages, costs, losses, and liabilities arising out of your use of these resources.

TI's products are provided subject to [TI's Terms of Sale](#) or other applicable terms available either on [ti.com](https://www.ti.com) or provided in conjunction with such TI products. TI's provision of these resources does not expand or otherwise alter TI's applicable warranties or warranty disclaimers for TI products.

TI objects to and rejects any additional or different terms you may have proposed.

Mailing Address: Texas Instruments, Post Office Box 655303, Dallas, Texas 75265
Copyright © 2024, Texas Instruments Incorporated