

bq34z100EVM Wide Range Impedance Track™ Enabled Battery Fuel Gauge Solution



Tom Cosby

HVAL - Battery Management Solutions

ABSTRACT

This evaluation module (EVM) is a complete evaluation system for the bq34z100 wide-range fuel gauge for lithium ion, Nickel metal hydride (NiMH) and Nickel Cadmium (NiCd) chemistries when combined with an EV2300 USB adapter and Microsoft® Windows® based PC software downloadable from the TI.com website. The circuit module includes one bq34z100 integrated circuit (IC) and all other components necessary to monitor and predict capacity in one or more series cell Li-ion, Li-polymer, or LiFePO4 battery packs. The minimum series cell count for PbA, NiMH, and NiCd chemistries must exceed 3.3-V stack voltage. The circuit module connects directly across the battery stack. With the EV2300 interface adapter and software, it is possible to read the bq34z100 data registers, program the chip for different pack configurations, log cycling data for further evaluation, and evaluate the overall functionality of the bq34z100 solution under different charge and discharge conditions.

Table of Contents

1 Features	3
1.1 Kit Contents.....	3
1.2 Ordering Information.....	3
1.3 Documentation.....	3
1.4 bq34z100 Circuit Module Performance Specification Summary.....	3
2 bq34z100 Quick Start Guide	4
2.1 Items Needed for EVM Setup and Evaluation.....	4
2.2 Software Installation.....	4
2.3 EVM Connections.....	5
3 Battery Management Studio	7
3.1 Registers Screen.....	7
3.2 Setting Programmable bq34z100 Options.....	8
3.3 Calibration Screen.....	9
3.4 Chemistry Screen.....	10
3.5 Programming Screen.....	11
3.6 Golden Image Screen.....	12
3.7 Advanced Comm I2C Screen.....	13
3.8 Send HDQ Screen.....	15
3.9 Dashboard Panel.....	15
3.10 Commands Panel.....	16
4 Circuit Module Physical Layouts	17
4.1 Board Layout.....	17
4.2 Schematic.....	20
4.3 Bill of Materials.....	21
5 Related Documentation from Texas Instruments	22
6 Revision History	22

List of Figures

Figure 2-1. bq34z100 Circuit Module Connection to Cells and System Load and Charger.....	5
Figure 3-1. Registers Screen.....	7
Figure 3-2. Data Memory Screen.....	8
Figure 3-3. Calibration Screen.....	9

Figure 3-4. Chemistry Screen.....	10
Figure 3-5. Programming Screen.....	11
Figure 3-6. Golden Image Screen.....	12
Figure 3-7. Advanced Comm Screen.....	13
Figure 3-8. Send HDQ Screen.....	15
Figure 4-1. Top Silk Screen.....	17
Figure 4-2. Top Assembly.....	17
Figure 4-3. Top Layer.....	18
Figure 4-4. Internal Layer 1.....	18
Figure 4-5. Internal Layer 2.....	19
Figure 4-6. Bottom Layer.....	19
Figure 4-7. bq34z100EVM-003 Schematic.....	20

List of Tables

Table 1-1. Ordering Information.....	3
Table 4-1. Bill of Materials.....	21

Trademarks

Impedance Track™ is a trademark of Texas Instruments.
 Microsoft® and Windows® are registered trademarks of Microsoft Corporation.
 All trademarks are the property of their respective owners.

1 Features

- Complete evaluation system for the bq34z100 advanced gas gauge with Impedance Track™ technology.
- Populated circuit module for quick setup
- Link to software allowing data logging for system analysis

1.1 Kit Contents

- bq34z100 circuit module
- Cable to connect the EVM to an EV2300 or EV2400 Communications Interface Adapter.

1.2 Ordering Information

Table 1-1. Ordering Information

EVM Part Number	Chemistry	Configuration	Capacity
bq34z100EVM	Li-Ion, Li-Polymer, LiFePO4, PbA, NiMH, NiCd	3 V–48 V	Any

1.3 Documentation

See the device data sheet for bq34z100-G1 ([SLUSBZ5](#)) on www.ti.com for information on device firmware and hardware.

1.4 bq34z100 Circuit Module Performance Specification Summary

This section summarizes the performance specifications of the bq34z100 circuit module.

Specification	Min	Typ	Max	Unit
Input voltage BAT+ to BAT– in 1S mode	3	4	5	V
Input voltage BAT+ to BAT– in MultiCell	6	28	48	V
Charge and discharge current	0	2	7	A

2 bq34z100 Quick Start Guide

This section provides the step-by-step procedures required to take a new EVM and configure it for operation in a laboratory environment.

2.1 Items Needed for EVM Setup and Evaluation

- bq34z100 circuit module
- EV2300 or EV2400 Communications Interface Adapter
- Cable to connect the EVM to an EV2300 or EV2400 Communications Interface Adapter
- USB cable to the Communications Interface Adapter to the computer
- Computer setup with Windows XP, or higher, operating system
- Access to the internet to download the [Battery Management Studio](#) software setup program
- Battery cells or 1-k Ω resistors to configure a cell simulator
- A DC power supply that can supply 50 V and 3 A (Constant current/constant voltage capability is desirable)

2.2 Software Installation

Find the latest software version in the [bq34z100](#) tool folder on [www.ti.com](#). Use the following steps to install the bq34z100-G1 Battery Management Studio software:

1. Download and run the Battery Management Studio setup program from the [bqStudio](#) product folder on [www.ti.com](#). See [Section 3](#) for detailed information on using the tools in the Battery Management Studio.
2. If the Communications Interface Adapter was not previously installed, after the Battery Management Studio installation, a TI USB driver installer pops up. Click "Yes" for the agreement message and follow the instructions. Two drivers are associated with the EV2300 and an additional file may be required for the EV2400. Follow the instructions to install both. Do not reboot the computer, even if asked to do so.
3. Plug the Communications Interface Adapter into a USB port using the USB cable. The Windows system may show a prompt that new hardware has been found. When asked, "Can Windows connect to Windows Update to search for software?", select "No, not this time", and click "Next". In the next dialog window, it indicates "This wizard helps you install software for: TI USB Firmware Updater". Select "Install the software automatically (Recommended)" and click "Next". It is common for the next screen to be the Confirm File Replace screen. Click "No" to continue. If this screen does not appear, then go to the next step. After Windows indicates that the installation was finished, a similar dialog window pops up to install the second driver. Proceed with the same installation preference as the first one. The second driver is the TI USB bq80xx Driver.

2.3 EVM Connections

This section covers the hardware connections for the EVM (see [Figure 2-1](#)).

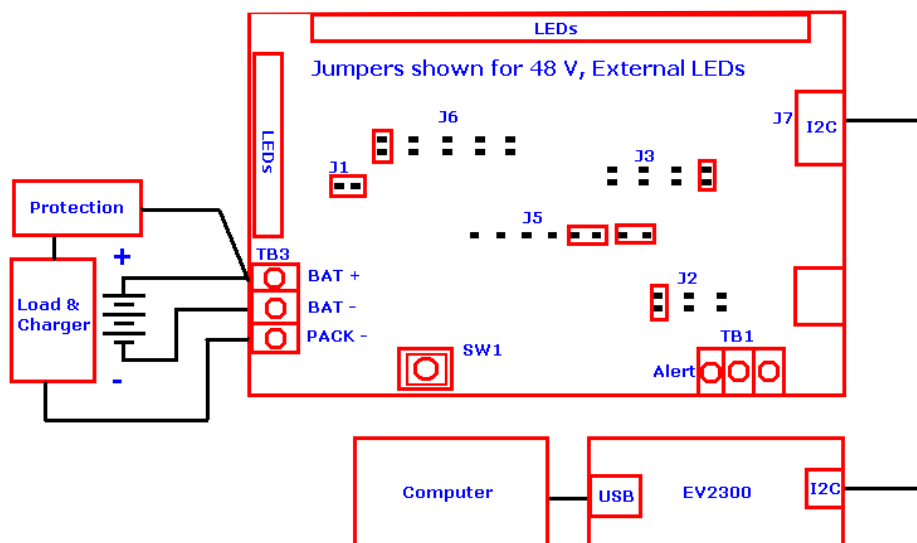

Figure 2-1. bq34z100 Circuit Module Connection to Cells and System Load and Charger

- Direct connection to the cells: BAT–, BAT+

The bq34z100 monitors the cell stack voltage. Connect the bottom of the stack to BAT– and the top of the stack to BAT+. The stack voltage can range from 3 V to 48 V (see [Figure 2-1](#)).

STACK VOLTAGE	J5 HEADER	J2 HEADER
Less than 5 V	< 5-V jumpers	N/A
Greater than 5 V	> 5-V jumpers	16 V, 32 V or 48 V

WARNING

Applying a voltage greater than 5 V when jumpers are configured to < 5-V operation will damage the IC. Do not apply power until you have completed the *EVM Connections* section.

- To the serial communications port (SCL, SDA)

Attach the Communications Interface Adapter cable to the J7 terminal block and to an EV2300 or EV2400 adapter box. Connect the PC USB cable to the EV2300 or EV2400 and the PC USB port (see [Figure 2-1](#)).

- The charger and system load connection across BAT+ and PACK–

Attach the charger or load to the TB3 terminal block. Connect the positive load wire to BAT+ and the ground wire for the load to PACK– (see [Figure 2-1](#)).

- The ALERT output

The ALERT output is an active low interrupt. The ALERT Configuration register selects the Control Status bits that will activate the interrupt. The ALERT pin is an open drain output and a pull-up resistor must be attached to the TB1 to use the feature.

- The LED Configuration

When configuring the data flash registers, choose one of five LED/Comm configuration codes (refer to Table 21 in the bq34z100-G1 datasheet [SLUSBZ5](#)). After reviewing those possibilities, select the jumper pattern desired for the J6 header on the EVM. For single LED mode, place a jumper on the pair marked A. For four direct LED mode, place jumpers on A, B, C, and D. (Note: This configuration is only available when using HDQ communications mode.) For external LEDs using the shift register option, place a single jumper on EXT. In all cases, where one or more LED's are used, place a jumper across the J1 header to provide power to the LED (see [Figure 2-1](#)).

- Parameter setup

The default data flash settings configure the device for 1-series Li-Ion cell. The user must update the data to set up the number of series cells to match the physical pack configuration (see Cell Configuration in [Section 3.2](#)). This provides basic functionality to the setup. Other data flash parameters should also be updated to fine tune the gauge to the pack. See the bq34z100 datasheet for help with setting the parameters.

3 Battery Management Studio

3.1 Registers Screen

Apply power to the EVM after you have completed the EVM Connections section. Run Battery Management Studio from the Start | Programs | Texas Instruments | Battery Management Studio menu sequence, or the Battery Management Studio shortcut. The Registers screen (see Figure 3-1) appears. The *Registers* section contains parameters used to monitor gauging. The *Bit Registers* section provides a bit-level picture of status and fault registers. A green flag indicates that the bit is 0 (low state) and a red flag indicates that the bit is 1 (high state). Data begins to appear once the *Refresh* (single-time scan) button is selected, or it scans continuously, if the *Scan* button is selected.

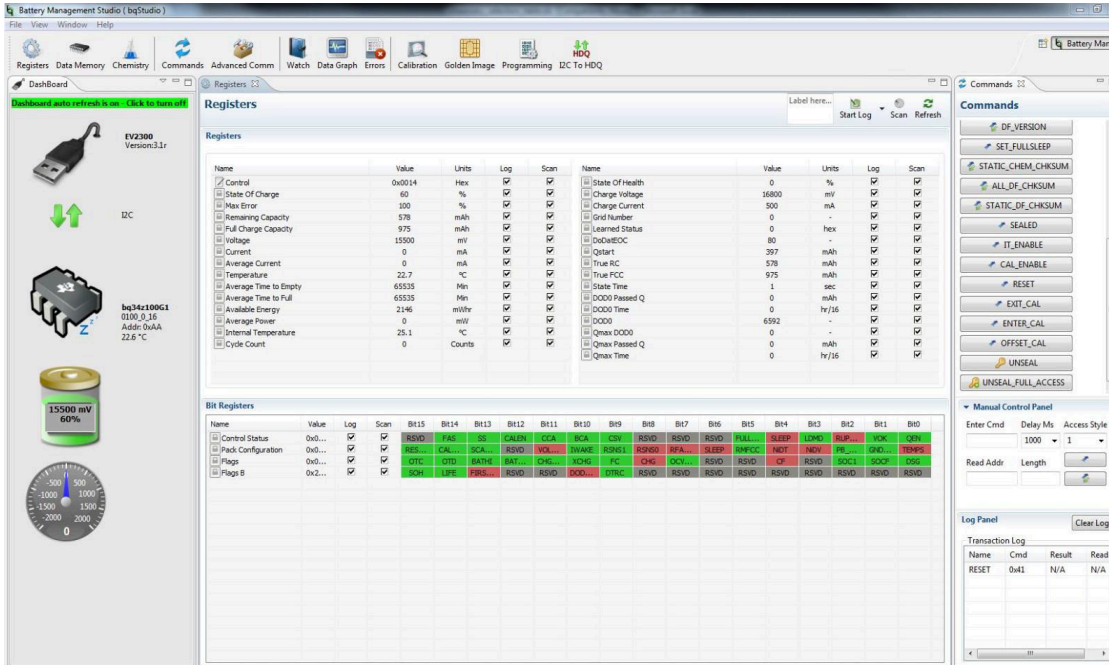

Figure 3-1. Registers Screen

The continuous scanning period can be set via the | Window | Preferences | SBS | Scan Interval | menu selection.

The Battery Management Studio program provides a logging function which logs the values selected by the *Log* check boxes located beside each parameter in the *Registers* section. To enable this function, select the *Log* button; this causes the *Scan* button to be selected. When logging is stopped, the *Scan* button is still selected and has to be manually deselected.

3.2 Setting Programmable bq34z100 Options

The bq34z100 data flash comes configured per the default settings detailed in the bq34z100 datasheet. Ensure that the settings are correctly changed to match the pack and application for the solution being evaluated.

Note

The correct setting of these options is essential to get the best performance. The settings can be configured using the *Data Memory* screen (see [Figure 3-2](#))

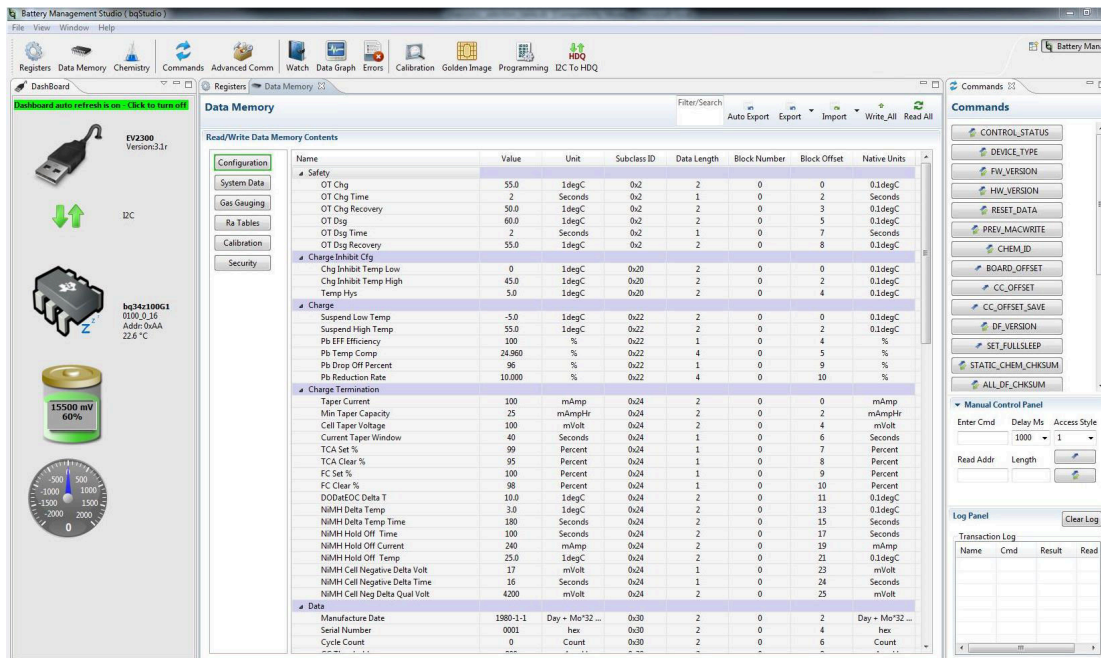

Name	Value	Unit	Subclass ID	Data Length	Block Number	Block Offset	Native Units
Safety							
OT Chg	55.0	1degC	0x2	2	0	0	0.1degC
OT Chg Time	2	Seconds	0x2	1	0	2	Seconds
OT Chg Recovery	50.0	1degC	0x2	2	0	3	0.1degC
OT Dig	60.0	1degC	0x2	2	0	5	0.1degC
OT Dig Time	2	Seconds	0x2	1	0	7	Seconds
OT Dig Recovery	55.0	1degC	0x2	2	0	8	0.1degC
Charge/Inhibit Cfg							
Chg Inhibit Temp Low	0	1degC	0x20	2	0	0	0.1degC
Chg Inhibit Temp High	45.0	1degC	0x20	2	0	2	0.1degC
Temp Hys	5.0	1degC	0x20	2	0	4	0.1degC
Charge							
Suspend Low Temp	-5.0	1degC	0x22	2	0	0	0.1degC
Suspend High Temp	55.0	1degC	0x22	2	0	2	0.1degC
Pb EFF Efficiency	100	%	0x22	1	0	4	%
Pb Temp Comp	24.860	%	0x22	4	0	5	%
Pb Drop Off Percent	96	%	0x22	1	0	9	%
Pb Reduction Rate	10.000	%	0x22	4	0	10	%
Charge Termination							
Taper Current	100	mAmp	0x24	2	0	0	mAmp
Min Taper Capacity	25	mAmpHr	0x24	2	0	2	mAmpHr
Cell Taper Voltage	100	mVolt	0x24	2	0	4	mVolt
Current Taper Window	40	Seconds	0x24	1	0	6	Seconds
TCA Set %	99	Percent	0x24	1	0	7	Percent
TCA Clear %	95	Percent	0x24	1	0	8	Percent
FC Set %	100	Percent	0x24	1	0	9	Percent
FC Clear %	98	Percent	0x24	1	0	10	Percent
DDOatOC Delta T	10.0	1degC	0x24	2	0	11	0.1degC
NIMH Delta Temp	3.0	1degC	0x24	2	0	13	0.1degC
NIMH Delta Temp Time	180	Seconds	0x24	2	0	15	Seconds
NIMH Hold Off Time	100	Seconds	0x24	2	0	17	Seconds
NIMH Hold Off Current	240	mAmp	0x24	2	0	19	mAmp
NIMH Hold Off Temp	25.0	1degC	0x24	2	0	21	0.1degC
NIMH Cell Negative Delta Volt	17	mVolt	0x24	1	0	23	mVolt
NIMH Cell Negative Delta Time	16	Seconds	0x24	1	0	24	Seconds
NIMH Cell Neg Delta Qual Volt	4200	mVolt	0x24	2	0	25	mVolt
Data							
Manufacture Date	1880-1-1	Day + Mo*32 ...	0x30	2	0	2	Day + Mo*32 ...
Serial Number	0001	hex	0x30	2	0	4	hex
Cycle Count	0	Count	0x30	2	0	6	Count

Figure 3-2. Data Memory Screen

3.2.1 Cell Configuration

The bq34z100 operates in one of two modes for measuring battery voltage. Place two jumpers on header J5 to select the mode of operation. Refer to the [Section 2.3](#).

For packs where the stack voltage is less than 5 V:

- Set the *Number of Series Cells* parameter field to the appropriate value
- Reset the gauge using the **RESET** button on the **Commands** panel
- Calibrate the stack voltage. Reference the **Calibration Screen** section

For packs where the stack voltage is greater than 5 V:

- Set the *Number of Series Cells* parameter field to the appropriate value
- Set the **VOLTSEL** bit in the *Pack Cfg A* register
- Reset the gauge using the **RESET** button on the **Commands** panel
- Calibrate the stack voltage. Reference the **Calibration Screen** section

3.3 Calibration Screen

Calibrate the voltages, temperatures, and currents to provide good gauging performance. Press the *Calibration* button to select the *Advanced Calibration* window. See [Figure 3-3](#).

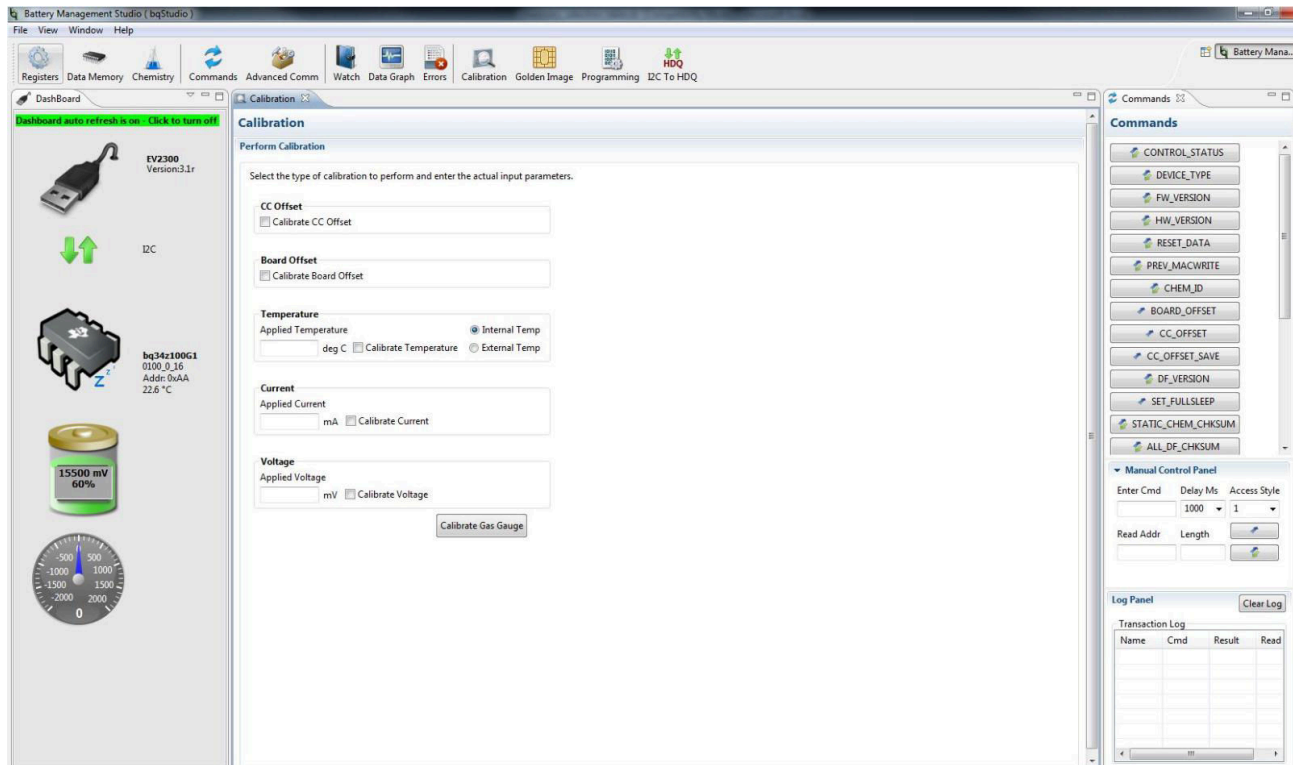

Figure 3-3. Calibration Screen

3.3.1 Voltage Calibration

- Measure the voltage from BAT+ to BAT– and enter this value in the *Applied Voltage* field and select the *Calibrate Voltage* box.
- Press the *Calibrate Gas Gauge* button to calibrate the voltage measurement system.
- Deselect the *Calibrate Voltage* boxes after voltage calibration has completed.

3.3.2 Temperature Calibration

- Enter the room temperature in the *Applied Temperature* field and select the *Calibrate Temperature* box and select the thermistor to be calibrated. The temperature value must be entered in degrees Celsius.
- Press the *Calibrate Gas Gauge* button to calibrate the temperature measurement system.
- Deselect the *Calibrate Temperature* box after temperature calibration has completed.

3.3.3 Current Calibration

- Select the *Calibrate CC Offset* and *Calibrate Board Offset* boxes and insure that there is no current flow.
- Press the *Calibrate Gas Gauge* button to calibrate.
- Deselect the *Calibrate CC Offset* and *Calibrate Board Offset* boxes after current calibration has completed.
- Connect and measure a 2-A load from BAT+ and PACK– to calibrate the current gain.
- Enter –2000 in the Applied Current field and select the Calibrate Current box.
- Press the *Calibrate Gas Gauge* button to calibrate.
- Deselect the Calibrate Current box after current calibration has completed.

3.4 Chemistry Screen

The chemistry file contains parameters that the simulations use to model the cell and its operating profile. It is critical to program a Chemistry ID that matches the cell into the device. Some of these parameters can be viewed in the Data Flash section of the Battery Management Studio.

Press the *Chemistry* button to select the Chemistry window. See [Figure 3-4](#).

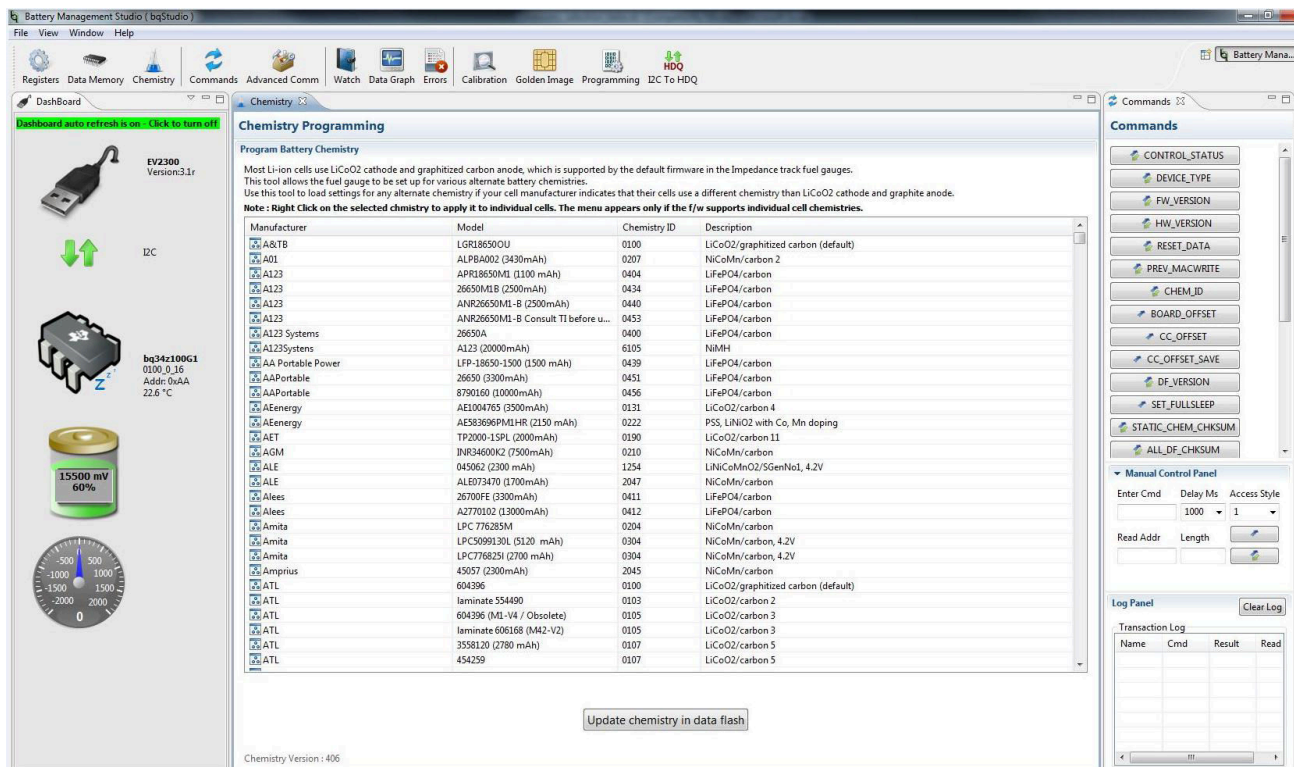

Program Battery Chemistry

Most Li-Ion cells use LiCoO₂ cathode and graphitized carbon anode, which is supported by the default firmware in the Impedance track fuel gauges. This tool allows the fuel gauge to be set up for various alternate battery chemistries. Use this tool to load settings for any alternate chemistry if your cell manufacturer indicates that their cells use a different chemistry than LiCoO₂ cathode and graphite anode. **Note: Right Click on the selected chemistry to apply it to individual cells. The menu appears only if the f/w supports individual cell chemistries.**

Manufacturer	Model	Chemistry ID	Description
A&TB	LGR18650OU	0100	LiCoO ₂ /graphitized carbon (default)
A01	ALPBA002 (3430mAh)	0207	NiCoMn/carbon 2
A123	APR18650M1 (1100 mAh)	0404	LiFePO ₄ /carbon
A123	26650MLB (2500mAh)	0434	LiFePO ₄ /carbon
A123	ANR26650M1-B (2500mAh)	0440	LiFePO ₄ /carbon
A123	ANR26650M1-B Consult TI before u...	0453	LiFePO ₄ /carbon
A123 Systems	26650A	0400	LiFePO ₄ /carbon
A123 Systems	A123 (20000mAh)	6105	NiMH
AA Portable Power	LFP-18650-1500 (1500 mAh)	0439	LiFePO ₄ /carbon
AA Portable	26650 (3300mAh)	0451	LiFePO ₄ /carbon
AA Portable	8790100 (10000mAh)	0456	LiFePO ₄ /carbon
AEnergy	ALC1804765 (3300mAh)	0131	LiCoO ₂ /carbon 4
AEnergy	ACE82696PALHR (2150 mAh)	0222	PSS, LiNiO ₂ with Co, Mn doping
AET	TP2000-1SPL (2000mAh)	0190	LiCoO ₂ /carbon 11
AGM	JNR34600K2 (7500mAh)	0210	NiCoMn/carbon
ALE	045062 (2300 mAh)	1254	LiNiCoMnO ₂ /SGenNo1, 4.2V
ALE	ALE073470 (1700mAh)	2047	NiCoMn/carbon
Alees	26700FE (3300mAh)	0411	LiFePO ₄ /carbon
Alees	A2770102 (13000mAh)	0412	LiFePO ₄ /carbon
Amita	LPC 776285M	0204	NiCoMn/carbon
Amita	LPC5099130L (5120 mAh)	0304	NiCoMn/carbon, 4.2V
Amita	LPC7768251 (2700 mAh)	0304	NiCoMn/carbon, 4.2V
Amprius	45057 (2300mAh)	2045	NiCoMn/carbon
ATL	604396	0100	LiCoO ₂ /graphitized carbon (default)
ATL	laminat6 554489	0103	LiCoO ₂ /carbon 2
ATL	604396 (M1-1/4 / Obsolete)	0105	LiCoO ₂ /carbon 3
ATL	laminat6 606168 (M42-V2)	0105	LiCoO ₂ /carbon 3
ATL	3558120 (2780 mAh)	0107	LiCoO ₂ /carbon 5
ATL	454259	0107	LiCoO ₂ /carbon 5

Update chemistry in data flash

Chemistry Version : 406

Figure 3-4. Chemistry Screen

- The table can be sorted by clicking the desired column. For example: Click the Chemistry ID column header.
- Select the ChemID that matches your cell from the table ([Figure 3-4](#)).
- Press the *Update chemistry in the data flash* button to update the chemistry in the device.

3.5 Programming Screen

Press the *Programming* button to select the Programming Update window. This window allows the user to program the device to a new version of firmware.

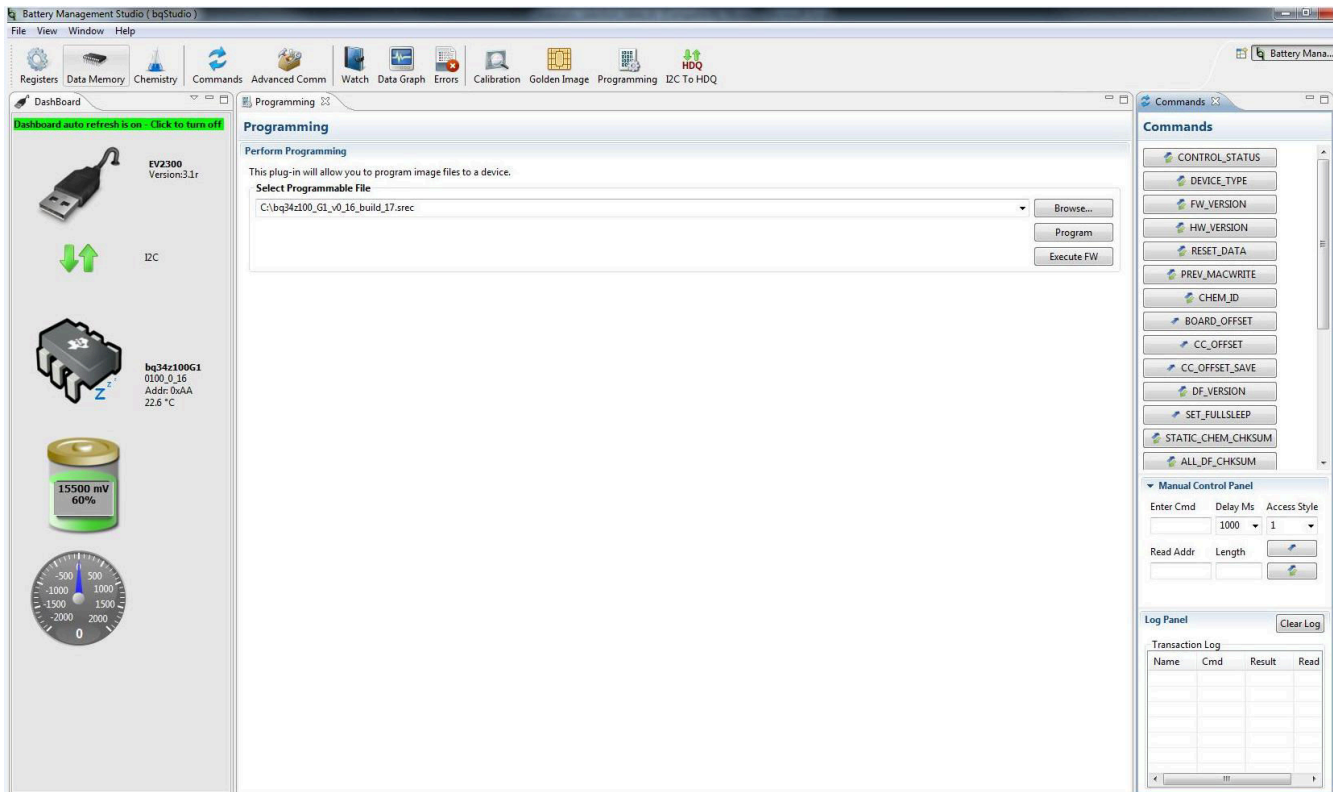

Figure 3-5. Programming Screen

3.5.1 Programming the Flash Memory

The upper section of the Programming screen is used to initialize the device by loading the default .srec into the flash memory (see Figure 3-5).

- Search for the .srec file using the *Browse* button.
- Press the *Program* button and wait for the download to complete.
- Press the *Execute FW* button after the download has completed.
- Select *File | Restart* to initialize bqStudio to the new firmware.

3.6 Golden Image Screen

Press the *Golden Image* button to select the Golden Image window. This window allows the user to export the device firmware as an .srec, .bq.fs, and .df.fs files.

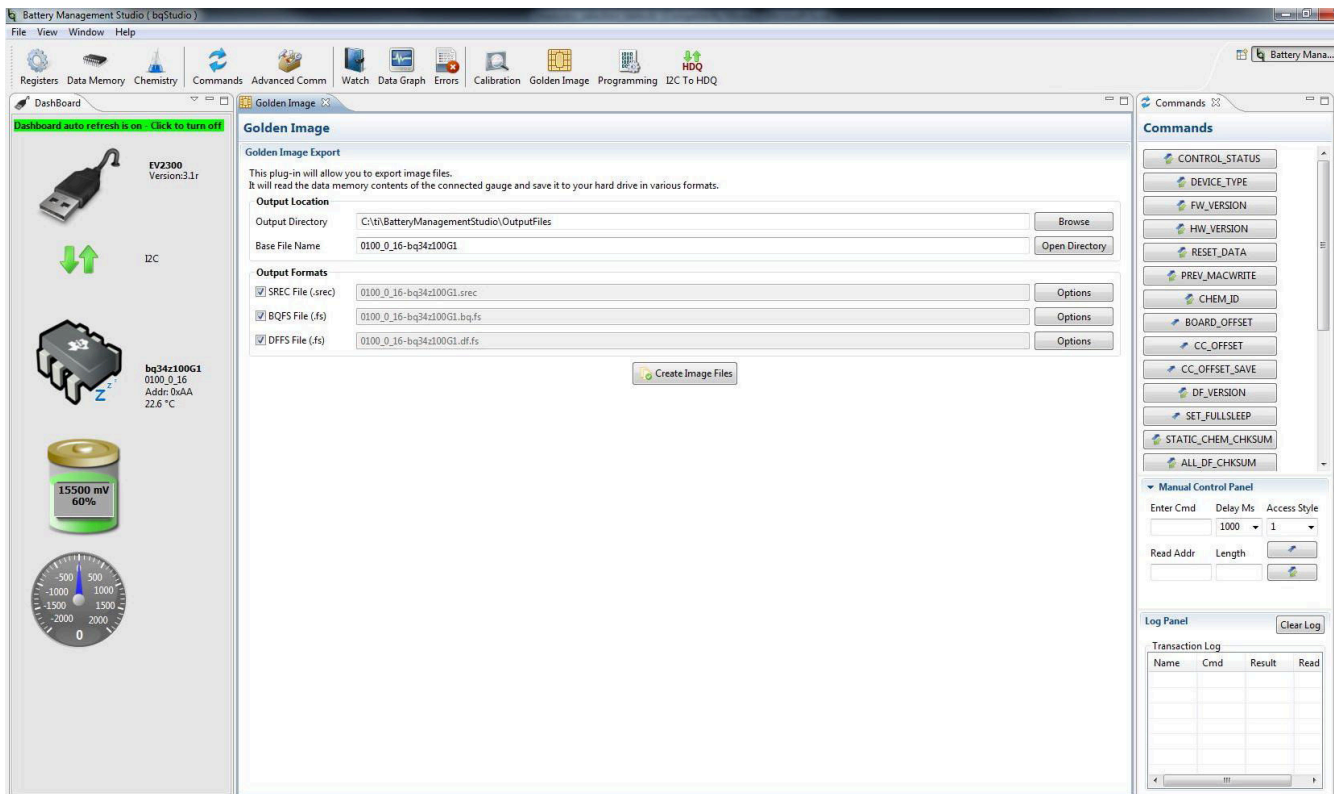

Figure 3-6. Golden Image Screen

3.6.1 Exporting the Flash Memory

The .srec file contains the full flash memory. The .bq.fs contains the program memory portion for the flash memory and the .df.fs contains the data flash portion of the flash memory (see Figure 3-6).

- Select the directory location to export the files.
- Enter the file name for the files.
- Select the files types to export.
- Press the *Create Image File* button to export the memory and create the files.

3.7 Advanced Comm I2C Screen

Press the *Advanced Comm I2C* button to select the Advanced I2C Comm window. This tool provides access to parameters using I2C and Manufacturing Access commands (see [Figure 3-7](#)).

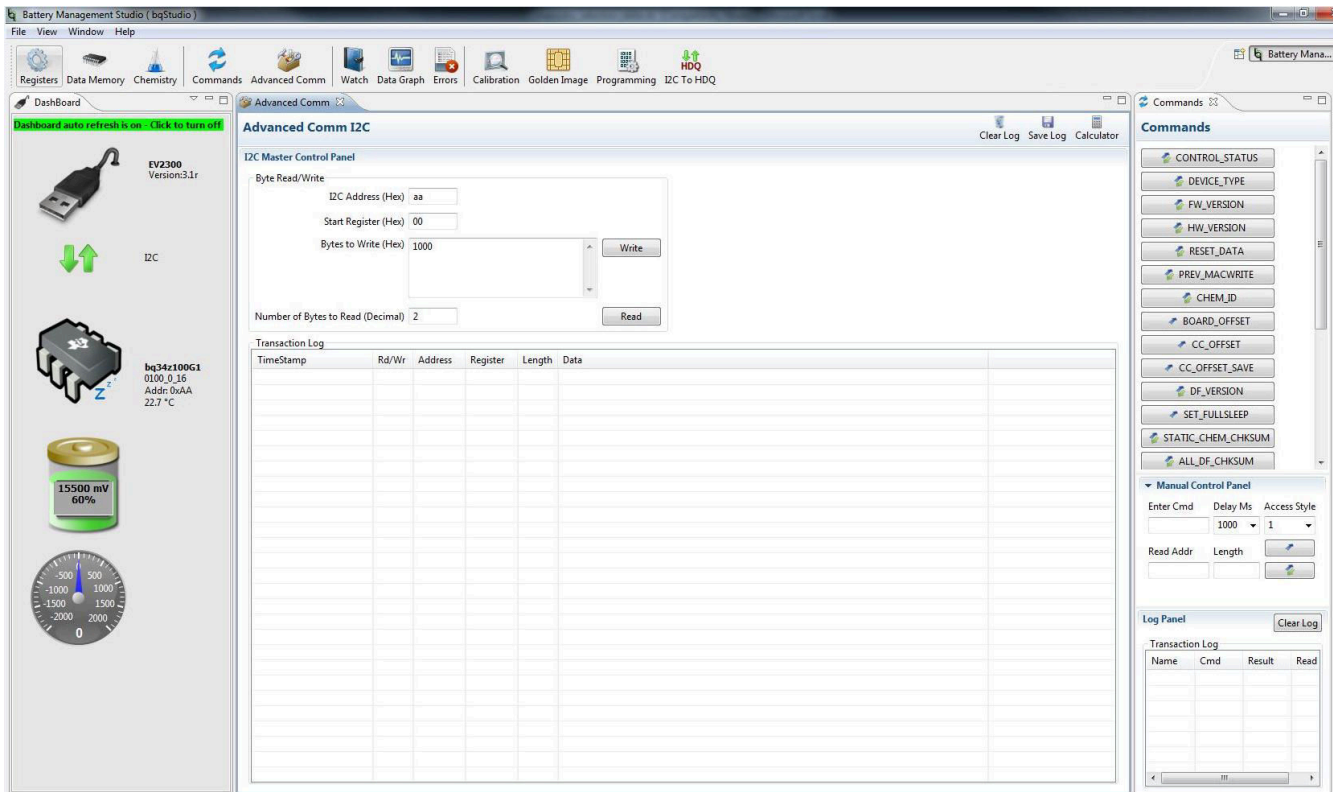

Figure 3-7. Advanced Comm Screen

3.7.1 Examples

Reading Standard Data Commands.

- Read SBData Voltage (0x08)
 - Start Register = 0x08
 - Number of Bytes to Read = 2
 - Press the *Read* button
 - Date returned =8C 3C, which a byte swapped
 - 0x3C8C = 15500mV, when converted to decimal

Sending a MAC Gauging() to enable IT via ManufacturerAccess().

- With Impedance Track™ disabled, send Gauging() (0x0021) to ManufacturerAccess().
 - Start Register = 0x00
 - Bytes to Write = 21 00
 - Press the *Write* button
 - The QEN flag should set in the Control Status register to indicate that Impedance Track is enabled

Reading Control Subcommands. Chemical ID() (0x0008) via ManufacturerAccess()

- Send Chemical ID() to ManufacturerAccess()
 - Start Register = 0x00
 - Bytes to Write = 08 00
 - Press the Write button
 - Start Register = 0x00
 - Number of Bytes to Read = 2
 - Press the *Read* button
 - Data returned =07 01, which a byte swapped
 - That is 0x0107, chem ID 107

3.8 Send HDQ Screen

When using the HDQ single wire serial communication feature, the mode of the gauge must be changed with a special command. This screen provides a button for this purpose. Note the warning message. The process is not reversible. Once in HDQ mode, the HDQ pro screen is available for testing commands and reprogramming the device. For register scanning and data flash access, use the companion evaluation program for HDQ (see [Figure 3-8](#)).

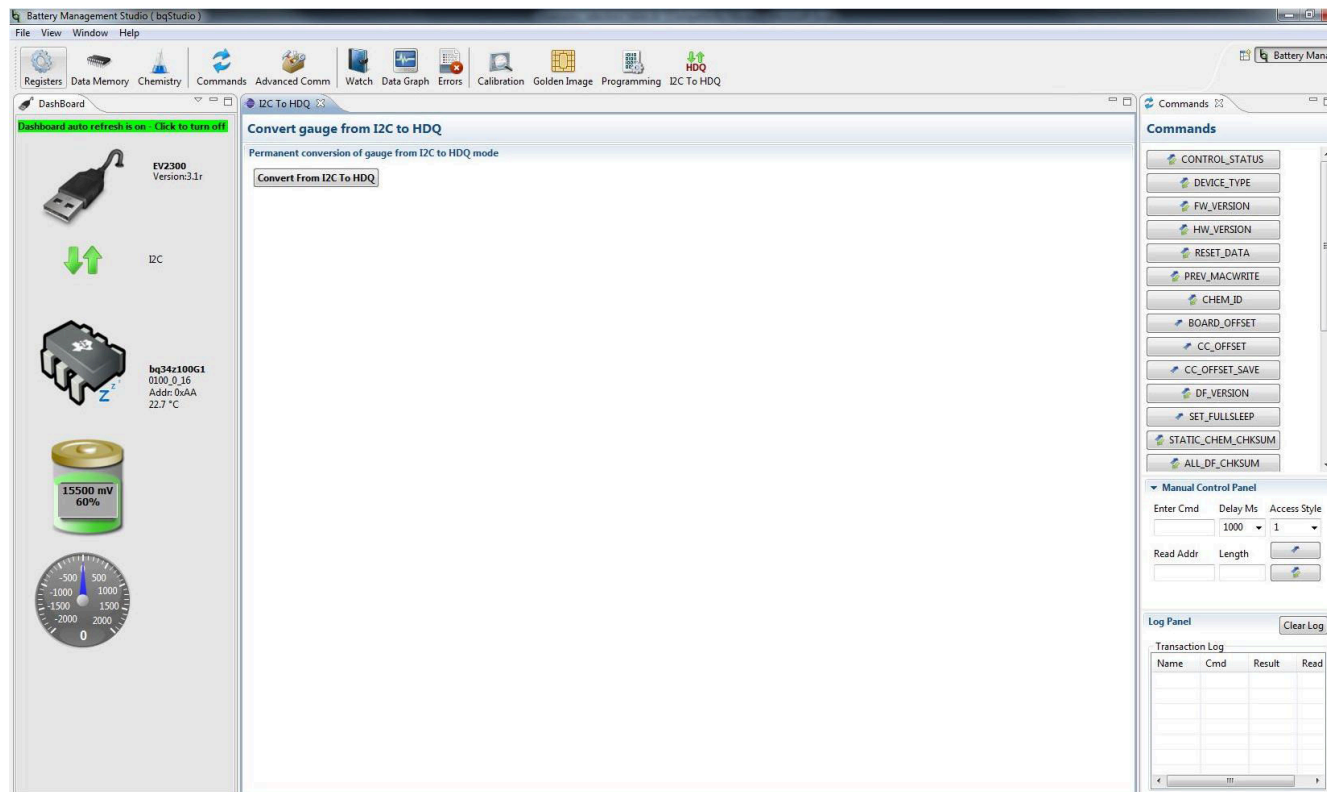

Figure 3-8. Send HDQ Screen

- To the HDQ communications port (HDQ, GND)
 - Attach the Communications Interface Adapter cable to the J7 terminal block (I2C Interface) to the I2C port on the EV2300..
 - Press the Convert From I2C to HDQ button
 - Power cycle the voltage to the device
 - Attach the Communications Interface Adapter cable to the J4 terminal block (HDQ Interface) to the HDQ port on the EV2300
 - Select File | Restart to reload the bqStudio program

WARNING

The conversion to HDQ mode is permanent. TI recommends using the I2C interface to setup, calibrate, and run the optimization cycle.

3.9 Dashboard Panel

The Dashboard panel displays the device type and firmware version. It also provides updates to the Voltage, SOC, Current and Temperature in one location. The Dashboard uses automatic polling, which can cause problems when sending some MAC commands. Dashboard polling can be disabled by clicking the auto refresh field at the top of the panel (see [Figure 3-1](#)).

3.10 Commands Panel

The Commands panel provides a quick and easy access to frequently used I2C and MAC commands. They are mapped to buttons that can be pressed to execute the function. The I2C transaction is logged in the Log Panel (see [Figure 3-1](#)).

4 Circuit Module Physical Layouts

This section contains the printed-circuit board (PCB) layout, assembly drawings, and schematic for the bq34z100 circuit module.

4.1 Board Layout

This section shows the dimensions, PCB layers (Figure 4-1 through Figure 4-6), and assembly drawing for the bq34z100 module.

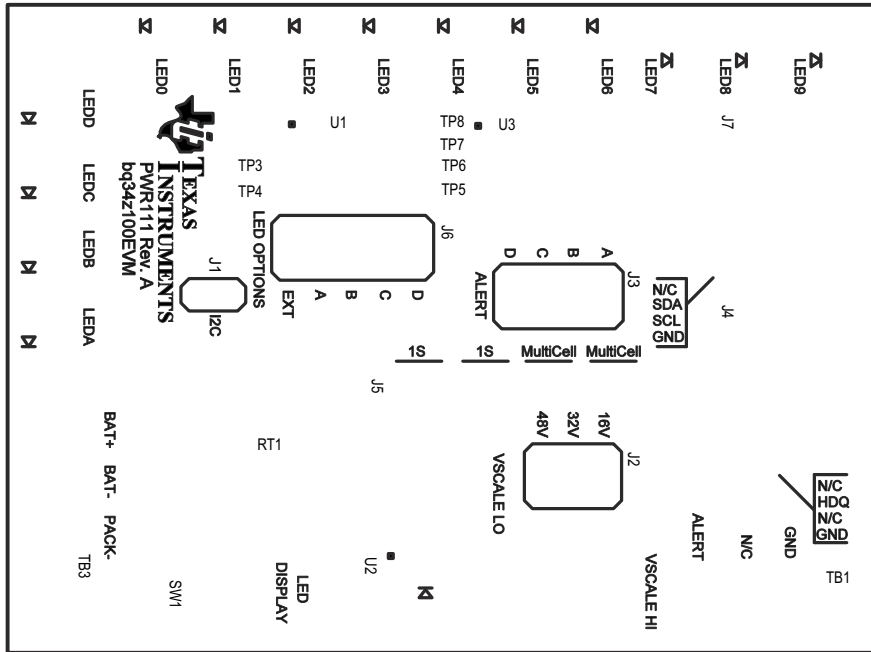

Figure 4-1. Top Silk Screen

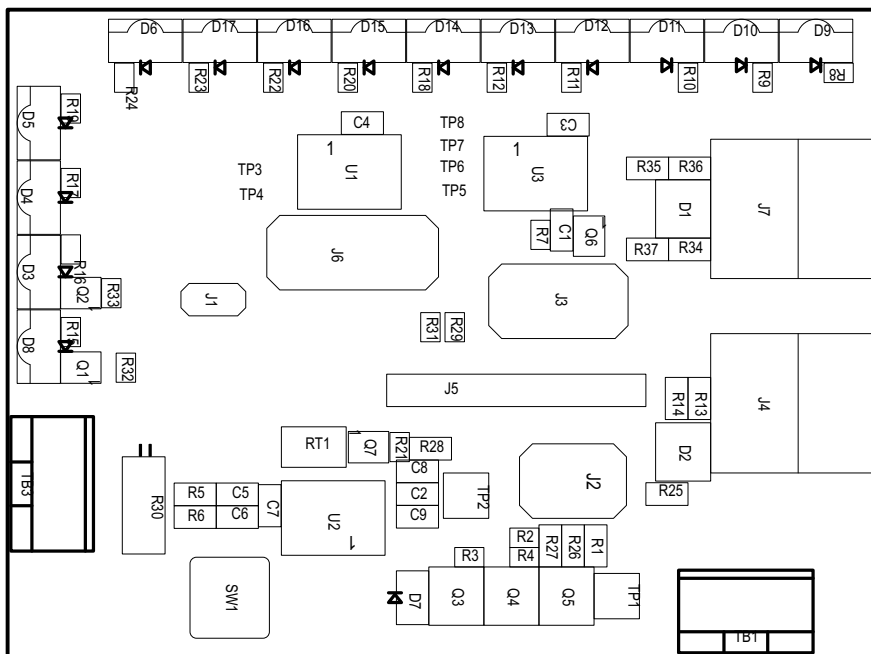

Figure 4-2. Top Assembly

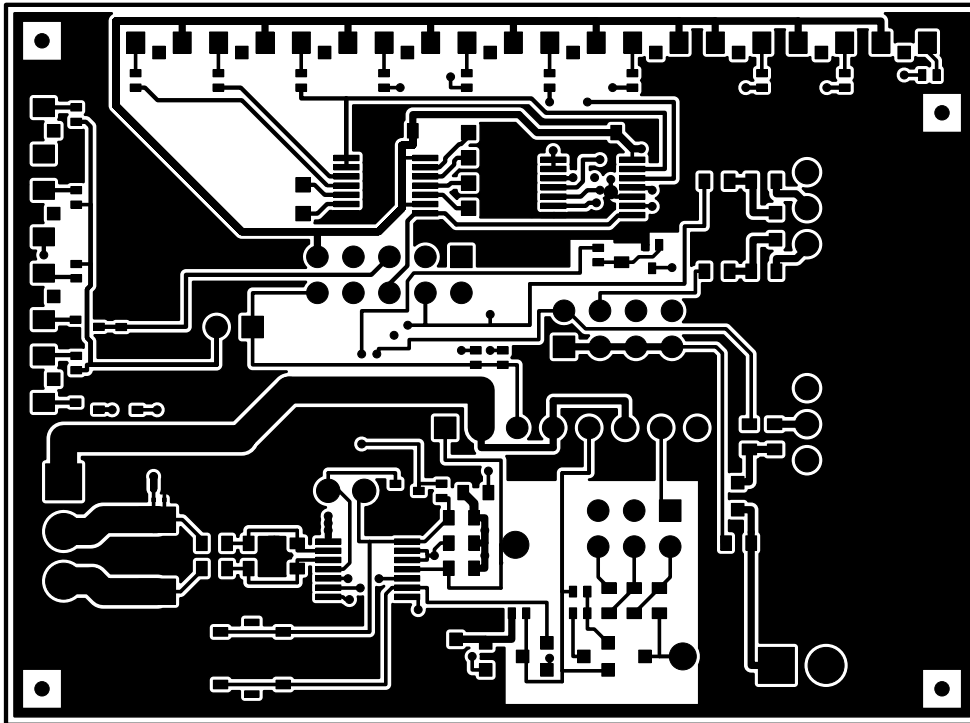

Figure 4-3. Top Layer

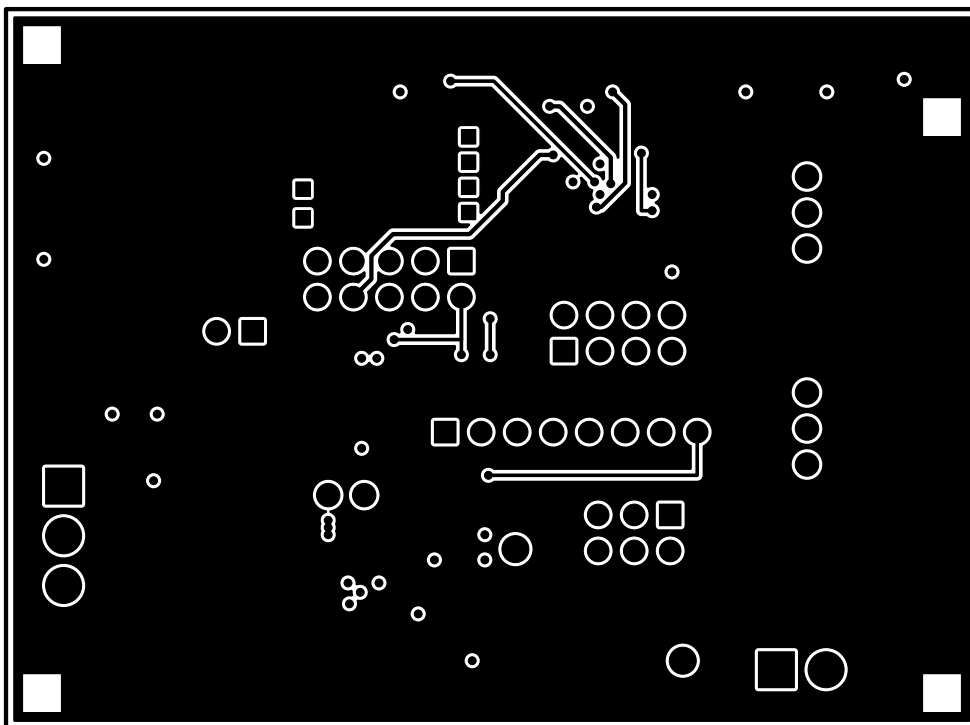

Figure 4-4. Internal Layer 1

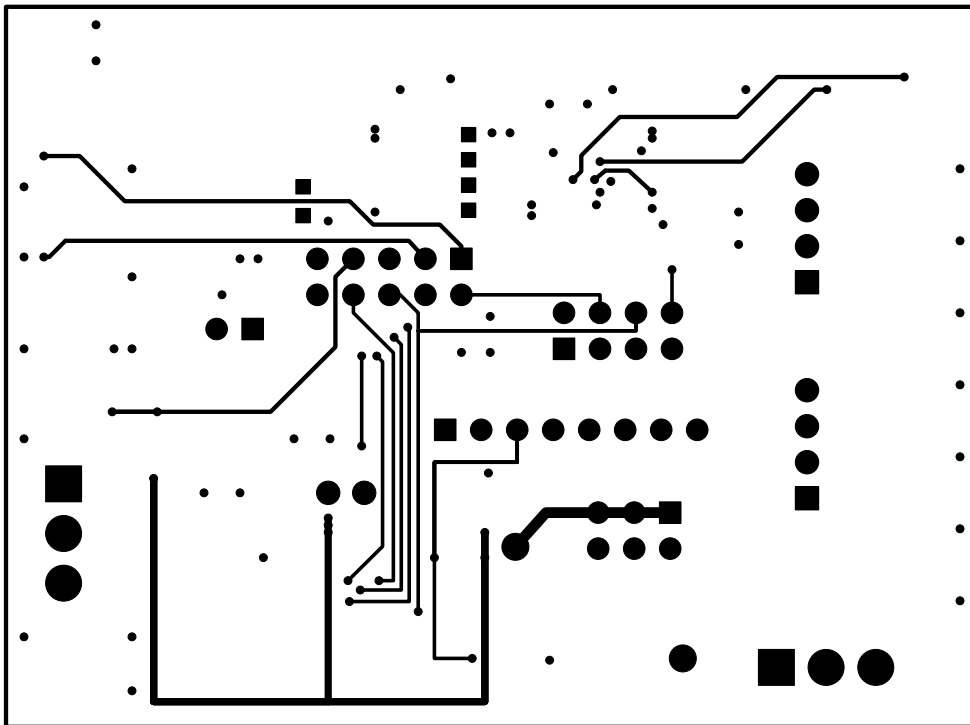

Figure 4-5. Internal Layer 2

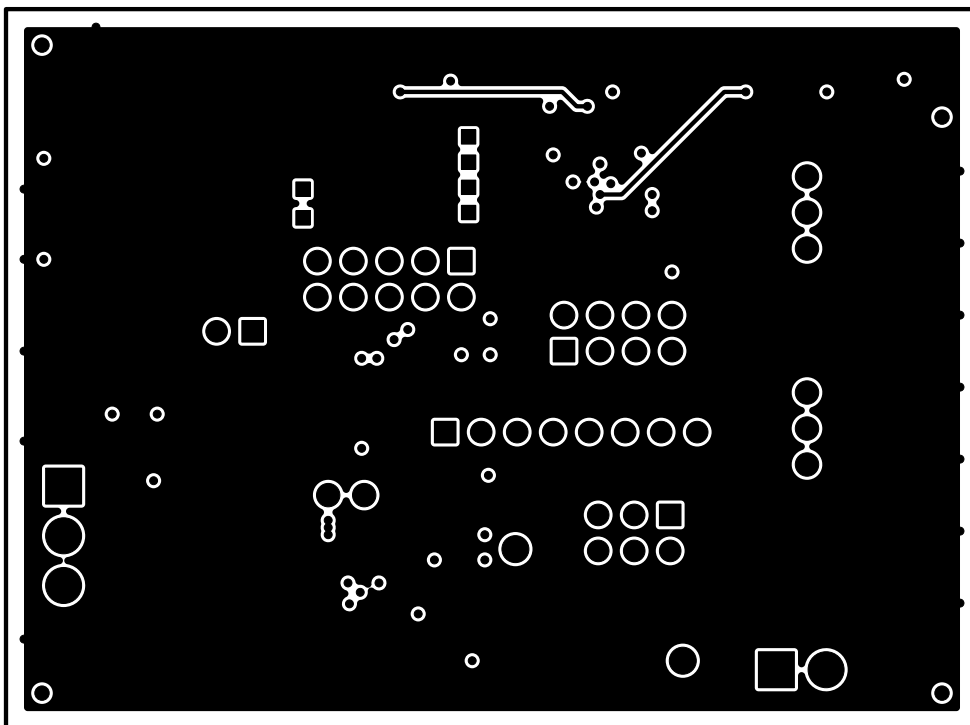

Figure 4-6. Bottom Layer

4.2 Schematic

Figure 4-7 shows the schematic for this EVM.

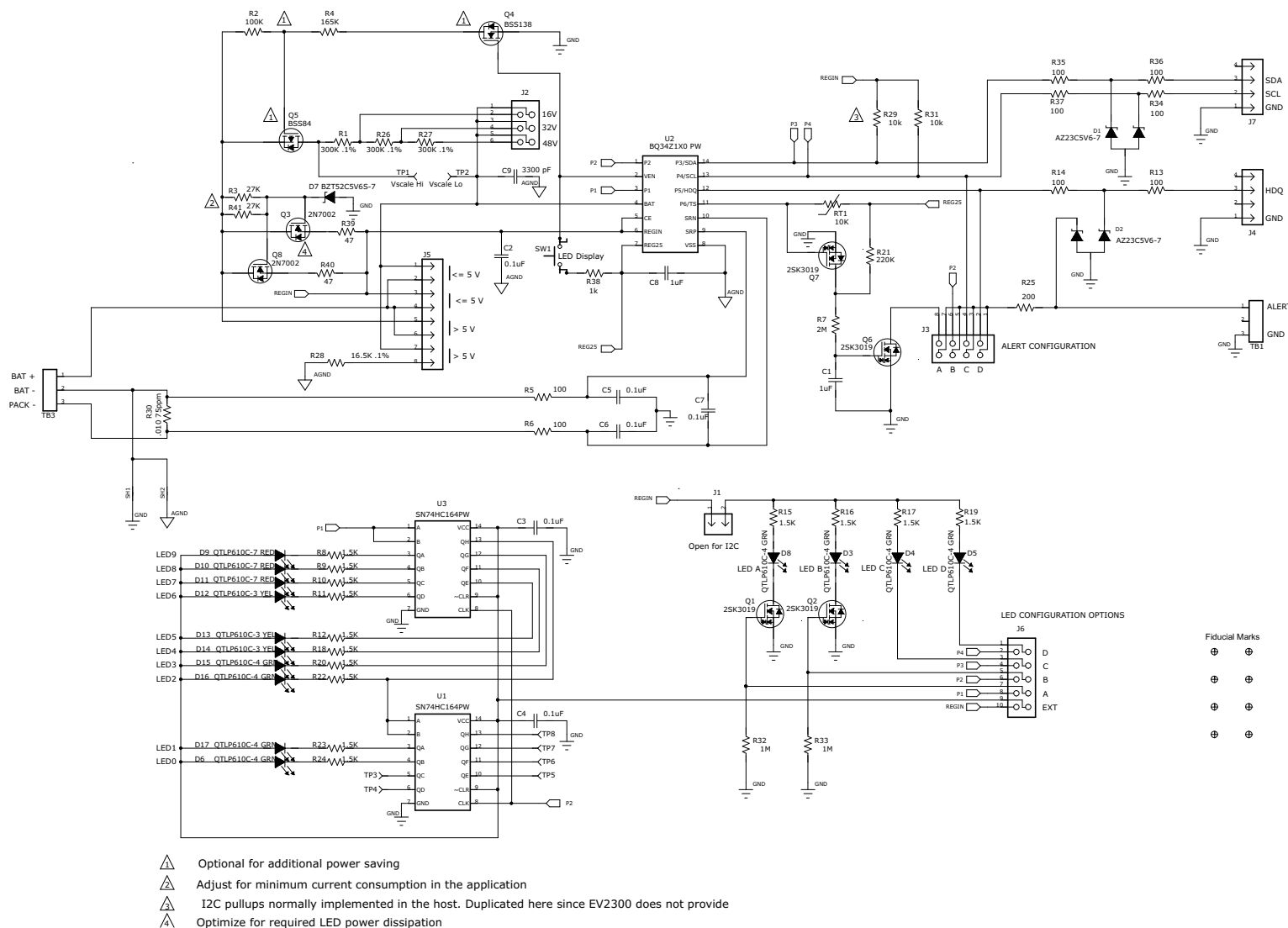

Figure 4-7. bq34z100EVM-003 Schematic

4.3 Bill of Materials

Table 4-1 lists the bill of materials (BOM) for this EVM.

Table 4-1. Bill of Materials

Count	RefDes	Value	Description	Size	Part Number	MFR
2	C1, C8	1 μ F	Capacitor, ceramic, 6.3 V, X7R, 20%	0603	Std	Any
6	C2–C7	0.1 μ F	Capacitor, ceramic, 50 V, X7R, 20%	0603	Std	Any
1	C9	3300 pF	Capacitor, ceramic, 50 V, X7R, 20%	0603	Std	Any
2	D1, D2	AZ23C5V6-7	Diode, dual, Zener, 5.6 V, 300 mW	SOT23	AZ23C5V6-7	Diodes
3	D12–D14	QTLP610C-3 YEL	Diode, LED yellow, 30 mA	0.126 × 0.087 in	QTLP610C-3	Fairchild
8	D3–D6, D8, D15–D17	QTLP610C-4 GRN	Diode, LED green, 30 mA	0.126 × 0.087 in	QTLP610C-4	Fairchild
1	D7	BZT52C5V6S-7	Diode, Zener, 200 mW, 5.6 V	SOD-323	BZT52C5V6S-7	Diodes Inc
3	D9–D11	QTLP610C-7 RED	Diode, LED red, 30 mA	0.126 × 0.087 in	QTLP610C-7	Fairchild
1	J1	PEC02SAAN	Header, male 2-pin, 100 mil spacing,	0.100 in × 2	PEC02SAAN	Sullins
1	J2	PEC03DAAN	Header, male 2 × 3-pin, 100 mil spacing	0.20 in × 0.30	PEC03DAAN	Sullins
1	J3	PEC04DAAN	Header, male 2 × 4-pin, 100 mil spacing	0.20 × 0.40 in	PEC04DAAN	Sullins
2	J4, J7	22-05-3041	Header, friction lock assembly, 4-pin right angle	0.400 × 0.500	22-05-3041	Molex
1	J5	PEC08SAAN	Header, male 8-pin, 100 mil spacing,	0.100 in × 8	PEC08SAAN	Sullins
1	J6	PEC05DAAN	Header, male 2 × 5-pin, 100 mil spacing	0.100 in × 5 × 2	PEC05DAAN	Sullins
4	Q1, Q2, Q6, Q7	2SK3019	MOSFET, N ch, 30V, 100 mA, 8 Ω	SC-75A	2SK3019	Rohm
2	Q3, Q8	2N7002	MOSFET, N ch, 60 V, 115 mA, 1.2 Ω	SOT23	2N7000-7-F	Diodes Inc
1	Q4	BSS138	MOSFET, N ch, 50 V, 0.22 A, 3.5 Ω	SOT23	BSS138	Fairchild
1	Q5	BSS84	MOSFET, P ch, 50 V, 130mA, 10 Ω	SOT23	BSS84	Fairchild
3	R1, R26, R27	300 k Ω	Resistor, chip, 0.1W, 0.1%, \pm 25 ppm/C $^{\circ}$	0603	RG1608P-304-B-T5	SSM
1	R2	100 k Ω	Resistor, chip, 1/16W, 1%	0402	Std	Std
2	R3, R41	27 k Ω	Resistor, chip, 1/16-W, 5%	0402	Std	Std
1	R21	220 k Ω	Resistor, chip, 1/16W, 5%	0402	Std	Std
1	R25	200 Ω	Resistor, chip, 1/16W, 5%	0603	Std	Any
1	R28	16.5 k Ω	Resistor, chip, 0.1W, 0.1%, \pm 25 ppm/C $^{\circ}$	0603	RG1608P-1652-B-T5	SSM
2	R29, R31	10 k Ω	Resistor, chip, 1/16W, 5%	0402	Std	Std
1	R30	.010 Ω	Resistor, chip, 1/2W, 1%, \pm 75 ppm/C $^{\circ}$	2010	WSL2010R0100FEA	Dale
2	R32, R33	1 M Ω	Resistor, chip, 1/16W, 5%	0402	Std	Std
1	R4	165 k Ω	Resistor, chip, 1/16W, 1%	0402	Std	Std
8	R5, R6, R13, R14, R34–R37	100 Ω	Resistor, chip, 1/16W, 5%	0603	STD	Any
1	R7	2 M Ω	Resistor, chip, 1/16W, 5%	0402	Std	Std
14	R8–R12, R15–R20, R22–R24	1 k Ω	Resistor, chip, 1/16W, 5%	0402	Std	Std
1	RT1	10 k Ω	Thermistor, NTC, 3 A	0.095 × 0.150 in	103AT-2	Semitec
1	SW1	EVQ-PLHA15	Switch, push button, momentary, N.O. low profile	0.200 × 0.200 in	EVQ-PLHA15	Panasonic
2	TB1, TB3	ED555/3DS	Terminal block, 3 pin, 6 A, 3.5 mm	0.41 × 0.25 in	ED555/3DS	OST
1	TP1	Vscale Hi	Test point, black, thru hole color keyed	0.100 × 0.100 in	5001	Keystone
1	TP2	Vscale Lo	Test point, black, thru hole color keyed	0.100 × 0.100 in	5001	Keystone
0	TP3–TP8	STD	Test point, 0.020 Hole		STD	STD
2	U1, U3	SN74HC164PW	IC, 8-Bit Parallel-Out Serial Shift Registers	TSSOP-14	SN74HC164PW	TI
1	U2	BQ34100PW-G1	IC, Gas gauge	TSSOP	BQ342100PW-G1	
1	–		PCB, 68 mm × 50 mm × 1 mm		PWR111	Any

5 Related Documentation from Texas Instruments

For related documentation, contact the TI field representative.

1. *bq34z100-G1 Wide Range Fuel Gauge with Impedance Track™ Technology* datasheet, [SLUSBZ5](#)

6 Revision History

NOTE: Page numbers for previous revisions may differ from page numbers in the current version.

Changes from Revision A (January 2015) to Revision B (April 2021)	Page
• Changed from less than 5 V to greater than 5 V in Section 3.2.1	8

Changes from Revision * (April 2012) to Revision A (January 2015)	Page
• Deleted the paragraphs in the Abstract and replace with new one.....	1
• Deleted the second Itemized List from Kit Contents and replaced with new text.....	3
• Changed the text in the second and third column of the Ordering information	3
• Added Documentation and subheadings to the first section.....	3
• Changed or rearranged most of this User Guide with new text, tables, and graphics.....	4
• Changed Schematic.....	20
• Changed <i>Bill of Materials</i>	21

IMPORTANT NOTICE AND DISCLAIMER

TI PROVIDES TECHNICAL AND RELIABILITY DATA (INCLUDING DATA SHEETS), DESIGN RESOURCES (INCLUDING REFERENCE DESIGNS), APPLICATION OR OTHER DESIGN ADVICE, WEB TOOLS, SAFETY INFORMATION, AND OTHER RESOURCES "AS IS" AND WITH ALL FAULTS, AND DISCLAIMS ALL WARRANTIES, EXPRESS AND IMPLIED, INCLUDING WITHOUT LIMITATION ANY IMPLIED WARRANTIES OF MERCHANTABILITY, FITNESS FOR A PARTICULAR PURPOSE OR NON-INFRINGEMENT OF THIRD PARTY INTELLECTUAL PROPERTY RIGHTS.

These resources are intended for skilled developers designing with TI products. You are solely responsible for (1) selecting the appropriate TI products for your application, (2) designing, validating and testing your application, and (3) ensuring your application meets applicable standards, and any other safety, security, regulatory or other requirements.

These resources are subject to change without notice. TI grants you permission to use these resources only for development of an application that uses the TI products described in the resource. Other reproduction and display of these resources is prohibited. No license is granted to any other TI intellectual property right or to any third party intellectual property right. TI disclaims responsibility for, and you will fully indemnify TI and its representatives against, any claims, damages, costs, losses, and liabilities arising out of your use of these resources.

TI's products are provided subject to [TI's Terms of Sale](#) or other applicable terms available either on ti.com or provided in conjunction with such TI products. TI's provision of these resources does not expand or otherwise alter TI's applicable warranties or warranty disclaimers for TI products.

TI objects to and rejects any additional or different terms you may have proposed.

Mailing Address: Texas Instruments, Post Office Box 655303, Dallas, Texas 75265
Copyright © 2022, Texas Instruments Incorporated