

# **bq40z50EVM Li-Ion Battery Pack Manager Evaluation Module**



Tom Cosby  
Roger Hwang

## **ABSTRACT**

This evaluation module (EVM) is a complete evaluation system for the bq40z50 or bq296000 battery management system. The EVM includes one bq40z50 and bq296000 circuit module and a link to Microsoft® Windows® based PC software. The circuit module includes one bq40z50 integrated circuit (IC), one bq296000 IC, and all other onboard components necessary to monitor and predict capacity, perform cell balancing, monitor critical parameters, protect the cells from overcharge, over-discharge, short-circuit, and overcurrent in 1-, 2-, 3-, or 4-series cell Li-ion or Li-polymer battery packs. The circuit module connects directly across the cells in a battery. With the EV2300 or EV2400 interface board and software, the user can read the bq40z50 data registers, program the chipset for different pack configurations, log cycling data for further evaluation, and evaluate the overall functionality of the solution under different charge and discharge conditions.

## **Table of Contents**

<b>1 Features</b> .....	<b>2</b>
1.1 Kit Contents.....	2
1.2 Ordering Information.....	2
1.3 Documentation.....	2
1.4 bq40z50 and bq296000 Circuit Module Performance Specification Summary.....	2
<b>2 bq40z50EVM Quick Start Guide</b> .....	<b>3</b>
2.1 Items Needed for EVM Setup and Evaluation.....	3
2.2 Software Installation.....	3
2.3 EVM Connections.....	4
2.4 Update Firmware.....	5
<b>3 Battery Management Studio</b> .....	<b>6</b>
3.1 Registers Screen.....	6
3.2 Setting Programmable bq40z50 Options.....	6
3.3 Calibration Screen.....	7
3.4 Chemistry Screen.....	9
3.5 Firmware Screen.....	10
3.6 Advanced Comm SMB Screen.....	11
<b>4 bq40z50EVM Circuit Module Schematic</b> .....	<b>12</b>
4.1 Pre-Charge.....	12
4.2 LED Control.....	12
4.3 Emergency Shutdown.....	12
4.4 Testing Fuse-Blowing Circuit.....	12
4.5 PTC Thermistor.....	13
<b>5 Circuit Module Physical Layouts</b> .....	<b>13</b>
5.1 Board Layout.....	13
5.2 Schematic.....	16
<b>6 Bill of Materials</b> .....	<b>17</b>
<b>7 Related Documentation from Texas Instruments</b> .....	<b>18</b>
<b>8 Revision History</b> .....	<b>18</b>

## List of Figures

Figure 2-1. bq40z50 Circuit Module Connection to Cells and System Load or Charger.....	4
Figure 2-2. Cell Connection Configuration.....	4
Figure 3-1. Registers Screen.....	6
Figure 3-2. Data Flash Screen.....	7
Figure 3-3. Calibration Screen.....	7
Figure 3-4. Chemistry Screen.....	9
Figure 3-5. Firmware Screen.....	10
Figure 3-6. Advanced Comm Screen.....	11
Figure 4-1. Fuse Trace Modifications.....	12
Figure 5-1. Top Silk Screen.....	13
Figure 5-2. Bottom Silk Screen.....	13
Figure 5-3. Top Assembly.....	14
Figure 5-4. Bottom Assembly.....	14
Figure 5-5. Top Layer.....	14
Figure 5-6. Internal Layer 1.....	15
Figure 5-7. Internal Layer 2.....	15
Figure 5-8. Bottom Layer.....	15

## Trademarks

Impedance Track™ is a trademark of TI.

Microsoft® and Windows® are registered trademarks of Microsoft Corporation.

All trademarks are the property of their respective owners.

## 1 Features

- Complete evaluation system for the bq40z50EVM Li-Ion Battery Pack Manager Evaluation Module and bq296000 independent overvoltage protection IC
- Populated circuit module for quick setup
- Software that allows data logging for system analysis

### 1.1 Kit Contents

- bq40z50 and bq296000 circuit module
- Cable to connect the EVM to an EV2300 or EV2400 communications interface adapter

### 1.2 Ordering Information

For complete ordering information, see the product page at [www.ti.com](http://www.ti.com).

**Table 1-1. Ordering Information**

EVM PART NUMBER	CHEMISTRY	CONFIGURATION	CAPACITY
bq40z50EVM-561	Li-ion	1-, 2-, 3-, or 4-cell	Any

### 1.3 Documentation

See the device data sheets for [bq40z50](#) and [bq296000](#) and technical reference manuals (TRMs) on [www.ti.com](http://www.ti.com) for information on device firmware and hardware.

### 1.4 bq40z50 and bq296000 Circuit Module Performance Specification Summary

This section summarizes the performance specifications of the bq40z50 and bq296000 EVM.

**Table 1-2. Performance Specification Summary**

Specification	Minimum	Typical	Maximum	Units
Input voltage Pack+ to Pack–	3	15	26	V
Charge and discharge current	0	2	7	A

## 2 bq40z50EVM Quick Start Guide

This section provides the step-by-step procedures required to use a new EVM and configure it for operation in a laboratory environment.

### 2.1 Items Needed for EVM Setup and Evaluation

- bq40z50 or bq296000 circuit module
- EV2300 or EV2400 communications interface adapter
- Cable to connect the EVM to an EV2300 or EV2400 communications interface adapter
- USB cable to connect the communications interface adapter to the computer
- Computer setup with Windows XP, or higher, operating system
- Access to the Internet to download the Battery Management Studio software setup program
- One-to-four battery cells or 1-k $\Omega$  resistors to configure a cell simulator
- A DC power supply that can supply 16.8 V and 2 A (constant current and constant voltage capability is desirable)

### 2.2 Software Installation

Find the latest software version in the bq40z50 tool folder on [www.ti.com](http://www.ti.com). Use the following steps to install the bq40z50 Battery Management Studio software:

1. Download and run the Battery Management Studio setup program from the Development Tools section of the bq40z50EVM product folder on [www.ti.com](http://www.ti.com). See [Section 3](#) for detailed information on using the tools in the Battery Management Studio.
2. If the communications interface adapter was not previously installed, after the Battery Management Studio installation, a TI USB driver installer pops up. Click "Yes" for the agreement message and follow its instructions. Two drivers are associated with the EV2300 and an additional file may be required for the EV2400. Follow the instructions to install both. Do not reboot the computer, even if asked to do so.
3. Plug the communications interface adapter into a USB port using the USB cable. The Windows system may show a prompt that new hardware has been found. When asked, "Can Windows connect to Windows Update to search for software?", select "No, not this time", and click "Next". In the next dialog window, it indicates "This wizard helps you install software for: TI USB Firmware Updater". Select "Install the software automatically (Recommended)" and click "Next". It is common for the next screen to be the Confirm File Replace screen. Click "No" to continue. If this screen does not appear, then go to the next step. After Windows indicates that the installation was finished, a similar dialog window pops up to install the second driver. Proceed with the same installation preference as the first one. The second driver is TI USB bq80xx Driver.

### 2.3 EVM Connections

This section covers the hardware connections for the EVM. See [Figure 2-1](#).

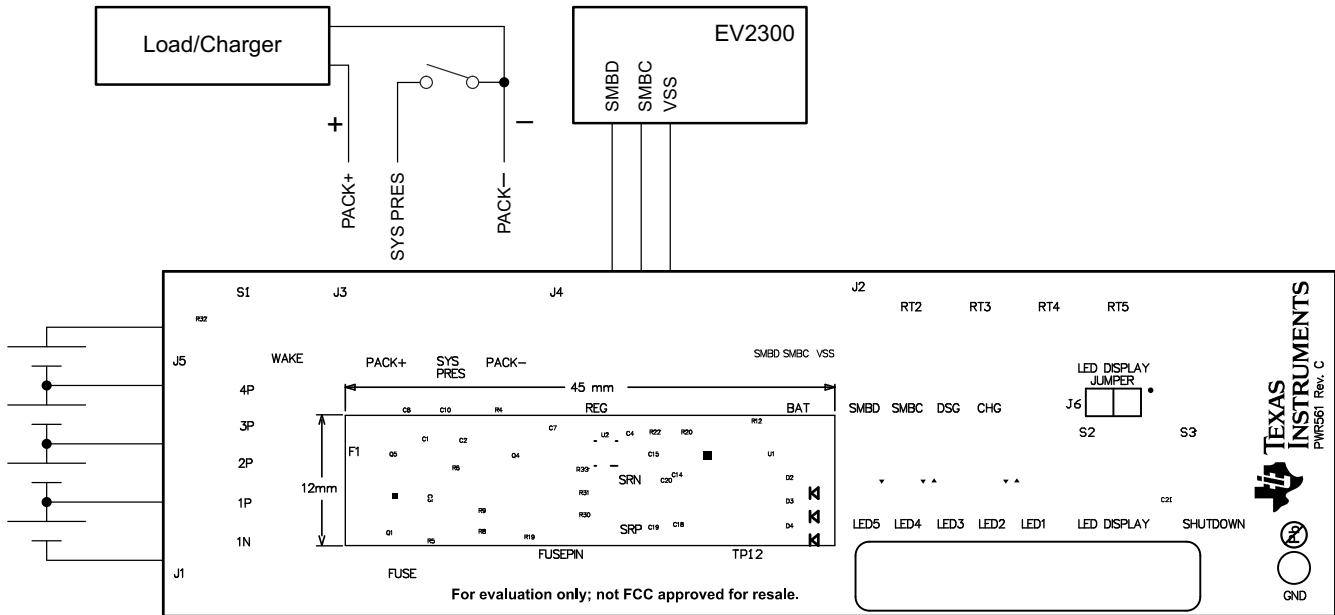

**Figure 2-1. bq40z50 Circuit Module Connection to Cells and System Load or Charger**

- Direct connection to the cells: 1N (BAT–), 1P, 2P, 3P, 4P (BAT+)

Attach the cells to the J1 and J5 terminal block. A specific cell connection sequence is not required; although, it is good practice to start with lowest cell in the stack (cell 1), then attach cells 2 through 4 in sequence. The U1 and U2 devices should not be damaged by other cell connection sequences, but there is a possibility that the bq296000 could blow the fuse. Attaching cells starting with cell 1 should eliminate this risk. A short should be placed across unused voltage sense inputs. See [Figure 2-2](#).

Number of Cells	J1 and J5 Terminal Block Connections								
	1N		1P		2P		3P		4P
1	⊖	-cell1+	⊖	short	⊖	short	⊖	short	⊖
2	⊖	-cell1+	⊖	-cell2+	⊖	short	⊖	short	⊖
3	⊖	-cell1+	⊖	-cell2+	⊖	-cell3+	⊖	short	⊖
4	⊖	-cell1+	⊖	-cell2+	⊖	-cell3+	⊖	-cell4+	⊖

**Figure 2-2. Cell Connection Configuration**

A resistor cell simulator can be used instead of battery cells. Connect a resistor between each of the contacts on the J1 or J5 connector. For example, from 1N to 1P, from 1P to 2P, and so forth, until the desired number of cells has been achieved. A power supply can provide power to the cell simulator. Set the power supply to the desired cell voltage × the number of cells and attach the ground wire to 1N and the positive wire to 4P. For example, for a 3S configuration with a 3.6-V cell voltage, set the power supply to 3 × 3.6 = 10.8 V.

- Serial communications port (SMBC, SMBD)

Attach the communications interface adapter cable to J2 and to the SMB port on the EV2300.

- System load and charger connections across PACK+ and PACK–

Attach the load or power supply to the J3 or J4 terminal block. The positive load or power supply wire should be connected to at least one of the first two terminal block positions labeled PACK+. The ground wire for the load or power supply should be connected to the last terminal block positions labeled PACK–.

- System-present pin (SYS PRES)

To start charge or discharge test, connect the SYS PRES position on the J3 terminal block to PACK–. The SYS PRES can be left open if the non-removable (NR) bit is set to 1 in the Pack Configuration A register. To test sleep mode, disconnect the SYS PRES pin.

- Wake-up the device up from shutdown (WAKE)

Press the Wake pushbutton switch to temporarily connect Bat+ to Pack+. This applies voltage to the PACK pin on the bq40z50 to power-up the regulators and start the initialization sequence.

- Parameter setup

The default data flash settings configure the device for 3-series Li-Ion cells. The user should change the | Data Flash | Settings | DA Configuration register to set up the number of series cells to match the physical pack configuration. This provides basic functionality to the setup. Other data flash parameters should also be updated to fine tune the gauge to the pack. See the bq40z50 TRM for help with setting the parameters.

## 2.4 Update Firmware

Find the latest firmware version in the appropriate bq40z50 folder on [www.ti.com](http://www.ti.com). Use the following steps to install the bq40z50 *Battery Management Studio* software:

1. Run *Battery Management Studio* from the **Start | Programs | Texas Instruments | Battery Management Studio** menu sequence, or the *Battery Management Studio* shortcut.
2. Follow the directions in [Section 3.5](#), select the firmware .srec file downloaded from [www.ti.com](http://www.ti.com), and click the **Program** button.
3. Once programming is finished, the EVM is ready to use with the latest firmware.

### 3 Battery Management Studio

#### 3.1 Registers Screen

Run Battery Management Studio from the Start | Programs | Texas Instruments | Battery Management Studio menu sequence, or the Battery Management Studio shortcut. The Registers screen (see [Figure 3-1](#)) appears. The Registers section contains parameters used to monitor gauging. The Bit Registers section provides bit level picture of status and fault registers. A green flag indicates that the bit is 0 (low state) and a red flag indicates that the bit is 1 (high state). Data begins to appear once the *Refresh* (single-time scan) button is selected, or it scans continuously if the *Scan* button is selected.

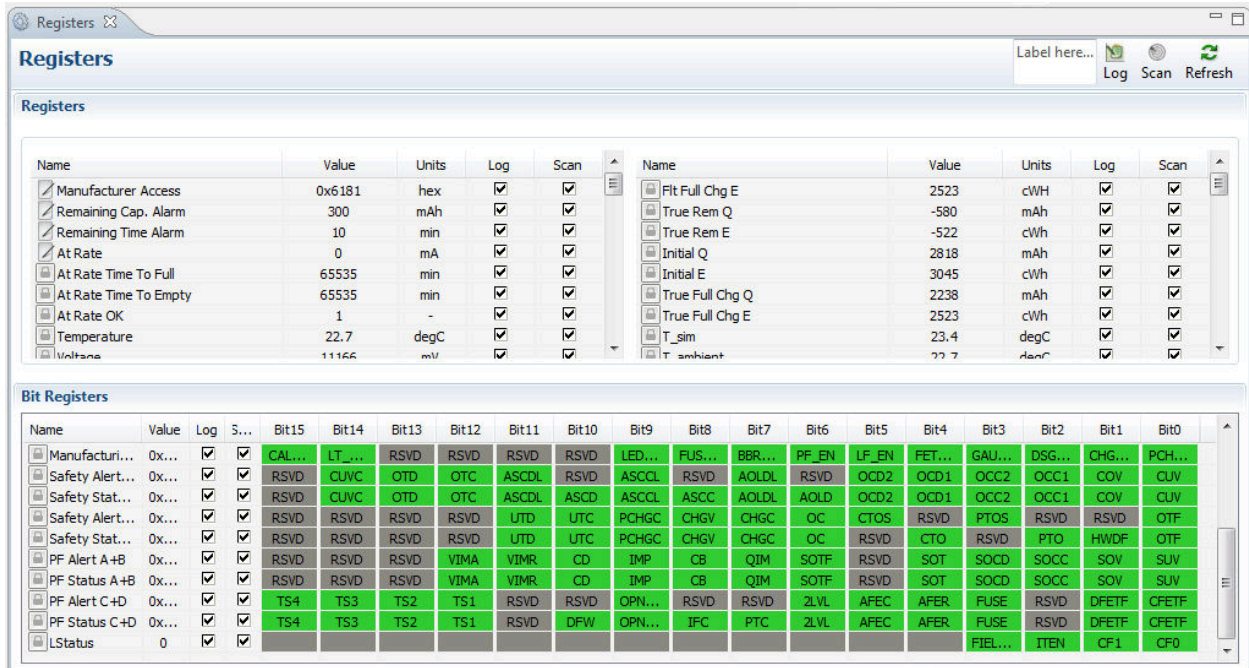

Figure 3-1. Registers Screen

The continuous scanning period can be set via the | Window | Preferences | SBS | Scan Interval | menu selections.

The Battery Management Studio program provides a logging function which logs the values that are selected by the Log check boxes located beside each parameter in the Register section. To enable this function, select the *Log* button; this causes the *Scan* button to be selected. When logging is stopped, the *Scan* button is still selected and has to be manually deselected.

#### 3.2 Setting Programmable bq40z50 Options

The bq40z50 data flash comes configured per the default settings detailed in the bq40z50 TRM. Ensure that the settings are correctly changed to match the pack and application for the solution being evaluated.

**Note**

The correct setting of these options is essential to get the best performance. The settings can be configured using the Data Flash screen (see [Figure 3-2](#)).

Name	Value	Unit	Physical Start Ad...	Data Length	Row Number	Row Offset	Native Units
<b>Voltage</b>							
Cell Gain	12083	-	0x4000	2	0	0	-
Pack Gain	49173	-	0x4002	2	0	2	-
BAT Gain	48867	-	0x4004	2	0	4	-
<b>Current</b>							
CC Gain	1.036	mOhm	0x4006	4	0	6	-
Capacity Gain	1.036	mOhm	0x400a	4	0	10	-
<b>Current Offset</b>							
CC Offset	0	-	0x400e	2	0	14	-
Coulomb Counter Offset Samples	64	-	0x4010	2	0	16	-
Board Offset	0	-	0x4012	2	0	18	-
CC Auto Config	03	hex	0x40c0	1	6	0	hex
CC Auto Offset	0	-	0x40c1	2	6	1	-
<b>Temperature</b>							
Internal Temp Offset	4.2	degC	0x4014	1	0	20	0.1degC
External1 Temp Offset	1.5	degC	0x4015	1	0	21	0.1degC
External2 Temp Offset	1.7	degC	0x4016	1	0	22	0.1degC
External3 Temp Offset	1.9	degC	0x4017	1	0	23	0.1degC
External4 Temp Offset	1.5	degC	0x4018	1	0	24	0.1degC
<b>Internal Temp Model</b>							
Int Gain	-12143	-	0x45c0	2	46	0	-
Int base offset	6232	-	0x45c2	2	46	2	-
Int Minimum AD	0	-	0x45c4	2	46	4	-
Int Maximum Temp	6232	0.1degK	0x45c6	2	46	6	0.1degK
<b>Cell Temperature Model</b>							
Coeff a1	-11130	-	0x45c8	2	46	8	-
Coeff a2	19142	-	0x45ca	2	46	10	-
Coeff a3	-19262	-	0x45cc	2	46	12	-

**Figure 3-2. Data Flash Screen**

### 3.3 Calibration Screen

The voltages, temperatures, and currents should be calibrated to provide good gauging performance.

Press the *Calibration* button to select the Advanced Calibration window. See [Figure 3-3](#).

**Advanced Calibration**

**Perform Calibration**

Select the types of calibration to perform and enter the actual input parameters in the corresponding boxes

**Current Calibration**

Applied Current  
 mA  Calibrate Current

**Voltage calibration**

Applied Cell 1 voltage  
 mV  Calibrate Voltage

Applied Battery Voltage  
 mV  Calibrate Battery Voltage

Applied Pack voltage  
 mV  Calibrate Pack Voltage

**Temperature calibration**

Sensor	Applied temperature	Calibrate
Internal	<input type="text"/> deg C	<input type="checkbox"/>
External 1	<input type="text"/> deg C	<input type="checkbox"/>
External 2	<input type="text"/> deg C	<input type="checkbox"/>

**Figure 3-3. Calibration Screen**

#### 3.3.1 Voltage Calibration

- Measure the voltage from Cell 1 to 1N and enter this value in the Applied Cell 1 Voltage field and select the Calibrate Voltage box.

- Measure the voltage from Bat+ to Bat– and enter this value in the Applied Battery Voltage field and select the Calibrate Battery Voltage box.
- Measure the voltage from Pack+ to Pack– and enter this value in the Applied Pack Voltage field and select the Calibrate Pack Voltage box. If the voltage is not present, then turn the charge and discharge FETs on by entering a 0x0022 command in the Manufacturer Access register on the Register screen.
- Press the *Calibrate Gas Gauge* button to calibrate the voltage measurement system.
- Deselect the Calibrate Voltage boxes after voltage calibration has completed.

### 3.3.2 Temperature Calibration

- Enter the room temperature in each of the Applied Temperature fields and select the Calibrate box for each thermistor to be calibrated. The temperature values must be entered in degrees Celsius.
- Press the *Calibrate Gas Gauge* button to calibrate the temperature measurement system.
- Deselect the Calibrate boxes after temperature calibration has completed.

### 3.3.3 Current Calibration

The Board Offset calibration option is not offered in Battery Management Studio, because it is not required when using the bq40z50EVM. The Board Offset calibration option is available in bqProduction.

- Connect and measure a 2-A current source from 1N (–) and Pack– (+) to calibrate without using the FETs. (TI does not recommend calibration using the FETs.)
- Enter –2000 in the Applied Current field and select the Calibrate Current box.
- Press the *Calibrate Gas Gauge* button to calibrate.
- Deselect the Calibrate Current box after current calibration has completed.

---

#### Note

Current can also be calibrated using the FETs. Measure the current in the discharge path and enter this value in the Applied Current field.

---



### 3.4 Chemistry Screen

The chemistry file contains parameters that the simulations use to model the cell and its operating profile. It is critical to program a Chemistry ID that matches the cell into the device. Some of these parameters can be viewed in the Data Flash section of the Battery Management Studio.

Press the *Chemistry* button to select the Chemistry window.

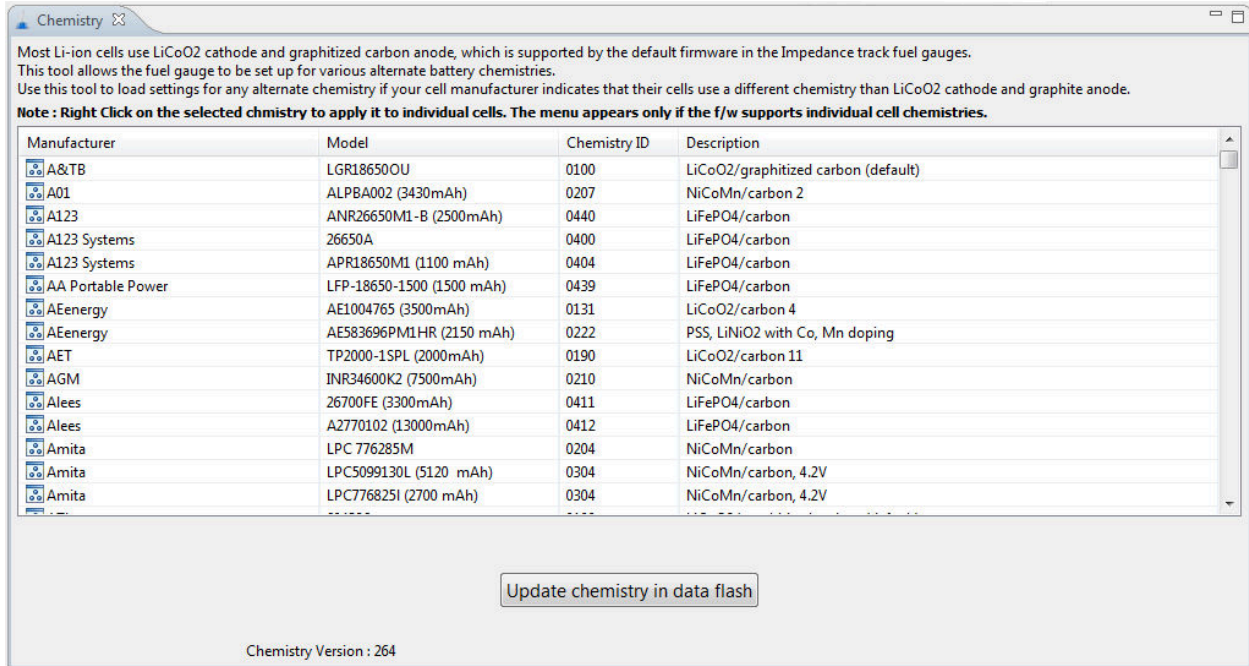

**Figure 3-4. Chemistry Screen**

- The table can be sorted by clicking the desired column. for example: Click the Chemistry ID column header.
- Select the ChemID that matches your cell from the table (see [Figure 3-4](#)).
- Press the Update Chemistry in the *Data Flash* button to update the chemistry in the device.

### 3.5 Firmware Screen

Press the *Firmware* button to select the Firmware Update window. This window allows the user to export and import the device firmware.

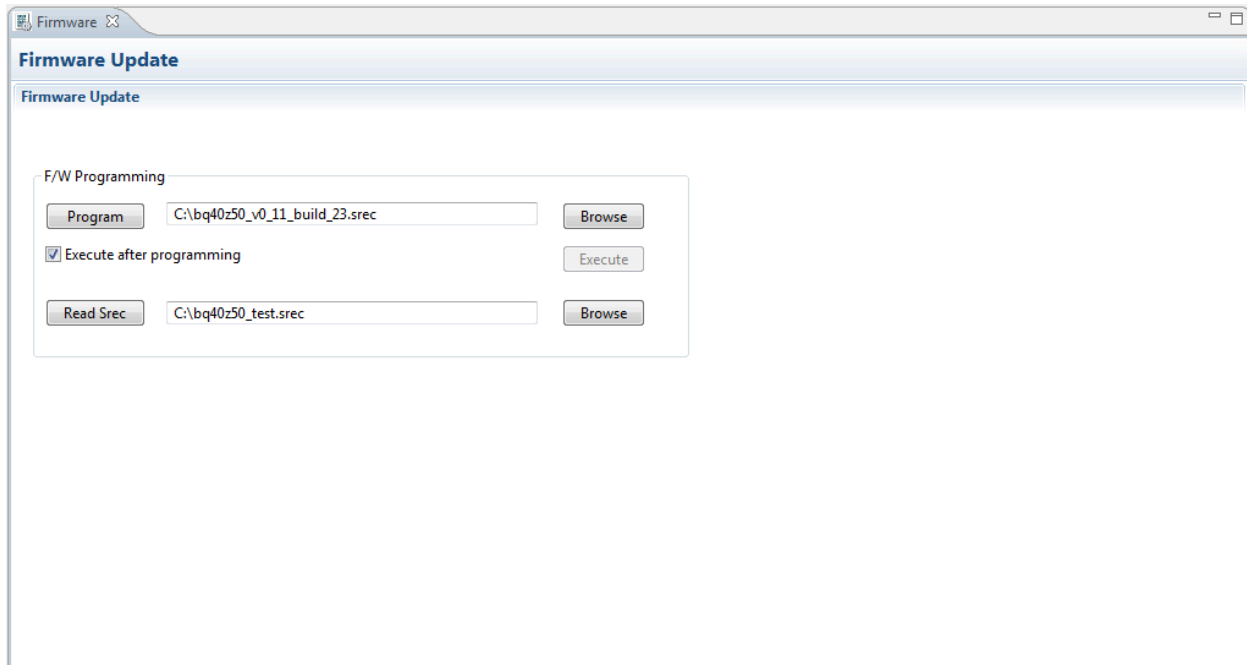

Figure 3-5. Firmware Screen

#### 3.5.1 Programming the Flash Memory

The upper section of the Firmware screen is used to initialize the device by loading the default .srec into the flash memory (see [Figure 3-5](#)).

- Search for the .srec file using the *Browse* button.
- Select the *Execute after programming* box to automatically return the device to Normal mode after programming has completed.
- Press the *Program* button and wait for the download to complete.

#### 3.5.2 Exporting the Flash Memory

The lower section of the Firmware screen is used to export all of the flash memory from the device (see [Figure 3-5](#)).

- Press the *Browse* button and enter an .srec filename.
- Press the *Read Srec* to save the flash memory contents to the file. Wait for the download to complete.

### 3.6 Advanced Comm SMB Screen

Press the *Advanced Comm SMB* button to select the Advanced SMB Comm window. This tool provides access to parameters using SMB and Manufacturing Access commands. See [Figure 3-6](#).

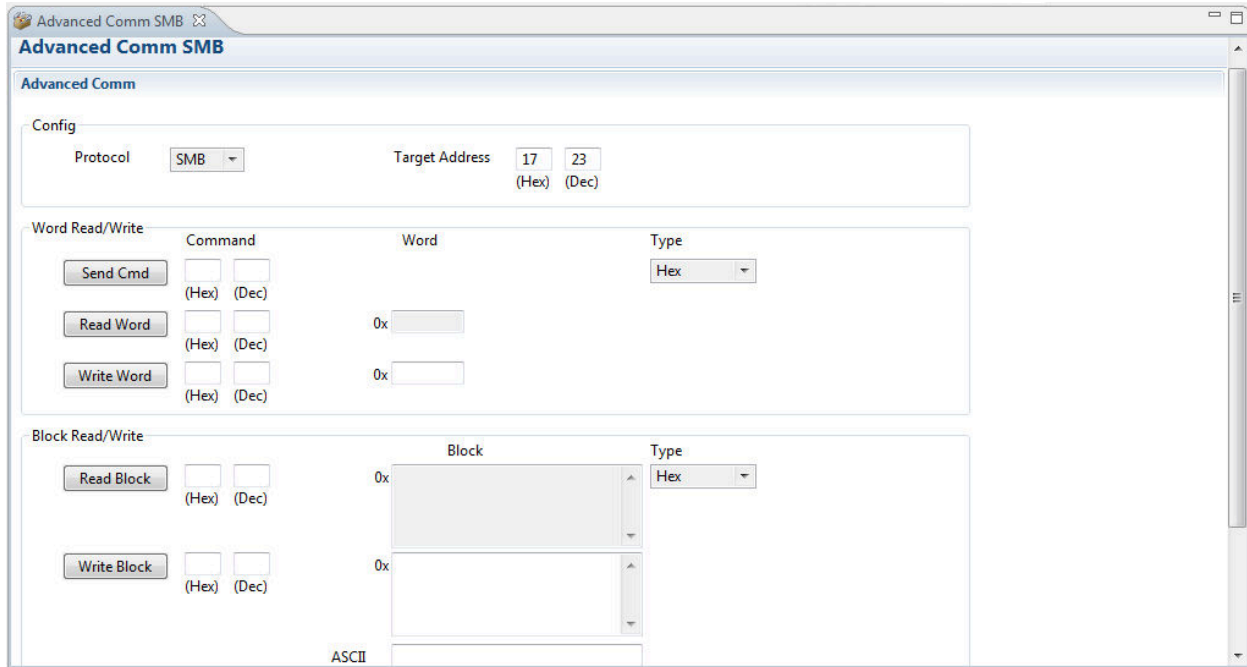

**Figure 3-6. Advanced Comm Screen**

#### Examples:

Reading an SMB Command.

- Read SBData Voltage (0x09)
  - SMBus Read Word. Command = 0x09
  - Word = 0x3A7B, which is hexadecimal for 14971 mV

Sending a MAC Gauging() to enable IT via ManufacturerAccess().

- With Impedance Track™ disabled, send Gauging() (0x0021) to ManufacturerAccess().
  - SMBus Write Word. Command = 0x00. Data = 00 21

Reading Chemical ID() (0x0006) via ManufacturerAccess()

- Send Chemical ID() to ManufacturerAccess()
  - SMBus Write Word. Command = 0x00. Data sent = 00 06
- Read the result from ManufacturerData()
  - SMBus Read Block. Command = 0x23. Data read = 00 01
  - That is 0x0100, chem ID 100

## 4 bq40z50EVM Circuit Module Schematic

This section contains information on modifying the EVM and using various features on the reference design.

### 4.1 Pre-Charge

The EVM provides a power resistor and FET to support a reduced current pre-charge path to charge the pack when cell voltages are below the pre-charge voltage threshold. This reduces heating that could lead to cell damage or reduced operating lifetime. The resistor (R1) is set up to limit the current to less than 40 mA for a 4S configuration. The user can change R1 to setup the pre-charge current to a different value.

### 4.2 LED Control

The EVM is configured to support five LEDs to provide state-of-charge information for the cells. The LED interface is enabled by entering a 0x0027 command in the Manufacturing Access register on the Registers screen. Press the *LED DISPLAY* button to illuminate the LEDs for approximately 5 seconds.

### 4.3 Emergency Shutdown

The Emergency Shutdown function allows the user to disable the charge and discharge FETs with an external GPIO pin. The EMSHUT and NR bits must be set high in the DA Configuration register to enable this feature. Press the SHUTDOWN pushbutton switch for one second to disable these FETs, and press it again for one second to enable them.

---

#### Note

Remember to remove the SYS PRES-to-PACK– short, if present.

---

### 4.4 Testing Fuse-Blowing Circuit

To prevent the loss of board functionality during the fuse-blowing test, the actual chemical fuse is not provided on the EVM. FET Q5 drives the FUSE test point low if a fuse-blow condition occurs. FUSE is attached to an open drain FET, so a pull-up resistor is required to check whether the FUSE pulls low. A FUSEPIN test point is attached to the gate of Q5; so, monitoring FUSEPIN can be used to test this condition without adding a pull-up resistor. Fuse placement on the application board is shown in the bq40z50 [data sheet](#). A chemical fuse can also be soldered to the EVM for in-system testing. A copper bridge is included on the PCB to bypass the chemical fuse, so it has to be cut to allow the fuse to open the power path. The cut is illustrated in yellow on [Figure 4-1](#) with arrows pointing to the location.

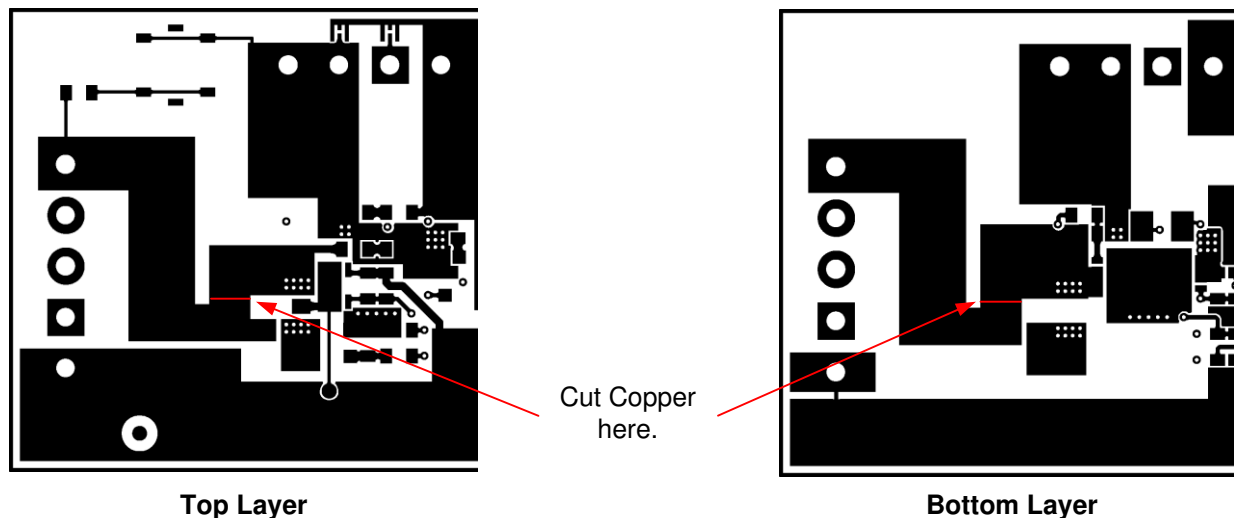

Figure 4-1. Fuse Trace Modifications

### 4.5 PTC Thermistor

The PTC interface is designed to work with a specific PTC thermistor. The thermistor must have a 10-kΩ typical resistance over the normal operating temperature range and the resistance must be greater than 1.2 MΩ at the PTC trip temperature. The muRata PRF18BA103QB1RB thermistor will work with this device.

The EVM has a 10-kΩ resistor installed on the PTC footprint.

The PTC function can be disabled by connecting PTC and PTCEN to VSS.

## 5 Circuit Module Physical Layouts

This section contains the printed-circuit board (PCB) layout, assembly drawings, and schematic for the bq40z50 and bq296000 circuit modules.

### 5.1 Board Layout

This section shows the dimensions, PCB layers, and assembly drawing for the bq40z50 modules.

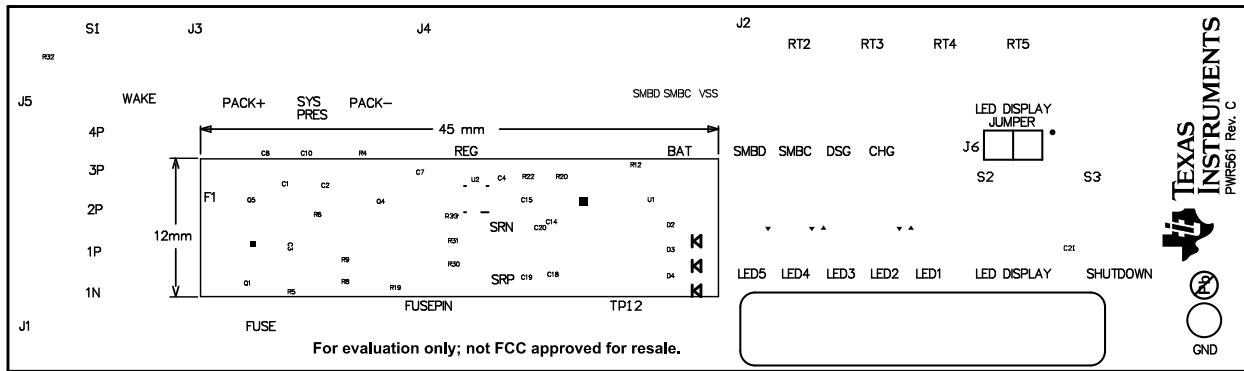

Figure 5-1. Top Silk Screen

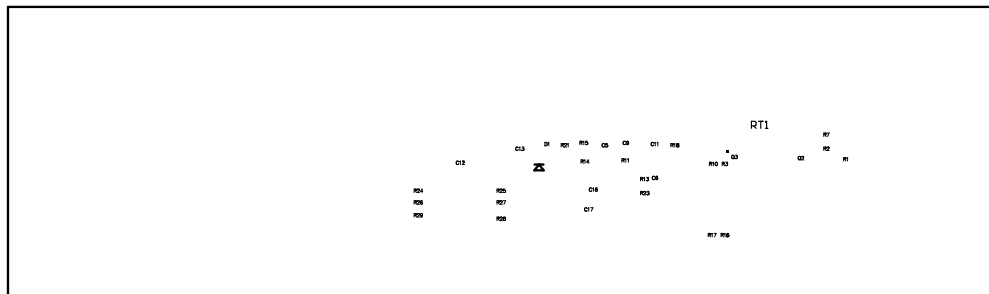

Figure 5-2. Bottom Silk Screen

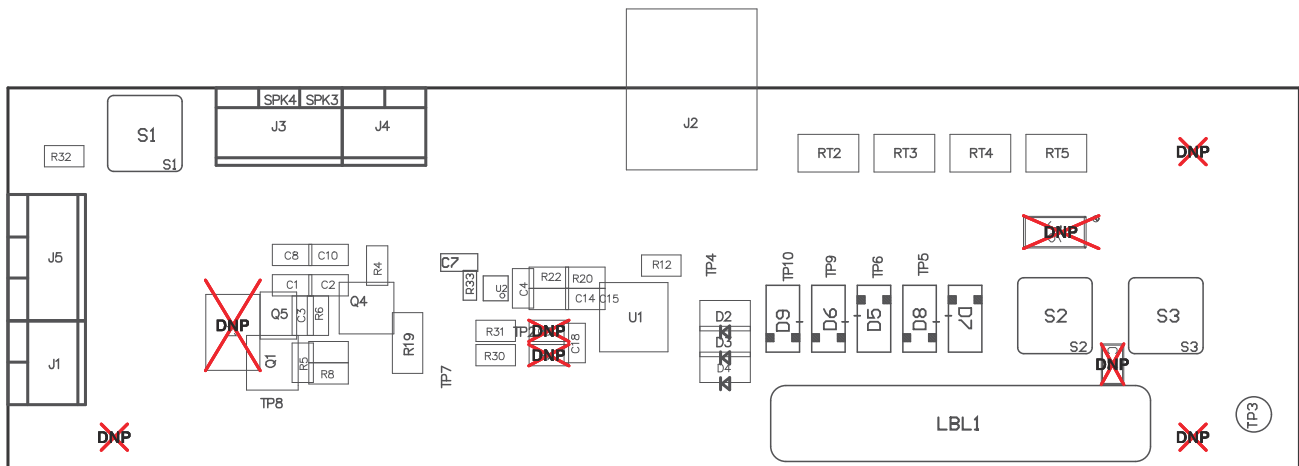

Figure 5-3. Top Assembly

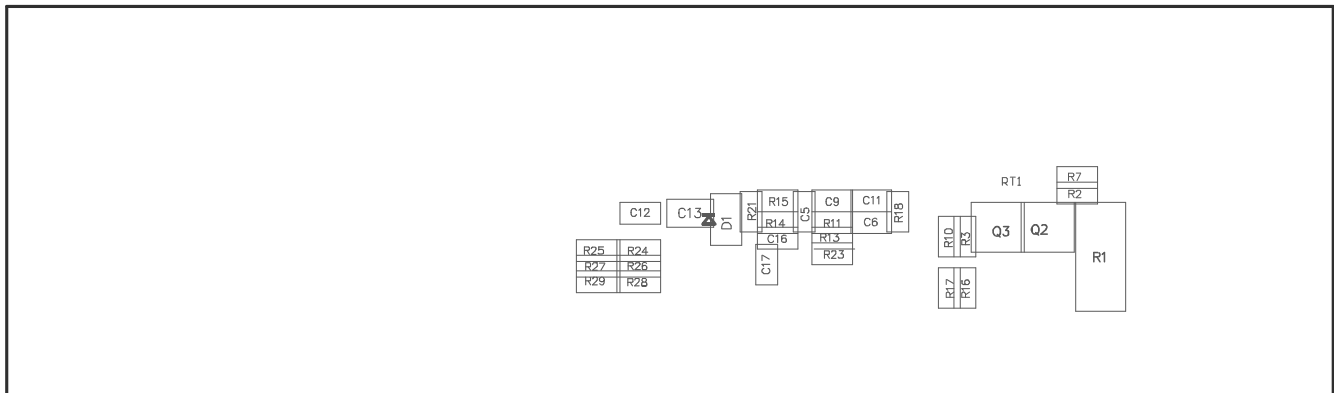

Figure 5-4. Bottom Assembly

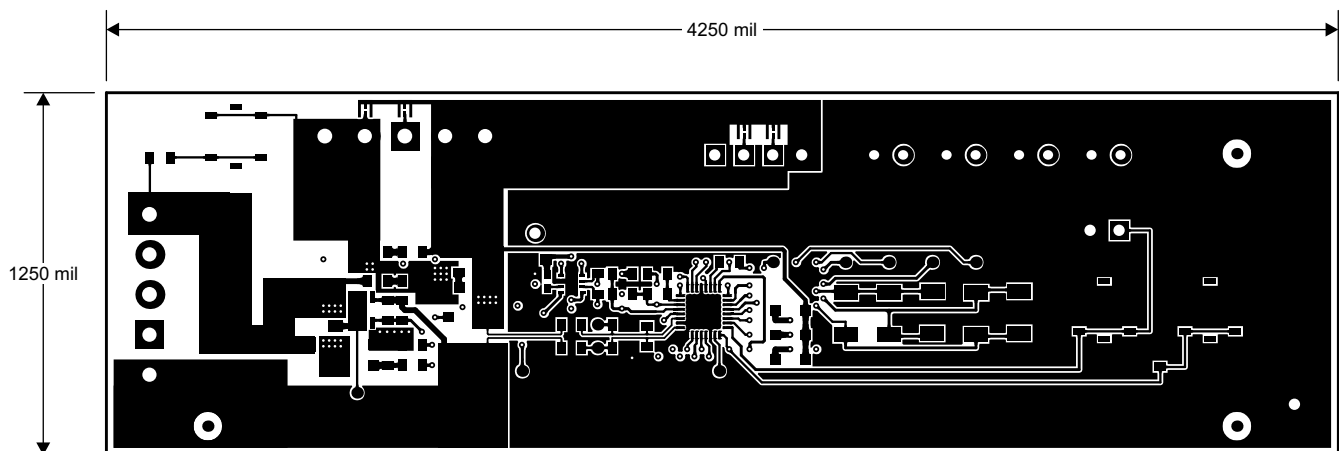

Figure 5-5. Top Layer

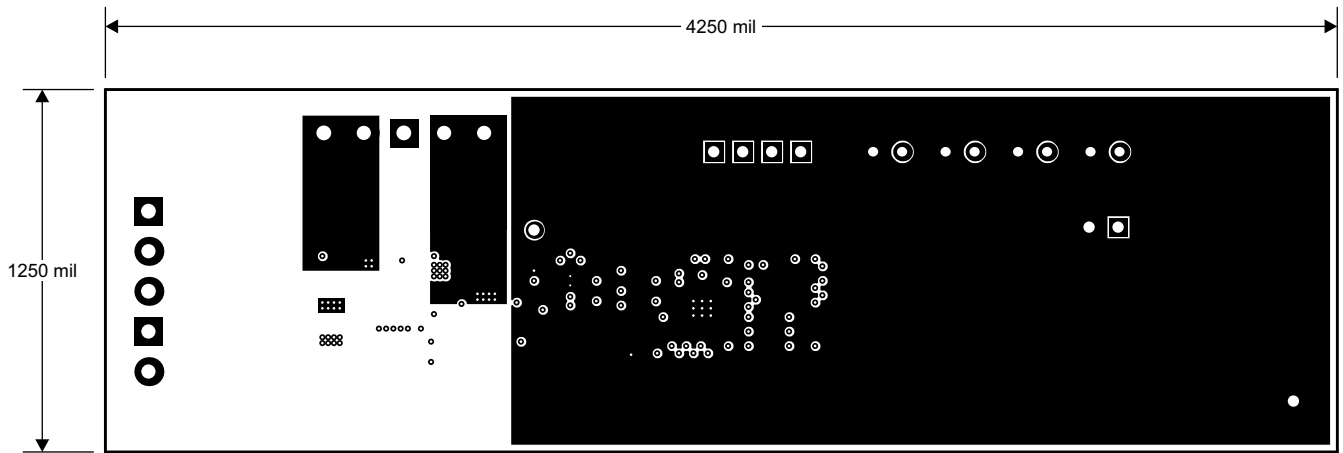

Figure 5-6. Internal Layer 1

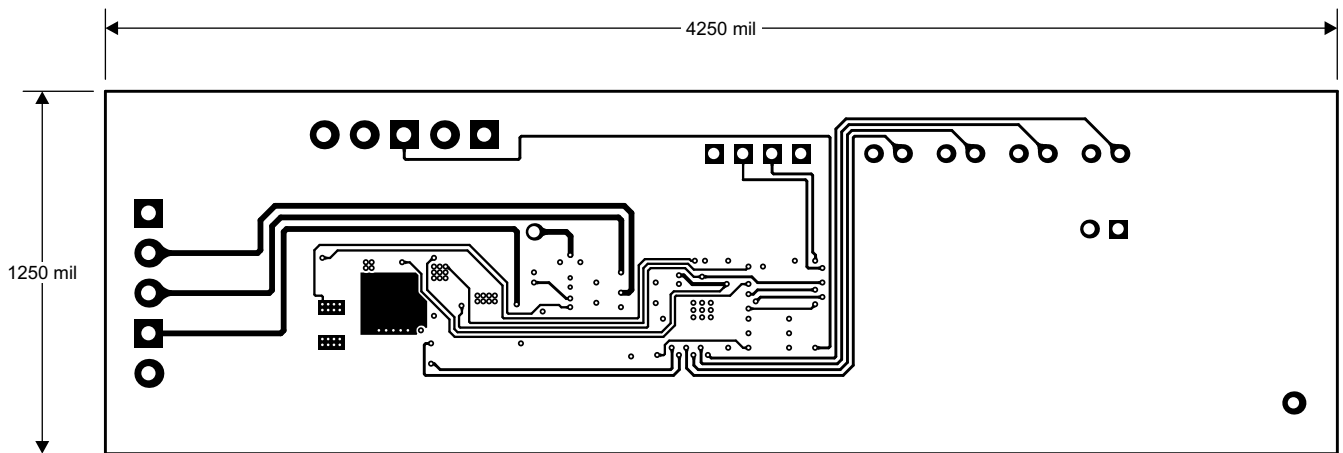

Figure 5-7. Internal Layer 2

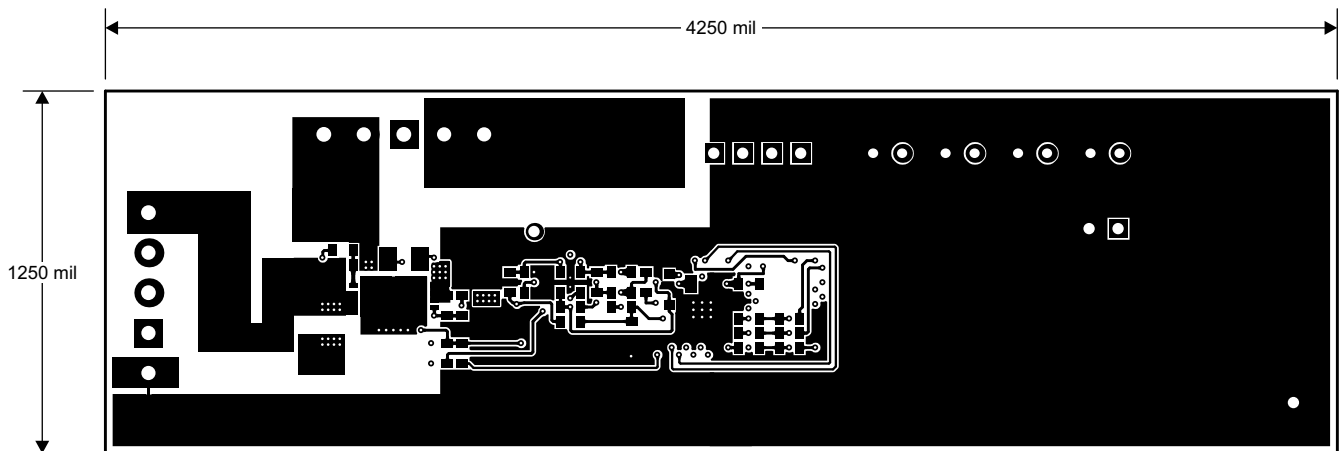
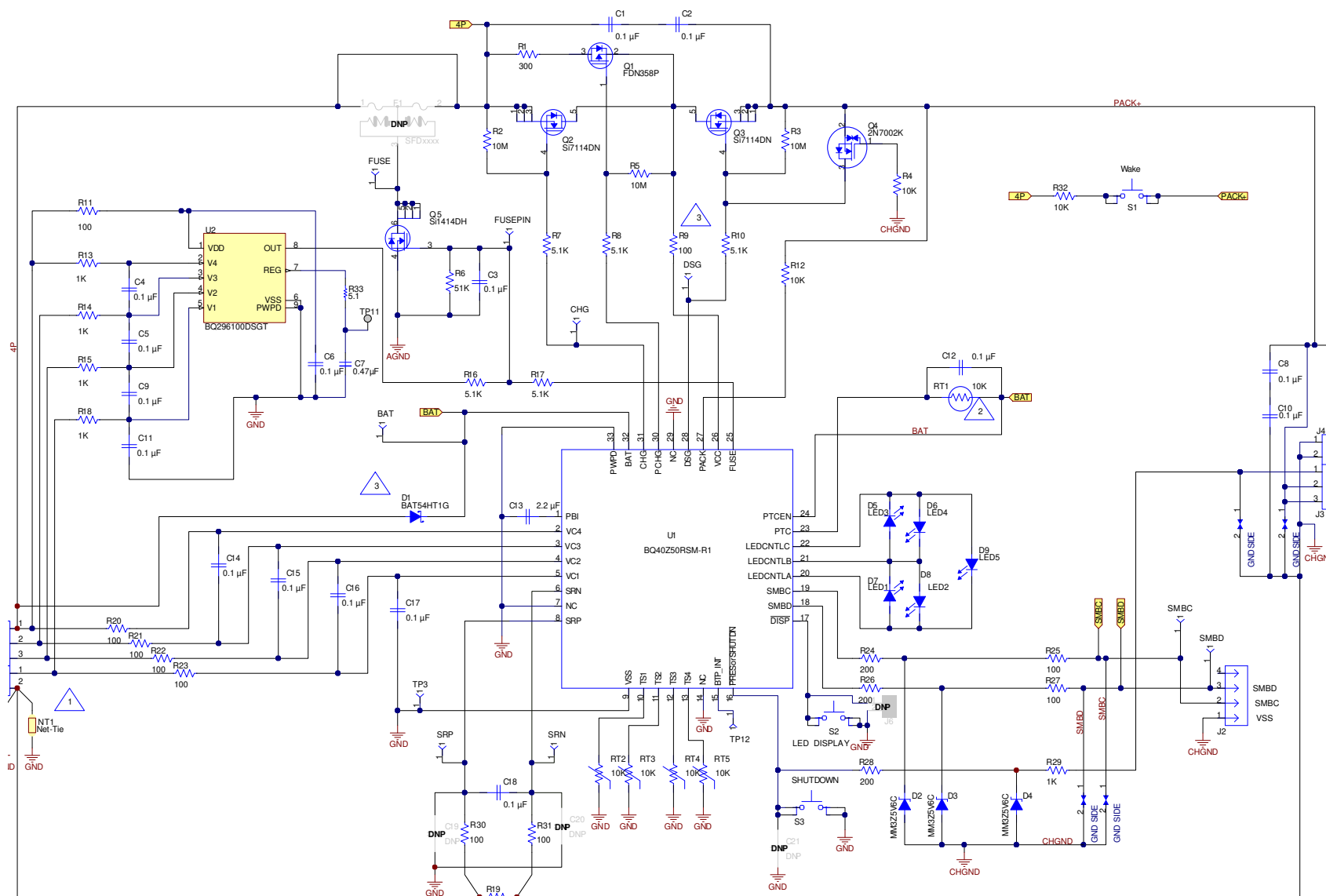

Figure 5-8. Bottom Layer

## 5.2 Schematic



- 1 IC ground should be connected to the 1N cell tab.
- 2 Place RT1 close to Q2 and Q3.
- 3 Replace D1 and R9 with a 10 ohm resistor for Single cell applications



## 6 Bill of Materials

COUNT	RefDes	Value	Description	Size	Part Number	MFR
16	C1-6, C8-12, C14-18	0.1 $\mu$ F	Capacitor, Ceramic Chip, 50 V, X7R, 20%	0603	C0603C104M5RACTU	Kemet
1	C7	0.47 $\mu$ F	Capacitor, Ceramic, 0.47 $\mu$ F, 10 V, X5R, 10%	0603	C0603C474K8PACTU	Kemet
1	C13	2.2 $\mu$ F	Capacitor, Ceramic, 25 V, X7R, 20%	0805	C2012X7R1E225M085AB	TDK
0	C19-21	DNP	Capacitor, Ceramic, 50 V, X7R, 20%	0603	C0603C104M5RACTU	Kemet
1	D1	BAT54HT1G	Diode, Schottky, 200-mA, 30-V	SOD323	BAT54HT1G	On Semi
3	D2-4	MM3Z5V6C	Diode, Zener, 5.6V, 200mW	SOD323	MM3Z5V6C	Fairchild
5	D5-9	SML-X23GC	LED 2x3mm 565nm GRN WTR CLR SMD	1206	SML-X23GC	Lumex
0	F1	DNP	Fuse, Slo-Blo Ceramic, xxA, yyyV	SFDxxx	SFDxxxx	Sony
1	R1	300	Resistor, Chip, 1W, 5%	2512	CRCW2512300RJNEG	Vishay-Dale
3	R2-3, R5	10M	Resistor, Chip, 1/10-W, 5%	0603	CRCW060310M0JNEA	Vishay-Dale
3	R4, R12, R32	10K	Resistor, Chip, 1/10-W, 5%	0603	CRCW060310K0JNEA	Vishay-Dale
1	R6	51K	Resistor, Chip, 1/16-W, 5%	0603	CRCW060351K0JNEA	Vishay-Dale
5	R7-8, R10, R16-17	5.1K	Resistor, Chip, 1/10-W, 5%	0603	CRCW06035K10JNEA	Vishay-Dale
10	R9, R11, R20-23, R25, R27, R30-31	100	Resistor, Chip, 1/10-W, 5%	0603	CRCW0603100RJNEAHP	Vishay-Dale
5	R13-15 R18 R29	1K	Resistor, Chip, 1/10-W, 5%	0603	CRCW06031K00JNEA	Vishay-Dale
1	R19	0.001 50ppm	Resistor, Chip, 1 watt, $\pm$ 1%	1206	CSR1206-0R001F1	Riedon
3	R24, R26, R28	200	Resistor, Chip, 1/16-W, 5%	0603	CRCW0603200RJNEA	Vishay-Dale
1	R33	5.1	Resistor, 5.1, 0.063 W, 5%, 0402	0402	CRCW04025R10JNED	Vishay-Dale
2	J1, J4	ED555/2DS	Terminal Block, 2-pin, 6-A, 3.5mm	0.27 x 0.25 inch	ED555/2DS	OST
1	J2	22-05-3041	Header, Friction Lock Ass'y, 4-pin Right Angle,	0.400 x 0.500 inch	22-05-3041	Molex
2	J3, J5	ED555/3DS	Terminal Block, 3-pin, 6-A, 3.5mm	0.41 x 0.25 inch	ED555/3DS	OST
0	J6		Header, TH, 100mil spacing, 2x1, 230 mil above insulator	0.100 inch x 2	PEC02SAAN	Sullins
1	LBL1		Thermal Transfer Printable Labels, 1.250 W x 0.250 H inch - 10,000 per roll	PCB Label 1.250 W x 0.250 H inch	THT-13-457-10	Brady
1	RT1	10K	Thermistor, NTC, 5 $\Omega$ , 1-A	1206	CRCW120610K0JNEA	Vishay
4	RT2-5	10K	Thermistor, NTC, 3-A	0.095 X 0.150 inch	103AT-2	Semitec
3	S1, S2, S3	EVQ-PLHA15	Switch, Push button, Momentary, 1P1T, 50-mA, 12-V	0.200 x 0.200 inch	EVQ-PLHA15	Panasonic
1	TP3	5001	Test Point, Black, Thru Hole Color Keyed	0.100 x 0.100 inch	5001	Keystone
1	Q1	FDN358P	MOSFET, Pch, -30V, -1.5A, 125 m $\Omega$	SOT23	FDN358P	Fairchild
2	Q2-3	Si7114DN-T1-E3	MOSFET Nch 30V, 11.7A, 7.5 m $\Omega$	PWRPAK 1212	Si7114DN-T1-E3	Vishay
1	Q4	2N7002K-T1-E3	MOSFET, Nch, 60V, 300 mA, 2- $\Omega$	SOT23	2N7002K-T1-E3	Vishay
1	Q5	Si1414DH-T1-GE3	MOSFET, Nch, 30V, 4A, 46 m $\Omega$	SC-70	Si1414DH-T1-GE3	Vishay
1	U1	BQ40Z50RSMR(T)-R1	IC, 2- to 4-Series Li-Ion Battery Pack Manager	QFN	BQ40Z50RSMR(T)-R1	TI
1	U2		IC, Overvoltage Protection for 2-Series, 3-Series, and 4-Series Cell Li-Ion Batteries with Regulated Output Supply, DSG0008A	DSG0008A	BQ296103DSGT	TI
1	W1		Cable assembly, 4 pin	N/A	CBL002	TI
1	IPCB		Printed Circuit Board	4.25 in x 1.25 in	PWR561	Any

## 7 Related Documentation from Texas Instruments

- bq40z50, 1-Series, 2-Series, 3-Series, and 4-Series Li-Ion Battery Pack Manager data sheet, [SLUSBS8](#)
- bq40z50 Technical Reference Manual, [SLUUA43](#)
- bq296000, BQ2960XY/BQ2961XY Overvoltage Protection for 2-Series, 3-Series, and 4-Series Cell Li-Ion Batteries with Regulated Output Supply, [SLUSBU5](#)

## 8 Revision History

<b>Changes from Revision B (September 2016) to Revision C (November 2022)</b>	<b>Page</b>
• Updated the numbering format for tables, figures, and cross-references throughout the document.....	<b>1</b>
<b>Changes from Revision A (July, 2015) to Revision B (September, 2016)</b>	<b>Page</b>
• Added <i>Update Firmware</i> section.....	<b>5</b>

## IMPORTANT NOTICE AND DISCLAIMER

TI PROVIDES TECHNICAL AND RELIABILITY DATA (INCLUDING DATA SHEETS), DESIGN RESOURCES (INCLUDING REFERENCE DESIGNS), APPLICATION OR OTHER DESIGN ADVICE, WEB TOOLS, SAFETY INFORMATION, AND OTHER RESOURCES "AS IS" AND WITH ALL FAULTS, AND DISCLAIMS ALL WARRANTIES, EXPRESS AND IMPLIED, INCLUDING WITHOUT LIMITATION ANY IMPLIED WARRANTIES OF MERCHANTABILITY, FITNESS FOR A PARTICULAR PURPOSE OR NON-INFRINGEMENT OF THIRD PARTY INTELLECTUAL PROPERTY RIGHTS.

These resources are intended for skilled developers designing with TI products. You are solely responsible for (1) selecting the appropriate TI products for your application, (2) designing, validating and testing your application, and (3) ensuring your application meets applicable standards, and any other safety, security, regulatory or other requirements.

These resources are subject to change without notice. TI grants you permission to use these resources only for development of an application that uses the TI products described in the resource. Other reproduction and display of these resources is prohibited. No license is granted to any other TI intellectual property right or to any third party intellectual property right. TI disclaims responsibility for, and you will fully indemnify TI and its representatives against, any claims, damages, costs, losses, and liabilities arising out of your use of these resources.

TI's products are provided subject to [TI's Terms of Sale](#) or other applicable terms available either on [ti.com](http://ti.com) or provided in conjunction with such TI products. TI's provision of these resources does not expand or otherwise alter TI's applicable warranties or warranty disclaimers for TI products.

TI objects to and rejects any additional or different terms you may have proposed.

Mailing Address: Texas Instruments, Post Office Box 655303, Dallas, Texas 75265  
Copyright © 2022, Texas Instruments Incorporated