

TPS546C23 2-Phase SWIFT Step-Down Converter Evaluation Module User's Guide



ABSTRACT

The TPS546C23EVM2-746 evaluation module (EVM) is a two-phase buck converter with two TPS546C23 devices. The TPS546C23 device is a stackable synchronous buck with PMBus interface that can operate from a nominal 4.5-V to 18-V supply. The device allows programming and monitoring through the PMBus interface.

Two TPS546C23 devices are configured as a two-phase buck converter in factory default and output current is evenly distributed in the two devices. Both the negative and positive output terminals are connected together.

Table of Contents

1 Description	3
1.1 Before You Begin	3
1.2 Typical Applications	3
1.3 Features	4
2 Electrical Performance Specifications	4
3 Schematic	5
4 Test Setup	6
4.1 Test and Configuration Software	6
4.2 Test Equipment	6
4.3 Recommended Test Setup	7
4.4 List of Test Points, Jumpers and Connectors	8
5 EVM Configuration Using the Fusion GUI	10
5.1 Configuration Procedure	10
6 Test Procedure	12
6.1 Line and Load Regulation and Efficiency Measurement Procedure	12
6.2 Control Loop Gain and Phase Measurement Procedure	12
6.3 Efficiency Measurement	13
7 Performance Data and Typical Characteristic Curves	14
7.1 Efficiency	14
7.2 Load Regulation	14
7.3 Line Regulation	15
7.4 Transient Response	15
7.5 Output Ripple	16
7.6 Control On	17
7.7 Control Off	18
7.8 Current Sharing Between Two Phases	19
7.9 Control Loop Bode Plot	19
7.10 Thermal Image	21
8 EVM Assembly Drawing and PCB Layout	22
9 Bill of Materials	31
10 Screenshots	33
10.1 Fusion GUI Screenshots	33
11 Revision History	44

List of Figures

Figure 3-1. TPS546C23EVM2-746 Schematic	5
Figure 4-1. TPS546C23EVM2-746 EVM Recommended Test Setup	7
Figure 4-2. Tip and Barrel Measurement	7
Figure 7-1. Efficiency of Output vs Line and Load	14

Figure 7-2. Load Regulation of Output.....	14
Figure 7-3. Line Regulation of 1.2-V Output (Different Board).....	15
Figure 7-4. Transient Response of 1.2-V Output at 12 V _{IN} , Transient is 10 A to 60 A, 0.2 A/μs.....	15
Figure 7-5. Output Ripple and SW Node of 1.2-V Output at 12 V _{IN} , 0-A Output.....	16
Figure 7-6. Output Ripple and SW Node of 1.2-V Output at 12 V _{IN} , 70-A Output.....	16
Figure 7-7. Start-Up from Control, 1.2-V Output at 12 V _{IN} , 0-A Output (TON_RISE is Modified to 5 ms)	17
Figure 7-8. Start-Up from Control, 1.2-V Output at 12 V _{IN} , 70-A Output (TON_RISE is Modified to 5 ms)	17
Figure 7-9. Soft Stop from Control, 1.2-V Output at 12 V _{IN} , 0-A Output (TON_RISE is Modified to 5 ms)	18
Figure 7-10. Soft Stop from Control, 1.2-V Output at 12 V _{IN} , 70-A Output (TON_RISE is Modified to 5 ms)	18
Figure 7-11. Inductor Current and Switch Node Waveform, 1.2-V Output at 12 V _{IN} , 70-A Output.....	19
Figure 7-12. Bode Plot at 1.2-V Output at 12 V _{IN} , 0-A Output.....	19
Figure 7-13. Bode Plot at 1.2-V Output at 12 V _{IN} , 70-A Output.....	20
Figure 7-14. Thermal Image.....	21
Figure 8-1. TPS546C23EVM2-746 EVM 3D (Top View).....	22
Figure 8-2. TPS546C23EVM2-746 EVM Top Layer Assembly Drawing (Top View).....	23
Figure 8-3. TPS546C23EVM2-746 EVM Bottom Assembly Drawing (Bottom View).....	24
Figure 8-4. TPS546C23EVM2-746 EVM Top Copper (Top View).....	25
Figure 8-5. TPS546C23EVM2-746 EVM Internal Layer 1 (Top View).....	26
Figure 8-6. TPS546C23EVM2-746 EVM Internal Layer 2 (Top View).....	27
Figure 8-7. TPS546C23EVM2-746 EVM Internal Layer 3 (Top View).....	28
Figure 8-8. TPS546C23EVM2-746 EVM Internal Layer 4 (Top View).....	29
Figure 8-9. TPS546C23EVM2-746 EVM Bottom Copper (Top View).....	30
Figure 10-1. Select Device Scanning Mode.....	33
Figure 10-2. Configure – Limits and On/Off	34
Figure 10-3. ON/OFF Control Pop-Up.....	36
Figure 10-4. Configure – Advanced.....	37
Figure 10-5. Configure – SMBALERT # Mask.....	38
Figure 10-6. Configure – Device Info.....	39
Figure 10-7. Configure – All Config.....	40
Figure 10-8. Monitor Screen with 10-A Total Load.....	41
Figure 10-9. Status Screen.....	43

List of Tables

Table 2-1. TPS546C23EVM2-746 Electrical Performance Specifications.....	4
Table 4-1. Test Point Functions.....	8
Table 4-2. Jumpers.....	9
Table 4-3. Connector Functions.....	9
Table 5-1. Key Factory Configuration Parameters.....	10
Table 6-1. List of Test Points for Loop Response Measurements.....	12
Table 6-2. Test Points for Better Efficiency Measurements.....	13
Table 9-1. TPS546C23EVM2-746 Components List.....	31

Trademarks

All trademarks are the property of their respective owners.

1 Description

The TPS546C23EVM2-746 is a two-phase buck converter with two stacked TPS546C23 devices. It uses a nominal 12-V bus to produce a regulated output at up to 70 A of load current. The TPS546C23EVM2-746 is designed to demonstrate the stacking operation of the TPS546C23 in a two-phase low output voltage application while providing a number of test points to evaluate the performance of the devices. The TPS546C23EVM2-746 can be modified to two separated single phase buck converters by changing the components assembled. Refer to the data sheet for more information on single-phase configuration.

1.1 Before You Begin

The following warnings and cautions are noted for the safety of anyone using or working close to the TPS546C23EVM2-746. Observe all safety precautions.



Warning

The TPS546C23EVM2-746 circuit module can become hot during operation due to dissipation of heat. Avoid contact with the board. Follow all applicable safety procedures applicable to your laboratory.



Caution

Do not leave the EVM powered when unattended.

WARNING

The circuit module has signal traces, components, and component leads on the bottom of the board. This can result in exposed voltages, hot surfaces, or sharp edges. Do not reach under the board during operation.

CAUTION

The circuit module can be damaged by over temperature. To avoid damage, monitor the temperature during evaluation and provide cooling, as needed, for the system environment.

CAUTION

Some power supplies can be damaged by application of external voltages. If using more than one power supply, check the equipment requirements and use blocking diodes or other isolation techniques, as needed, to prevent damage to the equipment.

CAUTION

The communication interface is not isolated on the EVM. Be sure no ground potential exists between the computer and the EVM. Also be aware that the computer is referenced to the battery potential of the EVM.

1.2 Typical Applications

- High-density power solutions
- Wireless infrastructure
- Switcher
- Router network
- Server
- Storage
- Smart power systems

1.3 Features

- Regulated 1.2-V output up to 70-A DC steady-state output current
- The output voltage is marginable and trimmable with the PMBus interface.
 - Programmable UVLO, soft start, and enable with the PMBus interface
 - Programmable overcurrent warning and fault limits and programmable response to faults with the PMBus interface
 - Programmable overvoltage and undervoltage warning and fault limits and programmable response to faults with the PMBus interface
 - Programmable turn-on and turn-off delays
- Convenient test points for probing critical waveforms

2 Electrical Performance Specifications

Table 2-1 lists the electrical performance specifications under room temperature 25°C.

Table 2-1. TPS546C23EVM2-746 Electrical Performance Specifications

Parameter	Test Conditions	MIN	TYP	MAX	Unit
Input Characteristics					
Voltage range	V_{IN}	5	12	18	V
Maximum input current	$V_{IN} = 12\text{ V}$, $I_O = 70\text{ A}$		8.5		A
No load input current	$V_{IN} = 12\text{ V}$, $I_O = 0\text{ A}$		120		mA
Output Characteristics					
Output voltage, V_{OUT}			1.2		V
Output load current, I_{OUT} ⁽¹⁾		0		70	A
Output voltage regulation	Line regulation: input voltage = 5 V to 18 V		1%		
	Load regulation: output current = 0 A to 70 A		1%		
Output voltage ripple, V_{OUT}	$V_{IN} = 12\text{ V}$, $I_{OUT} = 70\text{ A}$		10		mVpp
Output overcurrent protection threshold	Load current I_{OUT1} , default setting of U1		42		A
	Load current I_{OUT2} , default setting of U2		42		A
Systems Characteristics					
Switching frequency	$V_{IN} = 12\text{ V}$		500		kHz
Full load efficiency, V_{OUT} ⁽²⁾	$V_{IN} = 12\text{ V}$, $I_{OUT} = 70\text{ A}$		86%		
Operating temperature	$T_{ambient}$		25		°C
PMBUS Interface and Pin-Strapping					
U1 PMBUS address	Programmed by R ₃₃ and R ₃₅		27		Decimal
U2 PMBUS address	Programmed by R ₃₇ and R ₃₆		36		
U1 voltage reference	Default setting of VOUT_COMMAND		600		mV
U2 voltage reference	Default setting of VOUT_COMMAND		600		
U1 soft-start time (TON_RISE)	Default setting of TON_RISE		3		ms
U2 soft-start time (TON_RISE)	Default setting of TON_RISE		3		

(1) The output current I_{OUT} can be up to 80 A, if the output overcurrent limit (IOUT_OC_FAULT_LIMIT) is set to 45 A.

(2) The efficiency is measured based on Figure 4-1 and test setups, which includes power loss caused by on board copper traces.

3 Schematic

Figure 3-1 illustrates the TPS546C23EVM2-746 EVM schematic.

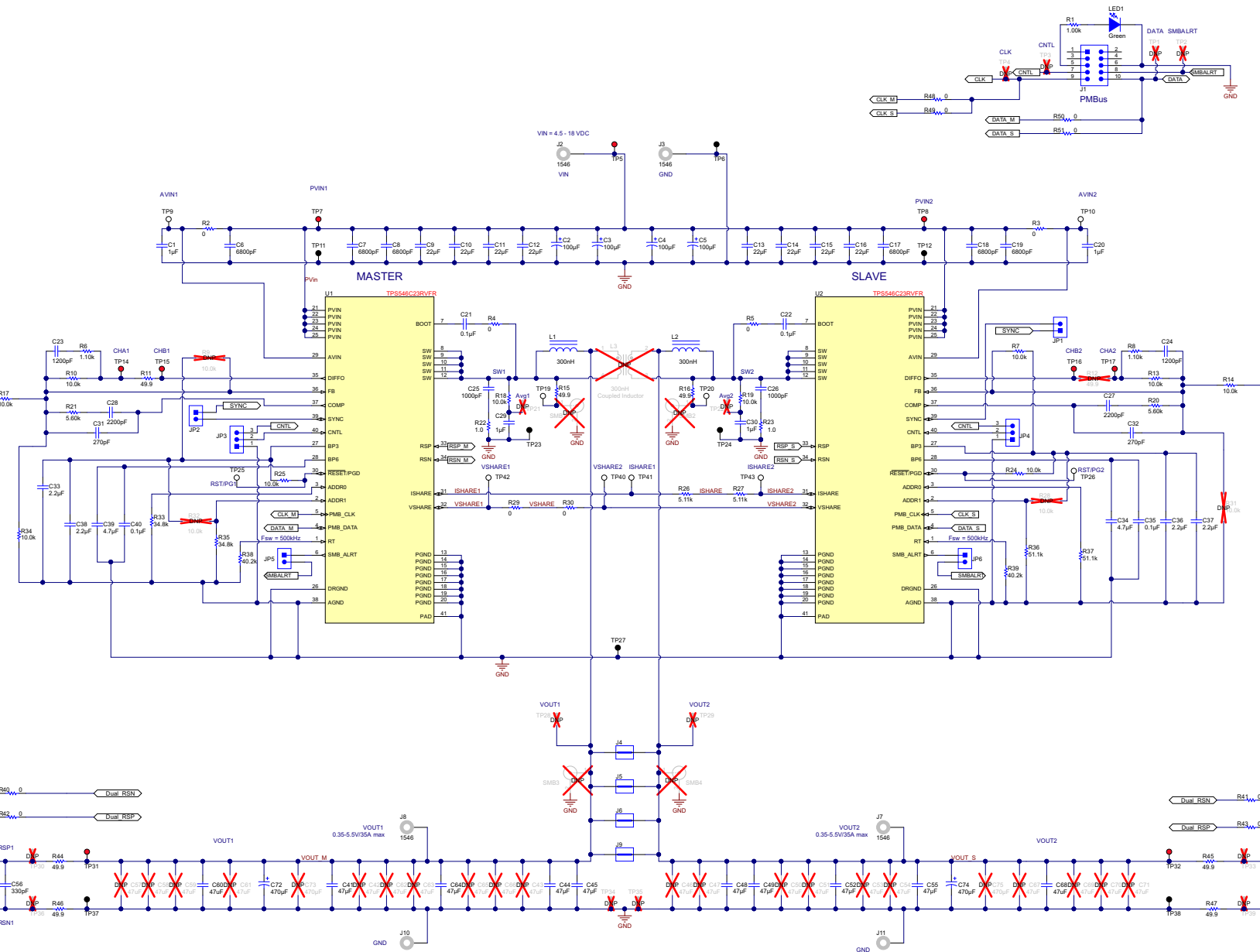

Figure 3-1. TPS546C23EVM2-746 Schematic

4 Test Setup

4.1 Test and Configuration Software

In order to change any of the default configuration parameters on the EVM, it is necessary to obtain the TI Fusion Digital Power Designer software.

4.1.1 Description

The Fusion Digital Power Designer is the graphical user interface (GUI) used to configure and monitor the Texas Instruments TPS546C23 power converter installed on this evaluation module. The application uses the PMBus protocol to communicate with the controller over serial bus by way of a TI USB adapter. This adapter can be purchased at <http://www.ti.com/tool/usb-to-gpio>.

4.1.2 Features

Some of the tasks that can be performed with the GUI include:

- Turn on or off the power supply output, either through the hardware control line or the PMBus operation command.
- Monitor real-time data, such as output voltage, output current, die temperature, warnings, and faults, which are continuously monitored and displayed by the GUI.
- Configure common operating characteristics such as V_{OUT} trim and margin, UVLO, soft-start time, warning and fault thresholds, fault response, and ON/OFF modes.

This software is available for download at http://www.ti.com/tool/fusion_digital_power_designer.

4.2 Test Equipment

4.2.1 Voltage Source

The input voltage source V_{IN} should be a 0-V to 20-V variable DC source capable of supplying 20 A_{DC}. Connect input VIN and GND to J2 and J3 as shown in [Figure 4-1](#).

4.2.2 Multimeters

It is recommended to use two separate multi-meters as shown in [Figure 4-1](#): one meter to measure V_{IN} , the other to measure V_{OUT} .

4.2.3 Output Load

A variable electronic load is recommended for the test setup as shown in [Figure 4-1](#). The load should be capable of 80 A.

4.2.4 Oscilloscope

An oscilloscope is recommended for measuring output noise and ripple. Output ripple should be measured using a *Tip-and-Barrel* method or better as shown in [Figure 4-2](#).

4.2.5 Fan

During prolonged operation at high loads, it can be necessary to provide forced air cooling with a small fan aimed at the EVM. The temperature of the devices on the EVM should be maintained at less than 105°C.

4.2.6 USB-to-GPIO Interface Adapter

A communications adapter is required between the EVM and the host computer. This EVM was designed to use the Texas Instruments USB-to-GPIO adapter. This adapter can be purchased at <http://www.ti.com/tool/usb-to-gpio>.

4.2.7 Recommended Wire Gauge

- Input VIN and GND to J2 and J3 (GND) (12-V input) – The recommended wire size is AWG #12, with the total length of wire less than two feet (1-foot input, 1-foot return).
- Output J8/J7 and GND J10/J11 (0.9-V output) – The minimum recommended wire size is AWG #10, with the total length of wire less than two feet (1-foot output, 1-foot return).

4.3 Recommended Test Setup

Figure 4-1 shows the recommended test setup.

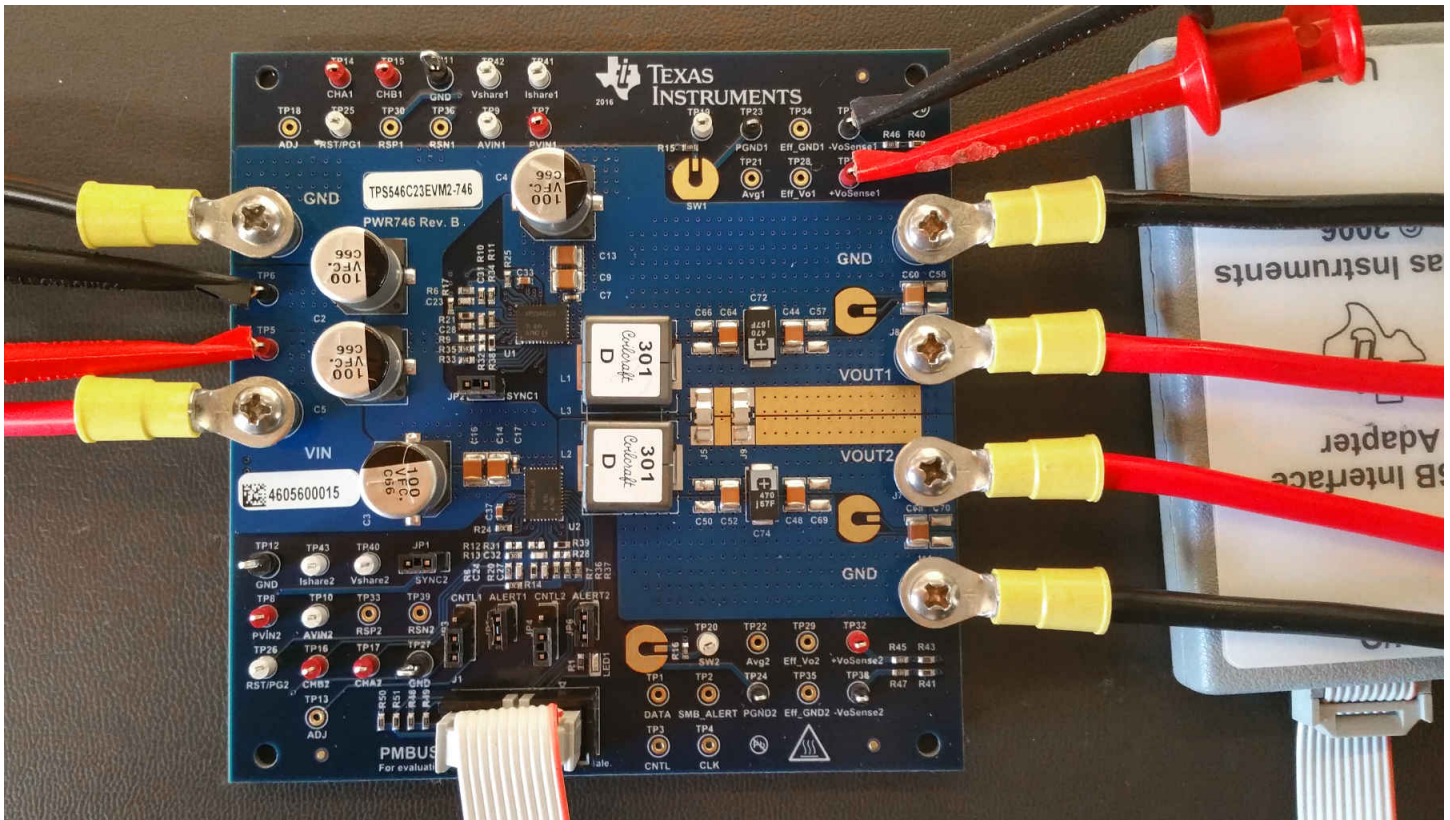

Figure 4-1. TPS546C23EVM2-746 EVM Recommended Test Setup

Figure 4-2 illustrates the tip and barrel measurement for switching node waveform on TP19 with TP23 or TP20 with TP24.

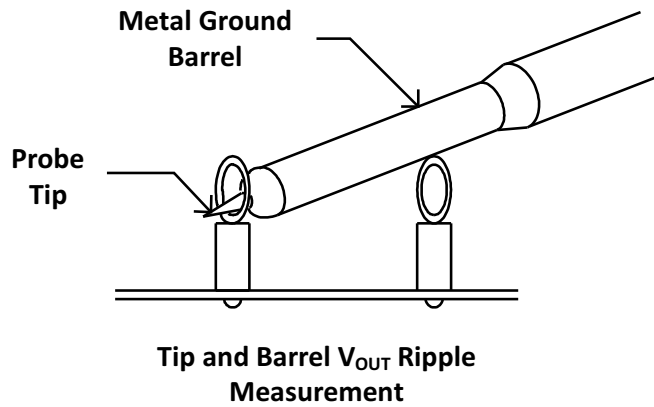

Figure 4-2. Tip and Barrel Measurement

4.4 List of Test Points, Jumpers and Connectors

Table 4-1 lists the test point functions.

Table 4-1. Test Point Functions

Test Point	Type	Name	Description
TP1	Not Assembled	DATA	DATA signal on J1 socket
TP2	Not Assembled	SMB_ALERT	SMBALERT signal on J1 socket
TP3	Not Assembled	CNTL	CNTL signal on J1 socket
TP4	Not Assembled	CLK	CLK signal on J1 socket
TP5	T-H Loop	VIN	V_{IN+} measurement point
TP6	T-H Loop	GND	V_{IN-} measurement point
TP7	T-H Loop	PVIN1	PVIN pin voltage of U1 device measurement point
TP8	T-H Loop	PVIN2	PVIN pin voltage of U2 device measurement point
TP9	T-H Loop	AVIN1	AVIN pin voltage of U1 device measurement point
TP10	T-H Loop	AVIN2	AVIN pin voltage of U2 device measurement point
TP11	T-H Loop	GND	GND reference
TP12	T-H Loop	GND	GND reference
TP13	Not Assembled	ADJ	Analog input to adjust rail 2 output voltage
TP14	T-H Loop	CHA1	Input for small signal loop gain measurements for output rail 1 (B/A setup)
TP15	T-H Loop	CHB1	OUTPUT for small signal loop gain measurements for output rail 1 (B/A setup)
TP16	T-H Loop	CHB2	OUTPUT for small signal loop gain measurements for output rail 2 (B/A setup)
TP17	T-H Loop	CHA2	Input for small signal loop gain measurements for output rail 2 (B/A setup)
TP18	Not Assembled	ADJ	Analog input to adjust rail 1 output voltage
TP19	T-H Loop	SW1	Switching node of output rail 1 measurement point, reference to TP23
TP20	T-H Loop	SW2	Switching node of output rail 2 measurement point, reference to TP24
TP21	Not Assembled	AVG1	Rail 1 switching node average voltage measurement point, reference to TP23
TP22	Not Assembled	AVG2	Rail 2 switching node average voltage measurement point, reference to TP24
TP23	T-H Loop	PGND1	GND reference for switching node measurement
TP24	T-H Loop	PGND2	GND reference for switching node measurement
TP25	T-H Loop	RST/RG1	PGOOD signal of output 1
TP26	T-H Loop	RST/PG2	PGOOD signal of output 2
TP27	T-H Loop	GND	GND reference
TP28	Not Assembled	EFF_VO1	U1 output voltage measurement point for efficiency, reference to TP34
TP29	Not Assembled	EFF_VO2	U2 output voltage measurement point for efficiency, reference to TP35
TP30	Not Assembled	RSP1	Output 1 remote sense + voltage point
TP31	T-H Loop	+VOSENSE1	V_{OUT1+} measurement point
TP32	T-H Loop	+VOSENSE2	V_{OUT2+} measurement point
TP33	Not Assembled	RSP2	Output 2 remote sense + voltage point
TP34	Not Assembled	EFF_GND1	Rail 1 output voltage referencing GND for efficiency measurement
TP35	Not Assembled	EFF_GND2	Rail 1 output voltage referencing GND for efficiency measurement
TP36	Not Assembled	RSN1	Output 1 remote sense - voltage point
TP37	T-H Loop	-VOSENSE1	V_{OUT1-} measurement point
TP38	T-H Loop	-VOSENSE2	V_{OUT2-} measurement point
TP39	Not Assembled	RSN2	Output 2 remote sense - voltage point
TP40	T-H Loop	Vshare2	VSHARE of U2 measurement point. Sensitive signal
TP41	T-H Loop	Ishare1	ISHARE of U1 measurement point. Sensitive signal
TP42	T-H Loop	Vshare1	VSHARE of U1 measurement point. Sensitive signal
TP43	T-H Loop	Ishare2	ISHARE of U2 measurement point. Sensitive signal

Table 4-2 lists the EVM jumpers.

Table 4-2. Jumpers

Jumper	Type	Name	Description
JP1	Header, 100 mil, 2×1	SYNC2	Synchronization connection between U1 and U2. Jumper is plugged as default.
JP2	Header, 100 mil, 2×1	SYNC1	Synchronization connection between U1 and U2. Jumper is plugged as default.
JP3	Header, 100 mil, 3×1	CNTL1	PMBUS CNTL connection options for U1 to socket J1 or GND. Jumper connecting U1 to J1 is plugged as default.
JP4	Header, 100 mil, 3×1	CNTL2	PMBUS CNTL connection options for U2 to socket J1 or GND. Jumper connecting U2 to J1 is plugged as default.
JP5	Header, 100 mil, 2×1	ALERT1	PMBUS SMBALERT connection between U1 and socket J1. Jumper connecting U1 to J1 is plugged as default.
JP6	Header, 100 mil, 2×1	ALERT2	PMBUS SMBALERT connection between U2 and socket J1. Jumper connecting U2 to J1 is plugged as default.

Table 4-3 lists the EVM connector functions.

Table 4-3. Connector Functions

Connector	Type	Name	Description
J1	Header, 100mil, 5x2	PMBUS	PMBUS socket for TI FUSION adapter
J2	Keystone 1546	VIN	VIN+ connector
J3	Keystone 1546	GND	VIN– (GND) connector
J8	Keystone 1546	VOUT1	VOUT1+ connector
J10	Keystone 1546	GND	VOUT1– connector
J7	Keystone 1546	VOUT2	VOUT2+ connector
J11	Keystone 1546	GND	VOUT2– connector

5 EVM Configuration Using the Fusion GUI

The TPS546C23 on this EVM leave the factory pre-configured. See [Table 5-1](#) for a short list of key factory configuration parameters as obtained from the configuration file.

Table 5-1. Key Factory Configuration Parameters

Address Hex	Address Dec	Part ID	Designator		
0x33	27	TPS546C23	U1		
0x44	36	TPS546C23	U2		
GENERAL					
CMD Code	CMD CODE HEX	ENCODED HEX	DECODED	COMMENTS	
VIN_OFF	0x36	0xF010	4.0 V	Turn OFF voltage	
VIN_ON	0x35	0xF012	4.5 V	Turn ON voltage	
IOUT_CAL_OFFSET	0x39	0xE000	0.0000 A	Current offset for PMBUS readout	
IOUT_OC_FAULT_LIMIT	0x46	0xF854	42 A	OC fault level	
IOUT_OC_FAULT_RESPONSE	0x47	0xFF	Restart	Response to OC fault	
IOUT_OC_WARN_LIMIT	0x4A	0xF84A	37 A	OC warning level	
VOUT_COMMAND	0x21	0x0133	0.6 V	Reference voltage	
VOUT_MIN	0x2B	00B3h	0.35V	Minimum reference voltage	
VOUT_MAX	0x24	0x034D	1.65 V	maximum reference voltage	
VOUT_TRANSITION_RATE	0x27	0xD03C	1 mV/us	Vout transition rate	
VOUT_SCALE_LOOP	0x29	0xF004	1	Output sense scaling ratio for main control loop	
PCT_OV_UV_WRN_FLT_LIMITS	0xD6	0x00	UV FAULT	83%	Output OV/UV settings, reference to nominal reference voltage
			UV WARN	88%	
			OV WARN	112%	
			OV FAULT	117%	
VOUT_OV_FAULT_RESPONSE	0x41	0xBF	Restart	Output overvoltage fault response	
VOUT_UV_FAULT_RESPONSE	0x45	0xBF	Restart	Output undervoltage fault response	
ON_OFF_CONFIG	0x02	0x16	CNTL only, Active High.	Control signal and operation command	
OPERATION	0x01	0x00	Operation is not used to enable regulation	Can be used to control device On/Off	
OT_FAULT_LIMIT	0x4F	0x0091	145°C	OT fault level	
OT_WARN_LIMIT	0x51	0x0078	120°C	OT warn level	
OT_FAULT_RESPONSE	0x50	0x3F	Ignore	Response to over temperature faults	
TON_DELAY	0x60	0x0000	0 ms	Turn-on delay	
TON_RISE	0x61	0x0003	3 ms	Soft-start time	
TON_MAX_FAULT_LIMIT	0x62	0x0000	Disabled	Upper limit for Vout reaching regulation	
TOFF_DELAY	0x64	0x0000	0 ms	Turn-off delay	
TOFF_FALL	0x65	0x0000	0 ms	Soft-stop fall time	

If it is desired to configure the EVM to settings other than the factory settings shown above, the TI Fusion Digital Power Designer software can be used for reconfiguration. It is necessary to have input voltage applied to the EVM prior to launching the software so that the TPS546C23 can respond to the GUI and the GUI can recognize the device. The default configuration for the EVM is to start converting at an input voltage of 4.5 V, therefore, to avoid any converter activity during configuration, an input voltage less than 4.5 V should be applied. An input voltage of 4 V is recommended.

5.1 Configuration Procedure

1. Adjust the input supply to provide 4 V_{DC}, current limited to 1 A.

2. Apply the input voltage to the EVM. Refer to [Figure 4-1](#) for connections and test setup.
3. Launch the Fusion GUI software. Refer to the screenshots in [Section 10](#) for more information.
4. Configure the EVM operating parameters as desired.

By default, both TPS546C23 devices are configured as loop controllers. PMBUS address for U1 is 27 decimal and for U2 is 36 decimal.

Both devices can be enabled to operate simultaneously. Also, both devices can be tied to PMBUS interface simultaneously.

6 Test Procedure

6.1 Line and Load Regulation and Efficiency Measurement Procedure

1. Set up the EVM as described in [Figure 4-1](#).
2. Ensure the electronic loads is set to draw 0 A_{DC}.
3. Increase V_{IN} from 0 V to 12 V using voltage meter to measure input voltage.
4. Use the other voltage meter to measure output voltage, V_{OUT}.
5. Vary the load from 0 to 70 A_{DC}. V_{OUT} should remain in regulation as defined in [Table 2-1](#).
6. Vary V_{IN} from 5 V to 18 V. V_{OUT} should remain in regulation as defined in [Table 2-1](#).
7. Decrease the load to 0 A.
8. Decrease V_{IN} to 0 V.

6.2 Control Loop Gain and Phase Measurement Procedure

The TPS546C23EVM2-746 includes a 49.9-Ω series resistor in the feedback loop for V_{OUT}. The resistor is accessible at the test points TP14 and TP15 for loop response analysis. These test points should be used during loop response measurements as the perturbation injecting points for the loop. See the description in [Table 6-1](#).

Table 6-1. List of Test Points for Loop Response Measurements

Test Point	Node Name	Description	Comment
TP14	CHA1	Input to feedback divider of V _{OUT}	The amplitude of the perturbation at this node should be limited to less than 30 mV.
TP15	CHB1	Resulting output of V _{OUT}	Bode can be measured by a network analyzer with a CH-B/CH-A configuration.

Measure only one output at a time with the following procedure:

1. Set up the EVM as described in [Figure 4-1](#).
2. For V_{OUT}, connect the isolation transformer of the network analyzer from TP14 to TP15.
3. Connect the input signal measurement probe to TP14. Connect the output signal measurement probe to TP15.
4. Connect the ground leads of both probe channels to TP11.
5. On the network analyzer, measure the Bode as TP15/TP14 (Out/In).

6.3 Efficiency Measurement

In order to evaluate the efficiency of the power train (device and inductor), it is important to measure the voltages at the correct location. This is necessary because otherwise the measurements will include losses that are not related to the power train itself. Losses incurred by the voltage drop in the copper traces and in the input and output connectors are not related to the efficiency of the power train, which should not be included in efficiency measurements.

Input current can be measured at any point in the input wires, and output current can be measured anywhere in the output wires of the output being measured.

Table 6-2 shows the measurement points for input voltage and output voltage. VIN and VOUT are measured to calculate the efficiency. Using these measurement points will result in efficiency measurements that excluded losses due to the connectors and PCB traces.

Table 6-2. Test Points for Better Efficiency Measurements

Test Point	Node Name	Description	Comment
VOUT			
TP7	PVIN1	Input voltage measurement point for VIN1+	The pair of test points are connected to the PVIN/GND pins of U1. The voltage drop between input terminal to the device pins is excluded for efficiency measurement.
TP23	PGND1	Input voltage measurement point for VIN1- (GND)	
TP28	Eff_Vo1	Output voltage measurement point for VOUT1+	The pair of test points are connected to the closest points of Vout /GND to the inductor. The voltage drop from the output point of inductor to the output terminals is excluded for efficiency measurement.
TP34	Eff_GND1	Output voltage measurement point for VOUT1- (GND)	

7 Performance Data and Typical Characteristic Curves

Figure 7-1 through Figure 7-14 present typical performance curves for the TPS546C23EVM2-746.

7.1 Efficiency

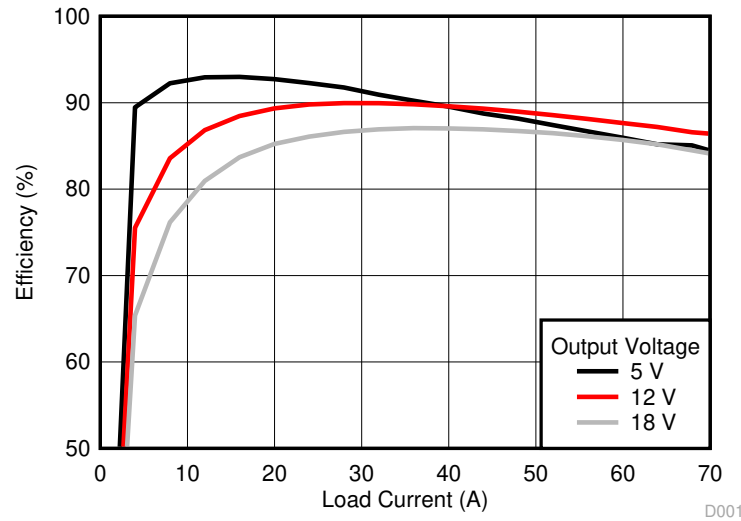

Figure 7-1. Efficiency of Output vs Line and Load

7.2 Load Regulation

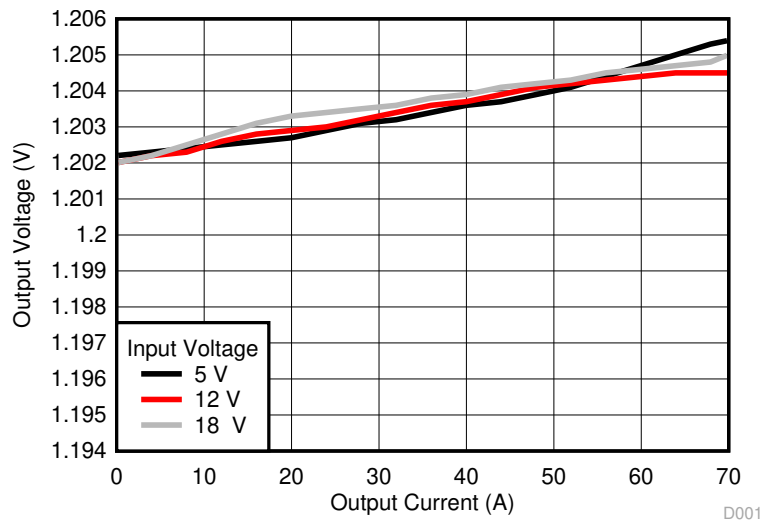

Figure 7-2. Load Regulation of Output

7.3 Line Regulation

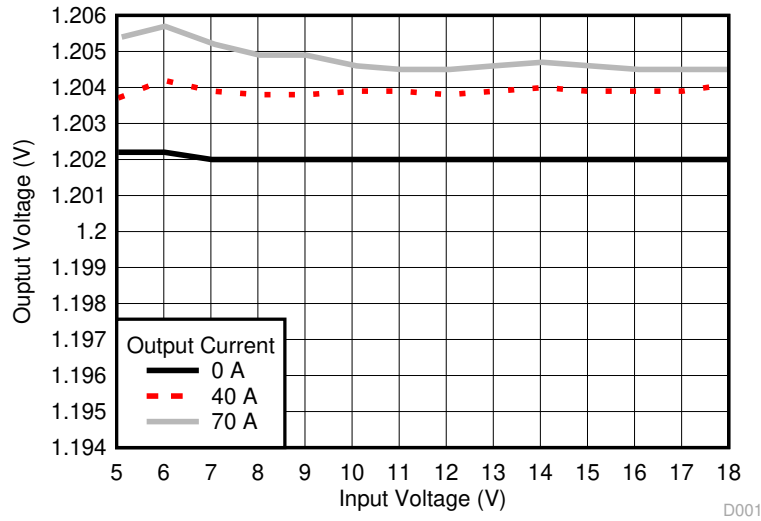
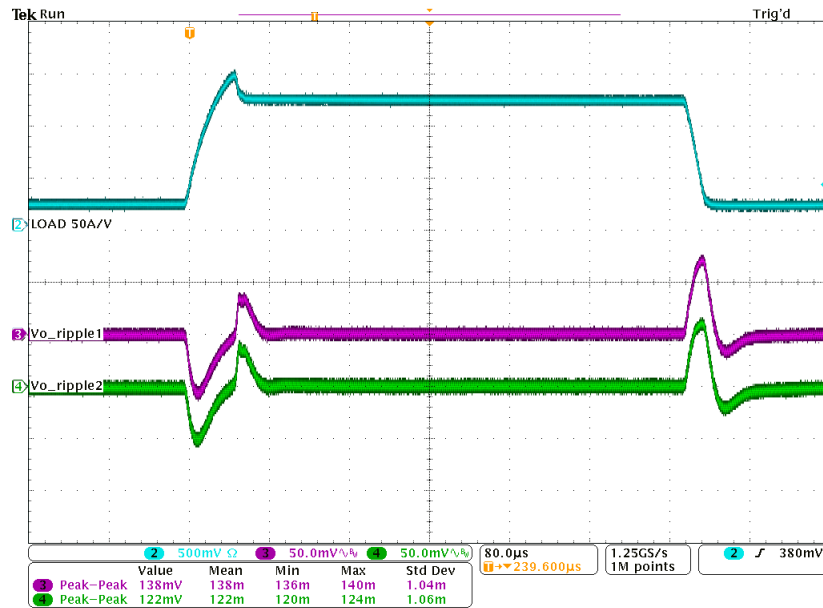

Figure 7-3. Line Regulation of 1.2-V Output (Different Board)

7.4 Transient Response



Ch1 = I_{OUT} at 25 A/division, Ch3 = V_{OUT} (AC coupled, measured at U1 side) at 50 mV/division, Ch4 = V_{OUT} (AC coupled, measured at U2 side) at 50 mV/division

Figure 7-4. Transient Response of 1.2-V Output at 12 V_{IN} , Transient is 10 A to 60 A, 0.2 A/ μ s

7.5 Output Ripple

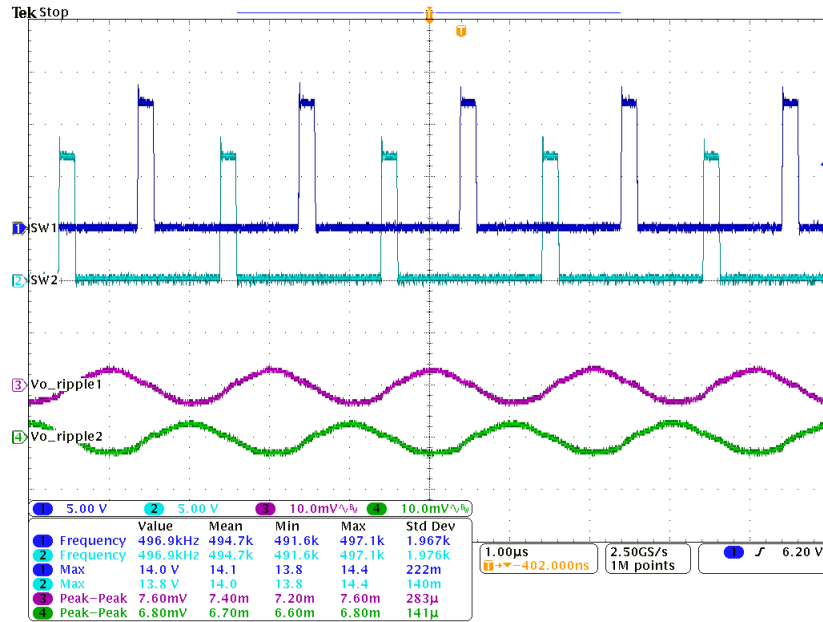

Ch1 = V_{SW1} at 5 V/division, Ch2 = V_{SW2} at 5 V/division, Ch3 = V_{OUT} (AC coupled, measured at U1 side) ripple at 10 mV/division, Ch4 = V_{OUT} (AC coupled, measured at U2 side) ripple at 10 mV/division

Figure 7-5. Output Ripple and SW Node of 1.2-V Output at 12 V_{IN} , 0-A Output

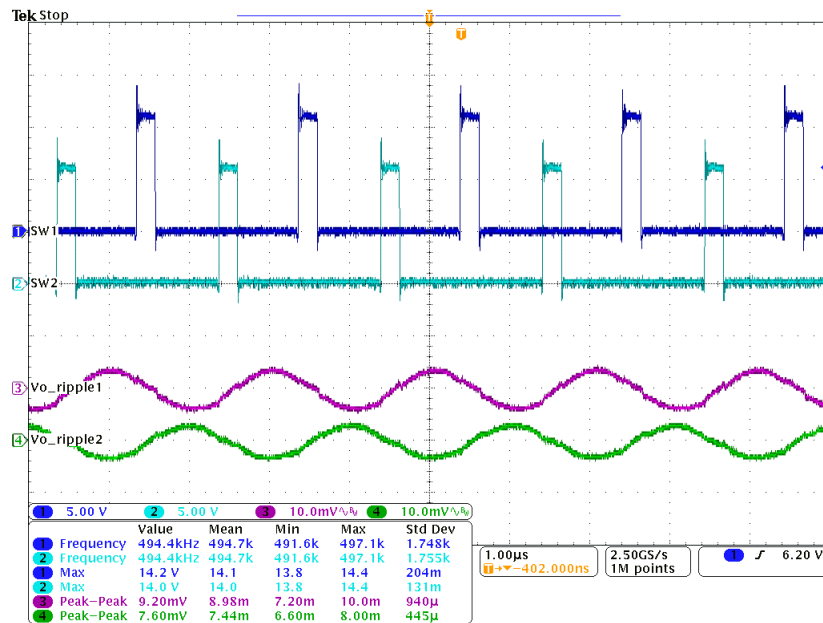

Ch1 = V_{SW1} at 5 V/division, Ch2 = V_{SW2} at 5 V/division, Ch3 = V_{OUT} (AC coupled, measured at U1 side) ripple at 10 mV/division, Ch4 = V_{OUT} (AC coupled, measured at U2 side) ripple at 10 mV/division

Figure 7-6. Output Ripple and SW Node of 1.2-V Output at 12 V_{IN} , 70-A Output

7.6 Control On

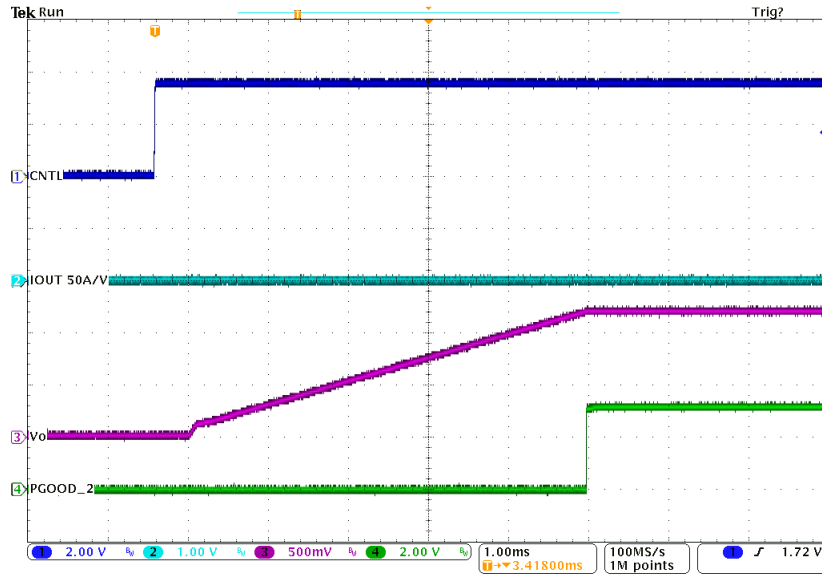

Ch1 = CNTL at 2 V/division, Ch2 = I_{OUT} at 50 A/division, Ch3 = V_{OUT} at 500 mV/division, Ch4 = PGOOD at 2 V/division

Figure 7-7. Start-Up from Control, 1.2-V Output at 12 V_{IN} , 0-A Output (TON_RISE is Modified to 5 ms)

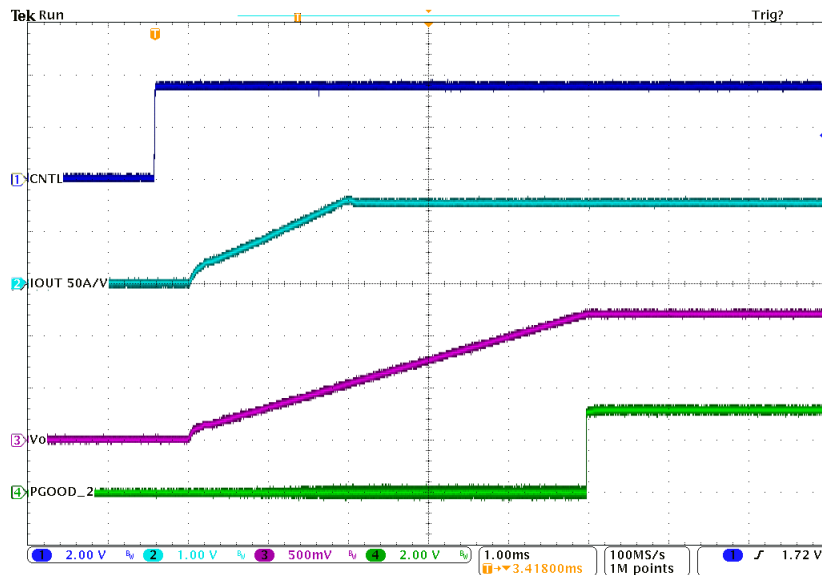

Ch1 = CNTL at 2 V/division, Ch2 = I_{OUT} at 50 A/division, Ch3 = V_{OUT} at 500 mV/division, Ch4 = PGOOD at 2 V/division

Figure 7-8. Start-Up from Control, 1.2-V Output at 12 V_{IN} , 70-A Output (TON_RISE is Modified to 5 ms)

7.7 Control Off

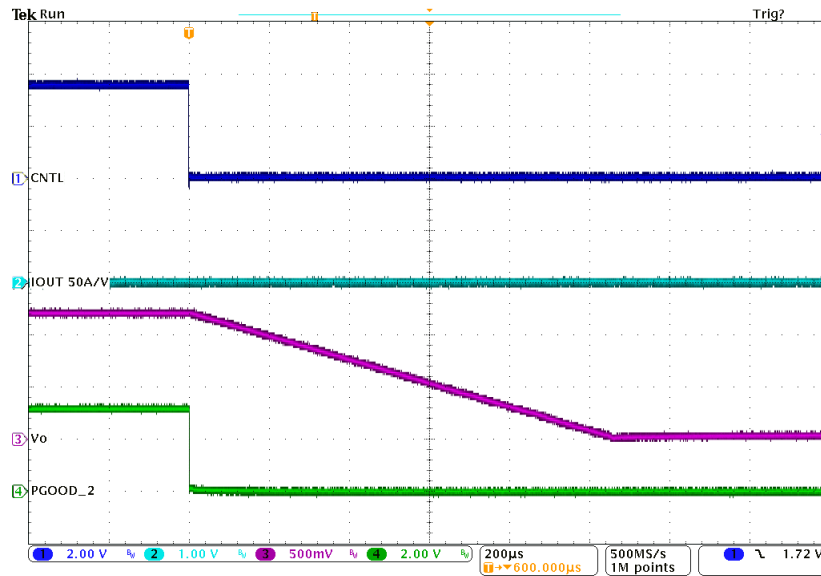

Ch1 = CNTL at 2 V/division, Ch2 = I_{OUT} at 50 A/division, Ch3 = V_{OUT} at 500 mV/division, Ch4 = PGOOD at 2 V/division

Figure 7-9. Soft Stop from Control, 1.2-V Output at 12 V_{IN} , 0-A Output (TON_RISE is Modified to 5 ms)

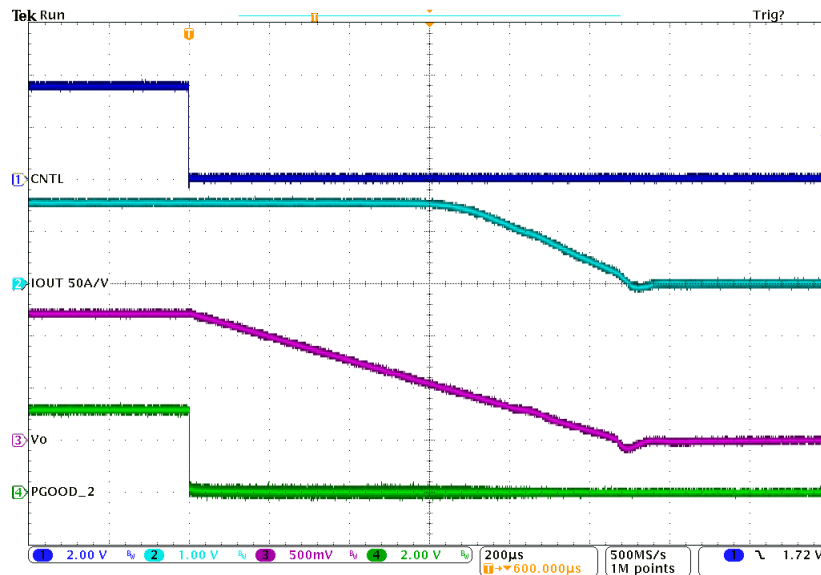

Ch1 = CNTL at 2 V/division, Ch2 = I_{OUT} at 50 A/division, Ch3 = V_{OUT} at 500 mV/division, Ch4 = PGOOD at 2 V/division

Figure 7-10. Soft Stop from Control, 1.2-V Output at 12 V_{IN} , 70-A Output (TON_RISE is Modified to 5 ms)

7.8 Current Sharing Between Two Phases

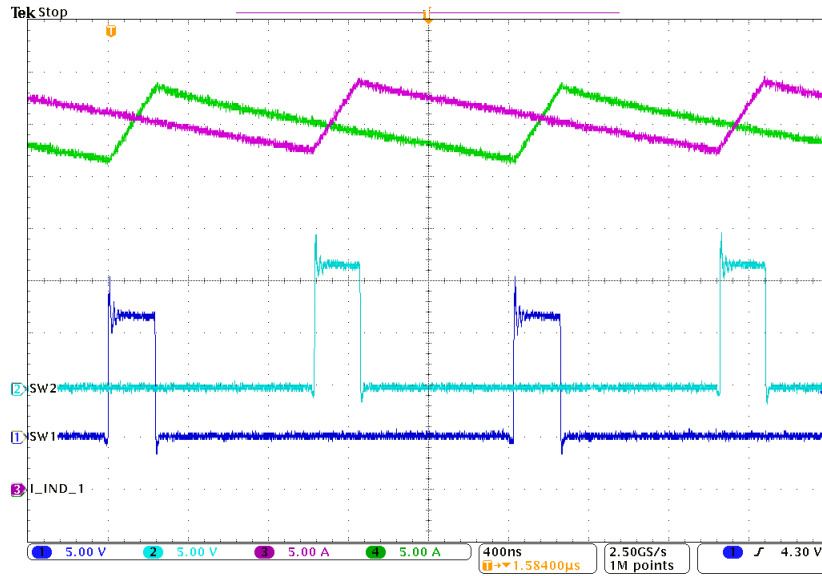

Ch1 = V_{SW1} at 5 V/division, Ch2 = V_{SW2} at 5 V/division, Ch3 = I_{L2} at 5 A/division, Ch4 = I_{L1} at 5 A/division

Figure 7-11. Inductor Current and Switch Node Waveform, 1.2-V Output at 12 V_{IN}, 70-A Output

7.9 Control Loop Bode Plot

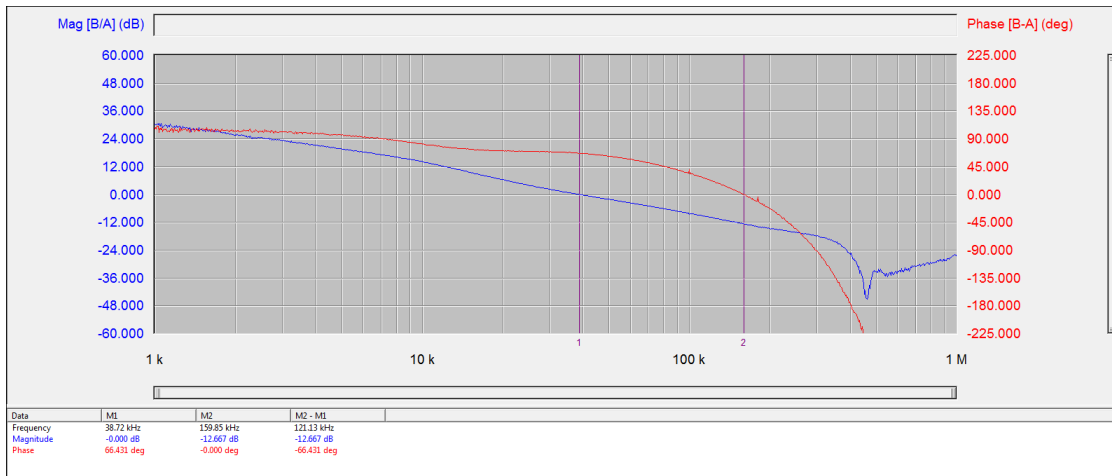

Figure 7-12. Bode Plot at 1.2-V Output at 12 V_{IN}, 0-A Output

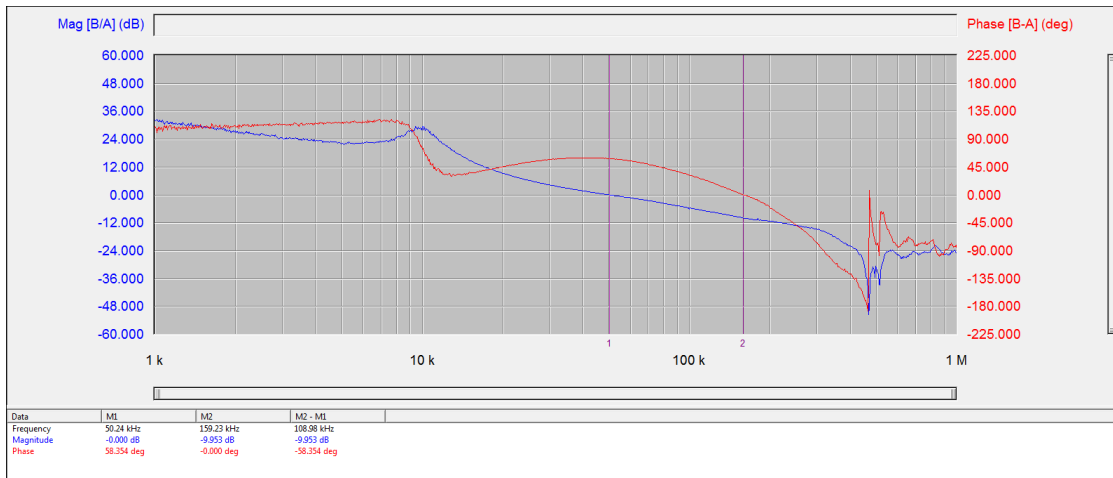
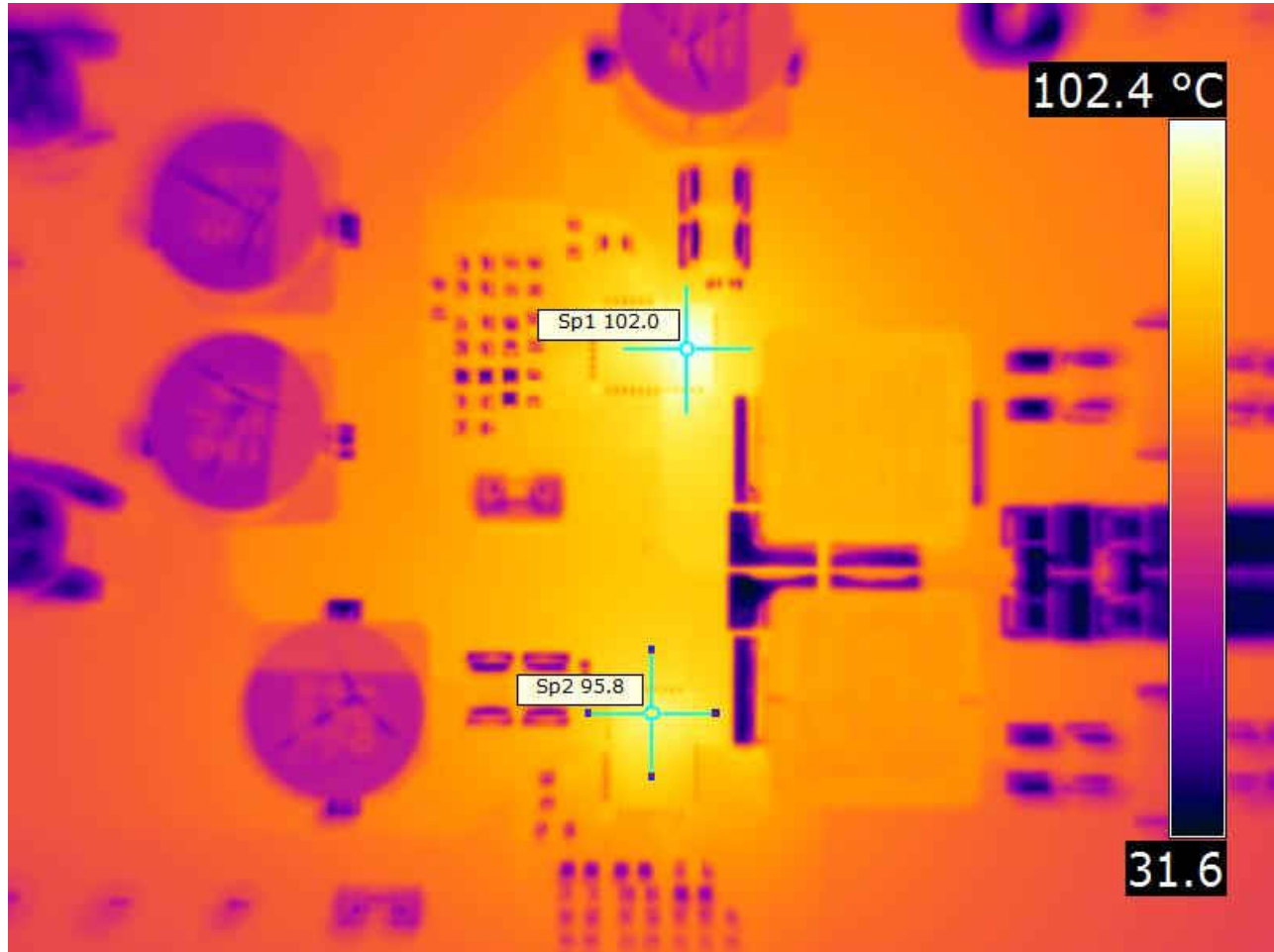

Figure 7-13. Bode Plot at 1.2-V Output at 12 V_{IN}, 70-A Output

7.10 Thermal Image



$V_{IN} = 12\text{ V}$, $I_{OUT} = 70\text{ A}$, $V_{OUT} = 1.2\text{ V}$, $F_{sw} = 500\text{ kHz}$

Figure 7-14. Thermal Image

8 EVM Assembly Drawing and PCB Layout

Figure 8-1 through Figure 8-9 show the design of the TPS546C23EVM2-746 EVM printed circuit board.

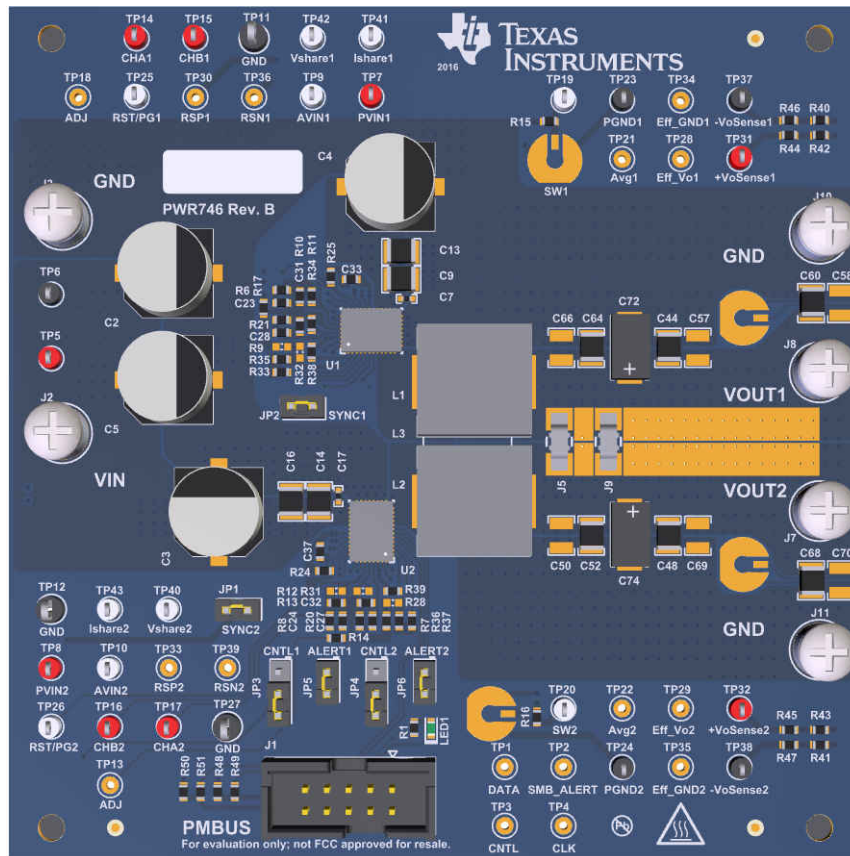

Figure 8-1. TPS546C23EVM2-746 EVM 3D (Top View)

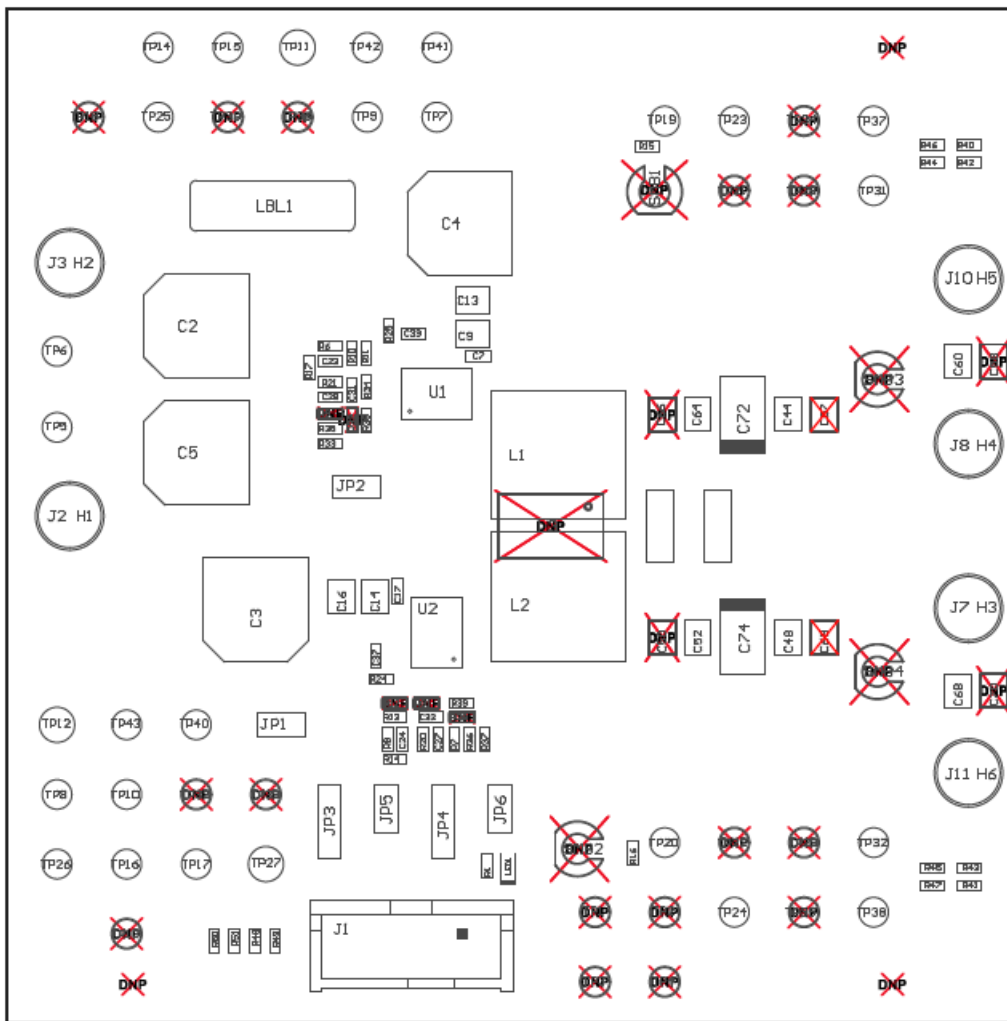

Figure 8-2. TPS546C23EVM2-746 EVM Top Layer Assembly Drawing (Top View)

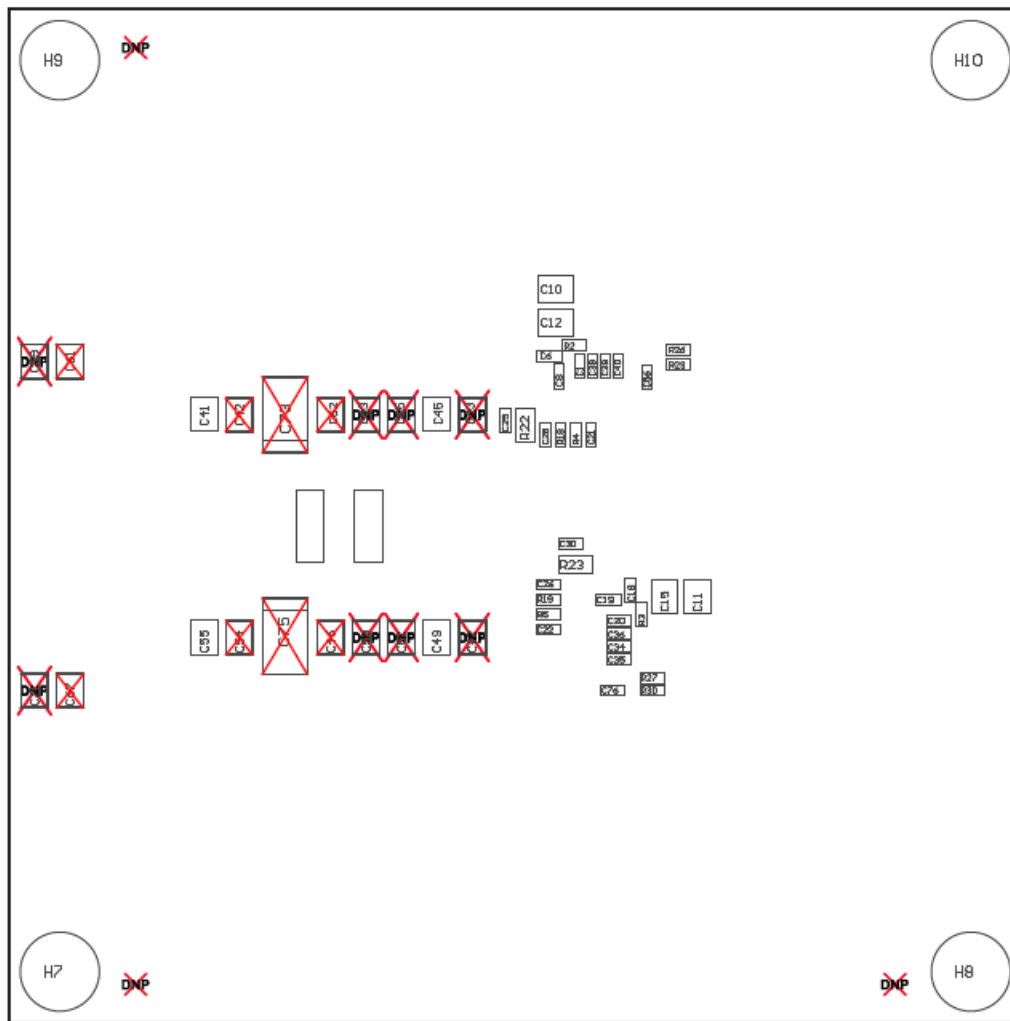

Figure 8-3. TPS546C23EVM2-746 EVM Bottom Assembly Drawing (Bottom View)

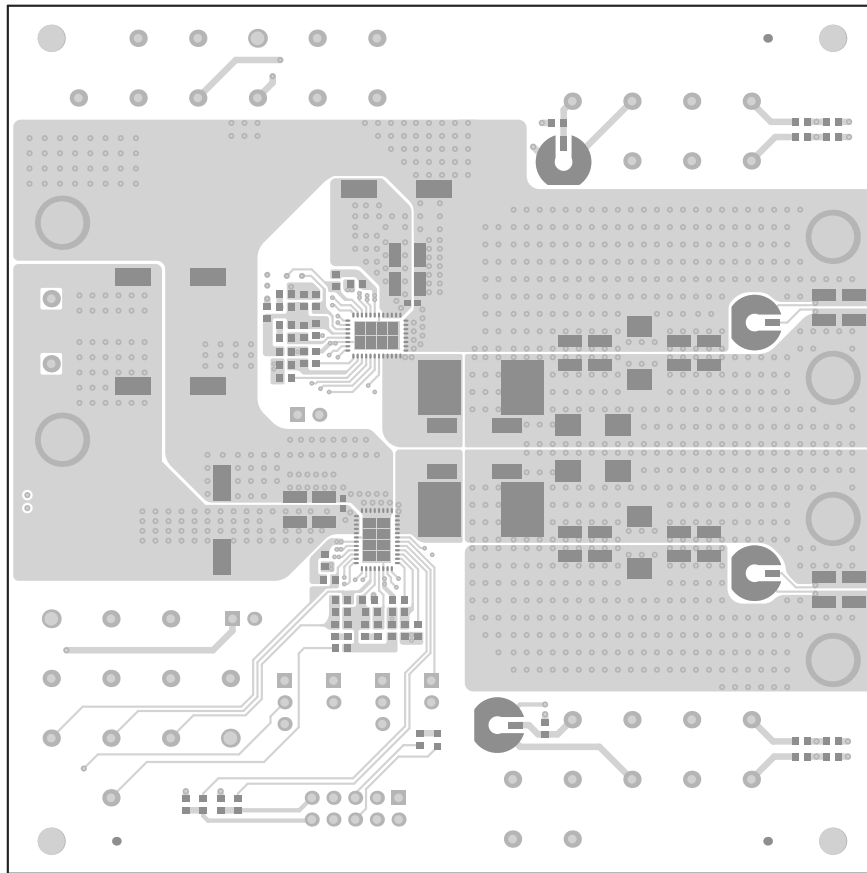

Figure 8-4. TPS546C23EVM2-746 EVM Top Copper (Top View)

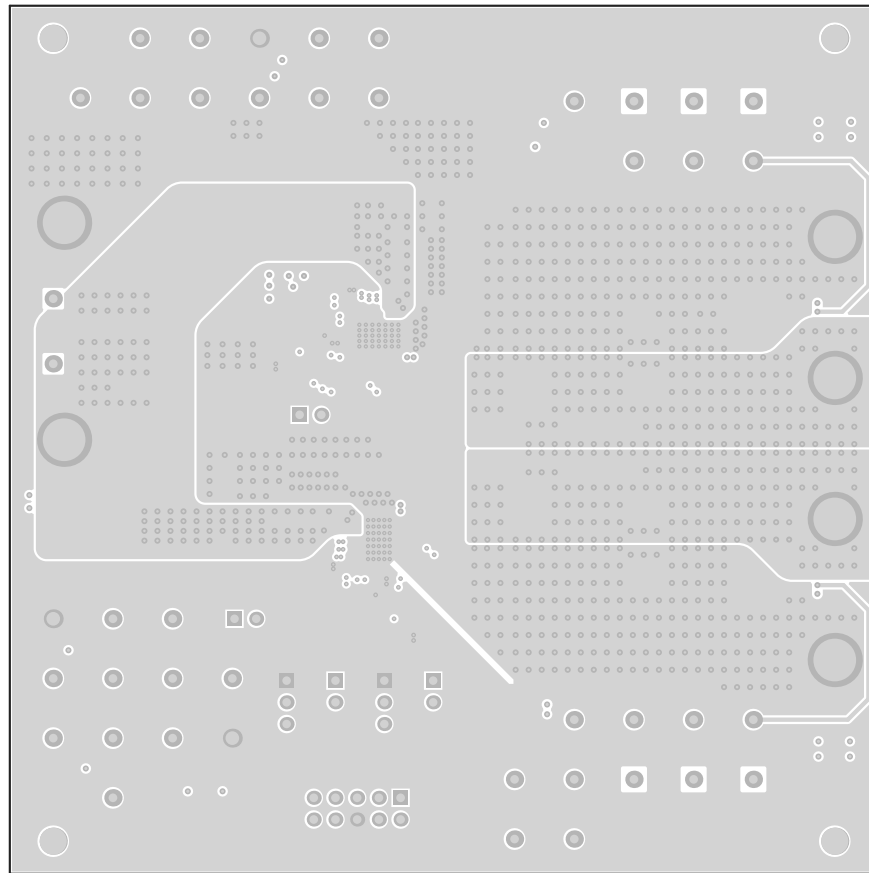

Figure 8-5. TPS546C23EVM2-746 EVM Internal Layer 1 (Top View)

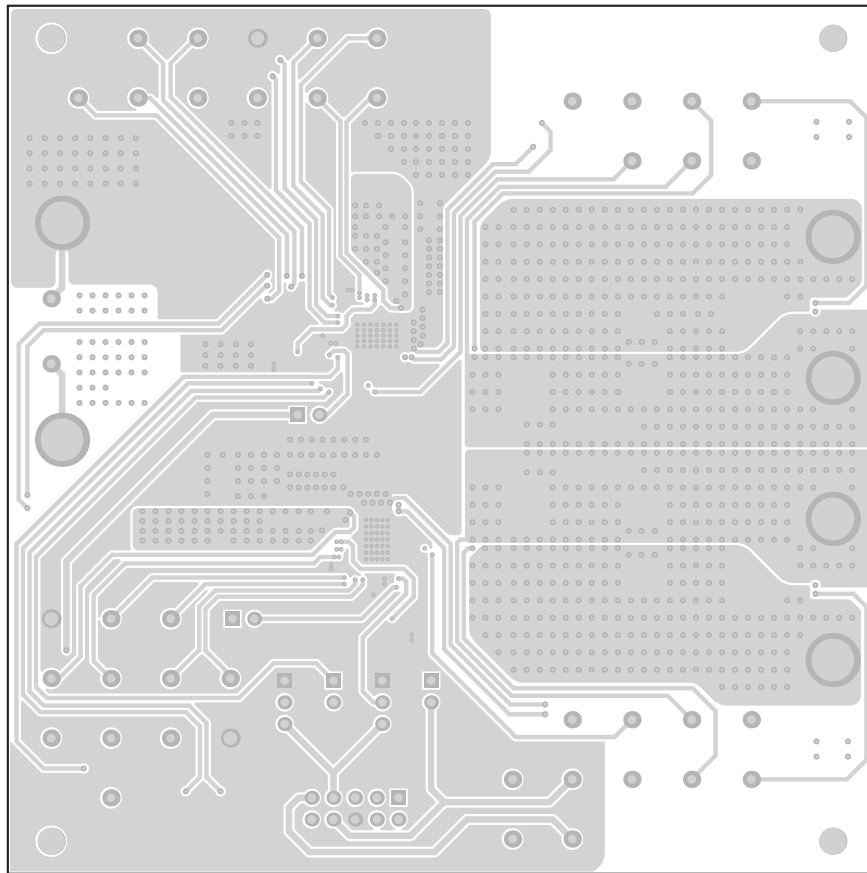

Figure 8-6. TPS546C23EVM2-746 EVM Internal Layer 2 (Top View)

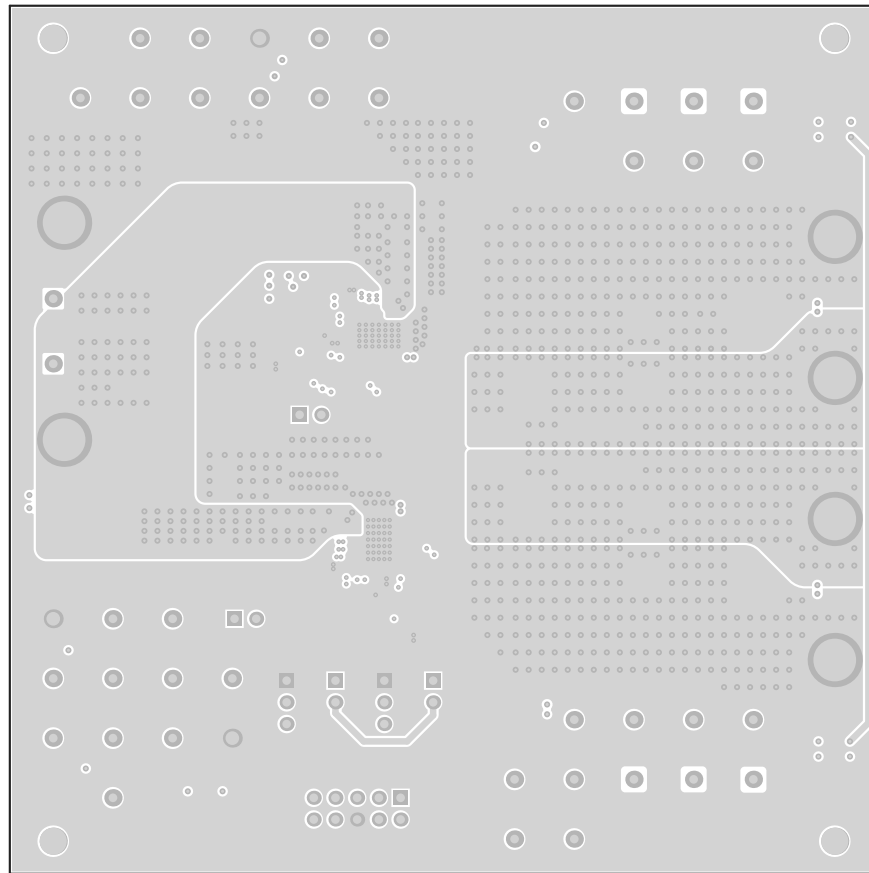

Figure 8-7. TPS546C23EVM2-746 EVM Internal Layer 3 (Top View)

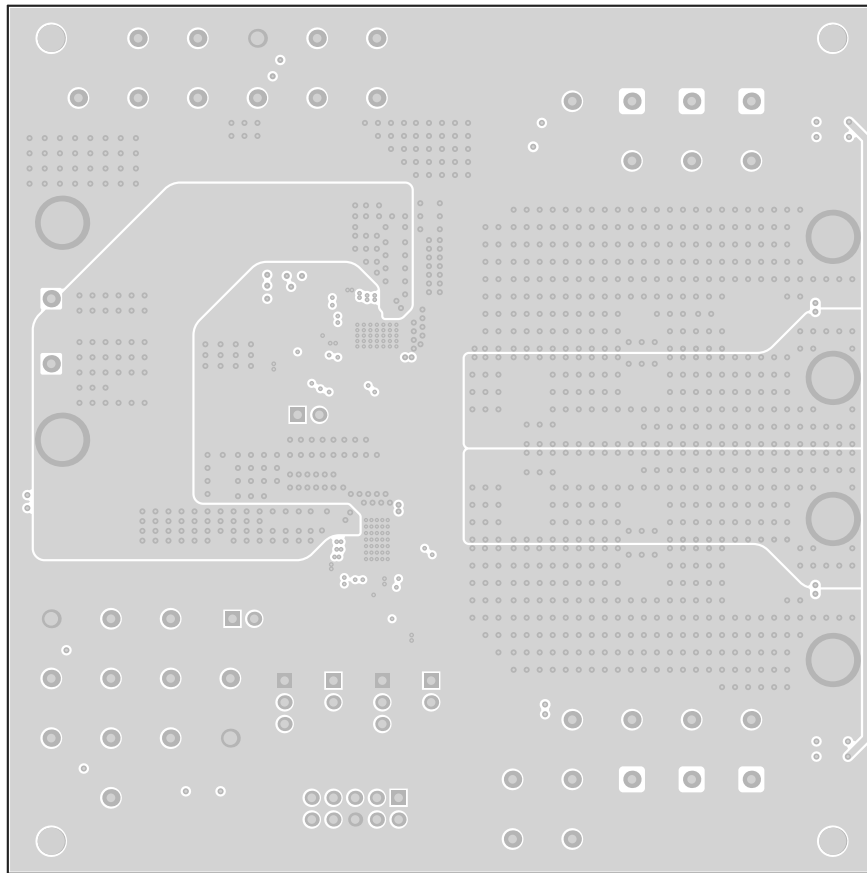

Figure 8-8. TPS546C23EVM2-746 EVM Internal Layer 4 (Top View)

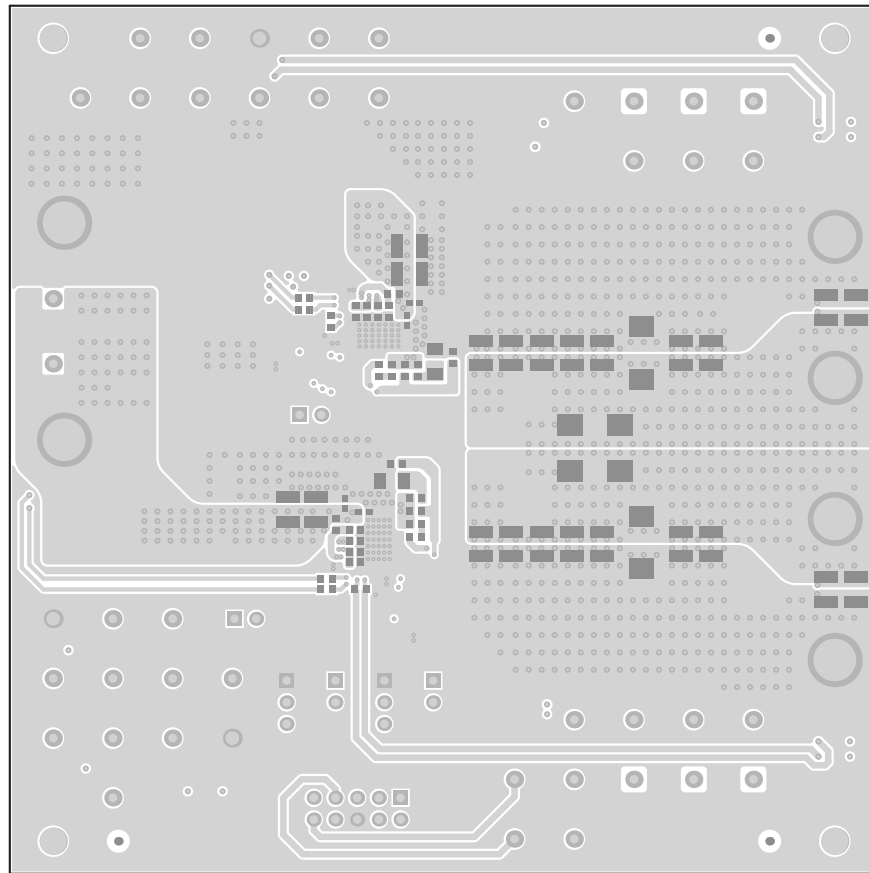

Figure 8-9. TPS546C23EVM2-746 EVM Bottom Copper (Top View)

9 Bill of Materials

Table 9-1 lists the BOM for the TPS546C23EVM2-746 (TPS546C23 EVM).

Table 9-1. TPS546C23EVM2-746 Components List

Qty	Designator	Description	Part Number	Manufacturer
4	C1, C20, C29, C31	CAP, CERM, 1 µF, 25 V, ±10%, X7R, 0603	GRM188R71E105KA12D	MuRata
4	C2–C5	CAP, AL, 100 µF, 35 V, ±20%, 0.15 Ω, SMD	EEE-FC1V101P	Panasonic
6	C6–C8, C17–C19	CAP, CERM, 6800 pF, 50 V, ±10%, X7R, 0402	GRM155R71H682KA88D	MuRata
8	C9–C16	CAP, CERM, 22 µF, 25 V, ±10%, X6S, 1210	GRM32EC81E226KE15L	MuRata
2	C21, C22	CAP, CERM, 0.1 µF, 50 V, ±10%, X7R, 0603	C0603C104K5RACTU	Kemet
2	C23, C24	CAP, CERM, 1200 pF, 100 V, ±5%, C0G/NP0, 0603	GRM1885C2A122JA01D	MuRata
2	C25, C26	CAP, CERM, 1000 pF, 100 V, ±5%, X7R, 0603	06031C102JAT2A	AVX
2	C27, C28	CAP, CERM, 2200 pF, 50 V, ±5%, C0G/NP0, 0603	GRM1885C1H222JA01D	MuRata
2	C31, C32	CAP, CERM, 270 pF, 50 V, ±5%, C0G/NP0, 0603	GRM1885C1H271JA01D	MuRata
4	C33, C36–C38	CAP, CERM, 2.2 µF, 16 V, ±10%, X7R, 0603	GRM188Z71C225KE43	MuRata
2	C34, C39	CAP, CERM, 4.7 µF, 10 V, ±10%, X5R, 0603	C0603C475K8PACTU	Kemet
2	C35, C40	CAP, CERM, 0.1 µF, 16 V, ±10%, X7R, 0603	C0603C104K4RACTU	Kemet
10	C41, C44, C45, C48, C49, C52, C55, C60, C64, C68	CAP, CERM, 47 µF, 10 V, ±10%, X7R, 1210	GRM32ER71A476KE15L	MuRata
2	C56, C76	CAP, CERM, 330 pF, 50 V, ±1%, C0G/NP0, 0603	C1608C0G1H331F080AA	TDK
2	C72, C74	CAP, Tantalum Polymer, 470 µF, 6.3 V, ±20%, 0.01 Ω, 7343-40 SMD	6TPF470MAH	Panasonic
6	H1–H6	MACHINE SCREW PAN PHILLIPS 6-32	PMSSS 632 0038 PH	B&F Fastener Supply
4	H7–H10	Bump, Cylindrical, 0.312 × 0.200, Black	SJ61A1	3M
1	J1	Header (shrouded), 100 mil, 5×2, Gold, TH	5103308-1	TE Connectivity
6	J2, J3, J7, J8, J10, J11	Swage Threaded Standoff, Brass, Swage Mount, TH	1546	Keystone
4	J4, J5, J6, J9	JUMPER TIN SMD	S1911-46R	Harwin
8	JP1, JP2, JP5, JP6	Header, 100 mil, 2×1, Tin, TH	5-146278-2	TE Connectivity
2	JP3, JP4	Header, 100 mil, 3×1, Tin, TH	5-146278-3	TE Connectivity
2	L1, L2	Inductor, Shielded, Ferrite, 300 nH, 52 A, 0.00015 Ω, SMD	SLC1480-301MLB	Coilcraft
1	LBL1	Thermal Transfer Printable Labels, 0.650" W × 0.200" H - 10,000 per roll	THT-14-423-10	Brady
1	LED1	LED, Green, SMD	150060GS75000	Würth Elektronik
1	R1	RES, 1.00 k, 1%, 0.1 W, 0603	CRCW06031K00FKEA	Vishay-Dale
14	R2–R5, R29, R30, R40–R43, R48–R51	RES, 0, 5%, 0.1 W, 0603	ERJ-3GEY0R00V	Panasonic
2	R6, R8	RES, 1.10 k, 1%, 0.1 W, 0603	RC0603FR-071K1L	Yageo America
9	R7, R10, R13, R14, R17–R19, R24, R25	RES, 10.0 k, 0.1%, 0.1 W, 0603	RT0603BRD0710KL	Yageo America
7	R11, R15, R16, R44–R47	RES, 49.9, 1%, 0.1 W, 0603	CRCW060349R9FKEA	Vishay-Dale
8	R14, R17–R21, R24, R25	RES, 10.0 k, 1%, 0.1 W, 0603	RC0603FR-0710KL	Yageo America
2	R20, R21	RES, 5.60 k, 1%, 0.1 W, 0603	RC0603FR-075K6L	Yageo America
2	R22, R23	RES, 1.0, 5%, 0.25 W, 1206	CRCW12061R00JNEA	Vishay-Dale
2	R26, R27	RES, 5.11 k, 1%, 0.1 W, 0603	CRCW06035K11FKEA	Vishay-Dale
2	R33, R35	RES, 34.8 k, 1%, 0.1 W, 0603	RC0603FR-0734K8L	Yageo America
2	R36, R37	RES, 51.1 k, 1%, 0.1 W, 0603	RC0603FR-0751K1L	Yageo America
2	R38, R39	RES, 40.2 k, 1%, 0.1 W, 0603	CRCW060340K2FKEA	Vishay-Dale
6	SH-JP1–SH-JP6	Shunt, 100 mil, Gold plated, Black	969102-0000-DA	3M
7	TP5, TP14–TP17, TP31, TP32	Test Point, Miniature, Red, TH	5000	Keystone
3	TP6, TP23, TP24	Test Point, Miniature, Black, TH	5001	Keystone
2	TP7, TP8	Test Point, Miniature, Red, TH	5000	Keystone
10	TP9, TP10, TP25, TP26, TP43, TP19, TP20, TP40, TP41, TP42	Test Point, Miniature, White, TH	5002	Keystone

Table 9-1. TPS546C23EVM2-746 Components List (continued)

Qty	Designator	Description	Part Number	Manufacturer
3	TP11, TP12, TP27	Test Point, Multipurpose, Black, TH	5011	Keystone
2	TP37, TP38	Test Point, Miniature, Black, TH	5001	Keystone
2	U1, U2	4.5-V to 18-V, 35-A PMBUS STACKABLE SYNCHRONOUS BUCK CONVERTER, RVF0040A	TPS546C23	Texas Instruments

10 Screenshots

10.1 Fusion GUI Screenshots

When launching the Fusion GUI, select **IC_DEVICE_ID** (Figure 10-1) as the scanning mode to find the TPS546C23.

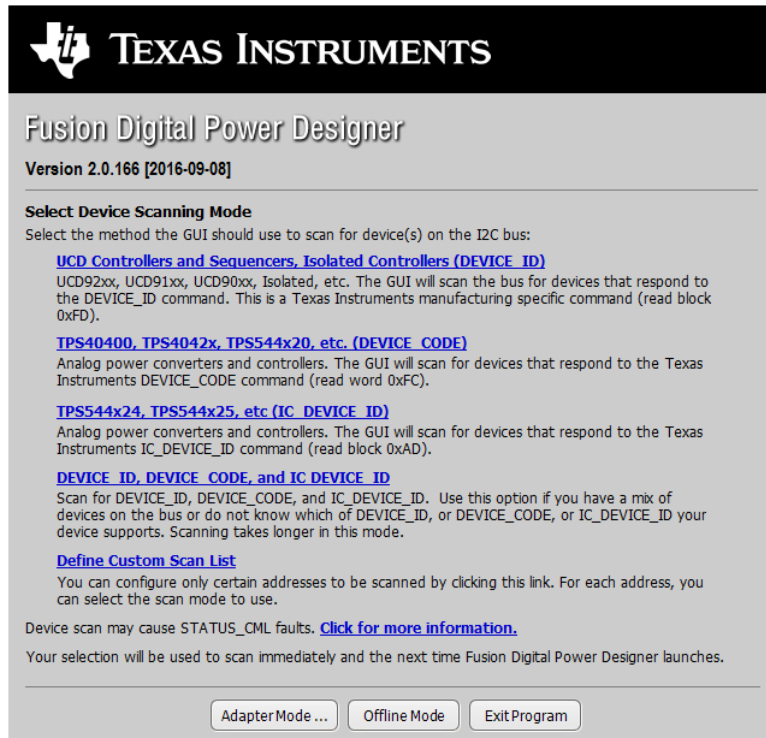
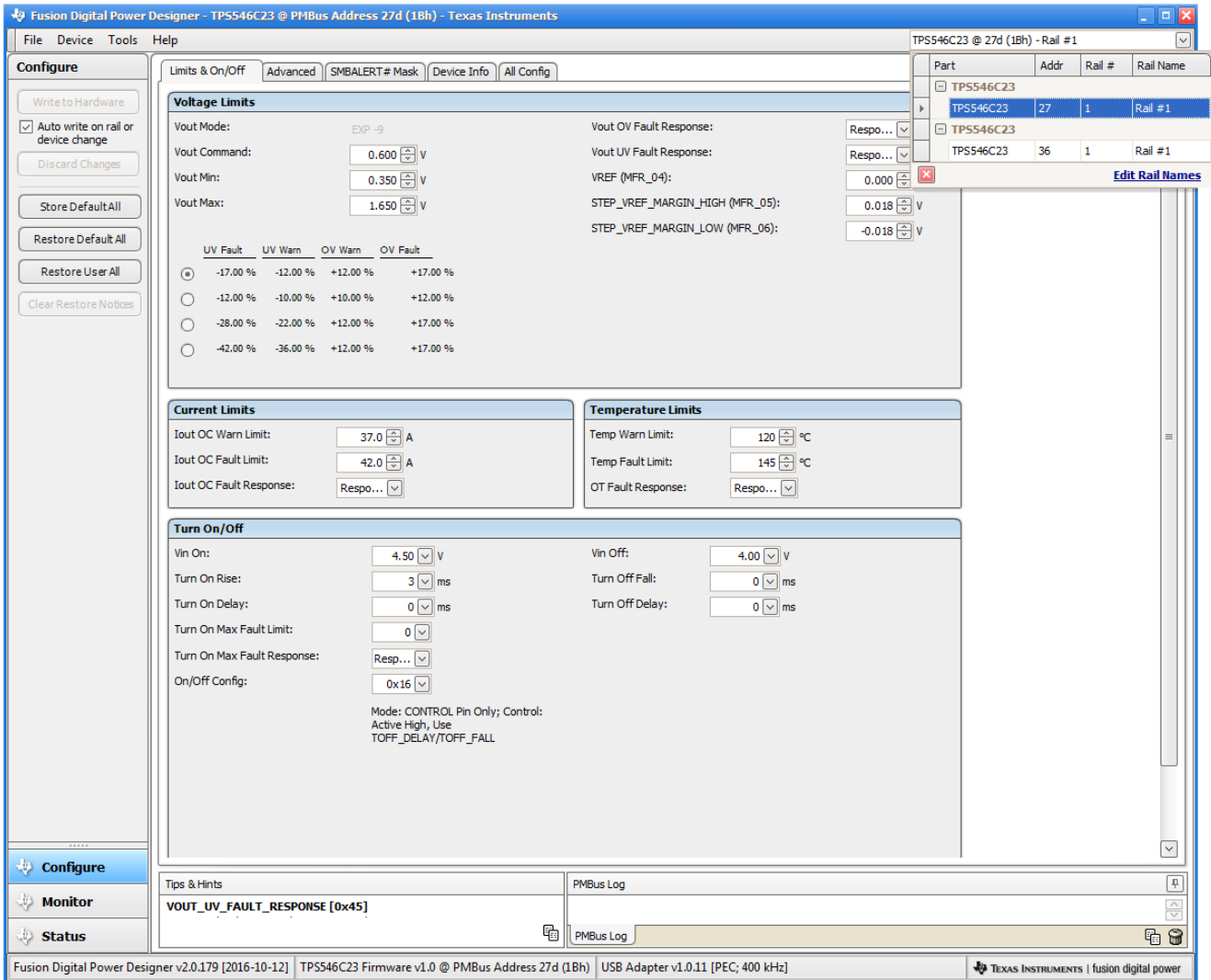

Figure 10-1. Select Device Scanning Mode

- Use the **Limits & On/Off** tab (Figure 10-2) to configure the following:
 - V_{ref} (Vout_Command)
 - OC fault and OC warn
 - OT fault and OT warn (die temperature)
 - Power-good limits
 - Fault response
 - UVLO
 - On/Off config
 - Soft-start time (turn-on rise)
 - Margin voltage

After making changes to one or more configurable parameters, the changes can be committed to nonvolatile memory by clicking **Store DefaultAll**. This action prompts a **confirm selection** pop-up, and if confirmed, the changes are committed to nonvolatile memory to store all the modifications in non-volatile memory.

Both the loop controller device and the loop follower device are tied to same bus interface. A scroll-down menu in the upper right corner can be used to switch view screens from one to the other. In a two-phase stacking system, most configurable parameters are disabled in GUI if the device is detected as loop follower (Figure 10-7).



The screenshot shows the Fusion Digital Power Designer software interface for configuring a TPS546C23 converter. The main window displays the 'Limits & On/Off' tab, which is divided into several sections:

- Voltage Limits:** Includes Vout Mode (EXP -9), Vout Command (0.600 V), Vout Min (0.350 V), and Vout Max (1.650 V). It also features a table for UV Fault, UV Warn, OV Warn, and OV Fault settings.
- Current Limits:** Includes Iout OC Warn Limit (37.0 A), Iout OC Fault Limit (42.0 A), and Iout OC Fault Response.
- Temperature Limits:** Includes Temp Warn Limit (120 °C), Temp Fault Limit (145 °C), and OT Fault Response.
- Turn On/Off:** Includes Vin On (4.50 V), Turn On Rise (3 ms), Turn On Delay (0 ms), Turn On Max Fault Limit (0 V), Turn On Max Fault Response, and On/Off Config (0x16).

The interface also includes a 'Configure' sidebar on the left with buttons like 'Write to Hardware', 'Auto write on rail or device change', 'Store DefaultAll', 'Restore Default All', 'Restore User All', and 'Clear Restore Notices'. A 'Part' table in the top right corner shows the device configuration:

Part	Addr	Rail #	Rail Name
TPS546C23	27	1	Rail #1
TPS546C23	36	1	Rail #1

The bottom status bar shows the software version (v2.0.179), device firmware (v1.0), and other system information.

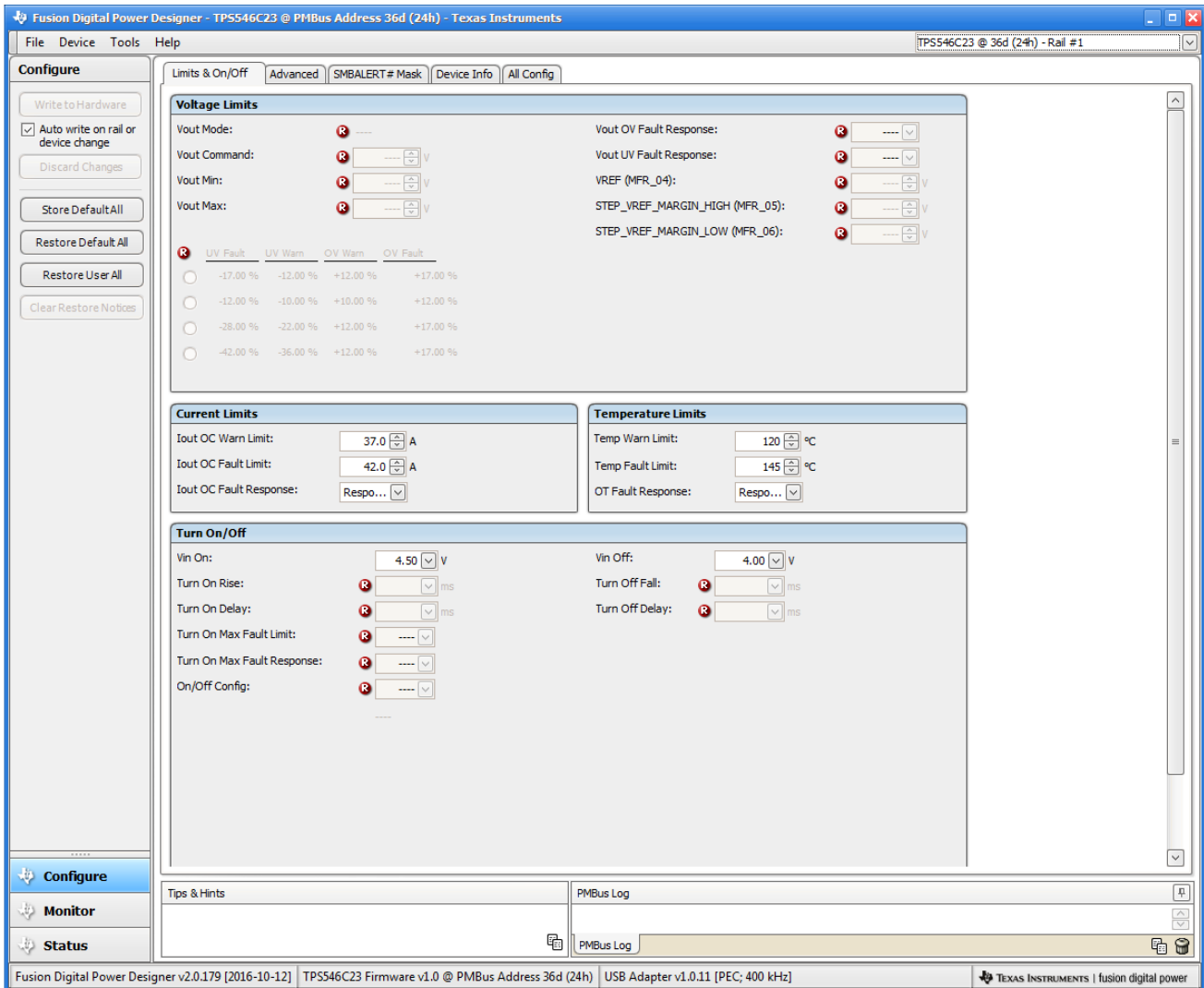

Figure 10-2. Configure – Limits and On/Off

Changing the on/off configuration prompts a pop-up window with details of the options (Figure 10-3).

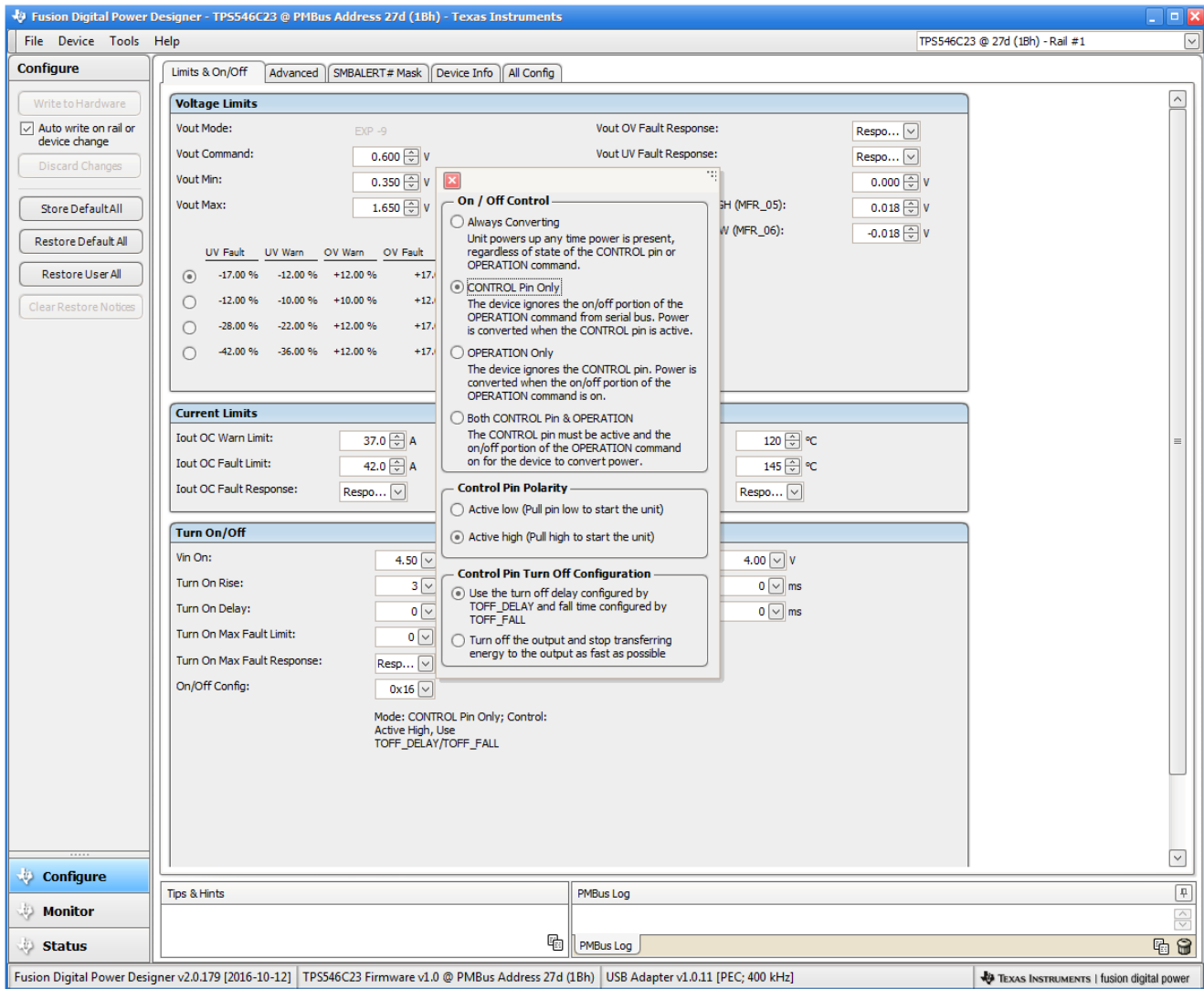

Figure 10-3. ON/OFF Control Pop-Up

- Use the **Advanced** tab (Figure 10-4) to configure:
 - OPTIONS: MFR_SPECIFIC_21 register
 - API_OPTIONS: MFR_SPECIFIC_32 register

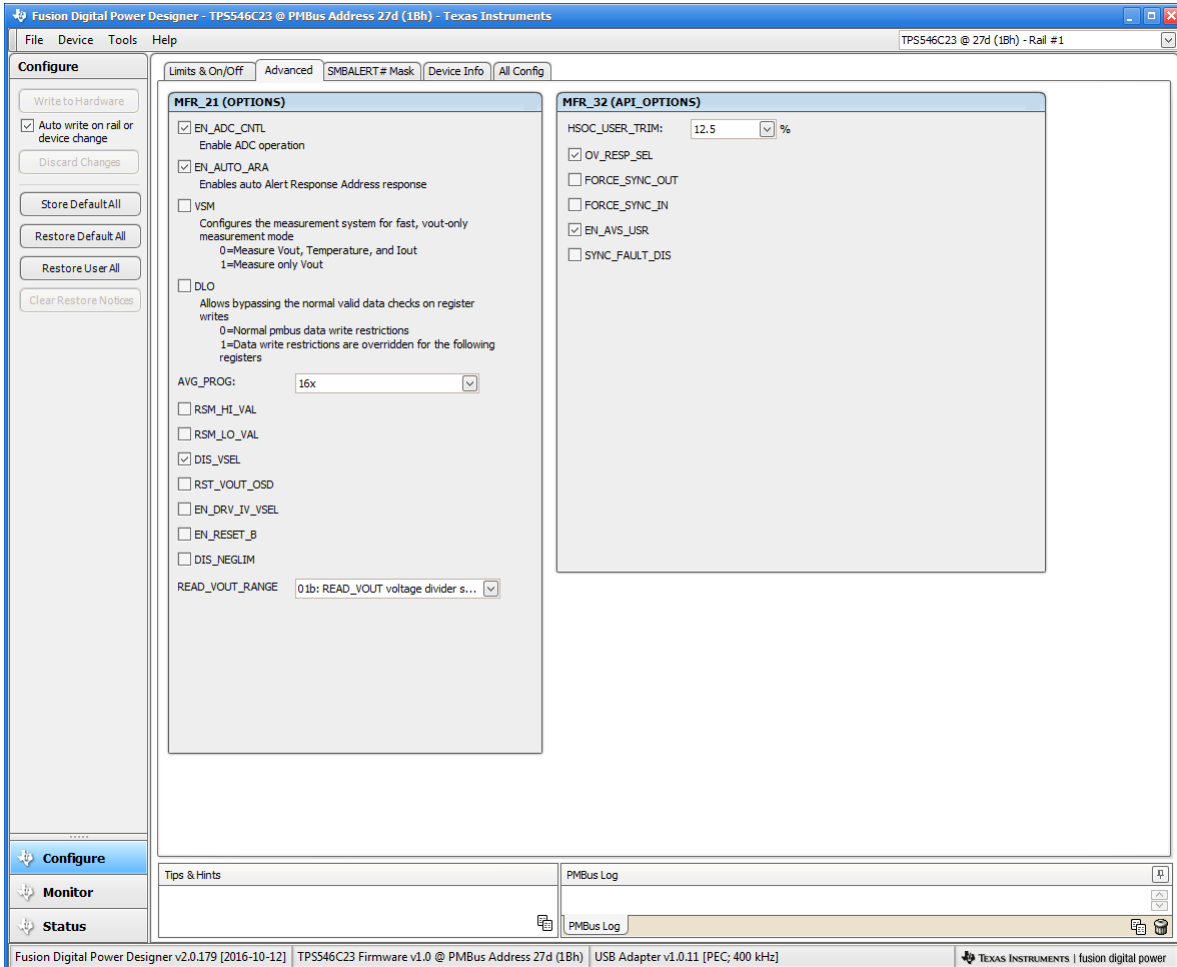

Figure 10-4. Configure – Advanced

The sources of SMBALERT that can be masked can be found and configured on the **SMBALERT # Mask** tab (Figure 10-5).

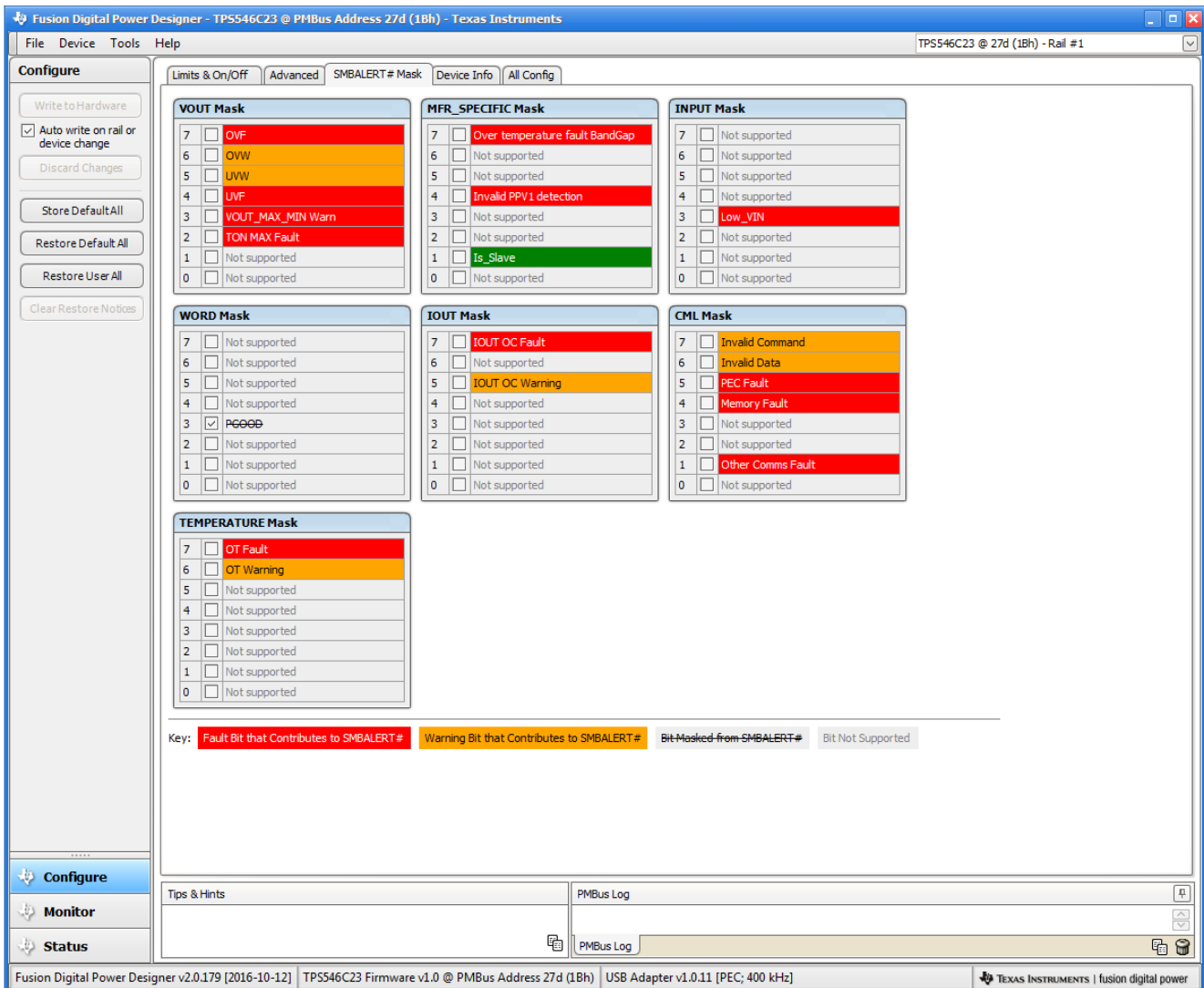

Figure 10-5. Configure – SMBALERT # Mask

The device information, User Scratch Pad, Write Protection options, and the configuration of **Vout Scale Loop**, **Vout Transition Rate**, and **Iout Cal Offset** can be found on **Device Info** tab (Figure 10-6).

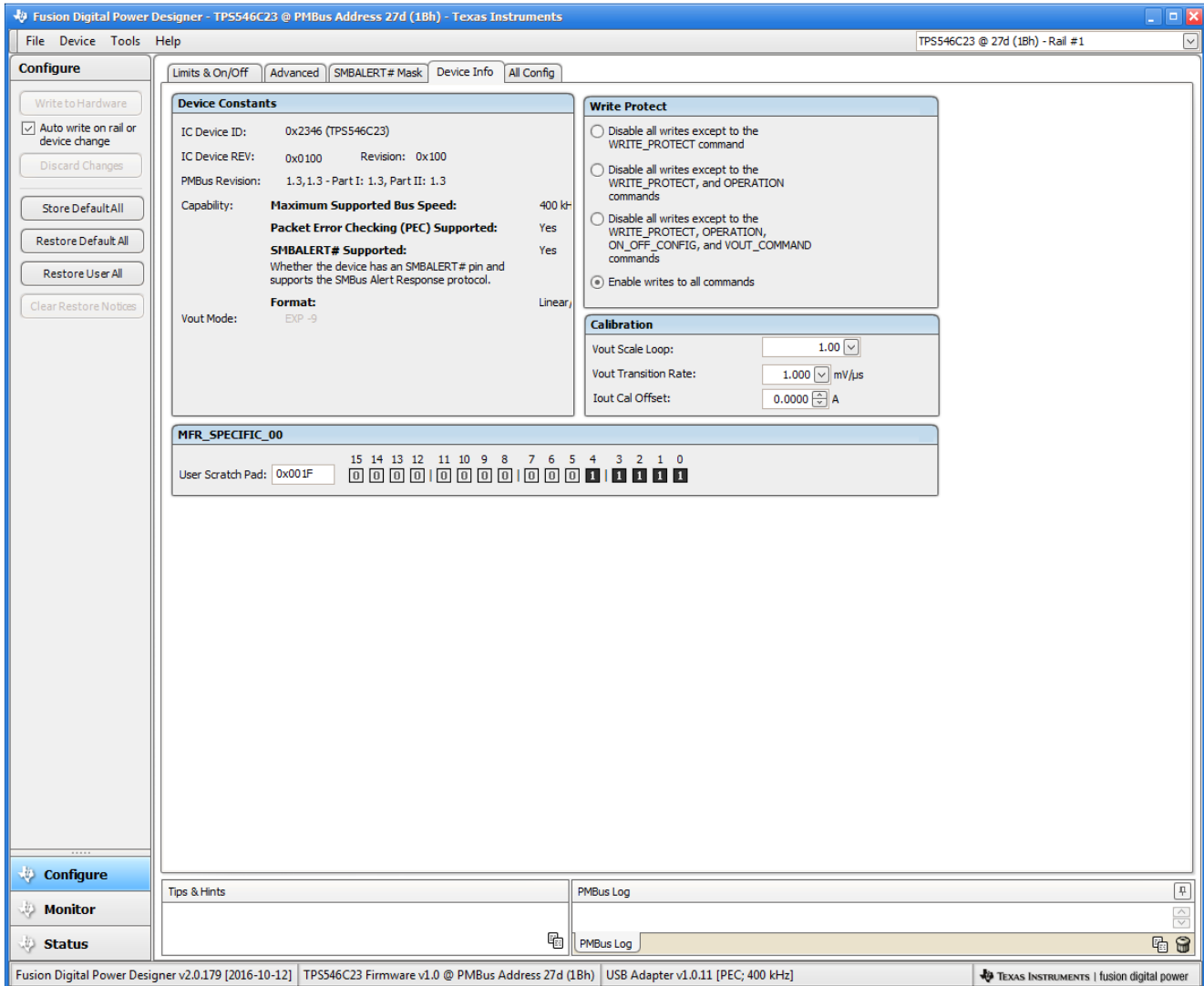

Figure 10-6. Configure – Device Info

Use the **All Config** tab (Figure 10-7) to configure all of the configurable parameters, which also shows other details like Hex encoding.

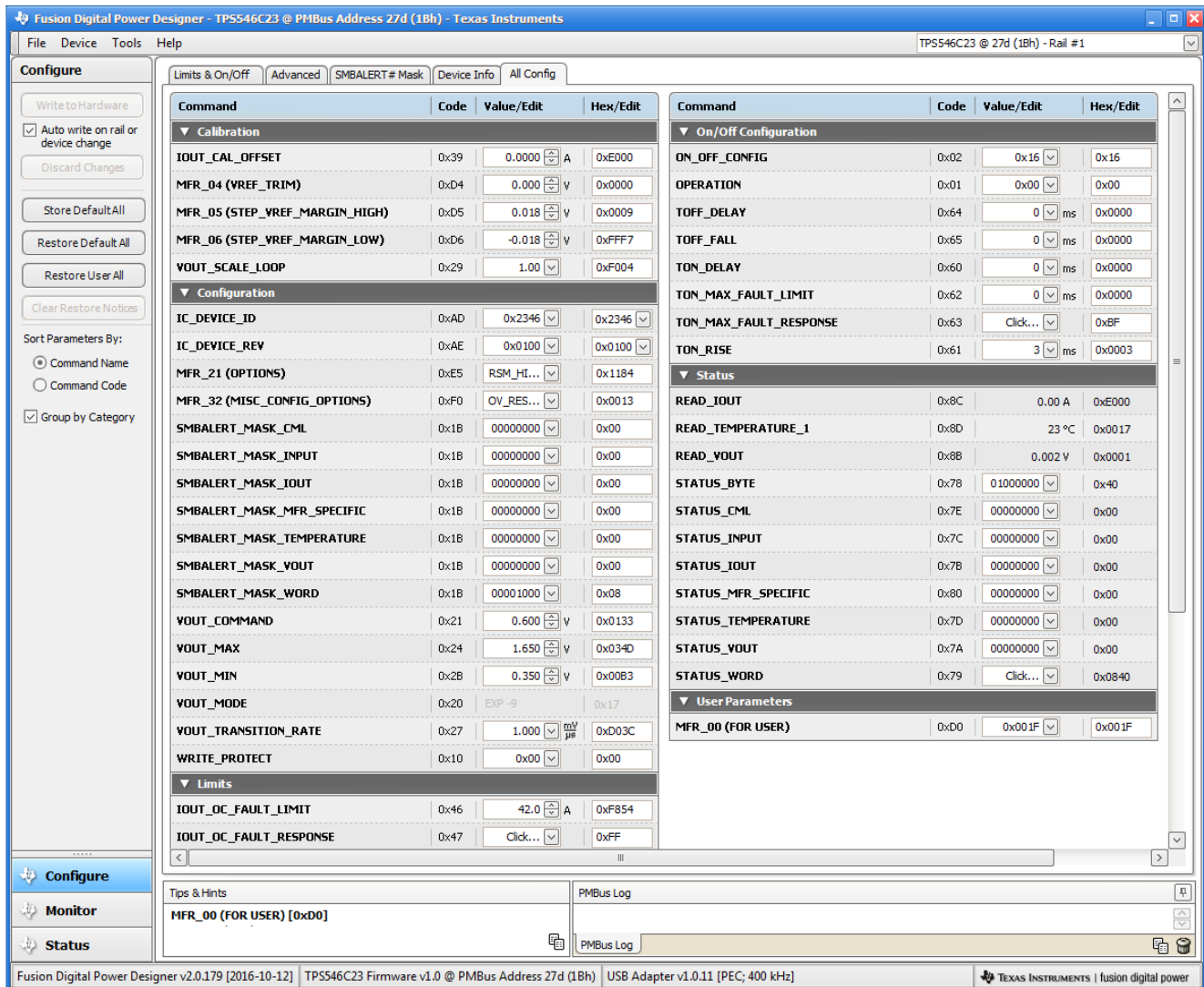
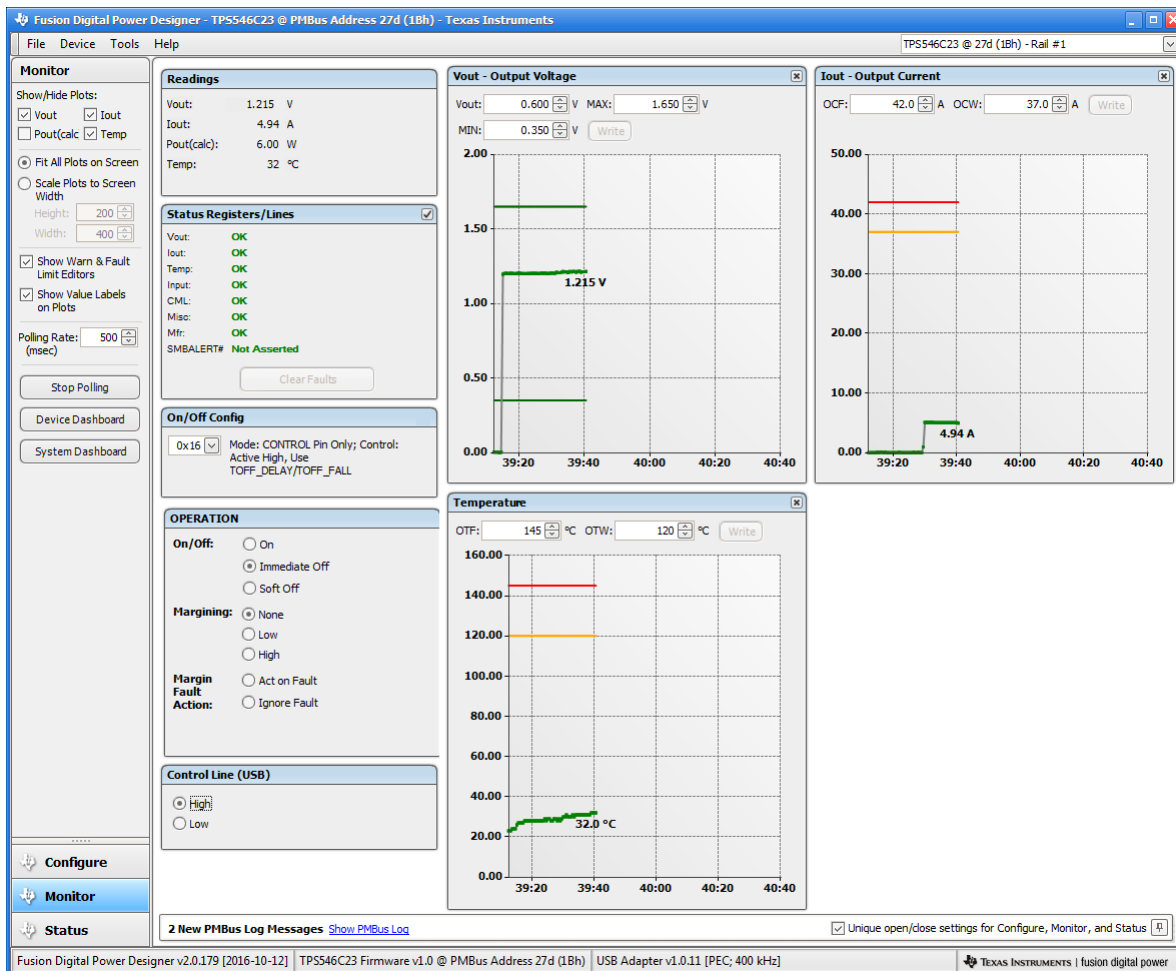

Figure 10-7. Configure – All Config

When the *Monitor* screen (Figure 10-8) is selected, the screen changes to display real-time data of the parameters that are measured by the device. This screen provides access to:

- Graphs of V_{OUT} , I_{out} , *Temperature*, and P_{out}
- *Start/Stop Polling*, which turns ON or OFF the real-time display of data
- Quick access to On/Off config
- Control pin activation and OPERATION command
- Margin control
- Clear Fault. Selecting **Clear Faults** clears any prior fault flags.

With two devices stacked together, the **IOUT** reading from either the loop controller or the loop follower device is the load current supported by the device itself, thus the **IOUT** reading is half of the total load.



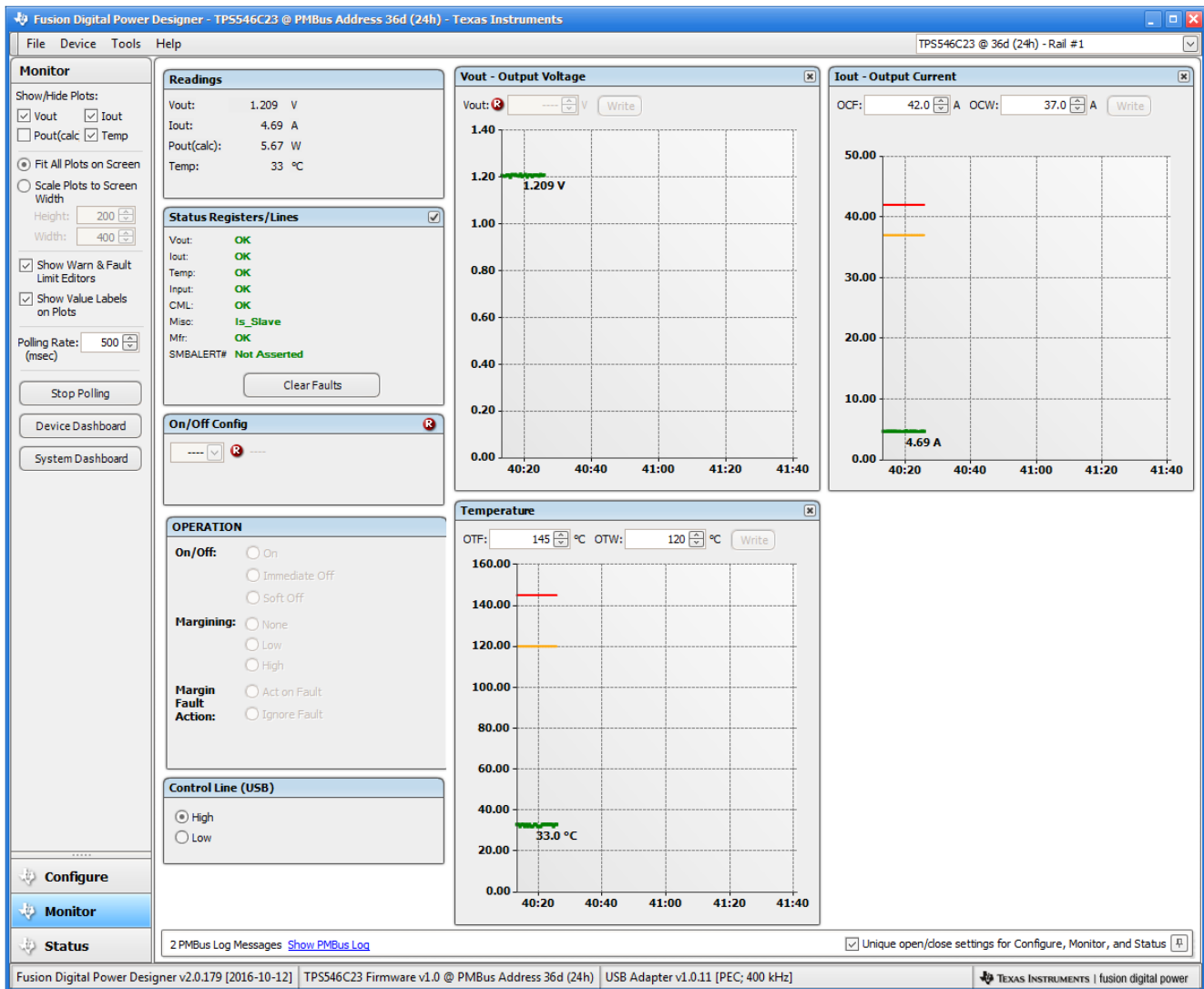

Figure 10-8. Monitor Screen with 10-A Total Load

Selecting *Status* screen (Figure 10-9) from lower left corner shows the status of the device.

Fusion Digital Power Designer - TPS546C23 @ PMBus Address 27d (1Bh) - Texas Instruments

File Device Tools Help TPS546C23 @ 27d (1Bh) - Rail #1

Status

Stop Polling

Launch Dashboard

Clear Faults

ARA

None

Configure

Monitor

Status

Status Registers

STATUS_VOUT 0x18

7	OVF	0x18
6	OVW	0x18
5	UVW	0x18
4	UVF	0x18
3	VOUT_MAX_MIN Warn	0x18
2	TON MAX Fault	0x18
1	0	0x18
0	0	0x18

STATUS_IOUT 0x19

7	IOUT OC Fault	0x19
6	IOUT OC Fault with LV Shutdown	0x19
5	IOUT OC Warning	0x19
4	IOUT UC Fault	0x19
3	Current Share Fault	0x19
2	Power Limiting Mode	0x19
1	POUT OP Fault	0x19
0	POUT OP Warning	0x19

STATUS_TEMP 0x1A

7	OT Fault	0x1A
6	OT Warning	0x1A
5	UT Fault	0x1A
4	UT Warning	0x1A
3	Reserved	0x1A
2	Reserved	0x1A
1	Reserved	0x1A
0	Reserved	0x1A

STATUS_WORD

15	VFW	0x1A
14	OCFW	0x1A
13	INPUT	0x1A
12	HFR fault/warn	0x1A
11	PGOOD_Z	0x1A
10	FANS	0x1A
9	OTHER	0x1A
8	Unknown	0x1A
7	Busy	0x1A
6	OFF	0x1A
5	OVF	0x1A
4	OCF	0x1A
3	Vout_MAX_Warning	0x1A
2	OTFW	0x1A
1	CML	0x1A
0	OTH	0x1A

STATUS_CML 0x1B

7	Invalid Command	0x1B
6	Invalid Data	0x1B
5	PEC Fault	0x1B
4	Memory Fault	0x1B
3	Processor Fault	0x1B
2	Reserved	0x1B
1	Other Comms Fault	0x1B
0	Other Memory/Logic Fault	0x1B

STATUS_INPUT 0x1C

7	Win OV Fault	0x1C
6	Win OV Warning	0x1C
5	Win UV Warning	0x1C
4	Win UV Fault	0x1C
3	Low_VIN	0x1C
2	IIN OC Fault	0x1C
1	IIN OC Warning	0x1C
0	PIN OP Warning	0x1C

STATUS_FANS_1_2

7	Fan 1 Fault	0x1C
6	Fan 2 Fault	0x1C
5	Fan 1 Warning	0x1C
4	Fan 2 Warning	0x1C
3	Fan 1 Speed Overridden	0x1C
2	Fan 2 Speed Overridden	0x1C
1	Air Flow Fault	0x1C
0	Air Flow Warning	0x1C

STATUS_FANS_3_4

7	Fan 3 Fault	0x1C
6	Fan 4 Fault	0x1C
5	Fan 3 Warning	0x1C
4	Fan 4 Warning	0x1C
3	Fan 3 Speed Overridden	0x1C
2	Fan 4 Speed Overridden	0x1C
1	Reserved	0x1C
0	Reserved	0x1C

STATUS_MFR_SPECIFIC 0x1D

7	Over temperature fault Band	0x1D
6	FSM Illegal ZERO state	0x1D
5	FSM Illegal MANY ONES state	0x1D
4	Invalid PPV1 detection	0x1D
3	Invalid PPV0 detection	0x1D
2	RESET VOUT	0x1D
1	Is_Slave	0x1D
0	SYNC_FAULT	0x1D

STATUS_OTHER

7	Reserved	0x1D
6	Reserved	0x1D
5	Input A fuse Or circuit breaker fault	0x1D
4	Input B fuse or circuit breaker fault	0x1D
3	Input A OR-ing device fault	0x1D
2	Input B OR-ing device fault	0x1D
1	Output OR-ing device fault	0x1D
0	Reserved	0x1D

Clear Faults Key: Fault Warning See other register Bit not set Bit not implemented

2 PMBus Log Messages [Show PMBus Log](#) Unique open/close settings for Configure, Monitor, and Status

Fusion Digital Power Designer v2.0.179 [2016-10-12] | TPS546C23 Firmware v1.0 @ PMBus Address 27d (1Bh) | USB Adapter v1.0.11 [PEC; 400 kHz] | TEXAS INSTRUMENTS | fusion digital power

SLUUBH5A – NOVEMBER 2016 – REVISED FEBRUARY 2022
[Submit Document Feedback](#)

TPS546C23 2-Phase SWIFT Step-Down Converter Evaluation Module User's Guide

43

Copyright © 2022 Texas Instruments Incorporated

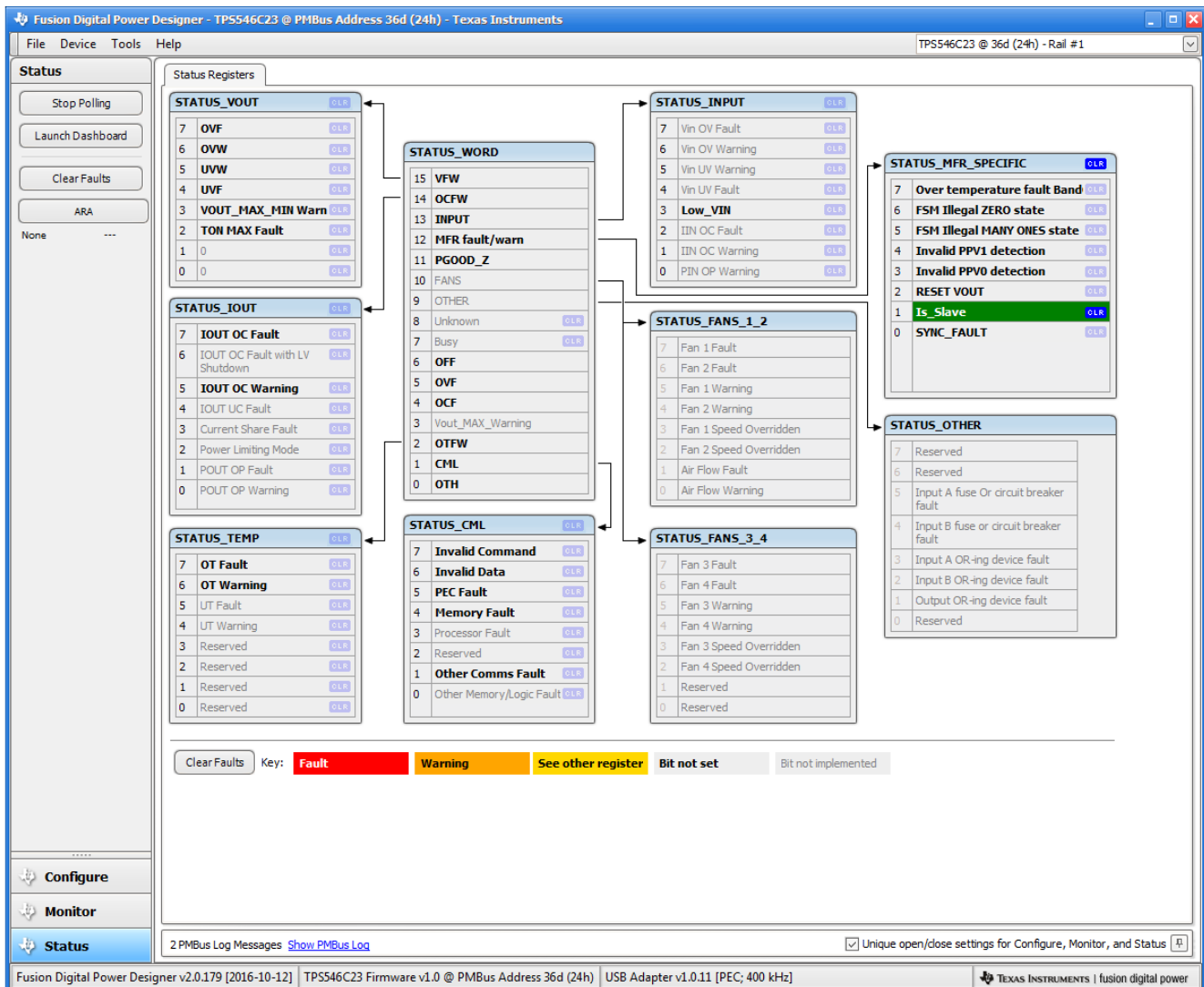

Figure 10-9. Status Screen

11 Revision History

NOTE: Page numbers for previous revisions may differ from page numbers in the current version.

Changes from Revision * (November 2016) to Revision A (February 2022)	Page
• Updated the numbering format for tables, figures, and cross-references throughout the document.	3
• Updated the updated user's guide title	3

IMPORTANT NOTICE AND DISCLAIMER

TI PROVIDES TECHNICAL AND RELIABILITY DATA (INCLUDING DATASHEETS), DESIGN RESOURCES (INCLUDING REFERENCE DESIGNS), APPLICATION OR OTHER DESIGN ADVICE, WEB TOOLS, SAFETY INFORMATION, AND OTHER RESOURCES "AS IS" AND WITH ALL FAULTS, AND DISCLAIMS ALL WARRANTIES, EXPRESS AND IMPLIED, INCLUDING WITHOUT LIMITATION ANY IMPLIED WARRANTIES OF MERCHANTABILITY, FITNESS FOR A PARTICULAR PURPOSE OR NON-INFRINGEMENT OF THIRD PARTY INTELLECTUAL PROPERTY RIGHTS.

These resources are intended for skilled developers designing with TI products. You are solely responsible for (1) selecting the appropriate TI products for your application, (2) designing, validating and testing your application, and (3) ensuring your application meets applicable standards, and any other safety, security, regulatory or other requirements.

These resources are subject to change without notice. TI grants you permission to use these resources only for development of an application that uses the TI products described in the resource. Other reproduction and display of these resources is prohibited. No license is granted to any other TI intellectual property right or to any third party intellectual property right. TI disclaims responsibility for, and you fully indemnify TI and its representatives against any claims, damages, costs, losses, and liabilities arising out of your use of these resources.

TI's products are provided subject to [TI's Terms of Sale](#), [TI's General Quality Guidelines](#), or other applicable terms available either on [ti.com](#) or provided in conjunction with such TI products. TI's provision of these resources does not expand or otherwise alter TI's applicable warranties or warranty disclaimers for TI products. Unless TI explicitly designates a product as custom or customer-specified, TI products are standard, catalog, general purpose devices.

TI objects to and rejects any additional or different terms you may propose.

Copyright © 2026, Texas Instruments Incorporated

Last updated 10/2025