

# TPS563207 Step-Down Converter Evaluation Module

## User's Guide



### ABSTRACT

This user's guide contains information for the TPS563207 as well as support documentation for the TPS563207EVM evaluation module. Included are the performance specifications, board layout, schematic, and the bill of materials of the TPS563207EVM.

### Table of Contents

<b>1 Introduction</b> .....	2
<b>2 Performance Specification Summary</b> .....	2
<b>3 Modifications</b> .....	2
3.1 Output Voltage Setpoint.....	2
<b>4 Test Setup and Results</b> .....	3
4.1 Input/Output Connections.....	3
4.2 Start-Up Procedure.....	4
4.3 Start-Up.....	5
4.4 Shut-Down.....	6
4.5 Output Voltage Ripple.....	7
4.6 Input Voltage Ripple.....	8
4.7 Load Transient Response.....	8
<b>5 Board Layout</b> .....	9
5.1 Layout.....	9
<b>6 Schematic, Bill of Materials, and Reference</b> .....	13
6.1 Schematic.....	13
6.2 Bill of Materials.....	14
6.3 Reference.....	14
<b>7 Revision History</b> .....	14

### List of Figures

Figure 4-1. TPS563207EVM Connectors and Jumpers Placement.....	4
Figure 4-2. Start-Up Relative to $V_{IN}$ , $I_{OUT} = 3\text{ A}$ .....	5
Figure 4-3. Start-Up Relative to EN, $I_{OUT} = 3\text{ A}$ .....	5
Figure 4-4. Shut-Down Relative to $V_{IN}$ , $I_{OUT} = 3\text{ A}$ .....	6
Figure 4-5. Shut-Down Relative to EN, $I_{OUT} = 3\text{ A}$ .....	6
Figure 4-6. Output Voltage Ripple, $I_{OUT} = 3\text{ A}$ .....	7
Figure 4-7. Output Voltage Ripple, $I_{OUT} = 10\text{ mA}$ .....	7
Figure 4-8. Input Voltage Ripple, $I_{OUT} = 3\text{ A}$ .....	8
Figure 4-9. Load Transient Response, 10% to 90% Load Step.....	8
Figure 5-1. TPS563207EVM Top Assembly.....	9
Figure 5-2. TPS563207EVM Top Layer.....	10
Figure 5-3. TPS563207EVM Bottom Layer.....	10
Figure 5-4. TPS563207EVM Board Top View.....	11
Figure 5-5. TPS563207EVM Board Bottom View.....	12
Figure 6-1. TPS563207EVM Schematic Diagram.....	13

### List of Tables

Table 1-1. Input Voltage and Output Current Summary.....	2
Table 2-1. Performance Specifications Summary.....	2
Table 3-1. Output Voltages.....	3

Table 4-1. Connection and Test Points.....	4
Table 6-1. Bill of Materials.....	14

## Trademarks

D-CAP2™ is a trademark of Texas Instruments.  
All trademarks are the property of their respective owners.

## 1 Introduction

The TPS563207 is a single, adaptive on-time, D-CAP2™ mode, synchronous buck converter requiring a very low external component count. The D-CAP2 control circuit is optimized for low-ESR output capacitors such as POSCAP, SP-CAP, or ceramic types and features fast transient response with no external compensation. The switching frequency is internally set at a nominal 580 kHz and operates in Forced Continuous Conduction Mode (FCCM). The high-side and low-side switching MOSFETs are incorporated inside the TPS563207 package along with the gate-drive circuitry. The low drain-to-source on-resistance of the MOSFETs allows the TPS563207 to achieve high efficiencies and helps keep the junction temperature low at high output currents. The TPS563207 dc/dc synchronous converter is designed to provide up to a 3-A output from an input voltage source of 4.3 V to 17 V. The output voltage range is from 0.806 V to 7 V. Rated input voltage and output current ranges for the evaluation module are given in [Section 2](#).

The TPS563207EVM evaluation module (EVM) is a single, synchronous buck converter providing 1.05 V at 3 A from 4.3-V to 17-V input. This user's guide describes the TPS563207EVM performance.

**Table 1-1. Input Voltage and Output Current Summary**

EVM	INPUT VOLTAGE RANGE	OUTPUT CURRENT RANGE
TPS563207EVM	$V_{IN} = 4.3 \text{ V to } 17 \text{ V}$	0 A to 3 A

## 2 Performance Specification Summary

A summary of the TPS563207EVM performance specifications is provided in [Table 2-1](#). Specifications are given for an input voltage of  $V_{IN} = 12 \text{ V}$  and an output voltage of 1.05 V, unless otherwise noted. The ambient temperature is 25°C for all measurement, unless otherwise noted.

**Table 2-1. Performance Specifications Summary**

SPECIFICATIONS	TEST CONDITIONS				UNIT
		MIN	TYP	MAX	
Input voltage range		4.3	12	17	V
Output voltage set point			1.05		V
Operating frequency	$V_{IN} = 12 \text{ V}, I_O = 3 \text{ A}$		580		kHz
Output current range		0		3	A
Over current limit	$V_{IN} = 12 \text{ V}, L_O = 1.2 \mu\text{H}$		4.4		A
Output ripple voltage	$V_{IN} = 12 \text{ V}, I_O = 3 \text{ A}$		20		mV <sub>PP</sub>

## 3 Modifications

These evaluation modules are designed to provide access to the features of the TPS563207. Some modifications can be made to this module.

### 3.1 Output Voltage Setpoint

To change the output voltage of the EVMs, it is necessary to change the value of resistor R4. Changing the value of R4 can change the output voltage. The value of R4 for a specific output voltage can be calculated using [Equation 1](#).

$$R_4 = \frac{R_6 \times (V_{out} - 0.806V)}{0.806V} \quad (1)$$

[Table 3-1](#) lists the R4 values for some common output voltages. Note that the values given in [Table 3-1](#) are standard values and not the exact value calculated using [Equation 1](#).

**Table 3-1. Output Voltages**

OUTPUT VOLTAGE (V)	R4 (kΩ)	R6 (kΩ)	TYP L1 (μH)	C5+C6+C7 (μF)			CFF (pF)
				MIN	TYP	MAX	
0.85	0.55	10.0	1.2	20	44	110	
0.9	1.2	10.0	1.2	20	44	110	
1.0	2.4	10.0	1.2	20	44	110	
1.05	3	10.0	1.2	20	44	110	
1.2	4.9	10.0	1.5	20	44	110	
1.5	8.6	10.0	1.5	20	44	110	
1.8	12.3	10.0	2.2	20	44	110	
2.5	21	10.0	2.2	20	44	110	10-220
3.3	31	10.0	3.3	20	44	110	10-220
5.0	52	10.0	4.7	20	44	110	10-220
6.5	70.5	10.0	4.7	20	44	110	10-220

## 4 Test Setup and Results

This section describes how to properly connect, set up, and use the TPS563207EVM. The section also includes test results typical for the evaluation modules: start-up, shut-down, output voltage ripple, input voltage ripple, and load transient response.

### 4.1 Input/Output Connections

The TPS563207EVM is provided with input/output connectors and test points as shown in [Table 4-1](#). [Figure 4-1](#) shows connectors and jumpers placement on TPS563207EVM board.

A power supply capable of supplying 3 A must be connected to J1 through a pair of 20-AWG wires. The load must be connected to J2 through a pair of 20-AWG wires. The maximum load current capability is 3 A. Wire lengths must be minimized to reduce losses in the wires. Test point TP2 provides a place to monitor the  $V_{IN}$  input voltages with TP6 providing a convenient ground reference. TP3 is used to monitor the output voltage with TP10 as the ground reference.

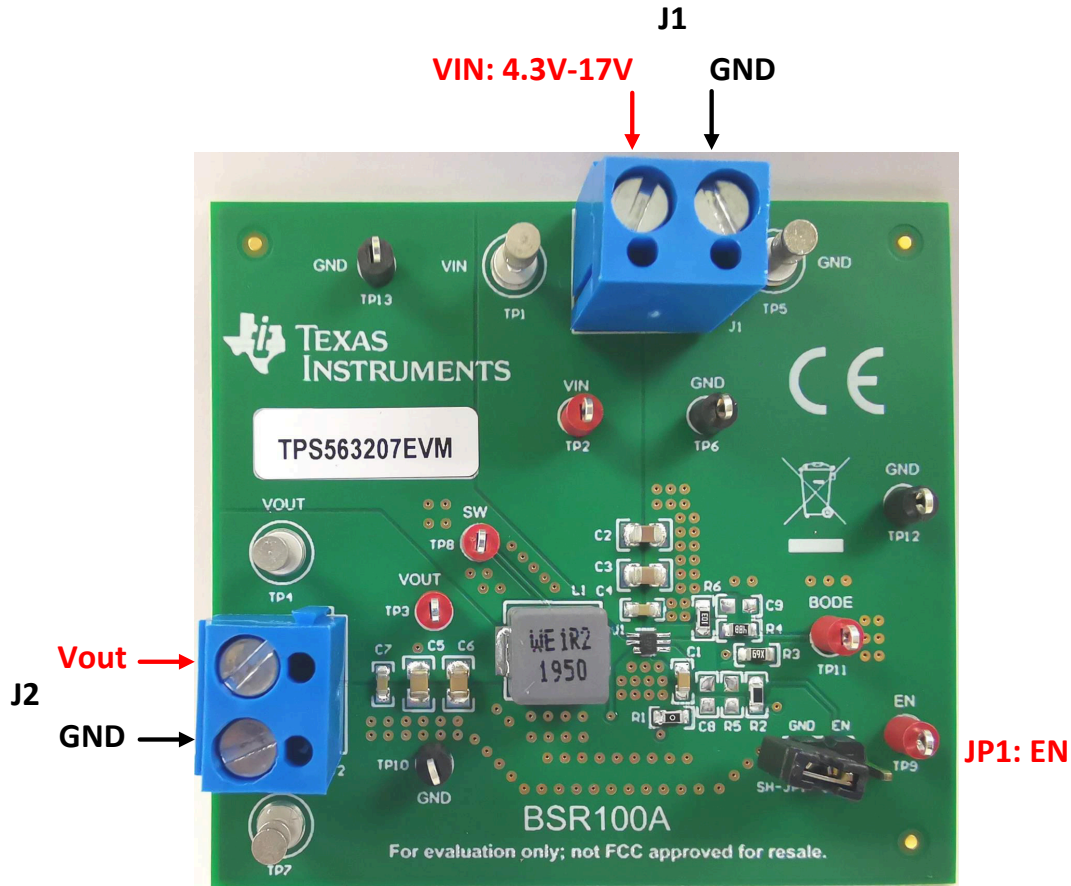

Figure 4-1. TPS563207EVM Connectors and Jumpers Placement

Table 4-1. Connection and Test Points

REFERENCE DESIGNATOR	FUNCTION
J1	$V_{IN}$ (see Table 1-1 for $V_{IN}$ range)
J2	$V_{OUT}$ , 1.05 V at 3-A maximum
JP1	EN control. Shunt EN to GND to disable
TP1	$V_{IN}$ positive power point
TP2	$V_{IN}$ positive monitor point
TP3	$V_{OUT}$ positive monitor point
TP4	$V_{OUT}$ positive power point
TP5, TP7	GND power point
TP6, TP10, TP12, TP13	GND monitor point
TP8	Switch node test point
TP9	EN test point
TP11	Test point for loop response measurements

## 4.2 Start-Up Procedure

1. Ensure that the jumper at JP1 (Enable control) pins 1 and 2 are covered to shunt EN to GND, disabling the output.
2. Apply appropriate  $V_{IN}$  voltage to VI (J1-2) and GND (J1-1).
3. Move the jumper at JP1 (Enable control) pins 1 and 2 (EN and GND) to enable the output.

### 4.3 Start-Up

The TPS563207EVM start-up waveform relative to  $V_{IN}$  is shown in Figure 4-2.

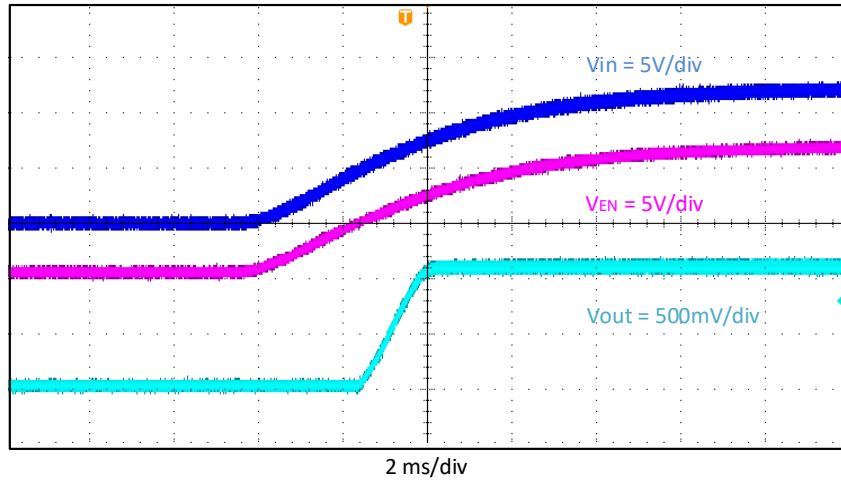

**Figure 4-2. Start-Up Relative to  $V_{IN}$ ,  $I_{OUT} = 3\text{ A}$**

The TPS563207EVM start-up waveform relative to enable (EN) is shown in Figure 4-3.

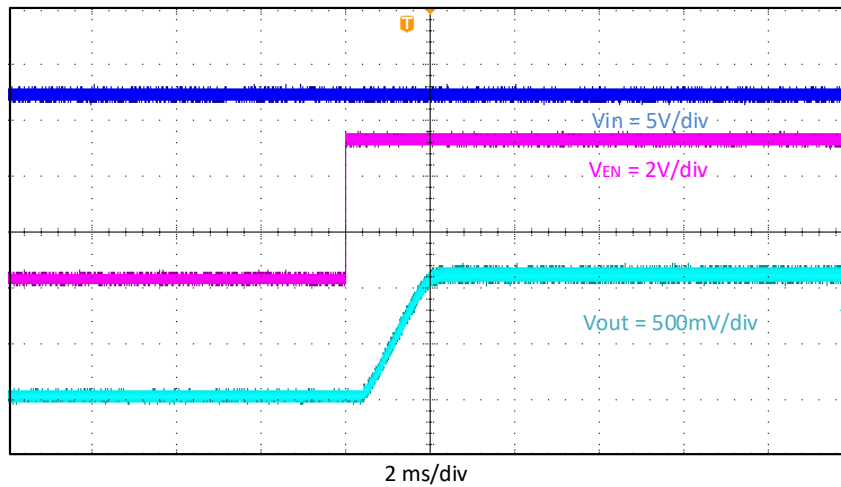

**Figure 4-3. Start-Up Relative to EN,  $I_{OUT} = 3\text{ A}$**

#### 4.4 Shut-Down

The TPS563207EVM shut-down waveform relative to  $V_{IN}$  is shown in Figure 4-4.

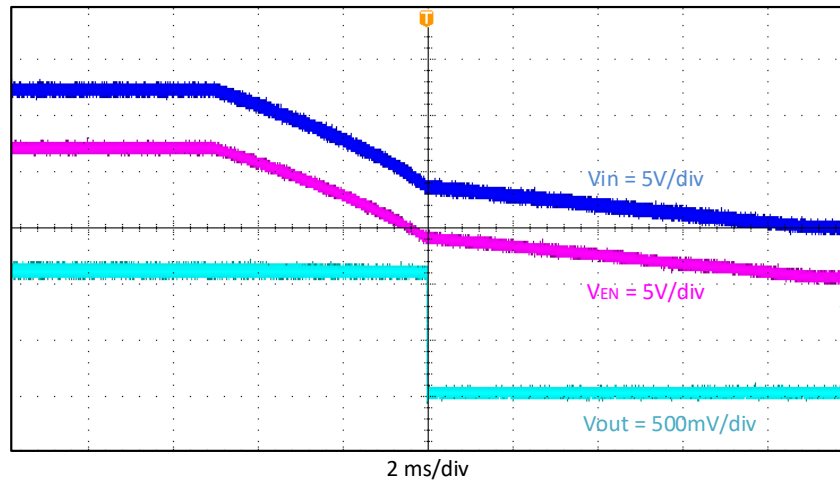

**Figure 4-4. Shut-Down Relative to  $V_{IN}$ ,  $I_{OUT} = 3\text{ A}$**

The TPS563207EVM shut-down waveform relative to EN is shown in Figure 4-5.

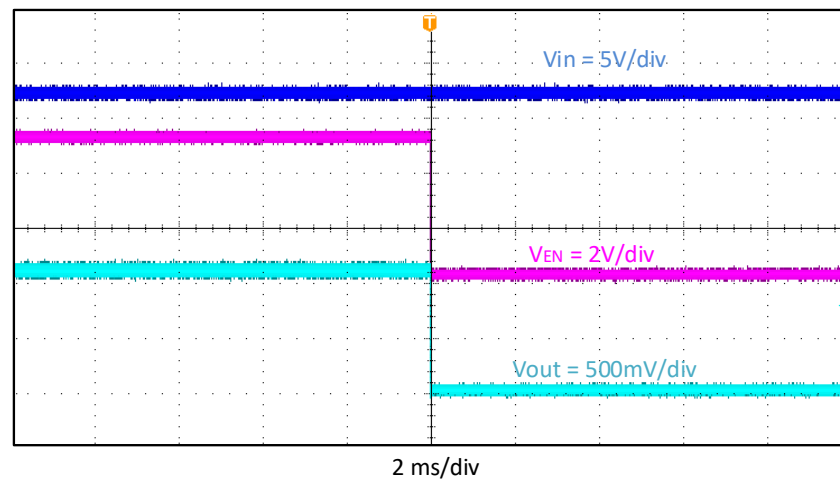

**Figure 4-5. Shut-Down Relative to EN,  $I_{OUT} = 3\text{ A}$**

## 4.5 Output Voltage Ripple

The TPS563207EVM output voltage ripple is shown in [Figure 4-6](#) and [Figure 4-7](#). The output currents are as indicated.

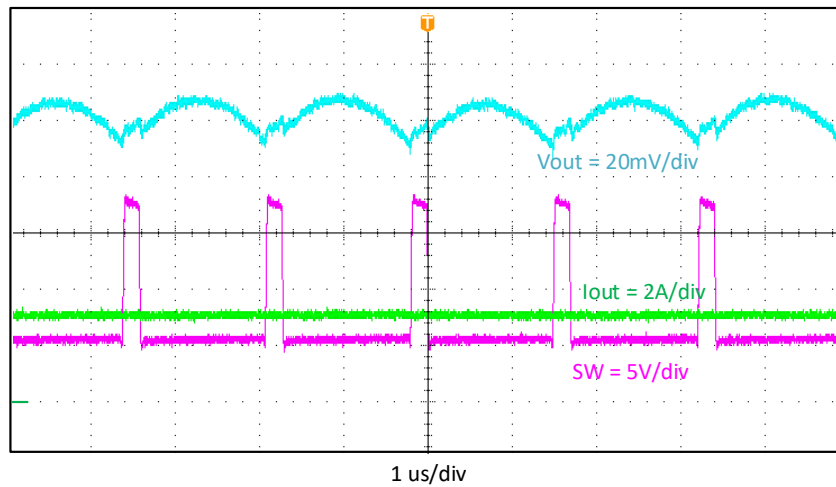

**Figure 4-6. Output Voltage Ripple,  $I_{OUT} = 3\text{ A}$**

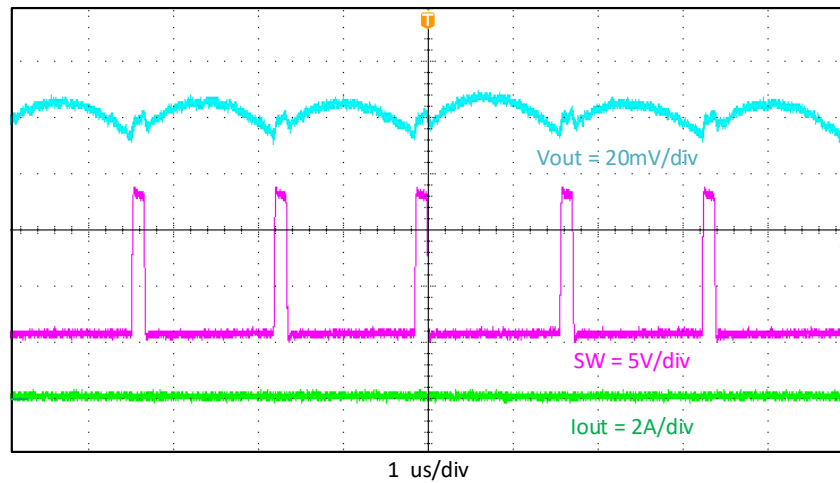

**Figure 4-7. Output Voltage Ripple,  $I_{OUT} = 10\text{ mA}$**

## 4.6 Input Voltage Ripple

The TPS563207EVM input voltage ripple is shown in Figure 4-8. The output current is as indicated.

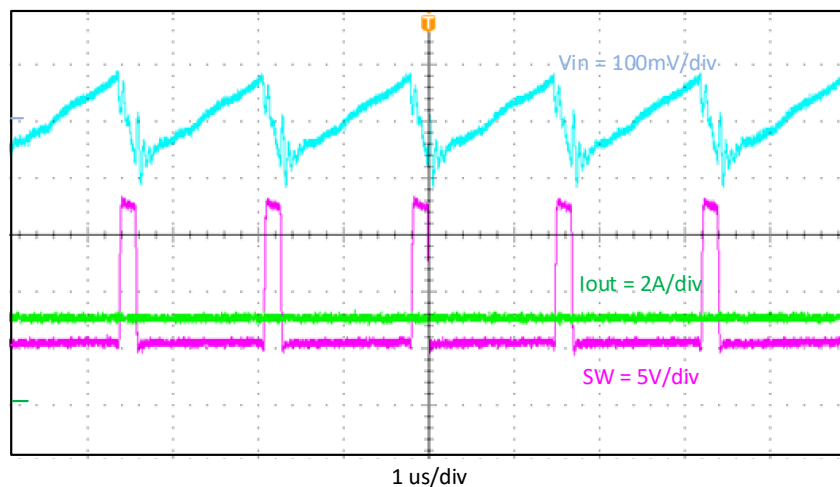

**Figure 4-8. Input Voltage Ripple,  $I_{OUT} = 3\text{ A}$**

## 4.7 Load Transient Response

The TPS563207EVM response to load transient is shown in Figure 4-9. The current steps are indicated in the figures. The loading step slew rate is 2.5 A/ $\mu\text{s}$ . Total peak-to-peak voltage variation is as shown.

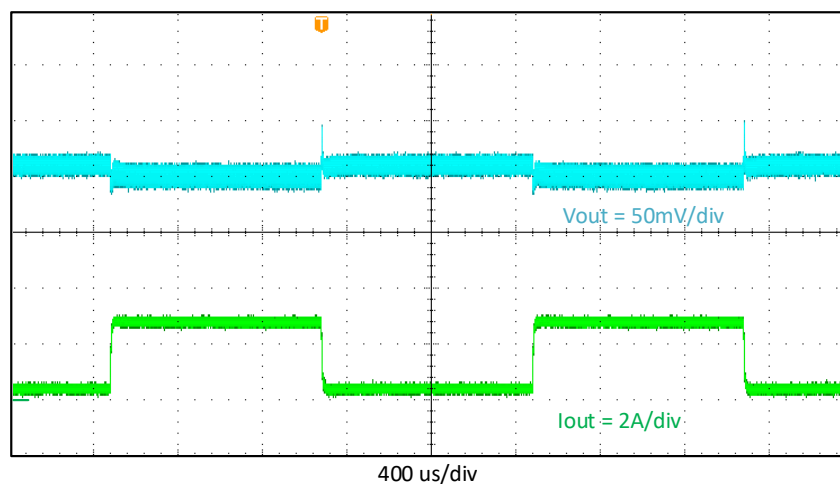

**Figure 4-9. Load Transient Response, 10% to 90% Load Step**



## 5 Board Layout

This section provides a description of the TPS563207EVM, board layout, and layer illustrations.

### 5.1 Layout

The board layout for the TPS563207EVM is shown in [Figure 5-1](#), [Figure 5-2](#), and [Figure 5-3](#). The top layer contains the main power traces for VIN, VOUT, and ground. The top layer also has the connections for the pins of the TPS563207 and a large area filled with ground. Most of the signal traces are also located on the top side. The input decoupling capacitors, C2, C3, and C4 are located as close to the IC as possible. The input and output connectors, test points, and all of the components are located on the top side. The bottom layer is a ground plane along with the switching node copper fill, signal ground copper fill and the feed back trace from the point of regulation to the top of the resistor divider network. Both the top layer and bottom layer use 2-oz. copper thickness.

[Figure 5-4](#) and [Figure 5-5](#) are the TPS563207EVM top view and bottom view, respectively.

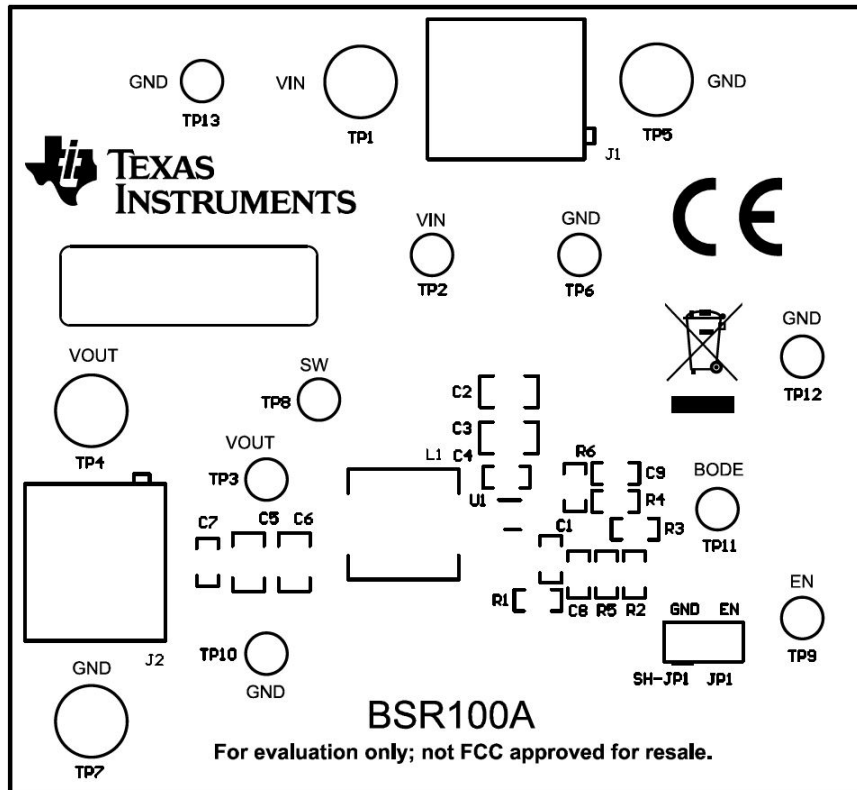

Figure 5-1. TPS563207EVM Top Assembly

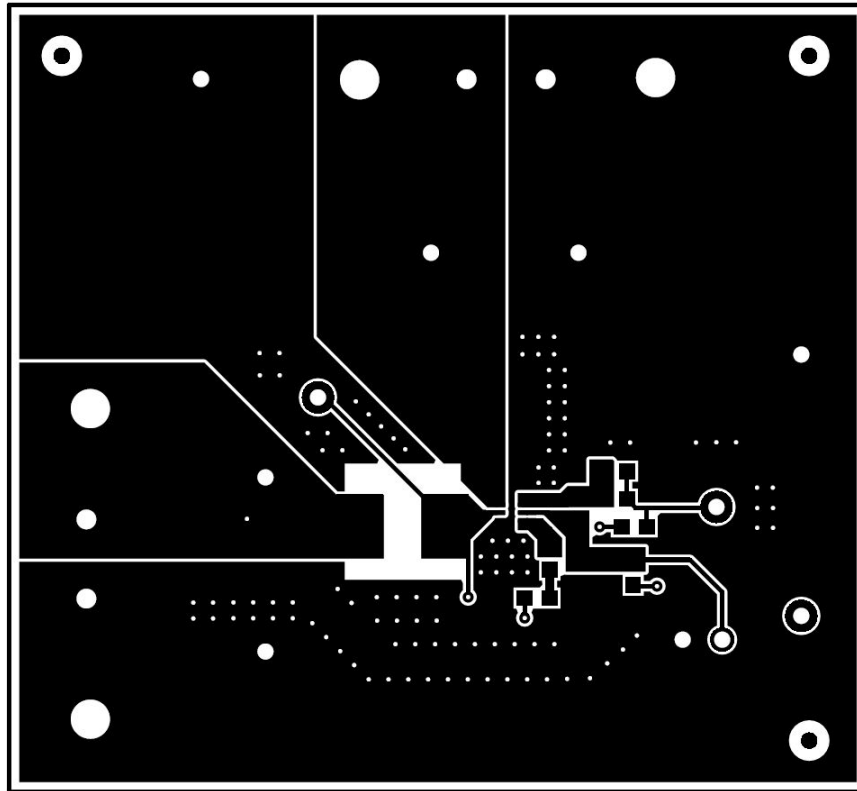

Figure 5-2. TPS563207EVM Top Layer

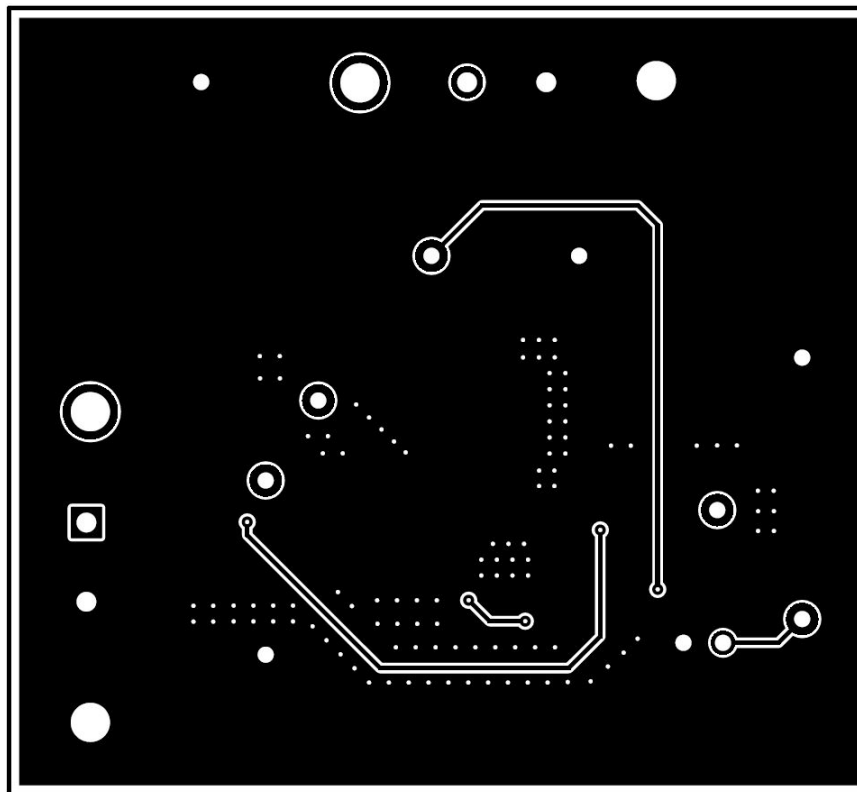
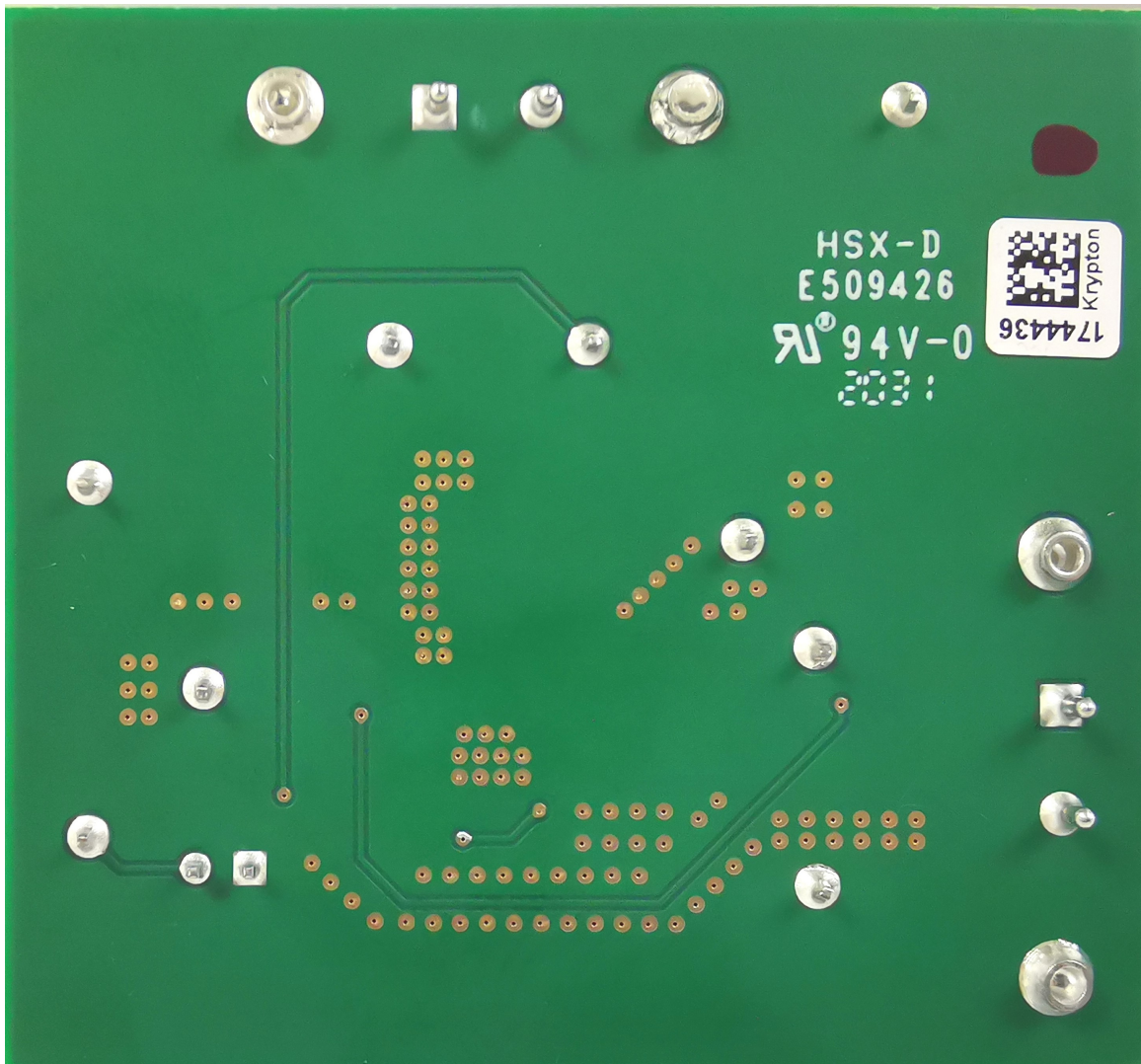

Figure 5-3. TPS563207EVM Bottom Layer



Figure 5-4. TPS563207EVM Board Top View

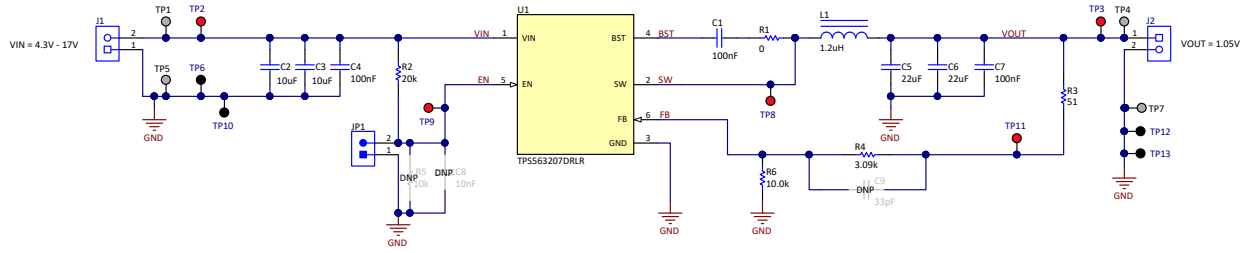

**Figure 5-5. TPS563207EVM Board Bottom View**

## 6 Schematic, Bill of Materials, and Reference

### 6.1 Schematic

Figure 6-1 is the schematic for the TPS563207EVM.



**Figure 6-1. TPS563207EVM Schematic Diagram**

## 6.2 Bill of Materials

**Table 6-1. Bill of Materials**

DES	QTY	DESCRIPTION	PART NUMBER	MANUFACTURER
!PCB1	1	Printed Circuit Board	BSR100	Any
C1, C4,C7	3	Capacitor, ceramic, 0.1 $\mu$ F, 25 V, $\pm$ 10%, X7R, 0603	C1608X7R1E104K080AA	TDK
C2, C3	2	Capacitor, ceramic, 10 $\mu$ F, 25 V, $\pm$ 20%, X5R, 0805	GRM21BR61E106MA73L	MuRata
C5, C6	2	Capacitor, ceramic, 22 $\mu$ F, 10 V, $\pm$ 20%, X5R, 0805	GRM21BR61A226ME44L	MuRata
J1, J2	2	Terminal block, 5.08 mm, 2x1, Brass, TH	ED120/2DS	On-Shore Technology
JP1	1	Header, 100 mil, 2 x 1, tin, TH	PEC02SAAN	Sullins Connector Solutions
L1	1	Inductor, Shielded Drum Core, Powdered Iron, 1.2 $\mu$ H, 9 A, 0.0072 $\Omega$ , SMD	74437349012	Würth Elektronik
LBL1	1	Thermal transfer printable labels, 0.650" W x 0.200" H - 10,000 per roll	THT-14-423-10	Brady
R1	1	Resistor, 0 $\Omega$ , 5%, 0.1 W, AEC-Q200 Grade 0, 0603	CRCW06030000Z0EA	Vishay-Dale
R2	1	Resistor, 20 k $\Omega$ , 5%, 0.1 W, AEC-Q200 Grade 0, 0603	CRCW060320K0JNEA	Vishay-Dale
R3	1	Resistor, 51 $\Omega$ , 5%, 0.1 W, AEC-Q200 Grade 0, 0603	CRCW060351R0JNEA	Vishay-Dale
R4	1	Resistor, 3.09 k $\Omega$ , 1%, 0.1 W, 0603	RC0603FR-073K09L	Yageo
R6	1	Resistor, 10.0 k $\Omega$ , 1%, 0.1 W, AEC-Q200 Grade 0, 0603	CRCW060310K0FKEA	Vishay-Dale
SH-JP1	1	Shunt, 100 mil, gold plated, black	SNT-100-BK-G	Samtec
TP1, TP4, TP5, TP7	4	Terminal, turret, TH, double	1502-2	Keystone
TP2, TP3, TP8, TP9, TP11	5	Test point, miniature, red, TH	5000	Keystone
TP6, TP10, TP12, TP13	4	Test Point, miniature, black, TH	5001	Keystone
U1	1	4.3-V to 17-V Input, 3-A Synchronous Buck Converter, DRL0006A (SOT-5X3-6)	TPS563207DRLR	Texas Instruments
C8	0	Capacitor, ceramic, 0.01 $\mu$ F, 50 V, $\pm$ 10%, X7R, 0603	C1608X7R1H103K080AA	TDK
C9	0	Capacitor, ceramic, 33 pF, 100 V, $\pm$ 5%, C0G/NP0, 0603	GRM1885C2A330JA01D	MuRata
R5	0	Resister, 10 k $\Omega$ 5%, 0.1 W, AEC-Q200 Grade 0, 0603	CRCW060310K0JNEA	Vishay-Dale

## 6.3 Reference

1. *TPS563207 4.3 V to 17 V Input, 3-A Synchronous Step-Down Voltage Regulator in SOT563 Data Sheet*([SLUSE25](#))

## 7 Revision History

NOTE: Page numbers for previous revisions may differ from page numbers in the current version.

### Changes from Revision \* (August 2020) to Revision A (April 2021)

**Page**

- Updated user's guide title..... **2**

## IMPORTANT NOTICE AND DISCLAIMER

TI PROVIDES TECHNICAL AND RELIABILITY DATA (INCLUDING DATA SHEETS), DESIGN RESOURCES (INCLUDING REFERENCE DESIGNS), APPLICATION OR OTHER DESIGN ADVICE, WEB TOOLS, SAFETY INFORMATION, AND OTHER RESOURCES "AS IS" AND WITH ALL FAULTS, AND DISCLAIMS ALL WARRANTIES, EXPRESS AND IMPLIED, INCLUDING WITHOUT LIMITATION ANY IMPLIED WARRANTIES OF MERCHANTABILITY, FITNESS FOR A PARTICULAR PURPOSE OR NON-INFRINGEMENT OF THIRD PARTY INTELLECTUAL PROPERTY RIGHTS.

These resources are intended for skilled developers designing with TI products. You are solely responsible for (1) selecting the appropriate TI products for your application, (2) designing, validating and testing your application, and (3) ensuring your application meets applicable standards, and any other safety, security, regulatory or other requirements.

These resources are subject to change without notice. TI grants you permission to use these resources only for development of an application that uses the TI products described in the resource. Other reproduction and display of these resources is prohibited. No license is granted to any other TI intellectual property right or to any third party intellectual property right. TI disclaims responsibility for, and you will fully indemnify TI and its representatives against, any claims, damages, costs, losses, and liabilities arising out of your use of these resources.

TI's products are provided subject to [TI's Terms of Sale](#) or other applicable terms available either on [ti.com](http://ti.com) or provided in conjunction with such TI products. TI's provision of these resources does not expand or otherwise alter TI's applicable warranties or warranty disclaimers for TI products.

TI objects to and rejects any additional or different terms you may have proposed.

Mailing Address: Texas Instruments, Post Office Box 655303, Dallas, Texas 75265  
Copyright © 2022, Texas Instruments Incorporated