

# TPS543820EVM SWIFT™ Step-Down Converter Evaluation Module User's Guide



## ABSTRACT

This user's guide contains information for the TPS543820EVM evaluation module (BSR101) and the TPS543820 dc/dc converter. Also included are the performance characteristics, schematic, and bill of materials for the TPS543820EVM.

## Table of Contents

|  |    |
|--|----|
| <b>1 Introduction</b>  | 3  |
| 1.1 Background   | 3  |
| 1.2 Before You Begin   | 3  |
| 1.3 Performance Characteristics Summary                                  | 4  |
| <b>2 Configurations and Modifications</b>                                | 6  |
| 2.1 Output Voltage   | 6  |
| 2.2 Switching Frequency (FSEL Pin)                                       | 7  |
| 2.3 Current Limit, Soft-Start Time, and Internal Compensation (MODE Pin) | 7  |
| 2.4 Adjustable UVLO  | 7  |
| <b>3 Test Setup and Results</b>  | 8  |
| 3.1 Input/Output Connections   | 8  |
| 3.2 Efficiency   | 11 |
| 3.3 Output Voltage Regulation  | 13 |
| 3.4 Load Transient and Loop Response                                     | 14 |
| 3.5 Output Voltage Ripple  | 16 |
| 3.6 Input Voltage Ripple   | 17 |
| 3.7 Synchronizing to a Clock   | 18 |
| 3.8 Start-up and Shutdown with EN  | 19 |
| 3.9 Start-up and Shutdown with VIN                                       | 20 |
| 3.10 Start-up Into Pre-Bias  | 21 |
| 3.11 Hiccup Current Limit  | 22 |
| 3.12 Overvoltage Protection  | 24 |
| 3.13 Thermal Performance   | 25 |
| <b>4 Board Layout</b>  | 26 |
| 4.1 Layout   | 26 |
| <b>5 Schematic and Bill of Materials</b>                                 | 27 |
| 5.1 Schematic  | 28 |
| 5.2 Bill of Materials  | 30 |
| <b>6 Revision History</b>  | 32 |

## List of Figures

|   |    |
|---|----|
| Figure 3-6. U1 Load Regulation                          | 13 |
| Figure 3-7. U1 Line Regulation                          | 13 |
| Figure 3-8. U2 Load Regulation                          | 13 |
| Figure 3-9. U2 Line Regulation                          | 13 |
| Figure 3-10. U1 Transient Response                      | 14 |
| Figure 3-11. U2 Transient Response                      | 14 |
| Figure 3-12. U1 Bode Plot                               | 14 |
| Figure 3-13. U2 Bode Plot                               | 14 |
| Figure 3-14. U2 Loop Gain with Different Ramp Settings  | 15 |
| Figure 3-15. U2 Loop Phase with Different Ramp Settings | 15 |
| Figure 3-16. U1 Output Ripple – No Load                 | 16 |

|   |    |
|---|----|
| Figure 3-17. U1 Output Ripple – 6-A Load.....                                 | 16 |
| Figure 3-18. U2 Output Ripple – No Load.....                                  | 16 |
| Figure 3-19. U2 Output Ripple – 6-A Load.....                                 | 16 |
| Figure 3-20. U1 Input Ripple – No Load.....                                   | 17 |
| Figure 3-21. U1 Input Ripple – 6-A Load.....                                  | 17 |
| Figure 3-22. U2 Input Ripple – No Load.....                                   | 17 |
| Figure 3-23. U2 Input Ripple – 6-A Load.....                                  | 17 |
| Figure 3-24. U1 and U2 Synchronized to a Clock.....                           | 18 |
| Figure 3-25. U2 Clock Synchronization Transitions.....                        | 18 |
| Figure 3-26. U2 Start-up with EN – No Load.....                               | 19 |
| Figure 3-27. U2 Shutdown with EN – No Load.....                               | 19 |
| Figure 3-28. U2 Start-up with EN – 0.2-Ω Load.....                            | 19 |
| Figure 3-29. U2 Startup with EN – No Load and Measuring BP5.....              | 19 |
| Figure 3-30. U2 Start-up with VIN – 0.3-Ω Load.....                           | 20 |
| Figure 3-31. U2 Shutdown with VIN – 0.3-Ω Load.....                           | 20 |
| Figure 3-32. U2 Start-up Into 0.5-V Pre-Bias.....                             | 21 |
| Figure 3-33. U2 Output Overcurrent Protection – Overload with High Limit..... | 22 |
| Figure 3-34. U2 Output Overcurrent Protection – Overload with Low Limit.....  | 22 |
| Figure 3-35. U2 Output Overcurrent Protection – Short with High Limit.....    | 22 |
| Figure 3-36. U2 Output Overcurrent Protection – Short with Low Limit.....     | 22 |
| Figure 3-37. U2 OCP Hiccup and Recover – High Limit.....                      | 23 |
| Figure 3-38. U2 Overvoltage Protection.....                                   | 24 |
| Figure 3-39. U2 OVP and Recover.....  | 24 |
| Figure 3-40. U1 Thermal Performance – 8-A Load and U2 off.....                | 25 |
| Figure 3-41. U2 Thermal Performance – 8-A Load and U1 off.....                | 25 |
| Figure 3-42. U1 Thermal Performance – Both 8-A Load.....                      | 25 |
| Figure 3-43. U2 Thermal Performance – Both 8-A Load.....                      | 25 |
| Figure 4-1. Top-Side Composite View.....                                      | 26 |
| Figure 4-2. Bottom-Side Composite View (Viewed From Bottom).....              | 26 |
| Figure 4-3. Top Layer Layout.....   | 27 |
| Figure 4-4. Mid Layer 1 Layout.....   | 27 |
| Figure 4-5. Mid Layer 2 Layout.....   | 27 |
| Figure 4-6. Bottom Layer Layout.....  | 27 |
| Figure 5-1. U1 Schematic.....   | 28 |
| Figure 5-2. U2 Schematic.....   | 29 |

## List of Tables

|   |    |
|---|----|
| Table 1-1. Input Voltage and Output Current Summary.....                              | 3  |
| Table 1-2. TPS543820EVM Small Size (U1) Performance Characteristics Summary.....      | 4  |
| Table 1-3. TPS543820EVM High Efficiency (U2) Performance Characteristics Summary..... | 5  |
| Table 2-1. VOUT Selection.....  | 6  |
| Table 2-2. FSEL Selection.....  | 7  |
| Table 2-3. MODE Selection.....  | 7  |
| Table 3-1. Connectors and Jumpers.....  | 9  |
| Table 3-2. Test Points.....   | 10 |
| Table 3-3. Efficiency Measurement Test Points.....                                    | 11 |
| Table 5-1. TPS543820EVM Bill of Materials.....  | 30 |

## Trademarks

All trademarks are the property of their respective owners.

## 1 Introduction

### 1.1 Background

The TPS543820 dc/dc converter is a synchronous buck converter designed to provide up to a 8-A output. The input (VIN) is rated for 4 V to 18 V. Rated input voltage and output current range for the evaluation module are given in [Table 1-1](#).

The high-side and low-side MOSFETs are incorporated inside the TPS543820 package along with the gate-drive circuitry. The low drain-to-source on-resistance of the MOSFET allows the TPS543820 to achieve high efficiencies and helps keep the junction temperature low at the rated output current. Fixed frequency advanced current mode control allows you to synchronize the regulators to an external clock source. An external divider allows for an adjustable output voltage. The TPS543820 FSEL and MODE pins provide selectable switching frequency, soft start time, current limit, and internal compensation. Lastly, the TPS543820 includes an enable pin and a power good output which can be used for sequencing multiple regulators.

This evaluation module includes two designs with the TPS543820. The first design is designed to demonstrate the small printed-circuit-board areas that may be achieved when designing with the TPS543820 regulator. The small area design fits within 100 mm<sup>2</sup>. The second design is designed to demonstrate the high efficiency that can be achieved when designing with the TPS543820 regulator. The second design also includes jumpers that can be used to easily evaluate the features of the TPS543820.

**Table 1-1. Input Voltage and Output Current Summary**

| EVM          | INPUT VOLTAGE RANGE           | OUTPUT CURRENT RANGE |
|--------------|-------------------------------|----------------------|
| TPS543820EVM | V <sub>IN</sub> = 4 V to 18 V | 0 A to 8 A           |

### 1.2 Before You Begin

The following warnings and cautions are noted for the safety of anyone using or working close to the TPS543820EVM. Observe all safety precautions.



**Warning**

The TPS543820EVM may become hot during operation due to dissipation of power in some operating conditions. Avoid contact with the board. Follow all applicable safety procedures applicable to your laboratory.

**WARNING**

The circuit module has signal traces, components, and component leads on the bottom of the board. This may result in exposed voltages, hot surfaces or sharp edges. Do not reach under the board during operation.

**CAUTION**

Some power supplies can be damaged by application of external voltages. If using more than 1 power supply, check your equipment requirements and use blocking diodes or other isolation techniques, as needed, to prevent damage to your equipment.

### 1.3 Performance Characteristics Summary

A summary of the TPS543820EVM performance characteristics is provided in [Table 1-2](#) and [Table 1-3](#). The TPS543820EVM is designed and tested for  $V_{IN} = 4\text{ V}$  to  $18\text{ V}$ . Characteristics are given for an input voltage of  $V_{IN} = 12\text{ V}$  and an output voltage of  $1.0\text{ V}$ , unless otherwise specified. The ambient temperature is room temperature ( $20^{\circ}\text{C}$  to  $25^{\circ}\text{C}$ ) for all measurements, unless otherwise noted.

**Table 1-2. TPS543820EVM Small Size (U1) Performance Characteristics Summary**

| SPECIFICATION                    | TEST CONDITIONS   | MIN                                 | TYP             | MAX                 | UNIT               |
|----------------------------------|---|-------------------------------------|-----------------|---------------------|--------------------|
| $V_{IN}$ voltage range           |   | 4                                   | 12              | 13.2 <sup>(1)</sup> | V                  |
| Input current                    | $V_{IN} = 12\text{ V}$ , $I_O = 0\text{ A}$                                   |                                     | 14              |                     | mA                 |
|                                  | $V_{IN} = 5\text{ V}$ , $I_O = 8\text{ A}$                                    |                                     | 1.90            |                     | A                  |
| $V_{IN}$ start voltage           | Set by internal UVLO  |                                     | 3.95            |                     | V                  |
| $V_{IN}$ stop voltage            | Set by internal UVLO  |                                     | 3.8             |                     | V                  |
| Output voltage setpoint          |   |                                     | 1.005           |                     | V                  |
| Output current range             | $V_{IN} = 4\text{ V}$ to $13.2\text{ V}$                                      | 0                                   |                 | 8                   | A                  |
| Line and load regulation         | $V_{IN} = 4\text{ V}$ to $13.2\text{ V}$ , $I_O = 0\text{ A}$ to $8\text{ A}$ |                                     | +0.1%,<br>-0.3% |                     |                    |
| Load transient response          | $I_O = 1.5\text{ A}$ to $4.5\text{ A}$  | Voltage change                      | -25             |                     | mV                 |
|                                  |   | Recovery time to within $\pm 0.5\%$ | 70              |                     | $\mu\text{s}$      |
|                                  | $I_O = 4.5\text{ A}$ to $1.5\text{ A}$  | Voltage change                      | 25              |                     | mV                 |
|                                  |   | Recovery time to within $\pm 0.5\%$ | 70              |                     | $\mu\text{s}$      |
| Loop bandwidth                   | $R_O = 0.2\ \Omega$   |                                     | 201             |                     | kHz                |
| Phase margin                     |   |                                     | 50              |                     | degrees            |
| Input ripple voltage             | $I_O = 6\text{ A}$  |                                     | 70              |                     | mVPP               |
| Output ripple voltage            | $I_O = 6\text{ A}$  |                                     | 9               |                     | mVPP               |
| Output rise time                 | Set by MODE pin resistor  |                                     | 1               |                     | ms                 |
| Current limit                    | Set by MODE pin resistor  |                                     | High            |                     |                    |
| Switching frequency ( $f_{SW}$ ) | Set by FSEL pin resistor  |                                     | 1500            |                     | kHz                |
| Peak efficiency                  | $V_{IN} = 5\text{ V}$ , $I_O = 2.5\text{ A}$                                  |                                     | 91.2%           |                     |                    |
|                                  | $V_{IN} = 12\text{ V}$ , $I_O = 3.5\text{ A}$                                 |                                     | 87.0%           |                     |                    |
| IC case temperature              | $V_{IN} = 12\text{ V}$ , $I_O = 8\text{ A}$ , 15-minute soak                  |                                     | 58.8            |                     | $^{\circ}\text{C}$ |

(1) Max  $V_{IN}$  limited by minimum on-time and no BOOT resistor

**Table 1-3. TPS543820EVM High Efficiency (U2) Performance Characteristics Summary**

| SPECIFICATION                    | TEST CONDITIONS   | MIN                                 | TYP         | MAX | UNIT               |
|----------------------------------|---|-------------------------------------|-------------|-----|--------------------|
| $V_{IN}$ voltage range           |   | 4                                   | 12          | 18  | V                  |
| Input current                    | $V_{IN} = 12\text{ V}$ , $I_O = 0\text{ A}$                                 |                                     | 11          |     | mA                 |
|                                  | $V_{IN} = 5\text{ V}$ , $I_O = 8\text{ A}$                                  |                                     | 1.90        |     | A                  |
| $V_{IN}$ start voltage           | Set by EN pin resistor divider  |                                     | 4.53        |     | V                  |
| $V_{IN}$ stop voltage            | Set by EN pin resistor divider  |                                     | 3.98        |     | V                  |
| Output voltage setpoint          | J14 short pins 1 and 2  |                                     | 1.003       |     | V                  |
| Output current range             | $V_{IN} = 4\text{ V}$ to $18\text{ V}$                                      | 0                                   |             | 8   | A                  |
| Line and load regulation         | $V_{IN} = 4\text{ V}$ to $18\text{ V}$ , $I_O = 0\text{ A}$ to $8\text{ A}$ |                                     | $\pm 0.1\%$ |     |                    |
| Load transient response          | $I_O = 1.5\text{ A}$ to $4.5\text{ A}$                                      | Voltage change                      |             | -28 | mV                 |
|                                  |   | Recovery time to within $\pm 0.5\%$ |             | 60  | $\mu\text{s}$      |
|                                  | $I_O = 4.5\text{ A}$ to $1.5\text{ A}$                                      | Voltage change                      |             | 25  | mV                 |
|                                  |   | Recovery time to within $\pm 0.5\%$ |             | 60  | $\mu\text{s}$      |
| Loop bandwidth                   | $R_O = 0.2\ \Omega$ , J18 short pins 3 and 4                                |                                     | 140         |     | kHz                |
| Phase margin                     |   |                                     | 56          |     | degrees            |
| Input ripple voltage             | $I_O = 6\text{ A}$  |                                     | 90          |     | mVPP               |
| Output ripple voltage            | $I_O = 6\text{ A}$  |                                     | 6           |     | mVPP               |
| Output rise time                 | Set by MODE pin resistor, All default J18 options                           |                                     | 1           |     | ms                 |
| Current limit                    | Set by MODE pin resistor, J18 short pins 1 and 2, 3 and 4, or 5 and 6       |                                     | High        |     |                    |
| Switching frequency ( $f_{SW}$ ) | Set by FSEL pin resistor, J17 short pins 3 and 4                            |                                     | 1000        |     | kHz                |
| Peak efficiency                  | $V_{IN} = 5\text{ V}$ , $I_O = 2\text{ A}$                                  |                                     | 92.4%       |     |                    |
|                                  | $V_{IN} = 12\text{ V}$ , $I_O = 3\text{ A}$                                 |                                     | 89.3%       |     |                    |
| IC case temperature              | $V_{IN} = 12\text{ V}$ , $I_O = 8\text{ A}$ , 15-minute soak                |                                     | 53.6        |     | $^{\circ}\text{C}$ |

## 2 Configurations and Modifications

These evaluation modules are designed to provide access to the features of the TPS543820. The U2 design provides jumpers for testing different configurations. Jumper selections must be made prior to enabling the TPS543820.

If a desired configuration is not available, some modifications can be made to this module. When modifications are made to the components on the EVM, the internal compensation option selected with the MODE pin resistor can need to be changed. Changes to the  $f_{SW}$ , output voltage, output inductor, and output capacitors can require a change in the compensation. TPS543820 data sheet equations or WEBENCH can be used to calculate the output capacitor value, compensation,  $f_{SW}$ , and inductance. Ensure all components have sufficient voltage and current ratings.

### 2.1 Output Voltage

In the U1 design, the output voltage is set by the resistor divider network of R7 ( $R_{FBT}$ ) and R8 ( $R_{FBB}$ ). R8 is fixed at 1.00 k $\Omega$  to set the FB divider current at approximately 500  $\mu$ A. To change the output voltage of the EVM, the value of resistor R7 must change. Changing the value of R7 can change the output voltage above the 0.5-V reference voltage ( $V_{REF}$ ). The value of R7 for a specific output voltage can be calculated using Equation 1. After changing R7, the feedforward capacitor (C8) can also need to be changed.

$$R_{FBT} = R_{FBB} \times \left( \frac{V_{OUT}}{V_{REF}} - 1 \right) \quad (1)$$

In the U2 design, there are a few ways to set the output voltage. First, jumper J14 can be used to select between the options shown in Table 2-1. If the desired output voltage is not available, a resistor must be changed. For output voltages less than 0.8 V, TI recommends leaving J14 open and increasing R21. R21 becomes  $R_{FBB}$  and the required value for can be calculated with Equation 2, where  $R_{FBT}$  is R15. For output voltages greater than 0.8 V, the jumper output voltage options can be changed by changing one of the resistors R23-R26. The  $R_{FBJ}$  resistor value to get a desired equivalent  $R_{FBB}$  resistance can be calculated with Equation 3. To use J14 for output voltages 3.3 V or larger, R20 should be reduced to 499  $\Omega$ .

$$R_{FBB} = R_{FBT} \times \frac{V_{REF}}{V_{OUT} - V_{REF}} \quad (2)$$

$$R_{FBJ} = \frac{R_{FBB} \times (R20 + R21) - R20 \times R21}{R21 - R_{FBB}} \quad (3)$$

**Table 2-1. VOUT Selection**

| JUMPER SETTING                    | EQUIVALENT BOTTOM FB RESISTOR ( $R_{FBB}$ ) | NOMINAL OUTPUT VOLTAGE |
|-----------------------------------|---|------------------------|
| Open                              | R21 = 8.25 k $\Omega$                       | 0.803 V                |
| 1 to 2 pin shorted <sup>(1)</sup> | (R23+R20)  R21 = 4.97 k $\Omega$            | 1.003 V                |
| 3 to 4 pin shorted                | (R24+R20)  R21 = 3.55 k $\Omega$            | 1.204 V                |
| 5 to 6 pin shorted                | (R25+R20)  R21 = 2.48 k $\Omega$            | 1.507 V                |
| 7 to 8 pin shorted                | (R26+R20)  R21 = 1.92 k $\Omega$            | 1.803 V                |

(1) Default Setting

## 2.2 Switching Frequency (FSEL Pin)

In the U2 design, jumper J17 can be used to select between the switching frequency options shown in [Table 2-2](#). If the desired option is not available, change one of the resistors to the value which sets the desired option.

In the U1 design, change the FSEL resistor to the value which sets the desired option.

**Table 2-2. FSEL Selection**

| JUMPER SETTING                    | FSEL RESISTOR | SWITCHING FREQUENCY |
|-----------------------------------|---------------|---------------------|
| 1 to 2 pin shorted                | 17.4 kΩ       | 750 kHz             |
| 3 to 4 pin shorted <sup>(1)</sup> | 11.8 kΩ       | 1000 kHz            |
| 5 to 6 pin shorted                | 8.06 kΩ       | 1500 kHz            |
| 7 to 8 pin shorted                | 4.99 kΩ       | 2200 kHz            |

(1) Default Setting

## 2.3 Current Limit, Soft-Start Time, and Internal Compensation (MODE Pin)

In the U2 design, jumper J18 can be used to select between the current limit, soft-start time, and internal compensation options shown in [Table 2-3](#). If the desired option is not available, change one of the resistors to the value which sets the desired option.

In the U1 design, change the MODE resistor to the value which sets the desired option.

**Table 2-3. MODE Selection**

| JUMPER SETTING                    | MODE RESISTOR | CURRENT LIMIT | SOFT-START TIME | RAMP |
|-----------------------------------|---------------|---------------|-----------------|------|
| 1 to 2 pin shorted                | 2.21 kΩ       | High          | 1 ms            | 1 pF |
| 3 to 4 pin shorted <sup>(1)</sup> | 4.87 kΩ       | High          | 1 ms            | 2 pF |
| 5 to 6 pin shorted                | 11.3 kΩ       | High          | 1 ms            | 4 pF |
| 7 to 8 pin shorted                | 60.4 kΩ       | Low           | 1 ms            | 2 pF |

(1) Default Setting

## 2.4 Adjustable UVLO

The undervoltage lockout (UVLO) for U2 can be adjusted externally using R14 ( $R_{ENT}$ ) and R17 ( $R_{ENB}$ ). See the [TPS543820 data sheet](#) for detailed instructions for setting the external UVLO.

In the U1 design, the EN pin is floating, so only the internal UVLO of the device is used.

### 3 Test Setup and Results

This section describes how to properly connect, set up, and use the TPS543820EVM evaluation module. The section also includes test results typical for the evaluation module and covers efficiency, output voltage regulation, load transients, loop response, output ripple, input ripple, start-up, and current limit modes. Measurements are taken with the following conditions unless otherwise noted.

- 12-V input
- Room temperature (20°C to 25°C)
- U2 with the default setting output voltage of 1 V, switching frequency of 1000 kHz, and maximum current limit setting
- With the other converter disabled

#### 3.1 Input/Output Connections

The TPS543820EVM is provided with input connectors, output connectors, and test points as shown in [Table 3-1](#) and [Table 3-2](#).

To support the minimum input voltage with the full rated load on both outputs with the default EVM, a power supply capable of supplying greater than 6 A must be connected to J8 through a pair of 20-AWG wires or better. Banana jacks J5 and J9 provide an alternative connection to input power supply.

For U1, the load must be connected to J2 and for U2, the load must be connected to J7. A pair of 20-AWG wires or better must be used for each connection. With the maximum current limit setting, the maximum load current capability is near 11 A before the TPS543820 goes into current limit. Wire lengths must be minimized to reduce losses in the wires.

Test point TP11 provides a place to monitor the  $V_{IN}$  input voltage with TP19 providing a convenient ground reference. TP2 is used to monitor the output voltage of U1 with TP5 as the ground reference. TP15 is used to monitor the output voltage of U2 with TP17 as the ground reference.

If modifications are made to the TPS543820EVM, the input current may change. The input power supply and wires connecting the EVM to the power supply must be rated for the input current.

---

#### Note

For the FSEL pin of the TPS543820 to detect and set the correct switching frequency, the pin must either detect the resistor to ground or an external clock must be applied to the pin before enabling the regulator. If starting up without an external clock, to properly detect the FSEL resistor value connected to ground, the buffers on the EVM need to be in high impedance mode. The shunts on J15 and J16 must be removed to put the buffers in high impedance mode for startup without an external clock.

---



**Table 3-1. Connectors and Jumpers**

| REFERENCE DESIGNATOR | NAME        | RELATED IC | FUNCTION   |
|----------------------|-------------|------------|--|
| J2                   | VOUT        | U1         | VOUT screw terminal to connect load to output  |
| J4                   | EN_OFF      | U1         | 2-pin header for enable. Add shunt to connect EN to ground and disable device.   |
| J5, J9               | VIN         | Both       | Banana jack for positive terminal and negative terminal of input power supply  |
| J7                   | VOUT        | U2         | VOUT screw terminal to connect load to output  |
| J8                   | VIN         | Both       | VIN screw terminal to connect input voltage (see <a href="#">Table 1-1</a> for $V_{IN}$ range)   |
| J11                  | RDIV_VIN    | U2         | 2-pin header for enable divider. Remove shunt to disconnect EN pin divider for U2 from VIN. If J11 shunt is removed and J13 shunt is populated, U2 EN pin is pulled to ground through bottom resistor in divider disabling U2. |
| J13                  | EN_RDIV     | U2         | 2-pin header to connect enable divider to U2. Remove shunt to float EN pin of U2 to use internal UVLO to enable U2.  |
| J14                  | VOUT Select | U2         | VOUT selection header. Use shunt to set output voltage. See <a href="#">Table 2-1</a> .  |
| J15                  | ENSYNC_U1   | U1         | 2-pin header to connect U1 buffer output enable to ground. Populate shunt to enable output of buffer. Remove shunt to make buffer output high impedance.   |
| J16                  | ENSYNC_U2   | U2         | 2-pin header to connect U2 buffer output enable to ground. Populate shunt to enable output of buffer. Remove shunt to make buffer output high impedance.   |
| J17                  | FSEL Select | U2         | FSEL selection header. Use shunt to select FSEL resistor. See <a href="#">Table 2-2</a> .  |
| J18                  | MODE Select | U2         | MODE selection header. Use shunt to select MODE resistor. See <a href="#">Table 2-3</a> .  |

**Table 3-2. Test Points**

| REFERENCE DESIGNATOR | NAME        | RELATED IC | FUNCTION  |
|----------------------|-------------|------------|---|
| TP1                  | VIN_U1      | U1         | VIN test point. Use this for efficiency measurements.   |
| TP2                  | VOUT_U1     | U1         | VOUT test point. Use this for efficiency, output regulation, and bode plot measurements.  |
| TP3                  | SW_U1       | U1         | SW node solder mask opening   |
| TP4                  | PGND_U1     | U1         | PGND test point   |
| TP5                  | PGND_EFF_U1 | U1         | PGND test point. Use this for efficiency measurements.  |
| TP6                  | PGOOD_U1    | U1         | PGOOD test point  |
| TP7                  | EN_U1       | U1         | EN test point. If applying an external voltage, it must be kept below the absolute maximum voltage of the EN pin of 6 V.  |
| TP8                  | AGND_U1     | U1         | AGND test point   |
| TP9                  | BODE_U1     | U1         | Test point between voltage divider network and output voltage. Used for Bode plot measurements.   |
| TP10                 | VOUT_U1     | U1         | SMB connector to measure output voltage. When using this test point, the scope should be set for 1-M $\Omega$ termination. When using 50- $\Omega$ termination, a 2:1 divider is created.   |
| TP11                 | VIN         | Both       | VIN test point near input terminals   |
| TP12                 | VIN_U2      | U2         | VIN test point. Use this for efficiency measurements.   |
| TP13                 | SW_U2       | U2         | SW node solder mask opening   |
| TP14                 | SW_U2       | U2         | SW node test point  |
| TP15                 | VOUT_U2     | U2         | VOUT test point. Use this for efficiency, output regulation, and bode plot measurements.  |
| TP16                 | PGND_U2     | U2         | PGND test point   |
| TP17                 | PGND_EFF_U2 | U2         | PGND test point. Use this for efficiency measurements.  |
| TP18                 | PGOOD_U2    | U2         | PGOOD test point  |
| TP19                 | PGND        | Both       | PGND test point near input terminals  |
| TP20                 | AGND_U2     | U2         | AGND test point   |
| TP21                 | BP5_U2      | U2         | BP5 test point  |
| TP22                 | BODE_U2     | U2         | Test point between voltage divider network and output voltage. Used for Bode plot measurements.   |
| TP23                 | EN_U2       | U2         | EN test point. If you are applying an external voltage, it must be kept below the absolute maximum voltage of the EN pin of 6 V.  |
| TP24                 | VO_ADJ      | U2         | Test point for injecting current into the FB divider to adjust the DC output voltage or inject a step to FB to test OVP   |
| TP25                 | VO_2NDSTG   | U2         | Test point to measure output voltage after second stage filter if added to EVM.   |
| TP26                 | SYNC        | Both       | SYNC test point. Supply an external clock to this test point to synchronize both regulators to it.  |
| TP27                 | FSEL        | U2         | FSEL test point   |
| TP28                 | SW_U2       | U2         | SMB connector to measure SW node. When using this test point, the scope should be set for 50- $\Omega$ termination. The combination of 50- $\Omega$ termination and 450- $\Omega$ series resistance creates a 10:1 attenuation.     |
| TP29                 | VOUT_U2     | U2         | SMB connector to measure output voltage. When using this test point, the scope should be set for 1-M $\Omega$ termination. When using 50- $\Omega$ termination, a 2:1 divider is created.   |
| TP30                 | VO_2NDSTG   | U2         | SMB connector to measure output voltage after second stage filter if added to EVM. When using this test point, the scope should be set for 1-M $\Omega$ termination. When using 50- $\Omega$ termination, a 2:1 divider is created. |
| TP31                 | FGEN        | Both       | Test point to connect function generator to load transient circuit. Slowly increase amplitude and vary slew rate of function generator for desired load step.   |
| TP32                 | ISNS        | Both       | Test point to measure current in load transient circuit. Gain is 20 A/V.  |
| TP33                 | PGND        | Both       | PGND test point for load transient circuit  |
| TP34                 | MODE        | U2         | MODE test point   |

### 3.2 Efficiency

Figure 3-1 through Figure 3-5 show the efficiency for both designs on the TPS543820EVM. Using the selection jumpers for U2, the results for different output voltage and switching frequency combinations are included. The test points listed in Table 3-3 are used for the efficiency measurement. Use these test points to minimize the contribution of PCB parasitic power loss to the measured power loss.

The following are some additional test setup considerations to minimize external sources of power dissipation.

- Disable the other regulator to avoid including the switching quiescent current of the other regulator in the efficiency measurement.
- Do not measure the SW pin of U2 with TP28 while measuring the efficiency of U2. Measuring the SW pin with this test point loads this node with 500  $\Omega$  and the efficiency measurement will include the power lost in this external resistance.
- Remove the shunts from J11 and J13 as a small amount of power is dissipated in the EN resistor divider connected to U2.

**Table 3-3. Efficiency Measurement Test Points**

| RELATED IC | TEST POINT NAME | REFERENCE DESIGNATOR | FUNCTION  |
|------------|-----------------|----------------------|---|
| U1         | VIN_U1          | TP1                  | Input voltage test point connected near pins of U1                                    |
|            | VOUT_U1         | TP2                  | Output voltage test point near output inductor of U1                                  |
|            | PGND_EFF_U1     | TP5                  | PGND reference test point for both input and output voltages Kelvin connected near U1 |
| U2         | VIN_U2          | TP12                 | Input voltage test point connected near pins of U2                                    |
|            | VOUT_U2         | TP15                 | Output voltage test point near output inductor of U2                                  |
|            | PGND_EFF_U2     | TP17                 | PGND reference test point for both input and output voltages Kelvin connected near U2 |

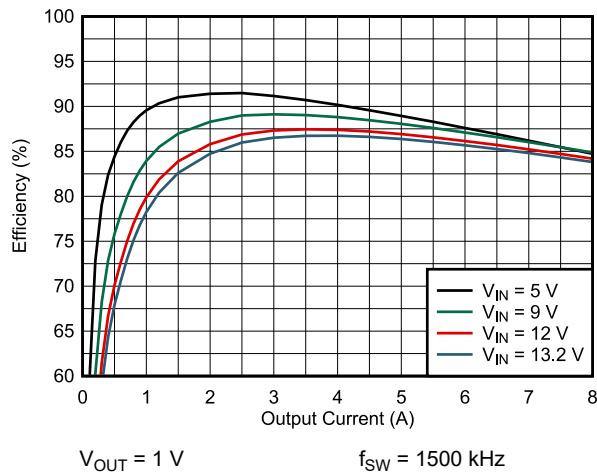

Figure 3-1. U1 Efficiency

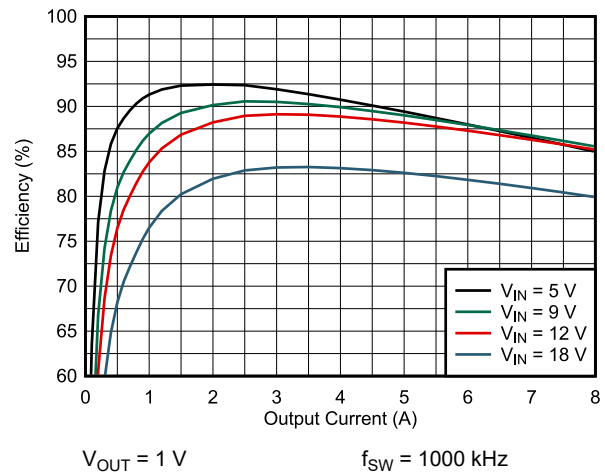

Figure 3-2. U2 Efficiency – Default Configuration

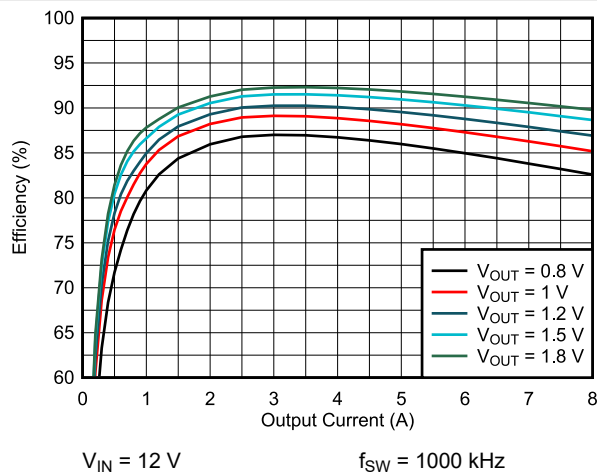

Figure 3-3. U2 Efficiency – 1000-kHz Switching Frequency with Different Output Voltages

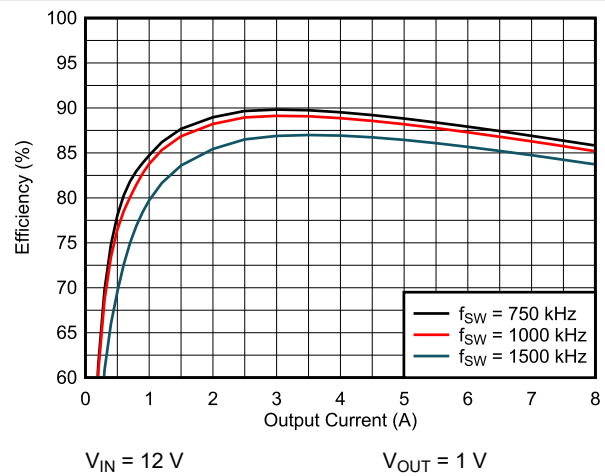

Figure 3-4. U2 Efficiency – 1-V Output with Different Switching Frequencies

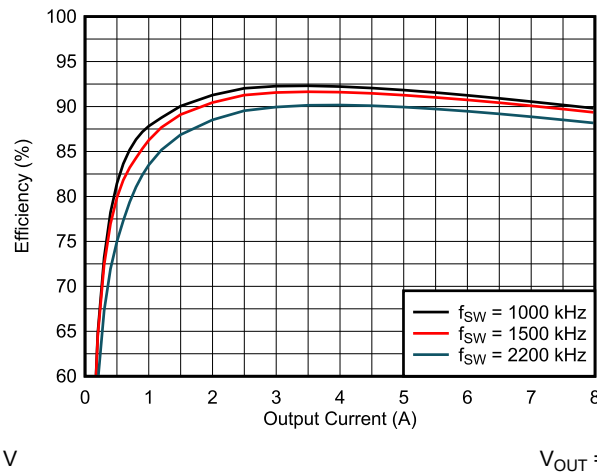
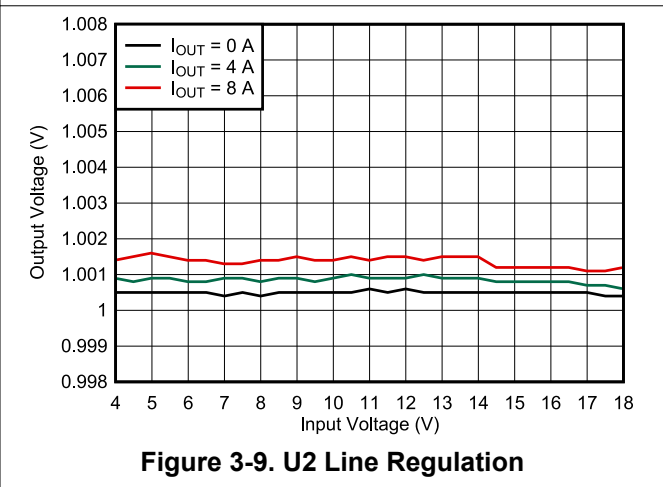
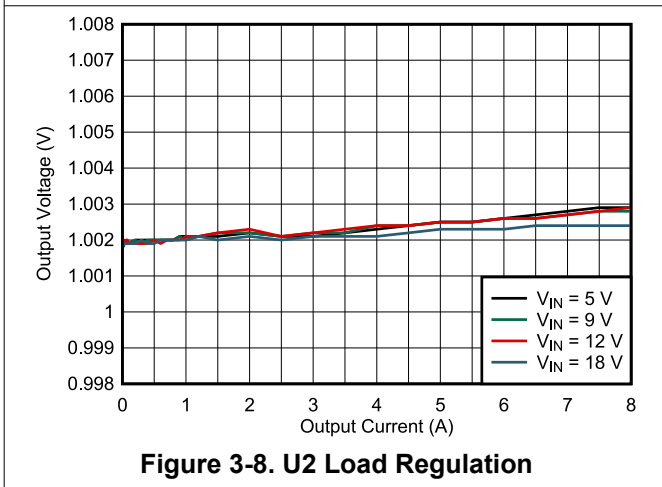
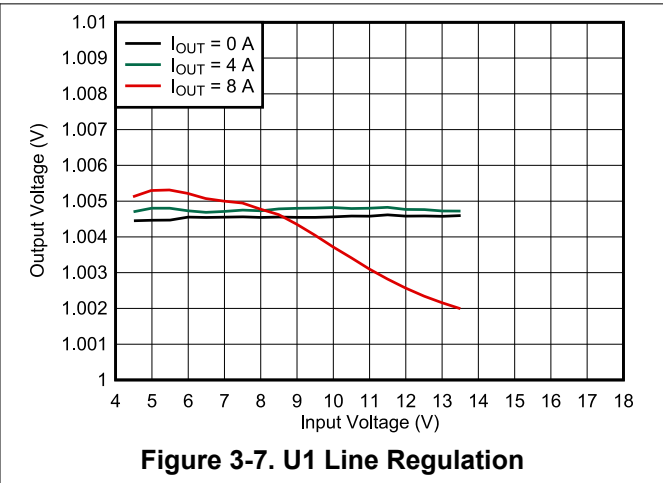
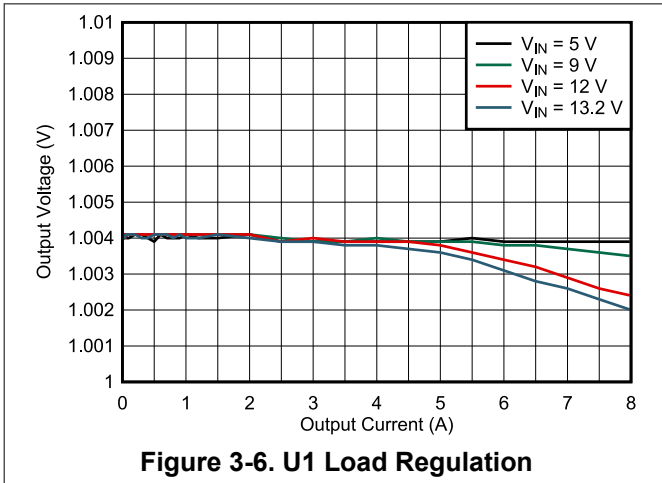

Figure 3-5. U2 Efficiency – 1.8-V Output with Different Switching Frequencies

### 3.3 Output Voltage Regulation

Figure 3-6 and Figure 3-7 show the load and line regulation for U1. Figure 3-8 and Figure 3-9 show the load and line regulation for U2.



### 3.4 Load Transient and Loop Response

Figure 3-10 and Figure 3-11 show the response to load transients for both designs. The current step is from 1.5 A to 4.5 A and the current step slew rate is 1 A/ $\mu$ s. An electronic load is used to provide a DC 1.5-A load and the load transient circuit on the EVM is used to provide a 3-A step. The VOUT voltage is measured using TP10 for U1 and TP29 for U2.

When using the load transient circuit included on the TPS543820EVM, slowly increase amplitude of function generator for desired load step amplitude then vary the rise and fall times for the desired slew rate. The current for the load step can be sensed with the ISNS test point. The default resistors on the EVM provide a gain of 20 A/V. With this gain, a 3-A step will result in 150-mV at the ISNS test point.

#### Note

To use the load transient circuit with U1, move R27 to R28.

Figure 3-12 and Figure 3-13 show the loop characteristics for both designs. Gain and phase plots are shown for V<sub>IN</sub> voltage of 12 V and a 0.2- $\Omega$  resistive load.

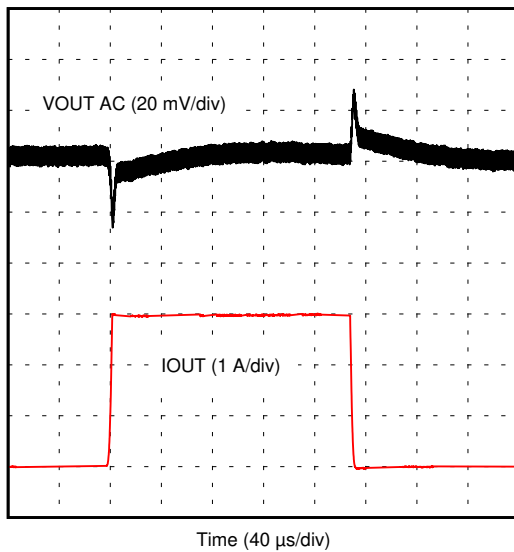

Figure 3-10. U1 Transient Response

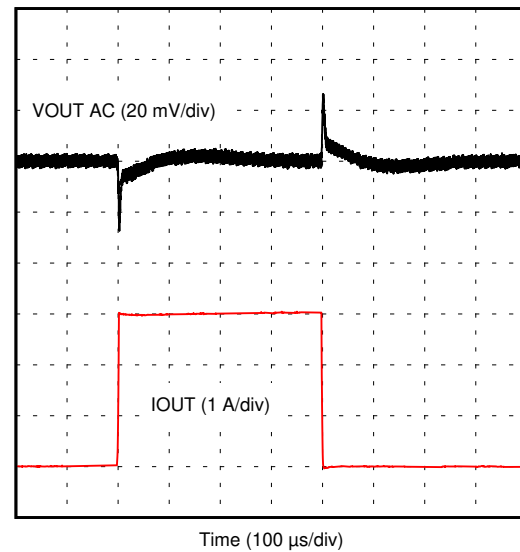

Figure 3-11. U2 Transient Response

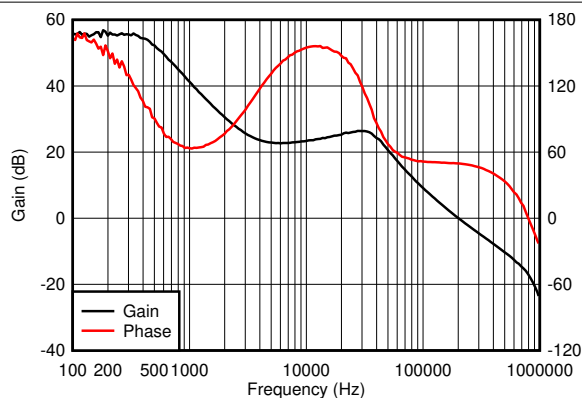

Figure 3-12. U1 Bode Plot

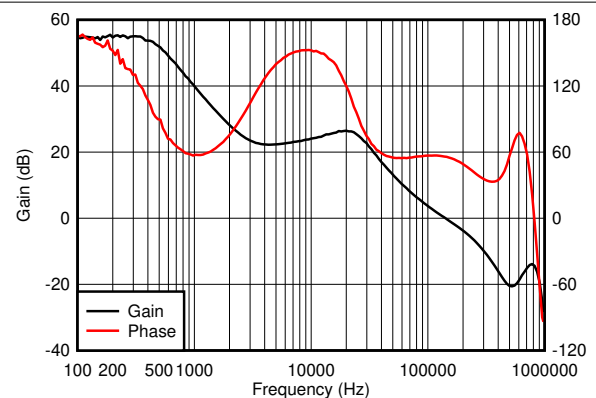
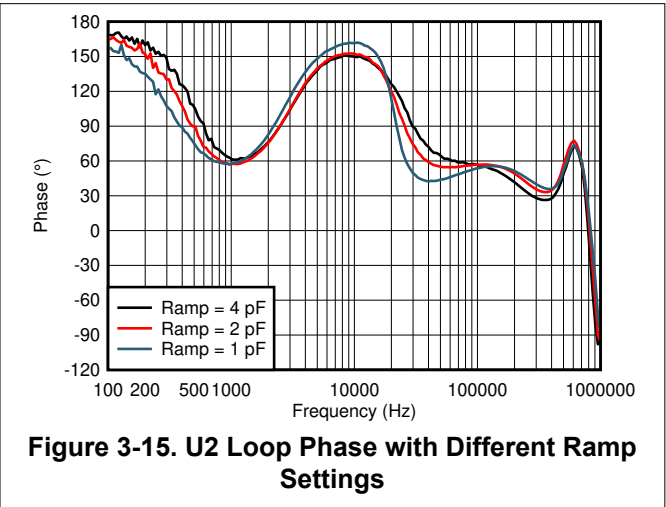
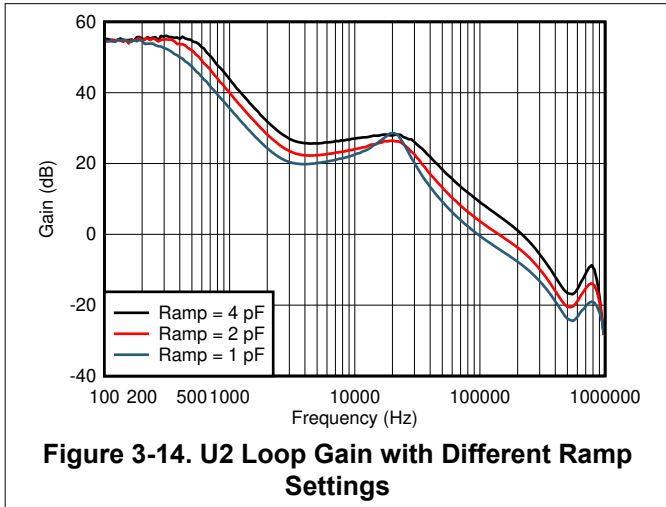

Figure 3-13. U2 Bode Plot

Figure 3-14 and Figure 3-15 shows the loop characteristics for U2 with the 3 different ramp settings.



### 3.5 Output Voltage Ripple

Figure 3-16 through Figure 3-19 show the TPS543820EVM output voltage ripple. The load currents are no load and 6 A.  $V_{IN} = 12$  V. The VOUT voltage is measured using TP10 for U1 and TP29 for U2.

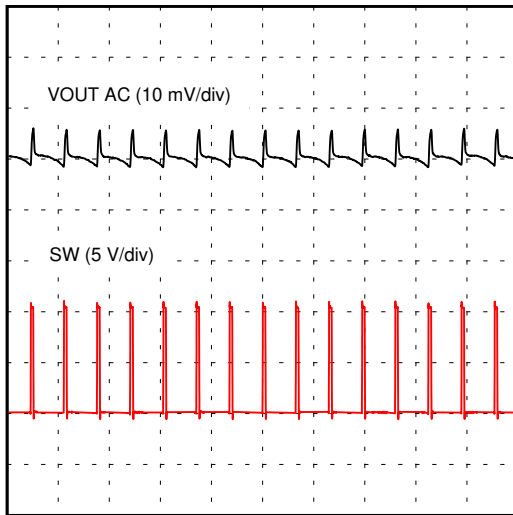
 Time (1  $\mu$ s/div)

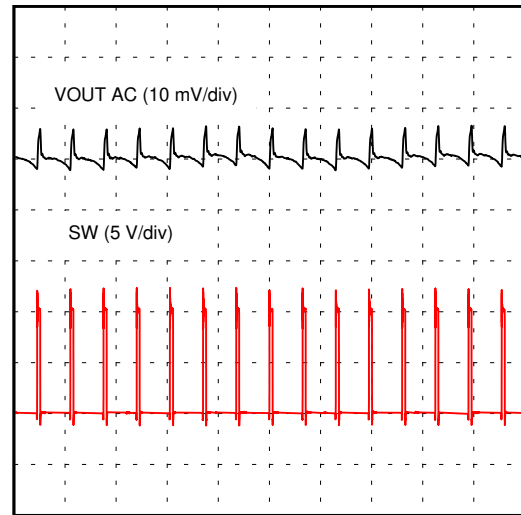
**Figure 3-16. U1 Output Ripple – No Load**

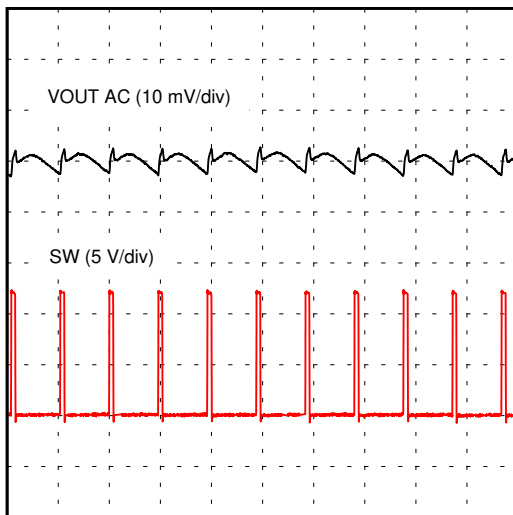
 Time (1  $\mu$ s/div)

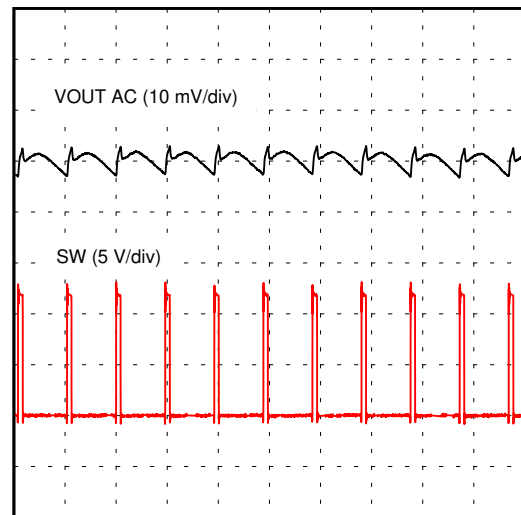
**Figure 3-17. U1 Output Ripple – 6-A Load**

 Time (1  $\mu$ s/div)

**Figure 3-18. U2 Output Ripple – No Load**

 Time (1  $\mu$ s/div)

**Figure 3-19. U2 Output Ripple – 6-A Load**

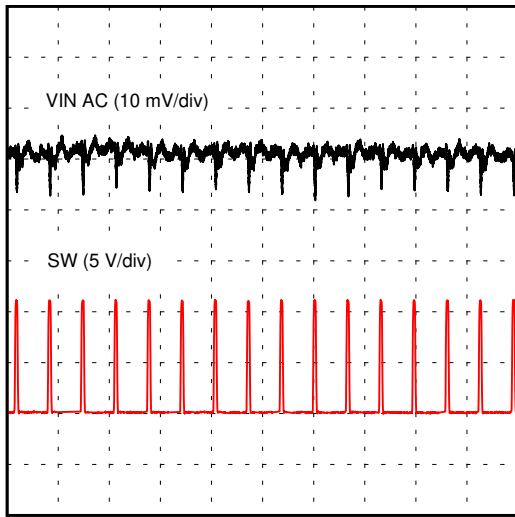

### 3.6 Input Voltage Ripple

Figure 3-20 through Figure 3-23 show the TPS543820EVM input voltage ripple. The load currents are no load and 6 A.  $V_{IN} = 12$  V. The ripple voltage is measured across C1 for U1 and measured across C13 for U2.



Time (1  $\mu$ s/div)  
**Figure 3-20. U1 Input Ripple – No Load**

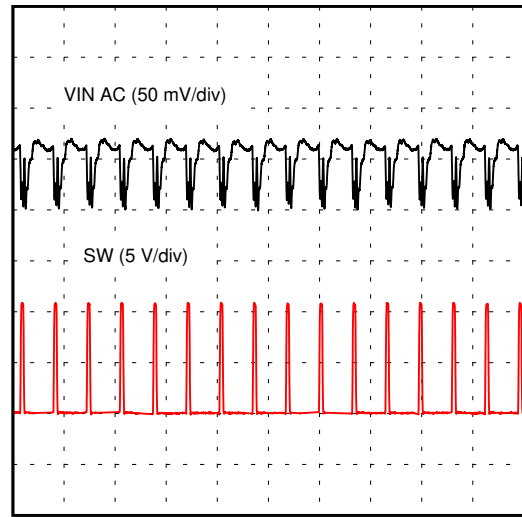

Time (1  $\mu$ s/div)  
**Figure 3-21. U1 Input Ripple – 6-A Load**

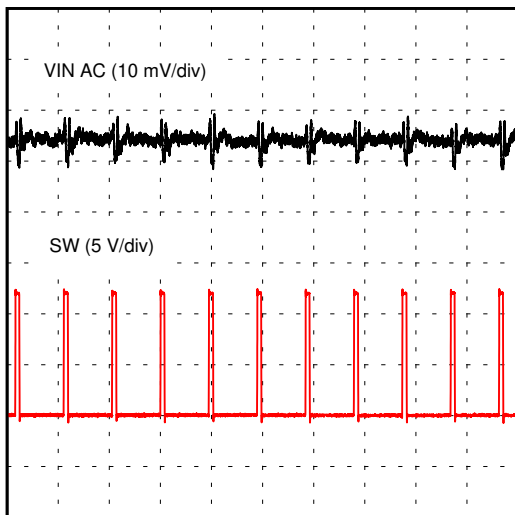

Time (1  $\mu$ s/div)  
**Figure 3-22. U2 Input Ripple – No Load**

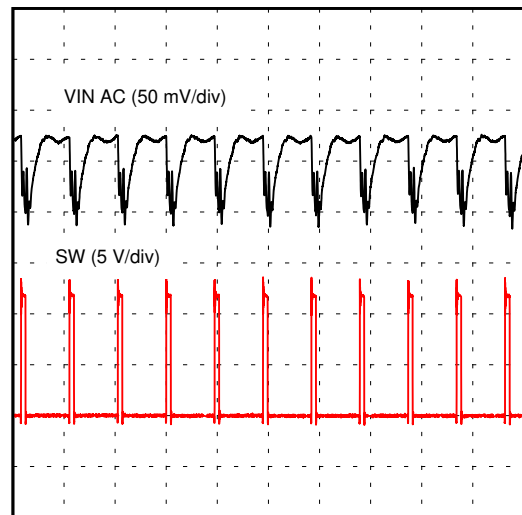

Time (1  $\mu$ s/div)  
**Figure 3-23. U2 Input Ripple – 6-A Load**

### 3.7 Synchronizing to a Clock

Figure 3-24 shows U1 and U2 synchronized to an external clock of 1.25 MHz at the SYNC test point. To synchronize to the clock at the SYNC test point, place a shunt on the ENSYNC\_U1 or ENSYNC\_U2 jumper or jumpers to enable the output of the buffers.

Figure 3-25 shows the transitions to and from synchronizing to an external clock with 6-A load. 16 pulses with a frequency of 1-MHz were sent to the SYNC testpoint on the EVM. In this waveform, after four pulses, the TPS543820 begins synchronizing to the clock. After the clock goes away, the TPS543820 switches at 70% of the internal clock frequency for four pulses then transitions back to the normal internal clock frequency. There is only a small variation in the output voltage during these transitions.

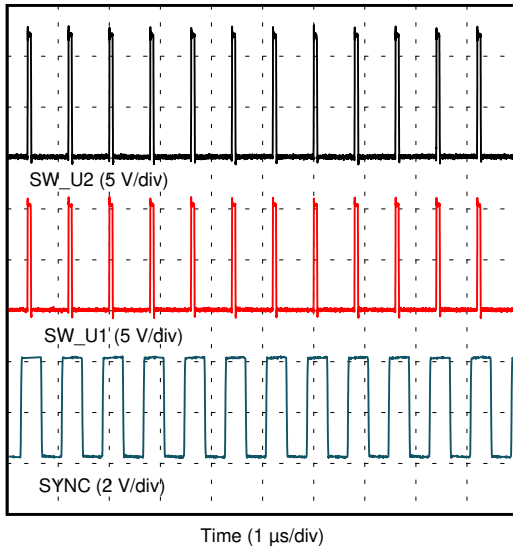

Figure 3-24. U1 and U2 Synchronized to a Clock

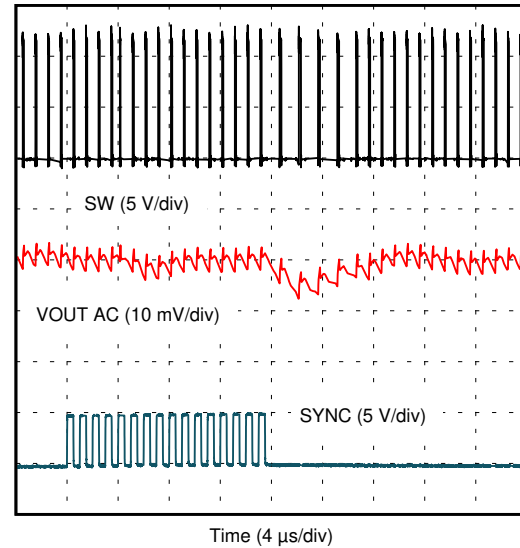

Figure 3-25. U2 Clock Synchronization Transitions

### 3.8 Start-up and Shutdown with EN

Figure 3-26 and Figure 3-27 show the start-up and shutdown waveforms for U2 with EN. In Figure 3-26, the input voltage is initially applied and the output is inhibited by pulling EN to GND using an external function generator. When the EN voltage is increased above the enable-threshold voltage, the start-up sequence begins and the output voltage ramps up to the externally set value. In Figure 3-27, the external function generator pulls EN to ground and the TPS543820 shuts down.

Figure 3-28 shows EN start-up with a 0.2-Ω resistor load. Figure 3-29 shows the BP5 internal LDO start-up relative to the EN pin.

A shunt on the ENOFF\_U1 jumper or RDIV\_VIN can be used to test the EN start-up of U1 and U2, respectively. When the shunt is removed from ENOFF\_U1, EN is released and the start-up sequence begins for U1. When the shunt is placed on RDIV\_VIN, EN is pulled to the input voltage through the resistor divider and the start-up sequence begins for U2.

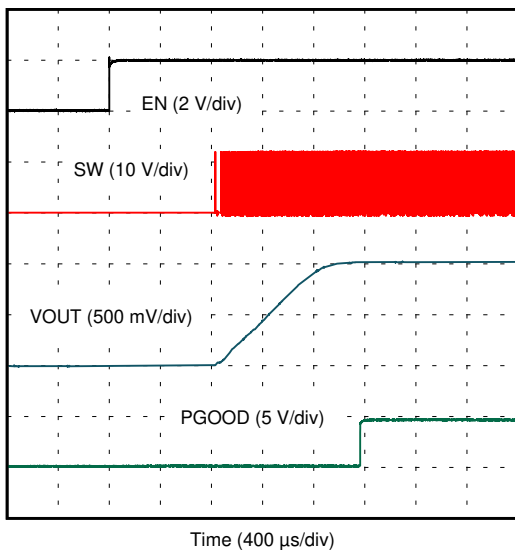

Figure 3-26. U2 Start-up with EN – No Load

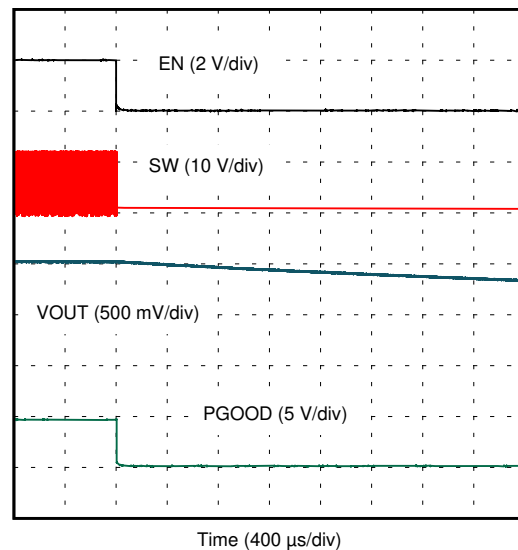

Figure 3-27. U2 Shutdown with EN – No Load

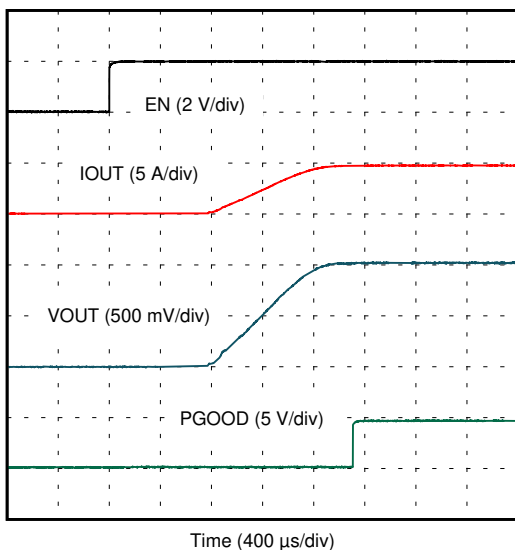

Figure 3-28. U2 Start-up with EN – 0.2-Ω Load

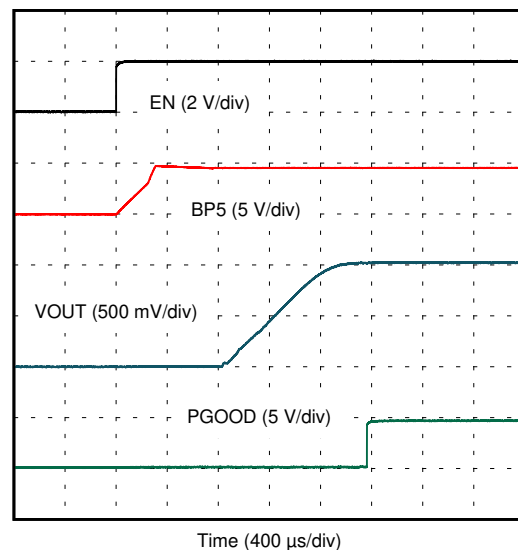
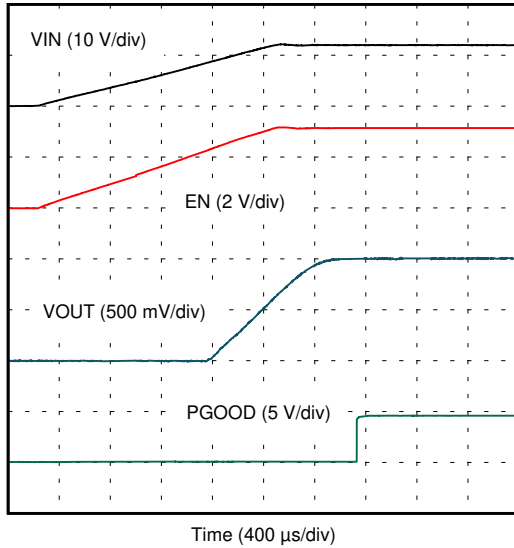

Figure 3-29. U2 Startup with EN – No Load and Measuring BP5

### 3.9 Start-up and Shutdown with VIN

Figure 3-30 and Figure 3-31 show the start-up and shutdown waveforms for U2 with VIN. In Figure 3-30, the VIN voltage ramps up and output voltage ramps up after the input and EN pin voltages reach their respective UVLO threshold. In Figure 3-31, the VIN voltage ramps down and the TPS543820 shuts down when the input or EN pin voltage reach their respective UVLO threshold. The rate at which VIN ramps down changes as soon as the TPS543820 is disabled because it is no longer loading the input supply.



**Figure 3-30. U2 Start-up with VIN – 0.3-Ω Load**

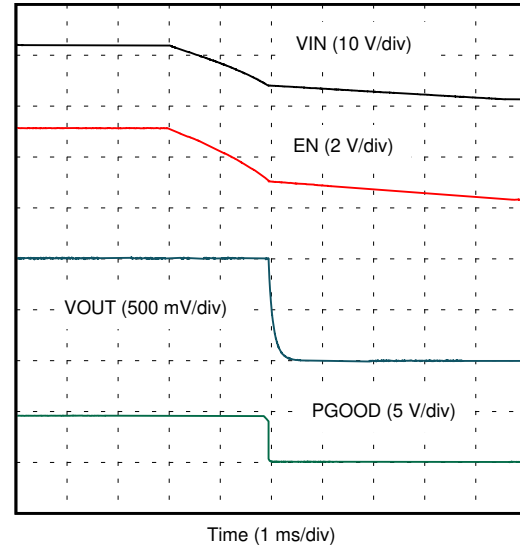

**Figure 3-31. U2 Shutdown with VIN – 0.3-Ω Load**

### 3.10 Start-up Into Pre-Bias

Figure 3-32 shows the EN start-up of U2 into a pre-biased output. The output voltage is pre-biased by toggling the EN pin low then high at a rate such that the output voltage does not fully discharge before EN goes high again.

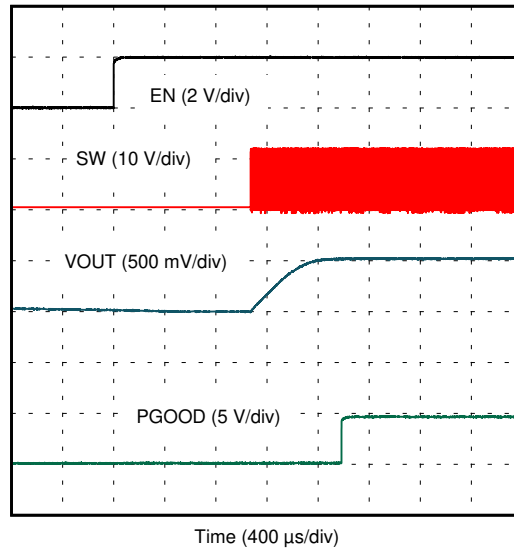
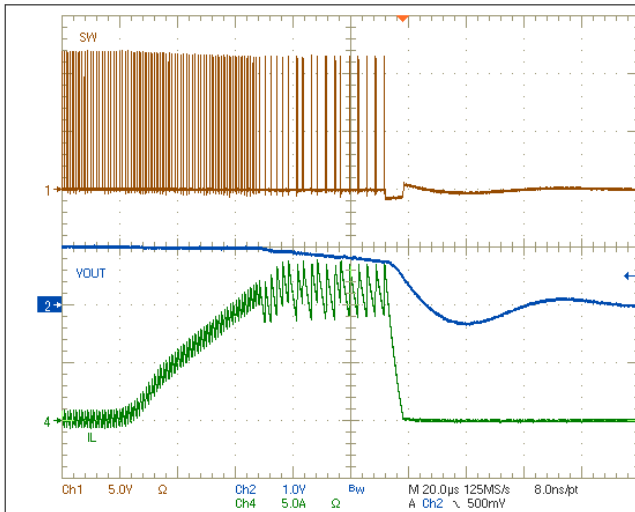

**Figure 3-32. U2 Start-up Into 0.5-V Pre-Bias**

### 3.11 Hiccup Current Limit

Figure 3-33 through Figure 3-37 show the TPS543820 hiccup current limit feature. These waveforms are measured using U2. Figure 3-33 and Figure 3-34 show the response to an overload with the High and Low current limit settings. Figure 3-35 and Figure 3-36 show the response to a hard short on the output with the High and Low current limit settings.

Figure 3-37 shows the TPS543820 entering hiccup with an overload on the output and the High current limit setting with a longer timescale. The TPS543820 tries to restart after the Hiccup wait time period but the overload was still present on the output. In the next restart attempt, the overload has been removed so the TPS543820 starts up normally.



**Figure 3-33. U2 Output Overcurrent Protection – Overload with High Limit**

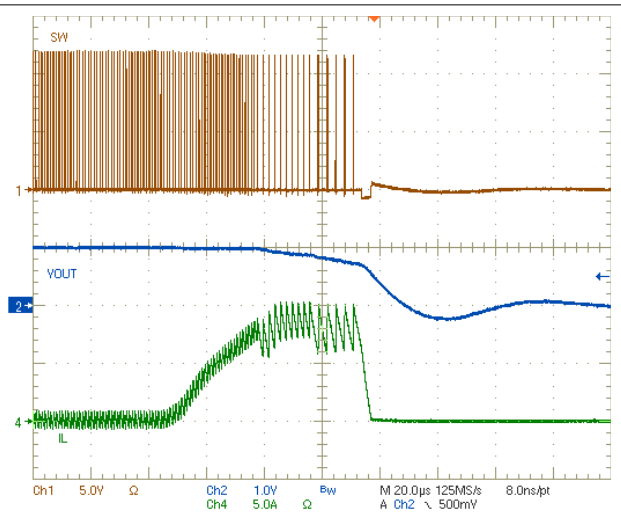

**Figure 3-34. U2 Output Overcurrent Protection – Overload with Low Limit**

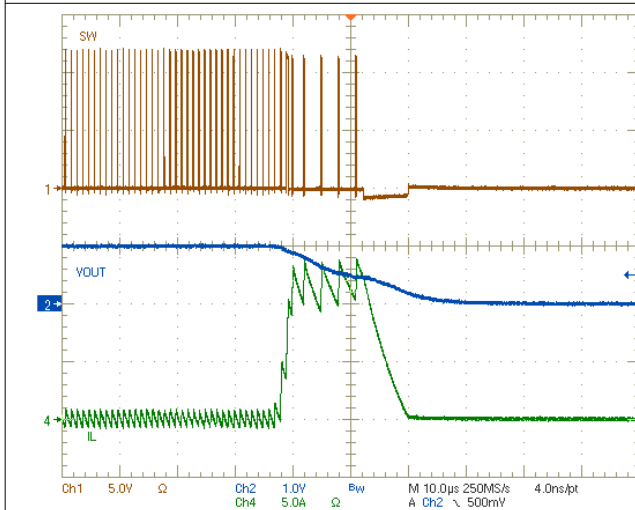

**Figure 3-35. U2 Output Overcurrent Protection – Short with High Limit**

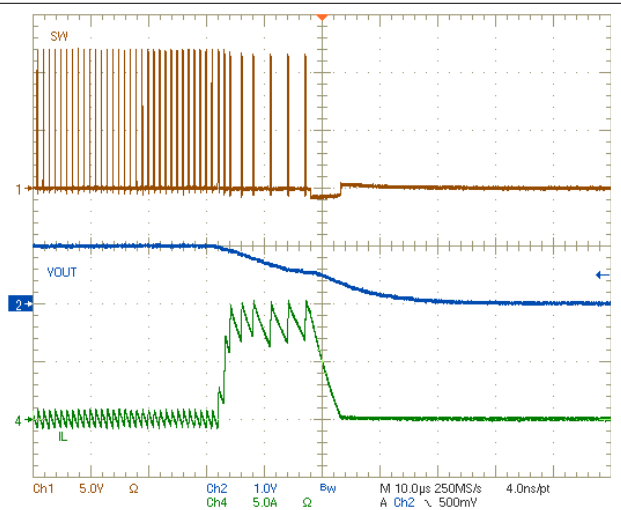

**Figure 3-36. U2 Output Overcurrent Protection – Short with Low Limit**

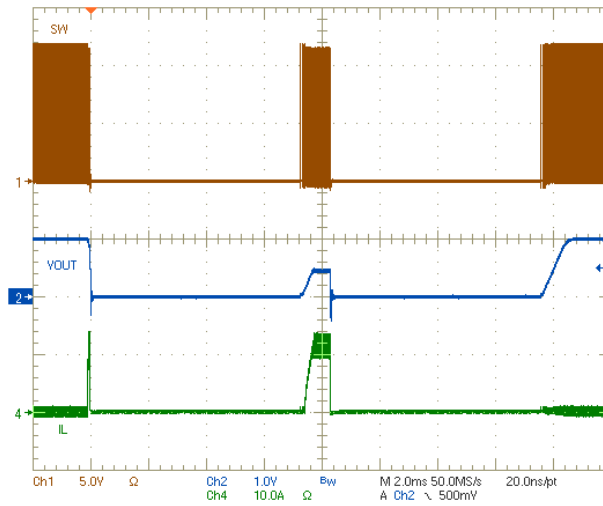

**Figure 3-37. U2 OCP Hiccup and Recover – High Limit**

### 3.12 Overvoltage Protection

Figure 3-38 and Figure 3-39 show the overvoltage protection behavior of U2. This is tested by applying a step to the FB pin with a function generator through the VO\_ADJ test point. The VO\_ADJ test point is initially equal to the reference voltage of 0.5 V and is stepped up to 3.3 V. The TPS543820 attempts to restart immediately after the OVP fault is cleared. It does not wait for the hiccup time period.

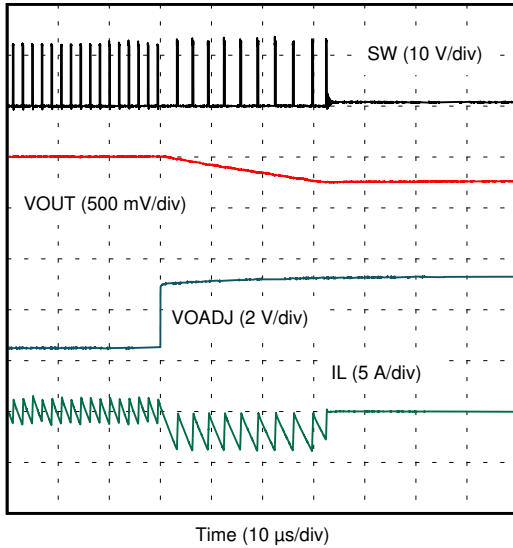

**Figure 3-38. U2 Overvoltage Protection**

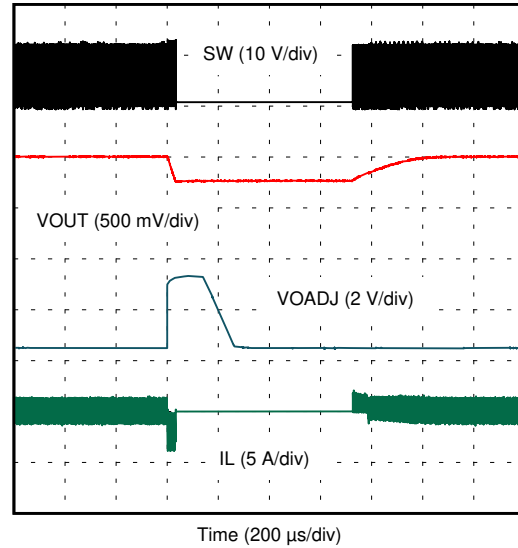

**Figure 3-39. U2 OVP and Recover**



### 3.13 Thermal Performance

Figure 3-40 through Figure 3-43 show the temperature rise of the TPS543820 ICs at full 8-A load. Figure 3-40 and Figure 3-41 have only one TPS543820 on and loaded. Figure 3-42 and Figure 3-43 have both TPS543820s loaded. A minimum of a 10 minute soak time was used before taking each measurement.

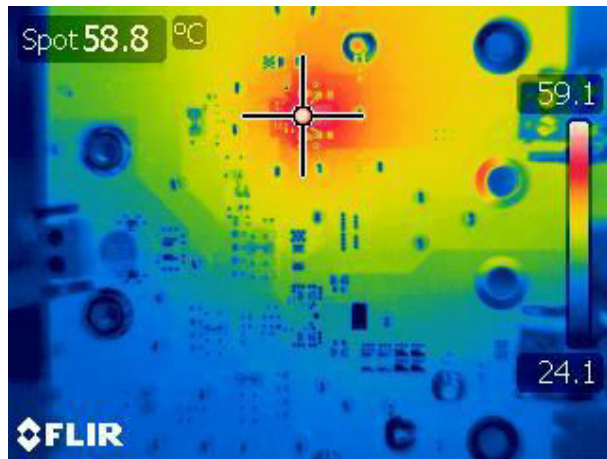

Figure 3-40. U1 Thermal Performance – 8-A Load and U2 off

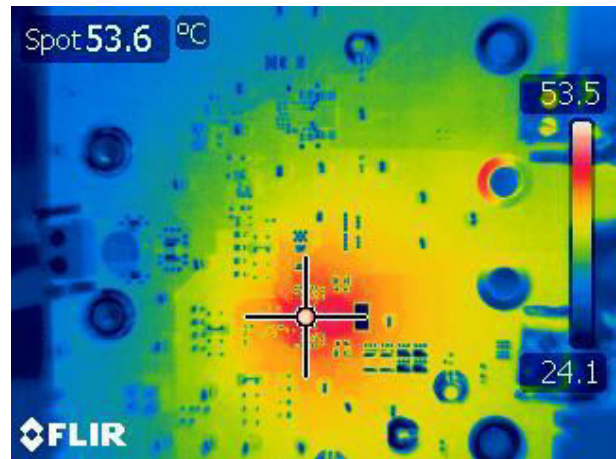

Figure 3-41. U2 Thermal Performance – 8-A Load and U1 off

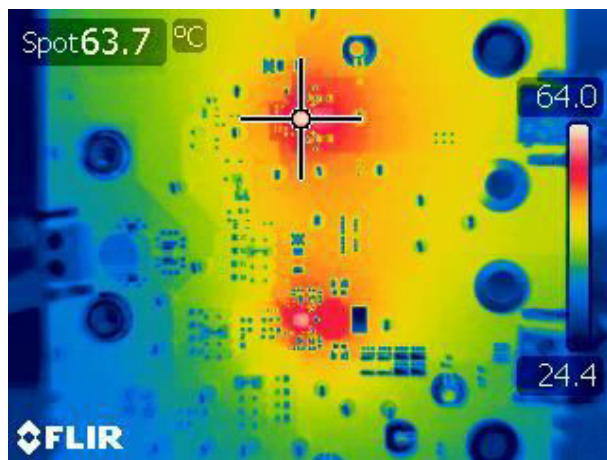

Figure 3-42. U1 Thermal Performance – Both 8-A Load

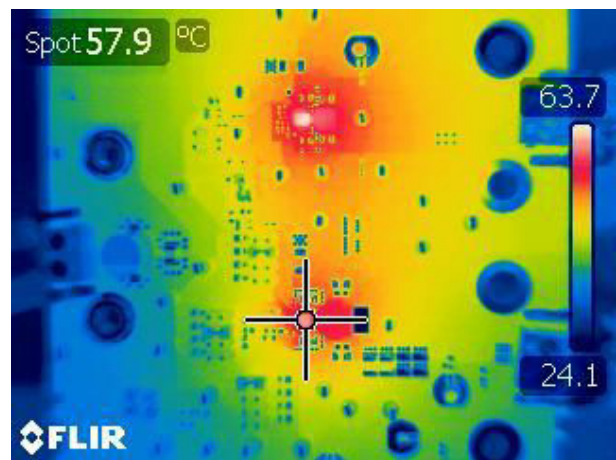

Figure 3-43. U2 Thermal Performance – Both 8-A Load

## 4 Board Layout

This section provides a description of the TPS543820EVM board layout and layer illustrations.

### 4.1 Layout

The board layout for the TPS543820EVM is shown in [Figure 4-1](#) through [Figure 4-6](#). The top-side layer of the EVM is laid out in a manner typical of a user application. The top, bottom, and internal layers are 2-oz. copper. The small size U1 circuit takes up an area of only approximately 100 mm<sup>2</sup> as shown on the silkscreen.

All of the required components for the TPS543820 are placed on the top layer. The input decoupling capacitors, BP5 capacitor, and bootstrap capacitor are all located as close to the IC as possible. Additionally, the voltage set point resistor divider components are kept close to the IC. An additional input bulk capacitor is used near the input terminal to limit the noise entering the converter from the supply used to power the board. Critical analog circuits such as the voltage set point divider, EN resistor, MODE resistor, and FSEL resistor are kept close to the IC and terminated to the quiet analog ground (AGND) island on the top layer.

The top layer contains the main power traces for VIN, VOUT, and SW. The top layer power traces are connected to the planes on other layers of the board with multiple vias placed around the board. There are multiple vias near the PGND pins of the IC to help maximize the thermal performance. Each TPS543820 circuit has its own dedicated ground area for quiet analog ground that is connected to the main power ground plane at a single point. This single point connection is done using vias to the internal ground planes. Lastly the voltage divider network ties to the output voltage at the point of regulation, the copper V<sub>OUT</sub> area on the top layer.

The mid layer 1 is a large ground plane with as few traces as possible to minimize cuts in the ground plane. It is especially important to minimize cuts in the ground plane near the IC to help with minimize noise and maximize thermal performance.

The mid layer 2 contains a VIN copper area to connect both TPS543820 circuits to the input terminals. There is also a VIN copper area beneath each IC to connect its VIN pins together with a low impedance connection. This layer also has the trace to connect the FB divider to the output. Lastly, the remaining area of this layer is filled in with PGND.

The bottom layer is primarily used for another ground plane. This layer also has an additional VOUT copper area for the U2 circuit. Lastly, the load transient circuit is placed on this side of the EVM.

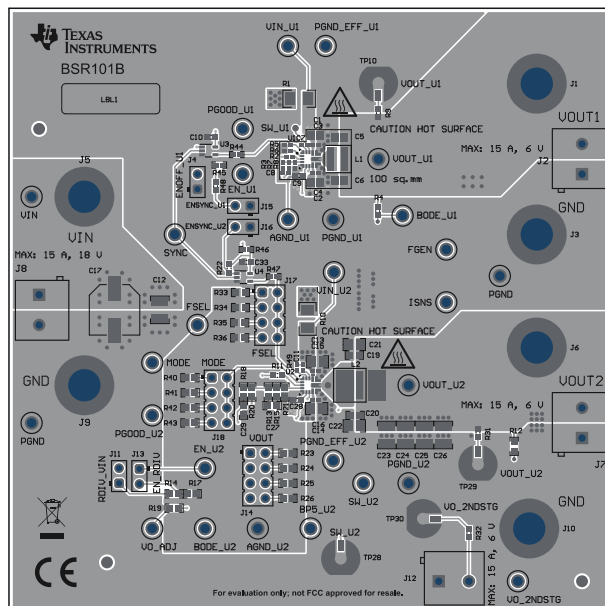

**Figure 4-1. Top-Side Composite View**

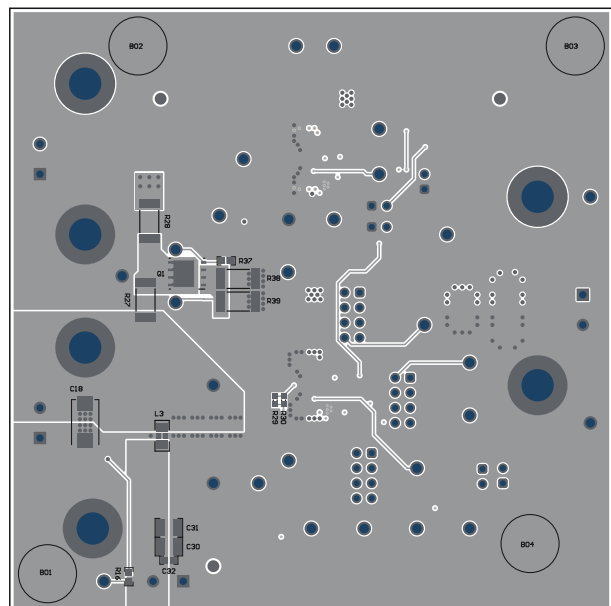

**Figure 4-2. Bottom-Side Composite View (Viewed From Bottom)**

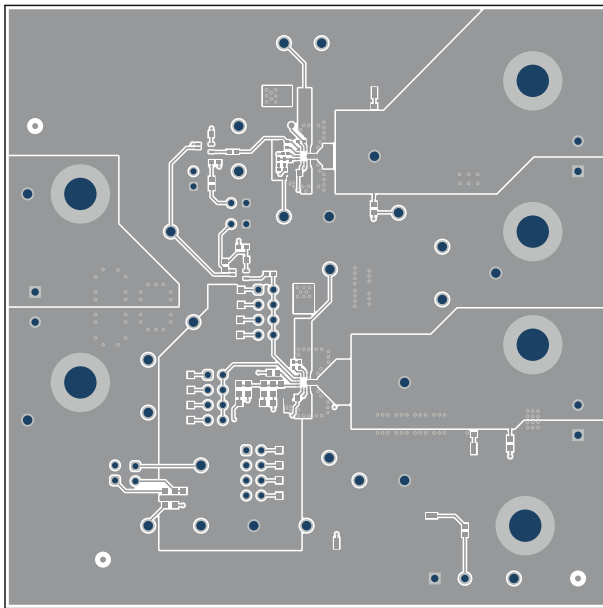

**Figure 4-3. Top Layer Layout**

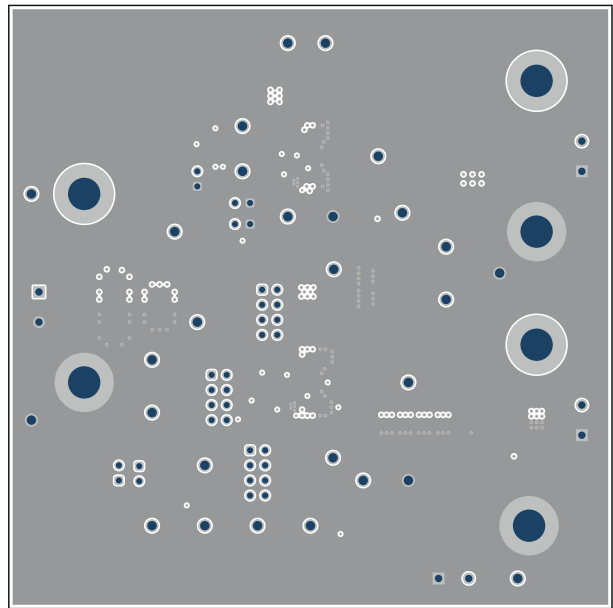

**Figure 4-4. Mid Layer 1 Layout**

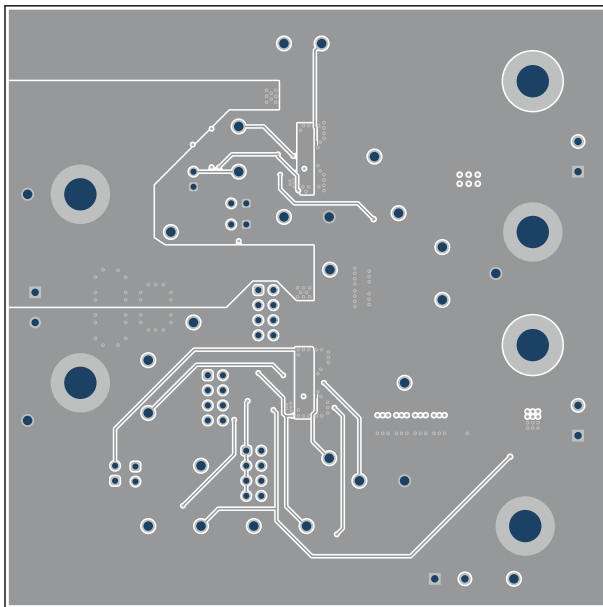

**Figure 4-5. Mid Layer 2 Layout**

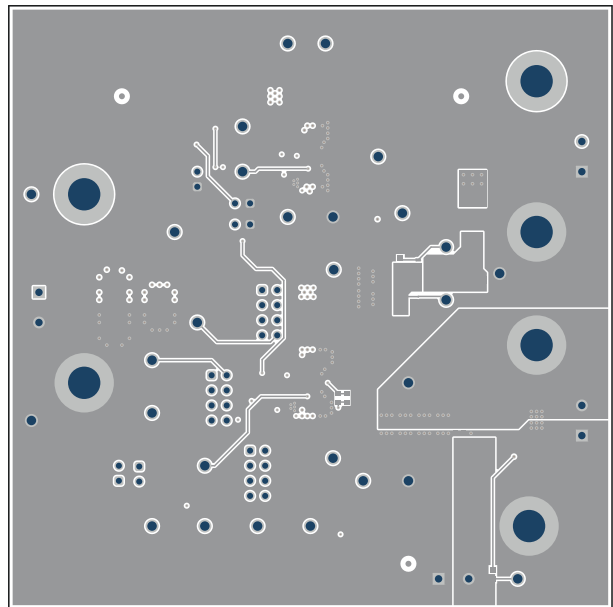

**Figure 4-6. Bottom Layer Layout**

## 5 Schematic and Bill of Materials

This section presents the TPS543820EVM schematic and bill of materials.

## 5.1 Schematic

Figure 5-1 is the schematic for U1. Figure 5-2 is the schematic for U2.

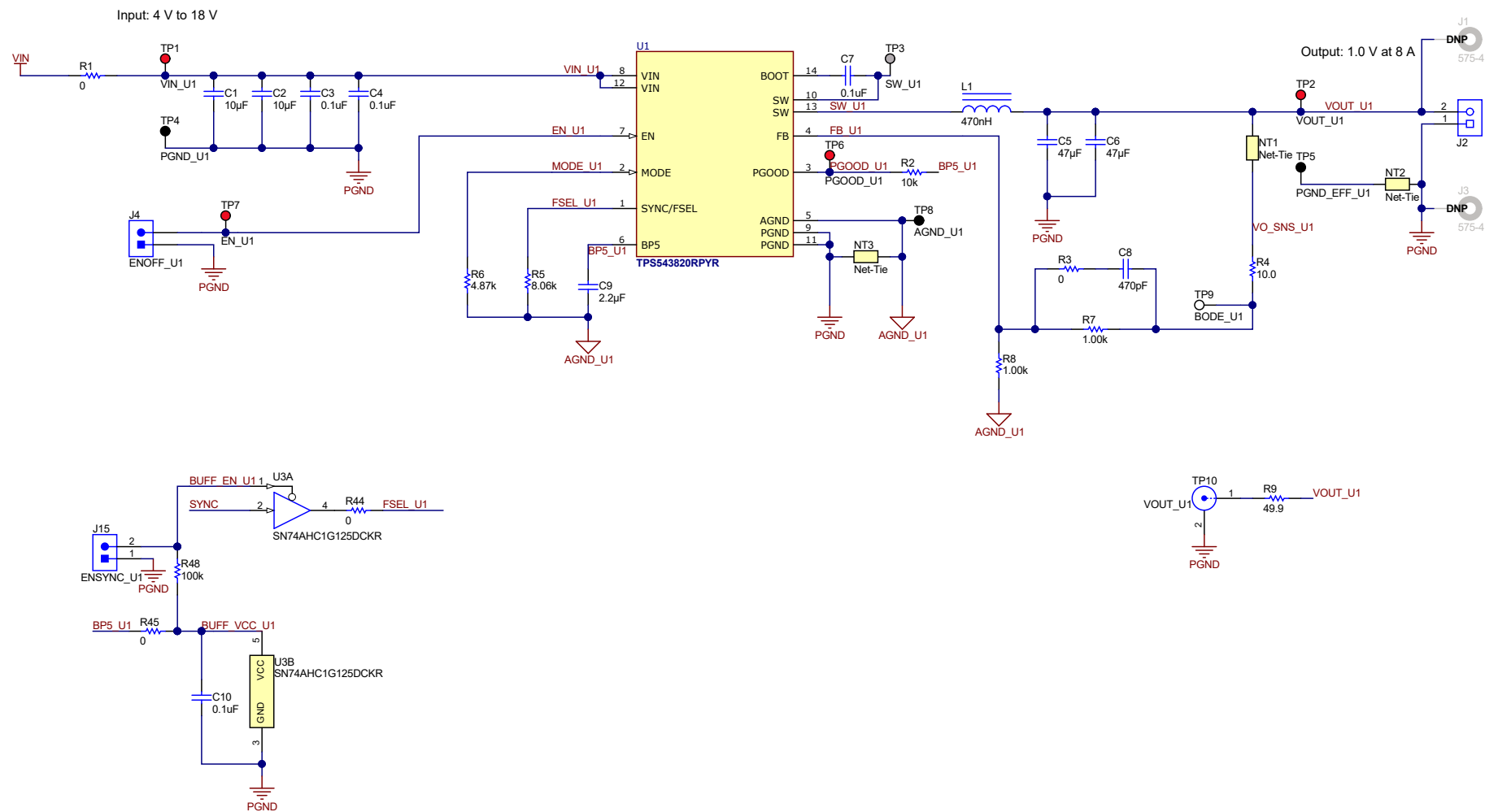

Figure 5-1. U1 Schematic

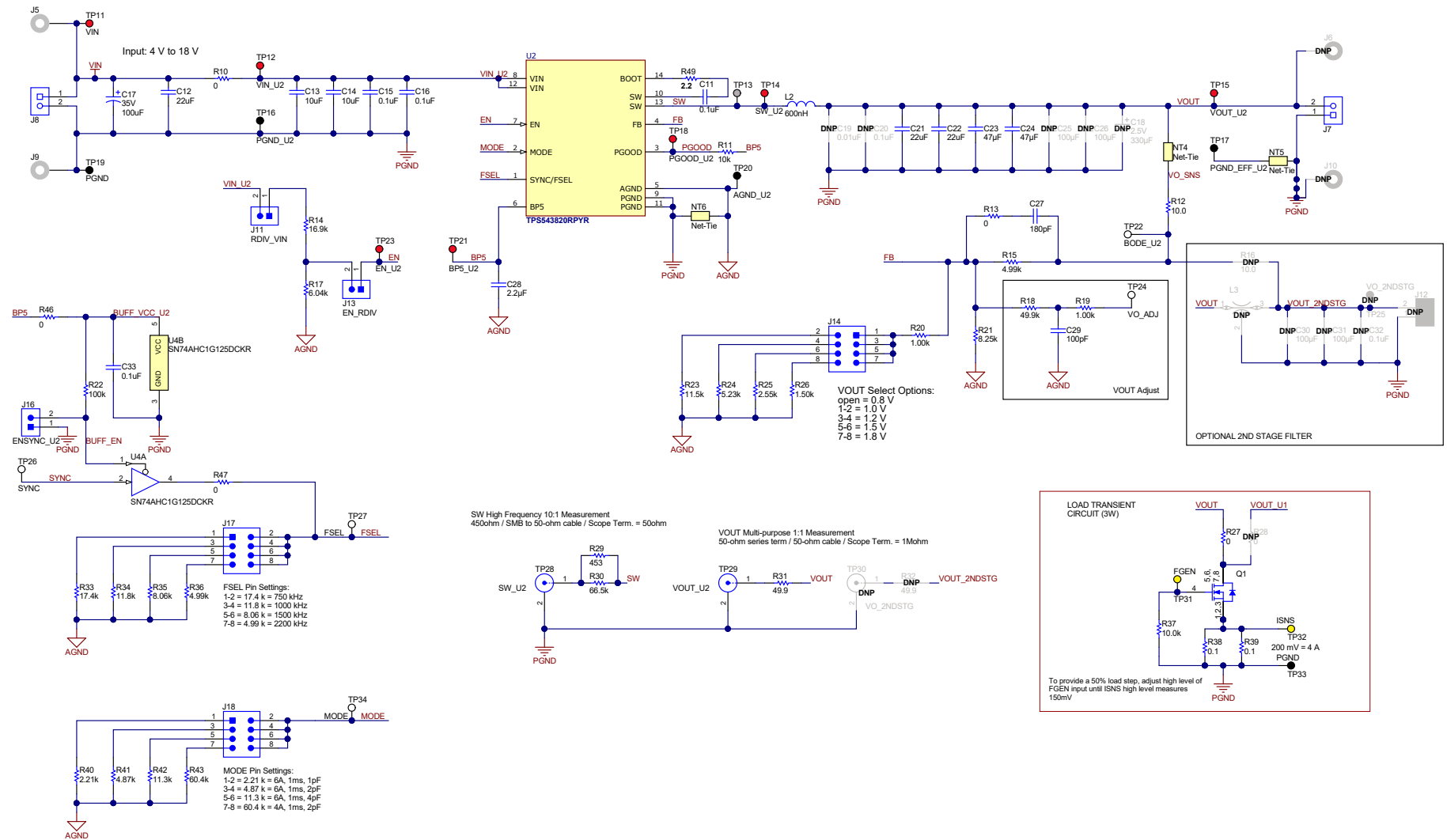

Figure 5-2. U2 Schematic

## 5.2 Bill of Materials

Table 5-1 presents the bill of materials for the TPS543820EVM.

**Table 5-1. TPS543820EVM Bill of Materials**

| Designator                | Quantity | Value | Description  | PackageReference             | PartNumber         | Manufacturer        |
|---------------------------|----------|-------|--|------------------------------|--------------------|---------------------|
| !PCB1                     | 1        |       | Printed Circuit Board  |                              | BSR101             | Any                 |
| BO1, BO2, BO3, BO4        | 4        |       | Bumpon, Hemisphere, 0.375 X 0.235, Black   | Black Bumpon                 | SJ61A2             | 3M                  |
| C1, C2, C13, C14          | 4        | 10uF  | CAP, CERM, 10 uF, 25 V, +/- 10%, X7S, 0805                                       | 0805                         | GRM21BC71E106KE11L | MuRata              |
| C3, C4, C7, C11, C15, C16 | 6        | 0.1uF | CAP, CERM, 0.1 uF, 50 V, +/- 10%, X7R, 0402                                      | 0402                         | C1005X7R1H104K050B | TDK                 |
| C5, C6                    | 2        | 47uF  | CAP, CERM, 47 uF, 10 V, +/- 20%, X5R, 0805                                       | 0805                         | GRM21BR61A476ME15L | MuRata              |
| C8                        | 1        | 470pF | CAP, CERM, 470 pF, 50 V, +/- 10%, C0G/NP0, 0402                                  | 0402                         | C0402C471K5GAC7867 | Kemet               |
| C9, C28                   | 2        | 2.2uF | CAP, CERM, 2.2 uF, 10 V, +/- 10%, X7R, 0603                                      | 0603                         | C1608X7R1A225K080A | TDK                 |
| C10, C33                  | 2        | 0.1uF | CAP, CERM, 0.1 uF, 25 V, +/- 5%, X7R, 0603                                       | 0603                         | C0603C104J3RACTU   | Kemet               |
| C12                       | 1        | 22uF  | CAP, CERM, 22 uF, 25 V, +/- 10%, X7R, 1210                                       | 1210                         | GRM32ER71E226KE15L | MuRata              |
| C17                       | 1        | 100uF | CAP, AL, 100 uF, 35 V, +/- 20%, 0.16 ohm, AEC-Q200 Grade 2, SMD                  | SMT Radial F                 | EEE-FK1V101P       | Panasonic           |
| C21, C22                  | 2        | 22uF  | CAP, CERM, 22 uF, 10 V, +/- 20%, X7S, 0805                                       | 0805                         | C2012X7S1A226M125A | TDK                 |
| C23, C24                  | 2        | 47uF  | CAP, CERM, 47 uF, 10 V, +/- 20%, X7R, 1210                                       | 1210                         | LMK325B7476MM-PR   | Taiyo Yuden         |
| C27                       | 1        | 180pF | CAP, CERM, 180 pF, 50 V, +/- 5%, C0G/NP0, 0603                                   | 0603                         | C0603C181J5GACTU   | Kemet               |
| C29                       | 1        | 100pF | CAP, CERM, 100 pF, 50 V, +/- 5%, C0G/NP0, 0603                                   | 0603                         | C0603C101J5GACTU   | Kemet               |
| J2, J7, J8                | 3        |       | Terminal Block, 5.08 mm, 2x1, Brass, TH  | 2x1 5.08 mm Terminal Block   | ED120/2DS          | On-Shore Technology |
| J4, J11, J13, J15, J16    | 5        |       | Header, 2.54mm, 2x1, Gold, TH  | Header, 2.54mm, 2x1, TH      | TSW-102-08-G-S     | Samtec              |
| J5, J9                    | 2        |       | Standard Banana Jack, Uninsulated, 5.5mm   | Keystone_575-4               | 575-4              | Keystone            |
| J14, J17, J18             | 3        |       | Header, 2.54mm, 4x2, Gold, TH  | Header, 2.54mm, 4x2, TH      | TSW-104-08-L-D     | Samtec              |
| L1                        | 1        | 470nH | Inductor, Shielded, Composite, 470 nH, 15.5 A, 0.0041 ohm, AEC-Q200 Grade 1, SMD | 4x4mm                        | XEL4030-471MEB     | Coilcraft           |
| L2                        | 1        |       | Shielded Power Inductor  | SMD2                         | XEL5030-601MEC     | Coilcraft           |
| LBL1                      | 1        |       | Thermal Transfer Printable Labels, 0.650" W x 0.200" H - 10,000 per roll         | PCB Label 0.650 x 0.200 inch | THT-14-423-10      | Brady               |
| Q1                        | 1        | 30V   | MOSFET, N-CH, 30 V, 25 A, DQJ0008A (VSONP-8)                                     | DQJ0008A                     | CSD17579Q5A        | Texas Instruments   |
| R1, R10                   | 2        | 0     | RES, 0, 5%, 0.25 W, AEC-Q200 Grade 0, 1206                                       | 1206                         | ERJ-8GEY0R00V      | Panasonic           |
| R2                        | 1        | 10k   | RES, 10 k, 5%, 0.1 W, AEC-Q200 Grade 0, 0402                                     | 0402                         | ERJ-2GEJ103X       | Panasonic           |
| R3                        | 1        | 0     | RES, 0, 5%, 0.1 W, AEC-Q200 Grade 0, 0402  | 0402                         | ERJ-2GE0R00X       | Panasonic           |
| R4, R12                   | 2        | 10.0  | RES, 10.0, 1%, 0.1 W, 0603   | 0603                         | RC0603FR-0710RL    | Yageo               |
| R5                        | 1        | 8.06k | RES, 8.06 k, 1%, 0.063 W, AEC-Q200 Grade 0, 0402                                 | 0402                         | CRCW04028K06FKED   | Vishay-Dale         |
| R6                        | 1        | 4.87k | RES, 4.87 k, 1%, 0.063 W, AEC-Q200 Grade 0, 0402                                 | 0402                         | CRCW04024K87FKED   | Vishay-Dale         |
| R7, R8                    | 2        | 1.00k | RES, 1.00 k, 1%, 0.063 W, AEC-Q200 Grade 0, 0402                                 | 0402                         | CRCW04021K00FKED   | Vishay-Dale         |
| R9, R31                   | 2        | 49.9  | RES, 49.9, 1%, 0.1 W, 0603   | 0603                         | RC0603FR-0749R9L   | Yageo               |
| R11                       | 1        | 10k   | RES, 10 k, 5%, 0.1 W, 0603   | 0603                         | RC0603JR-0710KL    | Yageo               |
| R13                       | 1        | 0     | RES, 0, 5%, 0.1 W, 0603  | 0603                         | RC0603JR-070RL     | Yageo               |
| R14                       | 1        | 16.9k | RES, 16.9 k, 1%, 0.1 W, 0603   | 0603                         | RC0603FR-0716K9L   | Yageo               |
| R15, R36                  | 2        | 4.99k | RES, 4.99 k, 1%, 0.1 W, 0603   | 0603                         | RC0603FR-074K99L   | Yageo               |
| R17                       | 1        | 6.04k | RES, 6.04 k, 1%, 0.1 W, 0603   | 0603                         | RC0603FR-076K04L   | Yageo               |
| R18                       | 1        | 49.9k | RES, 49.9 k, 1%, 0.1 W, 0603   | 0603                         | RC0603FR-0749K9L   | Yageo               |

**Table 5-1. TPS543820EVM Bill of Materials (continued)**

| Designator   | Quantity | Value  | Description   | PackageReference              | PartNumber         | Manufacturer        |
|--|----------|--------|---|-------------------------------|--------------------|---------------------|
| R19, R20   | 2        | 1.00k  | RES, 1.00 k, 1%, 0.1 W, 0603  | 0603                          | RC0603FR-071K1L    | Yageo               |
| R21  | 1        | 8.25k  | RES, 8.25 k, 1%, 0.1 W, 0603  | 0603                          | RC0603FR-078K25L   | Yageo               |
| R22, R48   | 2        | 100k   | RES, 100 k, 5%, 0.1 W, 0603   | 0603                          | CRCW0603100KJNEAC  | Vishay-Dale         |
| R23  | 1        | 11.5k  | RES, 11.5 k, 1%, 0.1 W, 0603  | 0603                          | RC0603FR-0711K5L   | Yageo               |
| R24  | 1        | 5.23k  | RES, 5.23 k, 1%, 0.1 W, 0603  | 0603                          | RC0603FR-075K23L   | Yageo               |
| R25  | 1        | 2.55k  | RES, 2.55 k, 1%, 0.1 W, 0603  | 0603                          | RC0603FR-072K55L   | Yageo               |
| R26  | 1        | 1.50k  | RES, 1.50 k, 1%, 0.1 W, 0603  | 0603                          | RC0603FR-071K5L    | Yageo               |
| R27  | 1        | 0      | RES, 0, 5%, 1 W, AEC-Q200 Grade 0, 2512                               | 2512                          | CRCW25120000Z0EG   | Vishay-Dale         |
| R29  | 1        | 453    | RES, 453, 1%, 0.1 W, 0603   | 0603                          | RC0603FR-07453RL   | Yageo               |
| R30  | 1        | 66.5k  | RES, 66.5 k, 1%, 0.1 W, 0603  | 0603                          | RC0603FR-0766K5L   | Yageo               |
| R33  | 1        | 17.4k  | RES, 17.4 k, 1%, 0.1 W, 0603  | 0603                          | RC0603FR-0717K4L   | Yageo               |
| R34  | 1        | 11.8k  | RES, 11.8 k, 1%, 0.1 W, 0603  | 0603                          | RC0603FR-0711K8L   | Yageo               |
| R35  | 1        | 8.06k  | RES, 8.06 k, 1%, 0.1 W, 0603  | 0603                          | RC0603FR-078K06L   | Yageo               |
| R37  | 1        | 10.0k  | RES, 10.0 k, 1%, 0.1 W, 0603  | 0603                          | ERJ-3EKF1002V      | Panasonic           |
| R38, R39   | 2        | 0.1    | RES, 0.1, 1%, 3 W, 2512   | 2512                          | CRA2512-FZ-R100ELF | Bourns              |
| R40  | 1        | 2.21k  | RES, 2.21 k, 1%, 0.1 W, 0603  | 0603                          | RC0603FR-072K21L   | Yageo               |
| R41  | 1        | 4.87k  | RES, 4.87 k, 1%, 0.1 W, 0603  | 0603                          | RC0603FR-074K87L   | Yageo               |
| R42  | 1        | 11.3k  | RES, 11.3 k, 1%, 0.1 W, 0603  | 0603                          | RC0603FR-0711K3L   | Yageo               |
| R43  | 1        | 60.4k  | RES, 60.4 k, 1%, 0.1 W, 0603  | 0603                          | RC0603FR-0760K4L   | Yageo               |
| R44, R45, R46, R47   | 4        | 0      | RES, 0, 5%, 0.063 W, AEC-Q200 Grade 0, 0402                           | 0402                          | CRCW04020000Z0ED   | Vishay-Dale         |
| R49  | 1        | 2.2    | RES, 2.2, 5%, 0.063 W, AEC-Q200 Grade 0, 0402                         | 0402                          | CRCW04022R20JNED   | Vishay-Dale         |
| SH-J1, SH-J2, SH-J3, SH-J4, SH-J5, SH-J6, SH-J7, SH-J8       | 8        | 1x2    | Shunt, 100mil, Gold plated, Black                                     | Shunt                         | SNT-100-BK-G       | Samtec              |
| TP1, TP2, TP6, TP7, TP11, TP12, TP14, TP15, TP18, TP21, TP23 | 11       |        | Test Point, Multipurpose, Red, TH                                     | Red Multipurpose Testpoint    | 5010               | Keystone            |
| TP4, TP5, TP8, TP16, TP17, TP19, TP20, TP33                  | 8        |        | Test Point, Multipurpose, Black, TH                                   | Black Multipurpose Testpoint  | 5011               | Keystone            |
| TP9, TP22, TP24, TP26, TP27, TP34                            | 6        |        | Test Point, Multipurpose, White, TH                                   | White Multipurpose Testpoint  | 5012               | Keystone            |
| TP10, TP28, TP29   | 3        |        | Connector, Receptacle, 50 ohm, TH                                     | SMB Connector                 | SMBR004D00         | JAE Electronics     |
| TP31, TP32   | 2        |        | Test Point, Multipurpose, Yellow, TH                                  | Yellow Multipurpose Testpoint | 5014               | Keystone            |
| U1, U2   | 2        |        | Synchronous SWIFT Step-Down Converter                                 | VQFN-HR14                     | TPS543820RPYR      | Texas Instruments   |
| U3, U4   | 2        |        | Single Bus Buffer Gate with 3-State Output, DCK0005A, LARGE T&R       | DCK0005A                      | SN74AHC1G125DCKR   | Texas Instruments   |
| C18  | 0        | 330uF  | CAP, Aluminum Polymer, 330 µF, 2.5 V,+/- 20%, 0.006 ohm, 7343-20, SMD | 7343-20                       | EEFSX0E331XE       | Panasonic           |
| C19  | 0        | 0.01uF | CAP, CERM, 0.01 uF, 50 V, +/- 5%, COG/NP0, 0603                       | 0603                          | GRM1885C1H103JA01D | MuRata              |
| C20, C32   | 0        | 0.1uF  | CAP, CERM, 0.1 uF, 25 V, +/- 5%, X7R, 0603                            | 0603                          | C0603C104J3RACTU   | Kemet               |
| C25, C26, C30, C31   | 0        | 100uF  | CAP, CERM, 100 µF, 6.3 V,+/- 20%, X7S, 1210                           | 1210                          | GRM32EC70J107ME15L | MuRata              |
| FID1, FID2, FID3, FID4, FID5, FID6                           | 0        |        | Fiducial mark. There is nothing to buy or mount.                      | N/A                           | N/A                | N/A                 |
| J1, J3, J6, J10  | 0        |        | Standard Banana Jack, Uninsulated, 5.5mm                              | Keystone_575-4                | 575-4              | Keystone            |
| J12  | 0        |        | Terminal Block, 5.08 mm, 2x1, Brass, TH                               | 2x1 5.08 mm Terminal Block    | ED120/2DS          | On-Shore Technology |
| L3   | 0        | 27 uF  | FILTER LC HIGH FREQ 27uF 1206   | 3.2x1.6mm                     | NFM31PC276B0J3L    | MuRata              |
| R16  | 0        | 10.0   | RES, 10.0, 1%, 0.1 W, 0603  | 0603                          | RC0603FR-0710RL    | Yageo               |
| R28  | 0        | 0      | RES, 0, 5%, 1 W, AEC-Q200 Grade 0, 2512                               | 2512                          | CRCW25120000Z0EG   | Vishay-Dale         |
| R32  | 0        | 49.9   | RES, 49.9, 1%, 0.1 W, 0603  | 0603                          | RC0603FR-0749R9L   | Yageo               |
| TP25   | 0        |        | Test Point, Multipurpose, Red, TH                                     | Red Multipurpose Testpoint    | 5010               | Keystone            |
| TP30   | 0        |        | Connector, Receptacle, 50 ohm, TH                                     | SMB Connector                 | SMBR004D00         | JAE Electronics     |

## 6 Revision History

NOTE: Page numbers for previous revisions may differ from page numbers in the current version.

| <b>Changes from Revision * (December 2020) to Revision A (April 2021)</b> | <b>Page</b>       |
|---|-------------------|
| • Updated user's guide title.....   | <a href="#">3</a> |

---



## IMPORTANT NOTICE AND DISCLAIMER

TI PROVIDES TECHNICAL AND RELIABILITY DATA (INCLUDING DATA SHEETS), DESIGN RESOURCES (INCLUDING REFERENCE DESIGNS), APPLICATION OR OTHER DESIGN ADVICE, WEB TOOLS, SAFETY INFORMATION, AND OTHER RESOURCES "AS IS" AND WITH ALL FAULTS, AND DISCLAIMS ALL WARRANTIES, EXPRESS AND IMPLIED, INCLUDING WITHOUT LIMITATION ANY IMPLIED WARRANTIES OF MERCHANTABILITY, FITNESS FOR A PARTICULAR PURPOSE OR NON-INFRINGEMENT OF THIRD PARTY INTELLECTUAL PROPERTY RIGHTS.

These resources are intended for skilled developers designing with TI products. You are solely responsible for (1) selecting the appropriate TI products for your application, (2) designing, validating and testing your application, and (3) ensuring your application meets applicable standards, and any other safety, security, regulatory or other requirements.

These resources are subject to change without notice. TI grants you permission to use these resources only for development of an application that uses the TI products described in the resource. Other reproduction and display of these resources is prohibited. No license is granted to any other TI intellectual property right or to any third party intellectual property right. TI disclaims responsibility for, and you will fully indemnify TI and its representatives against, any claims, damages, costs, losses, and liabilities arising out of your use of these resources.

TI's products are provided subject to [TI's Terms of Sale](#) or other applicable terms available either on [ti.com](http://ti.com) or provided in conjunction with such TI products. TI's provision of these resources does not expand or otherwise alter TI's applicable warranties or warranty disclaimers for TI products.

TI objects to and rejects any additional or different terms you may have proposed.

Mailing Address: Texas Instruments, Post Office Box 655303, Dallas, Texas 75265  
Copyright © 2022, Texas Instruments Incorporated