

# The Common LED Display Challenges in Narrow Pixel Pitch Matrix LED Display



Monet Xu, Wu Yang

## ABSTRACT

Currently, the resolution and pixel density of the Matrix LED Display is getting higher and higher, LED display meets several challenges that affect the display performance. This application note summarizes the common issues in narrow pixel pitch (NPP) Matrix LED display and explains the root causes accordingly.

## Table of Contents

<b>1 Introduction</b> .....	2
<b>2 Common issues in NPP Matrix LED Panel</b> .....	2
2.1 Ghosting.....	2
2.2 Non-Uniformity in Low Gray Scale.....	4
2.3 Coupling.....	5
2.4 Caterpillar.....	7
2.5 Color Shift in Low Gray Scale.....	9
2.6 Gray Scale Gradient Discontinuity Issue.....	9
2.7 First Scan Line Dim.....	10
<b>3 Summary</b> .....	11
<b>4 References</b> .....	12

## List of Figures

Figure 2-1. Upside-ghosting.....	2
Figure 2-2. Downside-ghosting.....	2
Figure 2-3. Upside Ghosting – 1.....	3
Figure 2-4. Upsides Ghosting – 2.....	3
Figure 2-5. Downside Ghosting – 1.....	4
Figure 2-6. Downside Ghosting – 2.....	4
Figure 2-7. Non-Uniformity in Low Gray Scale.....	5
Figure 2-8. Brighter Coupling – 1.....	6
Figure 2-9. Brighter Coupling – 2.....	6
Figure 2-10. Darker Coupling.....	6
Figure 2-11. LOD Caterpillar Issue.....	7
Figure 2-12. LSD Caterpillar Issue.....	8
Figure 2-13. Color Shift in Low Gray Scale.....	9
Figure 2-14. Gray Scale Gradient Discontinuity Issue.....	9
Figure 2-15. First Line Dim Issue.....	10

## Trademarks

All trademarks are the property of their respective owners.

## 1 Introduction

With the pixel density getting higher in narrow pixel pitch (NPP) LED Display or Mini and Micro-LED products, the display performance is becoming a critical challenge. In narrow pixel pitch Matrix LED display, common issues including ghosting, non-uniformity in low gray scale, coupling between black/low brightness/high brightness, caterpillar caused by open LED or short LED, and first scan line dim and so on, highly influence the display performance. This application note describes the details about these issues and explains the root causes accordingly based on common cathode matrix LED display.

## 2 Common issues in NPP Matrix LED Panel

### 2.1 Ghosting

Ghosting is a common issue in NPP LED display applications. Ghosting effect means some LED are lighted up when they do not need to be lighted. The ghosting effect is even more pronounced using the left or right slash grid test pattern. Generally, there are two kinds of ghosting, upside ghosting and downside ghosting shown in [Figure 2-1](#) and [Figure 2-2](#).

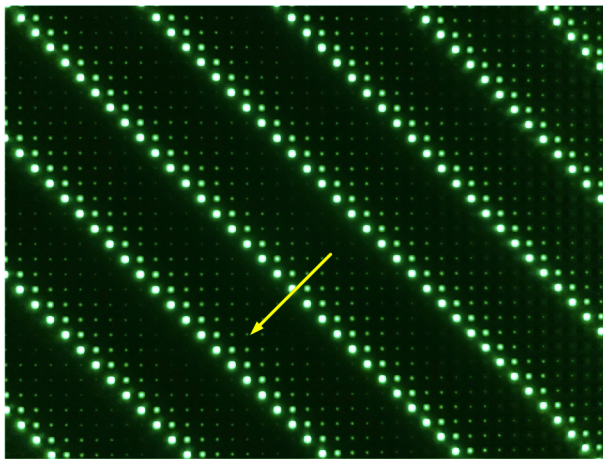

**Figure 2-1. Upside-ghosting**

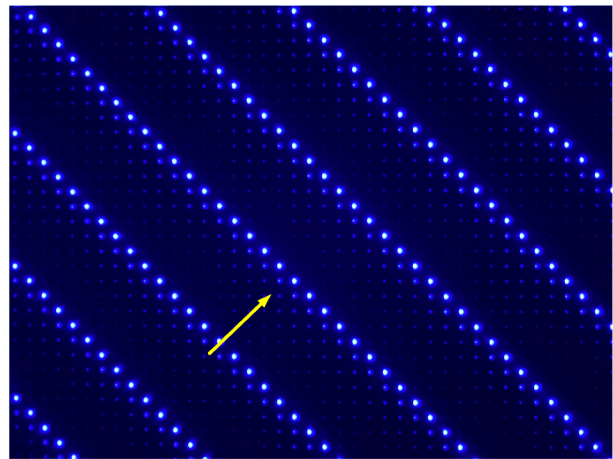

**Figure 2-2. Downside-ghosting**

The main cause of upside ghosting is the built up charge in the parasitic capacitance on SW<sub>n</sub> when transitioning between scan lines, the parasitic capacitance is charged through the LED causing it to light up when it does not need to be lighted.

[Figure 2-3](#) and [Figure 2-4](#) shows an example of upside ghosting. During the SW<sub>0</sub> turning on, channel 2 outputs current and LED<sub>02</sub> is light up. After line switch time, the SW<sub>1</sub> turning on, channel 1 outputs current and LED<sub>11</sub> is light up. Meantime, the SW<sub>0</sub> scan line voltage still keeps low and when the SW<sub>1</sub> scan line fully turns on, the channel 1 current may flow through LED<sub>01</sub> to the previous scan line causing LED<sub>01</sub> to illuminate unexpectedly.

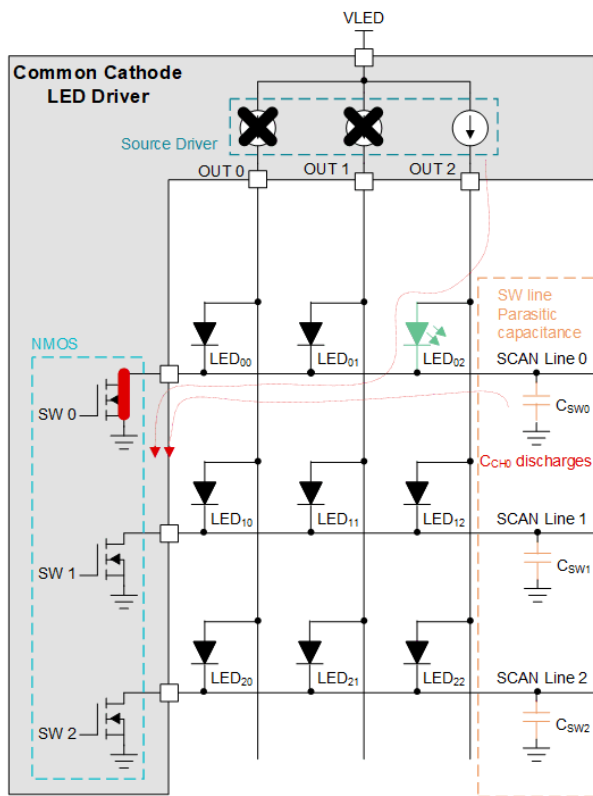

P1: SW0 ON, LED<sub>02</sub> light up. ➔ Lighted LED

Figure 2-3. Upside Ghosting – 1

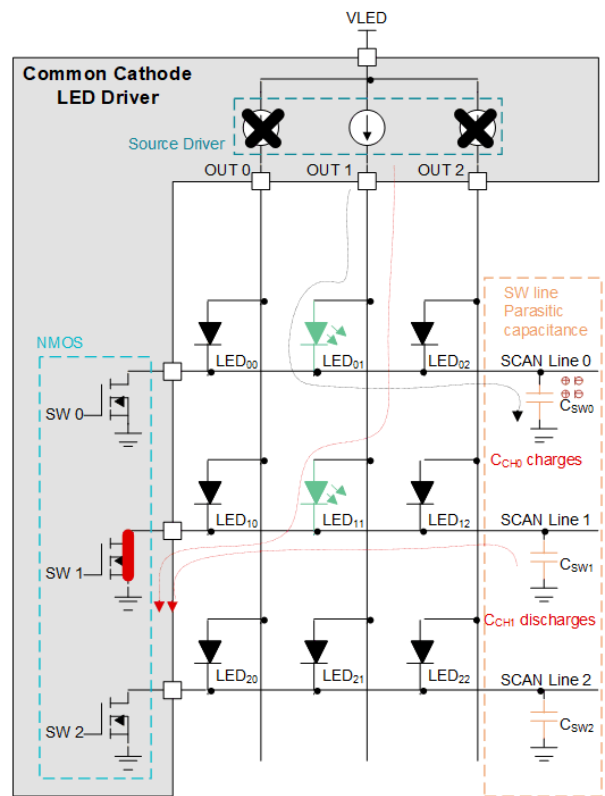

P2: SW1 ON, LED<sub>11</sub> light up, LED<sub>11</sub> slightly light up.

Figure 2-4. Upsides Ghosting – 2

The main cause of downside ghosting is the built up charge in the parasitic capacitance on OUT<sub>n</sub> when transitioning between scan lines, the charge on the parasitic capacitance will discharge through the LED causing it to light up when it does not need to not be lighted.

Figure 2-5 and Figure 2-6 shows how downside ghosting happens. During the SW<sub>0</sub> turning on, channel 2 output current and LED<sub>02</sub> is lit up. After line switch time, the SW<sub>1</sub> turning on, channel 1 output current and LED<sub>11</sub> is lit up. Meantime, the LED<sub>12</sub> lights up slightly which is called downside ghosting issue. Since the built up charge in the parasitic capacitance on OUT<sub>2</sub> discharges when line switch transition from SW<sub>0</sub> to SW<sub>1</sub>.

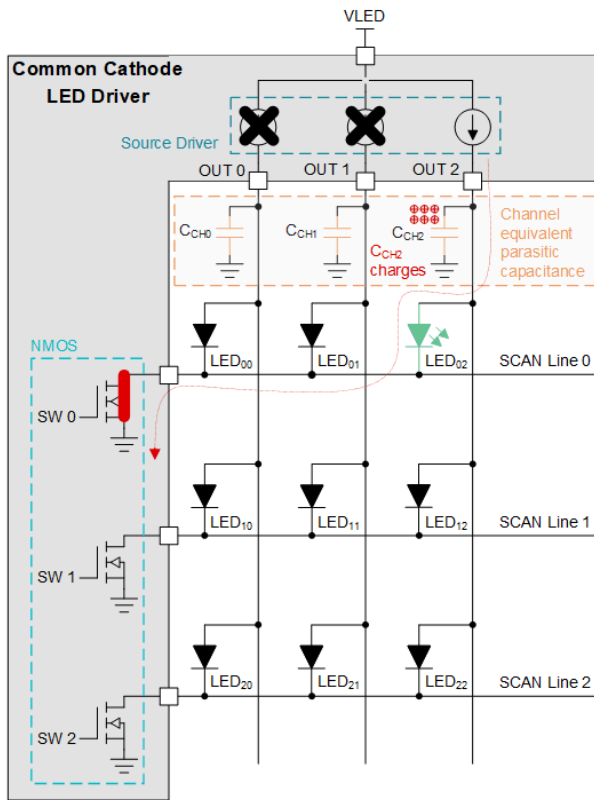

P1: SW0 ON, LED<sub>02</sub> light up.

Figure 2-5. Downside Ghosting – 1

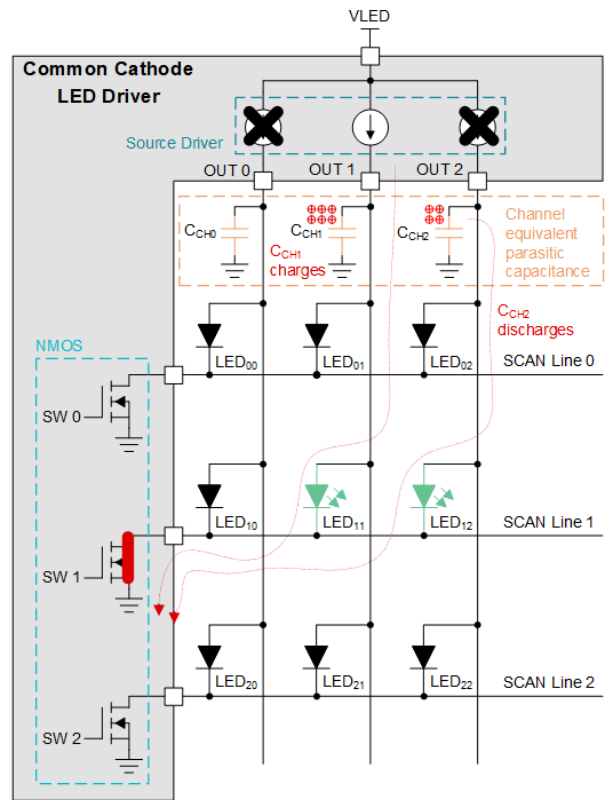

P2: SW1 ON, LED<sub>11</sub> light up, LED<sub>12</sub> slightly light up.

Figure 2-6. Downside Ghosting – 2

## 2.2 Non-Uniformity in Low Gray Scale

Currently, the narrow pixel pitch (NPP) LED Display or Mini and Micro-LED products are generally for indoor application, especially the emerging of LED Wall, micro TV, small VIP cinema. These applications need the LED screen can achieve the ultra-low luminance designed for the dark surroundings.

Because human eyes are very sensitive in ultra-low brightness, the small brightness difference on LEDs is captured in this circumstance, so from LED drivers' point of view, low current accuracy from channel to channel and from device to device will cause non-uniformity on low gray scale by column or matrix. In addition, When the turning-on pulse is getting smaller, the transient accuracy becomes another key issue. The transient current difference is mainly caused by the deviation of LEDs, such as forward voltage, parasitic capacitor.

Figure 2-7 shows the non-uniformity of NPP LED display in low gray scale.

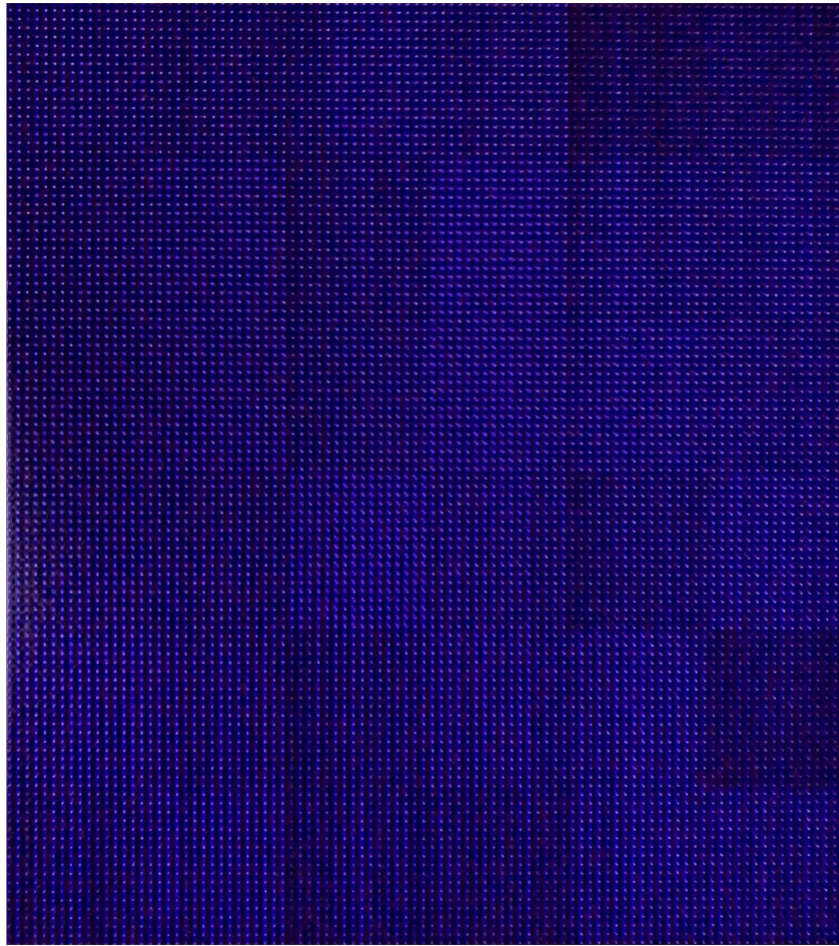

**Figure 2-7. Non-Uniformity in Low Gray Scale**

## 2.3 Coupling

Coupling is one of the critical challenges for display performance and it includes many types due to different causes. This topic will describe two most common types of coupling issues.

As mentioned above, since the human's eyes are very sensitive in ultra-low brightness, both the small brightness and color temperature difference on pixels will be captured, especially on the application based on time-multiplexing driving technology and All-in-one technology. The channels connected to the same lines will interplay when they don't turn on or turn off at the same time since the parasitic capacitor of LEDs, PCB and so on.

[Figure 2-8](#) shows one type of brighter coupling, the black area A is lighted coupled by area B. [Figure 2-9](#) shows another type of brighter coupling, the bright horizontal grid lines in area D couples the corresponding lines in area C to be brighter than other lines, such as area E.



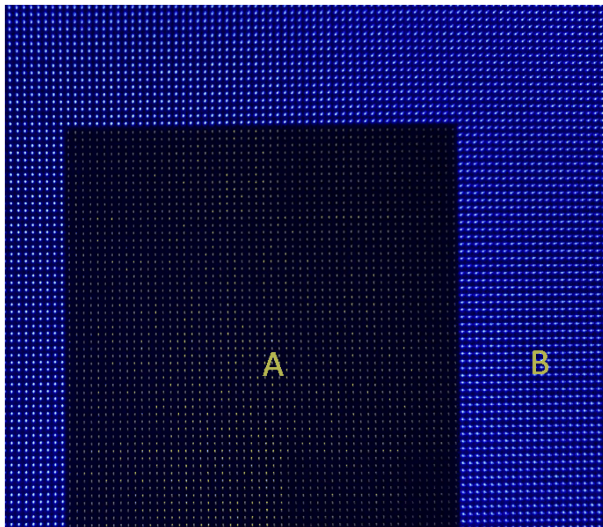

Figure 2-8. Brighter Coupling – 1

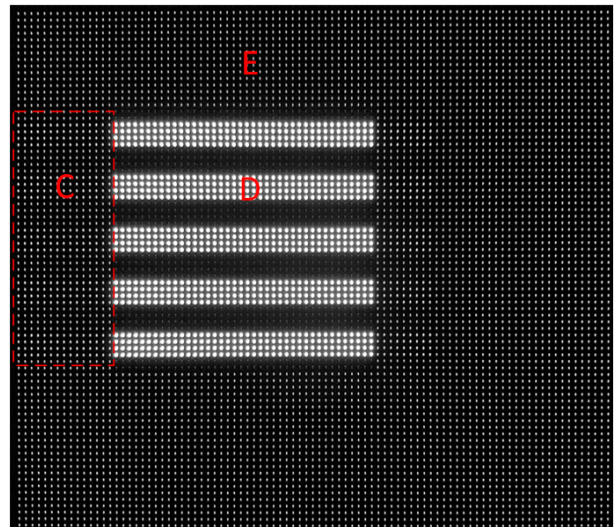

Figure 2-9. Brighter Coupling – 2

Figure 2-10 shows the darker coupling, the dark area A couples area B to be darker than other lines, such as area C.

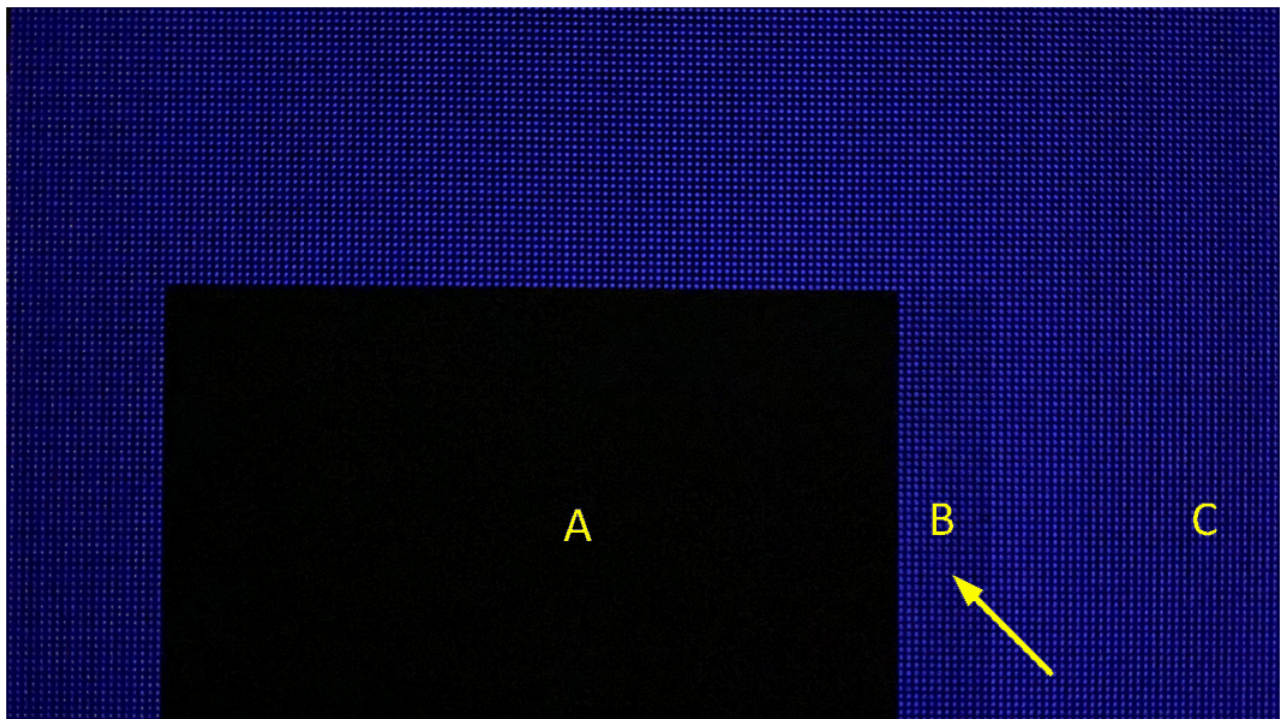

Figure 2-10. Darker Coupling

## 2.4 Caterpillar

Figure 2-11 shows the LOD caterpillar issue, suppose the LED<sub>11</sub> is an opened LED, when scans to the line0 and the OUT1 is turned on, the OUT1 voltage is forced to approach to V<sub>LED</sub> because of the broken path of the current source. However, if the difference between V<sub>OUT1</sub> and V<sub>line</sub> is larger than the LED forward voltage, it will cause all LEDs connecting to the channel OUT1 light unwanted.

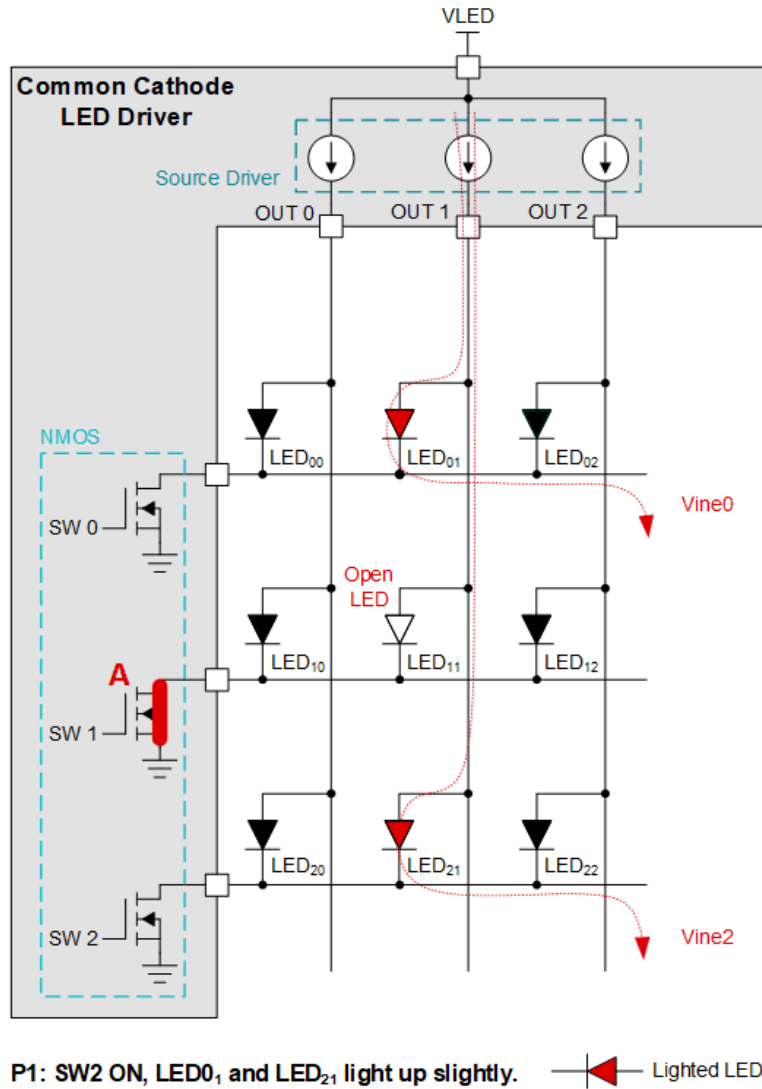
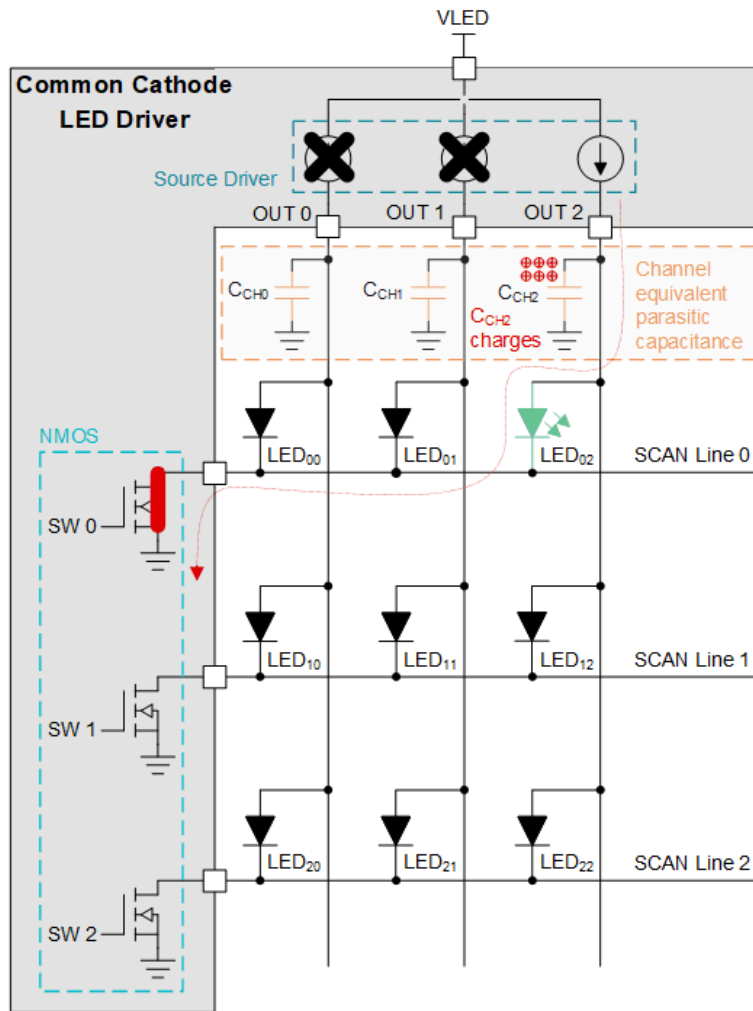

Figure 2-11. LOD Caterpillar Issue

Figure 2-12 shows the LSD caterpillar issue, suppose the LED<sub>11</sub> is a short LED, when scans to the line2 and the OUT1 is turned off, the OUT1 voltage is the same with scan line0 voltage because of the short path of the LED<sub>01</sub>, at this time, there is a current path from the line1 to the GND through the LED<sub>11</sub> and SW<sub>2</sub>, which causes LED<sub>21</sub> light unwanted.



**P1: SW0 ON, LED<sub>02</sub> light up.**

**Figure 2-12. LSD Caterpillar Issue**



## 2.5 Color Shift in Low Gray Scale

White balance has a big impact on the tone of the display so it is important to keep the same white balance in different brightness at the same configuration. [Figure 2-13](#) shows the color shift which is easily captured in in ultra-low brightness. the difference in parasitic capacitance between lamps of different colors is the main reason. Generally the Blue LED has much more parasitic capacitance than the red LED.

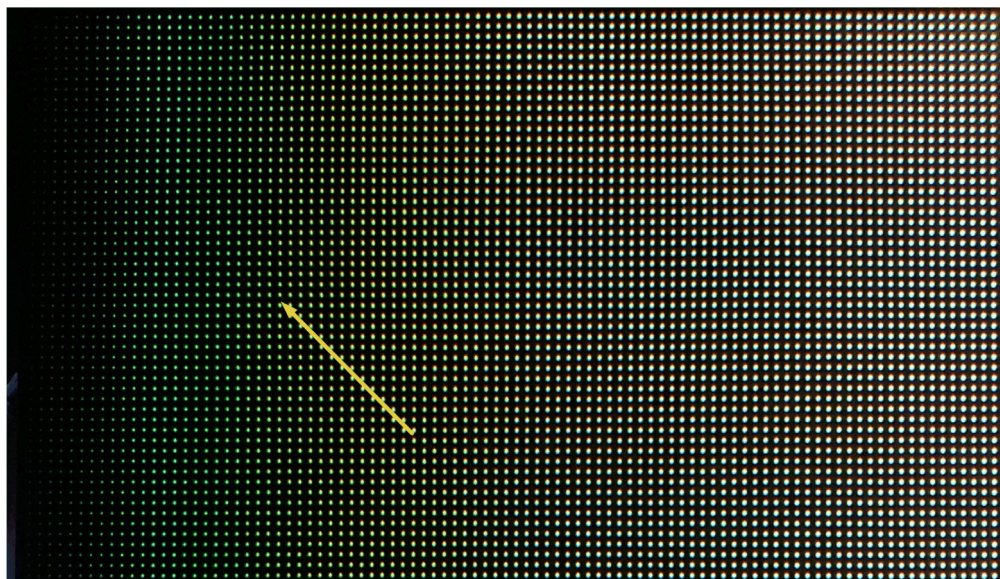

Figure 2-13. Color Shift in Low Gray Scale

## 2.6 Gray Scale Gradient Discontinuity Issue

The ability of gradient smoothness has a huge impact on the display performance, especially in low brightness. Gradient smoothness determines the vividness and smoothness of the animation. The main reason is similar to the cause of non-uniformity in low gray scale. [Figure 2-14](#) shows the blue gray scale gradient discontinuity issue in low brightness.

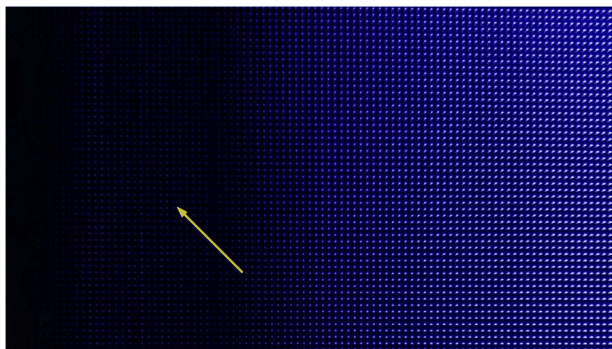
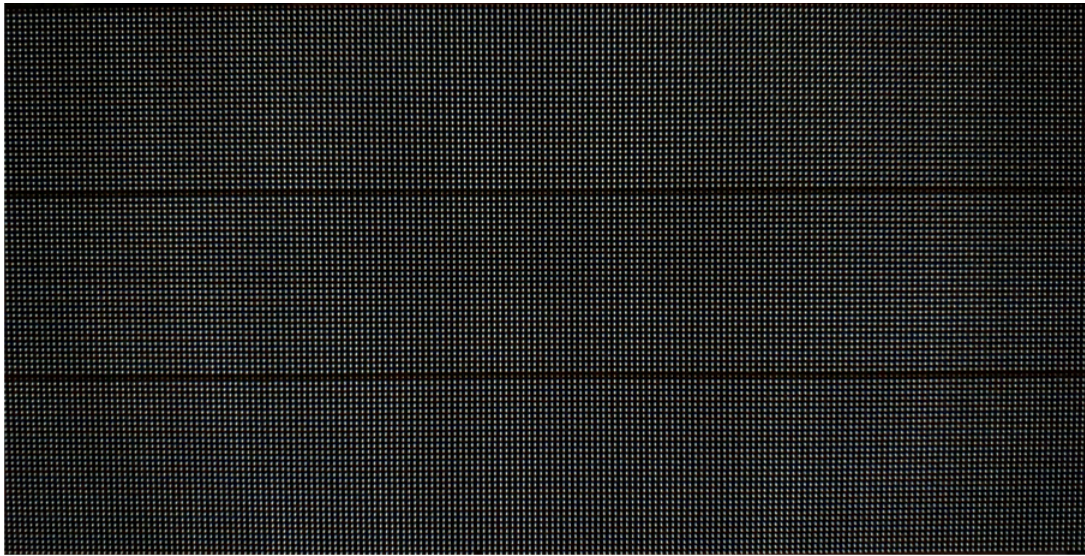

Figure 2-14. Gray Scale Gradient Discontinuity Issue

## 2.7 First Scan Line Dim

Figure 2-15 shows the first scan line dim issue. In ultra-low illumination the first line of each stackable led matrix will be darker than other lines. The voltage of un-conducted line is forced to float with the turn-on OUTx. Since the uncertainly starting voltage of first line, whose voltage can be higher or lower than other lines, causing the first line of every multiplexing is darker comparing to other lines.



**Figure 2-15. First Line Dim Issue**

### 3 Summary

This application note introduces seven critical challenges in narrow pixel pitch (NPP) LED Display or Mini and Micro-LED products.

## 4 References

- Texas Instruments, [TLC6984 48 x 16 Common Cathode Matrix LED Display Driver Evaluation Module](#).
- Texas Instruments, [TLC6983 48 x 16 Common Cathode Matrix LED Display Driver Evaluation Module](#).



## IMPORTANT NOTICE AND DISCLAIMER

TI PROVIDES TECHNICAL AND RELIABILITY DATA (INCLUDING DATA SHEETS), DESIGN RESOURCES (INCLUDING REFERENCE DESIGNS), APPLICATION OR OTHER DESIGN ADVICE, WEB TOOLS, SAFETY INFORMATION, AND OTHER RESOURCES "AS IS" AND WITH ALL FAULTS, AND DISCLAIMS ALL WARRANTIES, EXPRESS AND IMPLIED, INCLUDING WITHOUT LIMITATION ANY IMPLIED WARRANTIES OF MERCHANTABILITY, FITNESS FOR A PARTICULAR PURPOSE OR NON-INFRINGEMENT OF THIRD PARTY INTELLECTUAL PROPERTY RIGHTS.

These resources are intended for skilled developers designing with TI products. You are solely responsible for (1) selecting the appropriate TI products for your application, (2) designing, validating and testing your application, and (3) ensuring your application meets applicable standards, and any other safety, security, regulatory or other requirements.

These resources are subject to change without notice. TI grants you permission to use these resources only for development of an application that uses the TI products described in the resource. Other reproduction and display of these resources is prohibited. No license is granted to any other TI intellectual property right or to any third party intellectual property right. TI disclaims responsibility for, and you will fully indemnify TI and its representatives against, any claims, damages, costs, losses, and liabilities arising out of your use of these resources.

TI's products are provided subject to [TI's Terms of Sale](#) or other applicable terms available either on [ti.com](https://www.ti.com) or provided in conjunction with such TI products. TI's provision of these resources does not expand or otherwise alter TI's applicable warranties or warranty disclaimers for TI products.

TI objects to and rejects any additional or different terms you may have proposed.

Mailing Address: Texas Instruments, Post Office Box 655303, Dallas, Texas 75265  
Copyright © 2023, Texas Instruments Incorporated