

Using the TPS548A29EVM-023 15-A, Buck Converter Evaluation Module

This user's guide contains information for the TPS548A29EVM-023 evaluation module (EVM) as well as for the TPS548A29 DC/DC converter. Also included are the performance specifications, the schematic, and the list of materials for the TPS548A29EVM.

Contents

1	Introduction	2
	1.1 Background	2
	1.2 Performance Specification Summary	3
	1.3 Modifications.....	3
2	Test Setup and Results	5
	2.1 Input/Output Connections.....	5
	2.2 Start Up Procedure	5
	2.3 Efficiency.....	6
	2.4 Load Regulation.....	8
	2.5 Line Regulation	8
	2.6 Load Transients	10
	2.7 Loop Characteristics	10
	2.8 Output Voltage Ripple	12
	2.9 Powering Up	13
	2.10 Start-Up Into Pre-Bias	14
3	Schematic, List of Materials, and Layout.....	15
	3.1 Schematic	16
	3.2 List of Materials.....	17
	3.3 Layout.....	17

List of Figures

1	Safety Warnings	2
2	TPS548A29 Efficiency Plot: Vin Range.....	6
3	TPS548A29 Efficiency Plot: Vcc Range	6
4	TPS548A29 Efficiency Plot: Skip Mode	7
5	TPS548A29 Efficiency Plot: FCCM and Skip Mode.....	7
6	TPS548A29 Load Regulation	8
7	TPS548A29 Load Regulation	8
8	TPS548A29 Line Regulation	9
9	TPS548A28 Load Transient Response	10
10	TPS548A28 Load Transient Response	10
11	TPS548A29 Bode Plot.....	11
12	TPS548A29 Output Ripple, No Load.....	12
13	TPS548A29 Output Ripple, 15-A Load.....	12
14	TPS548A29 Output Ripple, Skip Mode, 10mA Load	12
15	TPS548A29 Enable Start-Up, 15A Load	13
16	TPS548A29 Start-Up Into Pre-Bias, 1-A Load	14

17 TPS548A29 Power Down Into Pre-Bias, 1-A Load 14

18 TPS548A29EVM Top-Side Layout..... 19

19 TPS548A29EVM Internal Layer-1 Layout..... 19

20 TPS548A29EVM Internal Layer-2 Layout..... 20

21 TPS548A29EVM Bottom-Side Layout..... 20

List of Tables

1 Input Voltage and Output Current Summary 2

2 TPS548A29EVM Performance Specification Summary 3

3 TPS548A29EVM Mode Pin Selection..... 3

4 Enable Pin Selection 4

5 TPS548A29EVM EVM Connectors and Test Points 5

6 TPS548A29EVM List of Materials..... 17

Trademarks

D-CAP3 is a trademark of Texas Instruments.

1 Introduction

The TPS548A29 is a D-CAP3™ synchronous buck converter designed for 15 A output current, and the evaluation module is designed to demonstrate the small printed-circuit-board areas that may be achieved when designing with the device. The high-side and low-side switching MOSFETs are integrated in the device package along with their gate drive circuitry. Rated input voltage and output current ranges for the evaluation module are given in [Table 1](#).

1.1 Background

The EVM is setup to allow the user to evaluate the performance of the TPS548A29 IC, and easily make changes to multiple settings. The low drain-to-source on resistance of the MOSFETs allows the device to achieve high efficiencies and keep the junction temperature low at high output currents. There is no need for external compensation components since this device is designed with D-CAP3™ control topology. On the EVM the switching frequency and the operation mode are externally selectable using a jumper to set the resistor from the MODE pin to AGND. An external resistor divider allows for an adjustable output voltage. Additionally, the device provides adjustable soft start, adjustable OC limit threshold, external reference input, and an open-drain power good indicator. Lastly the TPS548A29 device has a fixed internal VIN under voltage lockout and externally adjustable UVLO using a resistor divider at the EN pin.

Table 1. Input Voltage and Output Current Summary

EVM	INPUT VOLTAGE RANGE	OUTPUT CURRENT RANGE
TPS548A29	$V_{IN} = 3\text{ V to }16\text{ V}$	0 A to 15 A

CAUTION:



Hot surface. Contact may cause burns. Do not touch.

Figure 1. Safety Warnings

1.2 Performance Specification Summary

A summary of the TPS548A29EVM performance specifications is provided in [Table 2](#). Specifications are given for an input voltage of $V_{IN} = 12\text{ V}$ and an output voltage of 2.5 V , unless otherwise specified. The TPS548A29EVM is designed and tested for $V_{IN} = 4\text{ V}$ to 16 V . The ambient temperature is 25°C for all measurements, unless otherwise noted.

Table 2. TPS548A29EVM Performance Specification Summary

SPECIFICATION	TEST CONDITIONS	MIN	TYP	MAX	Unit
V_{IN} voltage range (without internal Bias)		4	12	16	V
V_{IN} voltage range (with external Bias)		2.7	12	16	V
Output voltage setpoint			2.5		V
Output current range	$V_{IN} = 4\text{ V}$ to 16 V	0	15	15	A
Internal LDO Voltage			4.5		V
Line regulation	$V_{IN} = 4\text{ V}$ to 16 V , $I_O = 15\text{ A}$		+/- 0.07%		
Load regulation	$V_{IN} = 12\text{ V}$, $I_O = 0\text{ A}$ to 15 A		+/- 0.12%		
Operating frequency		600	800	1000	kHz

1.3 Modifications

These evaluation modules are designed to provide access to the features of the TPS548A29. Some modifications can be made to this module.

1.3.1 Output Voltage Setpoint

To change the output voltage of the EVM, it is necessary to change the value of resistor R6 and R7. R9 is fixed at $10\text{ k}\Omega$. Changing the total value of R6 plus R7 can change the output voltage above the 0.6 V reference voltage V_{INTREF} . A two resistor configuration of R6+R7 is implemented to give the exact desired output voltage setting. The value of R6 and R7 for a specific output voltage can be calculated using [Equation 1](#).

$$R_{FB_HS} = \frac{V_O - V_{INTREF}}{V_{INTREF}} \times R_{FB_LS} \quad (1)$$

$$V_{INTREF} = 0.6\text{ V}$$

$$R_{FB_HS} = R_6 + R_7$$

$$R_{FB_LS} = R_9 = 10\text{ k}\Omega$$

1.3.2 Frequency and Operation Mode Setting

To change the frequency and operation mode of the part, the MODE pin is used. J6 and the surrounding circuitry allows for an easy change to the frequency and operation mode setting. All 6 options offered by J6 are shown in [Table 3](#)

Table 3. TPS548A29EVM Mode Pin Selection

Switching Frequency (F_{sw})	Operation Mode Under Light Load	Mode Pin Connections	
		Connection	Jumper Setting
600 kHz	Skip Mode	Short to VCC	Short Pins 1 and 2
800 kHz	Skip Mode	$243\text{ k}\Omega \pm 10\%$ to AGND	Short Pins 3 and 4
1000 kHz	Skip Mode	$121\text{ k}\Omega \pm 10\%$ to AGND	Short Pins 5 and 6
1000 kHz	Forced CCM	$60.4\text{ k}\Omega \pm 10\%$ to AGND	Short Pins 7 and 8
800 kHz	Forced CCM	$30.1\text{ k}\Omega \pm 10\%$ to AGND	Short Pins 9 and 10
600 kHz	Forced CCM	Short to AGND	Short Pins 11 and 12

1.3.3 Enable Pin Selection

The converter can be enabled and disabled by J5.
Default setting: EN pin connected to VIN.

Table 4. Enable Pin Selection

Set On Connection	Enable Selection
Pins 2-3 Shorted	EN pin connected to VIN pins through resistor divider
J3 Open	EN pin is left floating
Pins 1-2 Shorted	EN pin connected to PGND

1.3.4 Remote Sensing

The EVM is not set-up for remote sensing by default. To set up remote sensing follow these steps:

1. Replace R8 and R11 with 100Ω resistors
2. Connect your sense points to the Vsns+ and Vsns- test points

1.3.5 Adjustable UVLO

The undervoltage lockout (UVLO) can be adjusted externally using R2 and R9. See the TPS548A29 Data Sheet to get detailed instructions for setting the external UVLO.

2 Test Setup and Results

This section describes how to properly connect, set up, and use the TPS548A29EVM. This section also includes test results typical for the evaluation module and covers efficiency, output voltage regulation, load transient, loop response, output ripple, start-up, and current limit modes.

2.1 Input/Output Connections

The TPS548A29EVM is provided with input/output connectors and test points as shown in [Table 5](#). A power supply capable of supplying greater than 15 A must be connected to J1 and J2 through a pair of 20-AWG wires or better. The load must be connected to J3 and J4 through a pair of 20-AWG wires or better on each connector. The maximum load current capability is 15 A.

Wire lengths must be minimized to reduce losses in the wires. Test point VIN_SENSE+ provides a place to monitor the input voltage with Test point VIN_SENSE- providing a convenient ground reference. Test point VOUT+ is used to monitor the output voltage with VOUT- as the ground reference.

Table 5. TPS548A29EVM EVM Connectors and Test Points

REFERENCE DESIGNATOR	FUNCTION
J1	VIN input voltage connector (see Table 1 for V_{IN} range)
J2	PGND connection for input
J3	VOUT, 2.5V at 15A maximum
J4	PGND connection for output
J5	3-pin header for enable. ON -> Connects EN to VIN to enable the device. OFF- > Connects EN to GND to disable device. Floating EN will prevent the part from operating.
J6	12 Pin header for Mode selection (see Table 3)
VIN_SENSE+, VIN_SENSE-	VIN voltage sensing test points
VOUT+, VOUT-	VOUT voltage sensing test points
VCC, PGND	VCC voltage forcing/sensing test points
PGOOD	PGOOD output test point (pulled up to VCC pin through a 30k Ω resistor)
EN	EN test point
VSNS+, VSNS-	Remote sensing test points
AGND	AGND test point
BODE+, BODE-	Loop measurement test points (BODE+ is at the same net as VOUT, but is closer to FB divider and IC)
SS/REFIN	Can be used to monitor the reference voltage
SW	Switch Node test point

2.2 Start Up Procedure

1. Make sure the EN jumper (J5) is in the ON position (shorting pin 2 and pin 3) to connect the EN pin to the resistor divider from VIN.
2. (Optional) Apply appropriate external bias voltage on VCC and PGND test points. If no external bias, please go directly to step 3. The external bias range is 3.3V to 5.3V.
3. Apply appropriate VIN voltage to the VIN and PGND terminals at J1 and J2.

2.3 Efficiency

The efficiency of this EVM peaks at a load current of about 6 A and then decreases as the load current increases toward full load. The Below Images show the efficiency for the TPS548A29EVM at an ambient temperature of 25°C. shows the Efficiency over a range of Vin values, shows efficiency over a range of Vcc values, and shows how the light load efficiency is improved in DCM. and compare the efficiency of FCCM and Skip modes.

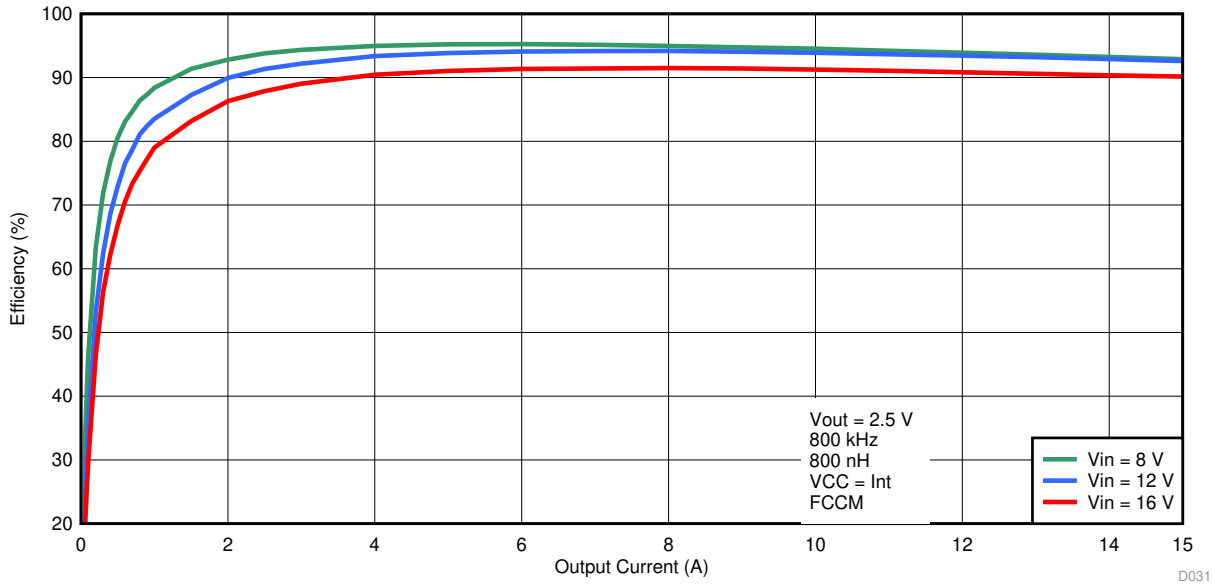

Figure 2. TPS548A29 Efficiency Plot: Vin Range

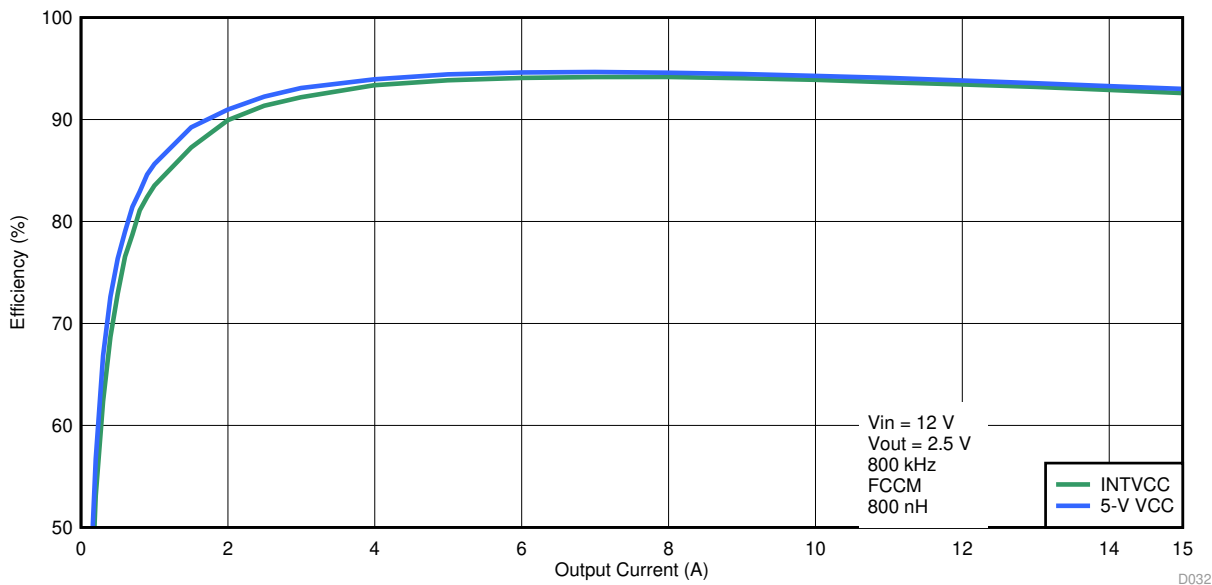

Figure 3. TPS548A29 Efficiency Plot: Vcc Range

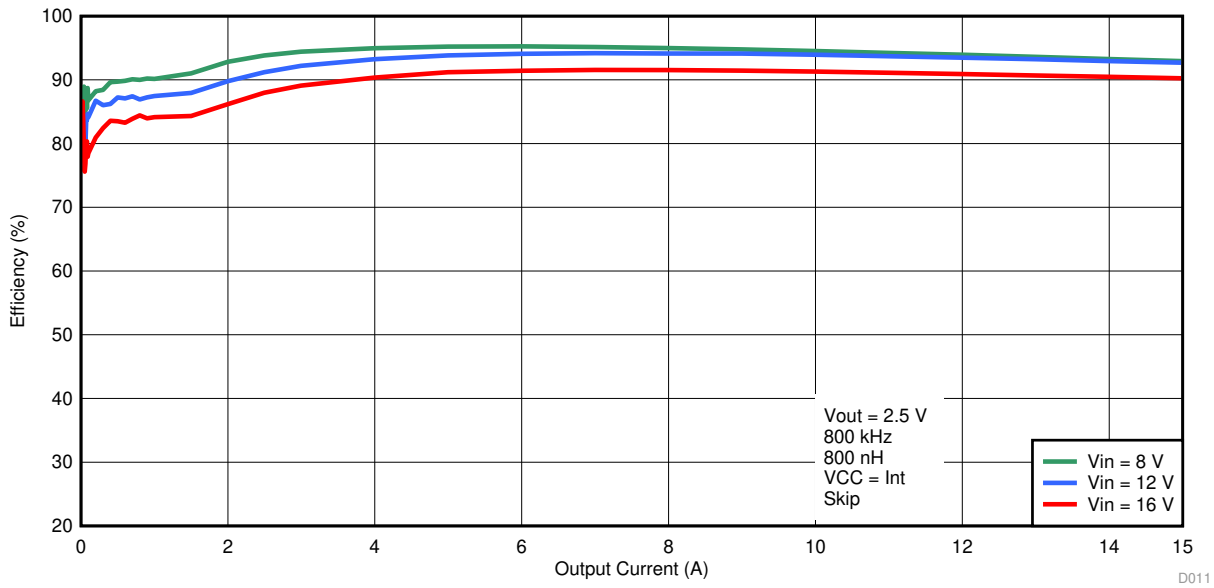

Figure 4. TPS548A29 Efficiency Plot: Skip Mode

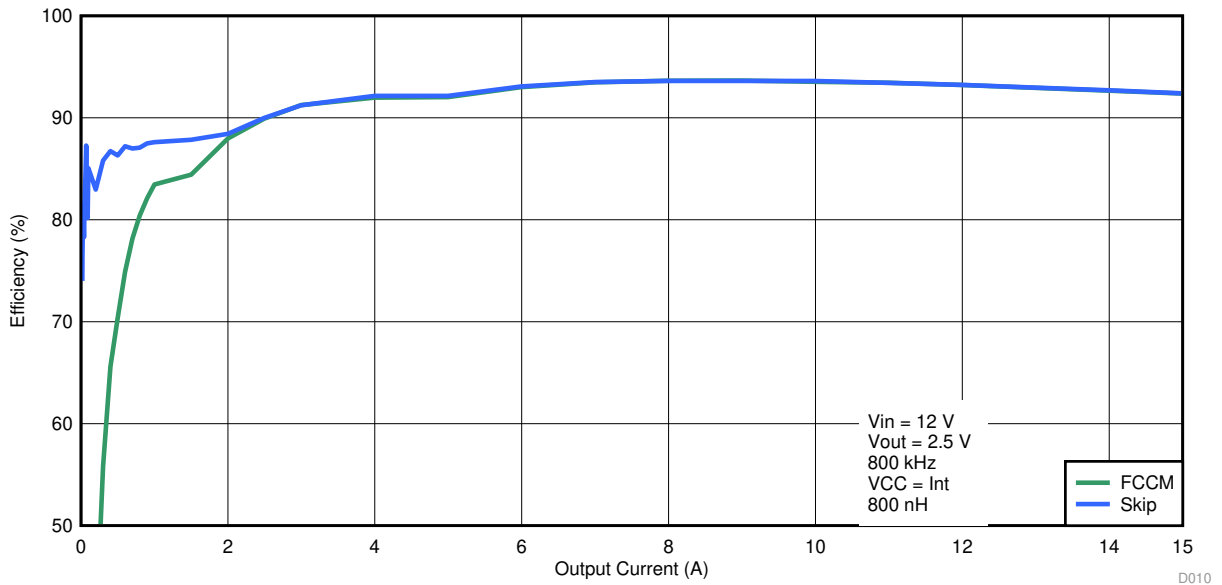

Figure 5. TPS548A29 Efficiency Plot: FCCM and Skip Mode

2.4 Load Regulation

and show the load regulation for the TPS548A29EVM.

Measurements are given for an ambient temperature of 25°C.

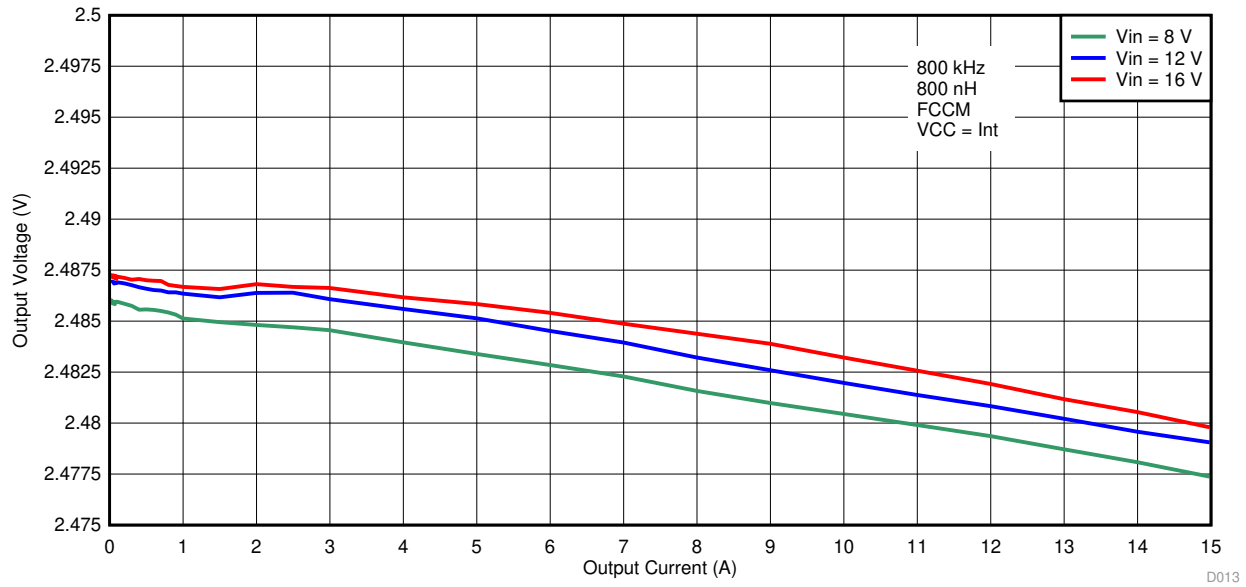

Figure 6. TPS548A29 Load Regulation

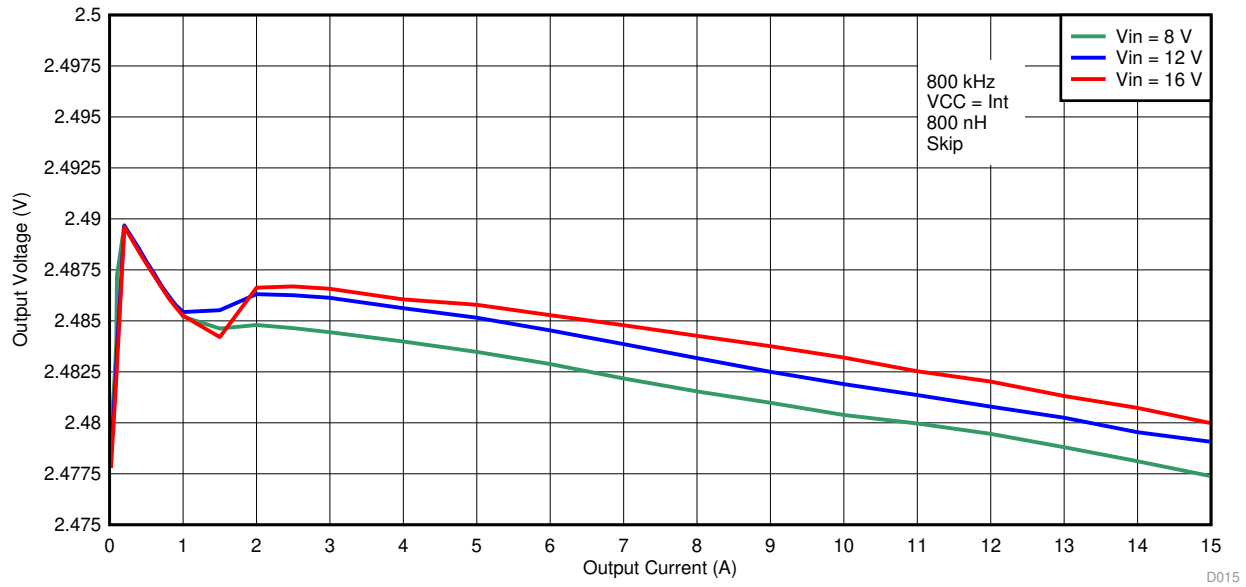

Figure 7. TPS548A29 Load Regulation

2.5 Line Regulation

shows the line regulation for the TPS548A29EVM.

Measurements are given for an ambient temperature of 25°C.

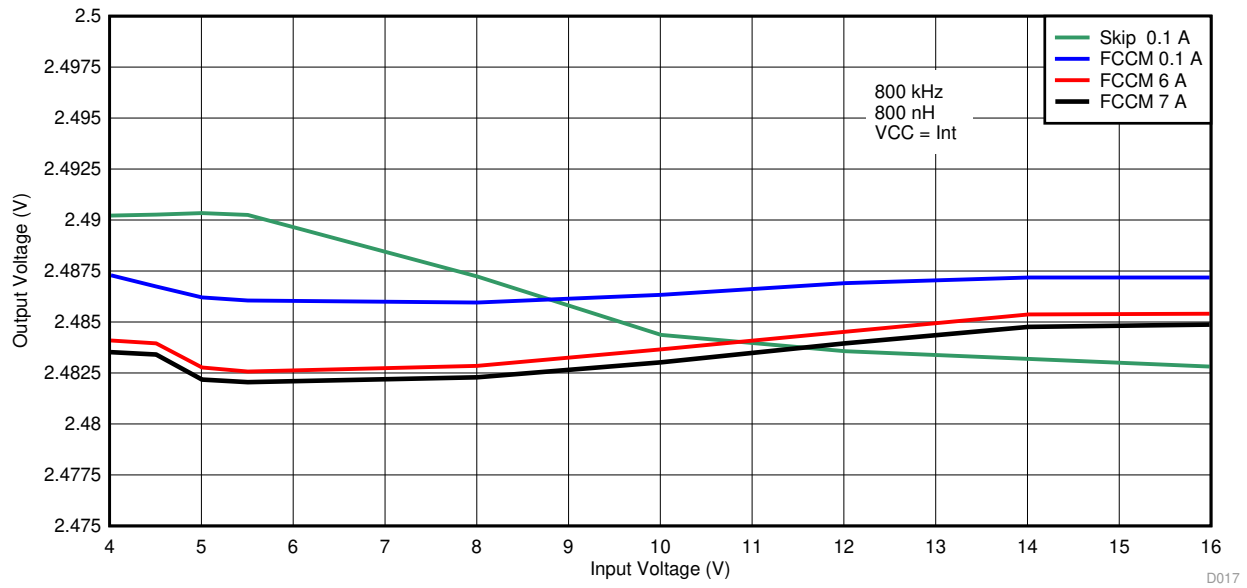

Figure 8. TPS548A29 Line Regulation

2.6 Load Transients

and show how the TPS548A29EVM response to load transients. The current step is from 25% to 75% Load. The current step slew rate is 2 A/ μ s. Total peak-to-peak voltage variation is as shown, including ripple and noise on the output.

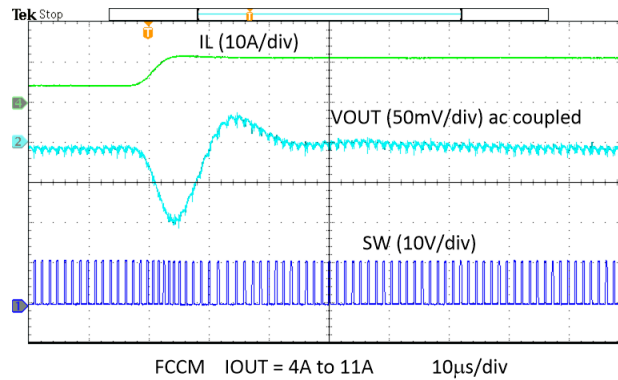

Figure 9. TPS548A28 Load Transient Response

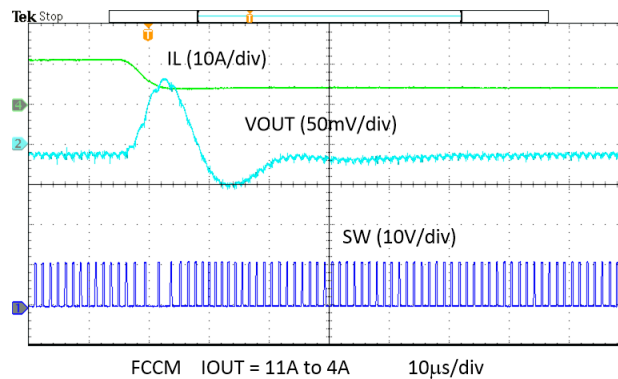

Figure 10. TPS548A28 Load Transient Response

2.7 Loop Characteristics

shows the TPS548A29EVM loop-response characteristics. Gain and phase plots are shown for V_{IN} voltage of 12 V. Load current for the measurement is 100%.

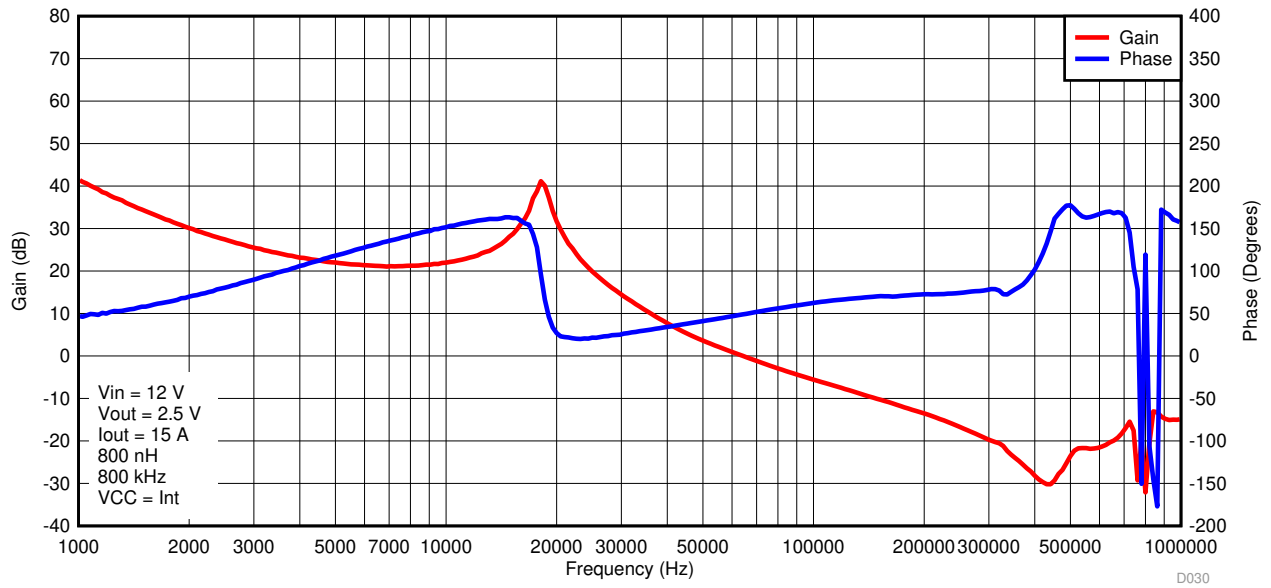

Figure 11. TPS548A29 Bode Plot

2.8 Output Voltage Ripple

, , and shows the TPS548A29EVM output voltage ripple. $V_{IN} = 12\text{ V}$. The ripple voltage is measured directly across the last ceramic output capacitor.

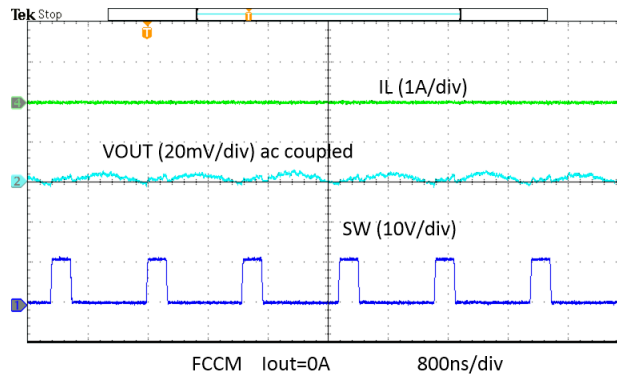

Figure 12. TPS548A29 Output Ripple, No Load

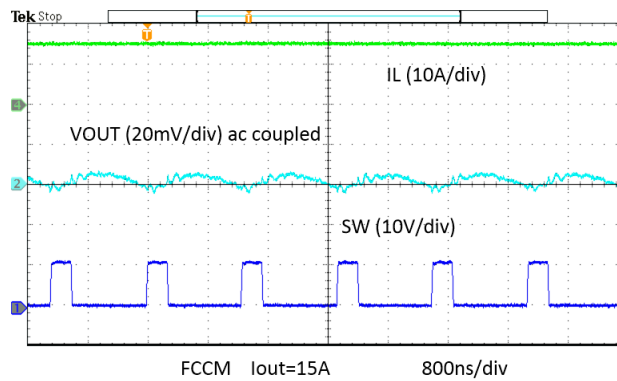

Figure 13. TPS548A29 Output Ripple, 15-A Load

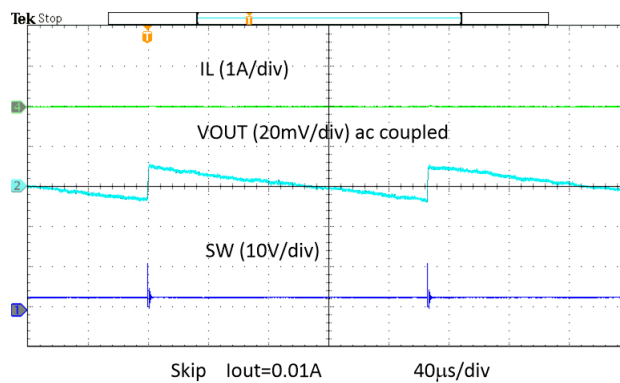

Figure 14. TPS548A29 Output Ripple, Skip Mode, 10mA Load

2.9 Powering Up

shows the start-up waveforms for the TPS548A29EVM. In , the start-up sequence begins as soon as the EN voltage is increased above the enable-threshold voltage, and the output voltage ramps up to the externally set value of 2.5 V. The input voltage for these plots is 12 V.

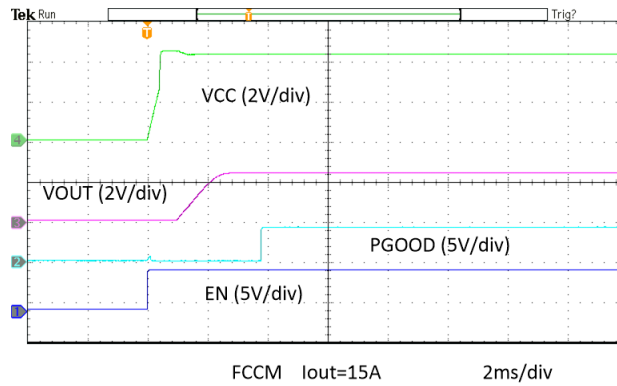

Figure 15. TPS548A29 Enable Start-Up, 15A Load

2.9.1 Powering Down

shows the TPS548A29EVM shutdown. The input voltage for these plots is 12 V.

2.10 Start-Up Into Pre-Bias

and show the TPS548A29EVM starting up into a pre-biased output. The output voltage is pre-biased to ~50% of V_{OUT} .

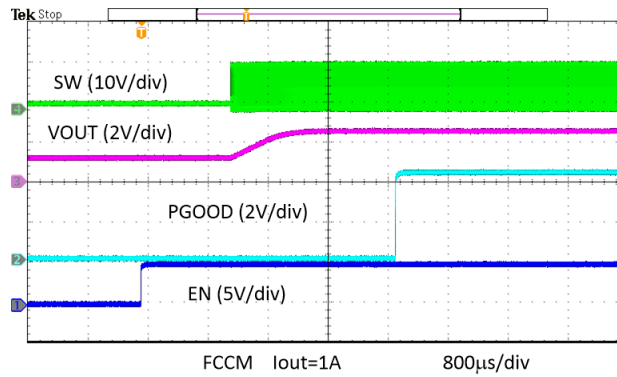

Figure 16. TPS548A29 Start-Up Into Pre-Bias, 1-A Load

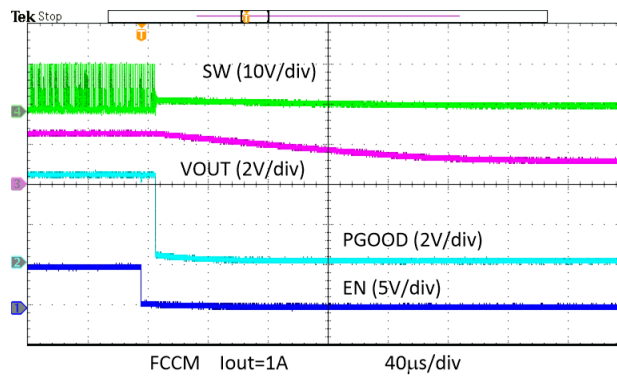

Figure 17. TPS548A29 Power Down Into Pre-Bias, 1-A Load

3 Schematic, List of Materials, and Layout

This section provides a schematic, a description of the TPS548A29EVM board layout, and layer illustrations.

3.1 Schematic

Below is the schematic for the TPS548A29EVM.

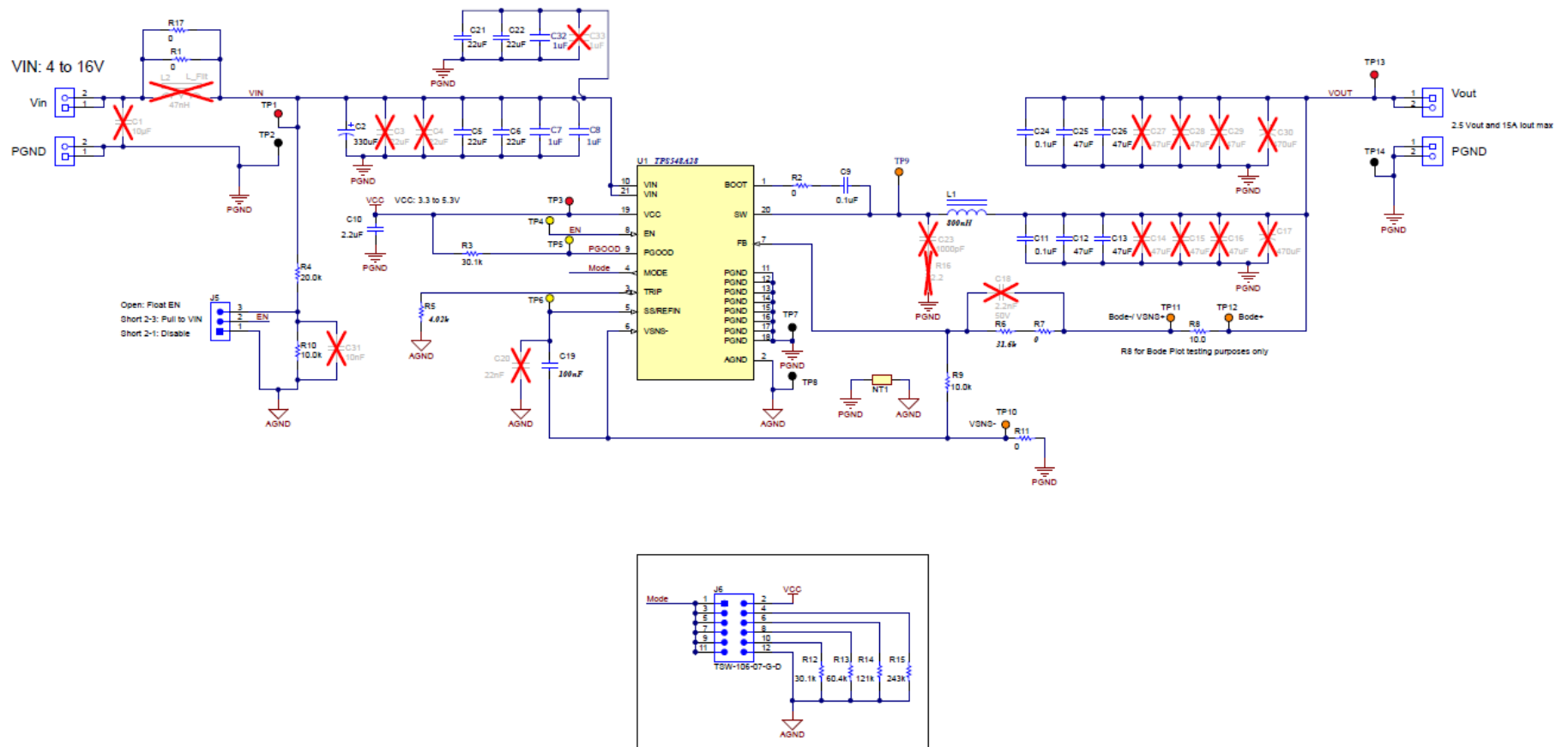

3.2 List of Materials

Table 6 presents the List of materials for the TPS548A29EVM.

Table 6. TPS548A29EVM List of Materials

DES	QTY	DESCRIPTION	PART NUMBER	MANUFACTURER
C2	1	CAP, AL, 330 uF, 25 V, +/- 20%, 0.15 ohm, SMD, 330uF	EEE-FC1E331P	Panasonic
C5, C6, C21, C22	4	CAP, CERM, 22 uF, 25 V, +/- 20%, X6S, 1206_190	GRM31CC81E226ME 11L	MuRata
C7, C8, C32	3	CAP CER 1UF 25V X6S 0402	GRM155C81E105KE 11D	Murata
C9	1	CAP, CERM, 0.1 uF, 50 V, +/- 10%, X7R, AEC-Q200 Grade 1, 0603	CGA3E2X7R1H104K 080AA	TDK
C10	1	CAP, CERM, 2.2 uF, 10 V, +/- 10%, X7R, 0603	GRM188R71A225KE 15D	MuRata
C11, C24	2	CAP, CERM, 0.1 uF, 6.3 V, +/- 10%, X7R, 0402	GRM155R70J104KA0 1D	MuRata
C12, C13, C25, C26	4			
C19	1	CAP, CERM, 0.22 uF, 16 V, +/- 10%, X7R, 0603	C1608X7R1C224K08 0AC	TDK
L1	1	Inductor, Shielded, Composite, 800 nH, 25.8 A, 0.00208 ohm, SMD	XAL7070-801MEB	Coilcraft
R1, R17	2	RES, 0, 1%, 0.5 W, 1206	5108	Keystone
R2, R7, R11	3	RES, 0, 1%, 0.1 W, AEC-Q200 Grade 0, 0603	RMCF0603ZT0R00	Stackpole Electronics Inc
R3, R12	2	RES, 30.1 k, 1%, 0.1 W, AEC-Q200 Grade 0, 0603	CRCW060330K1FKE A	Vishay-Dale
R4	1	RES, 20.0 k, 0.1%, 0.1 W, 0603	RT0603BRD0720KL	Yageo America
R5	1			
R6	1			
R8	1	RES, 10.0, 1%, 0.1 W, AEC-Q200 Grade 0, 0603	CRCW060310R0FKE A	Vishay-Dale
R9, R10	2	RES, 10.0 k, 1%, 0.1 W, AEC-Q200 Grade 0, 0603	CRCW060310K0FKE A	Vishay-Dale
R13	1	RES, 60.4 k, 1%, 0.1 W, 0603	RC0603FR-0760K4L	Yageo
R14	1	RES, 121 k, 1%, 0.1 W, 0603	RC0603FR-07121KL	Yageo
R15	1	RES, 243 k, 1%, 0.1 W, AEC-Q200 Grade 0, 0603	CRCW0603243KFKE A	Vishay-Dale
U1	1		TPS548A28RWWT	Texas Instruments

3.3 Layout

The board layout for the TPS548A29EVM is shown in [Figure 18](#) through [Figure 21](#). The top-side layer of the EVM is laid out in a manner typical of a user application. The top, bottom, and internal layers are 2-oz. copper.

The top layer contains the main power traces for V_{IN} , V_{OUT} , and SW. Also on the top layer are connections for the remaining pins of the TPS548A29 and the majority of the signal traces. The top layer has a dedicated ground plane for quiet analog ground that is connected to the main power ground plane at a single point. The internal layer-1 is a large ground plane. The internal layer-2 contains an additional large ground copper area as well as an additional V_{OUT} copper fill. The bottom layer is another ground plane with two additional traces for the output voltage feedback and various signals routed to test points and headers. There are also additional V_{IN} and V_{OUT} planes on the bottom layer. The top-side ground traces are connected to the bottom and internal ground planes with multiple via groupings placed around the board.

The input decoupling capacitors and bootstrap capacitor are all located as close to the IC as possible. Additionally, the voltage set point resistor divider components are kept close to the IC. The voltage divider network ties to the output voltage at the point of regulation, the copper V_{OUT} trace at the TP4 test point. An additional input bulk capacitor is used to limit the noise entering the converter from the input supply. Critical analog circuits that are noise sensitive are terminated to the quiet analog ground island on the top layer.

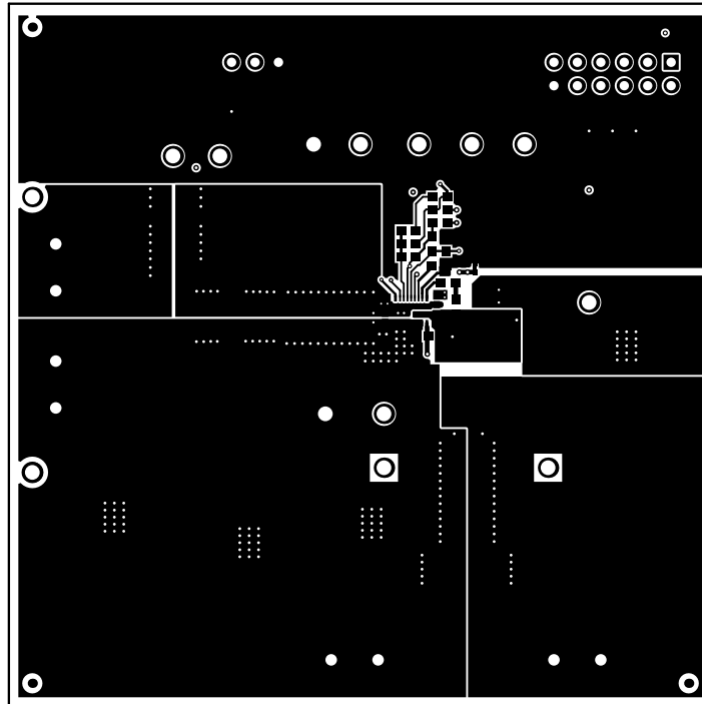

Figure 18. TPS548A29EVM Top-Side Layout

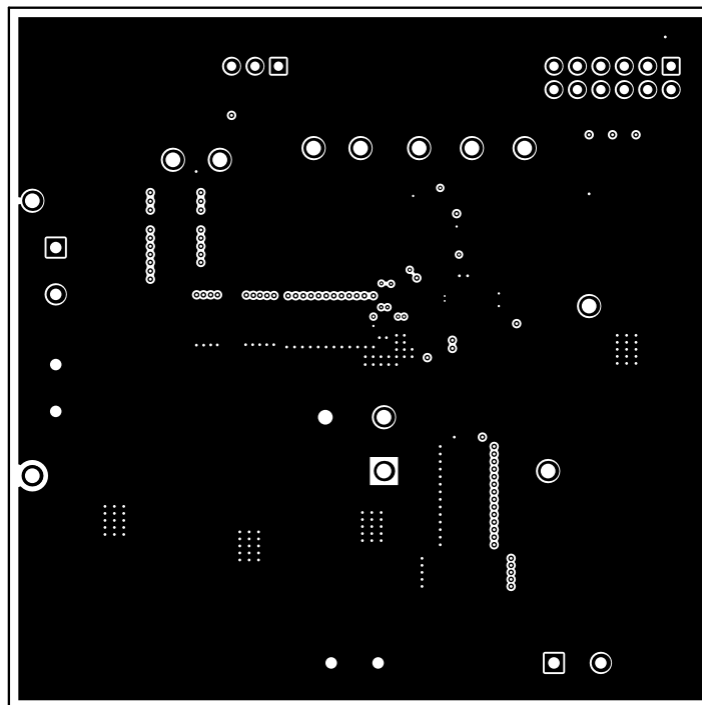

Figure 19. TPS548A29EVM Internal Layer-1 Layout

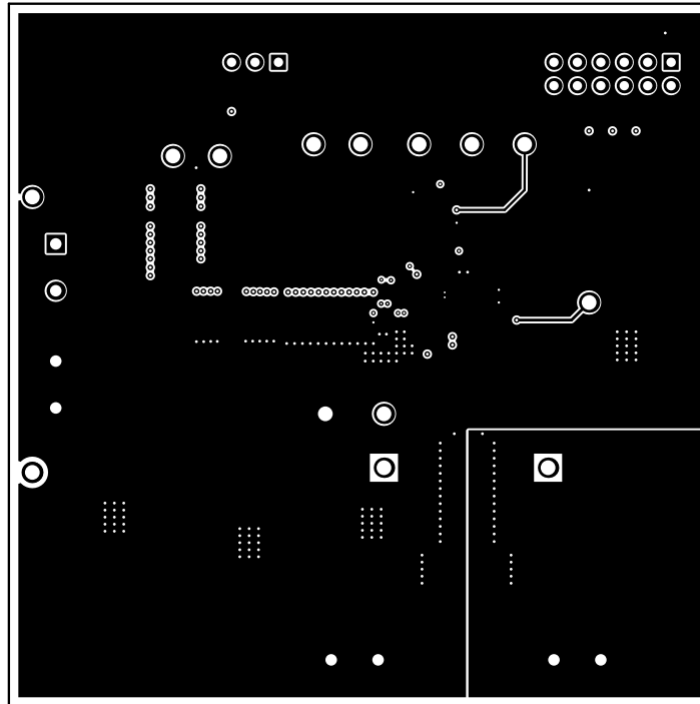

Figure 20. TPS548A29EVM Internal Layer-2 Layout

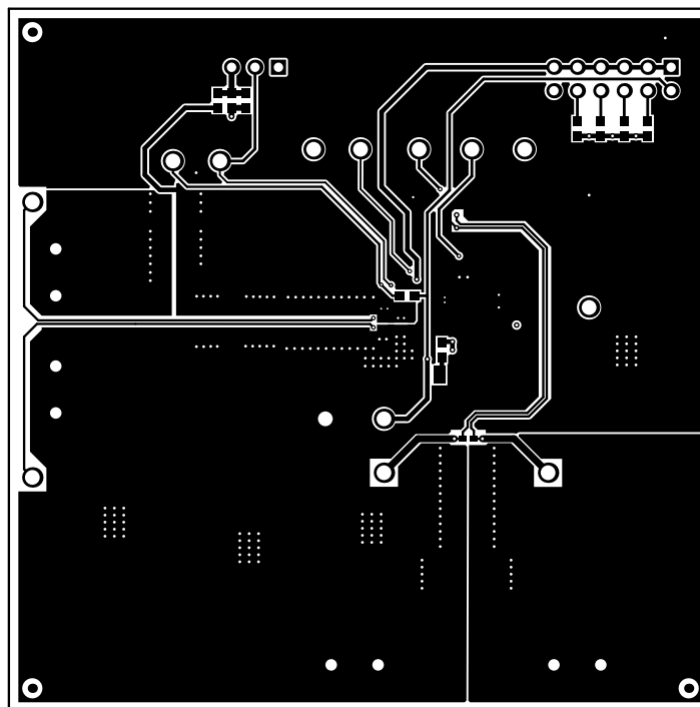

Figure 21. TPS548A29EVM Bottom-Side Layout

IMPORTANT NOTICE AND DISCLAIMER

TI PROVIDES TECHNICAL AND RELIABILITY DATA (INCLUDING DATASHEETS), DESIGN RESOURCES (INCLUDING REFERENCE DESIGNS), APPLICATION OR OTHER DESIGN ADVICE, WEB TOOLS, SAFETY INFORMATION, AND OTHER RESOURCES "AS IS" AND WITH ALL FAULTS, AND DISCLAIMS ALL WARRANTIES, EXPRESS AND IMPLIED, INCLUDING WITHOUT LIMITATION ANY IMPLIED WARRANTIES OF MERCHANTABILITY, FITNESS FOR A PARTICULAR PURPOSE OR NON-INFRINGEMENT OF THIRD PARTY INTELLECTUAL PROPERTY RIGHTS.

These resources are intended for skilled developers designing with TI products. You are solely responsible for (1) selecting the appropriate TI products for your application, (2) designing, validating and testing your application, and (3) ensuring your application meets applicable standards, and any other safety, security, or other requirements. These resources are subject to change without notice. TI grants you permission to use these resources only for development of an application that uses the TI products described in the resource. Other reproduction and display of these resources is prohibited. No license is granted to any other TI intellectual property right or to any third party intellectual property right. TI disclaims responsibility for, and you will fully indemnify TI and its representatives against, any claims, damages, costs, losses, and liabilities arising out of your use of these resources.

TI's products are provided subject to TI's Terms of Sale (www.ti.com/legal/termsofsale.html) or other applicable terms available either on ti.com or provided in conjunction with such TI products. TI's provision of these resources does not expand or otherwise alter TI's applicable warranties or warranty disclaimers for TI products.

Mailing Address: Texas Instruments, Post Office Box 655303, Dallas, Texas 75265
Copyright © 2020, Texas Instruments Incorporated