

# LMQ644A2QEVMD2100 36-V, Dual, 6-A Outputs, Synchronous, Buck Converter Evaluation Board



## ABSTRACT

LM(Q)64408(-Q1), LM(Q)644A0(-Q1) and LM(Q)644A2(-Q1) Dual Buck DC/DC Converter family provides flexibility, scalability, and optimized solution size for a wide range of applications. With integrated power MOSFETs, the device is stackable up to 6-phases for higher output currents up to 36 A, and uses a current-mode control architecture for easy loop compensation. The device supports input voltage surge up to 36 V and dip as low as 3 V. The switching frequency is adjustable from 100 kHz to 2.2 MHz using the RT pin and also can be synchronized to an external clock to eliminate beat frequencies in noise-sensitive applications. The output regulation target is programmed to a fixed 3.3 V, 5 V or adjustable using external feedback resistors. Available EMI mitigation features include spread spectrum, integrated input bypass capacitors and low package parasitic with enhanced QFN package.

**Table 1-1. LM(Q)644xx(-Q1) Dual Buck DC/DC Converter Family**

Part Number	Rated I <sub>OUT</sub>	PACKAGE	DIMENSIONS
LM(Q)64408(-Q1)	4 A per channel	Enhanced QFN (25)	5.0 mm × 4.0 mm
LM(Q)644A0(-Q1)	5 A per channel		
LM(Q)644A2(-Q1)	6 A per channel		

## Table of Contents

<b>1 EVM Description</b> .....	<b>3</b>
1.1 Features and Electrical Performance.....	3
<b>2 EVM Performance and Specifications</b> .....	<b>4</b>
<b>3 EVM Photo</b> .....	<b>5</b>
<b>4 Test Setup and Procedure</b> .....	<b>6</b>
4.1 EVM Connections.....	6
4.2 Test Equipment.....	8
4.3 EVM Setup.....	8
<b>5 Test Data and Performance Curves</b> .....	<b>9</b>
5.1 Efficiency and Load Regulation Performance.....	9
5.2 Waveforms and Plots.....	11
5.3 EMI Performance.....	13
5.4 Thermal Performance.....	16
<b>6 EVM Documentation</b> .....	<b>17</b>
6.1 Schematic.....	17
6.2 Bill of Materials.....	18
6.3 PCB Layout.....	20
<b>7 Device and Documentation Support</b> .....	<b>24</b>
7.1 Device Support.....	24
7.2 Documentation Support.....	24

## List of Figures

Figure 3-1. LMQ644A2QEVMD2100 EVM Photo.....	5
Figure 4-1. EVM Test Setup.....	6
Figure 5-1. Efficiency, V <sub>OUT</sub> = 3.3 V, FPWM Mode.....	9
Figure 5-2. Efficiency, V <sub>OUT</sub> = 3.3 V, AUTO Mode.....	9
Figure 5-3. Efficiency, V <sub>OUT</sub> = 5.0 V, FPWM Mode.....	9
Figure 5-4. Efficiency, V <sub>OUT</sub> = 5.0 V, AUTO Mode.....	9

Figure 5-5. Efficiency, VOUT = 3.3 V, AUTO Mode.....	9
Figure 5-6. Efficiency, VOUT = 5.0 V, AUTO Mode.....	9
Figure 5-7. Load Regulation, VOUT = 3.3 V, FPWM Mode.....	10
Figure 5-8. Load Regulation, VOUT = 3.3 V, AUTO Mode.....	10
Figure 5-9. Load Regulation, VOUT = 5.0 V, FPWM Mode.....	10
Figure 5-10. Load Regulation, VOUT = 5.0 V, AUTO Mode.....	10
Figure 5-11. Start-Up, VOUT1 = 5.0 V.....	11
Figure 5-12. Start-Up, VOUT2 = 3.3 V.....	11
Figure 5-13. Shutdown, VOUT1 = 5.0 V.....	11
Figure 5-14. Shutdown, VOUT2 = 3.3 V.....	11
Figure 5-15. Enable ON and OFF, VOUT1 = 5.0 V.....	11
Figure 5-16. Enable ON and OFF, VOUT2 = 3.3 V.....	11
Figure 5-17. Load Transient (CH1), IOUT1 = 3 A to 6 A.....	12
Figure 5-18. Load Transient (CH2), IOUT2 = 3 A to 6 A.....	12
Figure 5-19. Bode Plot (CH1).....	12
Figure 5-20. Bode Plot (CH2).....	12
Figure 5-21. SYNC and Interleaving, VOUT1 = 3.3 V, VOUT2 = 5.0 V.....	12
Figure 5-22. CISPR 25 Conducted Emissions: 150 kHz to 30 MHz.....	13
Figure 5-23. CISPR 25 Conducted Emissions: 30 MHz to 108 MHz.....	13
Figure 5-24. CISPR 25 Radiated Emissions: 150 kHz to 30 MHz, MONOPOLE.....	14
Figure 5-25. CISPR 25 Radiated Emissions: 30 MHz to 200 MHz, BICON.....	14
Figure 5-26. CISPR 25 Radiated Emissions: 200 MHz to 1 GHz, LOG.....	14
Figure 5-27. CISPR 25 Radiated Emissions: 1 GHz to 2.5G Hz, HORN.....	15
Figure 5-28. Infrared Thermal Image: VIN = 12 V, IOUT1 = 6 A, IOUT2 = 6 A.....	16
Figure 6-1. EVM Schematic.....	17
Figure 6-2. Top Component View.....	20
Figure 6-3. Bottom Component View.....	20
Figure 6-4. Top Layer Copper.....	21
Figure 6-5. Layer 2 Copper.....	21
Figure 6-6. Layer 3 Copper.....	22
Figure 6-7. Layer 4 Copper.....	22
Figure 6-8. Layer 5 Copper.....	23
Figure 6-9. Bottom Layer Copper (Viewed From Top).....	23

## List of Tables

Table 1-1. LM(Q)644xx(-Q1) Dual Buck DC/DC Converter Family.....	1
Table 2-1. Electrical Performance Specifications.....	4
Table 4-1. EVM Power Connections.....	6
Table 4-2. EVM Signal Connections.....	7
Table 6-1. Component BOM.....	18

## Trademarks

WEBENCH® is a registered trademark of Texas Instruments.  
All trademarks are the property of their respective owners.

## 1 EVM Description

The LMQ644A2QEVM-D2100 evaluation board showcases the features and performance of the LMQ644A2-Q1, dual buck DC/DC converter with integrated power MOSFETs. The EVM provides dual 6-A outputs. The output voltages can be individually programmed to a fixed 3.3 V, 5 V or adjustable using external feedback resistors. Also, each channel can be enabled or disabled by a jumper selection.

The switching frequency at the full load is programmed to 2.1 MHz as a default. The switching mode at the light load is selectable between FPWM and AUTO mode. Also, spread spectrum can be enabled or disabled by a jumper selection. If an external pulse signal is applied to the SYNC pin, the switching frequency is synchronized to the external clock.

### 1.1 Features and Electrical Performance

- Dual 6-A outputs synchronous buck converter
- Wide operating range of up to 36 V
- Default output voltages: 5 V (CH1) and 3 V (CH2)
- Default switching frequency: 2.1 MHz
- High efficiency across a wide load-current range
- Input EMI filter with electrolytic capacitor for parallel damping (input filter can handle up to 8-A input current)
- Clock synchronization and FPWM mode provide constant switching frequency across the full load range
- Integrated input capacitors enable low-noise switching performance
- Pin selectable spread spectrum
- Peak current-mode control architecture with integrated loop compensation.
- Peak current limiting with hiccup-mode overcurrent protection
- Thermal shutdown protection with hysteresis
- PGOOD indicator
- Programmable input UVLO
- 6-layer, 2-oz PC board design

## 2 EVM Performance and Specifications

Unless otherwise indicated,  $V_{IN} = 12\text{ V}$ ,  $V_{OUT1} = 5.0\text{ V}$ ,  $V_{OUT2} = 3.3\text{ V}$ ,  $I_{OUT1} = 6\text{ A}$ ,  $I_{OUT2} = 6\text{ A}$  and  $f_{sw} = 2.1\text{ MHz}$ .

**Table 2-1. Electrical Performance Specifications**

PARAMETER	TEST CONDITIONS	MIN	TYP	MAX	UNIT
<b>INPUT CHARACTERISTICS</b>					
Input supply voltage range	$V_{IN}$ range	6 <sup>(3)</sup>		36	V
	$V_{IN\_EMI}$ range	12		36	V
Input current	Input current at $V_{IN}$			12	A
	Input current at $V_{IN\_EMI}$			8	A
<b>OUTPUT CHARACTERISTICS <sup>(1)</sup></b>					
CH1 output voltage	Default output is 5.0 V	4.9	5.0	5.1	V
CH1 output current		0		6	A
CH2 output voltage	Default output is 3.3 V	3.234	3.3	3.366	V
CH2 output current		0		6	A
<b>SYSTEM CHARACTERISTICS</b>					
Default switching frequency, $f_{sw}$			2.1		MHz
Full-load efficiency <sup>(2)</sup>	CH1, $V_{IN} = 12\text{ V}$ , $I_{OUT1} = 6\text{ A}$		91%		
	CH1, $V_{IN} = 24\text{ V}$ , $I_{OUT1} = 6\text{ A}$		87%		
	CH2, $V_{IN} = 12\text{ V}$ , $I_{OUT2} = 6\text{ A}$		88%		
	CH2, $V_{IN} = 24\text{ V}$ , $I_{OUT2} = 6\text{ A}$		84%		

(1) Default output voltages and switching frequency are 5 V (CH1), 3.3 V (CH2) and 2.1MHz, respectively.

(2) The recommended airflow is 200 LFM when operating

(3) The EVM operates when the input voltage is in the range of 3 V to 6 V, but enters a dropout mode if there is insufficient input voltage to regulate output voltages.

### 3 EVM Photo

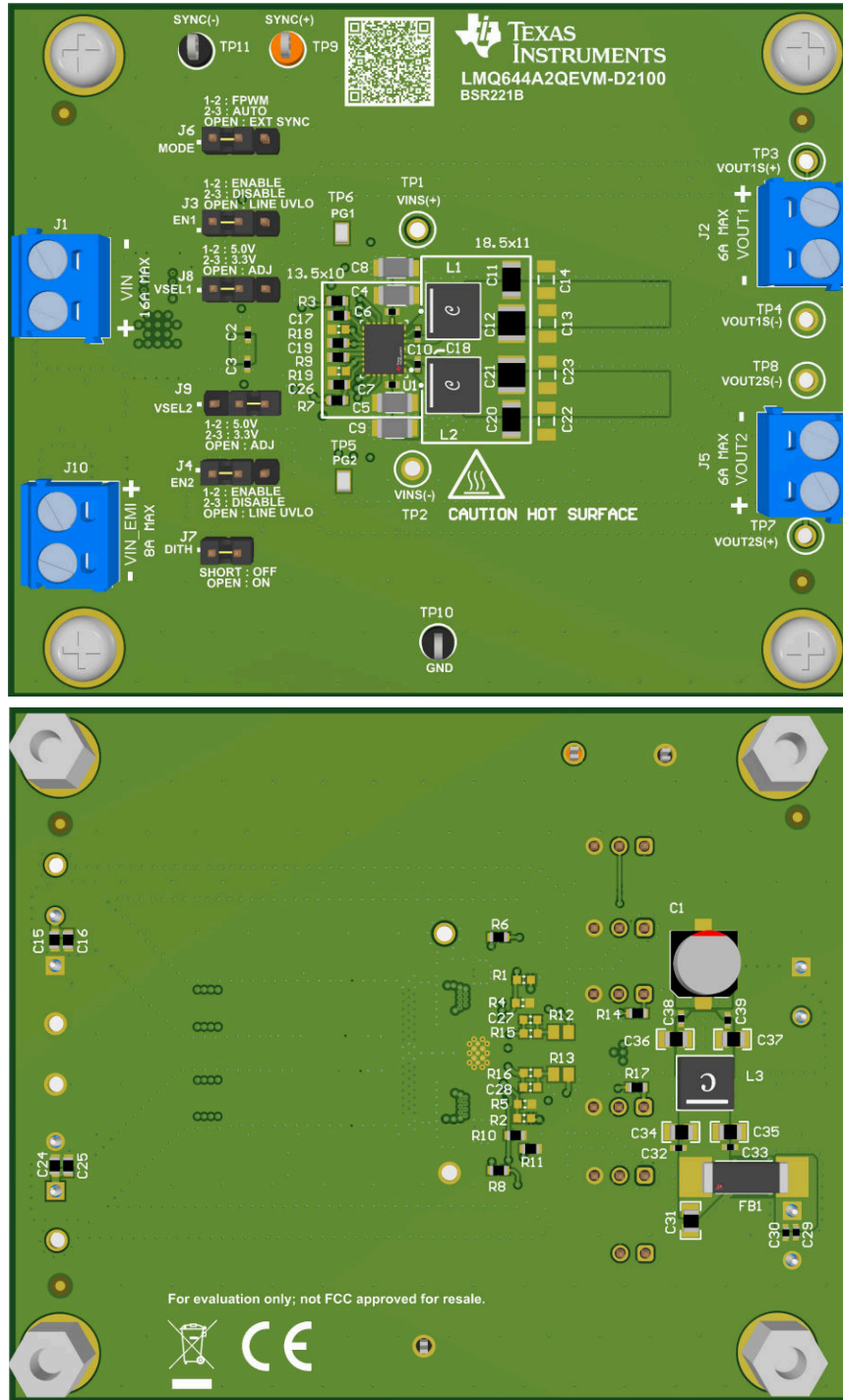



Figure 3-1. LMQ644A2QEVM-D2100 EVM Photo

**CAUTION**

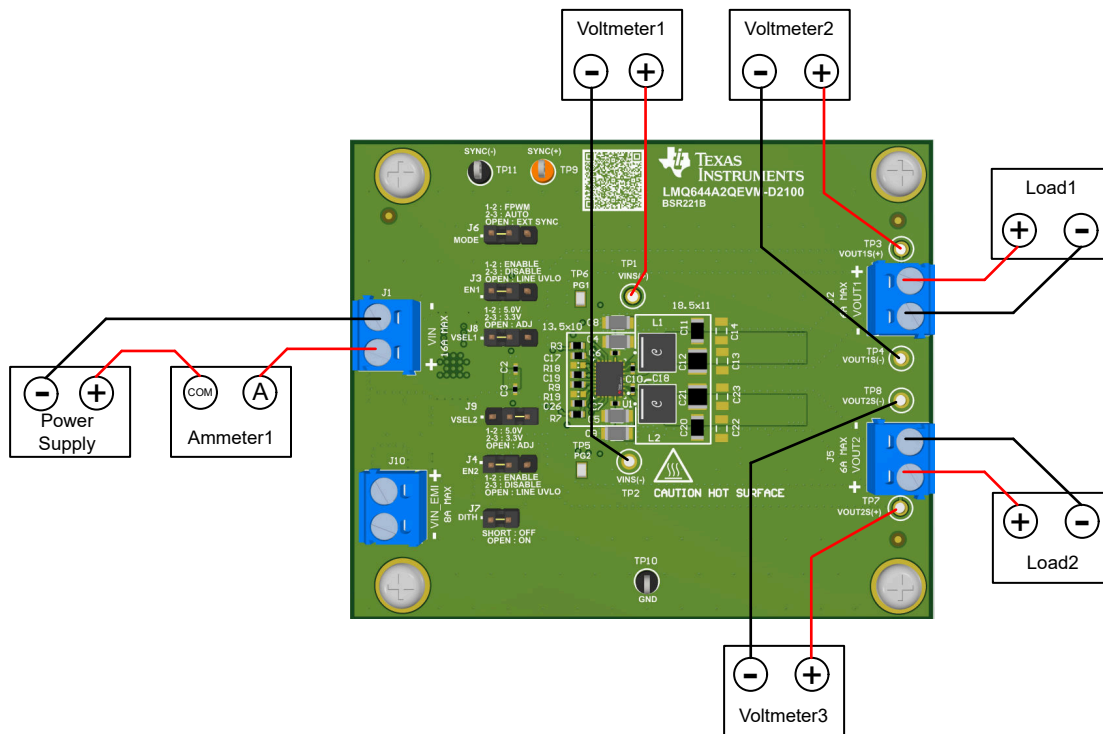


Caution Hot surface.  
 Contact may cause burns.  
 Do not touch.

## 4 Test Setup and Procedure

### 4.1 EVM Connections

Working at an ESD-protected workstation, make sure that any wrist straps, bootstraps, or mats are connected and referencing the user to earth ground before power is applied to the EVM.



**Figure 4-1. EVM Test Setup**

**Table 4-1. EVM Power Connections**

LABEL	DESCRIPTION
VIN+	Positive input power connection
VIN-	Negative input power connection
VIN_EMI+	Positive input power connection for EMI test. The minimum operating voltage is 12 V at this input.
VIN_EMI-	Negative input power connection for EMI test. The minimum operating voltage is 12 V at this input.
VOUT1+	CH1 Positive output power connection
VOUT1-	CH1 Negative output power connection
VOUT2+	CH2 Positive output power connection
VOUT2-	CH2 Negative output power connection

**Table 4-2. EVM Signal Connections**

<b>LABEL</b>	<b>DESCRIPTION</b>
VINS+	Positive input sense pin for measuring efficiency.
VINS-	Negative input sense pin for measuring efficiency.
VOUT1S+	CH1 positive output sense pin for measuring efficiency, and line and load regulation.
VOUT1S-	CH1 negative output sense pin for measuring efficiency, and line and load regulation.
VOUT2S+	CH2 positive output sense pin for measuring efficiency, and line and load regulation.
VOUT2S-	CH2 negative output sense pin for measuring efficiency, and line and load regulation.
GND	Ground reference point
SYNC(+)	Positive synchronization pulse input.
SYNC(-)	Negative synchronization pulse input.
MODE	Light load switching mode selection. Connect pin1 and pin2 for a FPWM mode . Connect pin2 and pin3 for an AUTO mode. Remove any jumper when external synchronization pulse is applied to SYNC.
DITH	Spread spectrum enable, disable. Connect pin1 and pin2 to disable the spread spectrum. Remove any jumper to enable the spread spectrum. The EVM needs to restart after changing the jumper setting.
EN1	CH1 enable, disable. Connect pin1 and pin2 to enable CH1. Connect pin2 and pin3 to disable CH1. Remove any jumper when programing the line UVLO using a resistor divider. Populate the external UVLO resistor divider.
EN2	CH2 enable, disable. Connect pin1 and pin2 to enable CH2. Connect pin2 and pin3 to disable CH2. Remove any jumper when programing the line UVLO using a resistor divider. Populate the external UVLO resistor divider.
VSEL1	CH1 output voltage selection. Connect pin1 and pin2 for a fixed 5-V output. Connect pin2 and pin3 for a fixed 3.3-V output. Remove any jumper when programing the regulation target using an external resistor divider. Populate the external feedback resistor divider.
VSEL2	CH2 output voltage selection. Connect pin1 and pin2 for a 5-V output. Connect pin2 and pin3 for a 3.3-V output. Remove any jumper when programing the regulation target using an external resistor divider. Populate the external feedback resistor divider.
PG1	Probe point for CH1 power-good indicator. A pullup resistor is connected to VCC.
PG2	Probe point for CH2 power-good indicator. A pullup resistor is connected to VCC.



## 4.2 Test Equipment

**Power Supply:** Connect to VIN(-) and Ammeter1. The power supply must be capable of supplying 16 A. Adjustable voltage range must be from 3 V to 36 V.

### Multimeters:

- **Voltmeter 1:** Measure the input voltage at VINS+ to VINS-.
- **Voltmeter 2:** Measure the CH1 output voltage at VOUT1S+ to VOUT1S-.
- **Voltmeter 3:** Measure the CH2 output voltage at VOUT2S+ to VOUT2S-.
- **Ammeter 1:** Measure the input current. Connect to the power supply and VIN(+).

### Electronic Load:

- **Load 1:** Connect to VOUT1(+) and VOUT1(-). The electronic load must be capable of sinking 6 A.
- **Load 2:** Connect to VOUT2(+) and VOUT2(-). The electronic load must be capable of sinking 6 A.

## 4.3 EVM Setup

Use the VINS+ and VINS- test points along with the VOUT1S+, VOUT1S-, VOUT2S+, VOUT2S- test points located near the power terminal blocks as voltage monitoring points where voltmeters are connected to measure the input and output voltages, respectively. *Do not use these sense terminals as the input supply or output load connection points.* The PCB traces connected to these sense terminals are not designed to support high currents. Before applying power to the EVM, make sure that the jumpers are present and properly positioned for the intended output voltage. Always remove input power before changing the jumper settings. Always use caution when touching any circuits that can be live or energized.

### CAUTION

Extended operation at high output current can raise component temperatures above 55°C. To avoid risk of a burn injury, do not touch the components until they have cooled sufficiently after disconnecting power. Wire gauge for the input power supply and the output electric load must be 9 AWG minimum and no longer than 1 foot. Please tighten the input and output terminal screws to minimize contact resistance.

### 4.3.1 Input Connections

- Connect voltmeter1 at VINS+ and VINS- .
- Connect ammeter1 to VIN+.
- Prior to connecting the power supply, set the current limit of the power supply to 0.3-A maximum and ensure the initial output voltage is set to 0 V. Connect to the VIN- and the ammeter1 as shown in [Figure 4-1](#).

### 4.3.2 Output Connections

- Connect voltmeter2 at VOUT1S+ and VOUT1S- sense points to measure the CH1 output voltage.
- Connect voltmeter3 at VOUT2S+ and VOUT2S- sense points to measure the CH2 output voltage.
- Connect load1 to the VOUT1+ and VOUT1- connections as shown in [Figure 4-1](#). Set the load to constant-resistance mode or constant-current mode at 0 A before applying input voltage.
- Connect load2 to the VOUT2+ and VOUT2- connections as shown in [Figure 4-1](#). Set the load to constant-resistance mode or constant-current mode at 0 A before applying input voltage.



## 5 Test Data and Performance Curves

Unless otherwise indicated,  $V_{IN} = 12\text{ V}$ ,  $V_{OUT1} = 5\text{ V}$ ,  $V_{OUT2} = 3.3\text{ V}$ ,  $I_{OUT1} = 6\text{ A}$ ,  $I_{OUT2} = 6\text{ A}$  and  $f_{SW} = 2.1\text{ MHz}$ .

### 5.1 Efficiency and Load Regulation Performance

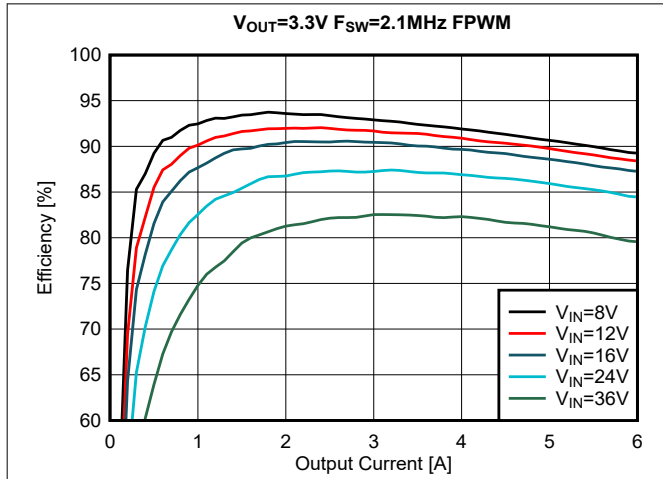


Figure 5-1. Efficiency,  $V_{OUT} = 3.3\text{ V}$ , FPWM Mode

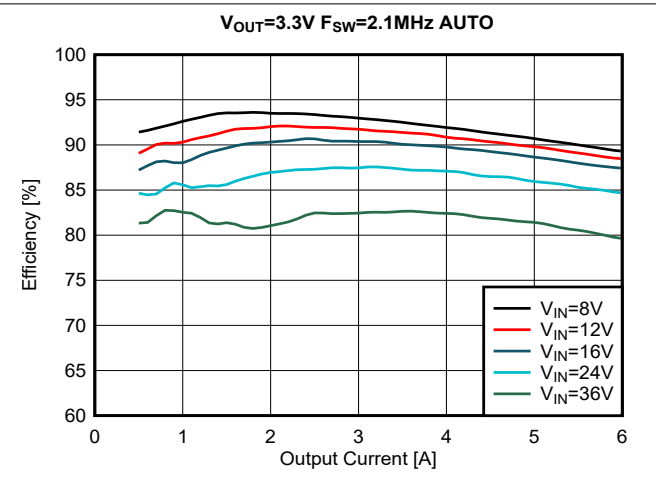


Figure 5-2. Efficiency,  $V_{OUT} = 3.3\text{ V}$ , AUTO Mode

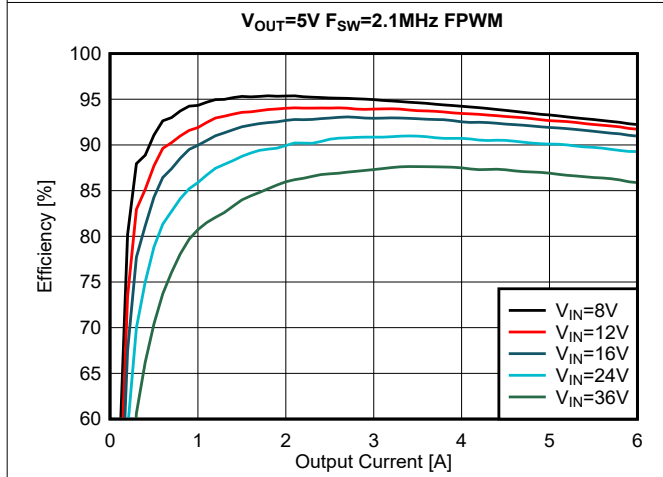


Figure 5-3. Efficiency,  $V_{OUT} = 5.0\text{ V}$ , FPWM Mode

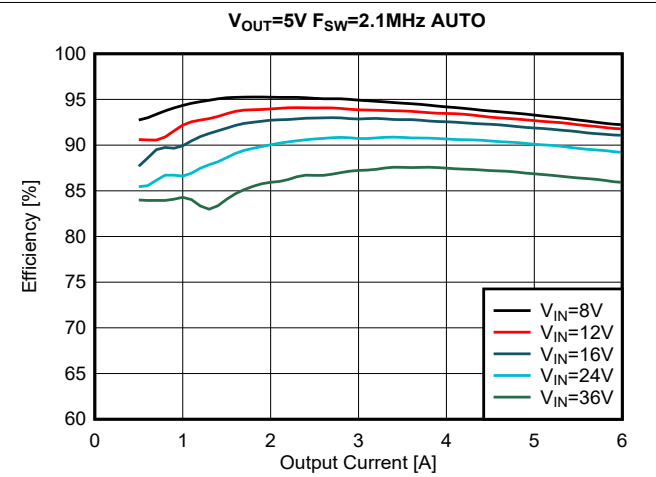


Figure 5-4. Efficiency,  $V_{OUT} = 5.0\text{ V}$ , AUTO Mode

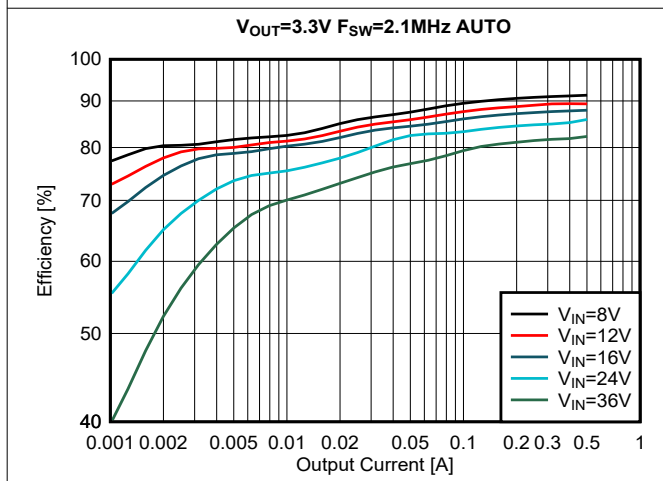


Figure 5-5. Efficiency,  $V_{OUT} = 3.3\text{ V}$ , AUTO Mode

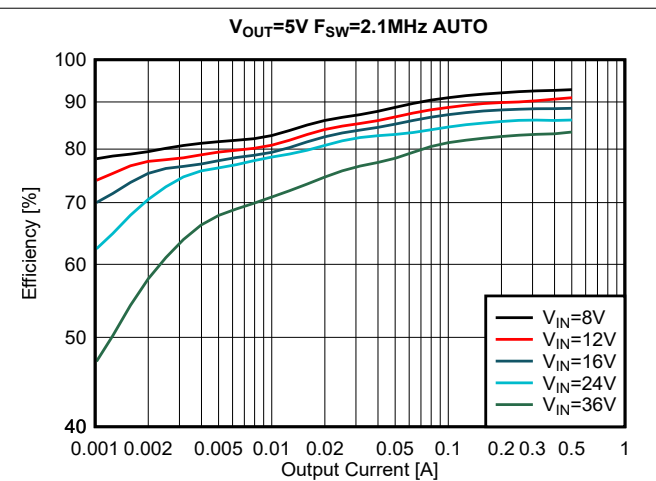
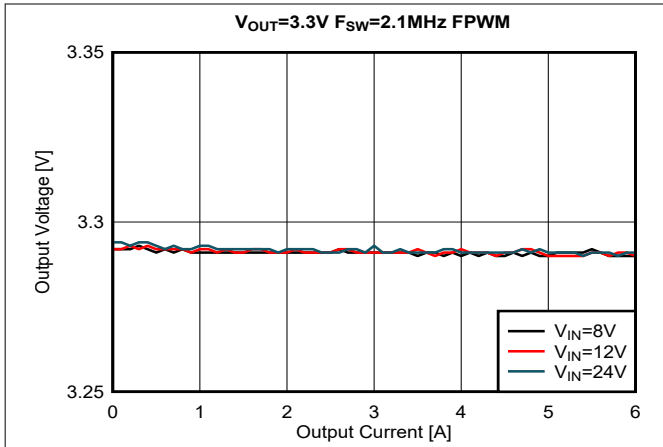
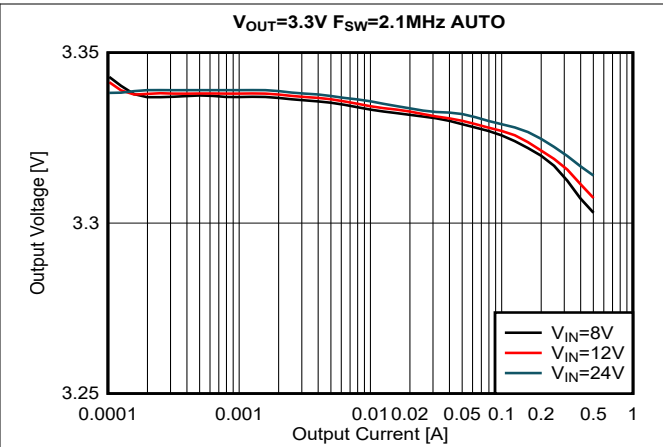


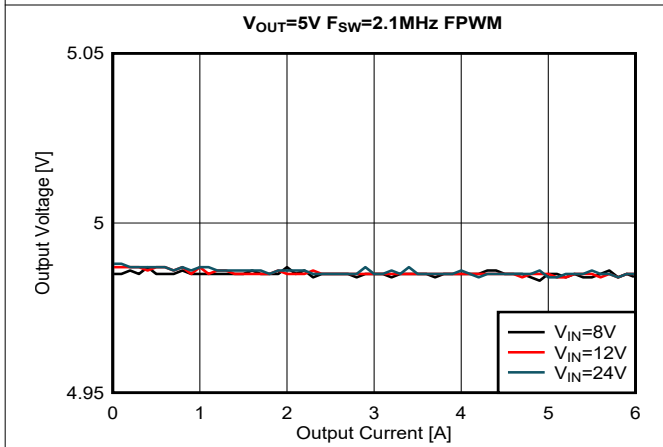
Figure 5-6. Efficiency,  $V_{OUT} = 5.0\text{ V}$ , AUTO Mode



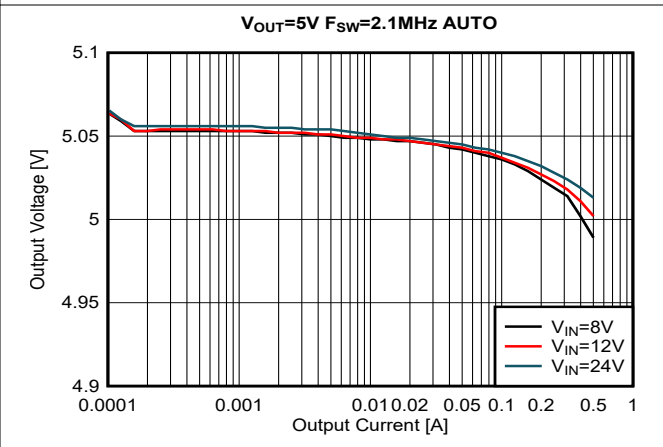
**Figure 5-7. Load Regulation, V<sub>OUT</sub> = 3.3 V, FPWM Mode**



**Figure 5-8. Load Regulation, V<sub>OUT</sub> = 3.3 V, AUTO Mode**



**Figure 5-9. Load Regulation, V<sub>OUT</sub> = 5.0 V, FPWM Mode**



**Figure 5-10. Load Regulation, V<sub>OUT</sub> = 5.0 V, AUTO Mode**

## 5.2 Waveforms and Plots

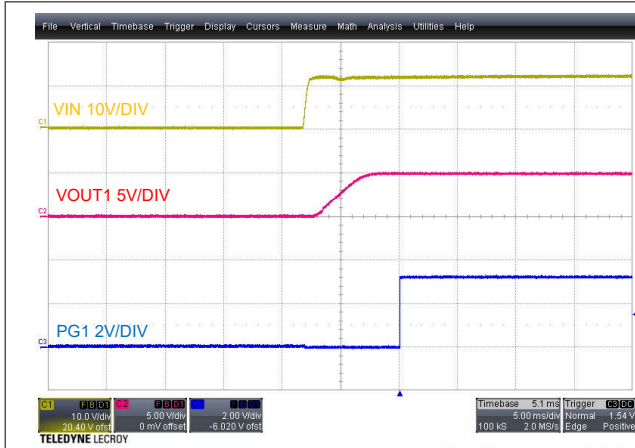


Figure 5-11. Start-Up, VOUT1 = 5.0 V

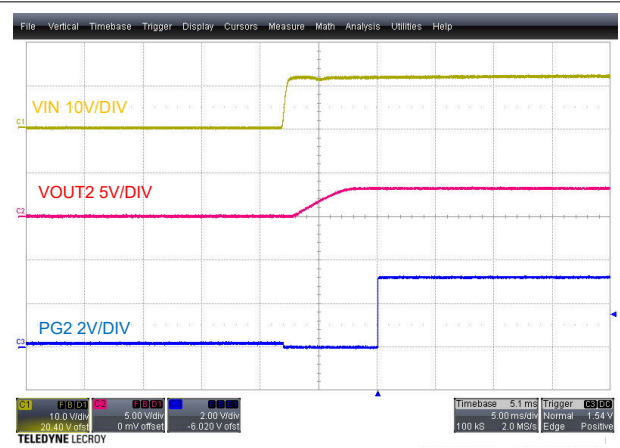


Figure 5-12. Start-Up, VOUT2 = 3.3 V

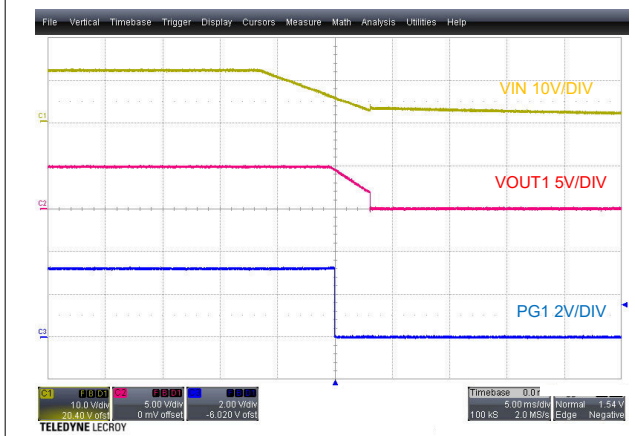


Figure 5-13. Shutdown, VOUT1 = 5.0 V

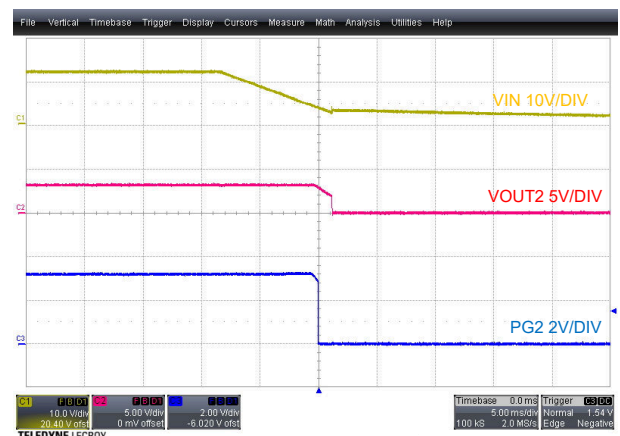


Figure 5-14. Shutdown, VOUT2 = 3.3 V

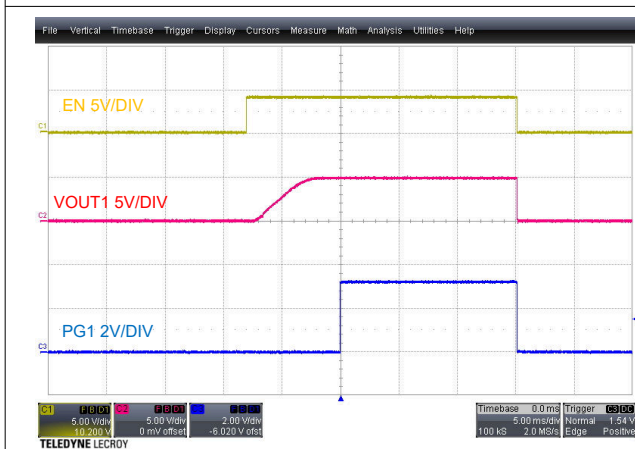


Figure 5-15. Enable ON and OFF, VOUT1 = 5.0 V

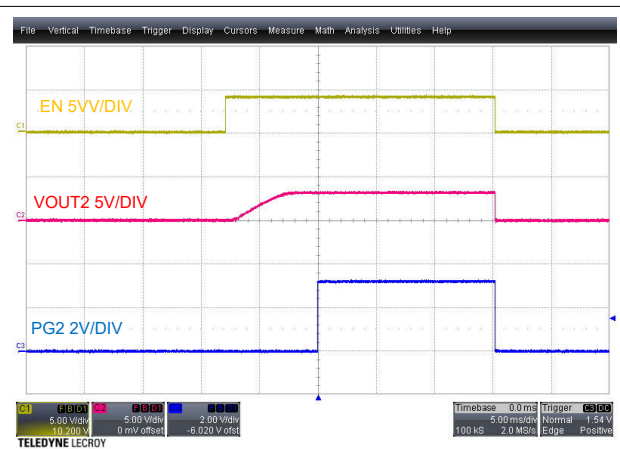


Figure 5-16. Enable ON and OFF, VOUT2 = 3.3 V

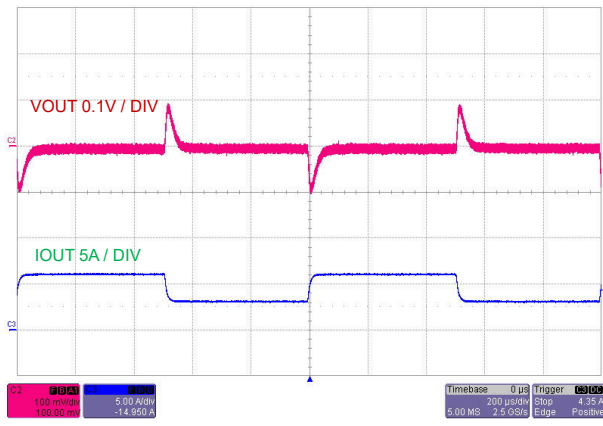


Figure 5-17. Load Transient (CH1), IOUT1 = 3 A to 6 A  
A

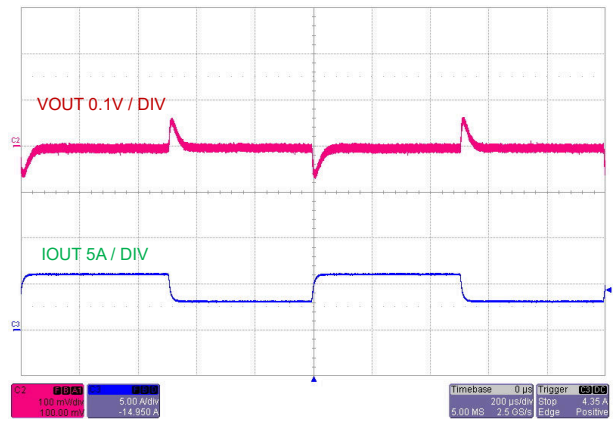


Figure 5-18. Load Transient (CH2), IOUT2 = 3 A to 6 A  
A

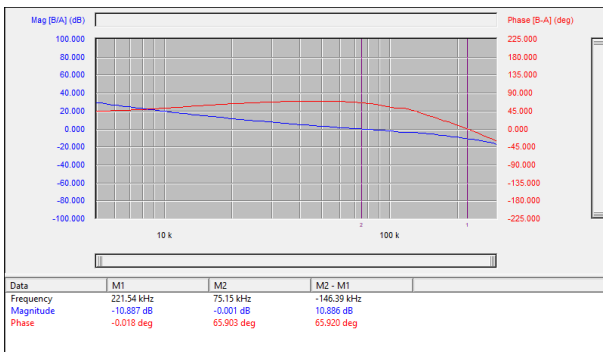


Figure 5-19. Bode Plot (CH1)

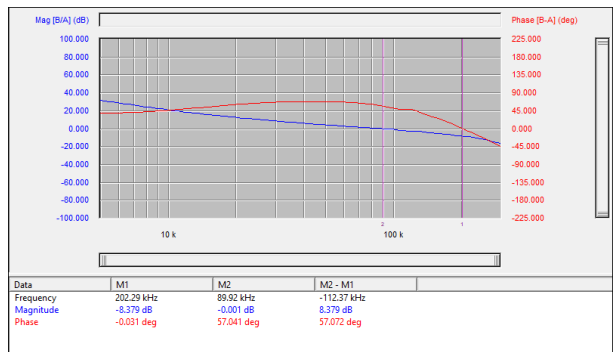


Figure 5-20. Bode Plot (CH2)

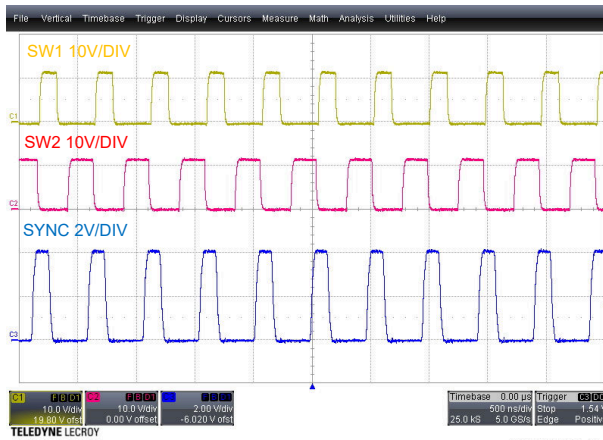


Figure 5-21. SYNC and Interleaving, VOUT1 = 3.3 V, VOUT2 = 5.0 V

### 5.3 EMI Performance

VIN = 12 V, VOUT1 = 5 V, VOUT2 = 3.3 V, IOUT1 = 6 A, IOUT2 = 6 A, Spread spectrum enabled.

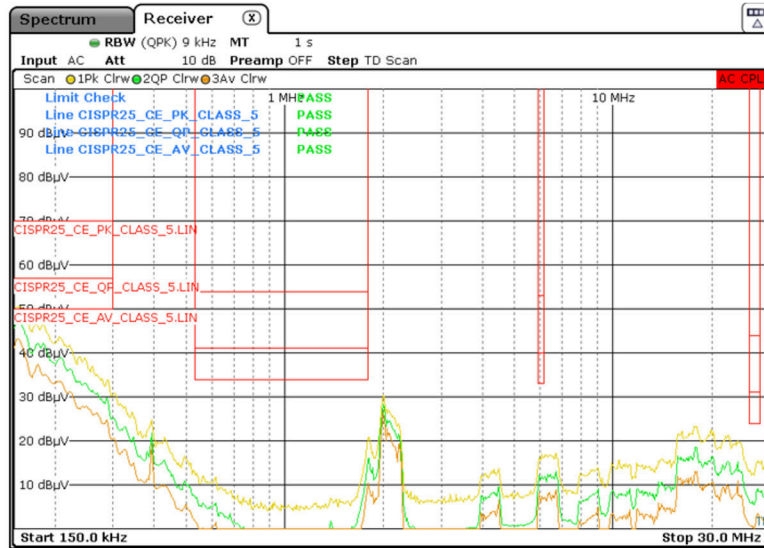


Figure 5-22. CISPR 25 Conducted Emissions: 150 kHz to 30 MHz

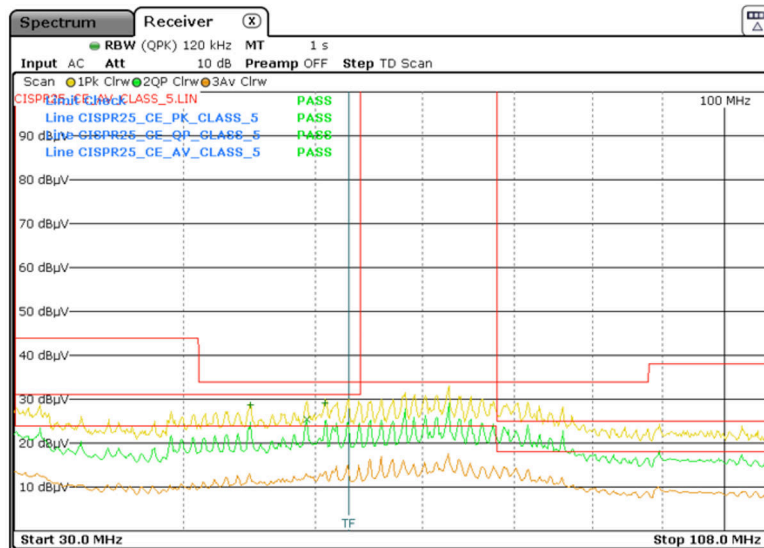
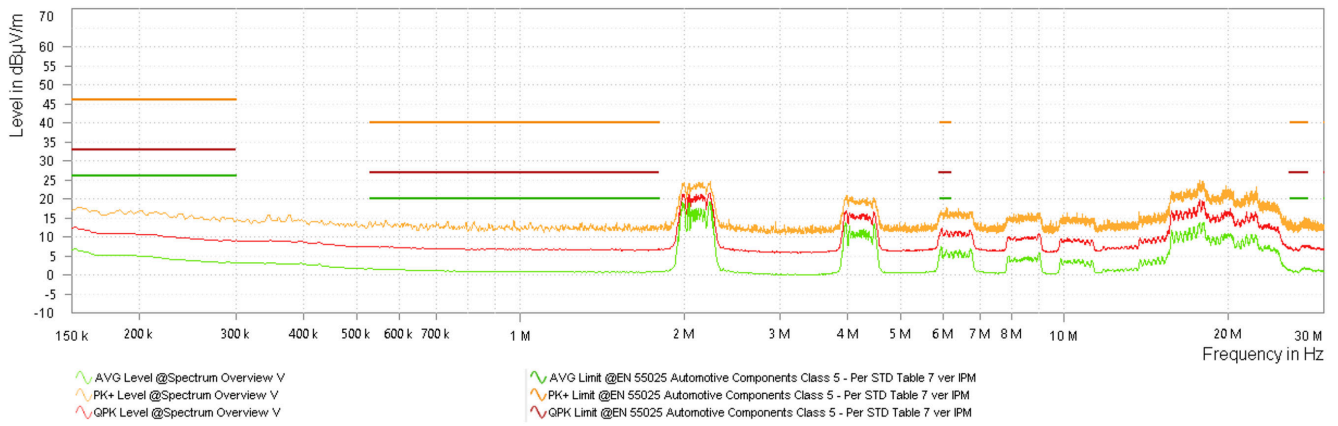
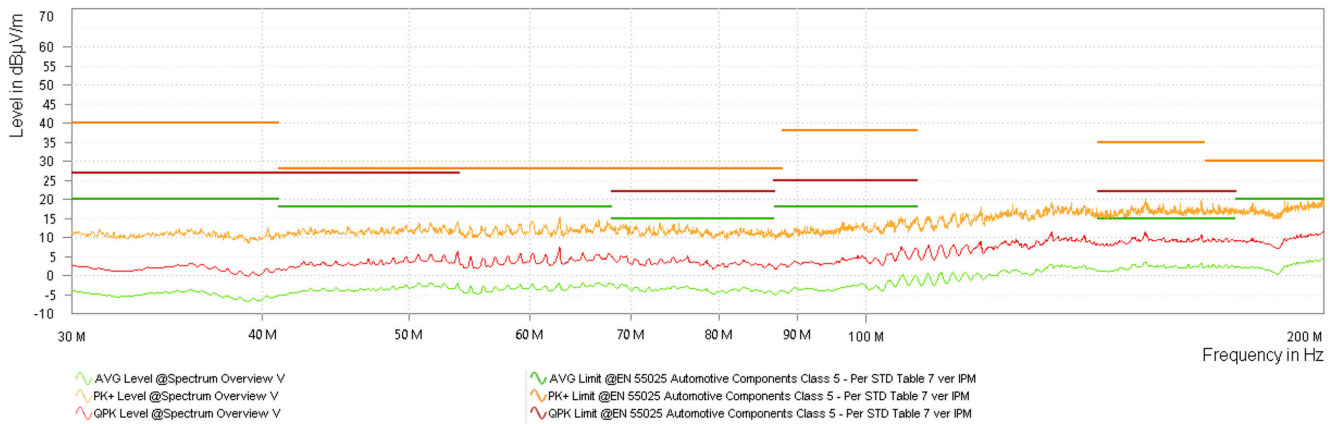


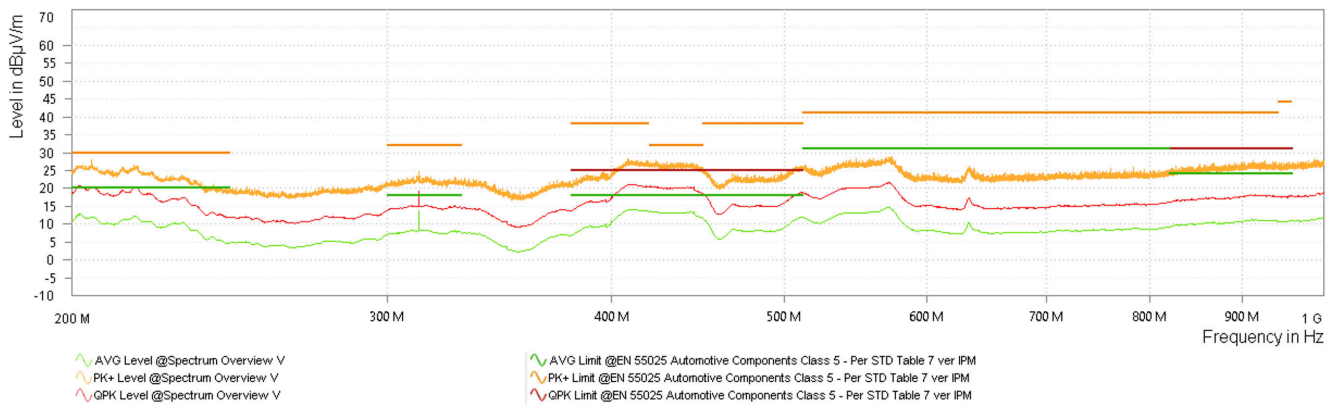
Figure 5-23. CISPR 25 Conducted Emissions: 30 MHz to 108 MHz



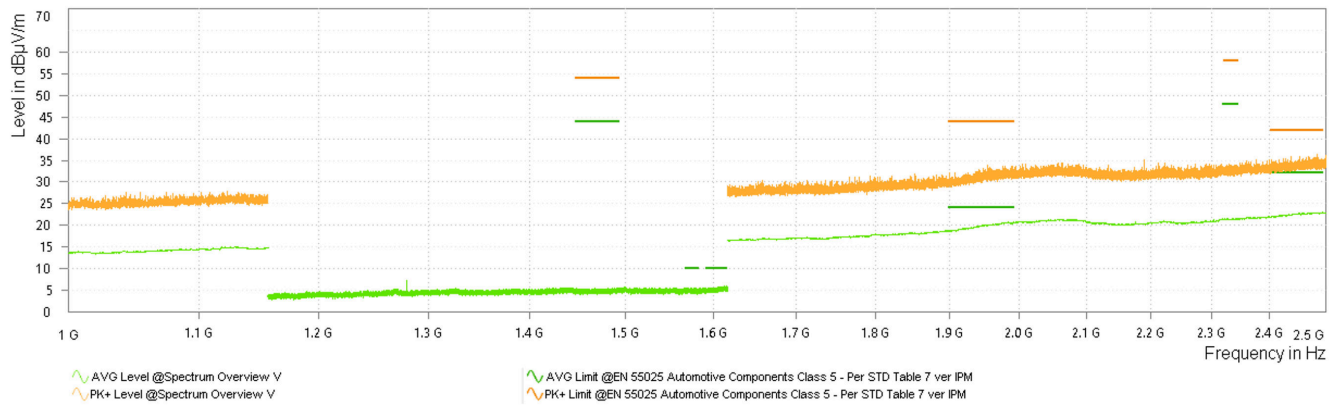
**Figure 5-24. CISPR 25 Radiated Emissions: 150 kHz to 30 MHz, MONOPOLE**



**Figure 5-25. CISPR 25 Radiated Emissions: 30 MHz to 200 MHz, BICON**



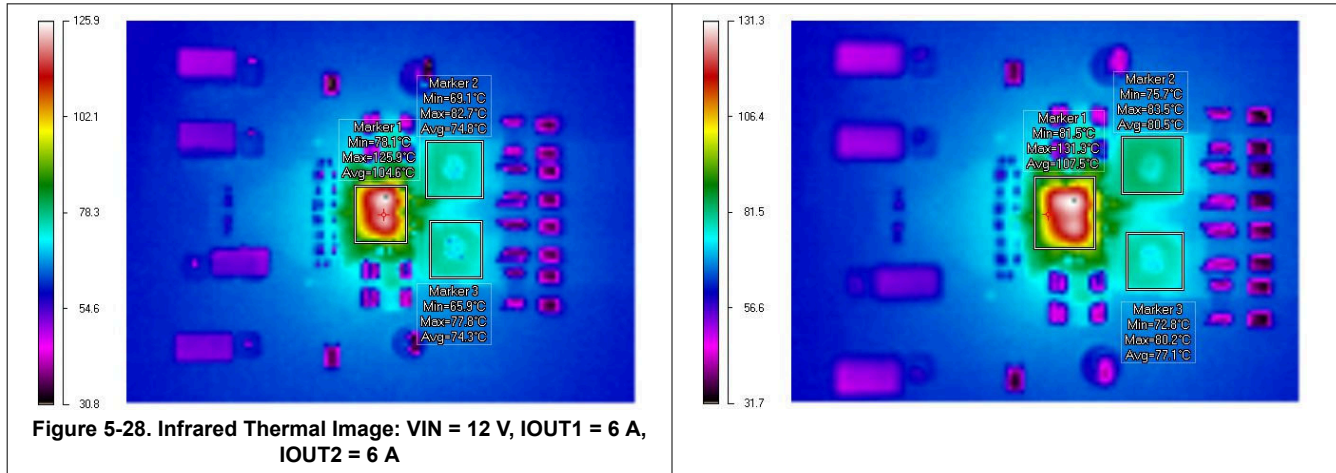
**Figure 5-26. CISPR 25 Radiated Emissions: 200 MHz to 1 GHz, LOG**



**Figure 5-27. CISPR 25 Radiated Emissions: 1 GHz to 2.5G Hz, HORN**



## 5.4 Thermal Performance



## 6 EVM Documentation

### 6.1 Schematic

Figure 6-1 illustrates the EVM schematic.

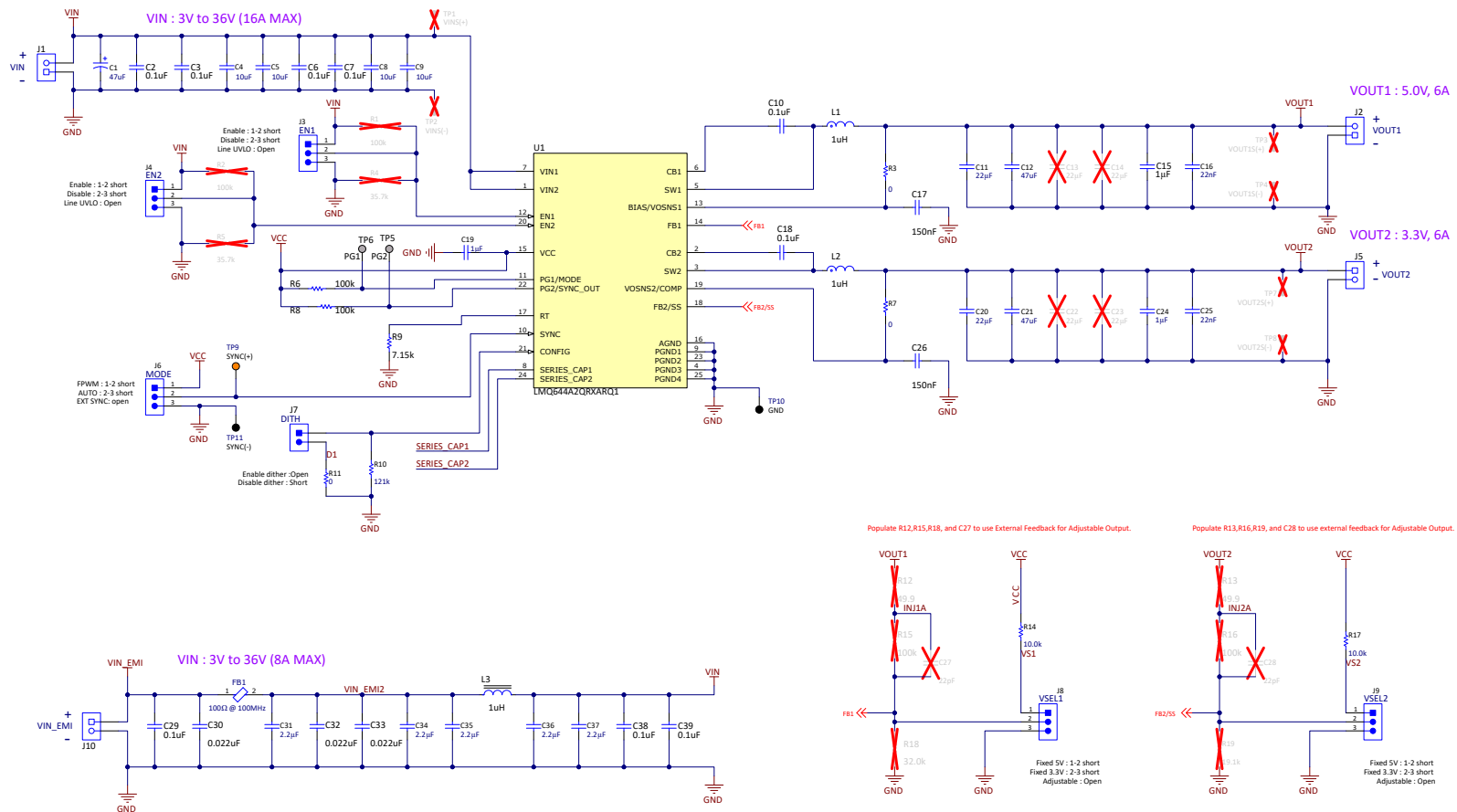


Figure 6-1. EVM Schematic

## 6.2 Bill of Materials

**Table 6-1. Component BOM**

REF DES	QTY	VALUE	DESCRIPTION	PACKAGE	PART NUMBER	MANUFACTURER
C1	1	47 uF	CAP, AL, 47 uF, 50 V, +/- 20%, SMD	D6.3xL7.7mm	865080645012	Würth Elektronik
C2, C3, C6, C7, C29, C38, C39	7	0.1 uF	CAP, CERM, 0.1 uF, 50 V, +/- 10%, X7R, AEC-Q200 Grade 1, 0402	402	GCM155R71H104KE02D	MuRata
C4, C5, C8, C9	4	10 uF	CAP, CERM, 10 uF, 50 V, +/- 10%, X7R, 1206	1206	CL31B106KBHNNNE	Samsung
C10, C18	2	0.1 uF	CAP, CERM, 0.1 uF, 16 V, +/- 10%, X7R, AEC-Q200 Grade 1, 0402	402	C0402C104K4RACAUTO	Kemet
C11, C20	2	22 uF	CAP, CERM, 22 uF, 16 V, +/- 20%, X7S, 1206	1206	GRM31CC71C226ME11L	MuRata
C12, C21	2	47 uF	CAP, CERM, 47 uF, 10 V, +/- 20%, X7R, 1210	1210	GRM32ER71A476ME15L	MuRata
C15, C24	2	1 uF	CAP, CERM, 1 uF, 25 V, +/- 10%, X7R, AEC-Q200 Grade 1, 0603	603	GCM188R71E105KA64D	MuRata
C16, C25	2	0.022 uF	CAP, CERM, 0.022 uF, 50 V, +/- 10%, X7R, 0603	603	C0603C223K5RACTU	Kemet
C17, C26	2	0.15 uF	CAP, CERM, 0.15 uF, 50 V, +/- 10%, X7R, AEC-Q200 Grade 1, 0603	603	CGA3E3X7R1H154K080AB	TDK
C19	1	1 uF	CAP, CERM, 1 uF, 16 V, +/- 20%, X7R, AEC-Q200 Grade 1, 0603	603	GCM188R71C105MA64D	MuRata
C30, C32, C33	3	0.022 uF	CAP, CERM, 0.022 uF, 50 V, +/- 10%, X7R, AEC-Q200 Grade 1, 0402	402	CGA2B3X7R1H223K050BB	TDK
C31, C34, C35, C36, C37	5	2.2 uF	CAP, CERM, 2.2 uF, 50 V, +/- 20%, X7R, 0805	805	C2012X7R1H225M125AC	TDK
FB1	1		100 Ohms at 100 MHz 1 Power Line Ferrite Bead 3312 (8531 Metric) 10 A 4mOhm	3312	78279225101	Würth Electronics
H1, H2, H3, H4	4		Machine Screw, Round, #4-40 x 1/4, Nylon, Philips panhead	Screw	NY PMS 440 0025 PH	B&F Fastener Supply
H5, H6, H7, H8	4		Standoff, Hex, 0.5"L #4-40 Nylon	Standoff	1902C	Keystone
J1, J2, J5, J10	4		Terminal Block, 5 mm, 2x1, Tin, TH	Terminal Block, 5 mm, 2x1, TH	691 101 710 002	Würth Elektronik
J3, J4, J6, J8, J9	5		Header, 2.54 mm, 3x1, Gold, TH	Header, 2.54mm, 3x1, TH	61300311121	Würth Elektronik
J7	1		Header, 2.54 mm, 2x1, Gold, TH	Header, 2.54mm, 2x1, TH	61300211121	Würth Elektronik
L1, L2	2	1 uH	Shielded Power Inductor, 1uH, 20%, 17.8A IRMS, 5.8mOhm DCR max, AECQ200 Grade1, 5.28x5.48x3.1mm	SMT_IND_5MM28_5MM48	XGL5030-102MEC	Coilcraft
L3	1		Inductor, Shielded, Composite, 1.0H, 16.9 A, 0.0084 ohm, AEC-Q200 Grade 1	SMT_5MM28_5MM48	XEL5030-102MEB	Coilcraft
R3, R7, R11	3	0	RES, 0, 5%, 0.1 W, 0603	603	RC0603JR-070RL	Yageo
R6, R8	2	100k	RES, 100 k, 1%, 0.1 W, 0603	603	RC0603FR-07100KL	Yageo

**Table 6-1. Component BOM (continued)**

REF DES	QTY	VALUE	DESCRIPTION	PACKAGE	PART NUMBER	MANUFACTURER
R9	1	7.15k	RES, 7.15 k, 1%, 0.1 W, 0603	603	RC0603FR-077K15L	Yageo
R10	1	121k	RES, 121 k, 1%, 0.1 W, 0603	603	RC0603FR-07121KL	Yageo
R14, R17	2	10.0k	RES, 10.0 k, 1%, 0.1 W, 0603	603	RC0603FR-0710KL	Yageo
SH-J1, SH-J2, SH-J3, SH-J4, SH-J5, SH-J6	6		Single Operation 2.54mm Pitch Open Top Jumper Socket	Single Operation 2.54mm Pitch Open Top Jumper Socket	M7582-05	Harwin
TP5, TP6	2		Test Point, SMT	Test Point, SMT	S2751-46R	Harwin
TP9	1		Test Point, Multipurpose, Orange, TH	Orange Multipurpose Testpoint	5013	Keystone Electronics
TP10, TP11	2		Test Point, Multipurpose, Black, TH	Black Multipurpose Testpoint	5011	Keystone Electronics
U1	1		LMQ644A2-Q1 3-V to 36-V, 12 A, Low Iq dual buck converter	WQFN-FCRLF24	LMQ644A2QRXARQ1	Texas Instruments

### 6.3 PCB Layout

The PCB is 62-mils standard thickness with 2-oz copper on all layers.

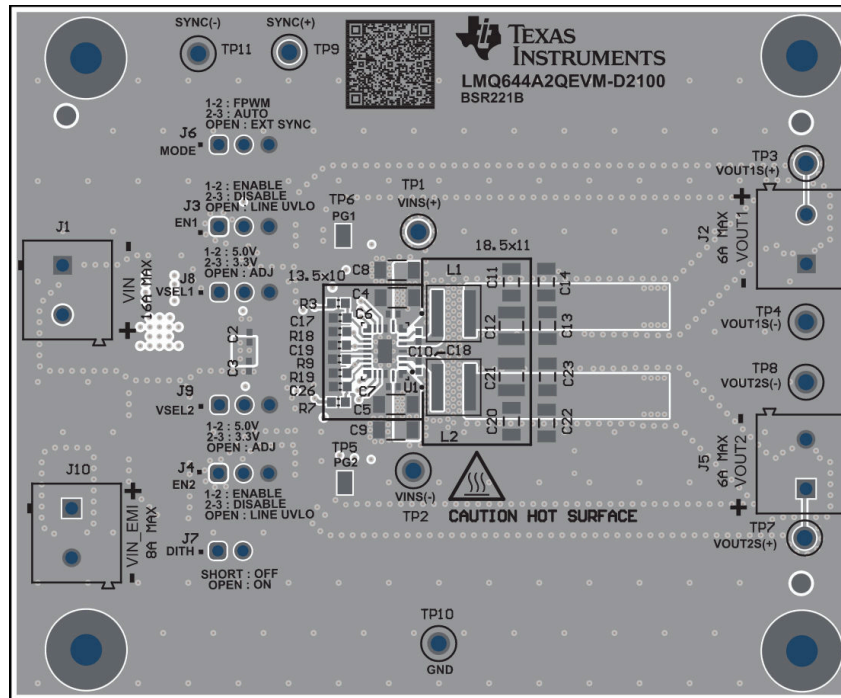


Figure 6-2. Top Component View

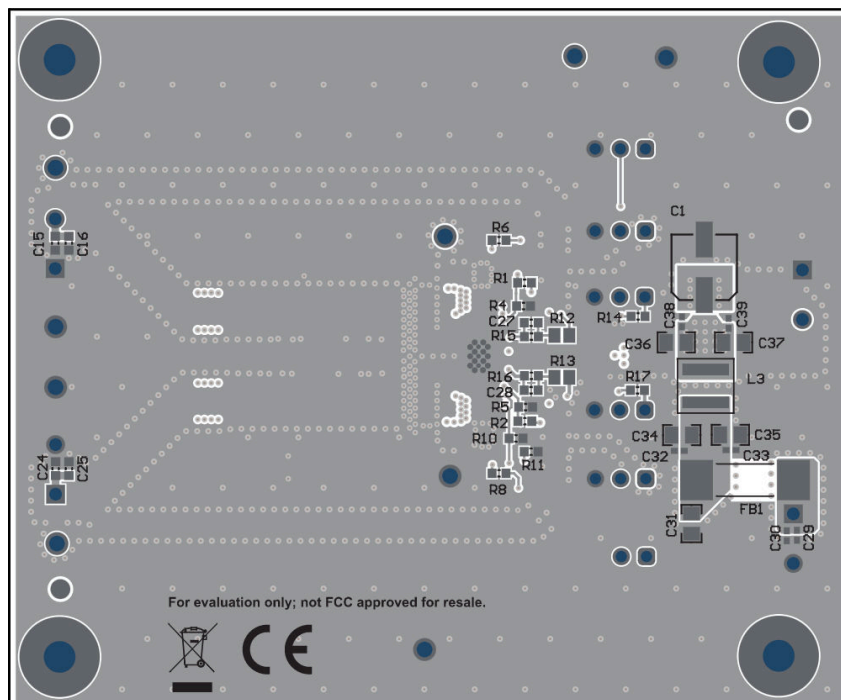
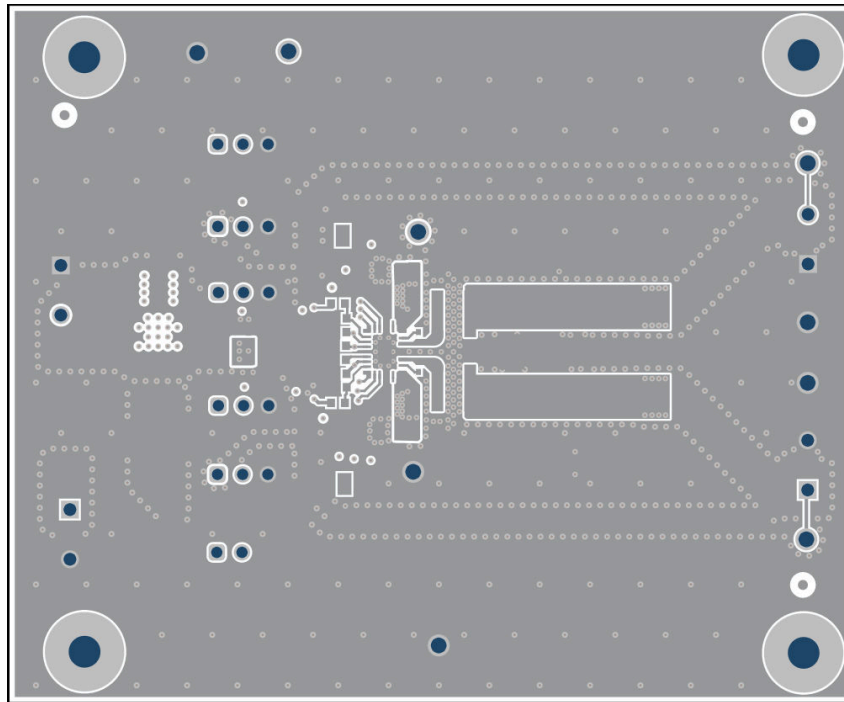
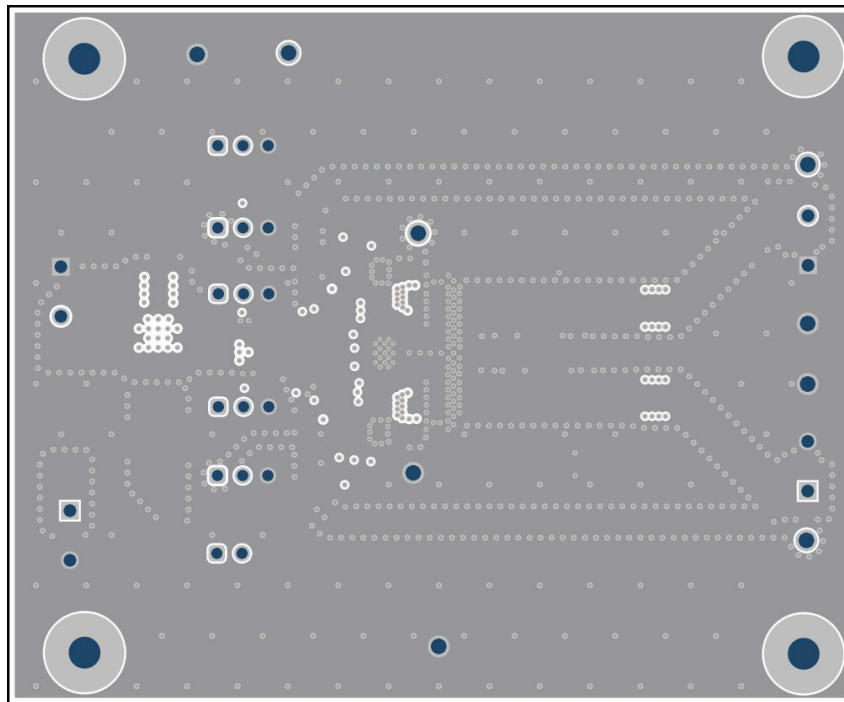


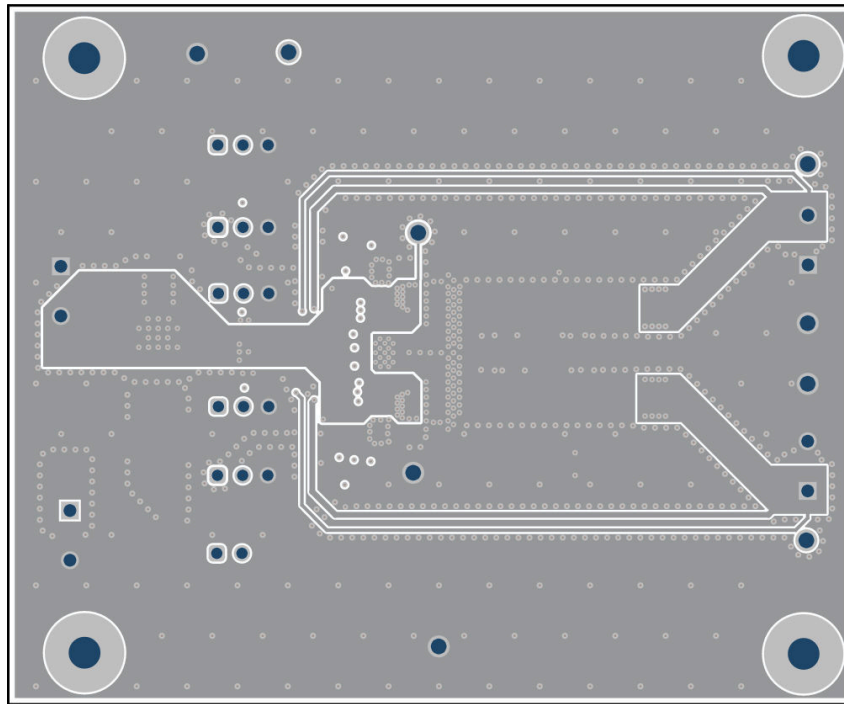
Figure 6-3. Bottom Component View



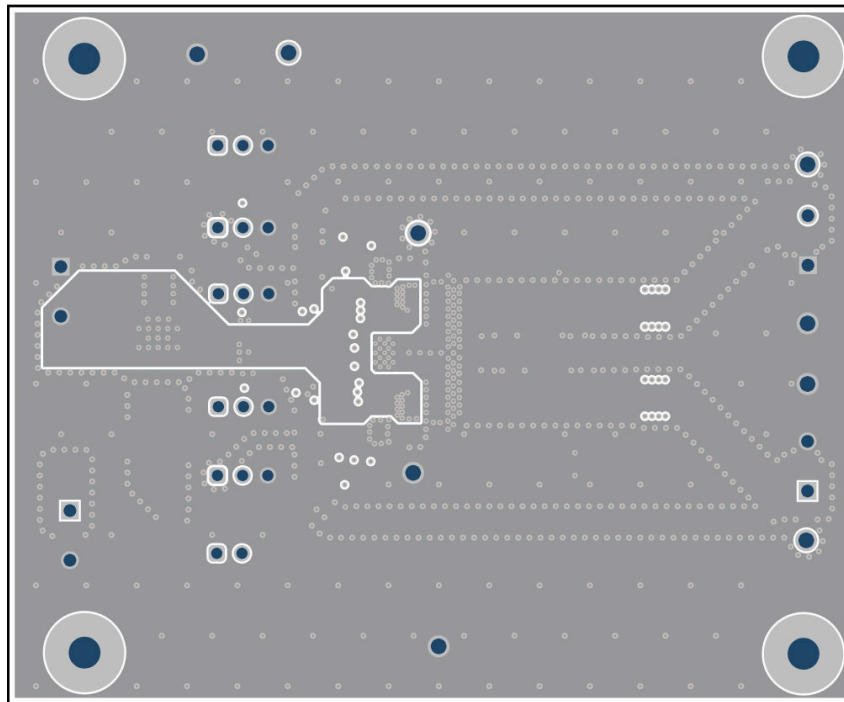
**Figure 6-4. Top Layer Copper**



**Figure 6-5. Layer 2 Copper**

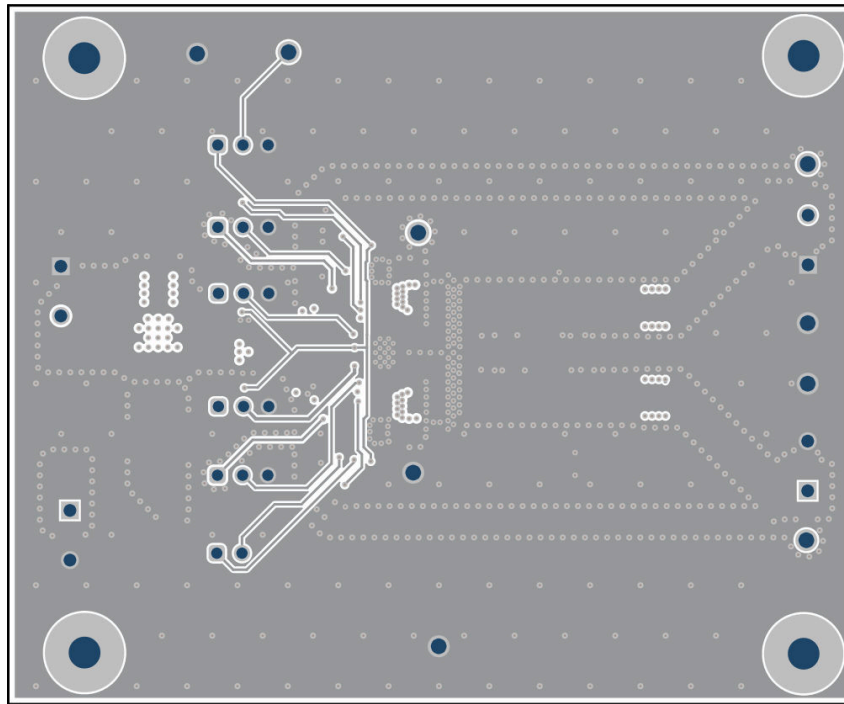


**Figure 6-6. Layer 3 Copper**

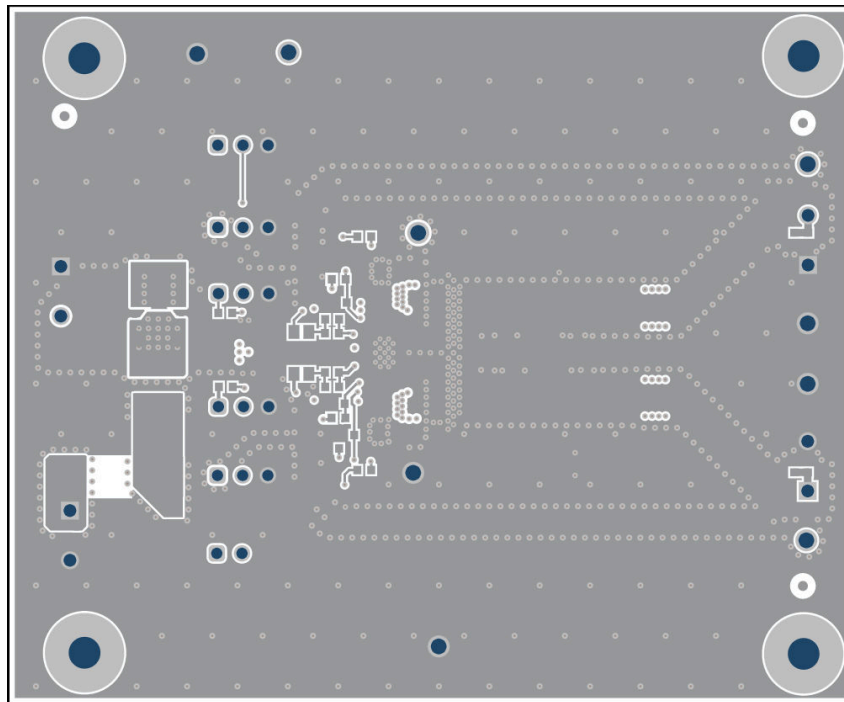


**Figure 6-7. Layer 4 Copper**





**Figure 6-8. Layer 5 Copper**



**Figure 6-9. Bottom Layer Copper (Viewed From Top)**

## 7 Device and Documentation Support

### 7.1 Device Support

#### 7.1.1 Development Support

For development support see the following:

- For TI's reference design library, visit [TI Designs](#).
- For TI's WEBENCH Design Environment, visit the [WEBENCH® Design Center](#).
- To design a low-EMI power supply, review TI's comprehensive [EMI Training Series](#).
- Technical Articles:
  - [How Device-level Features And Package Options Can Help Minimize EMI In Automotive Designs](#)
  - [Optimizing Flip-chip IC Thermal Performance In Automotive Designs](#)

##### 7.1.1.1 Custom Design With WEBENCH® Tools

[Click here](#) to create a custom design using the LMQ644A2-Q1 device with WEBENCH® Power Designer.

1. Start by entering the input voltage ( $V_{IN}$ ), output voltage ( $V_{OUT}$ ), and output current ( $I_{OUT}$ ) requirements.
2. Optimize the design for key parameters such as efficiency, footprint, and cost using the optimizer dial.
3. Compare the generated design with other possible solutions from Texas Instruments.

The WEBENCH Power Designer provides a customized schematic along with a list of materials with real-time pricing and component availability.

In most cases, these actions are available:

- Run electrical simulations to see important waveforms and circuit performance.
- Run thermal simulations to understand board thermal performance.
- Export customized schematic and layout into popular CAD formats.
- Print PDF reports for the design, and share the design with colleagues.

Get more information about WEBENCH tools at [www.ti.com/WEBENCH](http://www.ti.com/WEBENCH).

### 7.2 Documentation Support

#### 7.2.1 Related Documentation

For related documentation, see the following:

- Texas Instruments, [An Engineer's Guide To EMI In DC/DC Regulators](#) e-book
- Texas Instruments, [EMI Filter Components And Their Nonidealities For Automotive DC/DC Regulators](#) technical brief
- Texas Instruments, [Designing High Performance, Low-EMI, Automotive Power Supplies](#) application report
- Texas Instruments, [AN-2020 Thermal Design By Insight, Not Hindsight](#) application report
- Texas Instruments, [AN-2162 Simple Success With Conducted EMI From DC/DC Converters Application Report](#) application report
- Texas Instruments, [Practical Thermal Design With DC/DC Power Modules](#) application report

## STANDARD TERMS FOR EVALUATION MODULES

1. *Delivery:* TI delivers TI evaluation boards, kits, or modules, including any accompanying demonstration software, components, and/or documentation which may be provided together or separately (collectively, an "EVM" or "EVMs") to the User ("User") in accordance with the terms set forth herein. User's acceptance of the EVM is expressly subject to the following terms.
  - 1.1 EVMs are intended solely for product or software developers for use in a research and development setting to facilitate feasibility evaluation, experimentation, or scientific analysis of TI semiconductors products. EVMs have no direct function and are not finished products. EVMs shall not be directly or indirectly assembled as a part or subassembly in any finished product. For clarification, any software or software tools provided with the EVM ("Software") shall not be subject to the terms and conditions set forth herein but rather shall be subject to the applicable terms that accompany such Software
  - 1.2 EVMs are not intended for consumer or household use. EVMs may not be sold, sublicensed, leased, rented, loaned, assigned, or otherwise distributed for commercial purposes by Users, in whole or in part, or used in any finished product or production system.
2. *Limited Warranty and Related Remedies/Disclaimers:*
  - 2.1 These terms do not apply to Software. The warranty, if any, for Software is covered in the applicable Software License Agreement.
  - 2.2 TI warrants that the TI EVM will conform to TI's published specifications for ninety (90) days after the date TI delivers such EVM to User. Notwithstanding the foregoing, TI shall not be liable for a nonconforming EVM if (a) the nonconformity was caused by neglect, misuse or mistreatment by an entity other than TI, including improper installation or testing, or for any EVMs that have been altered or modified in any way by an entity other than TI, (b) the nonconformity resulted from User's design, specifications or instructions for such EVMs or improper system design, or (c) User has not paid on time. Testing and other quality control techniques are used to the extent TI deems necessary. TI does not test all parameters of each EVM. User's claims against TI under this Section 2 are void if User fails to notify TI of any apparent defects in the EVMs within ten (10) business days after delivery, or of any hidden defects with ten (10) business days after the defect has been detected.
  - 2.3 TI's sole liability shall be at its option to repair or replace EVMs that fail to conform to the warranty set forth above, or credit User's account for such EVM. TI's liability under this warranty shall be limited to EVMs that are returned during the warranty period to the address designated by TI and that are determined by TI not to conform to such warranty. If TI elects to repair or replace such EVM, TI shall have a reasonable time to repair such EVM or provide replacements. Repaired EVMs shall be warranted for the remainder of the original warranty period. Replaced EVMs shall be warranted for a new full ninety (90) day warranty period.

### **WARNING**

**Evaluation Kits are intended solely for use by technically qualified, professional electronics experts who are familiar with the dangers and application risks associated with handling electrical mechanical components, systems, and subsystems.**

**User shall operate the Evaluation Kit within TI's recommended guidelines and any applicable legal or environmental requirements as well as reasonable and customary safeguards. Failure to set up and/or operate the Evaluation Kit within TI's recommended guidelines may result in personal injury or death or property damage. Proper set up entails following TI's instructions for electrical ratings of interface circuits such as input, output and electrical loads.**

**NOTE:**

**EXPOSURE TO ELECTROSTATIC DISCHARGE (ESD) MAY CAUSE DEGRADATION OR FAILURE OF THE EVALUATION KIT; TI RECOMMENDS STORAGE OF THE EVALUATION KIT IN A PROTECTIVE ESD BAG.**

### 3 Regulatory Notices:

#### 3.1 United States

##### 3.1.1 Notice applicable to EVMs not FCC-Approved:

**FCC NOTICE:** This kit is designed to allow product developers to evaluate electronic components, circuitry, or software associated with the kit to determine whether to incorporate such items in a finished product and software developers to write software applications for use with the end product. This kit is not a finished product and when assembled may not be resold or otherwise marketed unless all required FCC equipment authorizations are first obtained. Operation is subject to the condition that this product not cause harmful interference to licensed radio stations and that this product accept harmful interference. Unless the assembled kit is designed to operate under part 15, part 18 or part 95 of this chapter, the operator of the kit must operate under the authority of an FCC license holder or must secure an experimental authorization under part 5 of this chapter.

##### 3.1.2 For EVMs annotated as FCC – FEDERAL COMMUNICATIONS COMMISSION Part 15 Compliant:

#### **CAUTION**

This device complies with part 15 of the FCC Rules. Operation is subject to the following two conditions: (1) This device may not cause harmful interference, and (2) this device must accept any interference received, including interference that may cause undesired operation.

Changes or modifications not expressly approved by the party responsible for compliance could void the user's authority to operate the equipment.

#### **FCC Interference Statement for Class A EVM devices**

*NOTE: This equipment has been tested and found to comply with the limits for a Class A digital device, pursuant to part 15 of the FCC Rules. These limits are designed to provide reasonable protection against harmful interference when the equipment is operated in a commercial environment. This equipment generates, uses, and can radiate radio frequency energy and, if not installed and used in accordance with the instruction manual, may cause harmful interference to radio communications. Operation of this equipment in a residential area is likely to cause harmful interference in which case the user will be required to correct the interference at his own expense.*

#### **FCC Interference Statement for Class B EVM devices**

*NOTE: This equipment has been tested and found to comply with the limits for a Class B digital device, pursuant to part 15 of the FCC Rules. These limits are designed to provide reasonable protection against harmful interference in a residential installation. This equipment generates, uses and can radiate radio frequency energy and, if not installed and used in accordance with the instructions, may cause harmful interference to radio communications. However, there is no guarantee that interference will not occur in a particular installation. If this equipment does cause harmful interference to radio or television reception, which can be determined by turning the equipment off and on, the user is encouraged to try to correct the interference by one or more of the following measures:*

- Reorient or relocate the receiving antenna.
- Increase the separation between the equipment and receiver.
- Connect the equipment into an outlet on a circuit different from that to which the receiver is connected.
- Consult the dealer or an experienced radio/TV technician for help.

#### 3.2 Canada

##### 3.2.1 For EVMs issued with an Industry Canada Certificate of Conformance to RSS-210 or RSS-247

#### **Concerning EVMs Including Radio Transmitters:**

This device complies with Industry Canada license-exempt RSSs. Operation is subject to the following two conditions:

(1) this device may not cause interference, and (2) this device must accept any interference, including interference that may cause undesired operation of the device.

#### **Concernant les EVMs avec appareils radio:**

Le présent appareil est conforme aux CNR d'Industrie Canada applicables aux appareils radio exempts de licence. L'exploitation est autorisée aux deux conditions suivantes: (1) l'appareil ne doit pas produire de brouillage, et (2) l'utilisateur de l'appareil doit accepter tout brouillage radioélectrique subi, même si le brouillage est susceptible d'en compromettre le fonctionnement.

#### **Concerning EVMs Including Detachable Antennas:**

Under Industry Canada regulations, this radio transmitter may only operate using an antenna of a type and maximum (or lesser) gain approved for the transmitter by Industry Canada. To reduce potential radio interference to other users, the antenna type and its gain should be so chosen that the equivalent isotropically radiated power (e.i.r.p.) is not more than that necessary for successful communication. This radio transmitter has been approved by Industry Canada to operate with the antenna types listed in the user guide with the maximum permissible gain and required antenna impedance for each antenna type indicated. Antenna types not included in this list, having a gain greater than the maximum gain indicated for that type, are strictly prohibited for use with this device.

### Concernant les EVMs avec antennes détachables

Conformément à la réglementation d'Industrie Canada, le présent émetteur radio peut fonctionner avec une antenne d'un type et d'un gain maximal (ou inférieur) approuvé pour l'émetteur par Industrie Canada. Dans le but de réduire les risques de brouillage radioélectrique à l'intention des autres utilisateurs, il faut choisir le type d'antenne et son gain de sorte que la puissance isotrope rayonnée équivalente (p.i.r.e.) ne dépasse pas l'intensité nécessaire à l'établissement d'une communication satisfaisante. Le présent émetteur radio a été approuvé par Industrie Canada pour fonctionner avec les types d'antenne énumérés dans le manuel d'usage et ayant un gain admissible maximal et l'impédance requise pour chaque type d'antenne. Les types d'antenne non inclus dans cette liste, ou dont le gain est supérieur au gain maximal indiqué, sont strictement interdits pour l'exploitation de l'émetteur.

#### 3.3 Japan

3.3.1 *Notice for EVMs delivered in Japan:* Please see [http://www.tij.co.jp/lstds/ti\\_ja/general/eStore/notice\\_01.page](http://www.tij.co.jp/lstds/ti_ja/general/eStore/notice_01.page) 日本国内に輸入される評価用キット、ボードについては、次のところをご覧ください。

<https://www.ti.com/ja-jp/legal/notice-for-evaluation-kits-delivered-in-japan.html>

3.3.2 *Notice for Users of EVMs Considered "Radio Frequency Products" in Japan:* EVMs entering Japan may not be certified by TI as conforming to Technical Regulations of Radio Law of Japan.

If User uses EVMs in Japan, not certified to Technical Regulations of Radio Law of Japan, User is required to follow the instructions set forth by Radio Law of Japan, which includes, but is not limited to, the instructions below with respect to EVMs (which for the avoidance of doubt are stated strictly for convenience and should be verified by User):

1. Use EVMs in a shielded room or any other test facility as defined in the notification #173 issued by Ministry of Internal Affairs and Communications on March 28, 2006, based on Sub-section 1.1 of Article 6 of the Ministry's Rule for Enforcement of Radio Law of Japan,
2. Use EVMs only after User obtains the license of Test Radio Station as provided in Radio Law of Japan with respect to EVMs, or
3. Use of EVMs only after User obtains the Technical Regulations Conformity Certification as provided in Radio Law of Japan with respect to EVMs. Also, do not transfer EVMs, unless User gives the same notice above to the transferee. Please note that if User does not follow the instructions above, User will be subject to penalties of Radio Law of Japan.

【無線電波を送信する製品の開発キットをお使いになる際の注意事項】 開発キットの中には技術基準適合証明を受けていないものがあります。技術適合証明を受けていないものご使用に際しては、電波法遵守のため、以下のいずれかの措置を取っていただく必要がありますのでご注意ください。

1. 電波法施行規則第6条第1項第1号に基づく平成18年3月28日総務省告示第173号で定められた電波暗室等の試験設備でご使用いただく。
2. 実験局の免許を取得後ご使用いただく。
3. 技術基準適合証明を取得後ご使用いただく。

なお、本製品は、上記の「ご使用にあたっての注意」を譲渡先、移転先に通知しない限り、譲渡、移転できないものとします。

上記を遵守頂けない場合は、電波法の罰則が適用される可能性があることをご留意ください。日本テキサス・イ

ンスツルメンツ株式会社

東京都新宿区西新宿 6 丁目 2 4 番 1 号

西新宿三井ビル

3.3.3 *Notice for EVMs for Power Line Communication:* Please see [http://www.tij.co.jp/lstds/ti\\_ja/general/eStore/notice\\_02.page](http://www.tij.co.jp/lstds/ti_ja/general/eStore/notice_02.page)

電力線搬送波通信についての開発キットをお使いになる際の注意事項については、次のところをご覧ください。 <https://www.ti.com/ja-jp/legal/notice-for-evaluation-kits-for-power-line-communication.html>

#### 3.4 European Union

3.4.1 *For EVMs subject to EU Directive 2014/30/EU (Electromagnetic Compatibility Directive):*

This is a class A product intended for use in environments other than domestic environments that are connected to a low-voltage power-supply network that supplies buildings used for domestic purposes. In a domestic environment this product may cause radio interference in which case the user may be required to take adequate measures.

- 
4. *EVM Use Restrictions and Warnings:*
    - 4.1 EVMS ARE NOT FOR USE IN FUNCTIONAL SAFETY AND/OR SAFETY CRITICAL EVALUATIONS, INCLUDING BUT NOT LIMITED TO EVALUATIONS OF LIFE SUPPORT APPLICATIONS.
    - 4.2 User must read and apply the user guide and other available documentation provided by TI regarding the EVM prior to handling or using the EVM, including without limitation any warning or restriction notices. The notices contain important safety information related to, for example, temperatures and voltages.
    - 4.3 *Safety-Related Warnings and Restrictions:*
      - 4.3.1 User shall operate the EVM within TI's recommended specifications and environmental considerations stated in the user guide, other available documentation provided by TI, and any other applicable requirements and employ reasonable and customary safeguards. Exceeding the specified performance ratings and specifications (including but not limited to input and output voltage, current, power, and environmental ranges) for the EVM may cause personal injury or death, or property damage. If there are questions concerning performance ratings and specifications, User should contact a TI field representative prior to connecting interface electronics including input power and intended loads. Any loads applied outside of the specified output range may also result in unintended and/or inaccurate operation and/or possible permanent damage to the EVM and/or interface electronics. Please consult the EVM user guide prior to connecting any load to the EVM output. If there is uncertainty as to the load specification, please contact a TI field representative. During normal operation, even with the inputs and outputs kept within the specified allowable ranges, some circuit components may have elevated case temperatures. These components include but are not limited to linear regulators, switching transistors, pass transistors, current sense resistors, and heat sinks, which can be identified using the information in the associated documentation. When working with the EVM, please be aware that the EVM may become very warm.
      - 4.3.2 EVMs are intended solely for use by technically qualified, professional electronics experts who are familiar with the dangers and application risks associated with handling electrical mechanical components, systems, and subsystems. User assumes all responsibility and liability for proper and safe handling and use of the EVM by User or its employees, affiliates, contractors or designees. User assumes all responsibility and liability to ensure that any interfaces (electronic and/or mechanical) between the EVM and any human body are designed with suitable isolation and means to safely limit accessible leakage currents to minimize the risk of electrical shock hazard. User assumes all responsibility and liability for any improper or unsafe handling or use of the EVM by User or its employees, affiliates, contractors or designees.
    - 4.4 User assumes all responsibility and liability to determine whether the EVM is subject to any applicable international, federal, state, or local laws and regulations related to User's handling and use of the EVM and, if applicable, User assumes all responsibility and liability for compliance in all respects with such laws and regulations. User assumes all responsibility and liability for proper disposal and recycling of the EVM consistent with all applicable international, federal, state, and local requirements.
  5. *Accuracy of Information:* To the extent TI provides information on the availability and function of EVMs, TI attempts to be as accurate as possible. However, TI does not warrant the accuracy of EVM descriptions, EVM availability or other information on its websites as accurate, complete, reliable, current, or error-free.
  6. *Disclaimers:*
    - 6.1 EXCEPT AS SET FORTH ABOVE, EVMS AND ANY MATERIALS PROVIDED WITH THE EVM (INCLUDING, BUT NOT LIMITED TO, REFERENCE DESIGNS AND THE DESIGN OF THE EVM ITSELF) ARE PROVIDED "AS IS" AND "WITH ALL FAULTS." TI DISCLAIMS ALL OTHER WARRANTIES, EXPRESS OR IMPLIED, REGARDING SUCH ITEMS, INCLUDING BUT NOT LIMITED TO ANY EPIDEMIC FAILURE WARRANTY OR IMPLIED WARRANTIES OF MERCHANTABILITY OR FITNESS FOR A PARTICULAR PURPOSE OR NON-INFRINGEMENT OF ANY THIRD PARTY PATENTS, COPYRIGHTS, TRADE SECRETS OR OTHER INTELLECTUAL PROPERTY RIGHTS.
    - 6.2 EXCEPT FOR THE LIMITED RIGHT TO USE THE EVM SET FORTH HEREIN, NOTHING IN THESE TERMS SHALL BE CONSTRUED AS GRANTING OR CONFERRING ANY RIGHTS BY LICENSE, PATENT, OR ANY OTHER INDUSTRIAL OR INTELLECTUAL PROPERTY RIGHT OF TI, ITS SUPPLIERS/LICENSORS OR ANY OTHER THIRD PARTY, TO USE THE EVM IN ANY FINISHED END-USER OR READY-TO-USE FINAL PRODUCT, OR FOR ANY INVENTION, DISCOVERY OR IMPROVEMENT, REGARDLESS OF WHEN MADE, CONCEIVED OR ACQUIRED.
  7. *USER'S INDEMNITY OBLIGATIONS AND REPRESENTATIONS.* USER WILL DEFEND, INDEMNIFY AND HOLD TI, ITS LICENSORS AND THEIR REPRESENTATIVES HARMLESS FROM AND AGAINST ANY AND ALL CLAIMS, DAMAGES, LOSSES, EXPENSES, COSTS AND LIABILITIES (COLLECTIVELY, "CLAIMS") ARISING OUT OF OR IN CONNECTION WITH ANY HANDLING OR USE OF THE EVM THAT IS NOT IN ACCORDANCE WITH THESE TERMS. THIS OBLIGATION SHALL APPLY WHETHER CLAIMS ARISE UNDER STATUTE, REGULATION, OR THE LAW OF TORT, CONTRACT OR ANY OTHER LEGAL THEORY, AND EVEN IF THE EVM FAILS TO PERFORM AS DESCRIBED OR EXPECTED.

8. *Limitations on Damages and Liability:*

8.1 *General Limitations.* IN NO EVENT SHALL TI BE LIABLE FOR ANY SPECIAL, COLLATERAL, INDIRECT, PUNITIVE, INCIDENTAL, CONSEQUENTIAL, OR EXEMPLARY DAMAGES IN CONNECTION WITH OR ARISING OUT OF THESE TERMS OR THE USE OF THE EVMS , REGARDLESS OF WHETHER TI HAS BEEN ADVISED OF THE POSSIBILITY OF SUCH DAMAGES. EXCLUDED DAMAGES INCLUDE, BUT ARE NOT LIMITED TO, COST OF REMOVAL OR REINSTALLATION, ANCILLARY COSTS TO THE PROCUREMENT OF SUBSTITUTE GOODS OR SERVICES, RETESTING, OUTSIDE COMPUTER TIME, LABOR COSTS, LOSS OF GOODWILL, LOSS OF PROFITS, LOSS OF SAVINGS, LOSS OF USE, LOSS OF DATA, OR BUSINESS INTERRUPTION. NO CLAIM, SUIT OR ACTION SHALL BE BROUGHT AGAINST TI MORE THAN TWELVE (12) MONTHS AFTER THE EVENT THAT GAVE RISE TO THE CAUSE OF ACTION HAS OCCURRED.

8.2 *Specific Limitations.* IN NO EVENT SHALL TI'S AGGREGATE LIABILITY FROM ANY USE OF AN EVM PROVIDED HEREUNDER, INCLUDING FROM ANY WARRANTY, INDEMNITY OR OTHER OBLIGATION ARISING OUT OF OR IN CONNECTION WITH THESE TERMS, , EXCEED THE TOTAL AMOUNT PAID TO TI BY USER FOR THE PARTICULAR EVM(S) AT ISSUE DURING THE PRIOR TWELVE (12) MONTHS WITH RESPECT TO WHICH LOSSES OR DAMAGES ARE CLAIMED. THE EXISTENCE OF MORE THAN ONE CLAIM SHALL NOT ENLARGE OR EXTEND THIS LIMIT.

9. *Return Policy.* Except as otherwise provided, TI does not offer any refunds, returns, or exchanges. Furthermore, no return of EVM(s) will be accepted if the package has been opened and no return of the EVM(s) will be accepted if they are damaged or otherwise not in a resalable condition. If User feels it has been incorrectly charged for the EVM(s) it ordered or that delivery violates the applicable order, User should contact TI. All refunds will be made in full within thirty (30) working days from the return of the components(s), excluding any postage or packaging costs.

10. *Governing Law:* These terms and conditions shall be governed by and interpreted in accordance with the laws of the State of Texas, without reference to conflict-of-laws principles. User agrees that non-exclusive jurisdiction for any dispute arising out of or relating to these terms and conditions lies within courts located in the State of Texas and consents to venue in Dallas County, Texas. Notwithstanding the foregoing, any judgment may be enforced in any United States or foreign court, and TI may seek injunctive relief in any United States or foreign court.

Mailing Address: Texas Instruments, Post Office Box 655303, Dallas, Texas 75265  
Copyright © 2023, Texas Instruments Incorporated



## IMPORTANT NOTICE AND DISCLAIMER

TI PROVIDES TECHNICAL AND RELIABILITY DATA (INCLUDING DATA SHEETS), DESIGN RESOURCES (INCLUDING REFERENCE DESIGNS), APPLICATION OR OTHER DESIGN ADVICE, WEB TOOLS, SAFETY INFORMATION, AND OTHER RESOURCES "AS IS" AND WITH ALL FAULTS, AND DISCLAIMS ALL WARRANTIES, EXPRESS AND IMPLIED, INCLUDING WITHOUT LIMITATION ANY IMPLIED WARRANTIES OF MERCHANTABILITY, FITNESS FOR A PARTICULAR PURPOSE OR NON-INFRINGEMENT OF THIRD PARTY INTELLECTUAL PROPERTY RIGHTS.

These resources are intended for skilled developers designing with TI products. You are solely responsible for (1) selecting the appropriate TI products for your application, (2) designing, validating and testing your application, and (3) ensuring your application meets applicable standards, and any other safety, security, regulatory or other requirements.

These resources are subject to change without notice. TI grants you permission to use these resources only for development of an application that uses the TI products described in the resource. Other reproduction and display of these resources is prohibited. No license is granted to any other TI intellectual property right or to any third party intellectual property right. TI disclaims responsibility for, and you will fully indemnify TI and its representatives against, any claims, damages, costs, losses, and liabilities arising out of your use of these resources.

TI's products are provided subject to [TI's Terms of Sale](#) or other applicable terms available either on [ti.com](https://www.ti.com) or provided in conjunction with such TI products. TI's provision of these resources does not expand or otherwise alter TI's applicable warranties or warranty disclaimers for TI products.

TI objects to and rejects any additional or different terms you may have proposed.

Mailing Address: Texas Instruments, Post Office Box 655303, Dallas, Texas 75265  
Copyright © 2023, Texas Instruments Incorporated