

AN-1910 LMK04000 Family Phase Noise Characterization

ABSTRACT

The purpose of this applications report is to present phase noise and jitter measurements representing the clock outputs of the LMK04000 family of Precision Clock Conditioners, when paired with various voltage controlled oscillators (VCXOs). The intent is to illustrate the relationship between clock output phase noise and VCXO phase noise.

Contents

1	Introduction	4
2	LMK04000 Family Description	5
3	LMK04000 Clock Output Phase Noise and Jitter	6
3.1	CTS Model 357 VCXO	8
3.2	Crystek CVHD-950-122.88 MHz VCXO	11
3.3	Crystek CVHD-950-80 VCXO	14
3.4	Crystek CVPD-920-61.44 VCXO	17
3.5	Epson Toyocom VG-4501 VCXO	20
3.6	Epson-Toyocom VG-4231 VCXO	23
3.7	Epson-Toyocom TCO-2111-AA VCXO	26
3.8	Suntsu SVD Series VCXO, 54 MHz	29
3.9	Suntsu SVD Series VCXO, 61.44 MHz	32
3.10	Suntsu SVD Series VCXO, 30.72 MHz	35
3.11	Vectron Model 5310 VCXO, 155.52 MHz	38
3.12	Vectron Model 5310 VCXO, 134.4 MHz	41

List of Figures

1	Dual-PLL Jitter Cleaning Clock Synthesizer Architecture	5
2	LMK04000 Family Block Diagram	6
3	PLL1 and PLL2 Loop Filter Components	7
4	Phase Noise and Jitter Measurement Test Setup	7
5	CTS Model 357 VCXO Open Loop Phase Noise, 61.44 MHz	9
6	LMK04031 Fout Phase Noise, CTS model 357 VCXO	9
7	LMK04031 LVDS Phase Noise, CTS model 357 VCXO	10
8	LMK04031 LVCMOS Phase Noise, CTS model 357 VCXO	10
9	LMK04031 LVPECL Phase Noise, CTS model 357 VCXO	11
10	Crystek CVHD-950-122.88 VCXO Open Loop Phase Noise	12
11	LMK04031 Fout Phase Noise, Crystek CVHD-950-122.88 VCXO	12
12	LMK04031 LVDS Phase Noise, Crystek CVHD-950-122.88 VCXO	13
13	LMK04031 LVCMOS Phase Noise, Crystek CVHD-950-122.88 VCXO	13
14	LMK04031 LVPECL Phase Noise, Crystek CVHD-950-122.88 VCXO	14
15	Crystek CVHD-950-80 VCXO Open Loop Phase Noise	15
16	LMK04031 Fout Phase Noise, Crystek CVHD-950-80 VCXO	15
17	LMK04031 LVDS Phase Noise, Crystek CVHD-950-80 VCXO	16
18	LMK04031 LVCMOS Phase Noise, Crystek CVHD-950-80 VCXO	16

All trademarks are the property of their respective owners.

19	LMK04031 LVPECL Phase Noise, Crystek CVHD-950-80 VCXO.....	17
20	Crystek CVPD-920-61.44 VCXO Open Loop Phase Noise.....	18
21	LMK04031 Fout Phase Noise, Crystek CVPD-920-61.44 VCXO	18
22	LMK04031 LVDS Phase Noise, Crystek CVPD-920-61.44 VCXO	19
23	LMK04031 LVCMOS Phase Noise, Crystek CVPD-920-61.44 VCXO	19
24	LMK04031 LVPECL Phase Noise, Crystek CVPD-920-61.44 VCXO	20
25	Epson Toyocom VG-4501 VCXO, 61.44 MHz, Open Loop Phase Noise.....	21
26	LMK04031 Fout Phase Noise, Epson Toyocom VG-4501 VCXO	21
27	LMK04031 LVDS Phase Noise, Epson Toyocom VG-4501 VCXO.....	22
28	LMK04031 LVCMOS Phase Noise, Epson Toyocom VG-4501 VCXO	22
29	LMK04031 LVPECL Phase Noise, Epson Toyocom VG-4501 VCXO	23
30	Epson Toyocom VG-4231 VCXO, 19.44 MHz, Open Loop Phase Noise.....	24
31	LMK04031 Fout Phase Noise, Epson Toyocom VG-4231 VCXO	24
32	LMK04031 LVDS Phase Noise, Epson Toyocom VG-4231 VCXO.....	25
33	LMK04031 LVCMOS Phase Noise, Epson Toyocom VG-4231 VCXO	25
34	LMK04031 LVPECL Phase Noise, Epson Toyocom VG-4231 VCXO	26
35	Epson Toyocom TCO-2111-AA VCXO, 245.76 MHz, Open Loop Phase Noise.....	27
36	LMK04031 Fout Phase Noise, Epson Toyocom TCO-2111-AA VCXO	27
37	LMK04031 LVDS Phase Noise, Epson Toyocom TCO-2111-AA VCXO	28
38	LMK04031 LVCMOS Phase Noise, Epson Toyocom TCO-2111-AA VCXO	28
39	LMK04031 LVPECL Phase Noise, Epson Toyocom TCO-2111-AA VCXO	29
40	Suntsu SVD Series VCXO, 54 MHz, Open Loop Phase Noise	30
41	LMK04031 Fout Phase Noise, Suntsu SVD Series VCXO, 54 MHz	30
42	LMK04031 LVDS Phase Noise, Suntsu SVD Series VCXO, 54 MHz.....	31
43	LMK04031 LVCMOS Phase Noise, Suntsu SVD Series VCXO, 54 MHz	31
44	LMK04031 LVPECL Phase Noise, Suntsu SVD Series VCXO, 54 MHz	32
45	Suntsu SVD Series VCXO, 61.44 MHz, Open Loop Phase Noise	33
46	LMK04031 Fout Phase Noise, Suntsu SVD Series VCXO, 61.44 MHz.....	33
47	LMK04031 LVDS Phase Noise, Suntsu SVD Series VCXO, 61.44 MHz	34
48	LMK04031 LVCMOS Phase Noise, Suntsu SVD Series VCXO, 61.44 MHz.....	34
49	LMK04031 LVPECL Phase Noise, Suntsu SVD Series VCXO, 61.44 MHz.....	35
50	Suntsu SVD Series VCXO, 30.72 MHz, Open Loop Phase Noise	36
51	LMK04031 Fout Phase Noise, Suntsu SVD Series VCXO, 30.72 MHz.....	36
52	LMK04031 LVCMOS Phase Noise, Suntsu SVD Series VCXO, 30.72 MHz.....	37
53	LMK04031 LVPECL Phase Noise, Suntsu SVD Series VCXO, 30.72 MHz.....	37
54	LMK04031 LVDS Phase Noise, Suntsu SVD Series VCXO, 30.72 MHz	38
55	Vectron Model 5310 VCXO, 155.52 MHz, Open Loop Phase Noise	39
56	LMK04031 Fout Phase Noise, Vectron Model 5310 VCXO, 155.52 MHz	39
57	LMK04031 LVDS Phase Noise, Vectron Model 5310 VCXO, 155.52 MHz	40
58	LMK04031 LVCMOS Phase Noise, Vectron Model 5310 VCXO, 155.52 MHz	40
59	LMK04031 LVPECL Phase Noise, Vectron Model 5310 VCXO, 155.52 MHz	41
60	Vectron Model 5310 VCXO, 134.4 MHz, Open Loop Phase Noise	42
61	LMK04031 Fout Phase Noise, Vectron Model 5310 VCXO, 134.4 MHz.....	42
62	LMK04031 LVDS Phase Noise, Vectron Model 5310 VCXO, 134.4 MHz	43
63	LMK04031 LVCMOS Phase Noise, Vectron Model 5310 VCXO, 134.4 MHz.....	43
64	LMK04031 LVPECL Phase Noise, Vectron Model 5310 VCXO, 134.4 MHz.....	44

List of Tables

1	LMK04000 Family Part Numbers, Output Formats and VCO Bands	5
---	--	---

2	Summary of RMS Jitter Measurements	8
3	CTS Model 357, 61.44 MHz	8
4	Crystek CVHD-950-122.88MHz	11
5	Crystek CVHD-950-80	14
6	Crystek CVPD-920-61.44	17
7	Epson Toyocom VG-4501, 61.44 MHz	20
8	Epson-Toyocom VG-4231, 19.44 MHz	23
9	Epson-Toyocom TCO-2111-AA 245.76	26
10	Suntsu SVD Series, 54 MHz	29
11	Suntsu SVD Series, 61.44 MHz	32
12	Suntsu SVD Series, 30.72 MHz	35
13	Vectron Model 5310, 155.52 MHz.....	38
14	Vectron Model 5310, 134.4 MHz	41

1 Introduction

The purpose of this applications report is to present phase noise and jitter measurements representing the clock outputs of the LMK04000 family of Precision Clock Conditioners, when paired with various voltage controlled oscillators (VCXOs). The intent is to illustrate the relationship between clock output phase noise and VCXO phase noise. The LMK04000 family provides superior jitter cleaning capability by employing a dual, cascaded phase locked loop (PLL) architecture. A generic example of a dual PLL architecture is shown in [Figure 1](#). The figure also shows a clock distribution section following the VCO output.

The first PLL utilizes a narrow loop bandwidth to frequency lock the external VCXO to the incoming reference clock. The narrow loop bandwidth rejects most of the phase noise associated with the reference clock, allowing the VCXO phase noise to dominate. The frequency-locked VCXO is injected as the reference clock to the second PLL that employs a wider loop bandwidth to lock an internal VCO. This wider loop bandwidth means the VCO is both phase and frequency-locked to the VCXO, thus the VCXO phase noise dominates. For phase noise offsets higher than the loop bandwidth, the internal VCO phase noise and the output dividers and drivers will determine the output phase noise. This can be illustrated more explicitly by considering the total phase noise at the output of the synthesizer. Because the synthesizer noise determines the clock output noise, it is sufficient to only look at the synthesizer noise. The following equation shows that the total noise is the weighted sum of reference clock noise, PLL noise and VCO noise:

$$S_{\text{TOTAL}}(f) = S_{\text{REF}}(f) \cdot G_{\text{REF}}^2 |H(f)|^2 + S_{\text{PLL}}(f) \cdot G_{\text{PLL}}^2 |H(f)|^2 + S_{\text{VCO}}(f) \cdot |1 - H(f)|^2$$

The weighting function $H(f)$ is the lowpass closed loop transfer function, formed by parameters such as the charge pump gain, loop filter response, VCO gain, and feedback path (N) counter. This equation represents the noise model at the output of each of the PLL stages shown in [Figure 1](#). The gains associated with the reference clock noise (G_{REF}) and PLL noise (G_{PLL}) are also functions of specific loop parameters. Though the explicit expressions for these gains and closed loop response $H(f)$ are not derived here, the relevance of this equation can still be seen. In general, the synthesizer parameters that comprise $H(f)$ and the gain values represented in the equation are under the control of the designer and should be chosen such that the overall noise at the synthesizer output ($S_{\text{TOTAL}}(f)$) is minimized. In this case, minimization means achieving the smallest integrated noise. When the noise equation is applied to PLL2, $S_{\text{REF}}(f)$ represents the VCXO noise. In the case of the LMK04000 family, $S_{\text{PLL}}(f)$ and $S_{\text{VCO}}(f)$ are “fixed” by the device characteristics, but $S_{\text{REF}}(f)$ is dependent on the VCXO chosen by the designer. *Therefore it is important to select a VCXO that supports the phase noise and jitter requirements of the target application.*

The inclusion of a particular VCXO model or manufacturer in this report does not constitute an endorsement by National Semiconductor. The purpose of the data contained in this report is to offer the reader some insight on the direct relationship between the phase noise and jitter performance of the total clocking solution and VCXO characteristics. Though no VCXO cost data is presented here, there is a significant correlation between VCXO cost and performance. The LMK04000 family is targeted toward applications that require jitter cleaning, frequency synthesis and multiple clock distribution. While the LMK04000 family offers the industry's best performance in these categories, not all applications require the same level of performance. Hence, the LMK04000 family offers designers the capability to tailor the cost and performance of their clocking solutions by selecting the VCXO that best meets the overall needs of the application. This objective is further enhanced through the built-in features of the LMK04000 family that support the use of discretely implemented external crystal oscillators as well as off-the-shelf VCXO modules. The use of external crystal oscillators is addressed in a separate applications report.

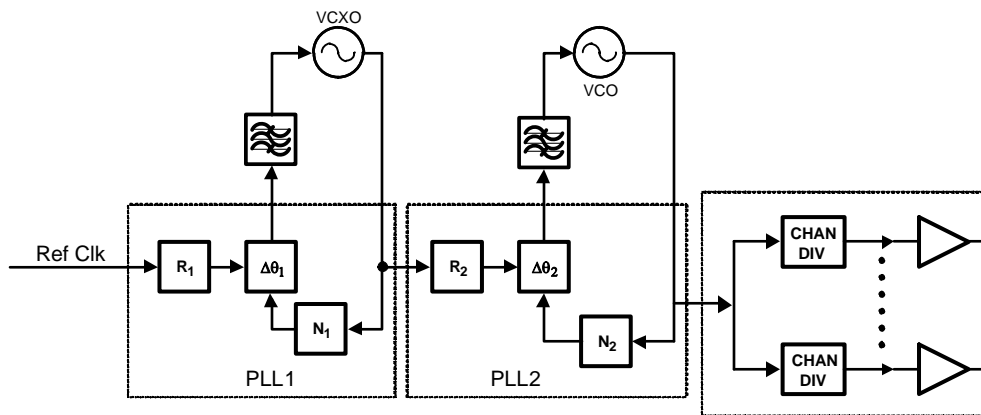

Figure 1. Dual-PLL Jitter Cleaning Clock Synthesizer Architecture

2 LMK04000 Family Description

Figure 2 shows a detailed block diagram of the LMK04000 Precision Clock Conditioner family. The redundant reference clock inputs (CLKin0, CLKin1) for PLL1 support frequencies up to 400 MHz. The reference clocks may be either single-ended or differential, and an auto-switching mode can be enabled for fail-safe operation. The maximum allowable frequency of the VCXO driving the OSCin port is 250 MHz. The signal at the OSCin port is fed back to the PLL1 phase comparator and is also injected to PLL2 as a phase and frequency reference. Though not shown in the diagram, there is internal support for a discretely implemented VCXO using an external crystal resonator. An optional frequency doubler path for the reference input to the PLL2 phase comparator allows the phase comparison frequency to be increased, thereby lowering the in-band noise of PLL2. An internal VCO is integrated with PLL2, along with optional internal loop filter components that support 3rd and 4th order poles for the PLL2 loop filter. The VCO output is buffered and made available at the Fout pin, and is also routed through a VCO divider to the internal clock distribution bus. The clock distribution section buffers and divides the bus clock through separately configured channels. Each channel features a divider, delay block and output buffer. The mixture of signal formats at the clock outputs is fixed according to the specific device part number.

Table 1 shows the currently released devices of the LMK04000 family. As Table 1 shows, two VCO frequency bands are offered along with two configurations of clock output formats. The device used for the measurements reported here was the LMK04031.

Table 1. LMK04000 Family Part Numbers, Output Formats and VCO Bands

NSID	PROCESS	2VPECL/LVPECL OUTPUTS	LVDS OUTPUTS	LVC MOS OUTPUTS	VCO FREQUENCY RANGE
LMK04011BISQ	BiCMOS	5			1430 to 1570 MHz
LMK04031BISQ	BiCMOS	2	2	2	1430 to 1570 MHz
LMK04033BISQ	BiCMOS	2	2	2	1840 to 2160 MHz

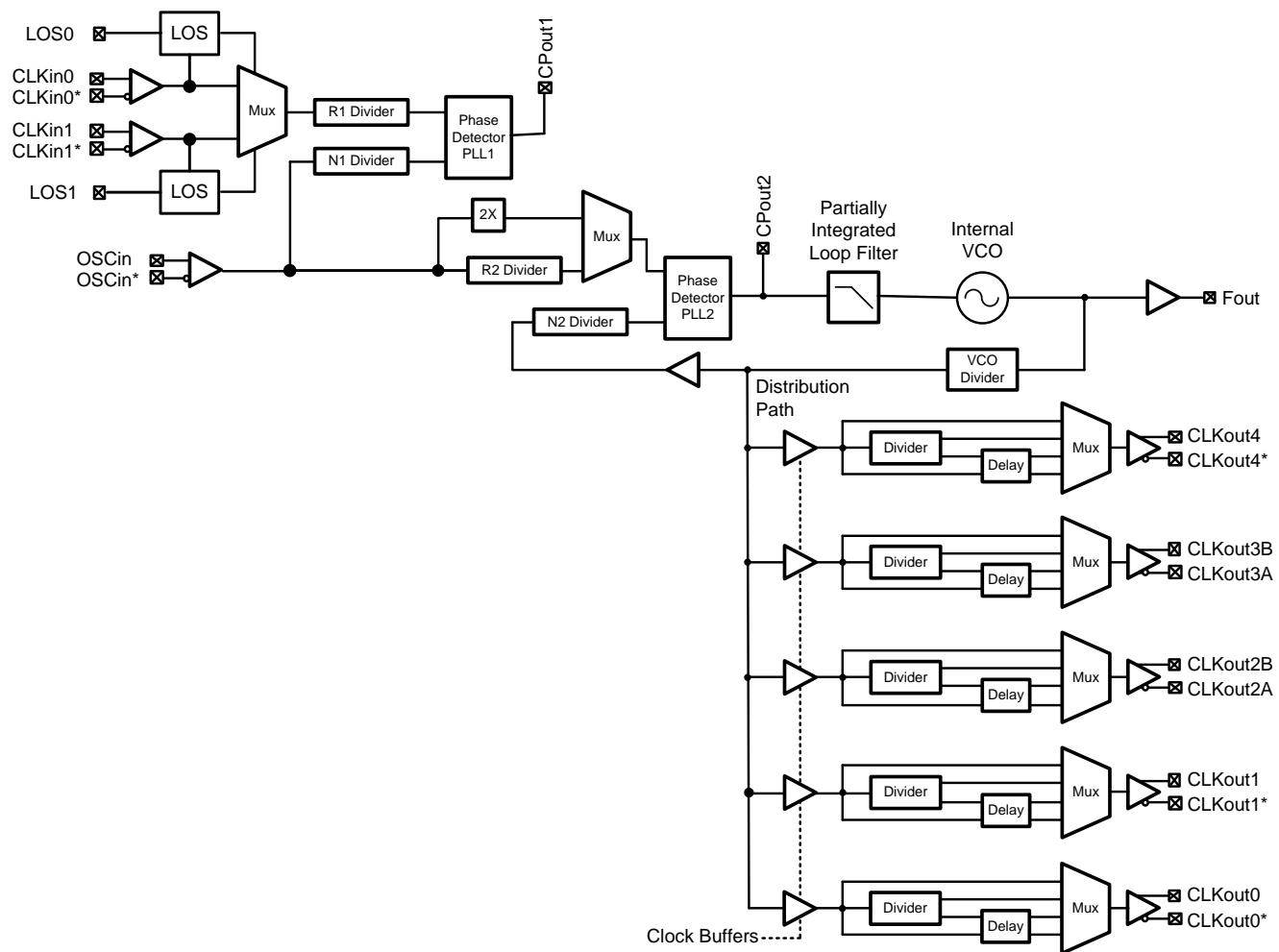

Figure 2. LMK04000 Family Block Diagram

3 LMK04000 Clock Output Phase Noise and Jitter

Various VCXOs were paired and tested with the LMK04031. The phase noise and jitter was measured at the clock outputs using an Agilent E5052A Signal Source Analyzer. The loop filters for PLL1 and PLL2 were fixed for all measurements. They are shown in [Figure 3](#). The closed loop bandwidth was adjusted either by the charge pump current or by adjusting the phase comparison frequency. The VCXOs cover various frequencies, so the measured clock frequencies vary, but are in the range of 122.88 MHz to 129 MHz. [Figure 4](#) illustrates the test setup for the measurements.

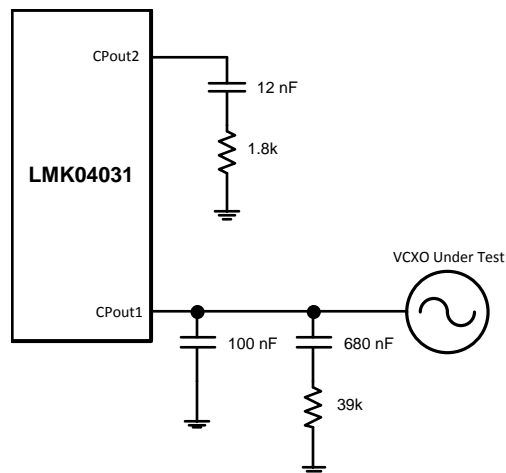

Figure 3. PLL1 and PLL2 Loop Filter Components

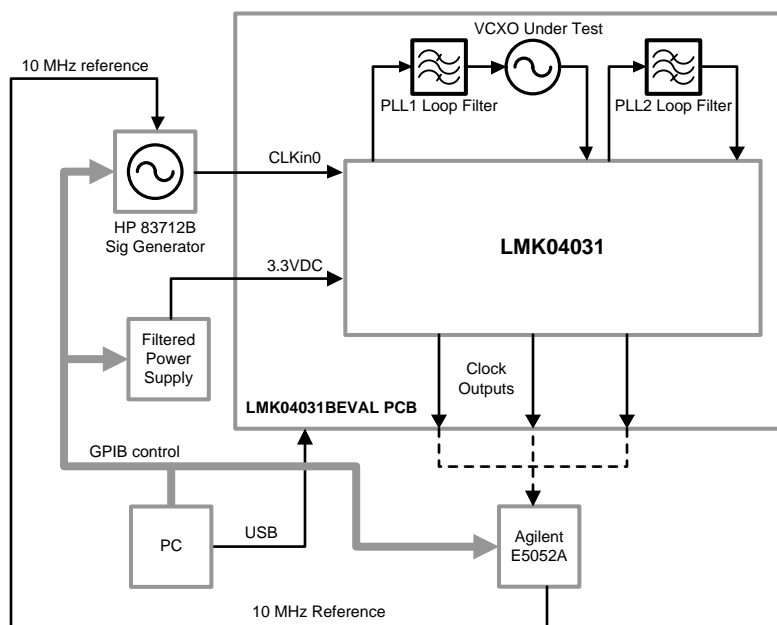

Figure 4. Phase Noise and Jitter Measurement Test Setup

Table 2 summarizes the RMS jitter measured at the Fout pin (buffered VCO output) and at clock output pins for LVDS, LVCMOS and LVPECL clock types. For all jitter measurements at the LMK04031 outputs, the integration bandwidth is 100 Hz to 20 MHz. The VCXO RMS jitter values listed in Table 2 are based upon a measurement bandwidth of 100 Hz to 200 kHz. 200 kHz was chosen as the upper limit because in most cases the loop bandwidth employed for PLL2 will not exceed 200 kHz, and so the VCXO contribution to total jitter beyond a 200 kHz offset is insignificant. Furthermore, because the measurement bandwidth is consistent for all of the VCXOs represented in this note, one can make useful comparisons between them when determining suitability for a particular application.

Table 2. Summary of RMS Jitter Measurements

VCXO MODEL		VCXO		LMK04031					
		FREQ (MHz)	RMS JITTER (fs) ⁽¹⁾	Fout FREQ (MHz)	Fout RMS JITTER (fs) ⁽²⁾	CLOCK OUTPUT FREQ (MHz)	LVDS RMS JITTER (fs) ⁽²⁾	LVPECL RMS JITTER (fs) ⁽²⁾	LVC MOS RMS JITTER (fs) ⁽²⁾
pp. 6-9	CTS Model 357	61.44	311	1474.56	390.3	122.88	398.6	413.1	416.2
pp. 10-14	Crystek CVHD-950	122.88	32	1474.56	127.8	122.88	160.7	170	149.9
pp. 15-19	Crystek CVHD-950	80	71	1520	165.5	126.66666	193.1	202.8	178.6
pp. 20-24	Crystek CVPD-920	61.44	285	1474.56	337.5	122.88	339.9	356	335.6
pp. 25-29	Epson Toyocom VG-4501	61.44	143	1474.56	230.2	122.88	250.4	264.2	237.3
pp. 30-34	Epson Toyocom VG-4231	19.44	383	1516.32	609.8	126.36	635.7	615.6	618.8
pp. 35-39	Epson Toyocom TCO-2111-AA	245.76	74	1474.56	148.1	122.88	183.3	184.4	163.1
pp. 40-44	Suntzu SVD series	54	336	1512	486.3	126	497.2	495.4	491.9
pp. 45-49	Suntzu SVD series	61.44	295	1474.56	489	122.88	495.9	494.9	491.2
pp. 50-54	Suntzu SVD series	30.72	655	1474.56	842.5	122.88	860.2	872.6	838.8
pp. 55-59	Vectron 5310	155.52	110	1555.2	155.7	129.6	179.5	187.6	169.1
pp. 60-64	Vectron 5310	134.40	82	1523.2	155.5	126.93333	181.8	191.6	169.6

⁽¹⁾ Integration bandwidth for VCXO jitter is 100 Hz to 200 kHz

⁽²⁾ Jitter integration bandwidth for clock measurements is 100 Hz to 20 MHz

The remainder of this application report presents phase noise plots captured using the E5052A. Each VCXO section begins with a table that lists the reference clock frequency, PLL1 phase comparison frequency and closed loop bandwidth, and the PLL2 phase comparison frequency and closed loop bandwidth. Each VCXO section also contains a plot of the open loop phase noise of the VCXO, and closed loop phase noise plots of the LMK04031 outputs.

3.1 CTS Model 357 VCXO

Table 3. CTS Model 357, 61.44 MHz

Reference Clock (MHz)	F _{comp1} (MHz)	PLL1 Loop BW (Hz)	F _{comp2} (MHz)	PLL2 Loop BW (kHz)
30.72	1.024	30	30.72	95.4

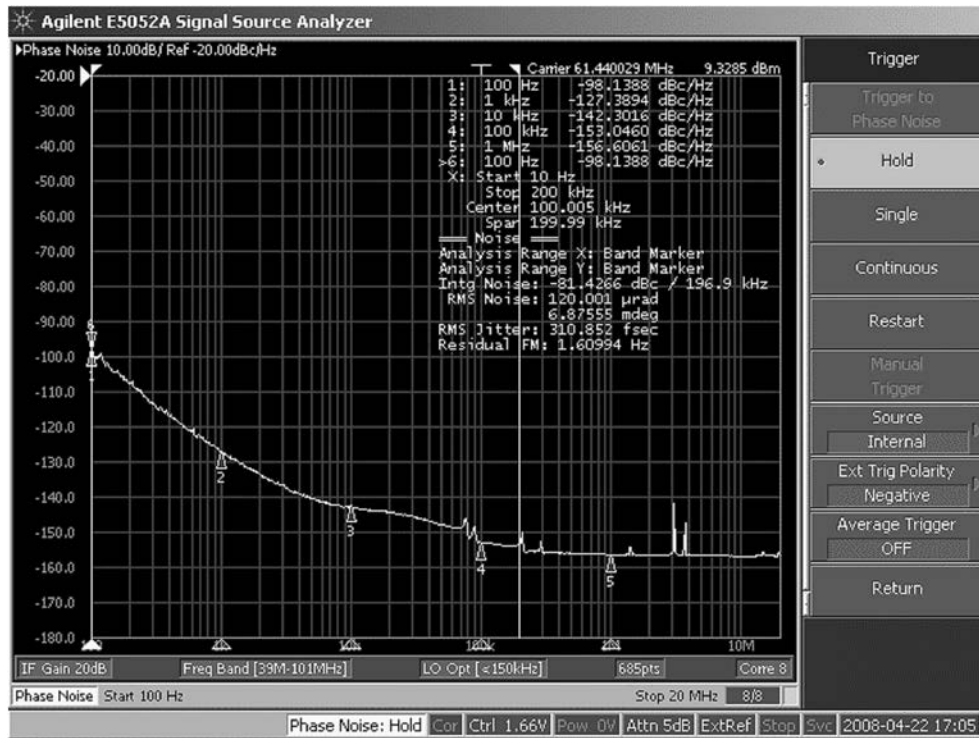

Figure 5. CTS Model 357 VCXO Open Loop Phase Noise, 61.44 MHz

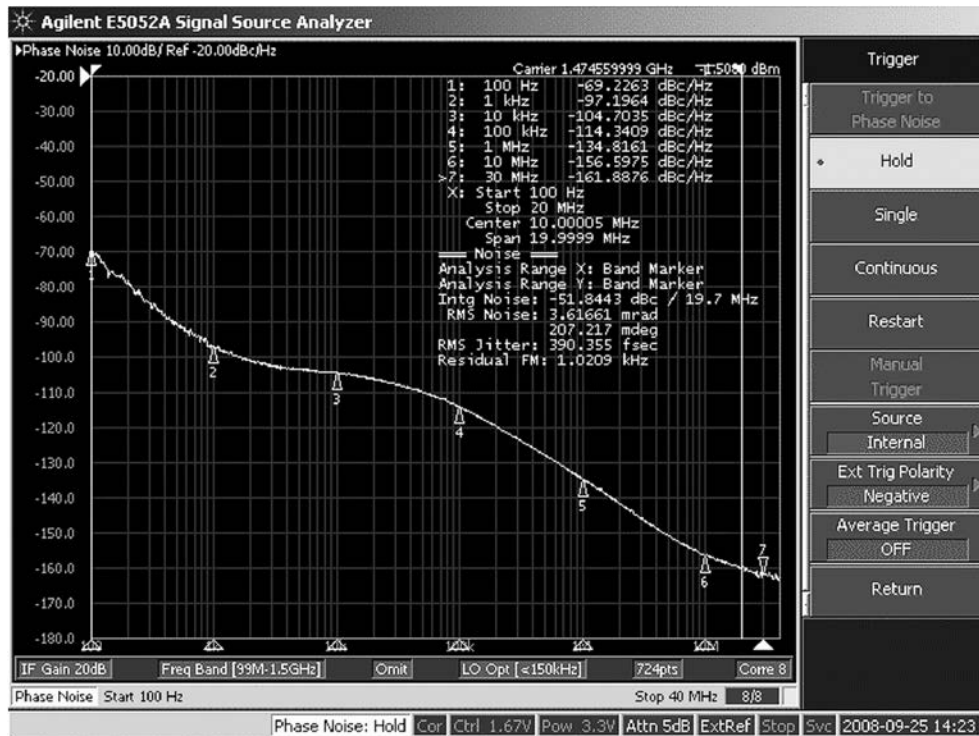

Figure 6. LMK04031 Fout Phase Noise, CTS model 357 VCXO

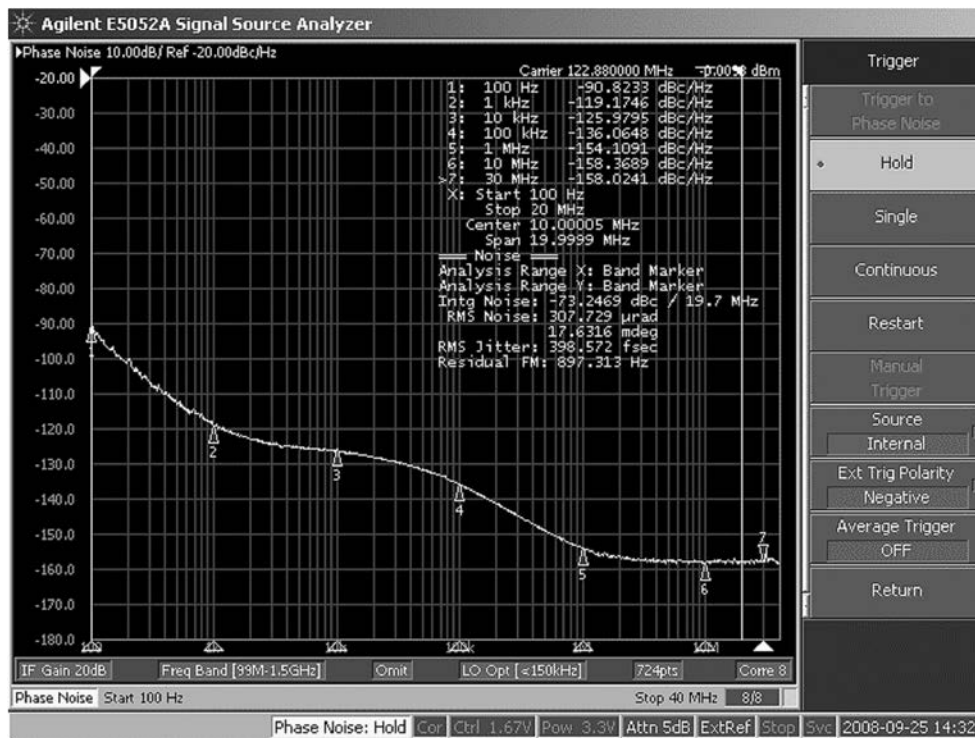

Figure 7. LMK04031 LVDS Phase Noise, CTS model 357 VCXO

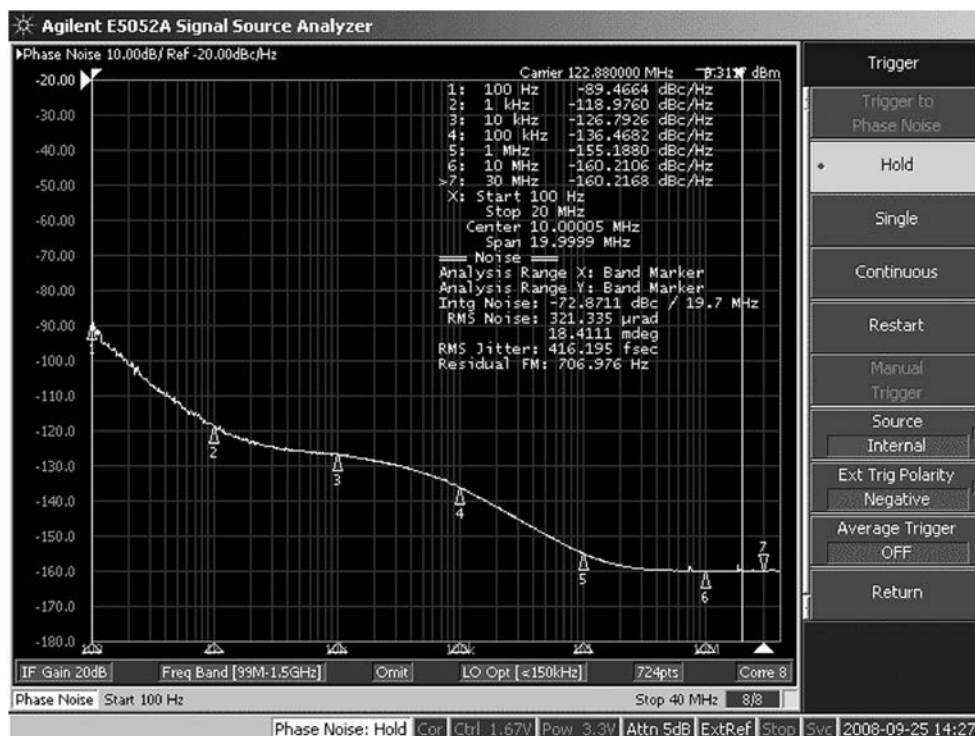

Figure 8. LMK04031 LVC MOS Phase Noise, CTS model 357 VCXO

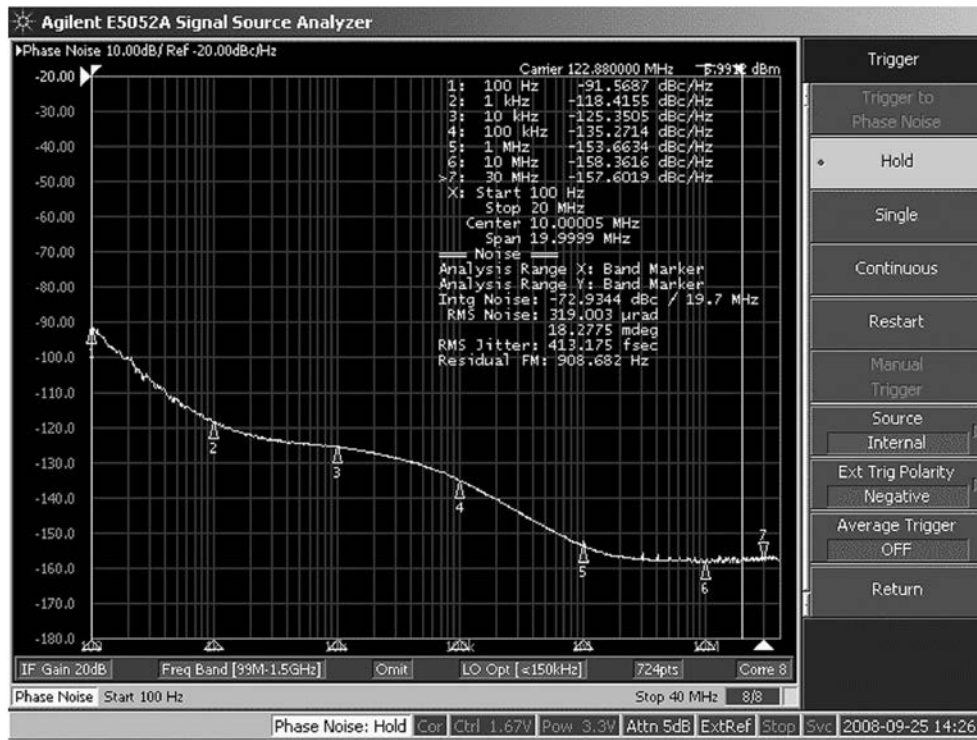

Figure 9. LMK04031 LVPECL Phase Noise, CTS model 357 VCXO

3.2 Crystek CVHD-950-122.88 MHz VCXO

Table 4. Crystek CVHD-950-122.88MHz

Reference Clock (MHz)	F _{comp1} (MHz)	PLL1 Loop BW (Hz)	F _{comp2} (MHz)	PLL2 Loop BW (kHz)
122.88	1.024	20	61.44	189.7

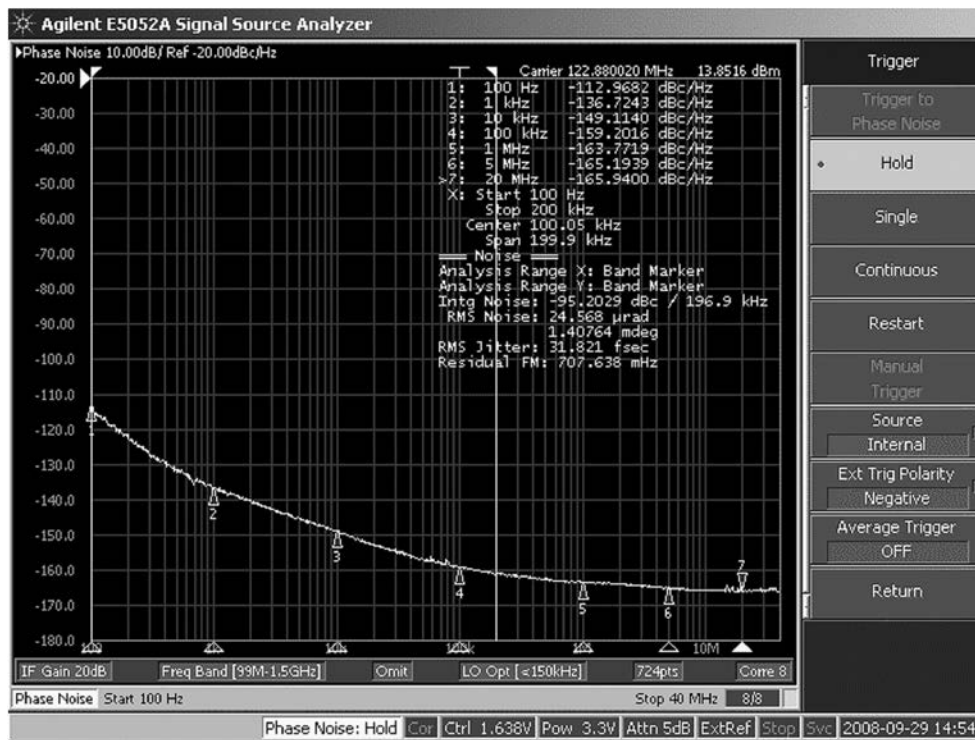

Figure 10. Crystek CVHD-950-122.88 VCXO Open Loop Phase Noise

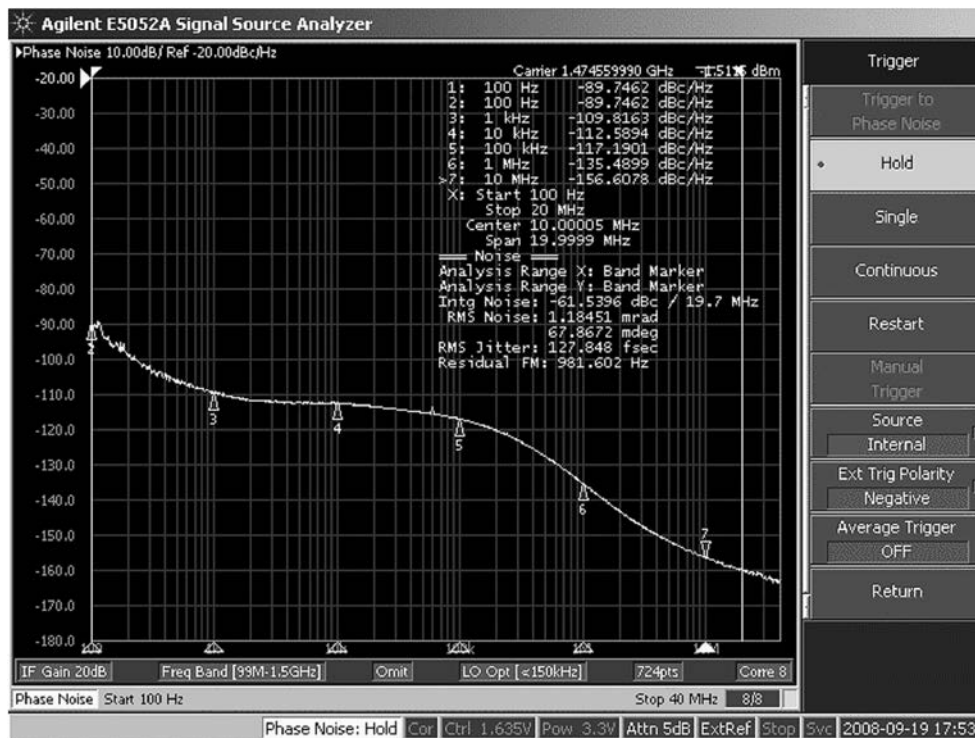

Figure 11. LMK04031 Fout Phase Noise, Crystek CVHD-950-122.88 VCXO

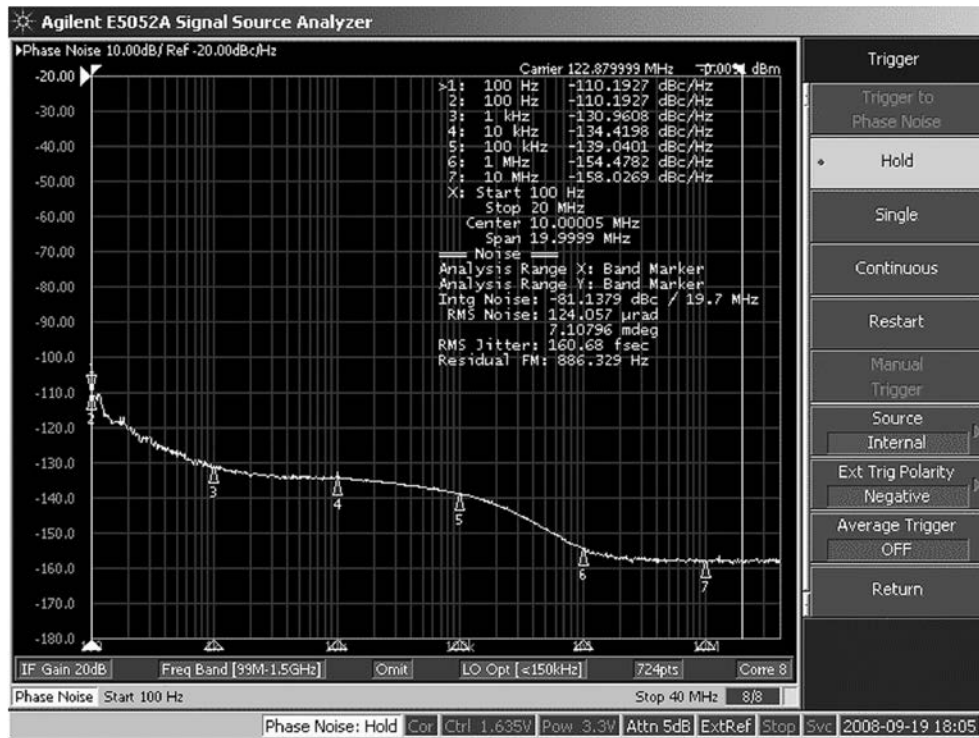

Figure 12. LMK04031 LVDS Phase Noise, Crystek CVHD-950-122.88 VCXO

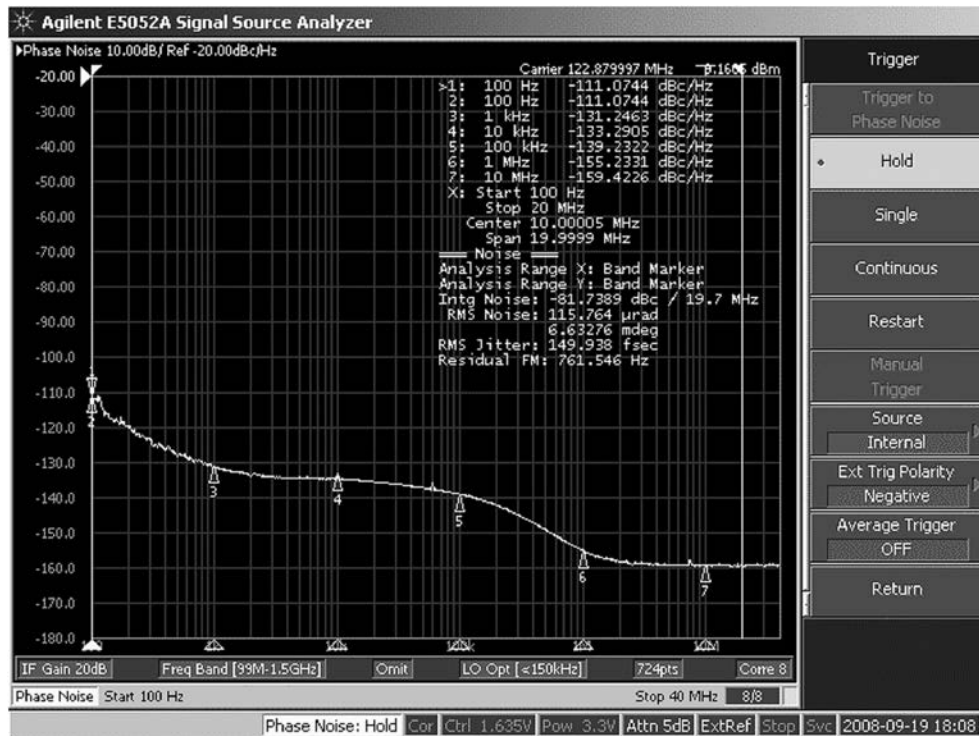

Figure 13. LMK04031 LVC MOS Phase Noise, Crystek CVHD-950-122.88 VCXO

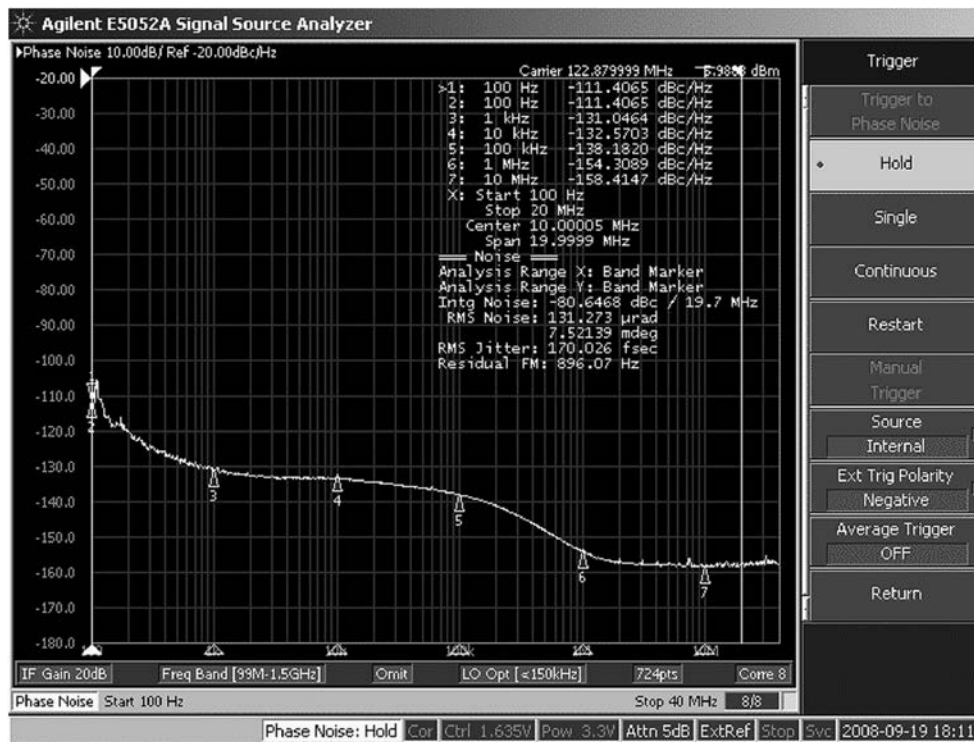

Figure 14. LMK04031 LVPECL Phase Noise, Crystek CVHD-950-122.88 VCXO

3.3 Crystek CVHD-950-80 VCXO

Table 5. Crystek CVHD-950-80

Reference Clock (MHz)	F _{comp1} (MHz)	PLL1 Loop BW (Hz)	F _{comp2} (MHz)	PLL2 Loop BW (kHz)
40	1.0	20	40	120.3

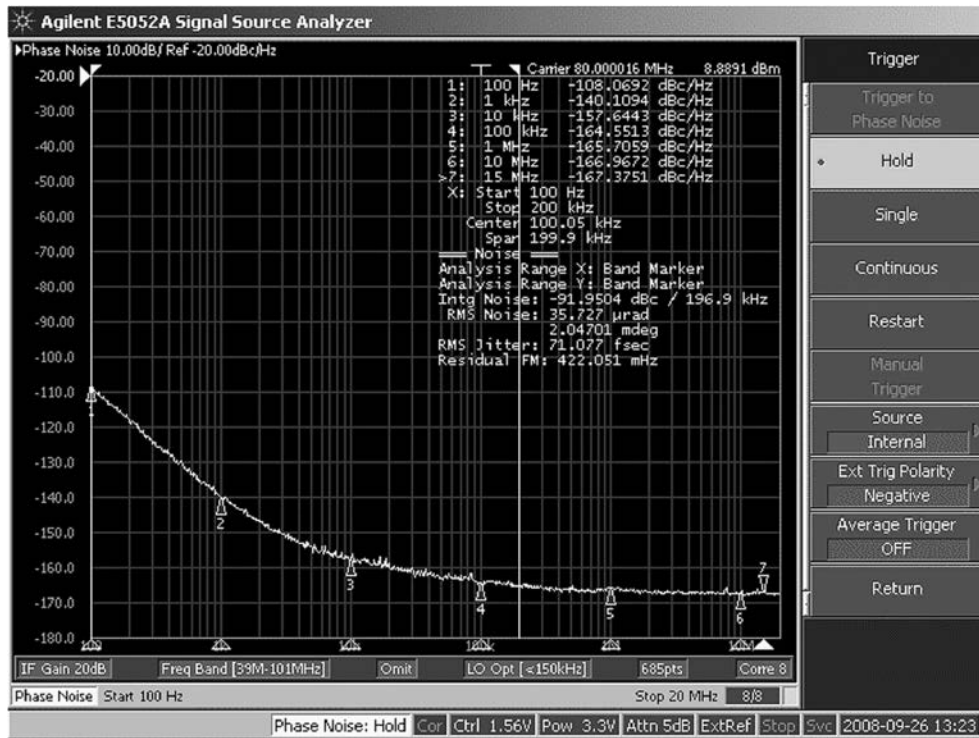

Figure 15. Crystek CVHD-950-80 VCXO Open Loop Phase Noise

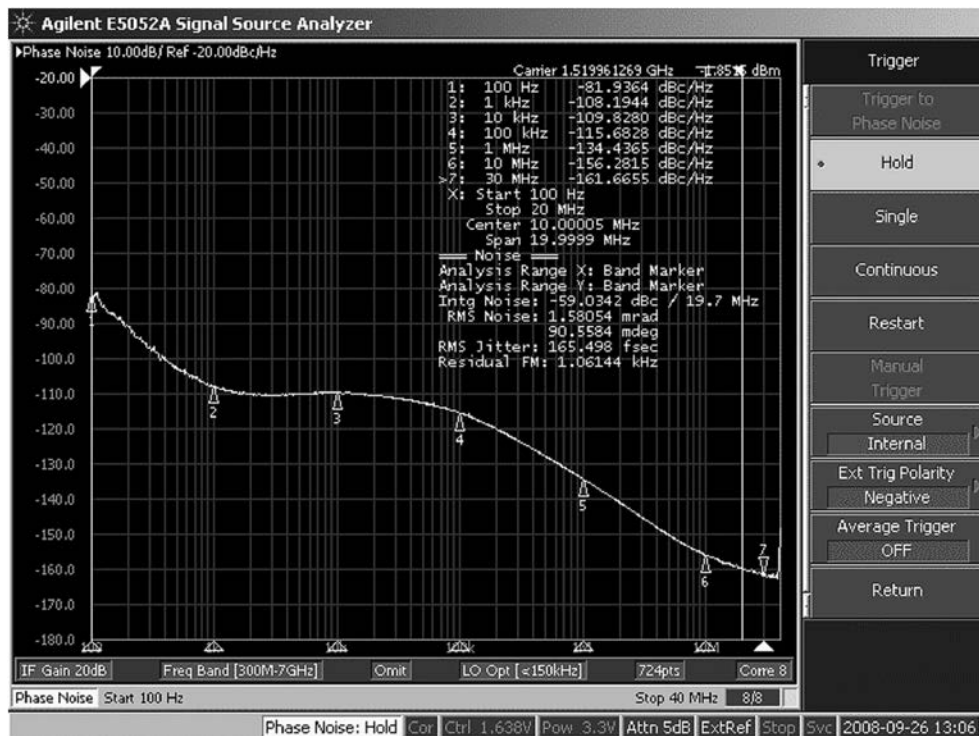

Figure 16. LMK04031 Fout Phase Noise, Crystek CVHD-950-80 VCXO

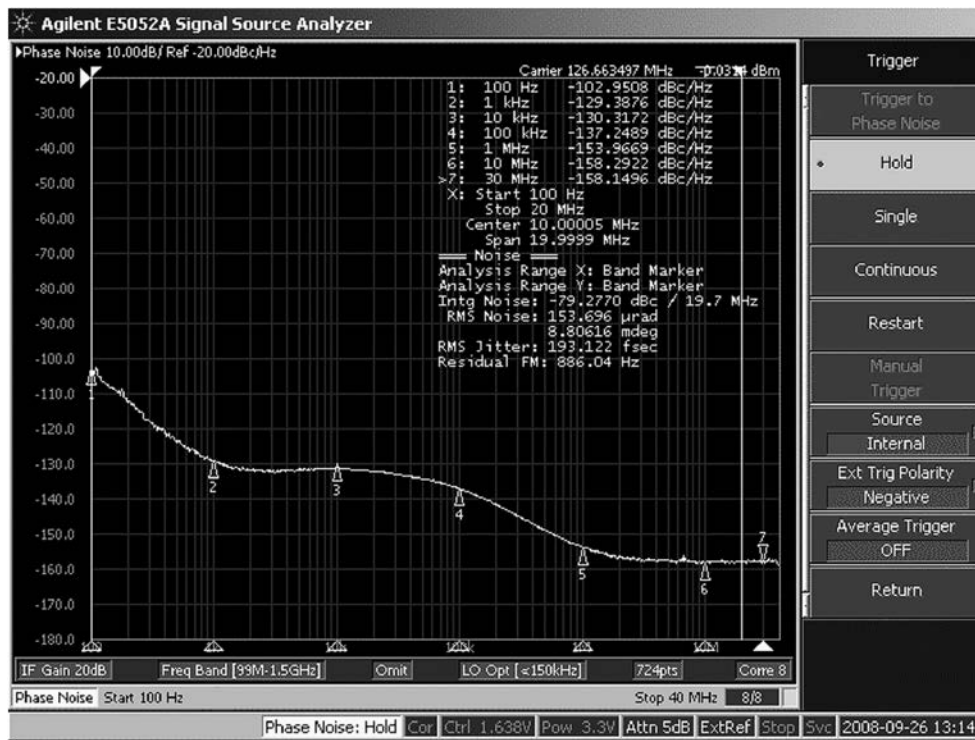

Figure 17. LMK04031 LVDS Phase Noise, Crystek CVHD-950-80 VCXO

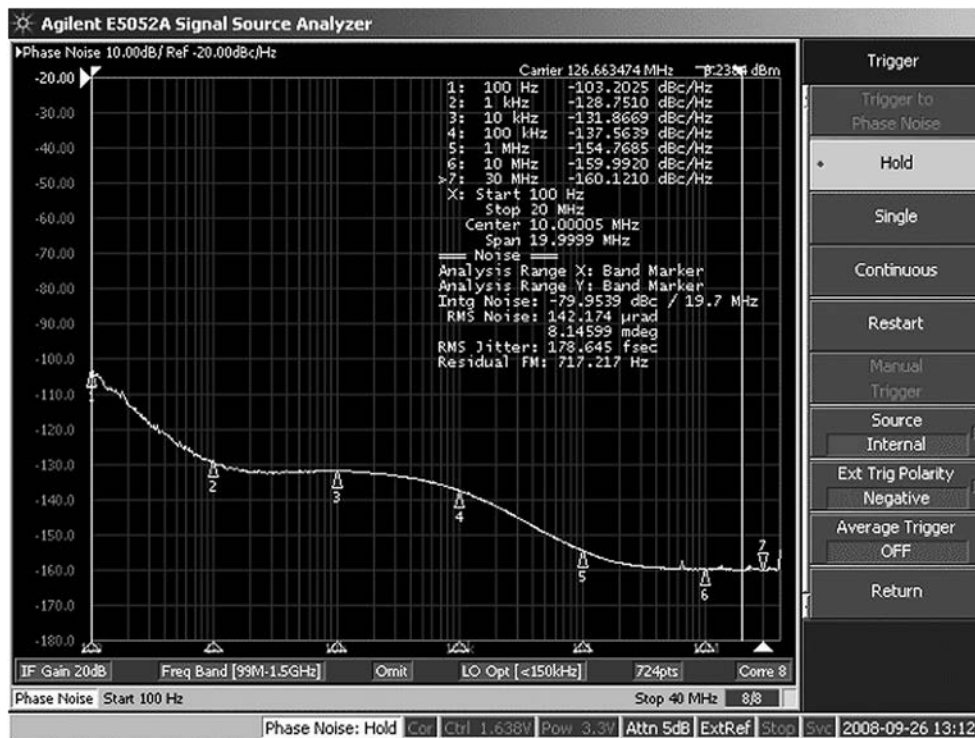

Figure 18. LMK04031 LVCMOS Phase Noise, Crystek CVHD-950-80 VCXO

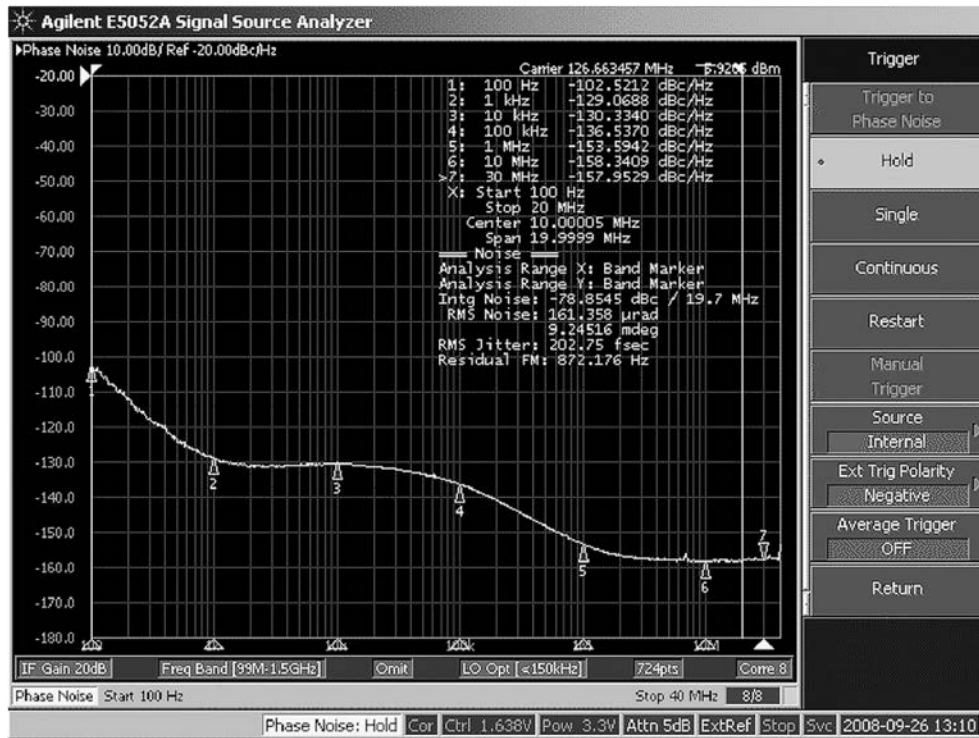

Figure 19. LMK04031 LVPECL Phase Noise, Crystek CVHD-950-80 VCXO

3.4 Crystek CVPD-920-61.44 VCXO

Table 6. Crystek CVPD-920-61.44

Reference Clock (MHz)	F _{comp1} (MHz)	PLL1 Loop BW (Hz)	F _{comp2} (MHz)	PLL2 Loop BW (kHz)
30.72	1.024	20	30.72	95.4

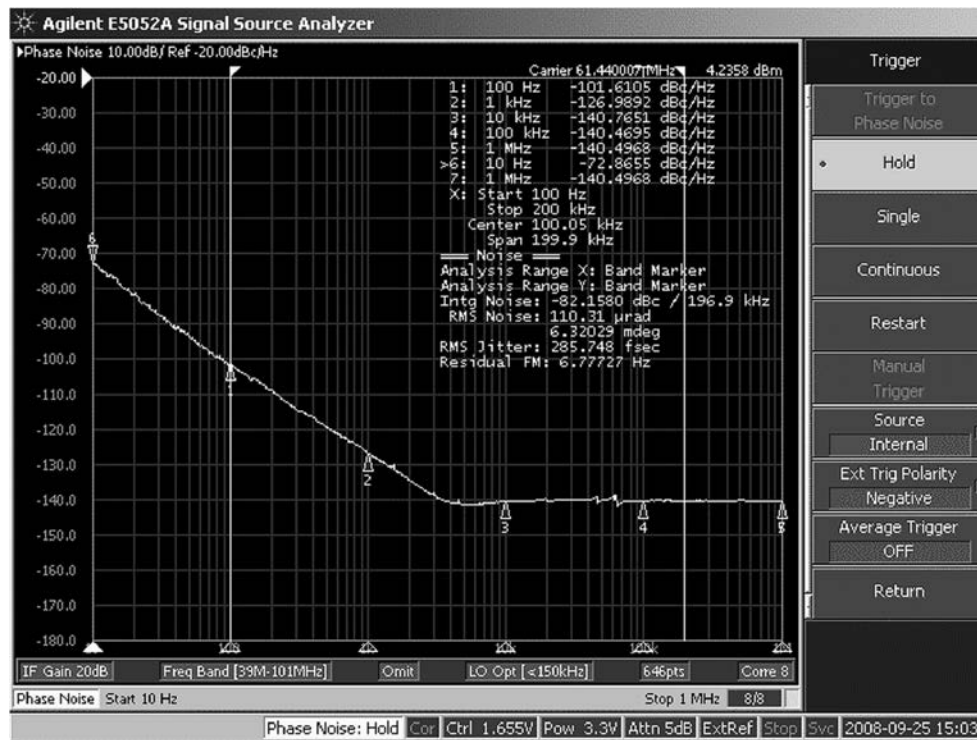

Figure 20. Crystek CVPD-920-61.44 VCXO Open Loop Phase Noise

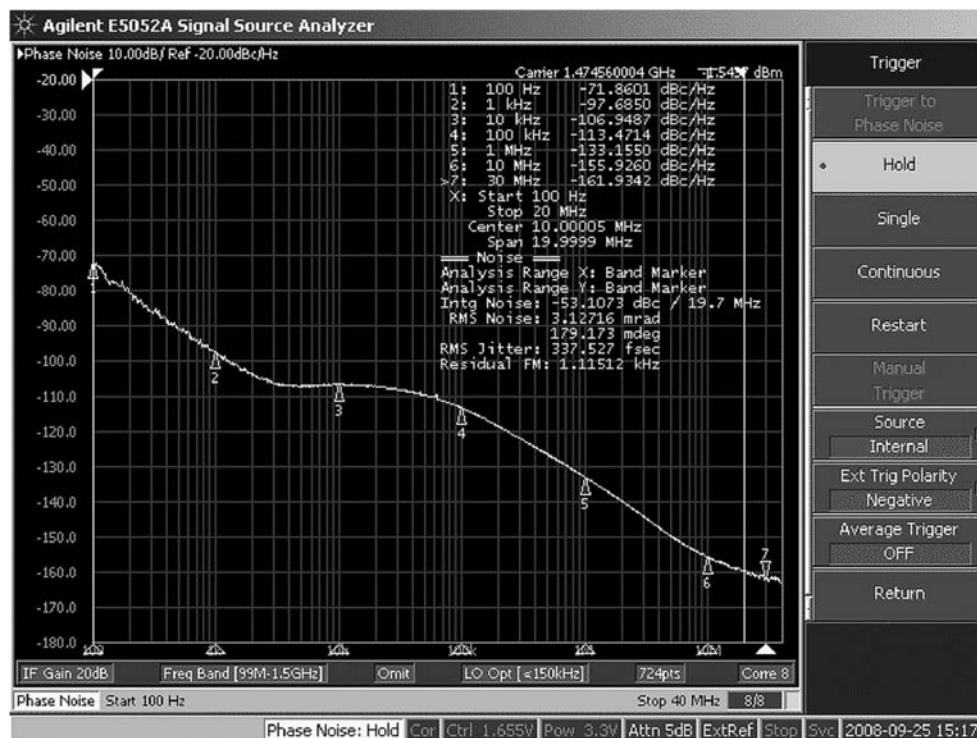

Figure 21. LMK04031 Four Phase Noise, Crystek CVPD-920-61.44 VCXO

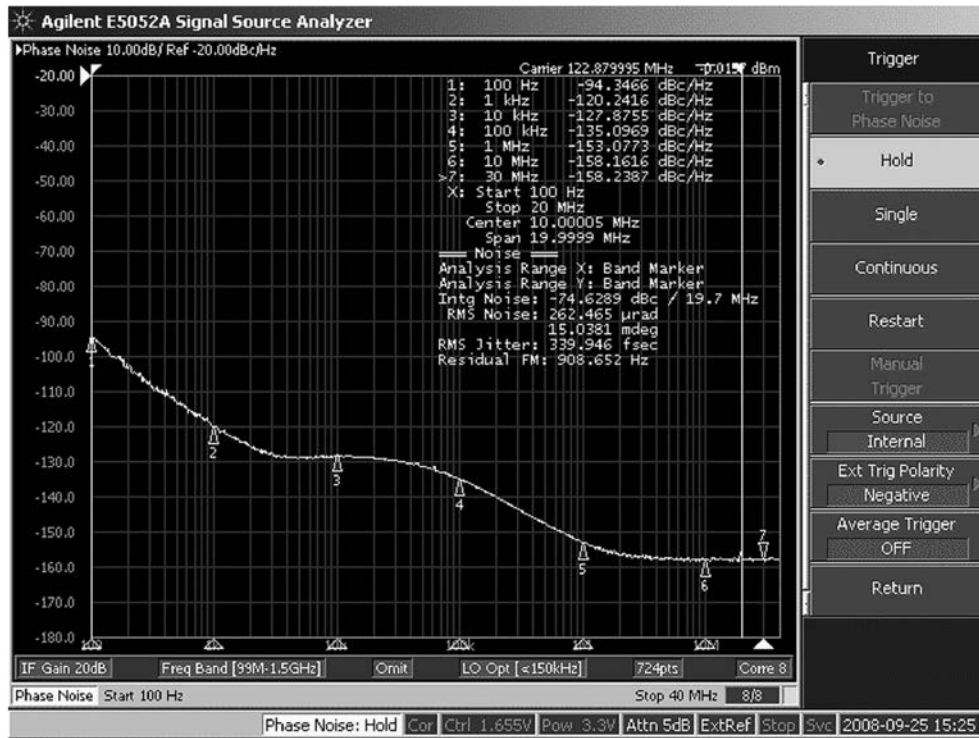

Figure 22. LMK04031 LVDS Phase Noise, Crystek CVPD-920-61.44 VCXO

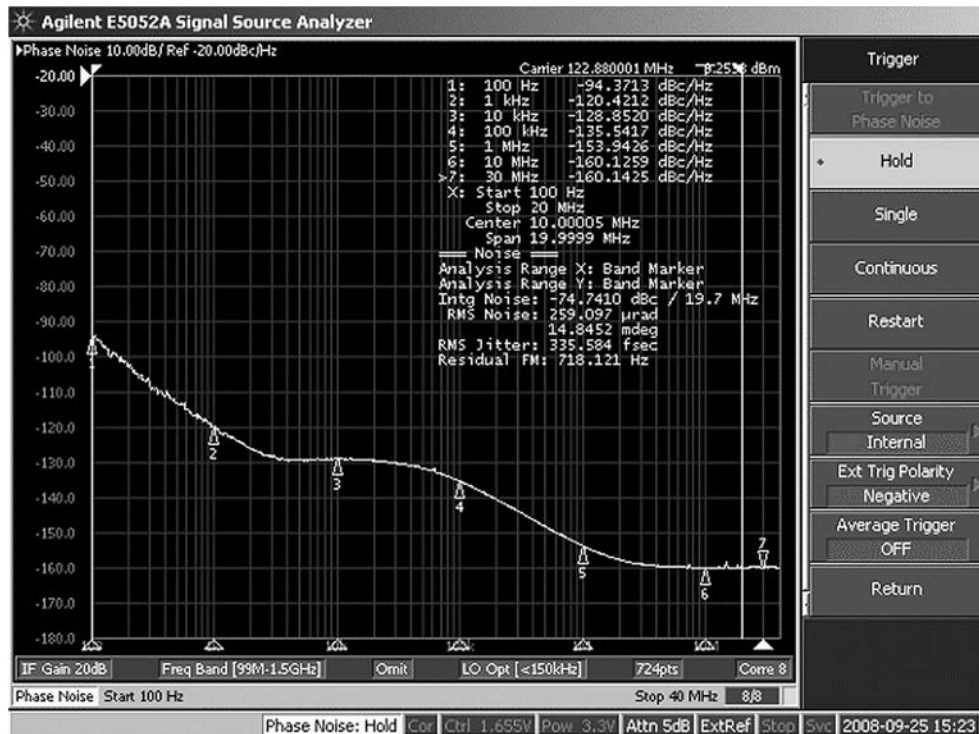

Figure 23. LMK04031 LVCMOS Phase Noise, Crystek CVPD-920-61.44 VCXO

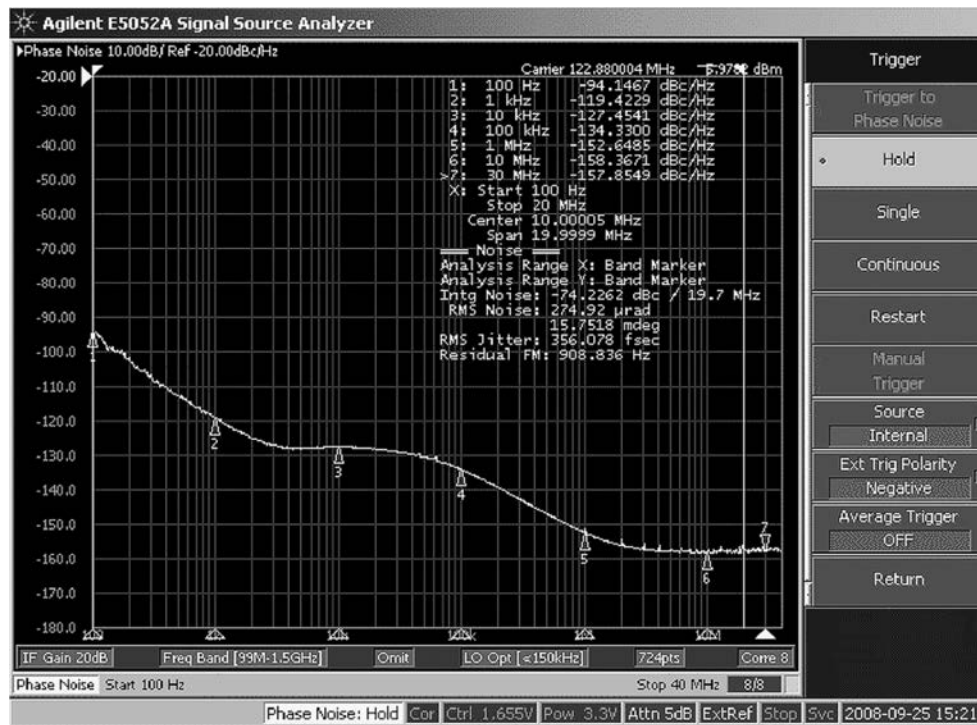

Figure 24. LMK04031 LVPECL Phase Noise, Crystek CVPD-920-61.44 VCXO

3.5 Epson Toyocom VG-4501 VCXO

Table 7. Epson Toyocom VG-4501, 61.44 MHz

Reference Clock (MHz)	F _{comp1} (MHz)	PLL1 Loop BW (Hz)	F _{comp2} (MHz)	PLL2 Loop BW (kHz)
30.72	1.024	20	30.72	95.4

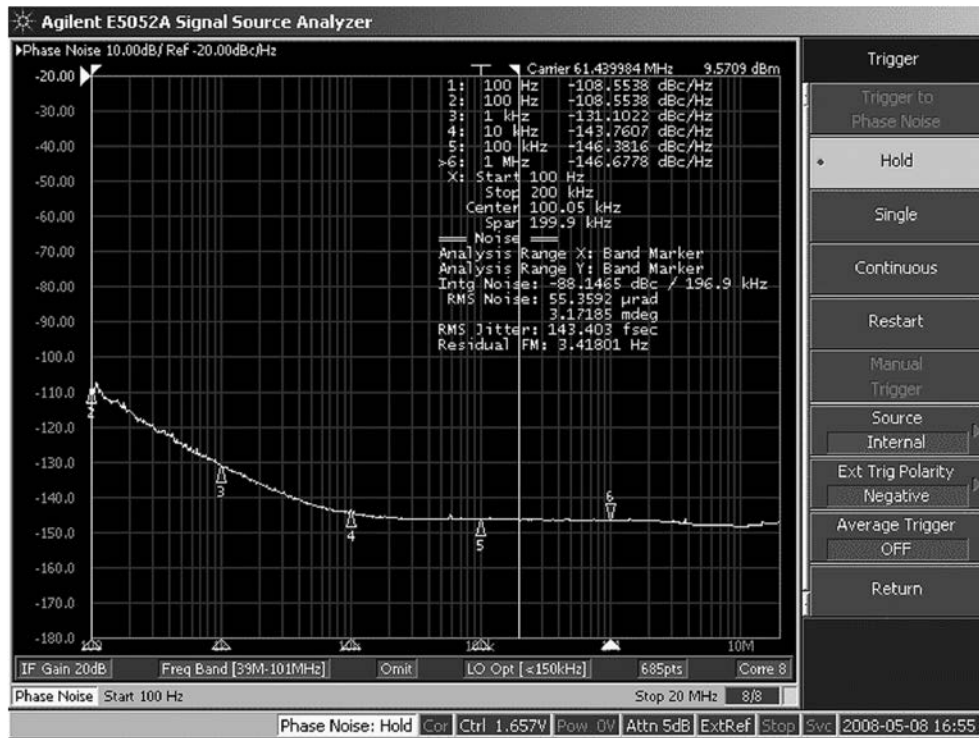

Figure 25. Epson Toyocom VG-4501 VCXO, 61.44 MHz, Open Loop Phase Noise

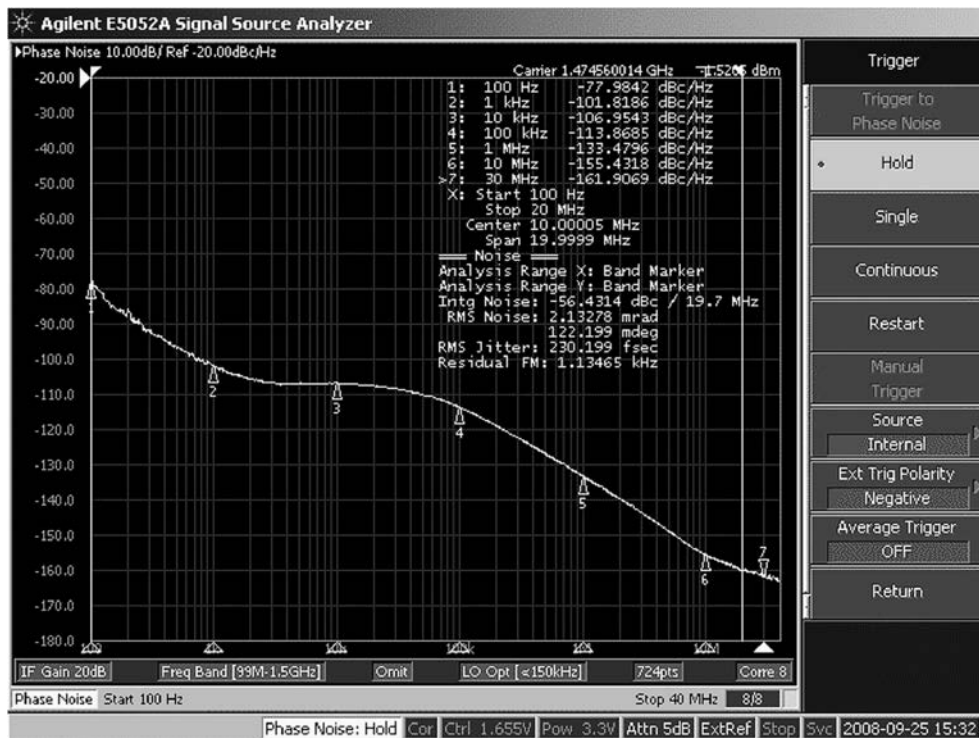

Figure 26. LMK04031 Fout Phase Noise, Epson Toyocom VG-4501 VCXO

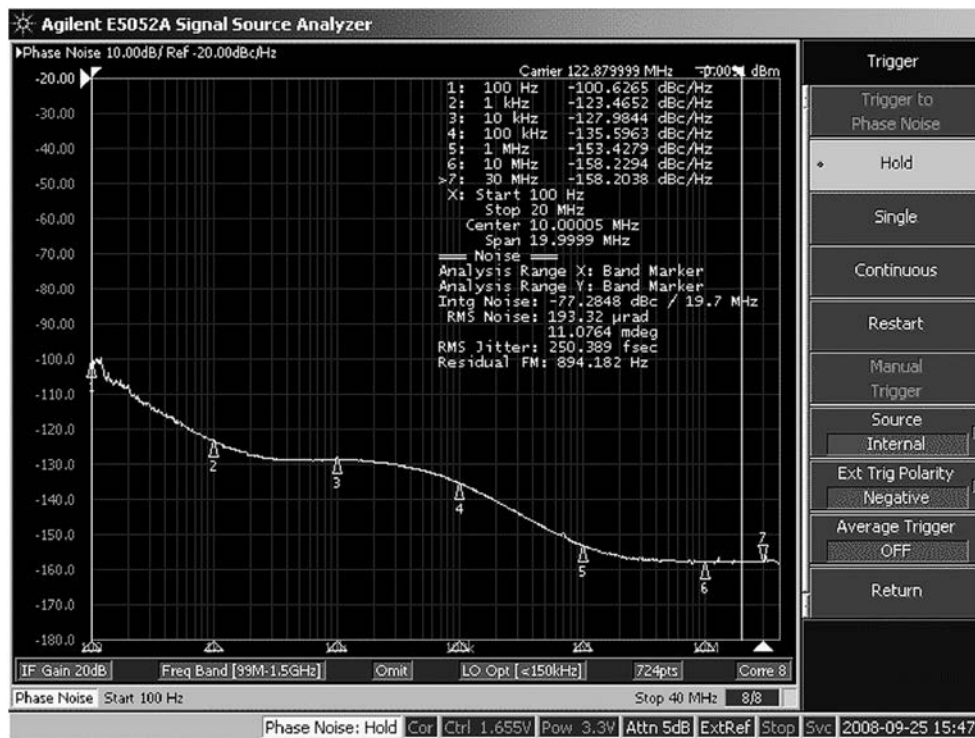

Figure 27. LMK04031 LVDS Phase Noise, Epson Toyocom VG-4501 VCXO

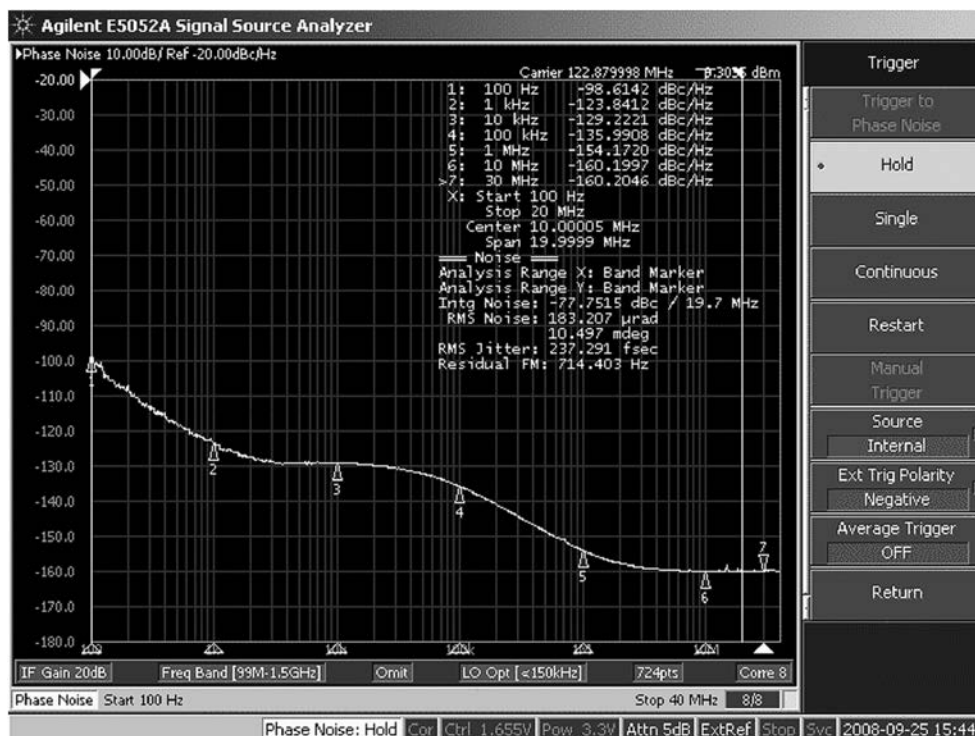

Figure 28. LMK04031 LVC MOS Phase Noise, Epson Toyocom VG-4501 VCXO

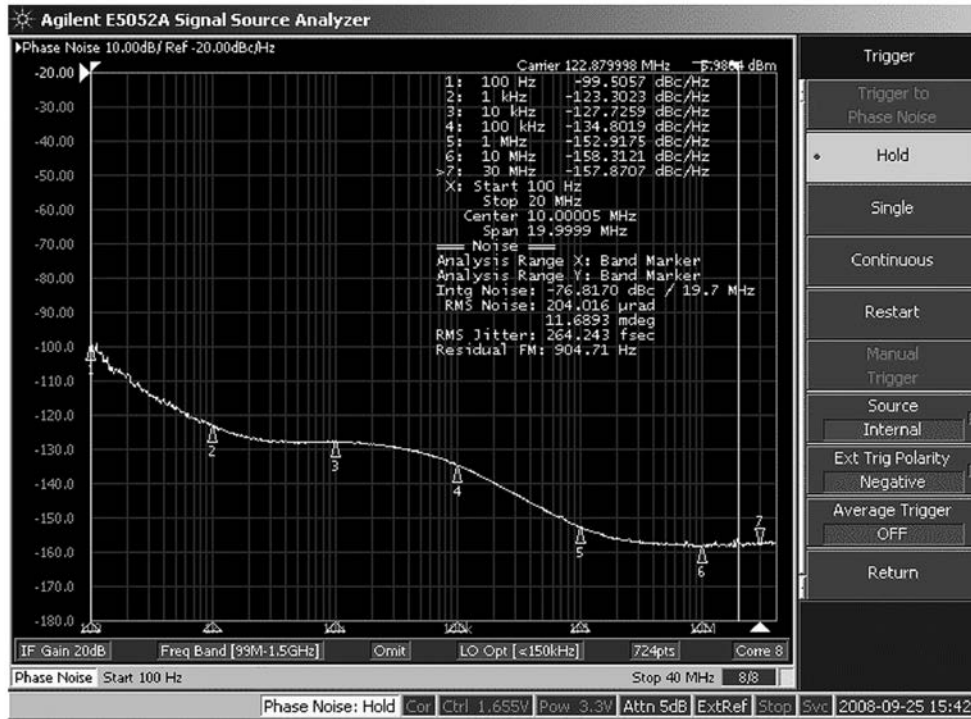

Figure 29. LMK04031 LVPECL Phase Noise, Epson Toyocom VG-4501 VCXO

3.6 Epson-Toyocom VG-4231 VCXO

Table 8. Epson-Toyocom VG-4231, 19.44 MHz

Reference Clock (MHz)	F _{comp1} (MHz)	PLL1 Loop BW (Hz)	F _{comp2} (MHz)	PLL2 Loop BW (kHz)
19.44	1.08	20	19.44	59

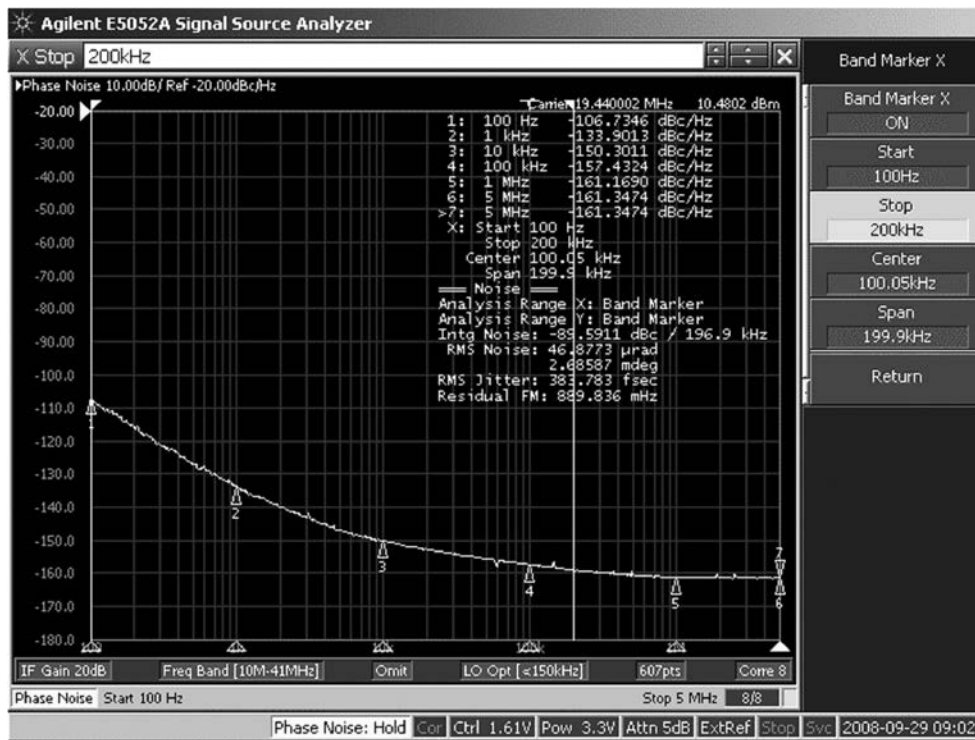

Figure 30. Epson Toyocom VG-4231 VCXO, 19.44 MHz, Open Loop Phase Noise

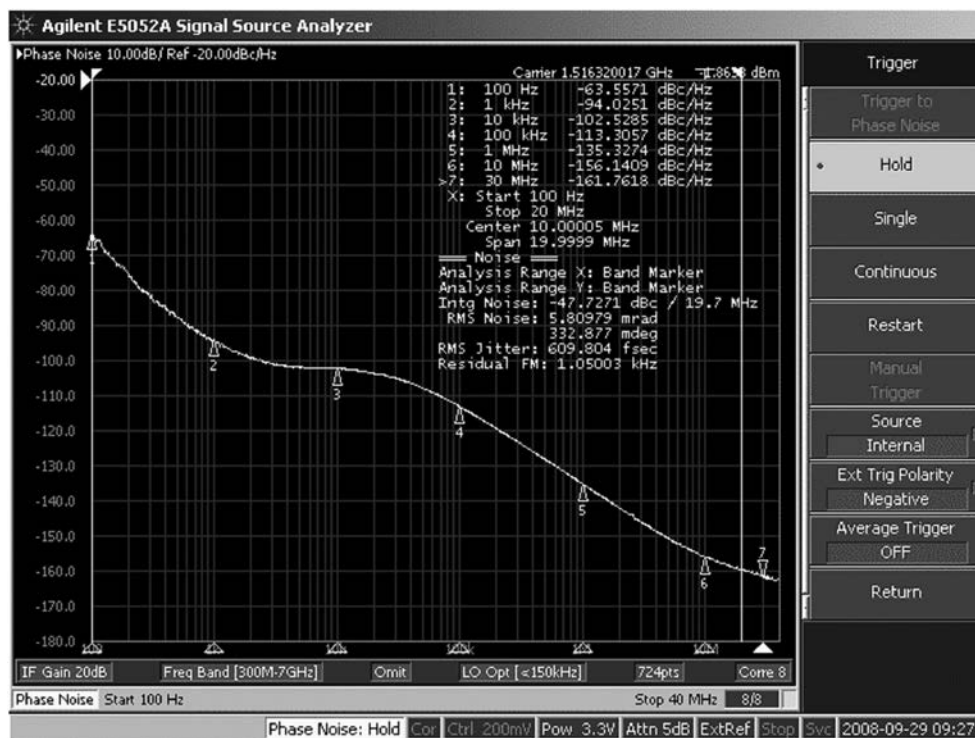

Figure 31. LMK04031 Four Phase Noise, Epson Toyocom VG-4231 VCXO

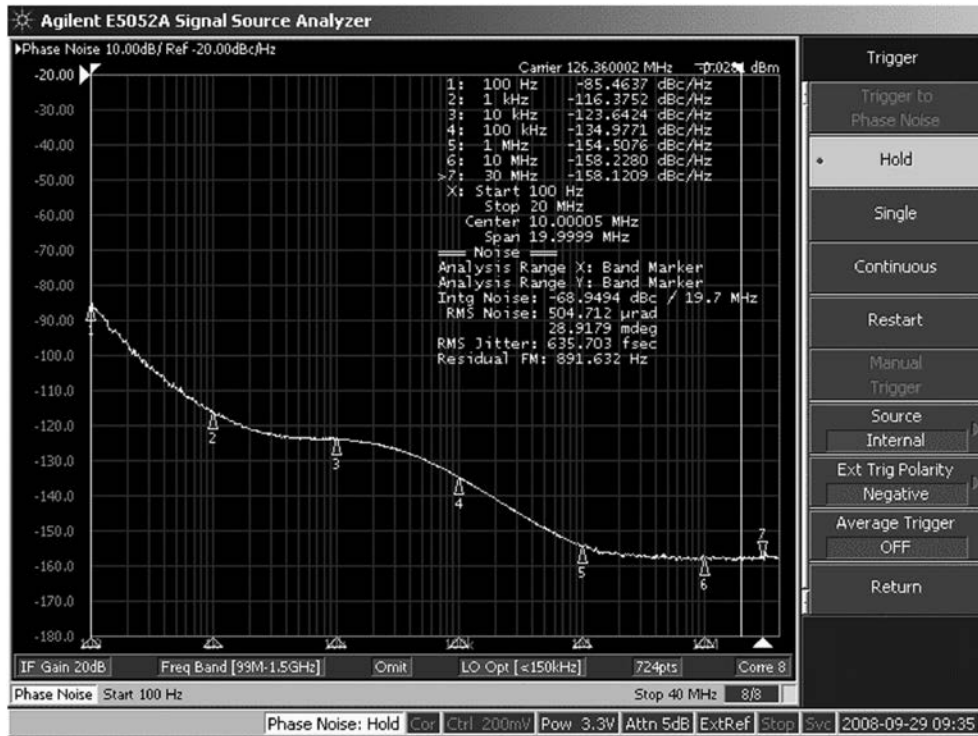

Figure 32. LMK04031 LVDS Phase Noise, Epson Toyocom VG-4231 VCXO

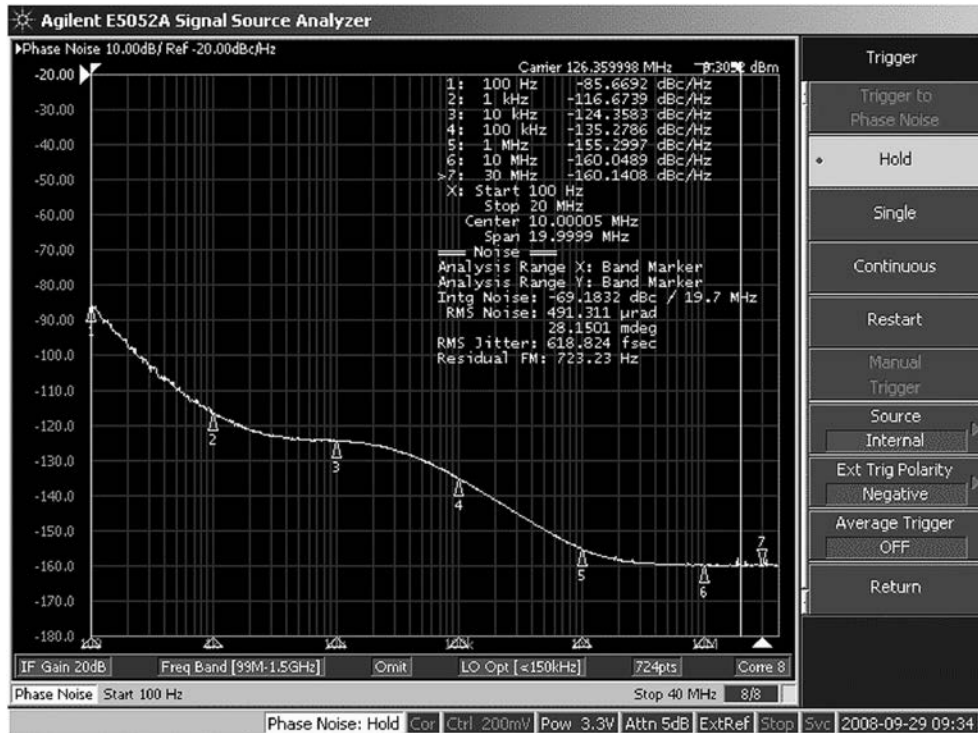

Figure 33. LMK04031 LVCMOS Phase Noise, Epson Toyocom VG-4231 VCXO

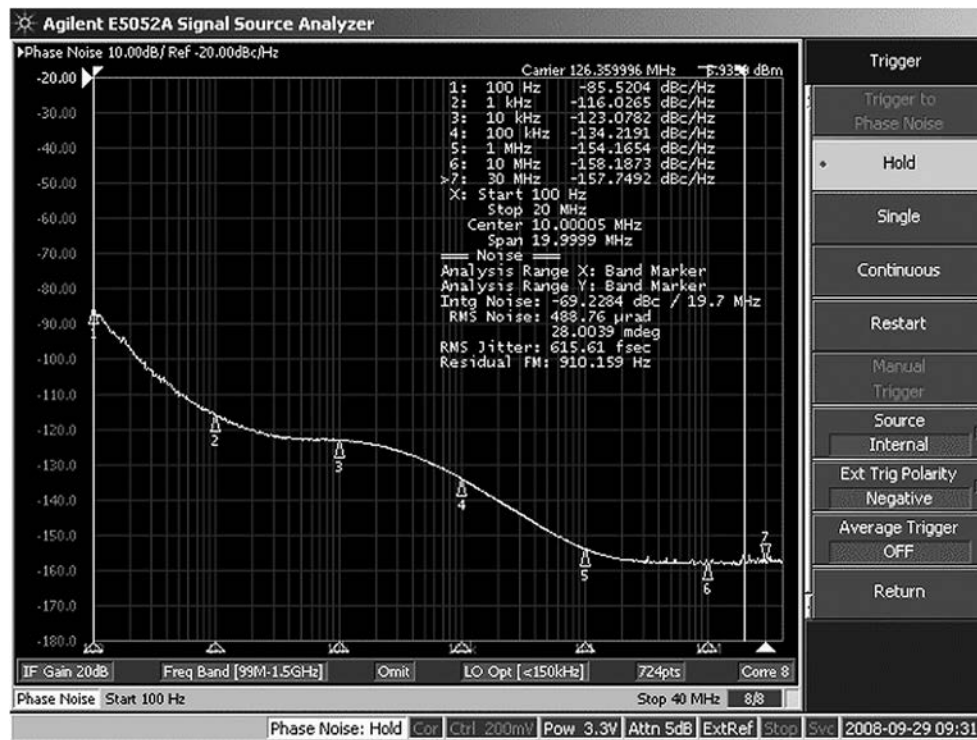

Figure 34. LMK04031 LVPECL Phase Noise, Epson Toyocom VG-4231 VCXO

3.7 Epson-Toyocom TCO-2111-AA VCXO

Table 9. Epson-Toyocom TCO-2111-AA 245.76

Reference Clock (MHz)	F _{comp1} (MHz)	PLL1 Loop BW (Hz)	F _{comp2} (MHz)	PLL2 Loop BW (kHz)
122.88	1.024	20	61.44	189.7

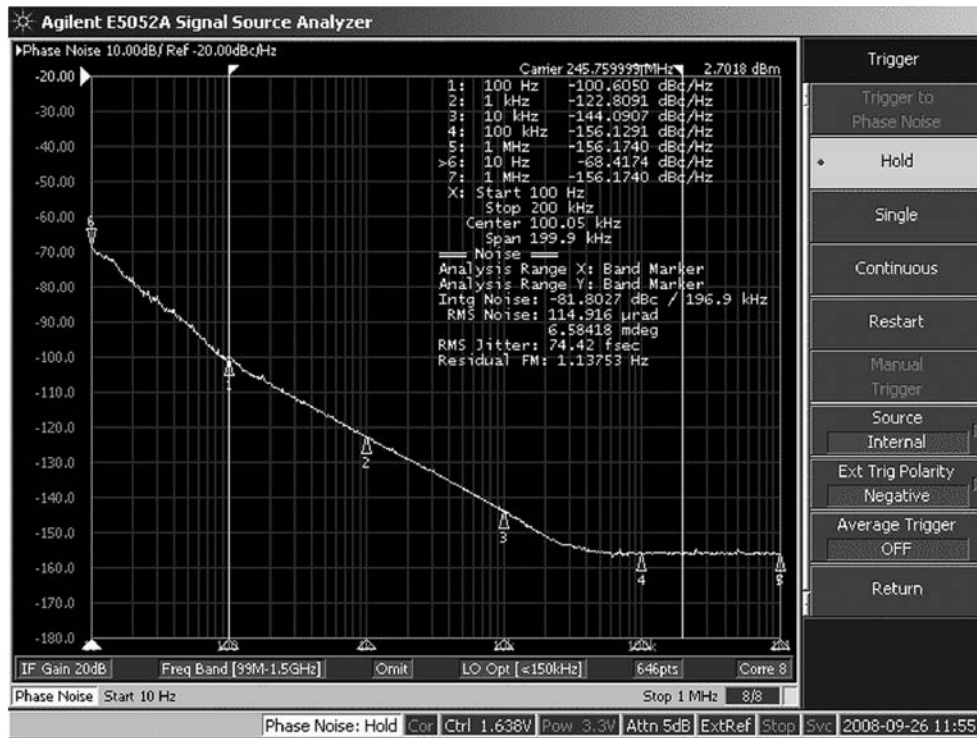

Figure 35. Epson Toyocom TCO-2111-AA VCXO, 245.76 MHz, Open Loop Phase Noise

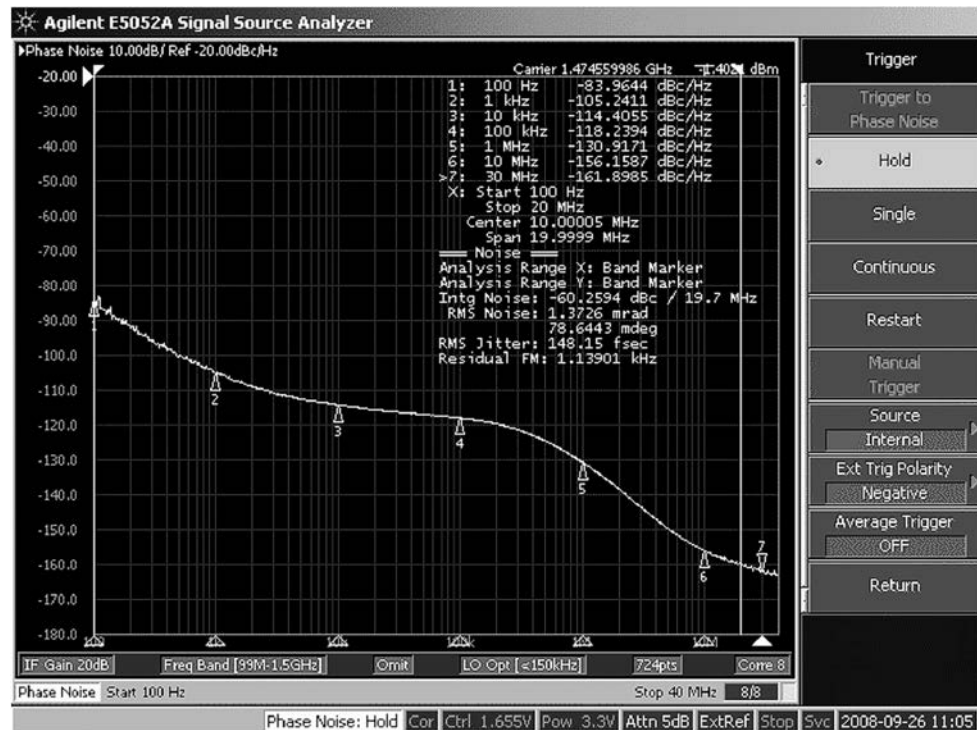

Figure 36. LMK04031 Four Phase Noise, Epson Toyocom TCO-2111-AA VCXO

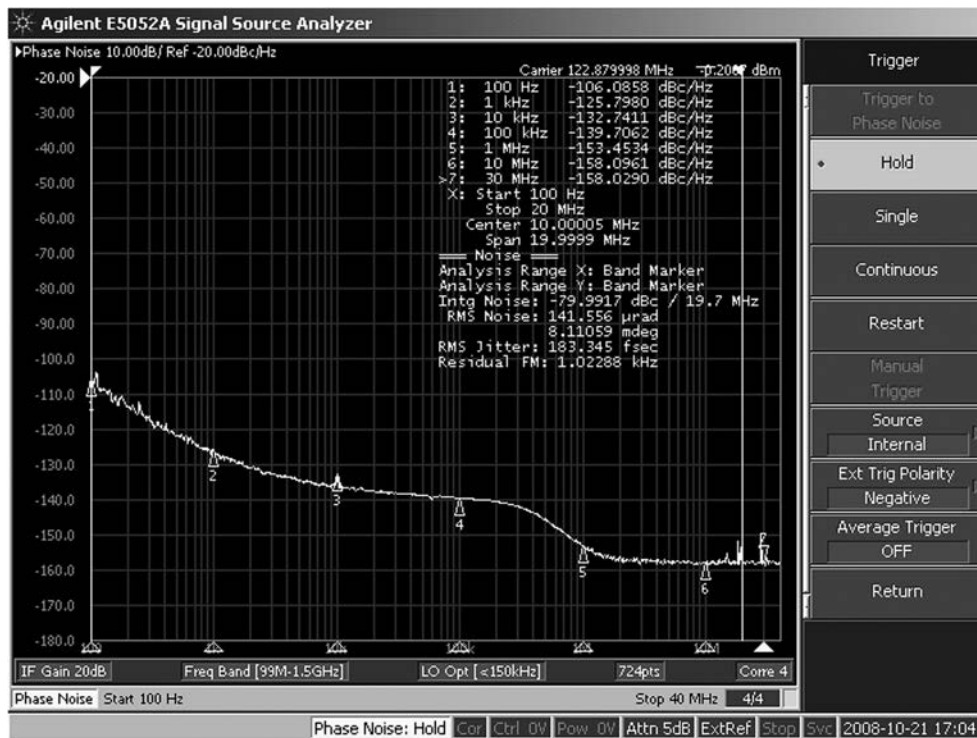

Figure 37. LMK04031 LVDS Phase Noise, Epson Toyocom TCO-2111-AA VCXO

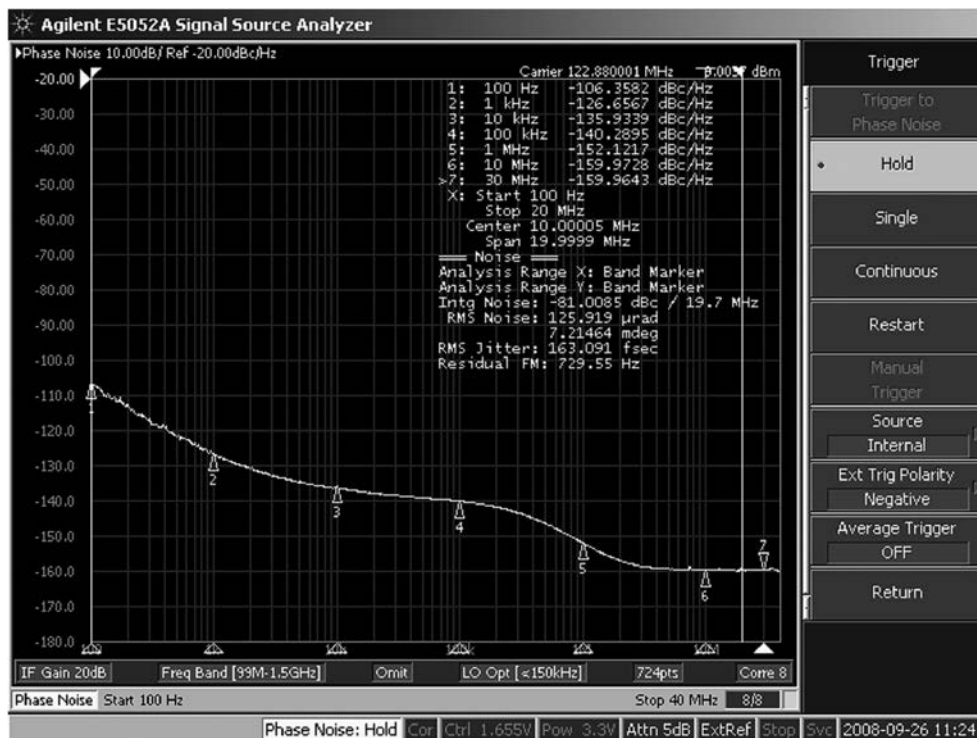

Figure 38. LMK04031 LVC MOS Phase Noise, Epson Toyocom TCO-2111-AA VCXO

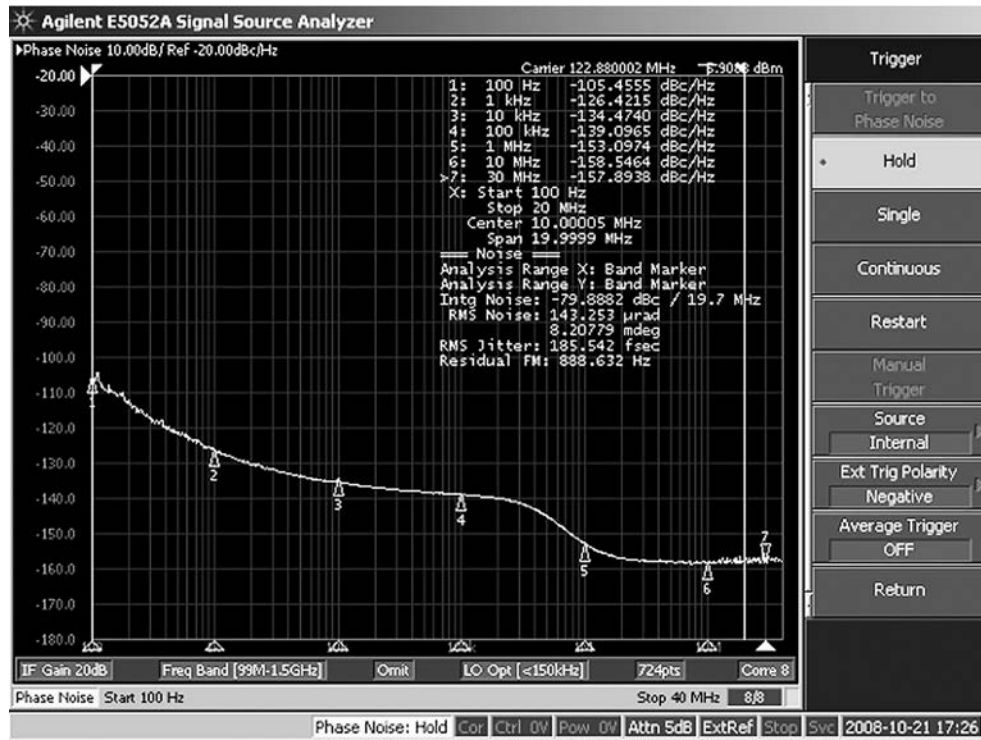

Figure 39. LMK04031 LVPECL Phase Noise, Epson Toyocom TCO-2111-AA VCXO

3.8 Suntsu SVD Series VCXO, 54 MHz

Table 10. Suntsu SVD Series, 54 MHz

Reference Clock (MHz)	F _{comp1} (MHz)	PLL1 Loop BW (Hz)	F _{comp2} (MHz)	PLL2 Loop BW (kHz)
27	1.0	30	27	81.9

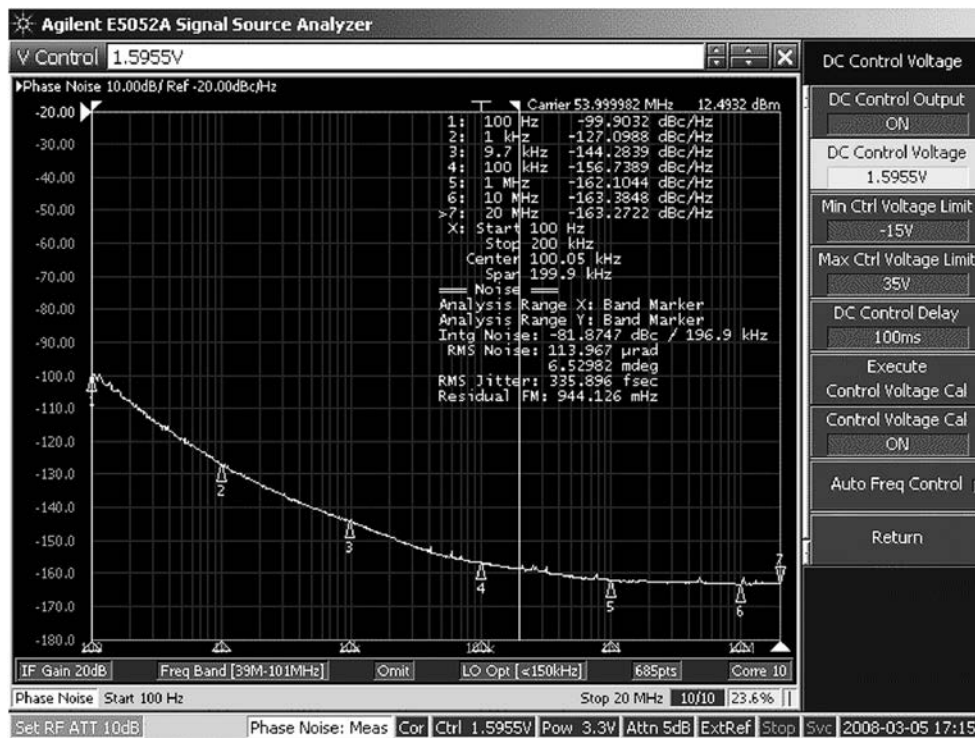

Figure 40. Suntsu SVD Series VCXO, 54 MHz, Open Loop Phase Noise

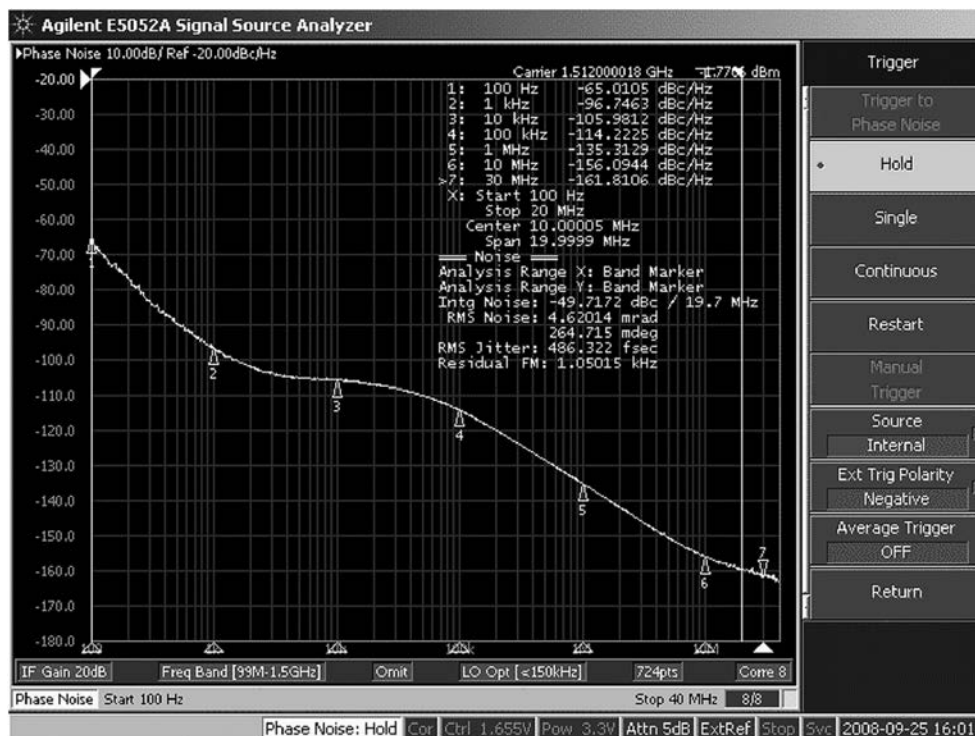

Figure 41. LMK04031 Four Phase Noise, Suntsu SVD Series VCXO, 54 MHz

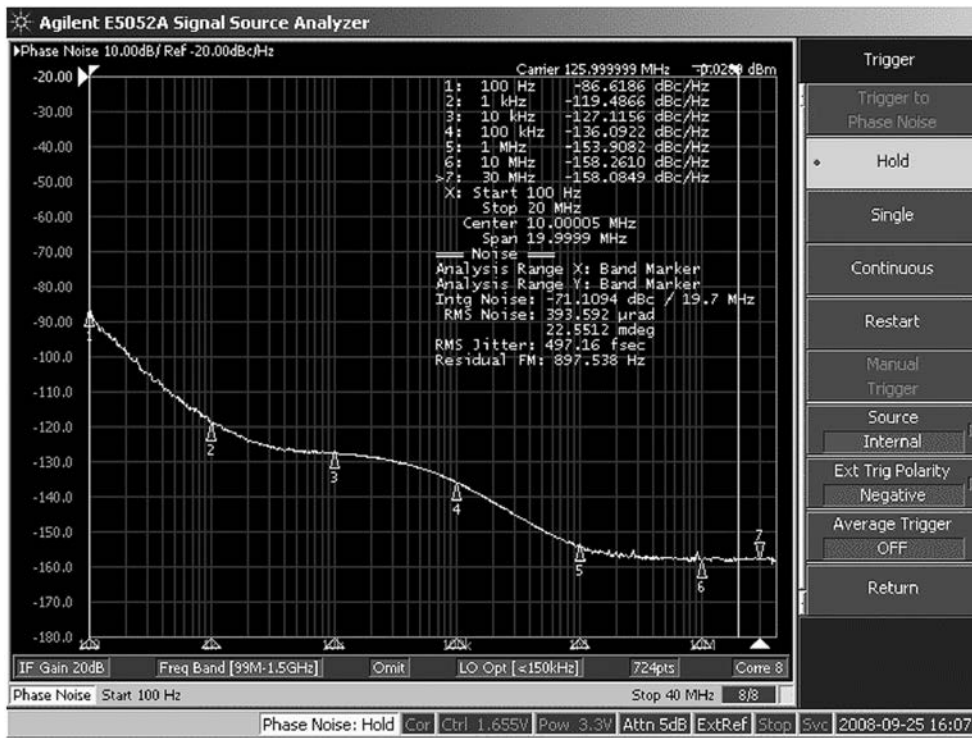

Figure 42. LMK04031 LVDS Phase Noise, Suntsu SVD Series VCXO, 54 MHz

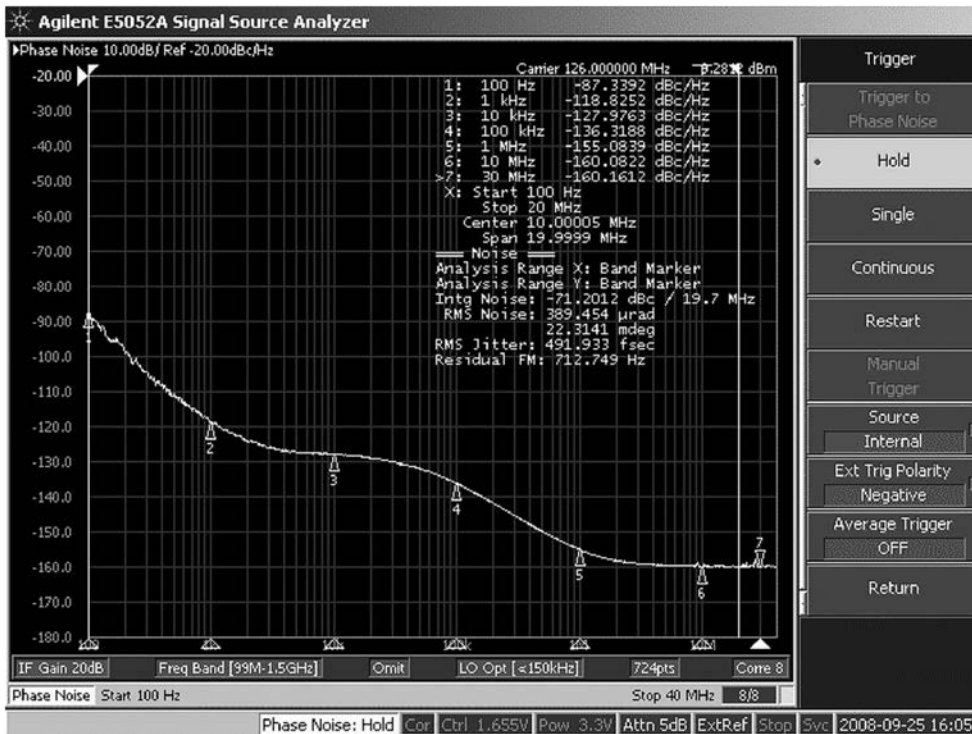

Figure 43. LMK04031 LVCMOS Phase Noise, Suntsu SVD Series VCXO, 54 MHz

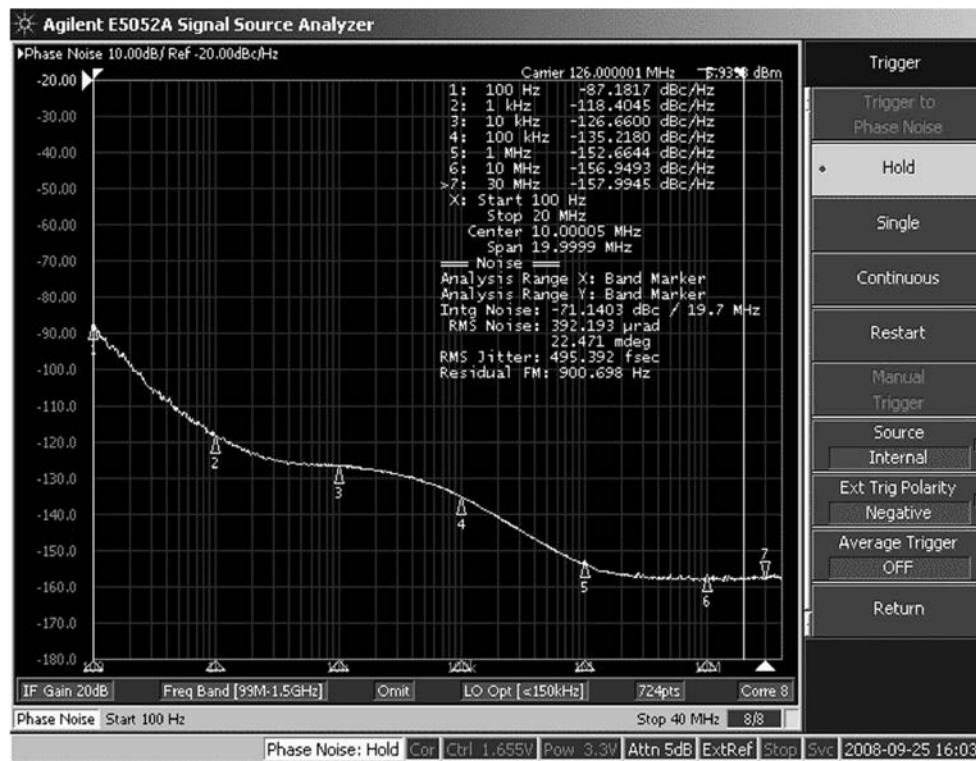

Figure 44. LMK04031 LVPECL Phase Noise, Suntsu SVD Series VCXO, 54 MHz

3.9 Suntsu SVD Series VCXO, 61.44 MHz

Table 11. Suntsu SVD Series, 61.44 MHz

Reference Clock (MHz)	F _{comp1} (MHz)	PLL1 Loop BW (Hz)	F _{comp2} (MHz)	PLL2 Loop BW (kHz)
30.72	1.024	30	30.72	95.4

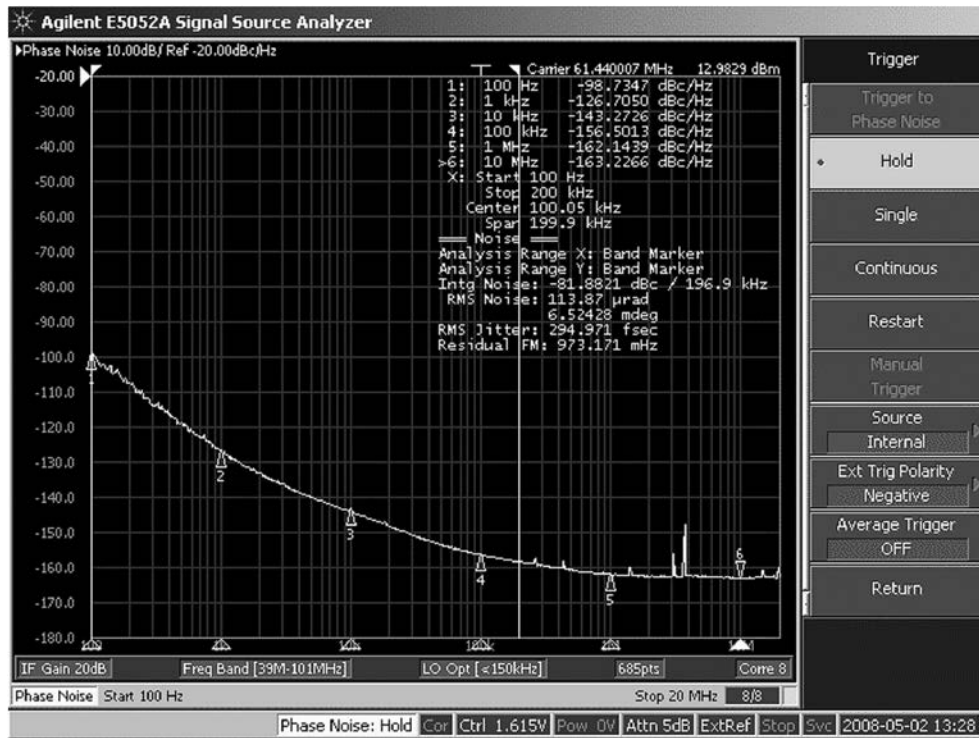

Figure 45. Suntsu SVD Series VCXO, 61.44 MHz, Open Loop Phase Noise

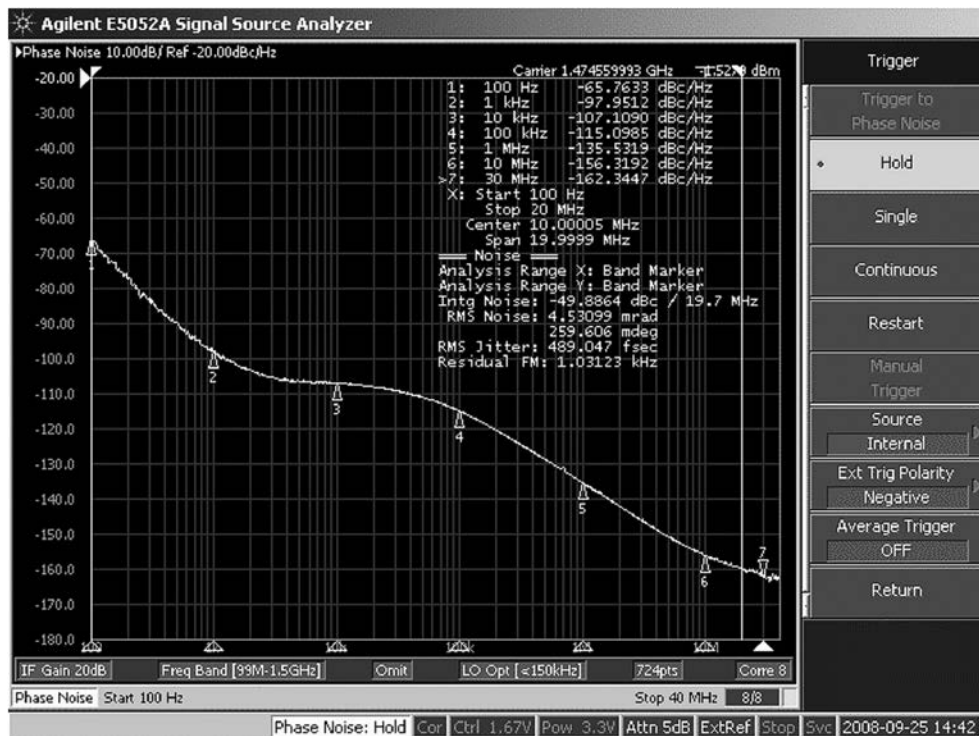

Figure 46. LMK04031 Four Phase Noise, Suntsu SVD Series VCXO, 61.44 MHz

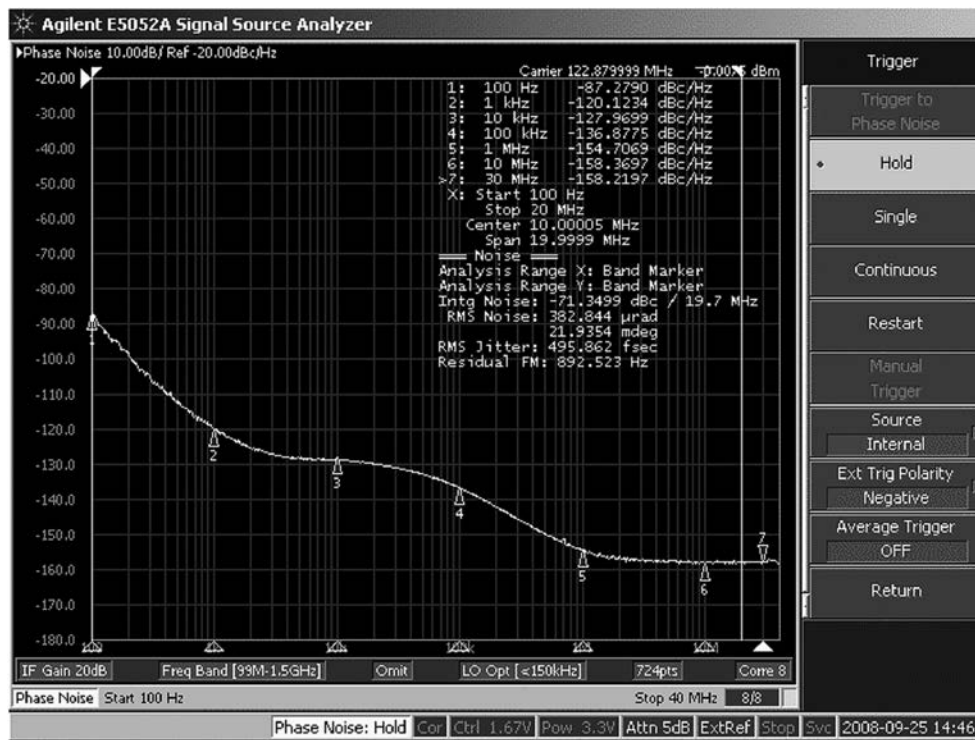

Figure 47. LMK04031 LVDS Phase Noise, Suntsu SVD Series VCXO, 61.44 MHz

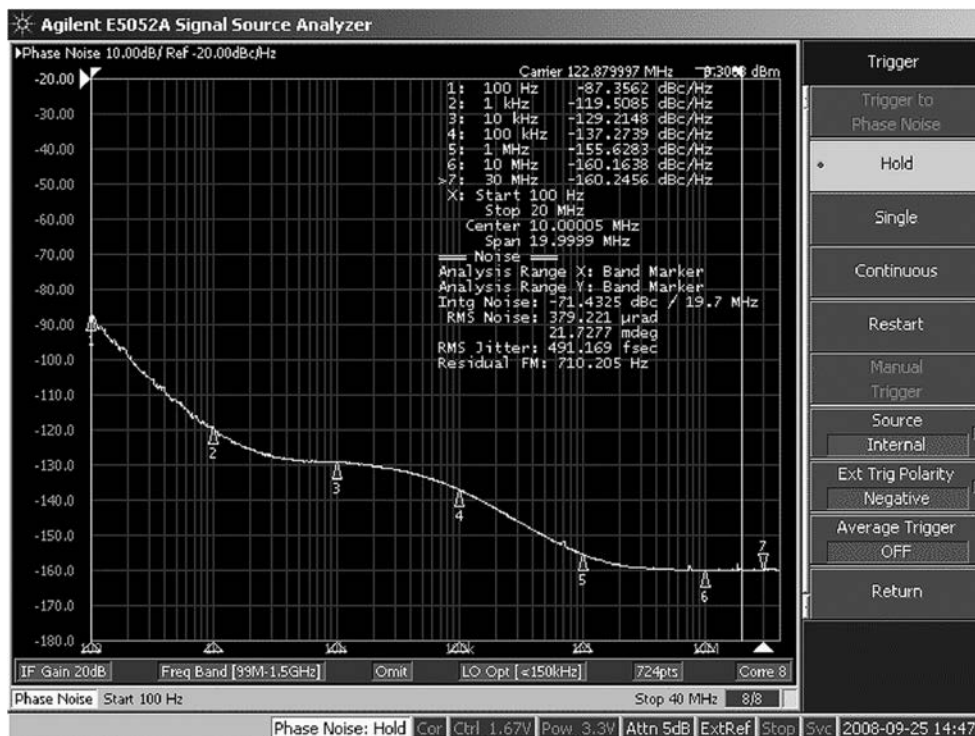

Figure 48. LMK04031 LVC MOS Phase Noise, Suntsu SVD Series VCXO, 61.44 MHz

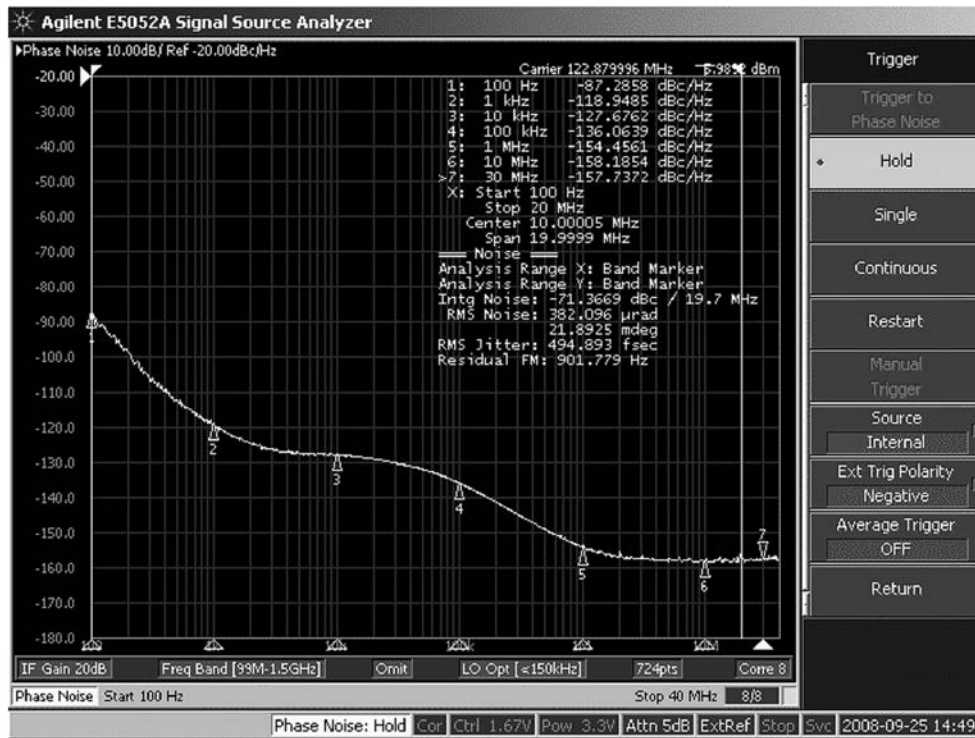

Figure 49. LMK04031 LVPECL Phase Noise, Suntsu SVD Series VCXO, 61.44 MHz

3.10 Suntsu SVD Series VCXO, 30.72 MHz

Table 12. Suntsu SVD Series, 30.72 MHz

Reference Clock (MHz)	F _{comp1} (MHz)	PLL1 Loop BW (Hz)	F _{comp2} (MHz)	PLL2 Loop BW (kHz)
30.72	1.024	20	30.72	95.4

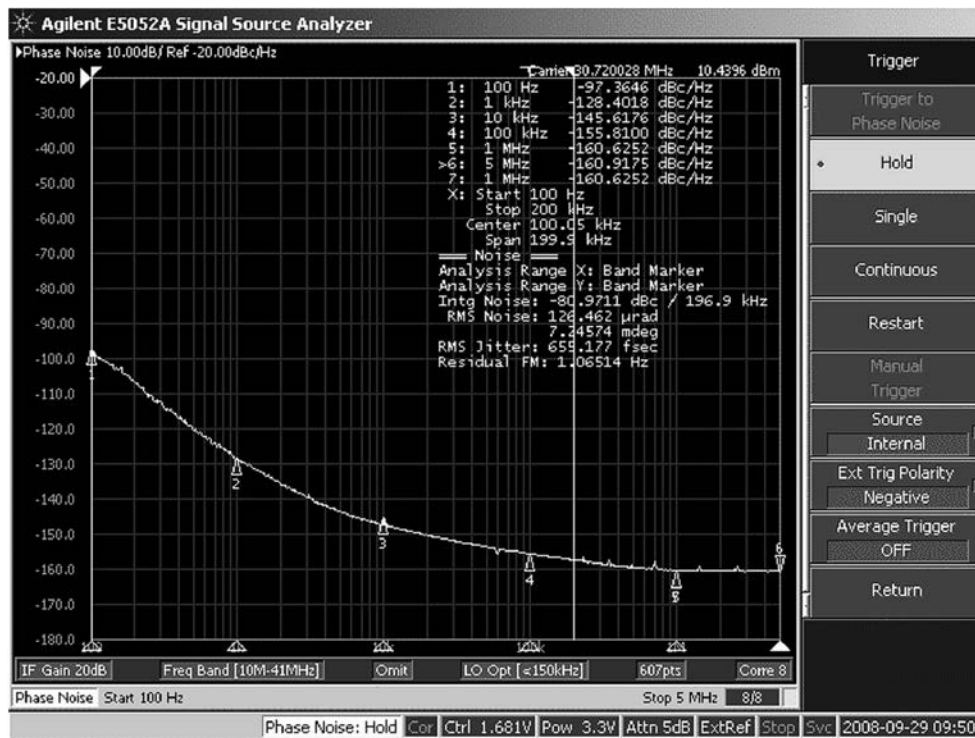

Figure 50. Suntsu SVD Series VCXO, 30.72 MHz, Open Loop Phase Noise

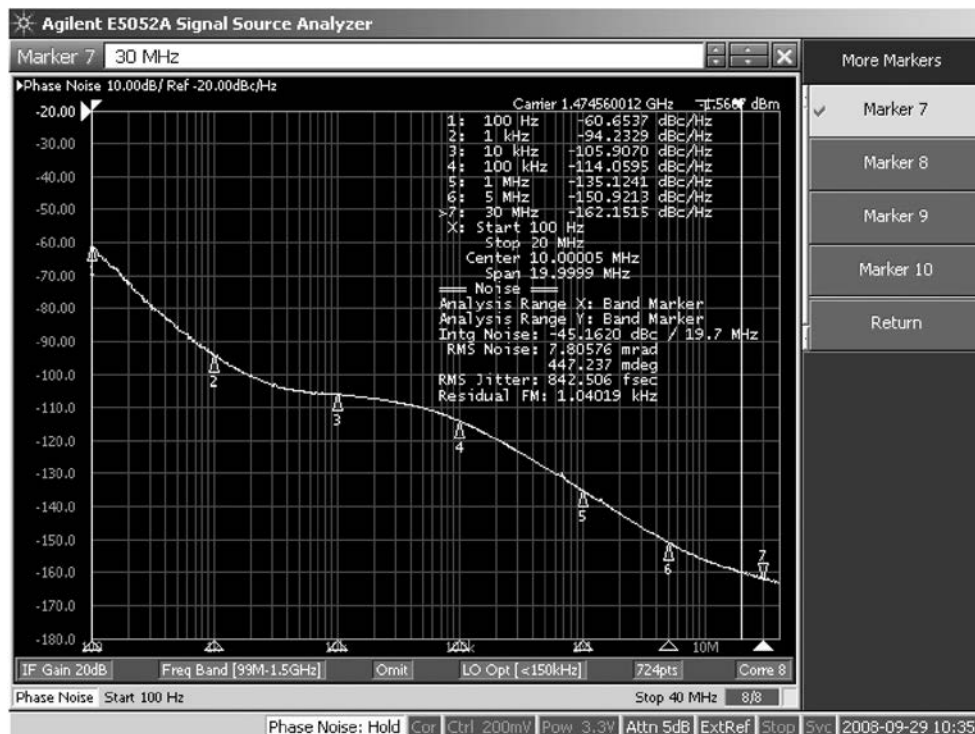

Figure 51. LMK04031 Four Phase Noise, Suntsu SVD Series VCXO, 30.72 MHz

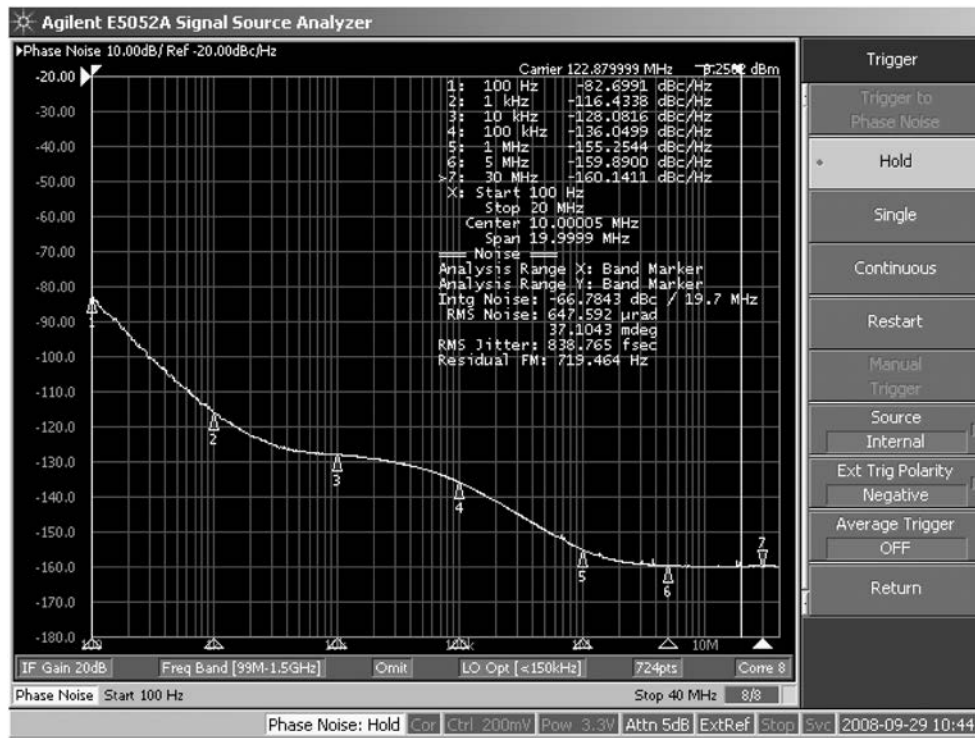

Figure 52. LMK04031 LVC MOS Phase Noise, Suntsu SVD Series VCXO, 30.72 MHz

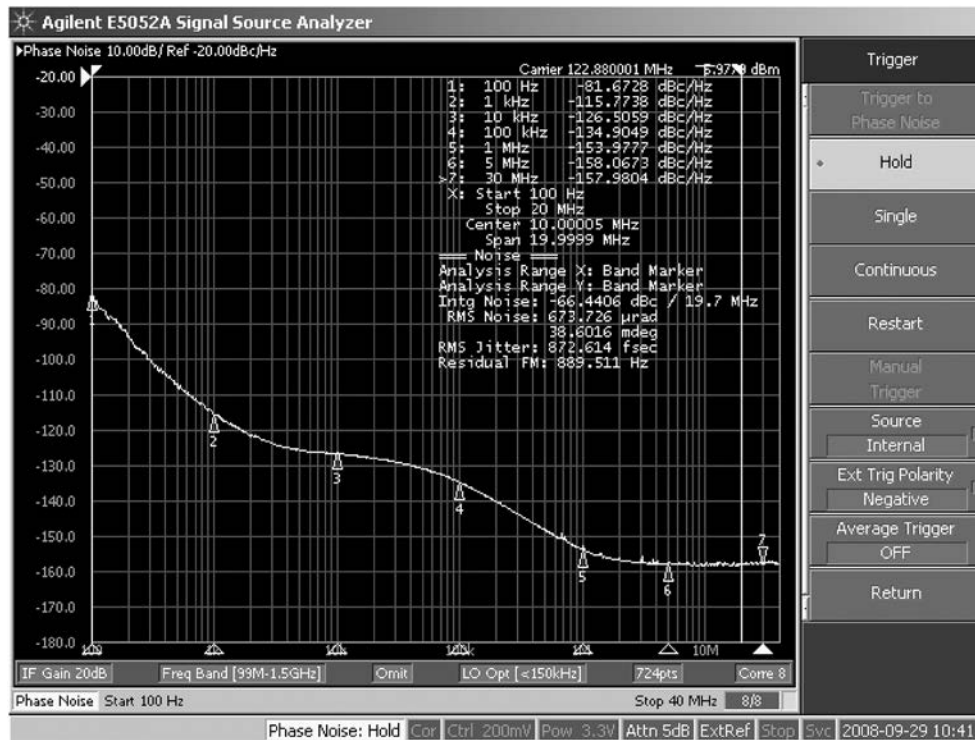

Figure 53. LMK04031 LVPECL Phase Noise, Suntsu SVD Series VCXO, 30.72 MHz

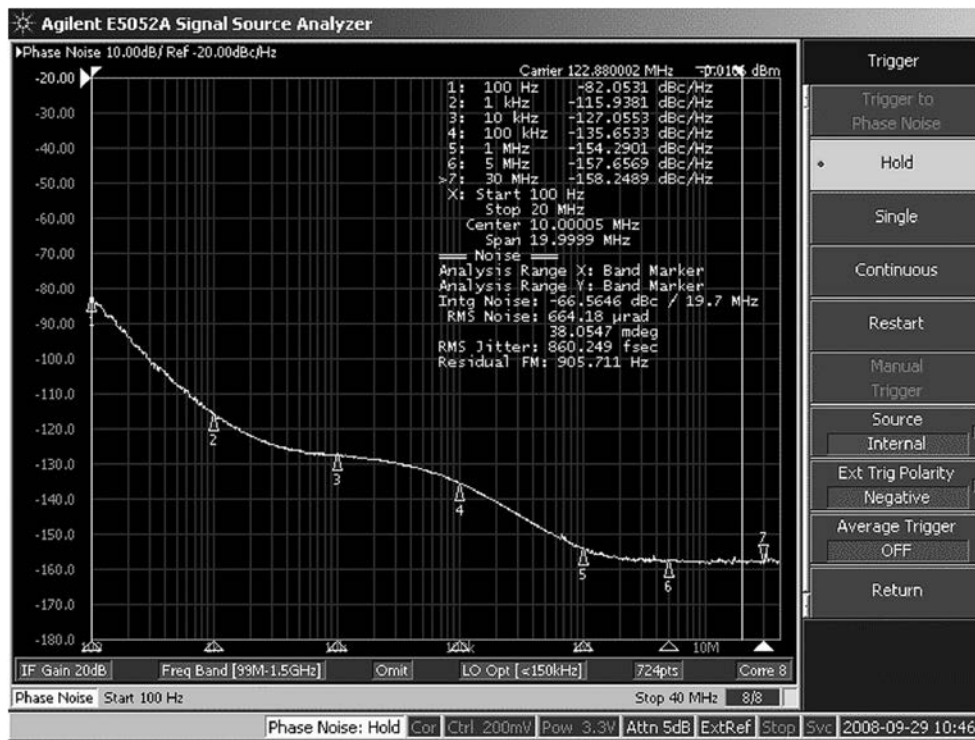

Figure 54. LMK04031 LVDS Phase Noise, Suntsu SVD Series VCXO, 30.72 MHz

3.11 Vectron Model 5310 VCXO, 155.52 MHz

Table 13. Vectron Model 5310, 155.52 MHz

Reference Clock (MHz)	F _{comp1} (MHz)	PLL1 Loop BW (Hz)	F _{comp2} (MHz)	PLL2 Loop BW (kHz)
38.88	1.08	30	51.84	152

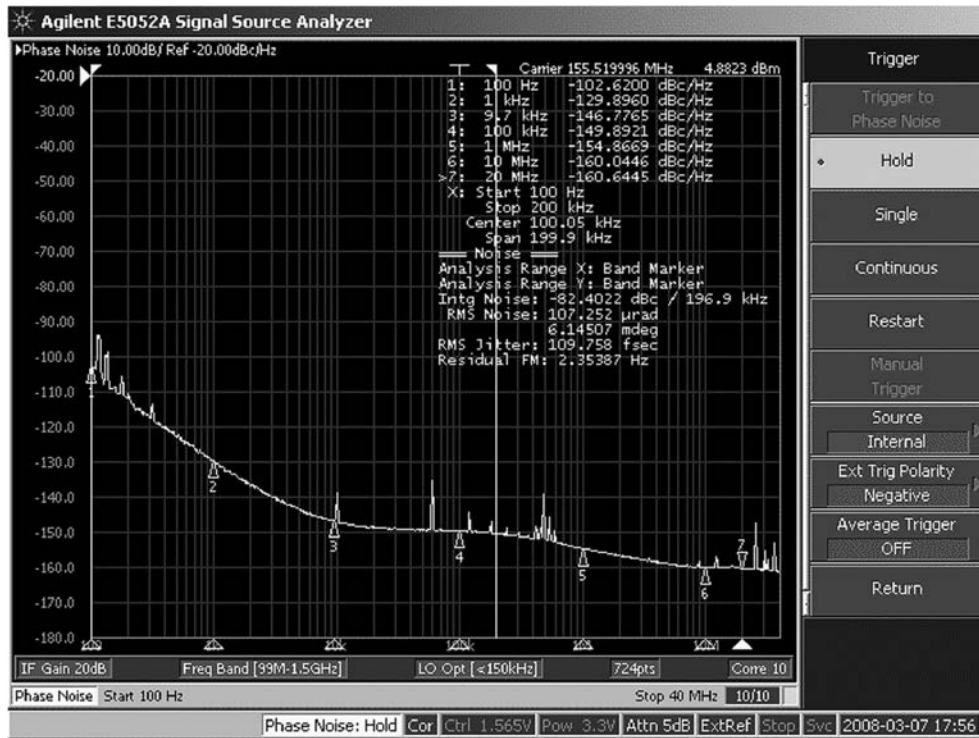

Figure 55. Vectron Model 5310 VCXO, 155.52 MHz, Open Loop Phase Noise

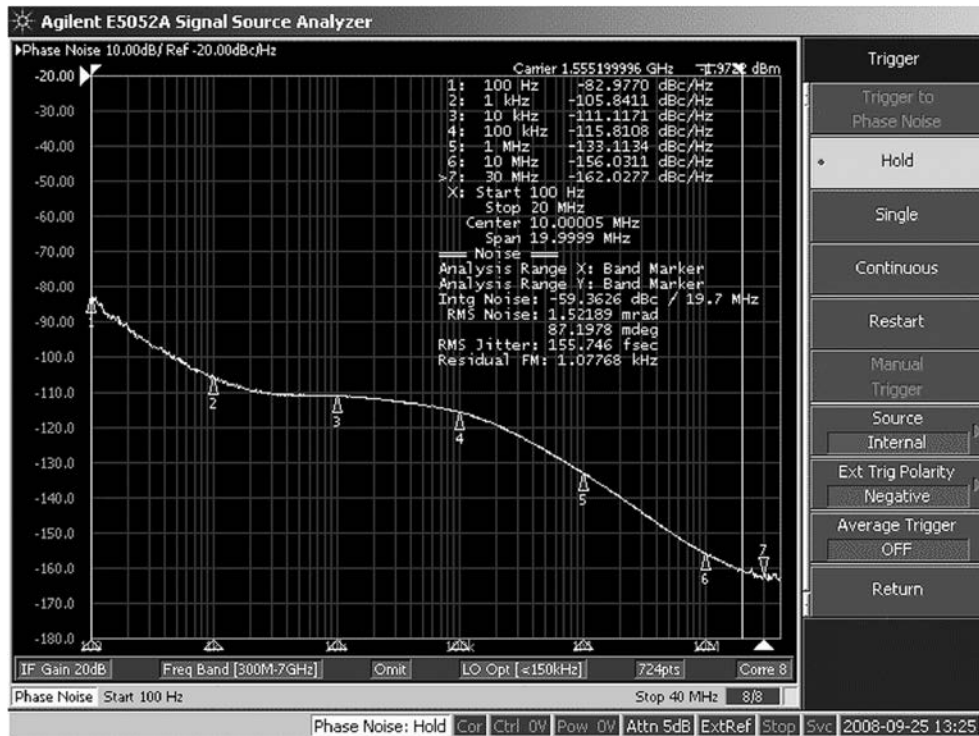

Figure 56. LMK04031 Fout Phase Noise, Vectron Model 5310 VCXO, 155.52 MHz

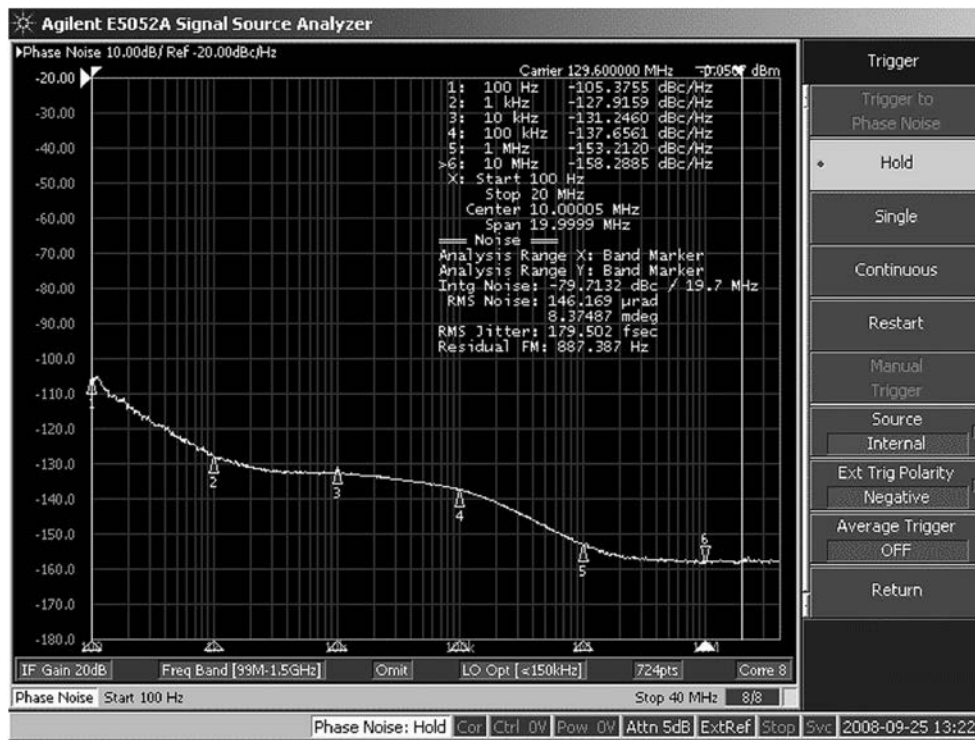

Figure 57. LMK04031 LVDS Phase Noise, Vectron Model 5310 VCXO, 155.52 MHz

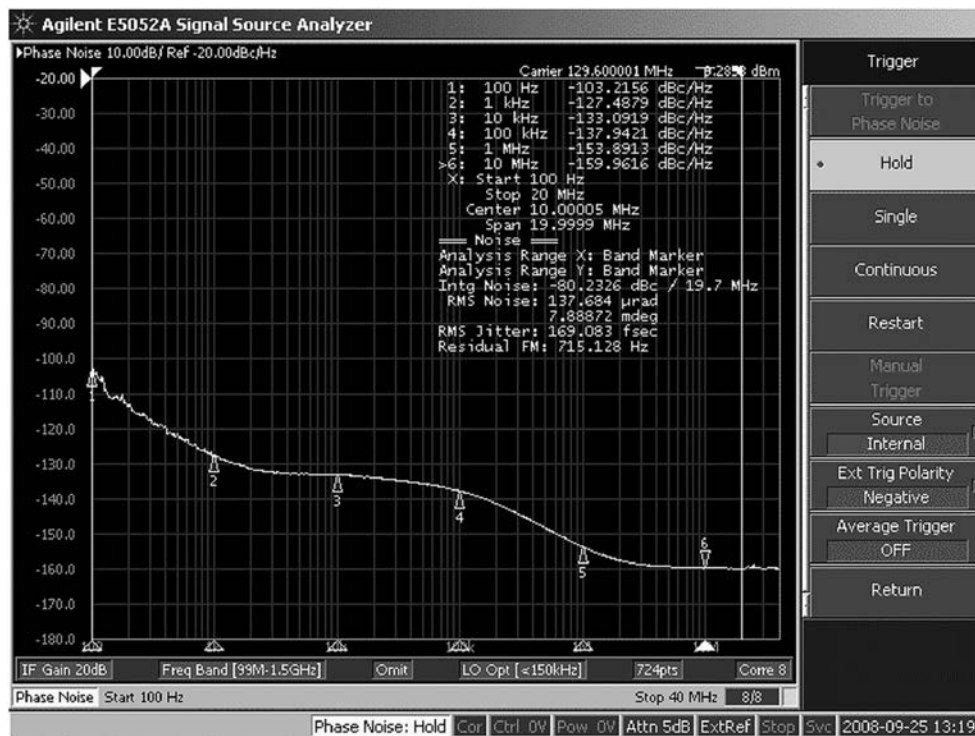

Figure 58. LMK04031 LVCMOS Phase Noise, Vectron Model 5310 VCXO, 155.52 MHz

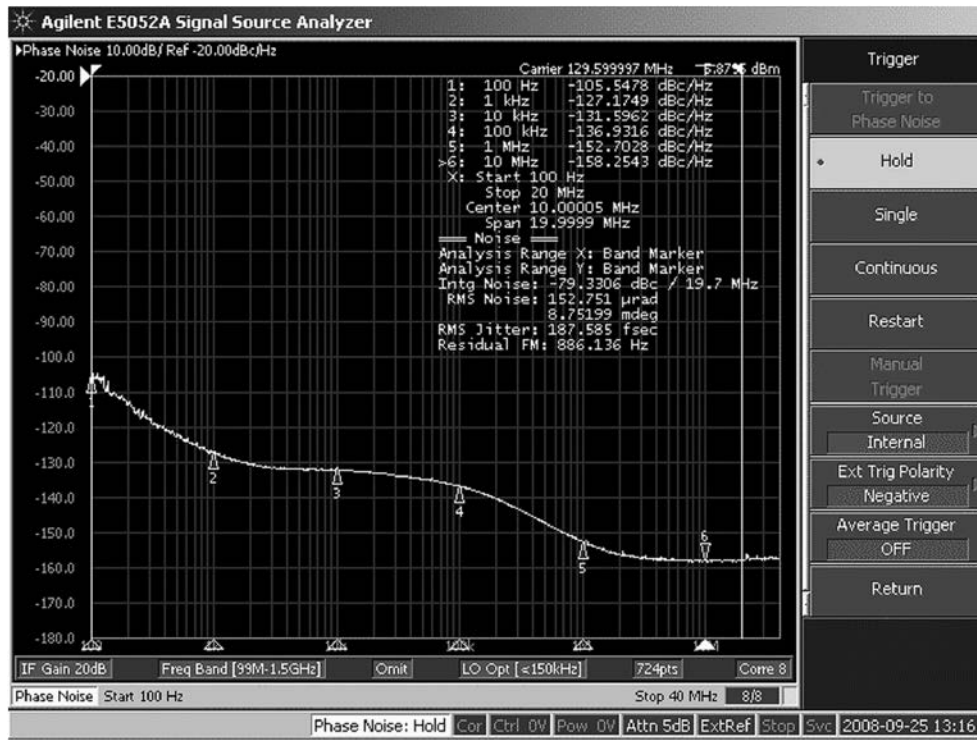

Figure 59. LMK04031 LVPECL Phase Noise, Vectron Model 5310 VCXO, 155.52 MHz

3.12 Vectron Model 5310 VCXO, 134.4 MHz

Table 14. Vectron Model 5310, 134.4 MHz

Reference Clock (MHz)	F _{comp1} (MHz)	PLL1 Loop BW (Hz)	F _{comp2} (MHz)	PLL2 Loop BW (kHz)
33.6	1.05	30	44.8	134.3

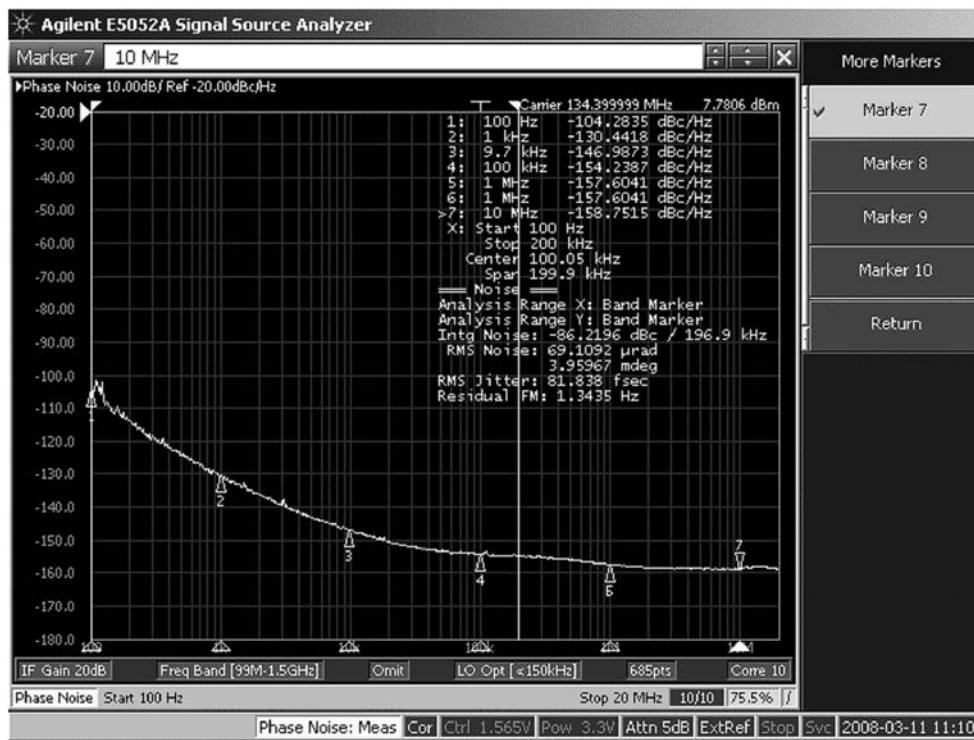

Figure 60. Vectron Model 5310 VCXO, 134.4 MHz, Open Loop Phase Noise

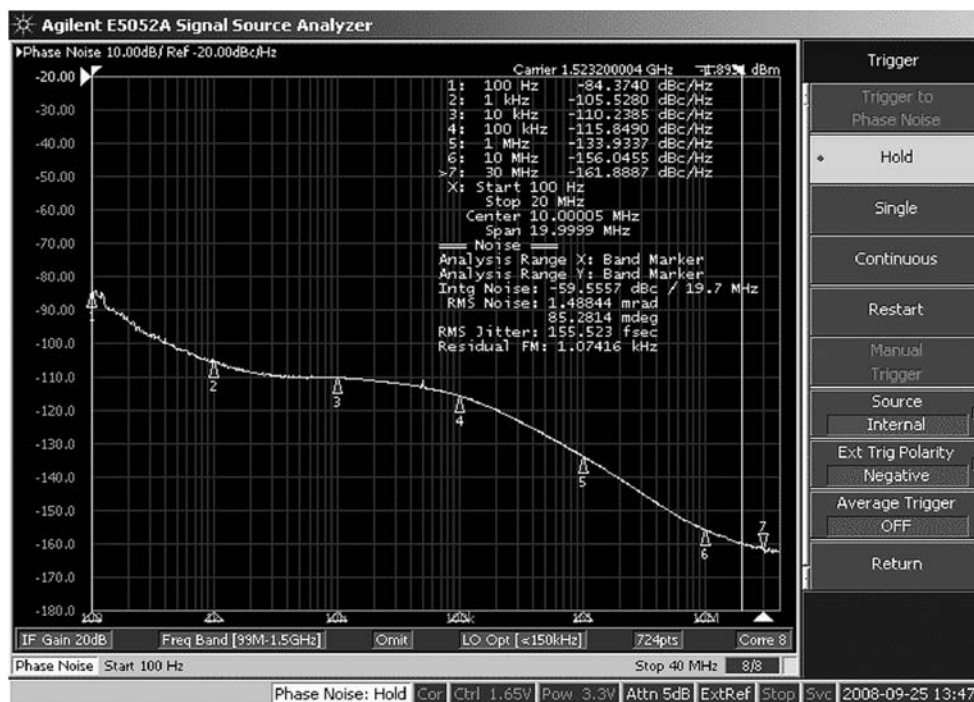

Figure 61. LMK04031 Fout Phase Noise, Vectron Model 5310 VCXO, 134.4 MHz

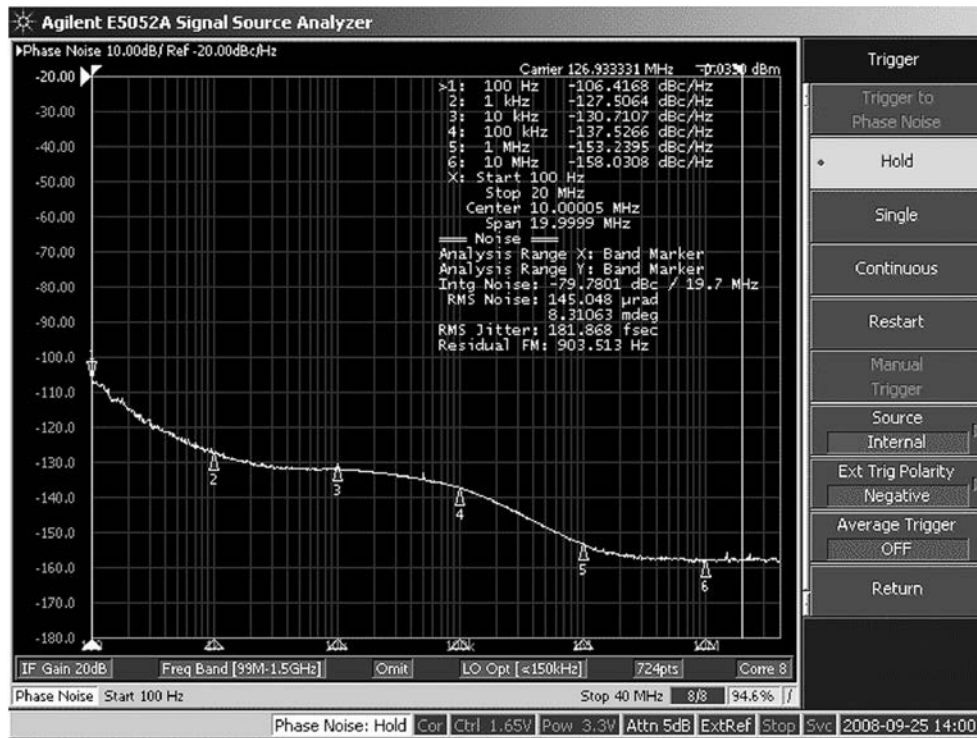

Figure 62. LMK04031 LVDS Phase Noise, Vectron Model 5310 VCXO, 134.4 MHz

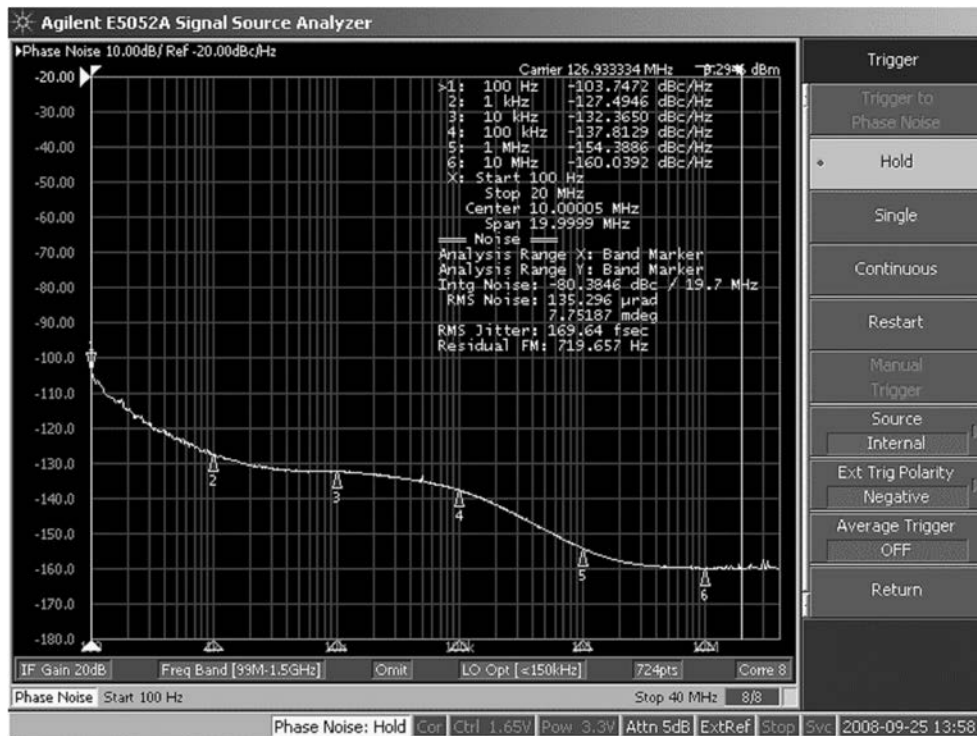

Figure 63. LMK04031 LVC MOS Phase Noise, Vectron Model 5310 VCXO, 134.4 MHz

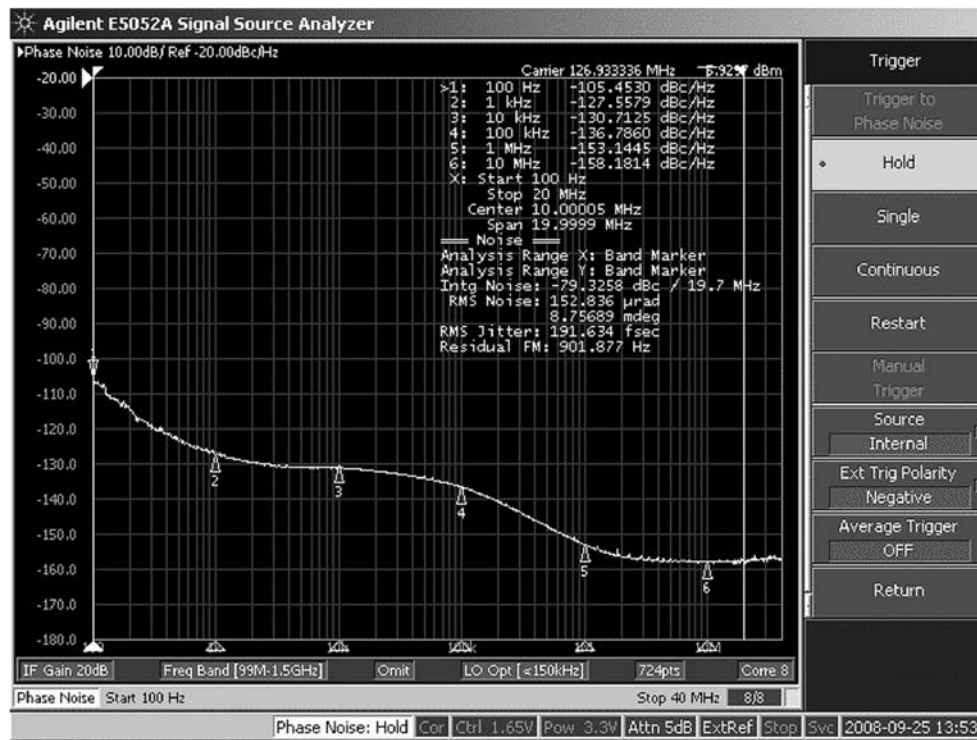

Figure 64. LMK04031 LVPECL Phase Noise, Vectron Model 5310 VCXO, 134.4 MHz

IMPORTANT NOTICE

Texas Instruments Incorporated and its subsidiaries (TI) reserve the right to make corrections, enhancements, improvements and other changes to its semiconductor products and services per JESD46, latest issue, and to discontinue any product or service per JESD48, latest issue. Buyers should obtain the latest relevant information before placing orders and should verify that such information is current and complete. All semiconductor products (also referred to herein as "components") are sold subject to TI's terms and conditions of sale supplied at the time of order acknowledgment.

TI warrants performance of its components to the specifications applicable at the time of sale, in accordance with the warranty in TI's terms and conditions of sale of semiconductor products. Testing and other quality control techniques are used to the extent TI deems necessary to support this warranty. Except where mandated by applicable law, testing of all parameters of each component is not necessarily performed.

TI assumes no liability for applications assistance or the design of Buyers' products. Buyers are responsible for their products and applications using TI components. To minimize the risks associated with Buyers' products and applications, Buyers should provide adequate design and operating safeguards.

TI does not warrant or represent that any license, either express or implied, is granted under any patent right, copyright, mask work right, or other intellectual property right relating to any combination, machine, or process in which TI components or services are used. Information published by TI regarding third-party products or services does not constitute a license to use such products or services or a warranty or endorsement thereof. Use of such information may require a license from a third party under the patents or other intellectual property of the third party, or a license from TI under the patents or other intellectual property of TI.

Reproduction of significant portions of TI information in TI data books or data sheets is permissible only if reproduction is without alteration and is accompanied by all associated warranties, conditions, limitations, and notices. TI is not responsible or liable for such altered documentation. Information of third parties may be subject to additional restrictions.

Resale of TI components or services with statements different from or beyond the parameters stated by TI for that component or service voids all express and any implied warranties for the associated TI component or service and is an unfair and deceptive business practice. TI is not responsible or liable for any such statements.

Buyer acknowledges and agrees that it is solely responsible for compliance with all legal, regulatory and safety-related requirements concerning its products, and any use of TI components in its applications, notwithstanding any applications-related information or support that may be provided by TI. Buyer represents and agrees that it has all the necessary expertise to create and implement safeguards which anticipate dangerous consequences of failures, monitor failures and their consequences, lessen the likelihood of failures that might cause harm and take appropriate remedial actions. Buyer will fully indemnify TI and its representatives against any damages arising out of the use of any TI components in safety-critical applications.

In some cases, TI components may be promoted specifically to facilitate safety-related applications. With such components, TI's goal is to help enable customers to design and create their own end-product solutions that meet applicable functional safety standards and requirements. Nonetheless, such components are subject to these terms.

No TI components are authorized for use in FDA Class III (or similar life-critical medical equipment) unless authorized officers of the parties have executed a special agreement specifically governing such use.

Only those TI components which TI has specifically designated as military grade or "enhanced plastic" are designed and intended for use in military/aerospace applications or environments. Buyer acknowledges and agrees that any military or aerospace use of TI components which have **not** been so designated is solely at the Buyer's risk, and that Buyer is solely responsible for compliance with all legal and regulatory requirements in connection with such use.

TI has specifically designated certain components as meeting ISO/TS16949 requirements, mainly for automotive use. In any case of use of non-designated products, TI will not be responsible for any failure to meet ISO/TS16949.

Products

Audio	www.ti.com/audio
Amplifiers	amplifier.ti.com
Data Converters	dataconverter.ti.com
DLP® Products	www.dlp.com
DSP	dsp.ti.com
Clocks and Timers	www.ti.com/clocks
Interface	interface.ti.com
Logic	logic.ti.com
Power Mgmt	power.ti.com
Microcontrollers	microcontroller.ti.com
RFID	www.ti-rfid.com
OMAP Applications Processors	www.ti.com/omap
Wireless Connectivity	www.ti.com/wirelessconnectivity

Applications

Automotive and Transportation	www.ti.com/automotive
Communications and Telecom	www.ti.com/communications
Computers and Peripherals	www.ti.com/computers
Consumer Electronics	www.ti.com/consumer-apps
Energy and Lighting	www.ti.com/energy
Industrial	www.ti.com/industrial
Medical	www.ti.com/medical
Security	www.ti.com/security
Space, Avionics and Defense	www.ti.com/space-avionics-defense
Video and Imaging	www.ti.com/video

TI E2E Community

e2e.ti.com