

Common Mistakes When Designing With RF Clock Synthesizers



Narala Reddy, Purnachandar Poshala, and Ajeet Pal

Introduction

When using TI synthesizers, some common mistakes are easily mitigated. This application brief highlights some of the common mistakes to avoid so that users are efficiently able to set up the device. Topics that cover are as follows:

1. **Clock synthesizer phase noise performance is bad and not as per data sheet specifications. What is going wrong?**
2. **How to simulate the performance of clock synthesizer with different Reference clock source phase noise?**
3. **Common issues with Input and Output terminations and impedance mismatches.**
4. **Impact of Slew rate of Reference on Clock Output Phase Noise**
5. **Impact of Clock Amplitude on ADC SNR performance**
6. **Clock synthesizer testing – debug flow**

1. Phase noise performance of the clock synthesizer

A common mistake when using TI synthesizers is when the phase noise performance of the clock synthesizer does not match the data sheet specifications.

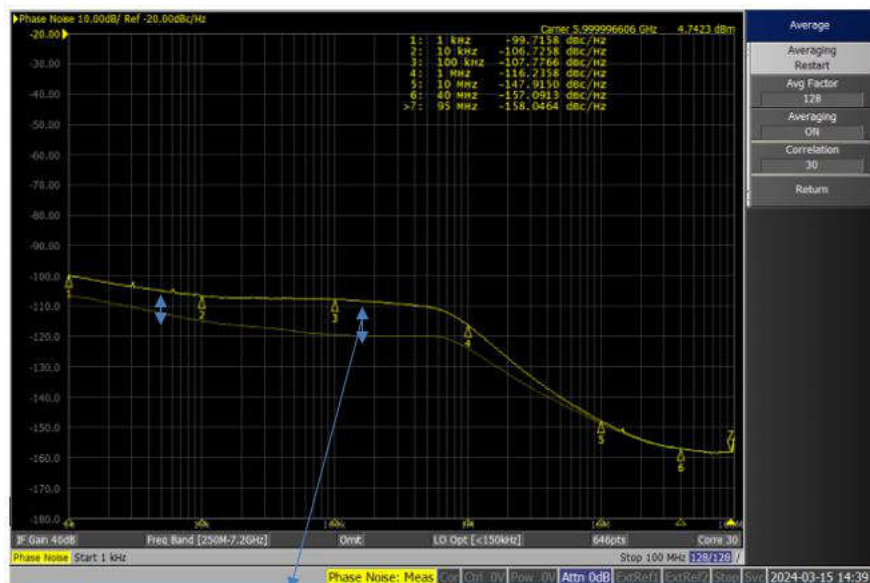

Figure 1. Phase noise performance of the clock synthesizer output with two different source

The difference in phase noise performance is not expected because both the light and bold traces in Figure 1 are from the same LMX2820 devices and set at the same 6GHZ output setting.

The bold trace in Figure 1 shows a degraded performance in comparison to the data sheet specification.

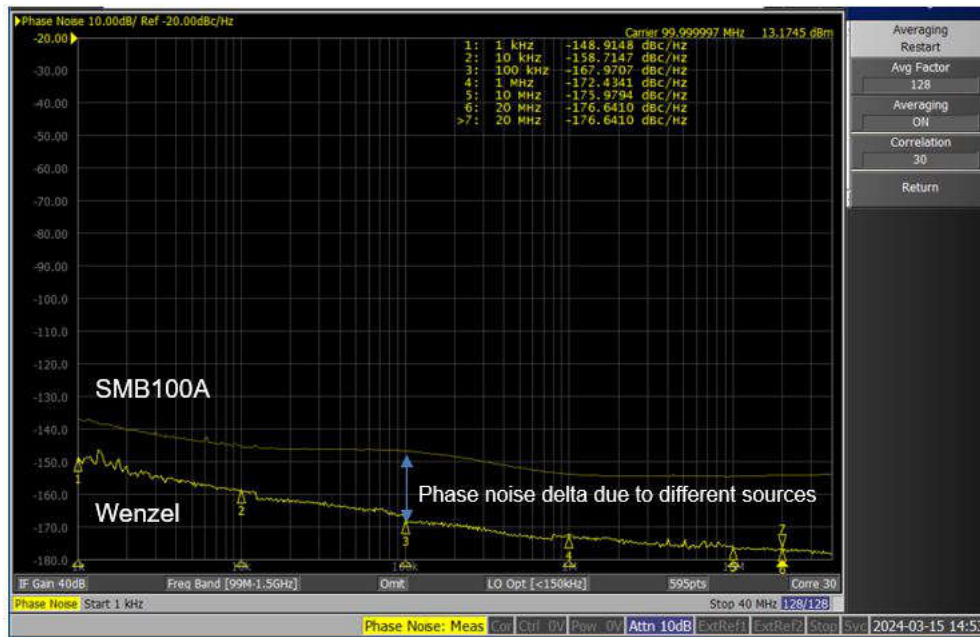

Figure 2. Different sources 100MHz Phase Noise Performance

The light trace in Figure 1 is generated with Wenzel 100MHz, used as a reference clock to the LMX2820 EVM. The degraded performance was generated using the SMB100A signal generator as a reference clock to the LMX2820 EVM.

In summary, the reference oscillator and source impacts the overall phase noise performance. To achieve performance data that is similar to the data sheet, use the good source as input to the LMX device.

Simulation of the LMX2820 with exact an source phase noise is available using the PLLatinum Sim software tool.

5052B Settings impact on phase noise



Figure 3. 5052B Settings impact on phase noise

As shown in above in the [Figure 3](#) graph, note warning settings before taking actual phase noise measurements. When checking the power on the PN analyzer, confirm that the trace loss on EVM is de-embedded, to calculate the power at the pin of the device.

2. Simulating the performance of a clock synthesizer with different phase noise of the reference clock source

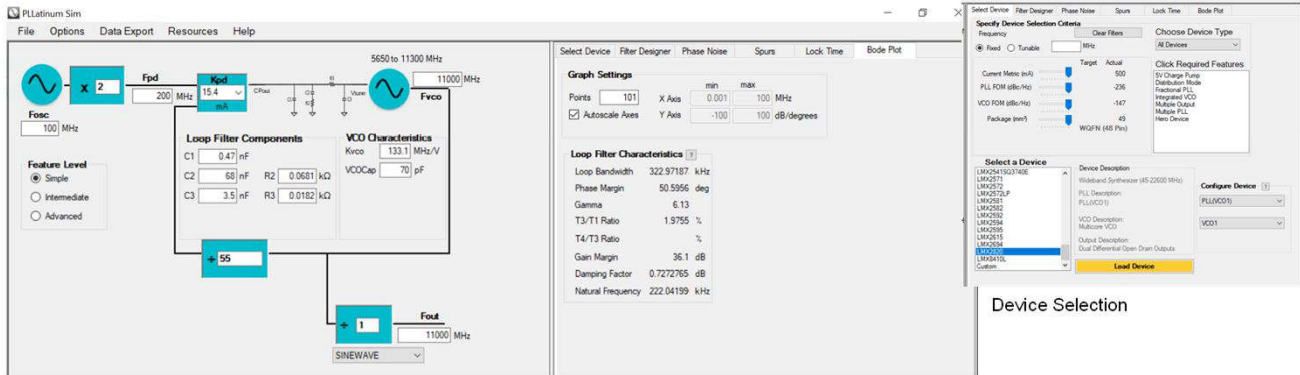

Figure 4. Clock Synthesizer Performance Simulation

[Figure 4](#) shows the PLLatinum sim tool simulation window. Confirm that the settings on board are entered into PLLatinum and the phase margin is verified before checking PN plots.

Following [Figure 5](#), [Figure 6](#) shows the PLLatinum sim tool simulation results for two different input clock profiles.

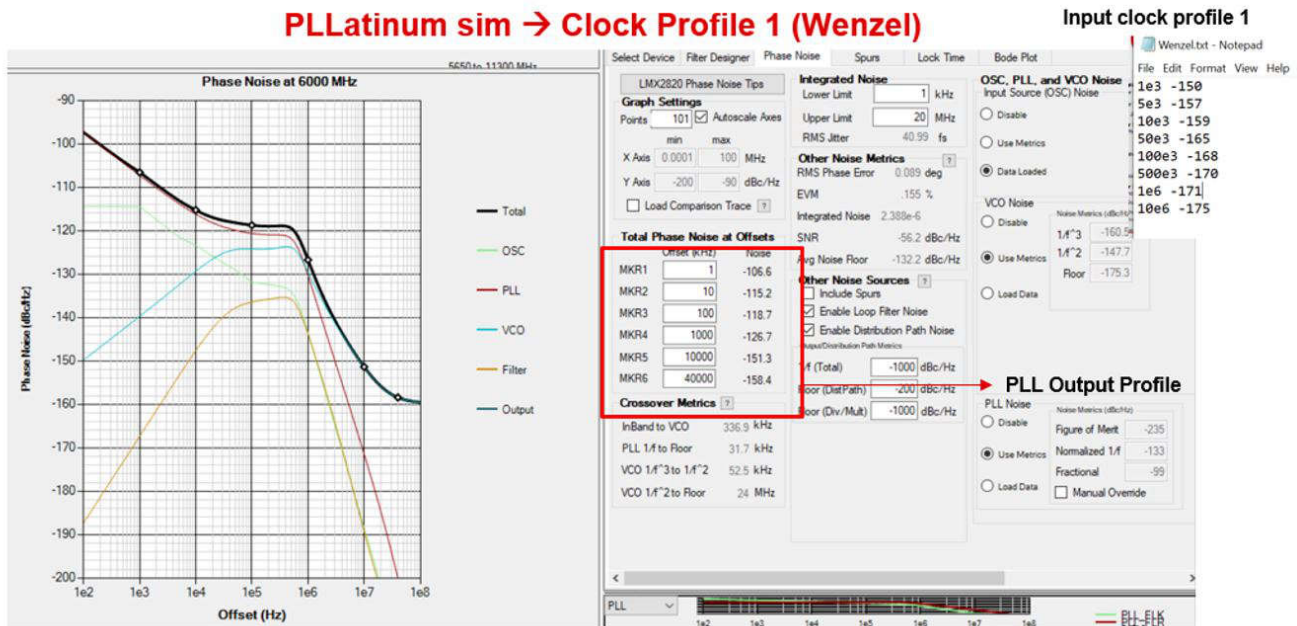

Figure 5. Output phase noise profile of LMX2820 with input Clock Profile 1 (Wenzel)

PLLatinum sim → Clock Profile 2 (SMB100A)

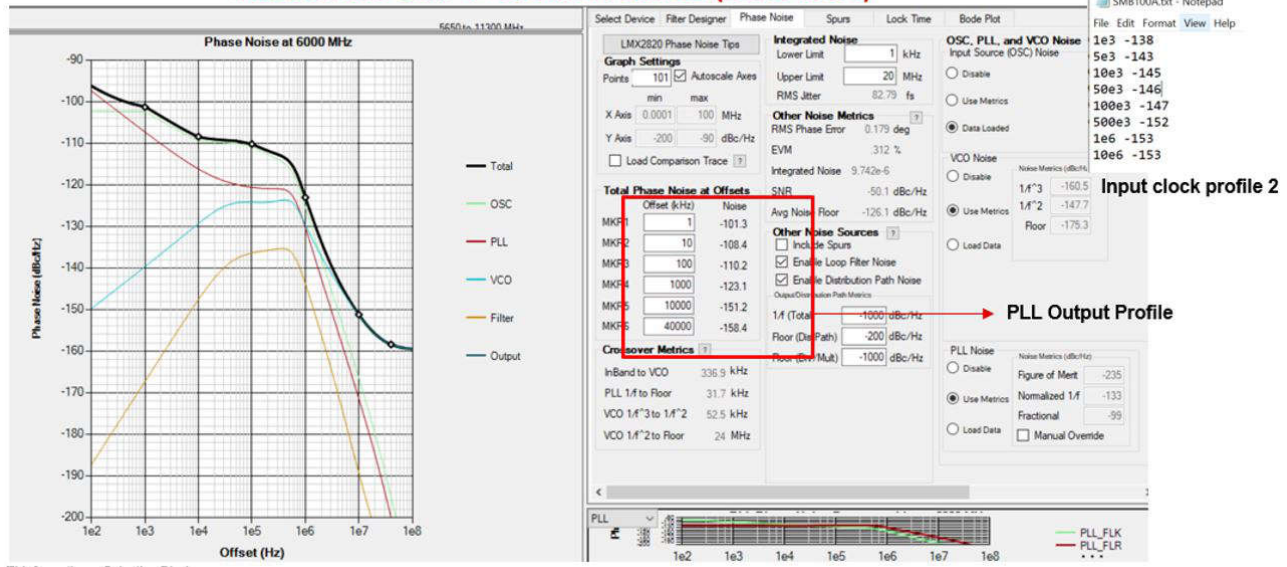

Figure 6. Output phase noise profile of LMX2820 with input Clock Profile 2 (SMB100A)

3. Common Issues with Input and Output terminations and Impedance Mismatches

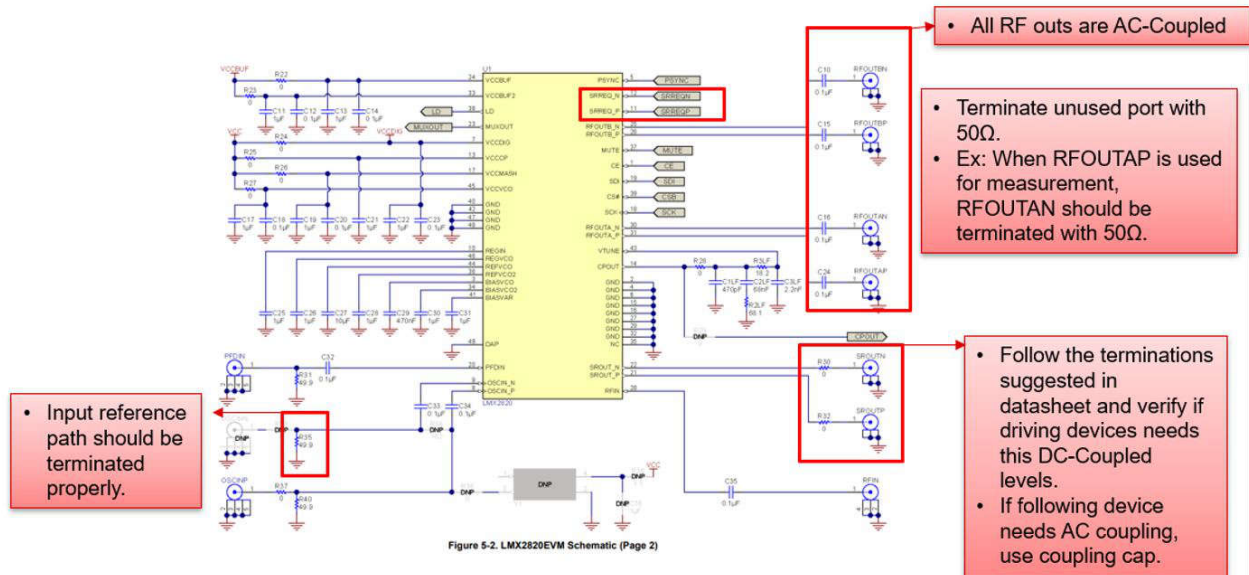

Figure 7. Common Issues with Input and Output terminations and Impedance Mismatches

Figure 7 shows various termination requirements based on input or output ports. Sometimes, there is damaged input coupling capacitor, which may damage the internal common mode operation for the input OSCIN_P pins and there could be issues with loop locking. Check to make sure the common mode at the OSCIN_P and OSCIN_N are the same.

4. Impact of Slew rate of Reference on Clock Output Phase Noise



Figure 8. 6GHz output on LMX2820 with reference (OSCIN) levels of -5dbm and 10dbm

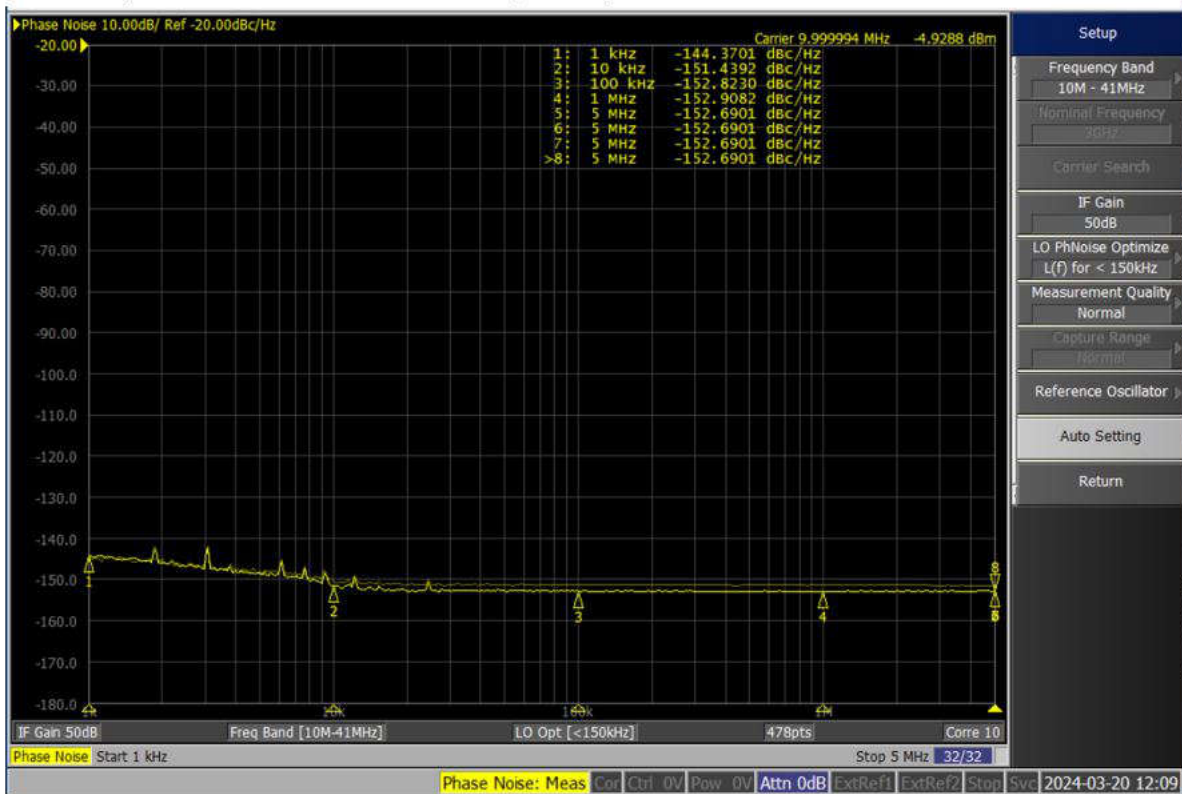

Figure 9. Reference (OSCIN) 10MHz reference PN plot for -5dbm and 10dbm

In general, low reference frequencies have less slew rate. At 10-MHz input, slew rate is very problematic. At 100-MHz input, there is 10 times the slew rate for the same power level. Even though there is minimal phase noise change at the input 10-MHz clock source for two different amplitude as shown in Figure 9, there is huge change in output phase noise as shown in Figure 8. Use a low noise buffers LMK1C1102 in the path of the 10MHz to boost the amplitude before giving to OSCIN_P.

5. Impact of clock amplitude on ADC SNR performance

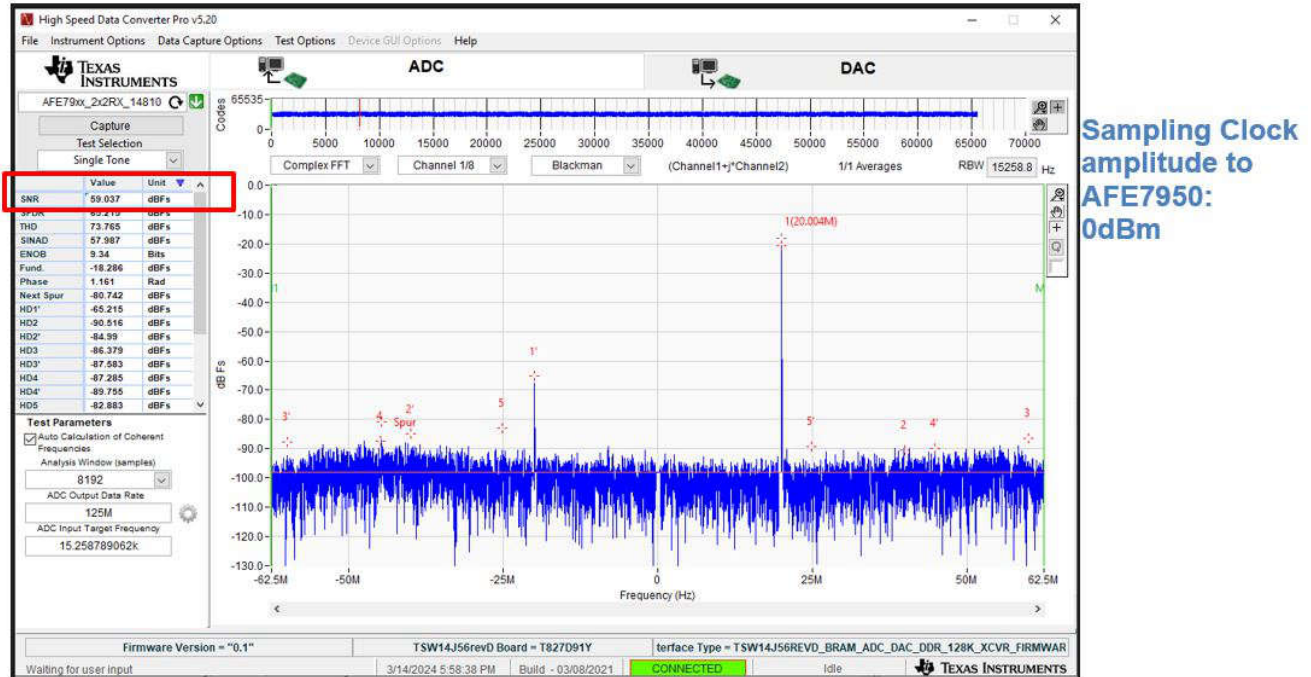

Figure 10. ADC capture with Sampling clock amplitude to AFE7950: 0dBm

AFE7950 FFT plot - 12GHz Sampling Clock (Fs) from LMX2820; Ain: -18dBFS. Input Frequency: 9520MHz; ADC Fs: 3GSPS; NCO: 9500MHz; Decimation:24

With Amplifier in the Clock path

Sampling Clock
 amplitude to
 AFE7950: 9.5dBm
 SNR: 67dBFS

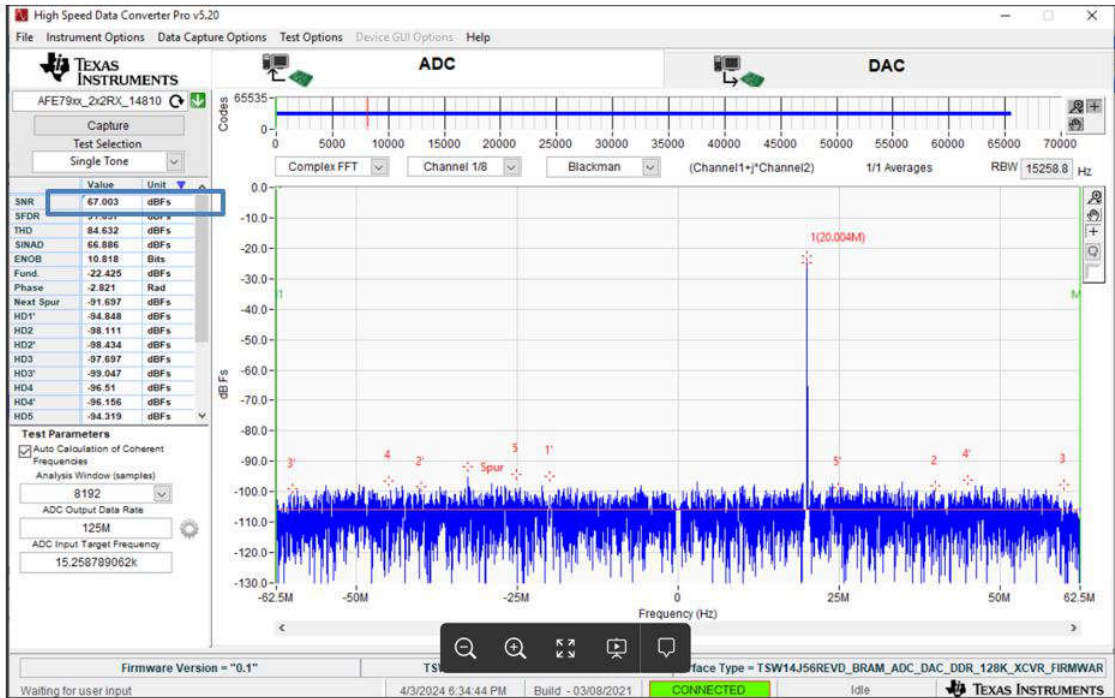

Figure 11. ADC capture with Sampling clock amplitude to AFE7950: 9.5Bm

AFE7950 FFT plot - 12GHz Sampling Clock (Fs) from LMX2820 + Amplifier (ZJL-153+) Input Frequency: 9520MHz; ADC Fs: 3GSPS; NCO: 9500MHz; Decimation:24

HD3	-97.697	dBFS
HD3'	-99.047	dBFS
HD4	-96.51	dBFS
HD4'	-96.156	dBFS
HD5	-94.319	dBFS
HD5'	-98.555	dBFS
N SD/Hz	-147.843	dBFS/Hz
		dBFS Hz
M1	-103.853	-6.25E+7
M2	-103.853	6.25E+7
Delta	0	1.25E+8

Figure 12. More Metrics from ADC capture

Table 1. SNR comparison with various configurations

Sampling clock from LMX2820 with different power levels	Sampling clock from LMC2820 and Amplifier (ZJL-153+)	Internal Clock (SNR)
0.18dBm/59dBFS	9.5dBm/67dBFS	61.4dBFS
-1.91dBm/56dBFS		
-3.19dBm/53dBFS		
-4.86dBm/36dBFS		

For the best SNR performance, use an external clock with the highest amplitude recommended for the ADC.

When these features are together, there is a 4 - 5dB signal power loss due to many losses in the path of the signal:

- LMX2820 EVM output trace
- SMA
- AFE EVM SMA
- AFE EVM Balun

It is important to understand LMX2820 data sheet specification for power level and compare with the requirement for AFE ADC/DAC Clock power level, as shown in [Table 1](#).

6. Clock synthesizer testing the debug flow

Figure 13 outlines the systematic debug of the PLL.

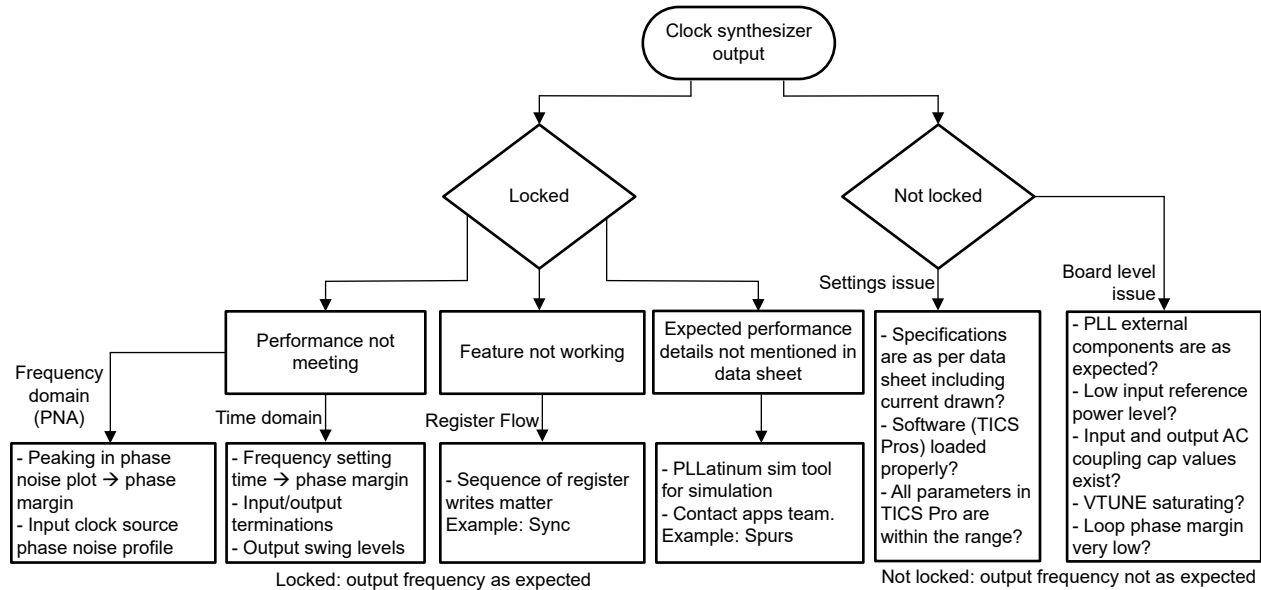

Figure 13. Systematic Debug Flowchart

References

- Texas Instruments, [A Survival Guide to Scaling Your PLL Loop Filter Design](#), technical article
- Texas Instruments, [Timing Is Everything: Improving Integer Boundary Spurs in Fractional PLL Synthesizers](#), technical article

Trademarks

All trademarks are the property of their respective owners.

IMPORTANT NOTICE AND DISCLAIMER

TI PROVIDES TECHNICAL AND RELIABILITY DATA (INCLUDING DATA SHEETS), DESIGN RESOURCES (INCLUDING REFERENCE DESIGNS), APPLICATION OR OTHER DESIGN ADVICE, WEB TOOLS, SAFETY INFORMATION, AND OTHER RESOURCES "AS IS" AND WITH ALL FAULTS, AND DISCLAIMS ALL WARRANTIES, EXPRESS AND IMPLIED, INCLUDING WITHOUT LIMITATION ANY IMPLIED WARRANTIES OF MERCHANTABILITY, FITNESS FOR A PARTICULAR PURPOSE OR NON-INFRINGEMENT OF THIRD PARTY INTELLECTUAL PROPERTY RIGHTS.

These resources are intended for skilled developers designing with TI products. You are solely responsible for (1) selecting the appropriate TI products for your application, (2) designing, validating and testing your application, and (3) ensuring your application meets applicable standards, and any other safety, security, regulatory or other requirements.

These resources are subject to change without notice. TI grants you permission to use these resources only for development of an application that uses the TI products described in the resource. Other reproduction and display of these resources is prohibited. No license is granted to any other TI intellectual property right or to any third party intellectual property right. TI disclaims responsibility for, and you will fully indemnify TI and its representatives against, any claims, damages, costs, losses, and liabilities arising out of your use of these resources.

TI's products are provided subject to [TI's Terms of Sale](#) or other applicable terms available either on [ti.com](https://www.ti.com) or provided in conjunction with such TI products. TI's provision of these resources does not expand or otherwise alter TI's applicable warranties or warranty disclaimers for TI products.

TI objects to and rejects any additional or different terms you may have proposed.

Mailing Address: Texas Instruments, Post Office Box 655303, Dallas, Texas 75265
Copyright © 2024, Texas Instruments Incorporated