

Reference Board User's Guide

**ADC08(B)3000RB: 8-Bit, 3.0 GSPS, A/D Converter with
Xilinx Virtex 4 (XC4VLX15) FPGA**

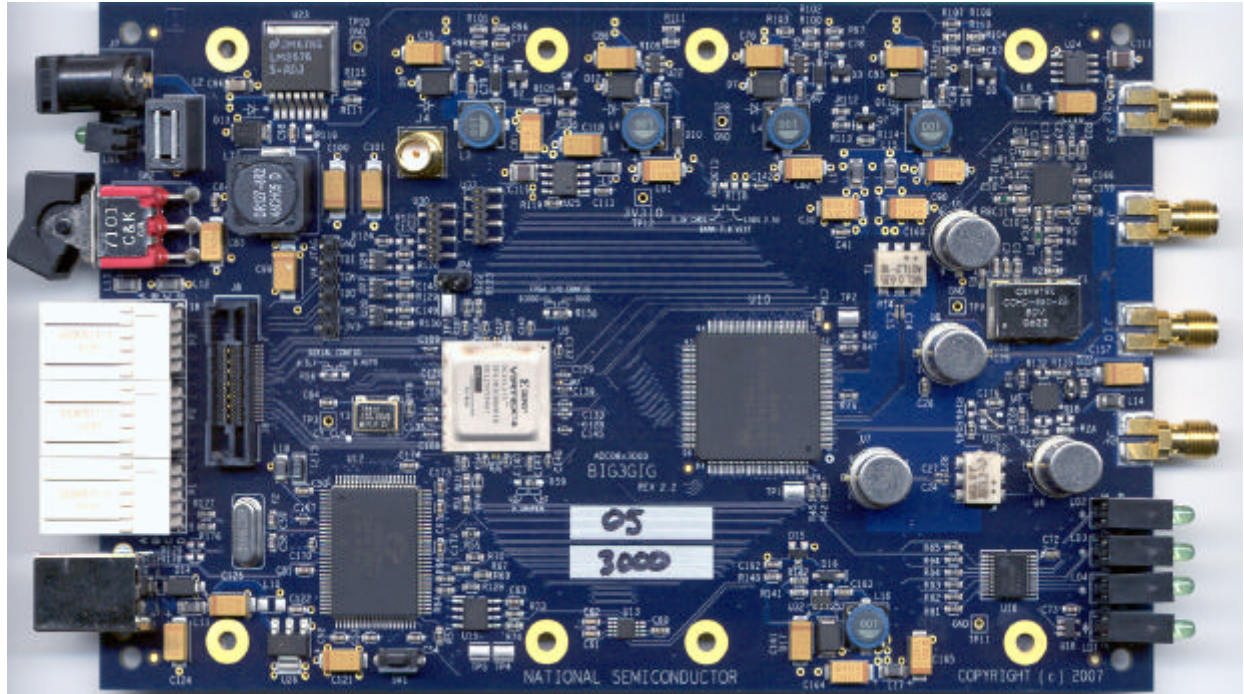

ADC08(B)3000RB REFERENCE BOARD USER'S GUIDE – TABLE OF CONTENTS

1.0 Introduction.....	3
2.0 Board Assembly.....	3
3.0 Quick Start.....	3
4.0 Board Specifications.....	4
4.1 FPGA Specification.....	4
4.2 Microcontroller.....	4
4.3 Memory Components.....	4
4.4 Power Supplies.....	5
4.5 Clocking.....	5
4.6 Resets.....	5
4.7 Thermal Management.....	5
4.8 ADC Analog Input.....	5
4.9 Status Indicators.....	5
4.10 Debug.....	6
5.0 Functional Description.....	6
5.1 Input circuitry.....	6
5.2 ADC reference.....	6
5.3 ADC clock.....	6
5.4 Digital Data Output.....	6
5.5 Power Requirements.....	6
5.6 Power Supply Connections.....	6
6.0 Obtaining Best Results.....	7
6.1 Clock Jitter.....	7
7.0 Using the WaveVision software with the ADC08(B)3000.....	7
7.1 Getting Started.....	7
7.2 Control Panel.....	8
7.3 Serial Control Mode.....	9
7.4 Manually downloading the FPGA firmware.....	9
7.5 Capturing Waveforms.....	10
Appendix A - Hardware Information.....	10
A.1 Xilinx Virtex 4 FPGA.....	10
A.2 LED functions.....	10
A.3 Expansion Header.....	11
A.4 System Block Diagram.....	12
Appendix B - Installing and running the WaveVision4 software.....	13
B.1 Installing the WaveVision Software.....	13
B.2 Java™ Technology.....	13
B.3 Automatic Device Detection and Configuration.....	13
B.4 Windows Driver.....	13
Appendix C - Using WaveVision Plots.....	14
C.1 The Waveform Plot.....	14
C.2 The FFT Plot.....	14
C.3 FFT Options.....	15
C.4 Histogram Plots.....	15
C.5 Information Viewer.....	16
C.6 Data Import and Export.....	16

1.0 Introduction

The ADC08(B)3000RB Board is designed to allow quick evaluation and design development of National Semiconductor's ADC083000 and ADC08B3000 8-bit Analog-to-Digital Converters. These devices are specified for 3.0 GSPS operation. This reference board is designed to function with National Semiconductor's WaveVision Software, for fast evaluation. It requires only 3 connections to get started: a power supply, a USB Interface to PC and an analog signal source. A 1.5 GHz clock generator is provided on-board and the system also allows for an external clock to be used if alternate sample rates are required.

The ADC connects to a Xilinx Virtex4 FPGA which stores up to 4K of data from each channel before transferring it through the USB interface to the PC.

2.0 Board Assembly

The ADC08(B)3000RB Evaluation Board comes as a plain board with rubber standoffs and requires no assisted cooling due to its low power consumption. The ADC083000 and ADC08B3000 devices are configured entirely through software and also allow for changes to easily be made to the FPGA configuration to enable system development.

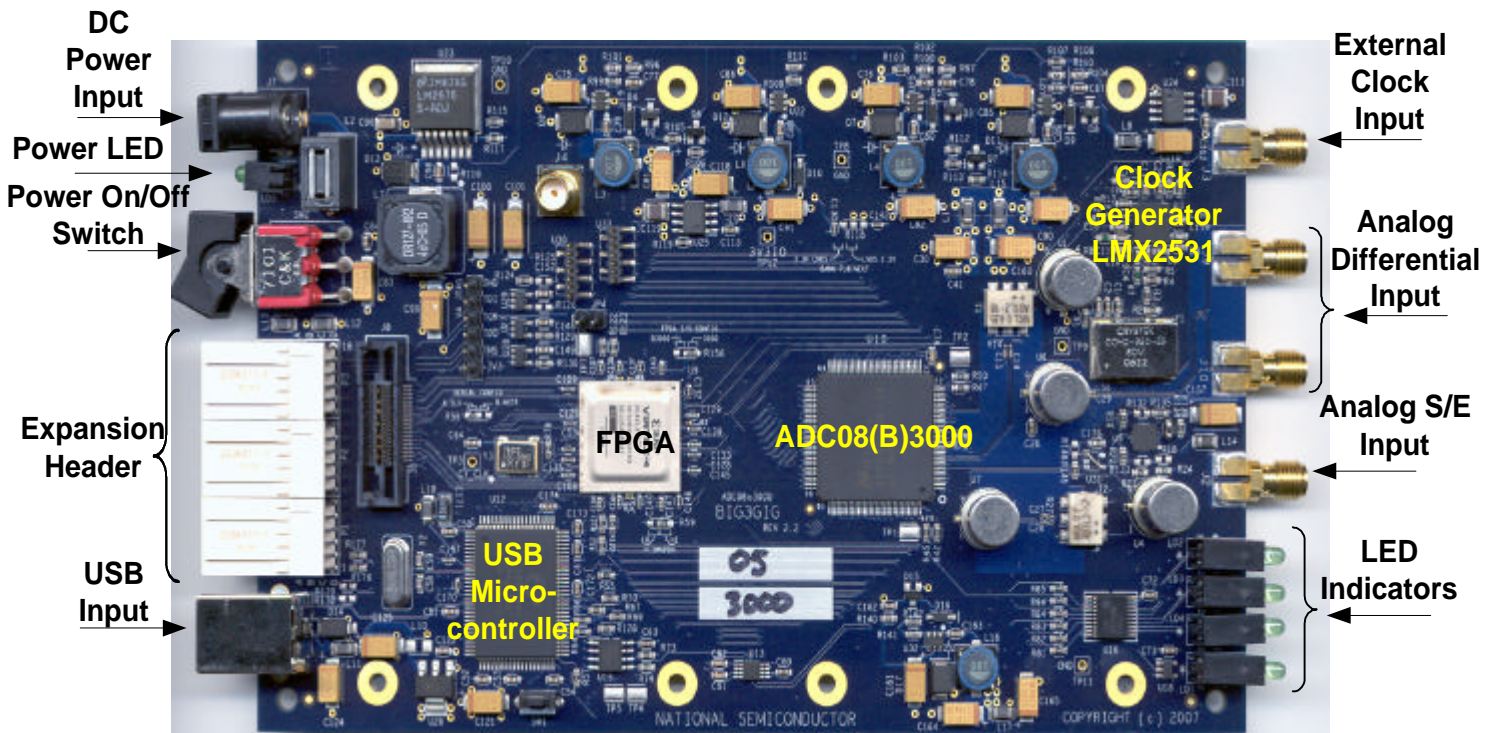

Figure 1. Input/Output Connection and Board Overview

3.0 Quick Start

Refer to Figure 1 for locations of the power connection, signal input and USB port.

NOTE: Install the WaveVision 4.3.01.5 Beta ADC08x3000 Software before connecting this product to the PC. See Appendix B – Installing WaveVision.

NOTE: If other versions of WaveVision software have previously been installed on the PC, they must be uninstalled prior to installing this version and the “National Semiconductor” folder in the C:\Program Files\ directory must be deleted. Never install more than one version of WaveVision onto a PC at a time.

For quick start operation:

1. Install WaveVision software. See Appendix B – Installing WaveVision.
2. Connect the 12V DC power source (included with the reference board) to the power input (8-12V DC).
3. Push the Power Switch to the ON position and check that the Green LED between the switch and the power connector illuminates.
4. Connect the USB cable (included) from the USB port to a PC. If this is the first time the board has been connected, Windows may install the drivers for this product at this time.
5. Obtain a stable analog source capable of supplying the desired frequencies at up to 8 dBm. Using a band-pass filter for AC-coupled signals or a low-pass filter for DC-coupled signals, connect this source signal to either the single-ended input (J2) or the differential inputs (J9 and J10). The exact level required from the generator will depend upon the insertion loss of the filter used.
6. Start the WaveVision software.
7. Once started, the “Firmware Download” progress bar should be displayed. See Appendix B for more information.
8. Upon Firmware Download completion, the control panel for the board should automatically be displayed on the PC and the CLK LED on the front panel should be on and blinking at a 50% duty cycle indicating that it is functioning. Refer to Appendix A for LED identification.
9. **For the ADC083000:** Set the signal source for the analog input to 8 dBm at the desired frequency. Observe that the Out of Range, (OVR) LED is illuminated. If this LED is not on, increase the input signal source until it is. Now, reduce the signal source level until the

OVR LED just turns off. This will result in a full-scale signal.

10. From the WaveVision window pull-down menu select **Acquire** and then **Samples**. The system will then capture the input waveform and display the results in the time domain.

11. For FFT Analysis, click the **FFT** Tab.

4.0 Board Specifications

The following shows the board specifications for the ADC08(B)3000, Table 1.

Board Size:	168mm x 100mm
Power Requirements:	+8 to +12V, 800mA
Clock Frequency Range :	800 MHz to 1.5 GHz
Analog Input Range (AC-Coupled)	100MHz to 1800MHz
Nominal Analog Input Voltage (Differential, AC-coupled):	600 mV P-P to 800 mV P-P
Impedance:	50 Ohms

Table 1. Reference Board Specifications

4.1 FPGA Specification

The board supports a Xilinx LX15 Virtex 4 363-pin FPGA. This device is responsible for collecting and storing the data from ADC, measuring the clock frequency, and uploading the data through the microcontroller to the PC.

Normally, the FPGA is configured automatically by the WaveVision software. It is possible, through modification of the board, to configure the FPGA using a FLASH ROM, so that the system may be run without the USB microcontroller.

NOTE: Although the reference board provides a powerful capability for the user to develop his own FPGA code, National does not support such custom FPGA code development.

4.2 Microcontroller

A Cypress CY7C68013A microcontroller manages the USB interface and general control of the board hardware. It uses a 24 MHz crystal oscillator.

4.3 Memory Components

One 2K EEPROM (24C02 or similar) is connected to the I²C Bus for Microcontroller and USB configuration data. This EEPROM also identifies the ADC and clock source.

4.4 Power Supplies

Power to the board is supplied through a single-pin power jack to allow the use of an external brick power supply with a voltage range of 8V to 12V.

The following supplies are provided by on-board regulators (Switching and Linear):

- 3.3V - USB Microcontroller
- 3.3V – FPGA (LVCMOS I/O)
- 2.5V - FPGA (AUX and LVDS25 I/O)
- 1.9V - ADC (V_A and V_{DR})
- 1.2V – FPGA (CORE)

A power LED indicator is provided on the front edge of the board along with the status LEDs.

A Rocker Switch is provided on the rear edge of the board to allow easy cold start/re-start.

The USB Microcontroller controls the shutdown pins of all the switching regulators to minimize power in standby mode.

4.5 Clocking

The USB Microcontroller is clocked by its own 24 MHz crystal oscillator. The ADC is clocked by either a National Semiconductor PLL and a VCO device, or by an external clock source. Switching between clock sources is done through a relay controlled by the WaveVision software.

The PLL and VCO devices are selected to provide a 1500 MHz very low jitter, on-board clock. The on-board PLL is programmed over a serial interface through the FPGA.

The FPGA utilizes two different clock sources:

1. For capturing data from the ADC, the FPGA uses the source synchronous ADC data clock (ADC083000), which will operate at a rate of either $F_s/2$ (Single Data Rate) or $F_s/4$ (Dual Data Rate) or it uses the supplied read clock (ADC08B3000).
2. For all other functions such as calculating the input clock frequency, and uploading the captured data to the USB Microcontroller, an on-board crystal oscillator running at 100 MHz is used.

4.6 Resets

The USB Microcontroller utilizes a simple RC power-on-reset circuit along with local push-button reset. The FPGA has a RESET input

signal which is controlled by the USB Microcontroller.

4.7 Thermal Management

A National Semiconductor LM95221 Dual Temperature Sensor device monitors the die temperature of the ADC and the Virtex 4 FPGA via their temperature diodes. This temp sensor interfaces to the USB Microcontroller over a 2 wire serial bus. The ADC's temperature is monitored to determine when calibration cycles are required. The user may also initiate a calibration cycle using the WaveVision software.

4.8 ADC Analog Input

The analog input is provided through SMA connectors on the front edge of the board. It may be either single-ended (J2) or differential (J9 and J10) and AC- or DC-coupled. (However, the differential input may be AC-coupled only.) These options are selected via the WaveVision software and controlled by Teledyne RF relays on-board.

In the case of a single-ended input, single-ended-to-differential signal conversion is performed by a Mini-Circuits Balun (ADTL2-18) for the AC-coupled path. A differential input signal is provided directly to the ADC via coupling capacitors.

For a single-ended input, a LMH6555 differential op-amp is used to DC-couple the input signal (if DC-coupling is selected).

4.9 Status Indicators

This is a brief summary of the name, abbreviation and description of the status LEDs:

Name	Abbr.	Description
Standby	STB	All switching regulators powered down
Trigger	TRG	Trigger input indicator
Over-range	OVR	Over-range indicator
Clock	CLK	Clock active indicator (blinks)
Power-on	PWR	12V-30V power
Upload	UPL	Data is being uploaded to PC
Sample	SMP	Data is being captured by FPGA
FPGA RDY/IDLE	IDL	FPGA is programmed and IDLE

Table 2. Status Indicators

The Following Status Indicators (LEDs) are provided on the front edge of the board, Figure 2:

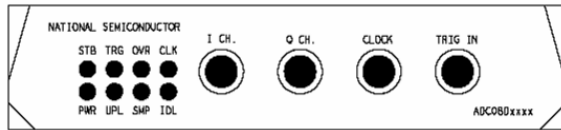

Figure 2. Component placement and front panel

4.10 Debug

A Mictor Logic Analyzer Header is provided along with test-point headers both of which are connected to the FPGA. This allows monitoring of captured data and critical signals during board debug. A JTAG header is also provided to allow further FPGA development.

5.0 Functional Description

5.1 Input circuitry

The analog input signal to be digitized should be applied to the “Analog Single-Ended Input” or the “Analog Differential Input” SMA connectors. These inputs accept low-noise analog signals. To accurately evaluate the dynamic performance of this converter, the input analog signals must be filtered by a high-quality bandpass or lowpass filter (depending upon whether the signal is AC- or DC- coupled) with at least 10-bit equivalent noise and distortion characteristics.

This reference board is capable of handling either a single-ended or a differential analog input. The single-ended input is converted to differential signals on-board via a balun and provides the single-ended-to-differential conversion for the ADC. The differential PCB traces to the ADC input pins have a characteristic differential impedance of 100 Ohms.

When the DC-coupled input path is selected, a 50Ω DC impedance to ground must exist at the input (signal generator must be DC-coupled and only a lowpass filter should be used). Should an AC-coupled signal generator or a bandpass filter be required, the AC-coupled input path should be used. However, should the customer desire to use an AC-coupled source or a bandpass filter with the DC-input path selected, a 49.9Ω resistor should be populated to the device location R24 to ensure the 50Ω DC impedance requirement for the amplifier is met.

No scope or other test equipment should be connected anywhere in the signal path while gathering data.

5.2 ADC reference

The ADC083000 and ADC08B3000 have an internal reference which cannot be adjusted. However, the Full-Scale (differential) Range may be adjusted with the Software Control Panel. Refer to Section 7.0 for more information.

5.3 ADC clock

NOTE: When using the internal clock, be sure to physically isolate the external clock signal (either gate the signal generator off or remove the external clock cable).

The ADC clock is supplied on-board and is a fixed frequency of 1.5 GHz. An external clock signal may be applied to the ADC through the SMA Connector labeled in Figure 1 as “External Clock Input”. The balun-transformer (T1) converts the single-ended clock source to a differential signal to drive the ADC clock pins.

The ADC clock should be as low-jitter as possible or the apparent SNR of the ADC device will be compromised.

When switching from an external reference clock to the internal reference clock, or vice-versa, be sure to press the **Test Communication** button in the **Capture Settings** window. This will reload the firmware with the appropriate settings.

5.4 Digital Data Output

The digital output data from the ADC is connected to a Xilinx Virtex 4 FPGA. Up to 4K bytes of data per channel can be stored and subsequently uploaded over the USB interface to the WaveVision software. The FPGA logic usage is low, allowing for further code to be written and tested for product development.

5.5 Power Requirements

The power supply requirement for the ADC08(B)3000RB Reference Board is 12V at 800mA.

Most of the on-board regulators are switching regulators for increased power efficiency.

The board typically draws around 500 mA, but it is good practice to have extra power reserve in the power supply above the typical power requirements.

A Universal 100-240V AC input to 12V DC Brick Power Supply is included with the reference board.

5.6 Power Supply Connections

Power to this board is supplied through the power connector. It is advised that only the supplied PSU is used with this board.

The ADC supply voltage has been set to 1.9V, ± 50 mV using on-board regulators.

6.0 Obtaining Best Results

Obtaining the best results with any ADC requires both good circuit techniques and a good PC board layout. For layout information for this product, please contact your nearest National Semiconductor representative.

6.1 Clock Jitter

When any circuitry is added after a signal source, some jitter is almost always added to that signal. Jitter in a clock signal, depending upon how bad it is, can degrade dynamic performance. The effects of jitter may be seen in the frequency domain (FFT) as "leakage" or "spreading" around the input frequency, as seen in Figure 3. Compare this with the more desirable plot of Figure 4. Note that all dynamic performance parameters (shown to the right of the FFT) are improved by eliminating clock jitter.

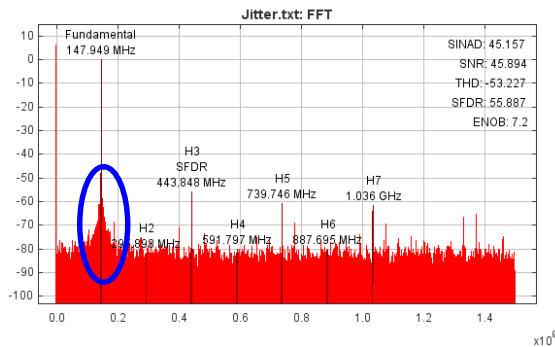

Figure 3. Jitter causes a spreading around the input signal, as well as undesirable signal spurs.

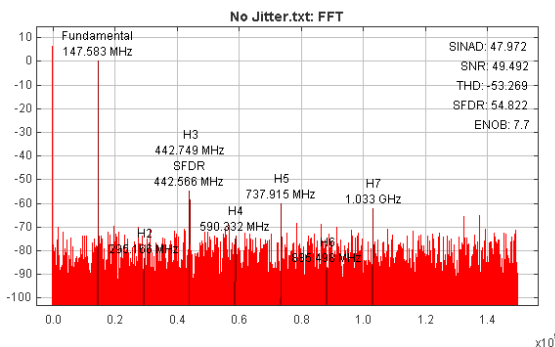

Figure 4. Eliminating or minimizing clock jitter results in a more desirable FFT that is more representative of how the ADC actually performs.

7.0 Using the WaveVision software with the ADC08(B)3000

7.1 Getting Started

This reference board is designed to connect to a PC running the WaveVision Software via a USB interface.

Ensure the board is connected to the 12V power supply (included with the package) and that the switch on the rear panel is pushed to the "ON" position. The Green LED on the rear panel should be illuminated.

Connect the USB cable between the PC which has WaveVision software installed and the ADC08(B)3000RB board. The USB port may be found on the rear panel (Figure 5).

If this is the first time the board has been connected to the PC, drivers may be required to be installed (automatic) by the Operating System. Follow the on-screen instructions and use the recommended settings.



Figure 5. ADC08(B)3000RB rear panel showing location of USB connector

Start the WaveVision software. (Start -> All Programs -> WaveVision -> WaveVision4)

The software may take several seconds to initialize, but should display a welcome screen similar to the Figure 6.



Figure 6. WaveVision welcome screen

If the board is connected correctly, the following popup box should appear (Figure 7) to indicate that the board has been recognized and the firmware for the FPGA is being downloaded over the USB interface.



Figure 7. Firmware downloading popup box

If the “Downloading firmware” box does not appear automatically, click on the “Settings” pull-down menu and then click Capture Settings (Figure 8).

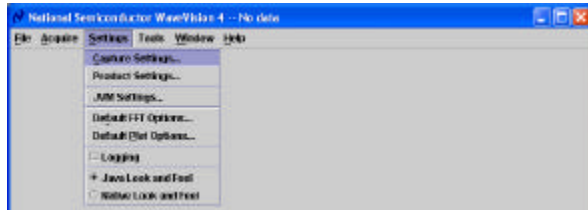

Figure 8. Capture Settings location

This will display the **System Settings** (Figure 9).

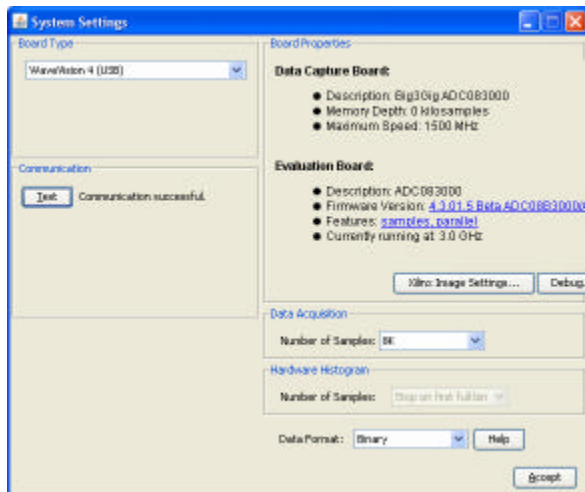

Figure 9. System Settings window

If the board has not been detected, click the **Test** button under the Communication heading. This forces the software to download the software to the FPGA. If the communications fail, check that the USB drivers are installed correctly. Then, disconnect and re-connect the USB cable. Finally, restart the WaveVision software. See Appendix B for more information.

7.2 Control Panel

Once the FPGA Firmware download is complete, the reference board Control Panel will automatically be displayed (Figure 10).

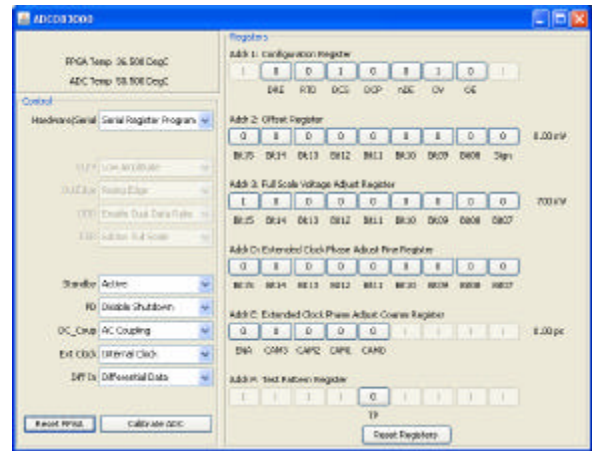

Figure 10. Control Panel window

The following section describes the function of the pull-down selection tabs in the left-hand side of the ADC08(B)3000RB product Control Panel. Note that some functions are device dependent. Refer to the device datasheet for available features.

- **Temp Sensor**
 - This displays the die temperature of both the FPGA and the ADC.
- **Hardware/Serial Control**
 - **Hardware Pin Control** – The ADC is controlled by the logic states on the dedicated control pins. The logic on these pins is determined by the setting of **OUTV**, **OUTEDGE**, **DDR**, and **FSR**, as described below.
 - **Serial Register Program** – The ADC’s registers are accessed through the Extended Control Mode. In this mode, the hardware pin control is disabled and the programmable registers are available for fine tuning.

NOTE: The Following Pull-down Tabs are available only when Hardware Pin Control is selected.

- **Out V**
 - **Low Amplitude** – LVDS output voltage amplitude is set to 520 mVpk-pk.
 - **High Amplitude** – LVDS output voltage amplitude is set to 680 mVpk-pk.
- **OutEdge** (SDR mode only, i.e. DDR disabled)
 - **Falling Edge** – Data outputs are changed on the falling edge of DCLK+.
 - **Rising Edge** – Data outputs are changed on the rising edge of DCLK+.

- **DDR**
 - **Disable Dual Data Rate** – DDR Mode is disabled (data output transitions determined by OutEdge Setting).
 - **Enable Dual Data Rate** – Data transitions occur on both rising and falling edge of DCLK+. (This is the default mode for 1.5 GHz clock).
- **FSR**
 - **600mV Full Scale** – Sets the full-scale range to 600 mVpk-pk.
 - **800mV Full Scale** – Sets the full-scale range to 800 mVpk-pk.

NOTE: The Following Pull-down Tabs are available regardless of Hardware/Serial Control setting.

- **Standby**
 - **Active** – Enable all on-board power regulators.
 - **Standby** – Board is put into standby mode; all power is shutdown except USB power.
- **PD**
 - **Disable Shutdown** – The ADC is powered up and active.
 - **Enable Shutdown** – The ADC is put into low power mode. Register Settings are retained.
- **DC_Coup**
 - **AC Coupling** – The analog input channel is AC-coupled to the ADC's input.
 - **DC Coupling** – The analog input channel is DC-coupled to the ADC's input.
- **Ext Clock**
 - **Internal Clock** – The ADC is clocked using the on-board clock.
 - **External Clock** – The ADC is clocked from an external clock source which is connected to the "CLOCK" input.
- **Reset FPGA**
 - This button resets the FPGA, and also returns all the pull-down tabs to their default values.
- **Calibrate ADC**
 - This button issues an on-command calibration to the ADC by toggling the ADC's calibrate pin.

7.3 Serial Control Mode

When the Hardware/Serial Control tab is selected as **Serial Register Program**, the control panel display will enable the other bits (Figure 11).

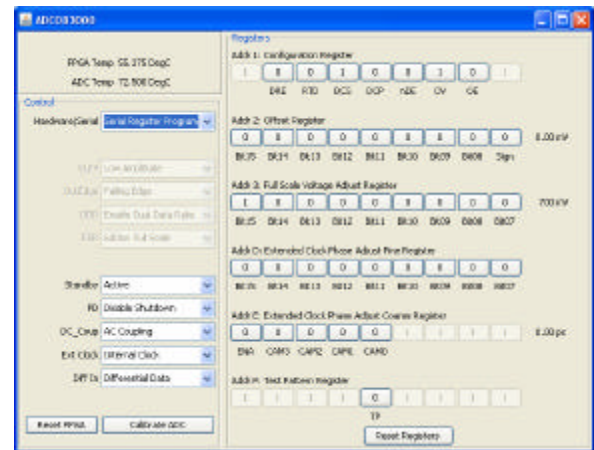

Figure 11. Serial Register Program window

In this mode, the register settings may be changed simply by clicking on the bits. Doing so will toggle each bit value. Any linear values such as **Full Scale Range** or **Offset** will automatically be updated.

The **Reset Registers** button at the bottom of the Control Panel will reset and write all the values to the power-on default settings.

NOTE: Please refer to the ADC08(B)3000 datasheet for a full description of the ADC's internal registers.

7.4 Manually downloading the FPGA firmware

Although the WaveVision software is designed to automatically recognize the reference board and download the appropriate FPGA code into it, it is possible for the user to download a different FPGA code (the .bit file) into the board. To download another FPGA code into the board, follow these instructions:

1. Place the desired .bit file (Xilinx object code that is known to operate correctly for the reference board you are using) in a known directory of your choice on the C: drive.
2. Start WaveVision with the board connected via the USB.
3. The default FPGA will load automatically – this will be overwritten.
4. From the main WaveVision panel, under the **Settings** drop down menu, select **Capture Settings**. This will bring up another panel called **System Settings**.

5. Click the **Xilinx Image Settings** button within the **System Settings** panel. This will bring up another panel labeled **Select Xilinx Firmware**.
6. Deselect the **Select Images automatically** button.
7. Then click the **Browse** button and select the location of the bit file.
8. Click the **Accept** button. The **Select Xilinx Firmware** panel will disappear.
9. Load the FPGA image by clicking on the **Reset** (or **Test** in some versions) button. It may be found in the **Communication** sub-panel of the **System Settings** panel.
10. FPGA bit file download may be confirmed by observing the progress bar pop-up. If the progress bar goes half-way and suddenly terminates, the FPGA has not loaded. The second half should progress at a similar rate.

Please note that the reference board's operation is only assured for the FPGA code provided by National. Though the board makes it possible for the user to develop and test his own FPGA code, such operation is not supported by National.

Appendix A - Hardware Information

A.1 Xilinx Virtex 4 FPGA

The ADC08(B)3000RB reference board implements the Xilinx Virtex 4 XC4VLX15-10SF363C FPGA for ADC control and data capture. The FPGA firmware is loaded over the USB port when the WaveVision software is started. The FPGA Verilog code and supplemental documentation is available to users upon request. Please contact your local National Semiconductor Sales or Field Applications Representative.

A.2 LED functions

The function of the LEDs on the front panel of the board (Figure 13) is as follows:

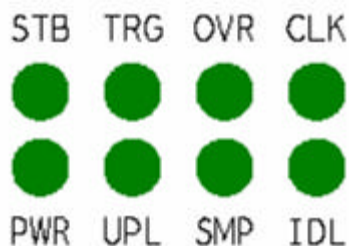

Figure 13. LED front panel

7.5 Capturing Waveforms

When the ADC has been properly configured, the selected input(s) may be sampled by clicking the **Acquire** pull-down menu and selecting **Samples**. Alternately, press **F1** then the **Escape** key. See Figure 12 for a sample waveform.

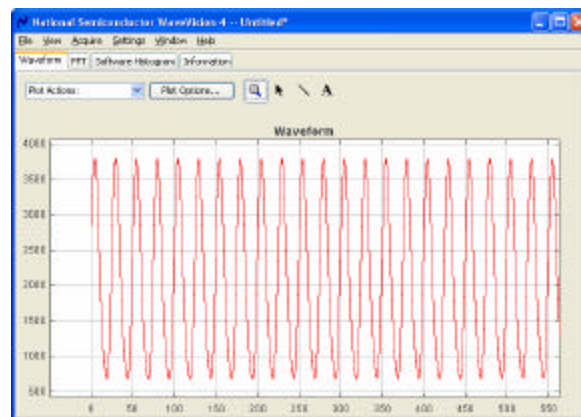

Figure 12. Waveform capture example

- **STB (STANDBY)** - illuminates when the board is in standby mode.
- **TRG (TRIGGER EVENT)** - illuminates when the Trigger Input makes low to high transition.
- **OVR (ADC OVER-RANGE)** - illuminates when the analog input channel exceeds the full-scale range of the ADC.
- **CLK (CLOCK INPUT)** - flashes with 50% duty cycle if the ADC is receiving a clock input.
- **PWR (POWER)** - illuminates when the external 12V power supply is connected and the system is not in Standby.
- **UPL (UPLOAD)** - illuminates when the FPGA is uploading sample data to the PC.
- **SMP (SAMPLE)** - illuminates when the FPGA is sampling data and storing to the FIFO buffers.
- **IDL (IDLE)** - illuminates when the system is IDLE.

A.3 Expansion Header

A 72-pin Future Bus Expansion Header (Table 3) is provided on the rear panel to allow easy connection to a third-party microprocessor board to allow for the reading and analysis of the data captured by the FPGA.

The Data busses on this header may be configured as follows:

- Two 8-bit busses with LVDS differential signaling, plus two LVDS strobes.
- Four 8-bit busses with LVCMOS (3.3V I/O) signaling plus four CMOS strobes.

All control signals on pins A1 to A15 will be at LVCMOS 3.3V levels.

PIN	DESCRIPTION	PIN	DESCRIPTION
P1_A1	I2C – SDA	P1_B1	GROUND
P1_A2	I2C – SCL	P1_B2	GROUND
P1_A3	SSP – SERIAL DATA	P1_B3	GROUND
P1_A4	SSP – SERIAL CLOCK	P1_B4	GROUND
P1_A5	FPGA RESET	P1_B5	GROUND
P1_A6	READ FIFO	P1_B6	GROUND
P2_A1	WRITE FIFO	P2_B1	GROUND
P2_A2	FIFO FULL	P2_B2	GROUND
P2_A3	FIFO EMPTY	P2_B3	GROUND
P2_A4	ADC DCLK RESET	P2_B4	GROUND
P2_A5	FPGA CONF DONE	P2_B5	GROUND
P2_A6	FPGA JTAG – TMS	P2_B6	GROUND
P3_A1	FPGA JTAG – TCK	P3_B1	GROUND
P3_A2	FPGA JTAG – TDI	P3_B2	GROUND
P3_A3	FPGA JTAG – TDO	P3_B3	GROUND
P3_A4	Not SHUTDOWN	P3_B4	GROUND
P3_A5	3.3V SUPPLY	P3_B5	GROUND
P3_A6	12V SUPPLY	P3_B6	GROUND
P1_C1	DATA BUS A P0 (LVDS or CMOS)	P1_D1	DATA BUS A N0 (LVDS or CMOS)
P1_C2	DATA BUS A P1 (LVDS or CMOS)	P1_D2	DATA BUS A N1 (LVDS or CMOS)
P1_C3	DATA BUS A P2 (LVDS or CMOS)	P1_D3	DATA BUS A N2 (LVDS or CMOS)
P1_C4	DATA BUS A P3 (LVDS or CMOS)	P1_D4	DATA BUS A N3 (LVDS or CMOS)
P1_C5	DATA BUS A P4 (LVDS or CMOS)	P1_D5	DATA BUS A N4 (LVDS or CMOS)
P1_C6	DATA BUS A P5 (LVDS or CMOS)	P1_D6	DATA BUS A N5 (LVDS or CMOS)
P2_C1	DATA BUS A P6 (LVDS or CMOS)	P2_D1	DATA BUS A N6 (LVDS or CMOS)
P2_C2	DATA BUS A P7 (LVDS or CMOS)	P2_D2	DATA BUS A N7 (LVDS or CMOS)
P2_C3	INPUT STROBE P	P2_D3	INPUT STROBE N
P2_C4	DATA BUS B P0 (LVDS or CMOS)	P2_D4	DATA BUS B N0 (LVDS or CMOS)
P2_C5	DATA BUS B P1 (LVDS or CMOS)	P2_D5	DATA BUS B N1 (LVDS or CMOS)
P2_C6	DATA BUS B P2 (LVDS or CMOS)	P2_D6	DATA BUS B N2 (LVDS or CMOS)
P3_C1	DATA BUS B P3 (LVDS or CMOS)	P3_D1	DATA BUS B N3 (LVDS or CMOS)
P3_C2	DATA BUS B P4 (LVDS or CMOS)	P3_D2	DATA BUS B N4 (LVDS or CMOS)
P3_C3	DATA BUS B P5 (LVDS or CMOS)	P3_D3	DATA BUS B N5 (LVDS or CMOS)
P3_C4	DATA BUS B P6 (LVDS or CMOS)	P3_D4	DATA BUS B N6 (LVDS or CMOS)
P3_C5	DATA BUS B P7 (LVDS or CMOS)	P3_D5	DATA BUS B N7 (LVDS or CMOS)
P3_C6	OUTPUT STROBE P	P3_D6	OUTPUT STROBE N

Table 3. Future bus expansion header pins

A.4 System Block Diagram

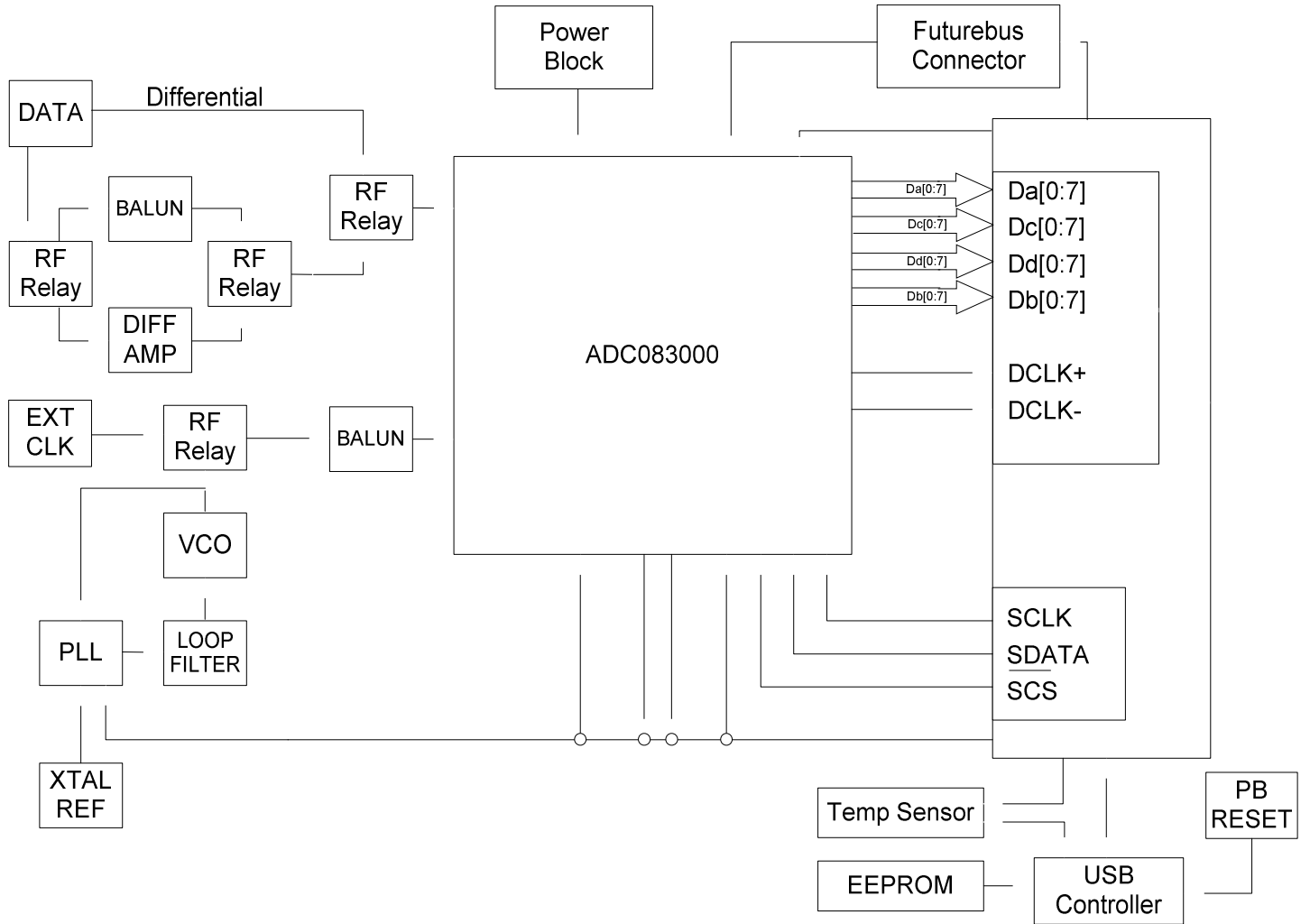

Appendix B - Installing and running the WaveVision4 software

B.1 Installing the WaveVision Software

1. Insert the WaveVision CD-ROM into the computer's CD-ROM drive.
2. The WaveVision software requires a Java™ Runtime Environment or Java™ Development Kit, Version 1.4 or higher, from Sun Microsystems, Inc. For detailed information on WaveVision's use of Java technology, see Section 10.2. If the computer does not have this software, the WaveVision installer will instruct you on how to install it.
3. Locate and run the **WaveVision4 Setup.exe** program on the CD-ROM.
4. Follow the on-screen instructions to finish the install.

B.2 Java™ Technology

The WaveVision software uses Sun Microsystems® Java technology. The underlying Java software must be installed on the computer in order for the WaveVision software to run. The software can run on top of either the Java Runtime Environment (JRE) or the Java Development Kit (JDK), Version 1.4 or higher. A suitable copy of the JRE is included on the WaveVision CD-ROM.

The WaveVision installer will first search for an existing copy of the JRE or JDK on the computer. If neither is found, the installer will prompt you to first install a JRE. To do this, run the **J2RE*.exe** installer program which may be found on the CD-ROM. Follow the on-screen instructions to finish the install.

After a suitable JRE or JDK is installed, run the WaveVision installer again. The installer will detect the Java software and configure the WaveVision software to use it.

Java technology can allow software to run on different platforms. However, the WaveVision software contains Windows-specific hardware interface code and is therefore only supported under Windows.

B.3 Automatic Device Detection and Configuration

The WaveVision system provides automatic hardware detection and configuration for the device under test. The FPGA is re-programmed automatically by the host PC when the reference board is turned on.

Normally, the configuration process is completely transparent to the user and requires no intervention. However, this process can be overridden, if required, by specifying a new Xilinx configuration image. To do this, select the **Xilinx Image Settings** button (Figure 14) within the Capture Setting window (**Settings ? Capture Settings**).

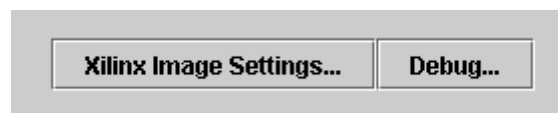

Figure 14. Selecting Xilinx image settings

B.4 Windows Driver

The WaveVision software communicates with the WaveVision hardware through the Windows device driver software. If you are unable to connect to the WaveVision board after installing the software, do the following to uninstall and reinstall the driver:

1. Find the Windows **Control Panel** and select **System**. If you are using Windows 2000/XP, select the **Hardware** tab.
2. Click on **Device Manager** and scroll down to the **Universal Serial Bus controllers**.
3. With the WaveVision board connected, an unknown device will be listed.
4. Right click on the unknown device and uninstall the driver.
5. Unplug the USB cable from the board.
6. Plug in USB cable to the board again to reinstall the driver.

Appendix C - Using WaveVision Plots

The WaveVision software provides several tools to manipulate the plot view. A toolbar appears above each plot, similar to Figure 15.

Seen from left to right, the following tools are available:

- **Plot Actions:** This menu contains commands that pertain to this particular plot. You may export the plot data to a file, print it, save it as a graphic, or change the plot's colors.
- **Plot Options:** This button opens a dialog box with options that pertain to this particular plot. You may turn off labels, annotations, or other elements in this dialog. The WaveVision software maintains default options for new plots. You may edit the default options by choosing **Default Plot Options** from the **Settings** menu.
- **FFT Options:** The toolbar shown in Figure 15 is from an FFT plot, and thus contains a button to edit the options for the FFT calculation. Depending upon the type of plot, various options will be present on the toolbar. Please consult the appropriate section below for more information about these options.
- **Magnifying glass tool:** This tool allows you to zoom in and out to see fine details in the plot. Click and drag a box from upper-left to lower-right to zoom in on the region of interest. Click and drag a box from lower-right to upper-left to zoom out. **With the magnifying glass tool selected, click the right mouse button to return to a full view.**
- **Arrow Tool:** The arrow tool is used to select, move, and edit annotations. To edit an annotation, double click it with the arrow tool. To delete an annotation, select it with the arrow tool and press the **Delete** key on your keyboard.
- **Line Annotation Tool:** To draw lines on the plot, select this tool. Drag to draw new lines. To add arrowheads or fix the endpoints of the line, double-click the appropriate end with the arrow tool.
- **Text Annotation Tool:** To draw labels on the plot, select this tool and click at the desired location in the plot. To edit the justification, location, or text of an annotation, double-click it with the arrow tool.



Figure 15. WaveVision plot tools

C.1 The Waveform Plot

The Waveform plot displays the raw samples collected from the hardware. This plot is primarily used to verify the integrity of collected data. The waveform is the best view in which to diagnose a distorted signal, an irregular clock, a low-amplitude signal, and many other common ADC system problems.

The Waveform plot also quickly shows how much of the ADC's dynamic range the analog input signal occupies.

C.2 The FFT Plot

The WaveVision software automatically computes a Fast Fourier Transform (FFT) of the sample set, and displays the results in an FFT plot. The resulting FFT plot is, in many respects,

the heart of the software because it shows the frequency content of the analog input signal. It marks the fundamental frequency, and a selectable number of harmonics. It also labels their order and frequencies. It shows the power in the fundamental and harmonics. Place the mouse cursor over a harmonic to display information about it.

The FFT may be used to diagnose common ADC problems such as input spectral impurity, clock phase noise, and clock jitter. The FFT plot also shows several statistics on the quality and purity of the collected samples including SNR, SINAD, THD, SFDR, and ENOB. These statistics are to be interpreted with the following definitions (which are repeated in every National Semiconductor ADC datasheet):

- **Signal to Noise Plus Distortion (S/N+D or SINAD)** Is the ratio, expressed in dB, of the RMS value of the input signal to the RMS value of all of the other spectral components below half the clock frequency, including harmonics but excluding DC.
- **Signal to Noise Ratio (SNR)** is the ratio, expressed in dB, of the RMS value of the input signal to the RMS value of the sum of all other spectral components below one-half the sampling frequency, not including harmonics or DC.
- **Total Harmonic Distortion (THD)** is the ratio, expressed in dBc, of the RMS total of the first five harmonic levels at the output to the level of the fundamental at the output. THD is calculated as

$$\text{THD} = 20 \log \sqrt{\frac{f_2^2 + \dots + f_N^2}{f_1^2}}$$

where f_1 is the RMS power of the fundamental (output) frequency and f_2 through f_N are the RMS power in the first N harmonic frequencies.

- **Spurious-Free Dynamic Range (SFDR)** is the difference, expressed in dB, between the RMS values of the input signal and the peak spurious signal, where a spurious signal is any signal present in the output spectrum that is not present at the input.
- **Effective Number of Bits (ENOB, or Effective Bits)** is another method of specifying Signal-to-Noise and Distortion or SINAD. ENOB is defined as

$$\text{ENOB} = \frac{\text{SINAD} - 1.76}{6.02}$$

and says that the converter is equivalent to a perfect ADC of this (ENOB) number of bits.

C.3 FFT Options

FFT plots can be configured in many different ways. Clicking the **FFT Options** button at the top of the plot will display a dialog showing the options for that particular plot. The software also maintains default options for new FFT plots, which are editable. The default FFT options may be edited by choosing **Default FFT Options** from the **Settings** menu. The options are:

- **Windowing:** You may choose from one of five different window functions. The window function is applied to the samples before computing the FFT to compensate for the fact that the sample set may not be an integral number of wavelengths of the input signal. In general, Flat-Top will give the best results, but it may be easier to compare data with other systems when the windowing functions are the same.
- **dB Scale:** You may select to represent power on the FFT in dBc (decibels relative to carrier), in which 0 dB is taken to be the fundamental (carrier) power, or dBFS (decibels relative to full-scale), in which 0 dB is taken to be the power contained in a signal which uses the entire dynamic range of the ADC.
- **Harmonic Calculations:** You may select the number of harmonics recognized (and labeled) by the software. You may also select the number of FFT bins excluded around harmonics in, for example, SNR calculations. The exclusion region around each harmonic will be shown in a different color than the rest of the data points.
- **IMD Calculations:** The WaveVision software is capable of performing Intermodulation Distortion calculations. When two fundamental frequencies within 3 dBFS are present in the waveform, the software will automatically perform IMD calculations. You may inhibit this behavior by deselecting the **Allow IMD calculation** checkbox. When the IMD calculation is enabled, you may also select whether the software will include only 2nd order or both 2nd and 3rd order terms.

C.4 Software Histogram

Histogram plots are created by counting the number of times each ADC output code appears in a dataset. Histograms may be computed by software, or by hardware. A software histogram is computed from a dataset which is normally 128k samples or smaller. A hardware histogram is collected directly by the hardware, and may include millions of counts per code. The resulting histogram will show discontinuities between comparators, gain or offset errors, and other common ADC system problems.

The Histogram plot also displays the number of codes that were never counted (missing codes), followed by the first ten such missing codes.

C.5 Information Viewer

The information viewer is not a plot, but it displays a variety of useful information about the dataset, such as the sampling rate, and any warnings generated by the software. You may also store comments about the dataset here, to be saved in a WaveVision file.

C.6 Data Import and Export

The WaveVision software provides a variety of means to share data with others, in both textual and graphical formats.

The most flexible way to import data into the software is from a tab-delimited ASCII text file. The contents can be either a sample set or a histogram, provided with or without time information. The simplest example of this would be a file with a single column of samples. You may open tab-delimited text files by choosing **Open** from the **File** menu; you can interleave data from multiple columns and/or files. You can choose **Reopen** to reopen the same file later with the same settings (for example, if you update the file with new data),

There are a variety of ways to export data from the software:

- Save the file as a normal WV4 (*.wv4) file. WV4 files are ASCII, tab-delimited text files. Samples are stored one per line in a single column. You can open a WV4 file directly into a spreadsheet program.
- Save the file as a TXT (*.txt) file. You will produce a one- or two-column tab-delimited ASCII text file of samples or histogram information, without the header information that is contained in a WV4 file.
- You can export the contents of an individual plot by choosing **Export Data** from the plot's **Plot Actions** menu. The format of the data is always tab-delimited ASCII text.
- You can export a plot as either a GIF (*.gif) or Encapsulated Postscript (*.eps) graphic by choosing **Export Plot as Graphic** from the plot's **Plot Actions** menu. GIF files are suitable for the web or for emails. Encapsulated Postscript files are high-resolution scalable files suitable for direct publication.

BY USING THIS PRODUCT, YOU ARE AGREEING TO BE BOUND BY THE TERMS AND CONDITIONS OF NATIONAL SEMICONDUCTOR'S END USER LICENSE AGREEMENT. DO NOT USE THIS PRODUCT UNTIL YOU HAVE READ AND AGREED TO THE TERMS AND CONDITIONS OF THAT AGREEMENT. IF YOU DO NOT AGREE WITH THEM, CONTACT THE VENDOR WITHIN TEN (10) DAYS OF RECEIPT FOR INSTRUCTIONS ON RETURN OF THE UNUSED PRODUCT FOR A REFUND OF THE PURCHASE PRICE PAID, IF ANY.

The ADC08(B)3000RB Reference Boards are intended for product evaluation purposes only and are not intended for resale to end consumers, is not authorized for such use and is not designed for compliance with European EMC Directive 89/336/EEC, or for compliance with any other electromagnetic compatibility requirements.

National Semiconductor Corporation does not assume any responsibility for use of any circuitry or software supplied or described. No circuit patent licenses are implied.

LIFE SUPPORT POLICY

NATIONAL'S PRODUCTS ARE NOT AUTHORIZED FOR USE AS CRITICAL COMPONENTS IN LIFE SUPPORT DEVICES OR SYSTEMS WITHOUT THE EXPRESS WRITTEN APPROVAL OF THE PRESIDENT OF NATIONAL SEMICONDUCTOR CORPORATION. As used herein:

1. Life support devices or systems are devices or systems which, (a) are intended for surgical implant into the body, or (b) support or sustain life, and whose failure to perform, when properly used in accordance with instructions for use provided in the labeling, can be reasonably expected to result in a significant injury to the user.
2. A critical component is any component in a life support device or system whose failure to perform can be reasonably expected to cause the failure of the life support device or system, or to affect its safety or effectiveness.

BANNED SUBSTANCE COMPLIANCE

National Semiconductor certifies that the products and packing materials meet the provisions of the Customer Products Stewardship Specification (CSP-9-111C2) and the Banned Substances and Materials of Interest Specification (CSP-9-111S2) and contain no "Banned Substances" as defined in CSP-9-111S2.

National does not assume any responsibility for any circuitry described, no circuit patent licenses are implied and National reserves the right at any time without notice to change said circuitry and specifications.



National Semiconductor Corporation
Americas Customer Support Center
Tel: 1-800-272-9959
Email: new.feedback@nsc.com

National Semiconductor Europe Customer Support Center
Fax: +49 (0) 1 80-530 85 86
Email: europe.support@nsc.com
Deutsch Tel: +49 (0) 699508 6208
English Tel: +49 (0) 870 24 0 2171
Français Tel: +49 (0) 141 91 8790

National Semiconductor Asia Pacific Customer Support Center
Email: ap.support@nsc.com

National Semiconductor Japan Customer Support Center
Tel: 81-3-5639-7560
Fax: 81-3-5639-7507
Email: jpn.feedback@nsc.com

IMPORTANT NOTICE

Texas Instruments Incorporated and its subsidiaries (TI) reserve the right to make corrections, modifications, enhancements, improvements, and other changes to its products and services at any time and to discontinue any product or service without notice. Customers should obtain the latest relevant information before placing orders and should verify that such information is current and complete. All products are sold subject to TI's terms and conditions of sale supplied at the time of order acknowledgment.

TI warrants performance of its hardware products to the specifications applicable at the time of sale in accordance with TI's standard warranty. Testing and other quality control techniques are used to the extent TI deems necessary to support this warranty. Except where mandated by government requirements, testing of all parameters of each product is not necessarily performed.

TI assumes no liability for applications assistance or customer product design. Customers are responsible for their products and applications using TI components. To minimize the risks associated with customer products and applications, customers should provide adequate design and operating safeguards.

TI does not warrant or represent that any license, either express or implied, is granted under any TI patent right, copyright, mask work right, or other TI intellectual property right relating to any combination, machine, or process in which TI products or services are used. Information published by TI regarding third-party products or services does not constitute a license from TI to use such products or services or a warranty or endorsement thereof. Use of such information may require a license from a third party under the patents or other intellectual property of the third party, or a license from TI under the patents or other intellectual property of TI.

Reproduction of TI information in TI data books or data sheets is permissible only if reproduction is without alteration and is accompanied by all associated warranties, conditions, limitations, and notices. Reproduction of this information with alteration is an unfair and deceptive business practice. TI is not responsible or liable for such altered documentation. Information of third parties may be subject to additional restrictions.

Resale of TI products or services with statements different from or beyond the parameters stated by TI for that product or service voids all express and any implied warranties for the associated TI product or service and is an unfair and deceptive business practice. TI is not responsible or liable for any such statements.

TI products are not authorized for use in safety-critical applications (such as life support) where a failure of the TI product would reasonably be expected to cause severe personal injury or death, unless officers of the parties have executed an agreement specifically governing such use. Buyers represent that they have all necessary expertise in the safety and regulatory ramifications of their applications, and acknowledge and agree that they are solely responsible for all legal, regulatory and safety-related requirements concerning their products and any use of TI products in such safety-critical applications, notwithstanding any applications-related information or support that may be provided by TI. Further, Buyers must fully indemnify TI and its representatives against any damages arising out of the use of TI products in such safety-critical applications.

TI products are neither designed nor intended for use in military/aerospace applications or environments unless the TI products are specifically designated by TI as military-grade or "enhanced plastic." Only products designated by TI as military-grade meet military specifications. Buyers acknowledge and agree that any such use of TI products which TI has not designated as military-grade is solely at the Buyer's risk, and that they are solely responsible for compliance with all legal and regulatory requirements in connection with such use.

TI products are neither designed nor intended for use in automotive applications or environments unless the specific TI products are designated by TI as compliant with ISO/TS 16949 requirements. Buyers acknowledge and agree that, if they use any non-designated products in automotive applications, TI will not be responsible for any failure to meet such requirements.

Following are URLs where you can obtain information on other Texas Instruments products and application solutions:

Products

Audio	www.ti.com/audio
Amplifiers	amplifier.ti.com
Data Converters	dataconverter.ti.com
DLP® Products	www.dlp.com
DSP	dsp.ti.com
Clocks and Timers	www.ti.com/clocks
Interface	interface.ti.com
Logic	logic.ti.com
Power Mgmt	power.ti.com
Microcontrollers	microcontroller.ti.com
RFID	www.ti-rfid.com
OMAP Mobile Processors	www.ti.com/omap
Wireless Connectivity	www.ti.com/wirelessconnectivity

Applications

Automotive and Transportation	www.ti.com/automotive
Communications and Telecom	www.ti.com/communications
Computers and Peripherals	www.ti.com/computers
Consumer Electronics	www.ti.com/consumer-apps
Energy and Lighting	www.ti.com/energy
Industrial	www.ti.com/industrial
Medical	www.ti.com/medical
Security	www.ti.com/security
Space, Avionics and Defense	www.ti.com/space-avionics-defense
Video and Imaging	www.ti.com/video

TI E2E Community Home Page

e2e.ti.com

Mailing Address: Texas Instruments, Post Office Box 655303, Dallas, Texas 75265
Copyright © 2012, Texas Instruments Incorporated