



ABSTRACT

This is the user guide for the HDC3 family, an integrated Relative Humidity (RH) and Temperature sensor that provides high accuracy with ultra-low power consumption. This family of sensors is equipped with a Drift Correction feature to further compensate and improve sensor drift due to contaminants and aging. The HDC3 family is ready to use out of the box and does not require any further calibration.

The hardware is populated with the HDC3020, an open cavity commercial version. Users can replace the HDC3020 device on this EVM with any of the devices from the HDC3020 family. It can be used to evaluate HDC3021 (removable tape) and HDC3022 (IP67 filter membrane), and their respective automotive versions because the HDC3 family are pin-to-pin and 100% software compatible.

This module and the GUI are designed to provide the user a quick setup to evaluate the device. This document includes the details of the EVM hardware and the software installation.

Table of Contents

1 Introduction	2
2 Quick Start	3
3 EVM Hardware	4
3.1 EVM Power Supply.....	4
3.2 Input/Output Connectors.....	4
3.3 Device Address Configuration.....	5
3.4 Reducing Thermal Mass.....	6
3.5 EVM Operating Conditions.....	7
4 EVM GUI	8
4.1 Live Software.....	8
4.2 Offline Version.....	8
5 GUI Operation	9
5.1 Home Tab.....	9
5.2 Data Capture Tab.....	10
5.3 EVM Settings Tab.....	13
5.4 Collateral.....	14
6 Board Layout	15
7 Schematic	16
8 HDC3020EVM Build of Materials	17
9 Revision History	18

Trademarks

All trademarks are the property of their respective owners.

1 Introduction

The Texas Instruments HDC3020 Evaluation Module (HDC3020EVM) enables designers to evaluate the operation and performance of the HDC3020 Relative Humidity and Temperature Sensor. The EVM hosts an MSP430F5528 microcontroller (MCU) as well as the HDC3020. The MCU is used to control the HDC3020 and communicate with a host PC through a USB port. The EVM is designed to be broken into two sections, if desired. The sensor section can be separated from the MCU section of the board to reduce thermal mass surrounding the HDC3020. The HDC3020EVM is configured by default to use the HDC3020 device with I²C address 0x44 (7 bit).

The EVM contains one HDC3020 (see [Table 1-1](#))

Table 1-1. Device and Package Configurations

DEVICE	IC	PACKAGE
U1	HDC3020	2.5 mm × 2.5 mm DFN

2 Quick Start

1. Click [here](#) in Safari, Firefox, or Chrome and select the HDC3020EVM GUI from the gallery to access the cloud-based GUI. Follow the onscreen instruction to complete TI Cloud Agent setup.

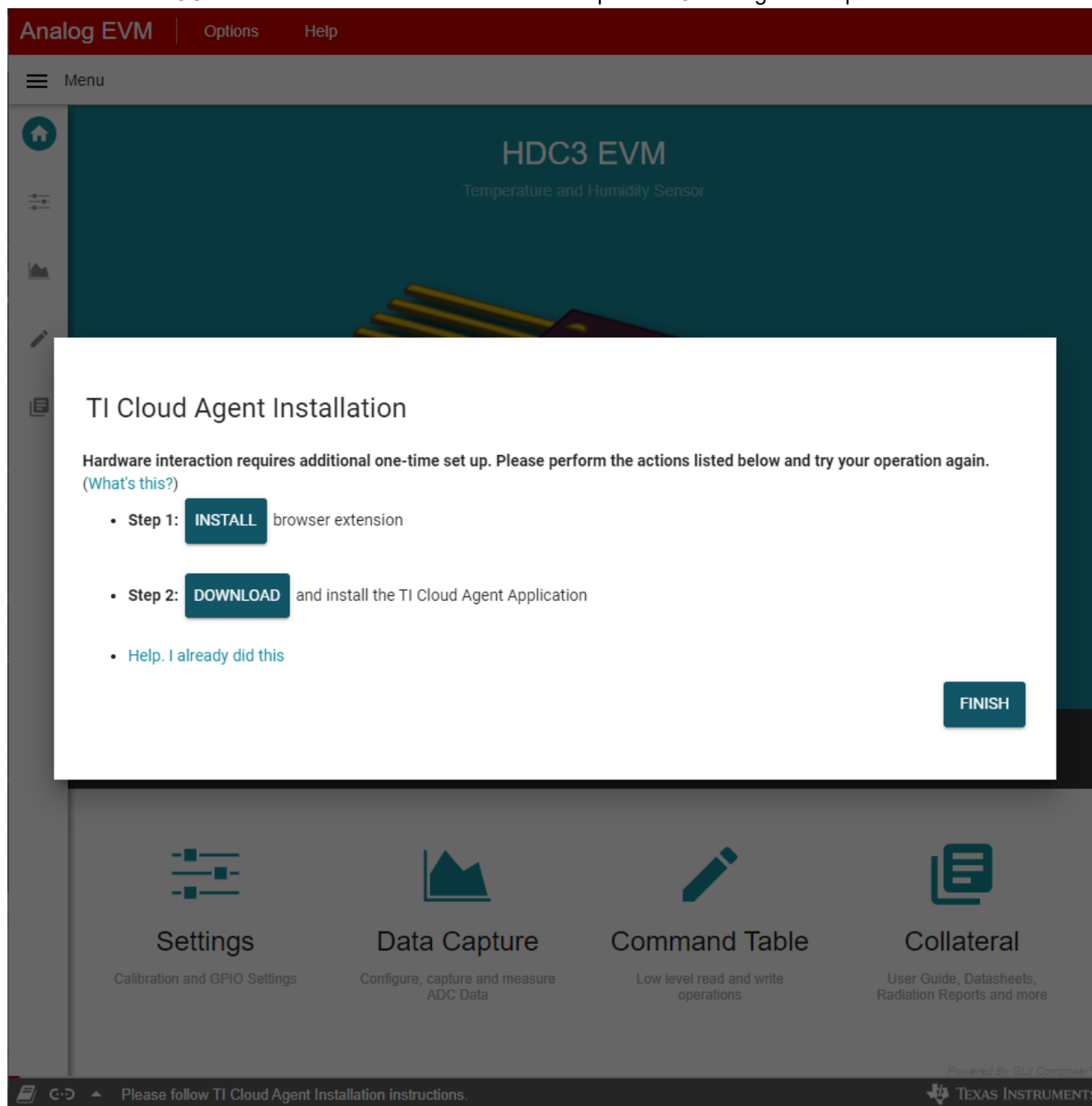



Figure 2-1. HDC3020EVM GUI on First Start-Up

2. Reload the browser window after installation to access the home screen of the HDC3020EVM GUI.
3. Connect the HDC3020EVM to the USB port of your computer through the USB. Drivers for the device will install automatically and the GUI will connect to the EVM.
4. Temperature and humidity data can be recorded and logged on the *Data Capture* tab. Select the  icon to navigate to this page. You can enable register auto-read from this page, and initiate a one-shot to take sample data.
5. Configure device settings from the *Device Configuration* tab .

3 EVM Hardware

This section describes how to connect, set up, and program the HDC3020EVM.

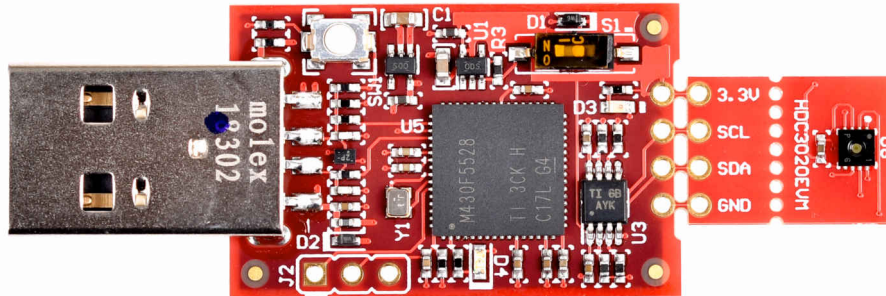

Figure 3-1. HDC3020EVM

3.1 EVM Power Supply

The HDC3020EVM power is supplied through the USB connector. The interface is used to access the device's registers and read the conversion data from the HDC3020 through the I²C communication protocol. The LDO (U4) converts the 5 V from the USB to 3.3 V used by the HDC3020 and the MSP430. The EVM can be directly inserted into a USB port on a PC or laptop, or connected to the latter using the appropriate USB cable.

3.2 Input/Output Connectors

The EVM can be broken off into two sections. The headers on module are not populated and they can be used to debug the firmware by using a 4-wire cable. The through holes can also be used as a test point to probe these signals during EVM operation.

3.3 Device Address Configuration

The HDC3020 can support 4 I²C addresses, but the HDC3020EVM can only support one fixed I²C address: 0x44 (7 Bit).

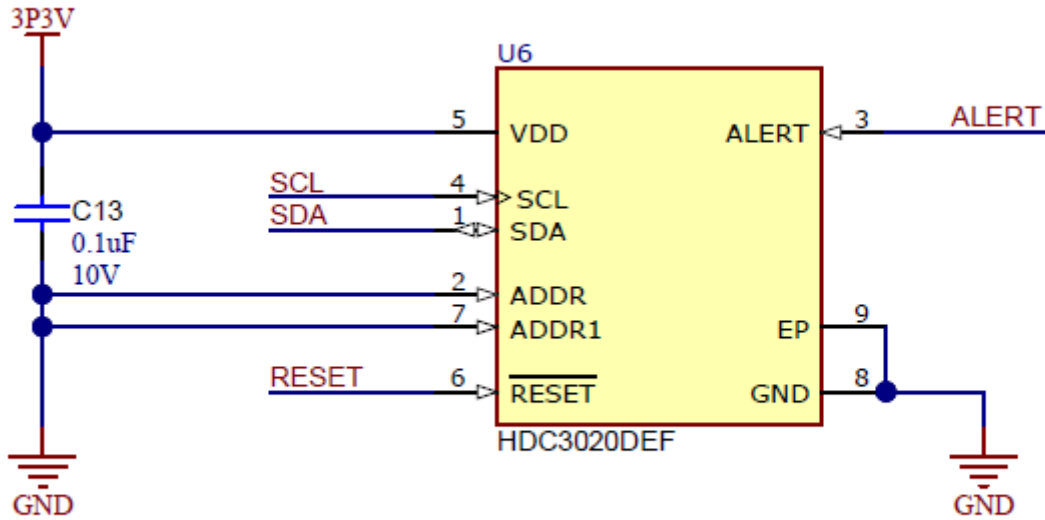

Figure 3-2. HDC3020 Sensor Module

3.4 Reducing Thermal Mass

The HDC3020EVM can be broken into 2 sections to isolate the thermal mass of the μC from the HDC3020. [Figure 3-3](#) shows the board perforations where the two sections can break apart.

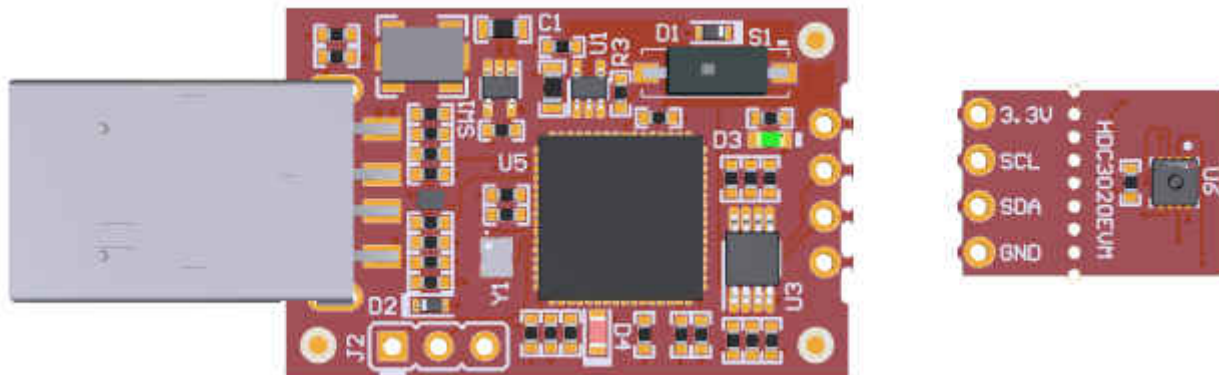

Figure 3-3. PC Interface and Sensor Module

The purpose of the header connector is to isolate the heat source from the HDC3020. When the HDC3020 is separated from the MSP430, it can be connected through wires or headers on both ends for remote temperature and humidity measurements. In this configuration, the thermal mass is reduced, improving the temperature measurements of the device. The GUI can still be used to communicate with the sensor and collect data.

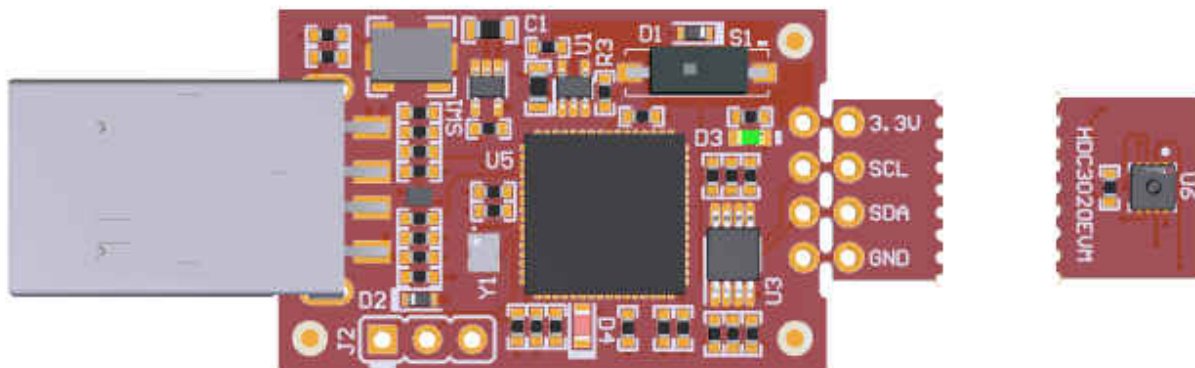

Figure 3-4. PC Interface and Smaller Sensor Module

Alternatively it is possible to connect the sensor module to a custom microcontroller.



Figure 3-5. Bottom Layer of the HDC3020EVM

3.5 EVM Operating Conditions

The controller and device sides of the EVM have different temperature limits as shown in [Table 3-3](#). These are set by the onboard MSP430F5528 and the HDC3020 ICs on the controller and breakout portions, respectively.

Table 3-1. EVM Operating Conditions

Board Section	Conditions	Temperature Range
Controller Board	Recommended Operating T_J Range	-40 °C to 85 °C
	Absolute Maximum T_{stg}	-55 °C to 150 °C
HDC3020 Breakout board	Recommended Operating T_J Range	-20 °C to 70 °C
	Absolute Maximum T_{stg}	-40 °C to 125 °C

4 EVM GUI

The EVM software is available through the EVM product folder on the TI website through this [hyperlink](#). The application can be run directly from the gallery with minimal install or it can be downloaded from the gallery to run on desktop local machine.

4.1 Live Software

The live software currently works within Chrome, Firefox and Safari browsers. Internet Explorer and Edge browsers are not supported. Users can access the live version through one of the following actions:

1. Go to the HDC3020EVM Tool page on TI.com and click the *View* button.
2. Go to dev.ti.com/gallery and search for the HDC3020EVM.

Click the application icon within the gallery to launch the software. Follow the prompts onscreen to install the TI Cloud Agent Bridge browser plugin.

4.2 Offline Version

Users can access the latest version of the offline software by navigating to the live version as noted above. The offline version allows users to append data to a file without losing any results. Look for the *Download* icon and download both the application and runtime for the operating system as shown in the download pop-up. After download, unzip and run the downloaded executable file. Follow the onscreen instructions to install the local version of the GUI.

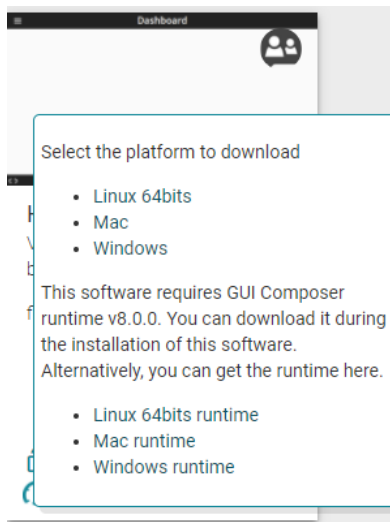

Figure 4-1. Download Pop-Up for the Offline Version

5 GUI Operation

This section describes how to use the HDC3020EVM GUI

5.1 Home Tab

The *Home* tab is shown at software launch. The icons on the left side of the screen are shortcuts which can be used for navigation to other tabs within the GUI. They are identical to the icons on the bottom half of the Home page.

If the HDC3020EVM is connected to the PC and powered on, the *Hardware Connected* icon will appear on the left corner of the status bar.

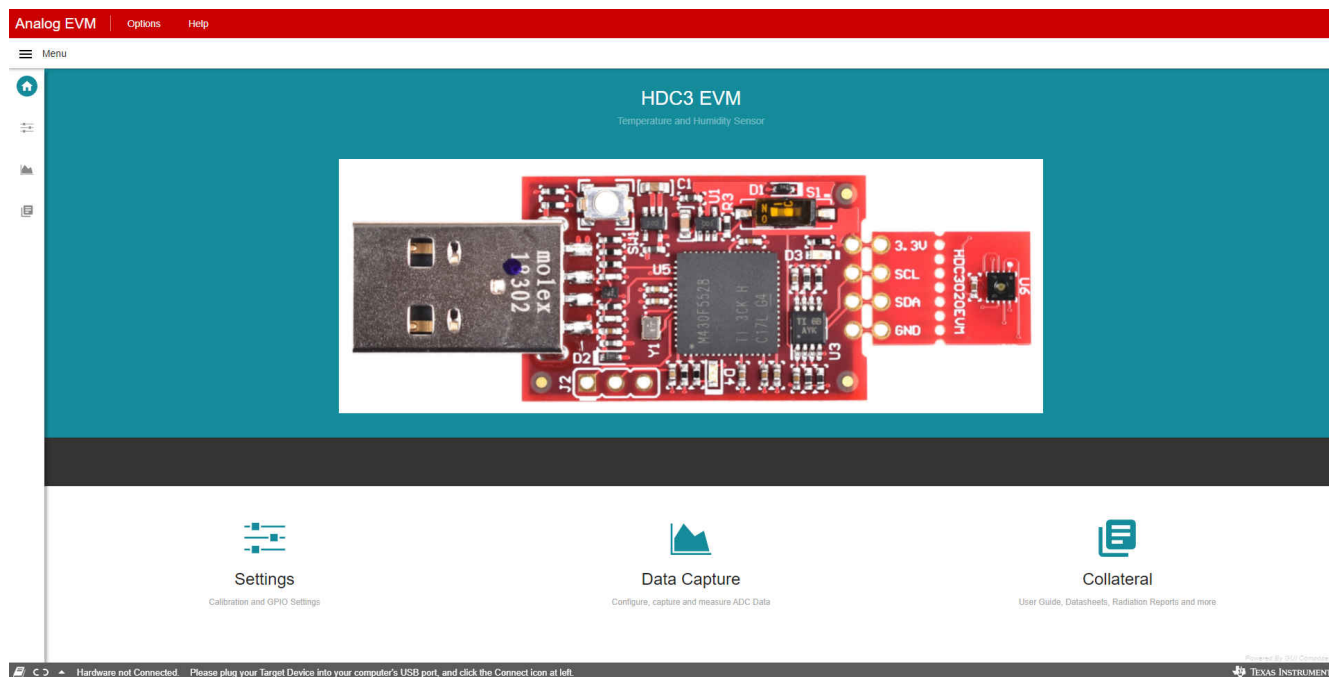

Figure 5-1. Home Tab of the HDC3020EVM GUI

5.2 Data Capture Tab

The *Data Capture* tab reports the temperature and humidity from the HDC3020 device included on the HDC3020EVM. Each selection option/button on this tab has a specific function as described below:

- Measurement Mode tab
 - Measurement mode: Can select Trigger-On Demand (one-shot mode) or the Auto Measurement mode with the appropriate frequency
 - Measurement duration: Changes the number of measurement bits for humidity/temperature measurements
- Chart Controls
 - I²C polling rate: Changes the communication frequency between the MCU and the HDC3020EVM
- Offset
 - Temperature Offset: Offsets the temperature value and sets it within the HDC3020 device
 - Humidity Offset: Offsets the humidity value and sets it within the HDC3020 device
- Status
 - Read Status: Reads the information about the operating state of the HDC3020
 - Clear Status: Clears the contents stored in the status registers
- Alert
 - Temperature Limit: Reads/writes the temperature threshold
 - Humidity Limit: Reads/writes the humidity threshold
 - Limit Code: Hex code representing the truncated 16-bit threshold value
- Other
 - Software reset: Issues a software reset
 - Enable Heater: Heating element included in device to remove any condensation on the device
 - Disable Heater: Disables the heater
- NIST ID
 - Read NIST ID: Returns the unique 48-bit value of the HDC3020.

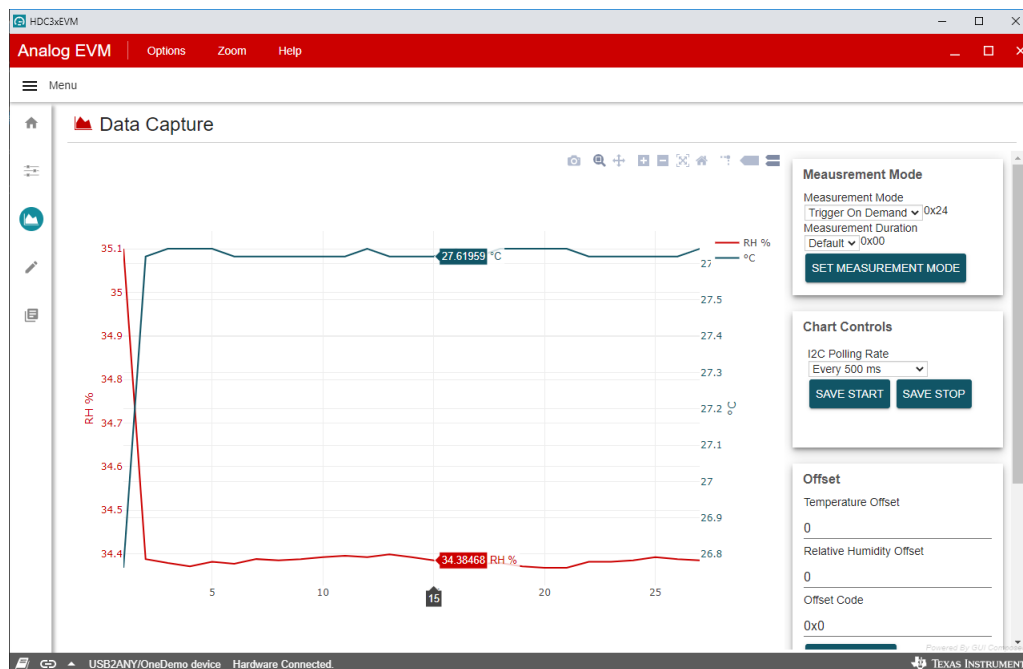

Figure 5-2. HDC3020EVM GUI Data Capture Tab

- Drift Correction
 - The Drift Correction Algorithm calibrates the device and corrects any observed sensor drift that may be encountered due to device mishandling or exposure to contaminants. This feature is not supported in Auto Measurement Mode and the device can only support this algorithm if the drift is less than 25% RH. If the observed drift after running this algorithm is greater than 25%, then the error is only reduced by (actual drift - 25%)
 - [Figure 5-3](#) describes the different layout considerations that can be implemented on the HDC devices. The EVM and the layout with the cutout would require lower current to execute the Drift Correction Algorithm. However, the layout that has little to no thermal isolation would require a lot more current to execute this command. The HDC3020EVM GUI offers three different power levels to run this algorithm: Min Power, Mid Power and Max Power

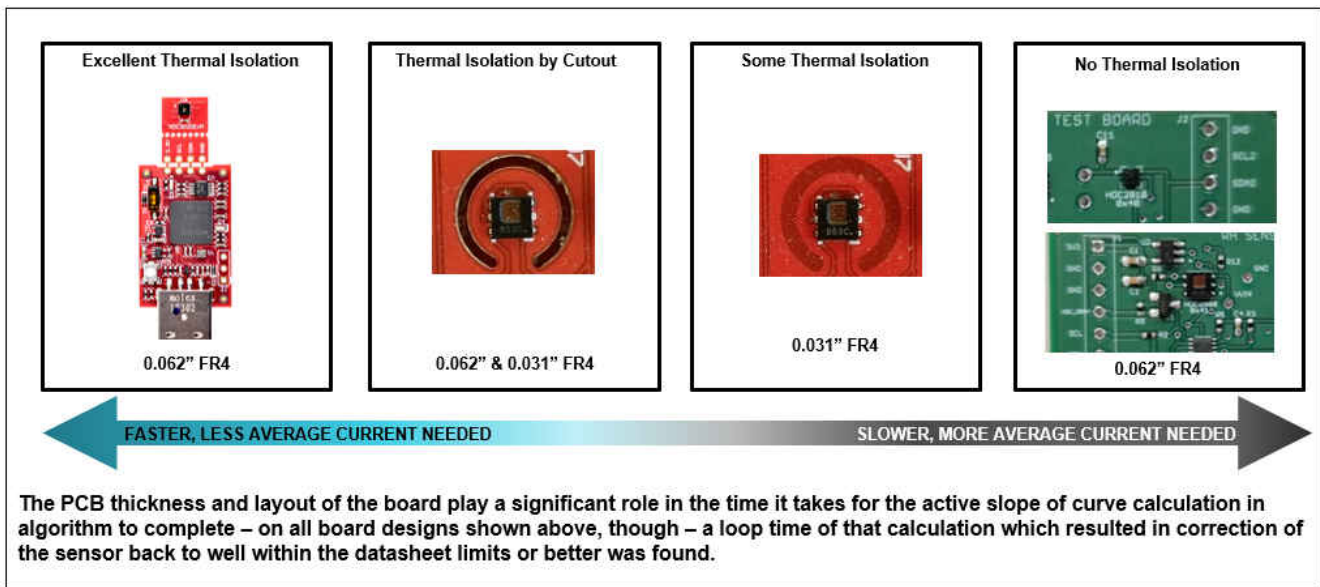

Figure 5-3. Thermal Isolation Examples

- This feature is currently only available for a demonstration purpose on the HDC3020EVM. The power settings are specifically chosen to correct the drift on the HDC3020EVM and code compensates for this layout.

Note

The Max power should only be used when there is no thermal isolation on the PCB. Using this setting for more than 5 minutes can damage the sensor.

- Execute: This command executes the Drift Correction Algorithm
 - After running this algorithm, the drift offset is displayed in the offset register tab (as shown in [figure 5-4](#)). To correct the offset, select the Write Offset command and the RH value is corrected.
 - The execution time depends on the power setting and the drift observed, but should not last more than 5 minutes. If the algorithm is taking a lot of time, abort the execution and re-start after a few minutes.

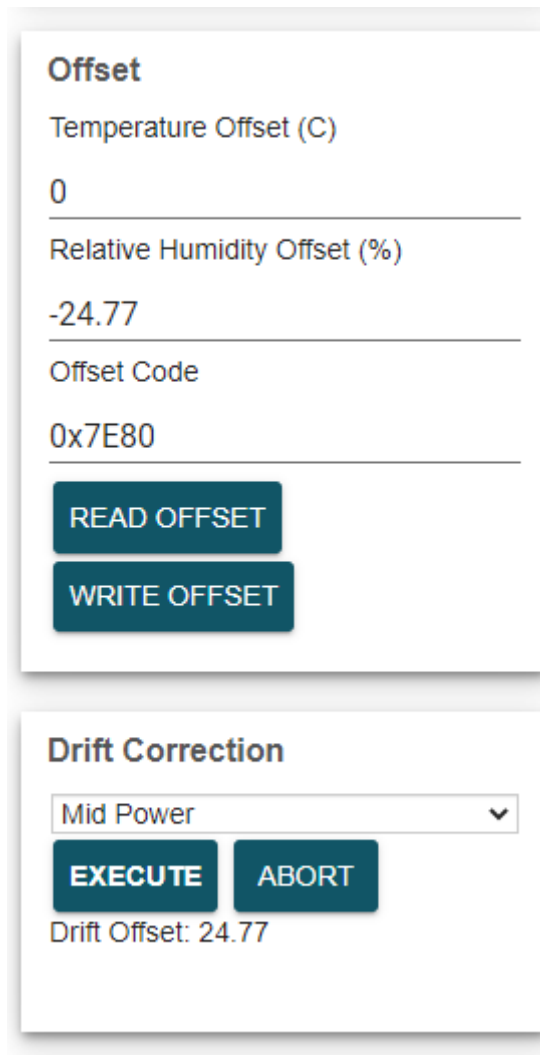

Figure 5-4. Offset Register Displaying the HDC3020 Drift Offset

- Abort: Aborts the drift Correction in the middle of an execution.

5.3 EVM Settings Tab

The *EVM Settings* tab allows for setup of features for the USB to I²C bridge and EVM GUI.

- I²C Frequency: Change the communication frequency between the control board and HDC3020EVM.
- I²C Address: Selects the address option of the HDC3020.
- CRC Generator: Retrieves the 8-bit CRC byte from the HDC3020. The message bytes must be a hex value and must be separated by a single space.

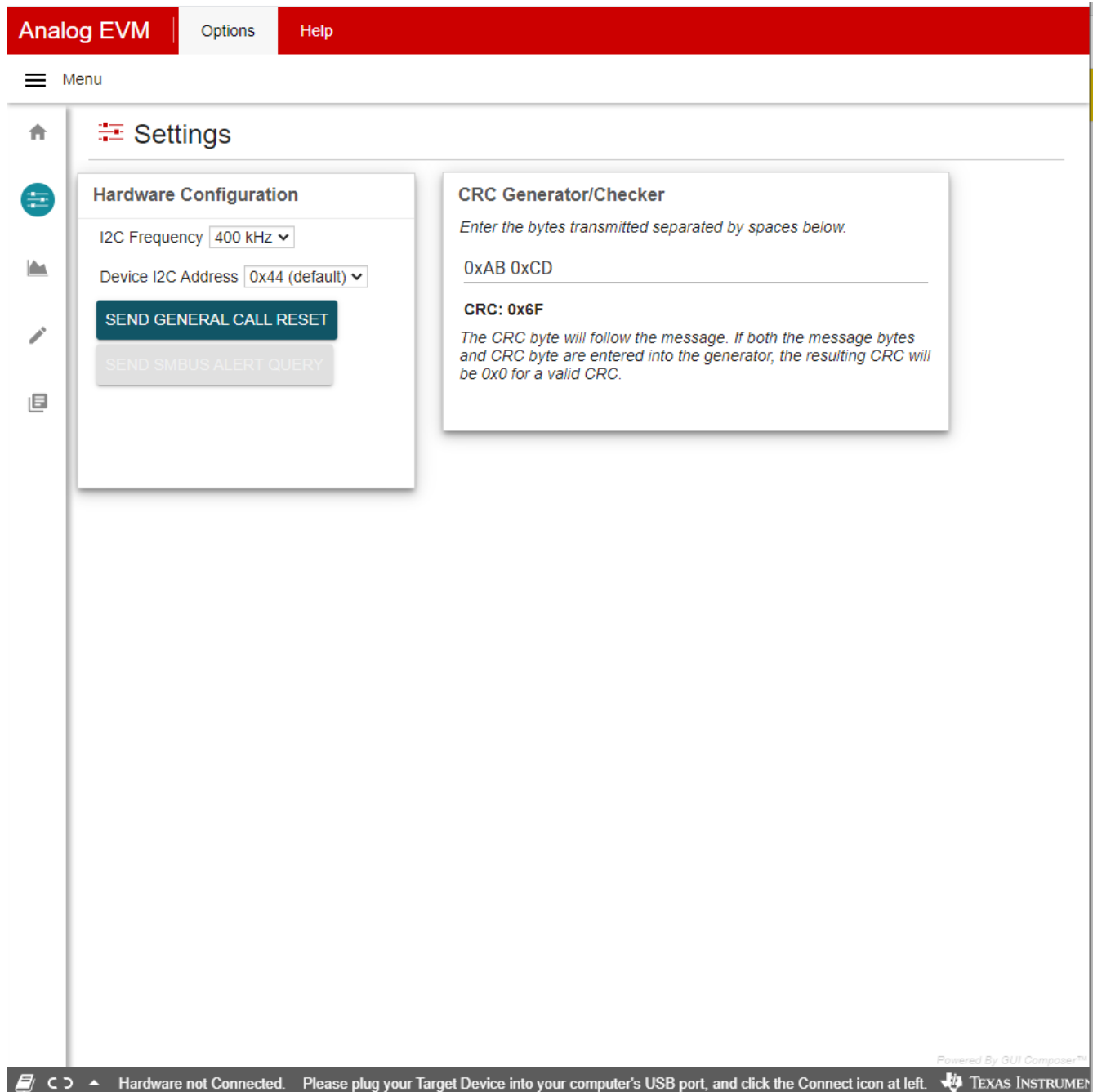

Figure 5-5. HDC3020EVM GUI Settings Tab

5.4 Collateral

The *Collateral* tab contains links to articles, guides, reports, and videos which are relevant to the HDC3020 device. This includes the device data sheet and EVM user's guide.

6 Board Layout

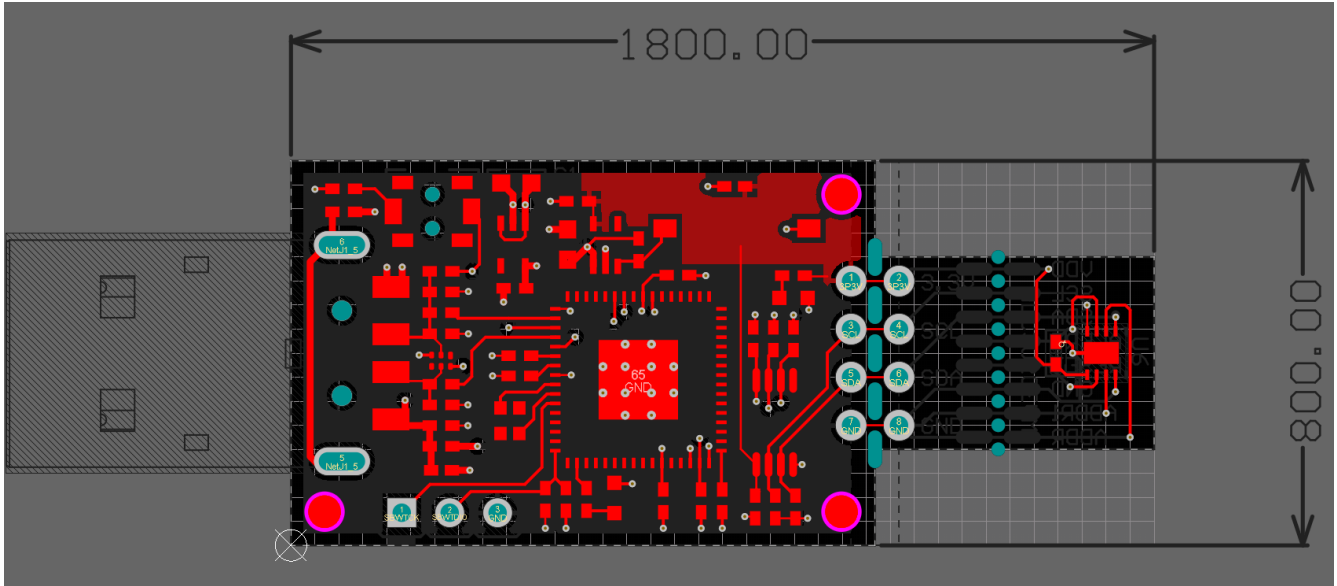

Figure 6-1. Top Layer Routing

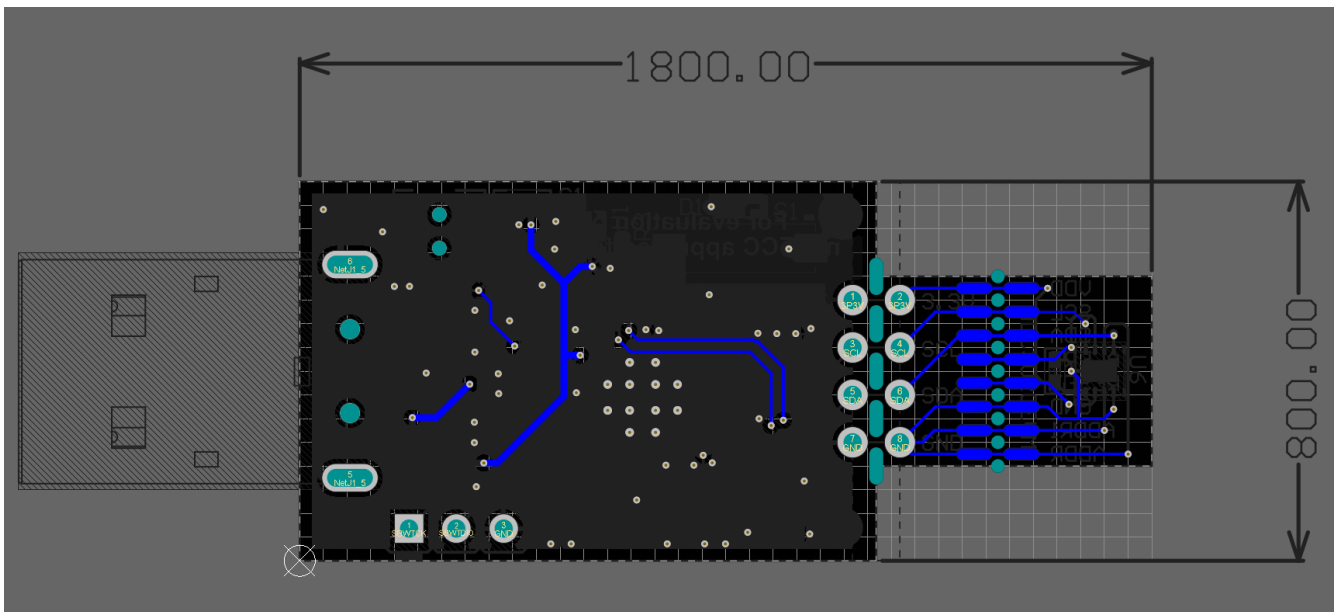

Figure 6-2. Bottom Layer Routing

7 Schematic

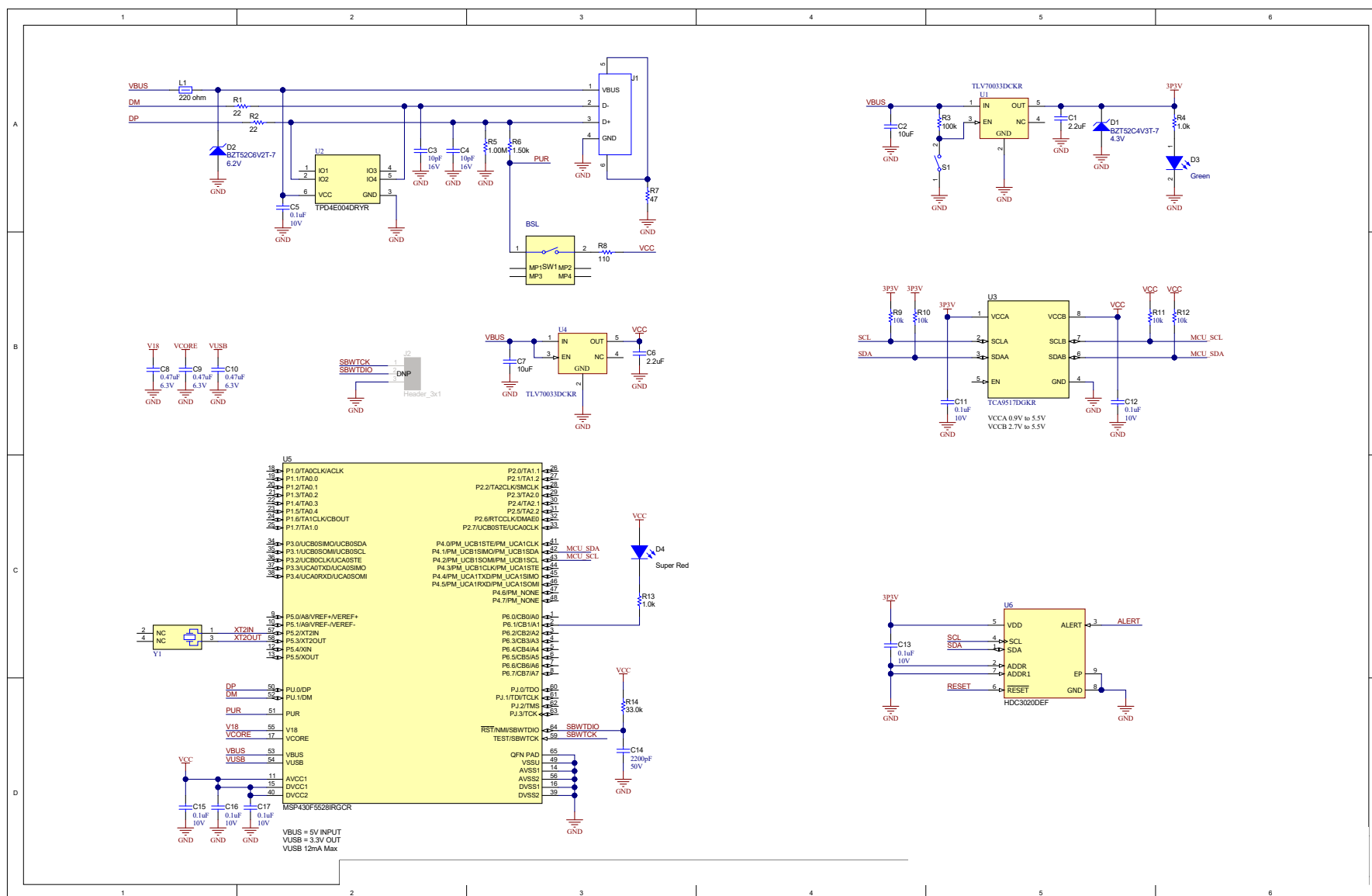

Figure 7-1. HDC3020EVM Schematic

8 HDC3020EVM Build of Materials

Designator	Quantity	Description	Package Reference	PartNumber
C1, C6	2	CAP, CERM, 2.2 uF, 16 V, +/- 10%, X5R, 0402	0402	GRM155R61C225KE11D
C2, C7	2	CAP, CERM, 10 uF, 10 V, +/- 20%, X5R, 0603	0603	C1608X5R1A106M080AC
C3, C4	2	CAP, CERM, 10 pF, 16 V, +/- 10%, C0G, 0402	0402	C0402C100K4GACTU
C5, C11, C12, C13, C15, C16, C17	7	CAP, CERM, 0.1 uF, 10 V, +/- 10%, X5R, 0402	0402	LMK105BJ104KV-F
C8, C9, C10	3	CAP, CERM, 0.47 uF, 6.3 V, +/- 10%, X7R, 0402	0402	JMK105B7474KVHF
C14	1	CAP, CERM, 2200 pF, 50 V, +/- 5%, X7R, 0402	0402	CL05B222JB5NNNC
D1	1	Diode, Zener, 4.3 V, 300 mW, SOD-523	SOD-523	BZT52C4V3T-7
D2	1	Diode, Zener, 6.2 V, 300 mW, SOD-523	SOD-523	BZT52C6V2T-7
D3	1	LED, Green, SMD	LED, GREEN, 0603	SML-LX0603GW-TR
D4	1	LED, Super Red, SMD	LED_0603	150060SS75000
J1	1	Connector, Plug, USB Type A, R/A, Top Mount SMT	USB Type A right angle	48037-1000
J2	1	Header, 2.54 mm, 3x1, Gold, TH	Header, 2.54 mm, 3x1, TH	GBC03SAAN
L1	1	Ferrite Bead, 220 ohm @ 100 MHz, 0.45 A, 0402	0402	BLM15AG221SN1D
R1, R2	2	RES, 22, 5%, 0.1 W, AEC-Q200 Grade 0, 0402	0402	ERJ-2GEJ220X
R3	1	RES, 100 k, 5%, 0.1 W, AEC-Q200 Grade 0, 0402	0402	ERJ-2GEJ104X
R4, R13	2	RES, 1.0 k, 5%, 0.1 W, AEC-Q200 Grade 0, 0402	0402	ERJ-2GEJ102X
R5	1	RES, 1.00 M, 1%, 0.063 W, AEC-Q200 Grade 0, 0402	0402	RMCF0402FT1M00
R6	1	RES, 1.50 k, 1%, 0.063 W, AEC-Q200 Grade 0, 0402	0402	RMCF0402FT1K50
R7	1	RES, 47, 5%, 0.1 W, AEC-Q200 Grade 0, 0402	0402	ERJ-2GEJ470X
R8	1	RES, 110, 1%, 0.1 W, AEC-Q200 Grade 0, 0402	0402	ERJ-2RKF1100X
R9, R10, R11, R12	4	RES, 10 k, 5%, 0.1 W, AEC-Q200 Grade 0, 0402	0402	ERJ-2GEJ103X
R14	1	RES, 33.0 k, 1%, 0.063 W, 0402	0402	RC0402FR-0733KL

S1	1	Switch, Slide, SPST, Top Slide, SMT	Switch, Single Top Slide, 2.5x8x2.5mm	CHS-01TB
SW1	1	Switch, SPST-NO, Off-Mom, 0.05A, 12VDC, SMD	3.9x2.9mm	PTS820 J20M SMTR LFS
U1, U4	2	Single Output LDO, 200 mA, Fixed 3.3 V Output, 2 to 5.5 V Input, with Low IQ, 5-pin SC70 (DCK), -40 to 125 degC, Green (RoHS & no Sb/Br)	DCK0005A	TLV70033DCKR
U2	1	4-Channel ESD Protection Array for High-Speed Data Interfaces, DRY0006A (USON-6)	DRY0006A	TPD4E004DRYR
U3	1	Level-Shifting I2C Bus Repeater, DGK0008A (VSSOP-8)	DGK0008A	TCA9517DGKR
U5	1	16-Bit Ultra-Low-Power Microcontroller, 128KB Flash, 8KB RAM, USB, 12Bit ADC, 2 USCIs, 32Bit HW MPY, RGC0064B (VQFN-64)	RGC0064B	MSP430F5528IRGCR
U6	1	Integrated Humidity and Temperature Digital Sensor	WSON8	HDC3020DEF
Y1	1	Crystal, 24 MHz, SMD	2x1.6mm	XRCGB24M000F2P00R0

9 Revision History

NOTE: Page numbers for previous revisions may differ from page numbers in the current version.

Changes from Revision * (June 2021) to Revision A (June 2021)	Page
• Changed <i>Home Tab</i> section.....	9
• Changed <i>Data Capture Tab</i> section.....	10

STANDARD TERMS FOR EVALUATION MODULES

1. *Delivery:* TI delivers TI evaluation boards, kits, or modules, including any accompanying demonstration software, components, and/or documentation which may be provided together or separately (collectively, an "EVM" or "EVMs") to the User ("User") in accordance with the terms set forth herein. User's acceptance of the EVM is expressly subject to the following terms.
 - 1.1 EVMs are intended solely for product or software developers for use in a research and development setting to facilitate feasibility evaluation, experimentation, or scientific analysis of TI semiconductors products. EVMs have no direct function and are not finished products. EVMs shall not be directly or indirectly assembled as a part or subassembly in any finished product. For clarification, any software or software tools provided with the EVM ("Software") shall not be subject to the terms and conditions set forth herein but rather shall be subject to the applicable terms that accompany such Software
 - 1.2 EVMs are not intended for consumer or household use. EVMs may not be sold, sublicensed, leased, rented, loaned, assigned, or otherwise distributed for commercial purposes by Users, in whole or in part, or used in any finished product or production system.
2. *Limited Warranty and Related Remedies/Disclaimers:*
 - 2.1 These terms do not apply to Software. The warranty, if any, for Software is covered in the applicable Software License Agreement.
 - 2.2 TI warrants that the TI EVM will conform to TI's published specifications for ninety (90) days after the date TI delivers such EVM to User. Notwithstanding the foregoing, TI shall not be liable for a nonconforming EVM if (a) the nonconformity was caused by neglect, misuse or mistreatment by an entity other than TI, including improper installation or testing, or for any EVMs that have been altered or modified in any way by an entity other than TI, (b) the nonconformity resulted from User's design, specifications or instructions for such EVMs or improper system design, or (c) User has not paid on time. Testing and other quality control techniques are used to the extent TI deems necessary. TI does not test all parameters of each EVM. User's claims against TI under this Section 2 are void if User fails to notify TI of any apparent defects in the EVMs within ten (10) business days after delivery, or of any hidden defects with ten (10) business days after the defect has been detected.
 - 2.3 TI's sole liability shall be at its option to repair or replace EVMs that fail to conform to the warranty set forth above, or credit User's account for such EVM. TI's liability under this warranty shall be limited to EVMs that are returned during the warranty period to the address designated by TI and that are determined by TI not to conform to such warranty. If TI elects to repair or replace such EVM, TI shall have a reasonable time to repair such EVM or provide replacements. Repaired EVMs shall be warranted for the remainder of the original warranty period. Replaced EVMs shall be warranted for a new full ninety (90) day warranty period.

WARNING

Evaluation Kits are intended solely for use by technically qualified, professional electronics experts who are familiar with the dangers and application risks associated with handling electrical mechanical components, systems, and subsystems.

User shall operate the Evaluation Kit within TI's recommended guidelines and any applicable legal or environmental requirements as well as reasonable and customary safeguards. Failure to set up and/or operate the Evaluation Kit within TI's recommended guidelines may result in personal injury or death or property damage. Proper set up entails following TI's instructions for electrical ratings of interface circuits such as input, output and electrical loads.

NOTE:

EXPOSURE TO ELECTROSTATIC DISCHARGE (ESD) MAY CAUSE DEGRADATION OR FAILURE OF THE EVALUATION KIT; TI RECOMMENDS STORAGE OF THE EVALUATION KIT IN A PROTECTIVE ESD BAG.

3 Regulatory Notices:

3.1 United States

3.1.1 Notice applicable to EVMs not FCC-Approved:

FCC NOTICE: This kit is designed to allow product developers to evaluate electronic components, circuitry, or software associated with the kit to determine whether to incorporate such items in a finished product and software developers to write software applications for use with the end product. This kit is not a finished product and when assembled may not be resold or otherwise marketed unless all required FCC equipment authorizations are first obtained. Operation is subject to the condition that this product not cause harmful interference to licensed radio stations and that this product accept harmful interference. Unless the assembled kit is designed to operate under part 15, part 18 or part 95 of this chapter, the operator of the kit must operate under the authority of an FCC license holder or must secure an experimental authorization under part 5 of this chapter.

3.1.2 For EVMs annotated as FCC – FEDERAL COMMUNICATIONS COMMISSION Part 15 Compliant:

CAUTION

This device complies with part 15 of the FCC Rules. Operation is subject to the following two conditions: (1) This device may not cause harmful interference, and (2) this device must accept any interference received, including interference that may cause undesired operation.

Changes or modifications not expressly approved by the party responsible for compliance could void the user's authority to operate the equipment.

FCC Interference Statement for Class A EVM devices

NOTE: This equipment has been tested and found to comply with the limits for a Class A digital device, pursuant to part 15 of the FCC Rules. These limits are designed to provide reasonable protection against harmful interference when the equipment is operated in a commercial environment. This equipment generates, uses, and can radiate radio frequency energy and, if not installed and used in accordance with the instruction manual, may cause harmful interference to radio communications. Operation of this equipment in a residential area is likely to cause harmful interference in which case the user will be required to correct the interference at his own expense.

FCC Interference Statement for Class B EVM devices

NOTE: This equipment has been tested and found to comply with the limits for a Class B digital device, pursuant to part 15 of the FCC Rules. These limits are designed to provide reasonable protection against harmful interference in a residential installation. This equipment generates, uses and can radiate radio frequency energy and, if not installed and used in accordance with the instructions, may cause harmful interference to radio communications. However, there is no guarantee that interference will not occur in a particular installation. If this equipment does cause harmful interference to radio or television reception, which can be determined by turning the equipment off and on, the user is encouraged to try to correct the interference by one or more of the following measures:

- Reorient or relocate the receiving antenna.
- Increase the separation between the equipment and receiver.
- Connect the equipment into an outlet on a circuit different from that to which the receiver is connected.
- Consult the dealer or an experienced radio/TV technician for help.

3.2 Canada

3.2.1 For EVMs issued with an Industry Canada Certificate of Conformance to RSS-210 or RSS-247

Concerning EVMs Including Radio Transmitters:

This device complies with Industry Canada license-exempt RSSs. Operation is subject to the following two conditions:

(1) this device may not cause interference, and (2) this device must accept any interference, including interference that may cause undesired operation of the device.

Concernant les EVMs avec appareils radio:

Le présent appareil est conforme aux CNR d'Industrie Canada applicables aux appareils radio exempts de licence. L'exploitation est autorisée aux deux conditions suivantes: (1) l'appareil ne doit pas produire de brouillage, et (2) l'utilisateur de l'appareil doit accepter tout brouillage radioélectrique subi, même si le brouillage est susceptible d'en compromettre le fonctionnement.

Concerning EVMs Including Detachable Antennas:

Under Industry Canada regulations, this radio transmitter may only operate using an antenna of a type and maximum (or lesser) gain approved for the transmitter by Industry Canada. To reduce potential radio interference to other users, the antenna type and its gain should be so chosen that the equivalent isotropically radiated power (e.i.r.p.) is not more than that necessary for successful communication. This radio transmitter has been approved by Industry Canada to operate with the antenna types listed in the user guide with the maximum permissible gain and required antenna impedance for each antenna type indicated. Antenna types not included in this list, having a gain greater than the maximum gain indicated for that type, are strictly prohibited for use with this device.

Concernant les EVMs avec antennes détachables

Conformément à la réglementation d'Industrie Canada, le présent émetteur radio peut fonctionner avec une antenne d'un type et d'un gain maximal (ou inférieur) approuvé pour l'émetteur par Industrie Canada. Dans le but de réduire les risques de brouillage radioélectrique à l'intention des autres utilisateurs, il faut choisir le type d'antenne et son gain de sorte que la puissance isotrope rayonnée équivalente (p.i.r.e.) ne dépasse pas l'intensité nécessaire à l'établissement d'une communication satisfaisante. Le présent émetteur radio a été approuvé par Industrie Canada pour fonctionner avec les types d'antenne énumérés dans le manuel d'usage et ayant un gain admissible maximal et l'impédance requise pour chaque type d'antenne. Les types d'antenne non inclus dans cette liste, ou dont le gain est supérieur au gain maximal indiqué, sont strictement interdits pour l'exploitation de l'émetteur.

3.3 Japan

3.3.1 *Notice for EVMs delivered in Japan:* Please see http://www.tij.co.jp/lstds/ti_ja/general/eStore/notice_01.page 日本国内に輸入される評価用キット、ボードについては、次のところをご覧ください。
http://www.tij.co.jp/lstds/ti_ja/general/eStore/notice_01.page

3.3.2 *Notice for Users of EVMs Considered "Radio Frequency Products" in Japan:* EVMs entering Japan may not be certified by TI as conforming to Technical Regulations of Radio Law of Japan.

If User uses EVMs in Japan, not certified to Technical Regulations of Radio Law of Japan, User is required to follow the instructions set forth by Radio Law of Japan, which includes, but is not limited to, the instructions below with respect to EVMs (which for the avoidance of doubt are stated strictly for convenience and should be verified by User):

1. Use EVMs in a shielded room or any other test facility as defined in the notification #173 issued by Ministry of Internal Affairs and Communications on March 28, 2006, based on Sub-section 1.1 of Article 6 of the Ministry's Rule for Enforcement of Radio Law of Japan,
2. Use EVMs only after User obtains the license of Test Radio Station as provided in Radio Law of Japan with respect to EVMs, or
3. Use of EVMs only after User obtains the Technical Regulations Conformity Certification as provided in Radio Law of Japan with respect to EVMs. Also, do not transfer EVMs, unless User gives the same notice above to the transferee. Please note that if User does not follow the instructions above, User will be subject to penalties of Radio Law of Japan.

【無線電波を送信する製品の開発キットをお使いになる際の注意事項】 開発キットの中には技術基準適合証明を受けていないものがあります。技術適合証明を受けていないものご使用に際しては、電波法遵守のため、以下のいずれかの措置を取っていただく必要がありますのでご注意ください。

1. 電波法施行規則第6条第1項第1号に基づく平成18年3月28日総務省告示第173号で定められた電波暗室等の試験設備でご使用いただく。
2. 実験局の免許を取得後ご使用いただく。
3. 技術基準適合証明を取得後ご使用いただく。

なお、本製品は、上記の「ご使用にあたっての注意」を譲渡先、移転先に通知しない限り、譲渡、移転できないものとします。

上記を遵守頂けない場合は、電波法の罰則が適用される可能性があることをご留意ください。日本テキサス・インスツルメンツ株式会社
東京都新宿区西新宿 6 丁目 2 4 番 1 号
西新宿三井ビル

3.3.3 *Notice for EVMs for Power Line Communication:* Please see http://www.tij.co.jp/lstds/ti_ja/general/eStore/notice_02.page 電力線搬送波通信についての開発キットをお使いになる際の注意事項については、次のところをご覧ください。
http://www.tij.co.jp/lstds/ti_ja/general/eStore/notice_02.page

3.4 European Union

3.4.1 *For EVMs subject to EU Directive 2014/30/EU (Electromagnetic Compatibility Directive):*

This is a class A product intended for use in environments other than domestic environments that are connected to a low-voltage power-supply network that supplies buildings used for domestic purposes. In a domestic environment this product may cause radio interference in which case the user may be required to take adequate measures.

-
- 4 *EVM Use Restrictions and Warnings:*
 - 4.1 EVMS ARE NOT FOR USE IN FUNCTIONAL SAFETY AND/OR SAFETY CRITICAL EVALUATIONS, INCLUDING BUT NOT LIMITED TO EVALUATIONS OF LIFE SUPPORT APPLICATIONS.
 - 4.2 User must read and apply the user guide and other available documentation provided by TI regarding the EVM prior to handling or using the EVM, including without limitation any warning or restriction notices. The notices contain important safety information related to, for example, temperatures and voltages.
 - 4.3 *Safety-Related Warnings and Restrictions:*
 - 4.3.1 User shall operate the EVM within TI's recommended specifications and environmental considerations stated in the user guide, other available documentation provided by TI, and any other applicable requirements and employ reasonable and customary safeguards. Exceeding the specified performance ratings and specifications (including but not limited to input and output voltage, current, power, and environmental ranges) for the EVM may cause personal injury or death, or property damage. If there are questions concerning performance ratings and specifications, User should contact a TI field representative prior to connecting interface electronics including input power and intended loads. Any loads applied outside of the specified output range may also result in unintended and/or inaccurate operation and/or possible permanent damage to the EVM and/or interface electronics. Please consult the EVM user guide prior to connecting any load to the EVM output. If there is uncertainty as to the load specification, please contact a TI field representative. During normal operation, even with the inputs and outputs kept within the specified allowable ranges, some circuit components may have elevated case temperatures. These components include but are not limited to linear regulators, switching transistors, pass transistors, current sense resistors, and heat sinks, which can be identified using the information in the associated documentation. When working with the EVM, please be aware that the EVM may become very warm.
 - 4.3.2 EVMs are intended solely for use by technically qualified, professional electronics experts who are familiar with the dangers and application risks associated with handling electrical mechanical components, systems, and subsystems. User assumes all responsibility and liability for proper and safe handling and use of the EVM by User or its employees, affiliates, contractors or designees. User assumes all responsibility and liability to ensure that any interfaces (electronic and/or mechanical) between the EVM and any human body are designed with suitable isolation and means to safely limit accessible leakage currents to minimize the risk of electrical shock hazard. User assumes all responsibility and liability for any improper or unsafe handling or use of the EVM by User or its employees, affiliates, contractors or designees.
 - 4.4 User assumes all responsibility and liability to determine whether the EVM is subject to any applicable international, federal, state, or local laws and regulations related to User's handling and use of the EVM and, if applicable, User assumes all responsibility and liability for compliance in all respects with such laws and regulations. User assumes all responsibility and liability for proper disposal and recycling of the EVM consistent with all applicable international, federal, state, and local requirements.
 5. *Accuracy of Information:* To the extent TI provides information on the availability and function of EVMs, TI attempts to be as accurate as possible. However, TI does not warrant the accuracy of EVM descriptions, EVM availability or other information on its websites as accurate, complete, reliable, current, or error-free.
 6. *Disclaimers:*
 - 6.1 EXCEPT AS SET FORTH ABOVE, EVMS AND ANY MATERIALS PROVIDED WITH THE EVM (INCLUDING, BUT NOT LIMITED TO, REFERENCE DESIGNS AND THE DESIGN OF THE EVM ITSELF) ARE PROVIDED "AS IS" AND "WITH ALL FAULTS." TI DISCLAIMS ALL OTHER WARRANTIES, EXPRESS OR IMPLIED, REGARDING SUCH ITEMS, INCLUDING BUT NOT LIMITED TO ANY EPIDEMIC FAILURE WARRANTY OR IMPLIED WARRANTIES OF MERCHANTABILITY OR FITNESS FOR A PARTICULAR PURPOSE OR NON-INFRINGEMENT OF ANY THIRD PARTY PATENTS, COPYRIGHTS, TRADE SECRETS OR OTHER INTELLECTUAL PROPERTY RIGHTS.
 - 6.2 EXCEPT FOR THE LIMITED RIGHT TO USE THE EVM SET FORTH HEREIN, NOTHING IN THESE TERMS SHALL BE CONSTRUED AS GRANTING OR CONFERRING ANY RIGHTS BY LICENSE, PATENT, OR ANY OTHER INDUSTRIAL OR INTELLECTUAL PROPERTY RIGHT OF TI, ITS SUPPLIERS/LICENSORS OR ANY OTHER THIRD PARTY, TO USE THE EVM IN ANY FINISHED END-USER OR READY-TO-USE FINAL PRODUCT, OR FOR ANY INVENTION, DISCOVERY OR IMPROVEMENT, REGARDLESS OF WHEN MADE, CONCEIVED OR ACQUIRED.
 7. *USER'S INDEMNITY OBLIGATIONS AND REPRESENTATIONS.* USER WILL DEFEND, INDEMNIFY AND HOLD TI, ITS LICENSORS AND THEIR REPRESENTATIVES HARMLESS FROM AND AGAINST ANY AND ALL CLAIMS, DAMAGES, LOSSES, EXPENSES, COSTS AND LIABILITIES (COLLECTIVELY, "CLAIMS") ARISING OUT OF OR IN CONNECTION WITH ANY HANDLING OR USE OF THE EVM THAT IS NOT IN ACCORDANCE WITH THESE TERMS. THIS OBLIGATION SHALL APPLY WHETHER CLAIMS ARISE UNDER STATUTE, REGULATION, OR THE LAW OF TORT, CONTRACT OR ANY OTHER LEGAL THEORY, AND EVEN IF THE EVM FAILS TO PERFORM AS DESCRIBED OR EXPECTED.
-

8. *Limitations on Damages and Liability:*

8.1 *General Limitations.* IN NO EVENT SHALL TI BE LIABLE FOR ANY SPECIAL, COLLATERAL, INDIRECT, PUNITIVE, INCIDENTAL, CONSEQUENTIAL, OR EXEMPLARY DAMAGES IN CONNECTION WITH OR ARISING OUT OF THESE TERMS OR THE USE OF THE EVMS , REGARDLESS OF WHETHER TI HAS BEEN ADVISED OF THE POSSIBILITY OF SUCH DAMAGES. EXCLUDED DAMAGES INCLUDE, BUT ARE NOT LIMITED TO, COST OF REMOVAL OR REINSTALLATION, ANCILLARY COSTS TO THE PROCUREMENT OF SUBSTITUTE GOODS OR SERVICES, RETESTING, OUTSIDE COMPUTER TIME, LABOR COSTS, LOSS OF GOODWILL, LOSS OF PROFITS, LOSS OF SAVINGS, LOSS OF USE, LOSS OF DATA, OR BUSINESS INTERRUPTION. NO CLAIM, SUIT OR ACTION SHALL BE BROUGHT AGAINST TI MORE THAN TWELVE (12) MONTHS AFTER THE EVENT THAT GAVE RISE TO THE CAUSE OF ACTION HAS OCCURRED.

8.2 *Specific Limitations.* IN NO EVENT SHALL TI'S AGGREGATE LIABILITY FROM ANY USE OF AN EVM PROVIDED HEREUNDER, INCLUDING FROM ANY WARRANTY, INDEMNITY OR OTHER OBLIGATION ARISING OUT OF OR IN CONNECTION WITH THESE TERMS, , EXCEED THE TOTAL AMOUNT PAID TO TI BY USER FOR THE PARTICULAR EVM(S) AT ISSUE DURING THE PRIOR TWELVE (12) MONTHS WITH RESPECT TO WHICH LOSSES OR DAMAGES ARE CLAIMED. THE EXISTENCE OF MORE THAN ONE CLAIM SHALL NOT ENLARGE OR EXTEND THIS LIMIT.

9. *Return Policy.* Except as otherwise provided, TI does not offer any refunds, returns, or exchanges. Furthermore, no return of EVM(s) will be accepted if the package has been opened and no return of the EVM(s) will be accepted if they are damaged or otherwise not in a resalable condition. If User feels it has been incorrectly charged for the EVM(s) it ordered or that delivery violates the applicable order, User should contact TI. All refunds will be made in full within thirty (30) working days from the return of the components(s), excluding any postage or packaging costs.

10. *Governing Law:* These terms and conditions shall be governed by and interpreted in accordance with the laws of the State of Texas, without reference to conflict-of-laws principles. User agrees that non-exclusive jurisdiction for any dispute arising out of or relating to these terms and conditions lies within courts located in the State of Texas and consents to venue in Dallas County, Texas. Notwithstanding the foregoing, any judgment may be enforced in any United States or foreign court, and TI may seek injunctive relief in any United States or foreign court.

Mailing Address: Texas Instruments, Post Office Box 655303, Dallas, Texas 75265
Copyright © 2019, Texas Instruments Incorporated

IMPORTANT NOTICE AND DISCLAIMER

TI PROVIDES TECHNICAL AND RELIABILITY DATA (INCLUDING DATASHEETS), DESIGN RESOURCES (INCLUDING REFERENCE DESIGNS), APPLICATION OR OTHER DESIGN ADVICE, WEB TOOLS, SAFETY INFORMATION, AND OTHER RESOURCES "AS IS" AND WITH ALL FAULTS, AND DISCLAIMS ALL WARRANTIES, EXPRESS AND IMPLIED, INCLUDING WITHOUT LIMITATION ANY IMPLIED WARRANTIES OF MERCHANTABILITY, FITNESS FOR A PARTICULAR PURPOSE OR NON-INFRINGEMENT OF THIRD PARTY INTELLECTUAL PROPERTY RIGHTS.

These resources are intended for skilled developers designing with TI products. You are solely responsible for (1) selecting the appropriate TI products for your application, (2) designing, validating and testing your application, and (3) ensuring your application meets applicable standards, and any other safety, security, or other requirements. These resources are subject to change without notice. TI grants you permission to use these resources only for development of an application that uses the TI products described in the resource. Other reproduction and display of these resources is prohibited. No license is granted to any other TI intellectual property right or to any third party intellectual property right. TI disclaims responsibility for, and you will fully indemnify TI and its representatives against, any claims, damages, costs, losses, and liabilities arising out of your use of these resources.

TI's products are provided subject to TI's Terms of Sale (<https://www.ti.com/legal/termsofsale.html>) or other applicable terms available either on [ti.com](https://www.ti.com) or provided in conjunction with such TI products. TI's provision of these resources does not expand or otherwise alter TI's applicable warranties or warranty disclaimers for TI products.

Mailing Address: Texas Instruments, Post Office Box 655303, Dallas, Texas 75265
Copyright © 2021, Texas Instruments Incorporated