



Evan Su

## ABSTRACT

PCIe linear redrivers are designed to compensate for signal distortion caused by insertion loss from traces and other elements in the path of a PCIe signal. This is done through special CTLE amplifiers that boost the high-frequency content of incoming signals. This process of equalization, or EQ, is one of the fundamental tools of PCIe signal conditioning across different product categories. While simpler at a theoretical level than the additional digital processing capabilities offered by PCIe retimer, the analog properties of equalization already have complexities that can be confusing to engineers who are new to the field of signal integrity. This application note can explain the background and operation of PCIe redriver equalization in an intuitive and detailed way to assist engineers in planning and using TI PCIe redrivers in designs.

---

## Table of Contents

<b>1 Introduction</b> .....	2
<b>2 Insertion Loss and Equalization</b> .....	2
<b>3 EQ Amplifiers and EQ Indexes</b> .....	5
<b>4 Over-Equalization and Redriver Placement</b> .....	8
<b>5 Summary</b> .....	10
<b>6 References</b> .....	10

## Trademarks

All trademarks are the property of their respective owners.

## 1 Introduction

PCIe, or *Peripheral Component Interconnect Express*, is a high-speed data transfer standard commonly used in computers and enterprise systems to interface between CPUs and various types of endpoints such as GPUs and SSDs. It is also attracting interest in new areas such as automotive applications. PCIe is an ubiquitous protocol with many advantages: it uses a simple NRZ (non-return-to-zero) differential signaling scheme and the structure based on multiple individual lanes allows it to support both small and large applications as needed.

Industry trends have led to greater and greater PCIe data rate demands with successive generations. PCIe Gen 1 from 2003 allowed for 2.5 GT/s of data transfer per lane. PCIe Gen 5 from 2017 provides for up to 32 GT/s, an increase of nearly 13x. No modifications were made to the original NRZ signaling scheme from Gen 1 to Gen 5 and such data rate increases were accomplished by increasing the symbol rate, leading to new challenges in signal integrity. Signal conditioning devices such as redrivers and retimers are designed to address these problems by maintaining signal quality over higher data rates and longer reaches. Though many methods can be used to condition signals, equalization is one of the most fundamental and is intimately tied to the properties of the materials that signals propagate through.

## 2 Insertion Loss and Equalization

To understand equalization, it is helpful to first discuss insertion loss. The physics of electromagnetic waves become complicated at high frequencies. Waves experience attenuation when they travel through a lossy medium, but the amount of attenuation, known as *insertion loss*, depends on both the characteristics of the medium and the frequency of the wave. A high-frequency data signal is necessarily composed of significant high-frequency components. As it travels through a copper wire or trace for example, the high-frequency components can experience more attenuation than the lower-frequency components, resulting a spectral imbalance that distorts the shape of the signal in the time domain.

Figure 2-1 shows an example of insertion loss for a simulation model of a 5-inch length of FR4 trace: the loss starts from 0dB at DC, and becomes steadily larger with increasing frequency.

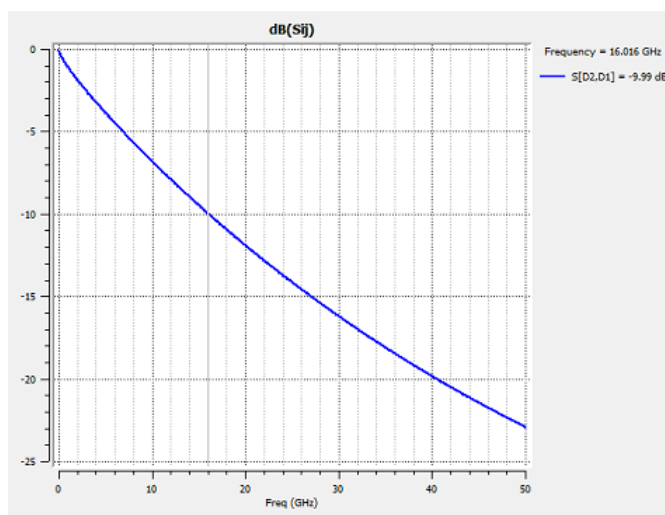
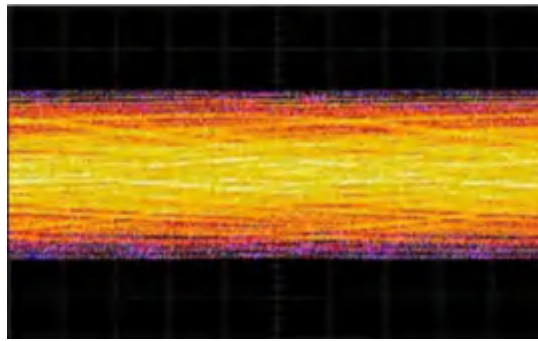

Figure 2-1. Example of Insertion Loss for a 5-inch FR4 Trace

One of the main features of this distortion is a phenomenon known as inter-symbol interference, or *ISI*. Signal edges and sharp, rapid transitions in general are formed by high-frequency components. When these are degraded in a sequence of symbols, symbols begin bleeding into each other, causing significant distortions in signal shaping. This can result in bit errors when the receiver samples these degraded symbols, and if severe enough the input is not intelligible at all to the receiver – an eye diagram can show a closed eye with no meaningful opening to distinguish and interpret signals, as in Figure 2-2.



**Figure 2-2. Eye Diagram of Signal with Severe ISI**

In general, increasing the loss between the sender and receiver of a signal by extending the length or increasing the data rate can result in lower and lower signal quality until some limit where reliable and error-free operation cannot be maintained.

Since the amount of loss in a data channel is an important factor, there must be a convenient way to measure or quantify the loss at a system level. In the field of signal integrity, the loss of an element is usually measured in terms of insertion loss of a certain dB at a certain Nyquist frequency, the frequency that is half of the symbol rate. The reason for this is that for PRBS data at a certain rate, the vast majority (over 90%) of the signal energy is concentrated at or below the Nyquist frequency, so the Nyquist frequency can be used as an upper bound for the region where degradation must be seriously accounted for. Degradation above Nyquist frequency can still negatively affect the signal, but to a lesser extent.

In PCIe, the Nyquist frequency for PCIe Gen 5 (32 GT/s data transfer) is  $32\text{GHz} \div 2 = 16\text{GHz}$ . For Gen 4 (16 GT/s data transfer), is  $16\text{GHz} \div 2 = 8\text{GHz}$ . An example insertion loss figure of -4dB at 16GHz for an element along the signal path implies that a 16GHz pure sine wave is attenuated by 4 dB after passing through it, and that this information is most relevant for PCIe Gen 5 operation. For differential protocols like PCIe, insertion loss can be calculated from two-port S-parameters as  $S[D2, D1]$ , the differential-mode to differential-mode gain.

While this loss-induced signal degradation can be a major problem for system designers, degradation can be repaired. Theoretically, an element whose frequency response is the mathematical inverse of the applied loss can be able to restore the original signal. The cascaded response of the loss and the element can be unity across all frequencies, preserving the characteristics of the original signal. This is the fundamental idea behind equalization: an active device can perform frequency-selective amplification to counter the effects of frequency-selective loss.

Figure 2-3 shows the EQ boosts for the DS320PR810 PCIe Gen 5 redriver: the positive magnitude and positive slope up to and beyond 16GHz means there is gain or amplification of such frequencies, and the stronger EQ settings increase the slope to compensate for more loss.

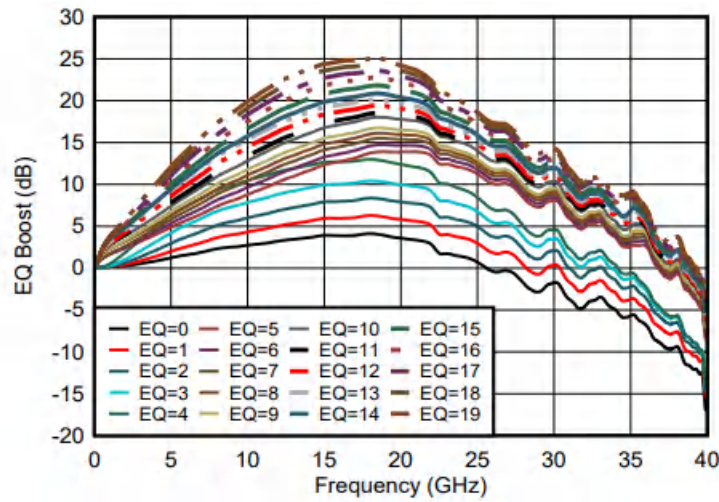

**Figure 2-3. EQ Boost Curves for DS320PR810**

In practice, this restoration cannot be exactly perfect, because the media of an actual system and the behavior of an actual active device can both be non-ideal. Equalization therefore *compensates* for insertion loss. The processed signal can have some inevitable spectral and shaping differences from the original pre-degradation signal, but successful compensation can result in an open eye diagram that the signal receiver can interpret without error.

Figure 2-4 shows the same signal from Figure 2-2 after passing through a redriver.

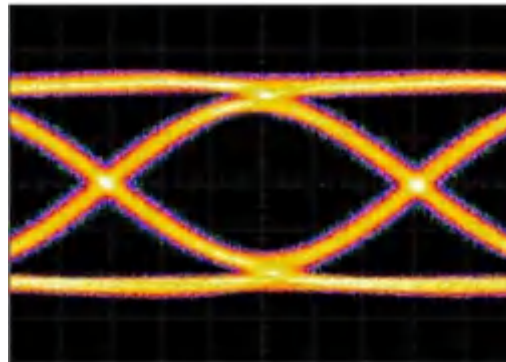

**Figure 2-4. Correction of ISI by a Redriver**

As such, equalization is a powerful tool to restore signal quality and enable longer PCIe links.

### 3 EQ Amplifiers and EQ Indexes

In a PCIe redriver, equalization is carried out by a special analog filter consisting of several amplifiers. Overall, they comprise a *continuous-time linear equalizer*, or *CTLE* stage. The overall frequency response of the filter is designed to compensate for insertion loss of a certain type of signal media, typically copper PCB traces, and at various adjustable boost strengths so that the device can accurately compensate a range of losses – a fixed boost can be inflexible because applying too much or too little boost relative to the actual amount of loss in the system can negatively impact signal quality.

Focusing on TI PCIe Gen 5 redrivers as an example, the equalization system for each channel consists of three amplifiers:

- EQ Boost 1
- EQ Boost 2
- EQ Boost 1 (2nd order)

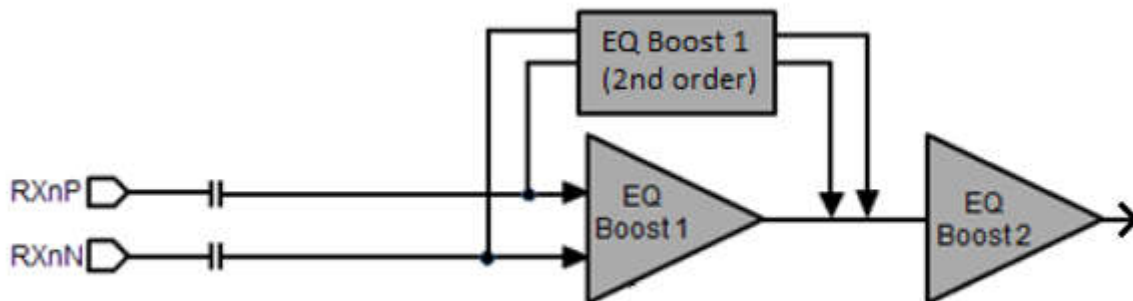

**Figure 3-1. EQ Amplifiers for TI PCIe Gen 5 Redrivers**

To provide finer control of the overall filter shape, each of these amplifiers focuses on a somewhat different frequency region. EQ Boost 1 tends to operate close to the Nyquist frequency, EQ Boost 2 tends to operate somewhat higher than Nyquist frequency, and EQ Boost 1 (2nd order) tends to operate at mid to lower frequencies. However the overall activities still overlap, so changing EQ Boost 1 (2nd order) for example affects the high frequency regions as well.

The following images illustrate some of the behavior of the individual amplifier settings in a network analyzer bench test setup; note that the methodology and trends are somewhat different from the EQ curves shown previously. EQ Index Default is used as a baseline for comparison and the data is saved in memory as the light pink trace. The magenta traces are data from custom settings altered from EQ Index Default by changing one of the amplifier settings to maximum or minimum.

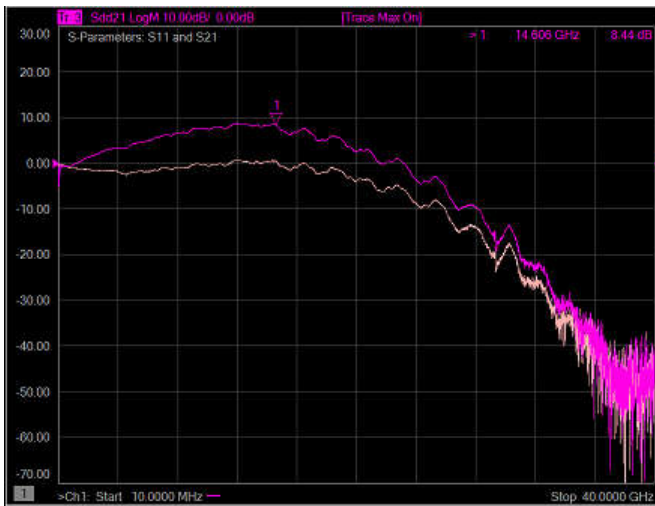

**Figure 3-2. EQ Index Default vs Maximum EQ Boost 1**

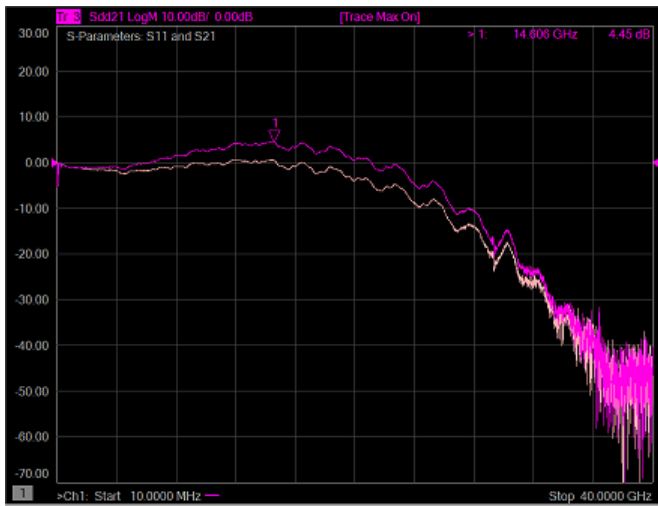

**Figure 3-3. EQ Index Default vs Maximum EQ Boost 2**

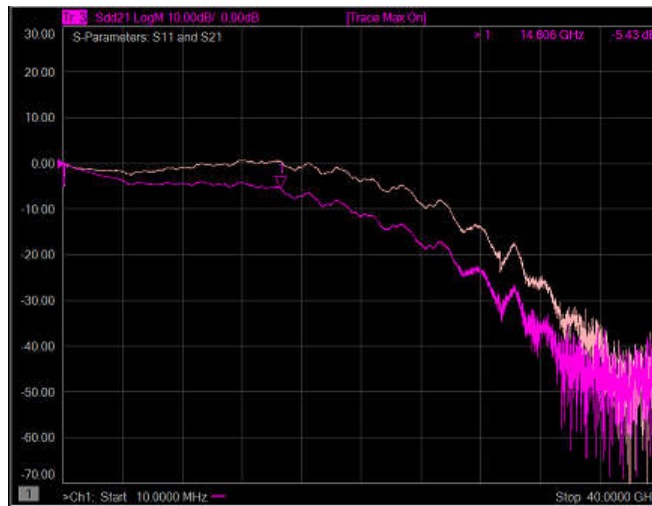

**Figure 3-4. EQ Index Default vs Minimum EQ Boost 1 (2nd order)**

As adjusting the individual amplifier settings can be complicated, TI Gen 5 and Gen 4 redrivers organize combinations of the three amplifier settings into the *EQ Index* system, where EQ Index 0 is the lowest possible equalization setting of the redriver and higher indexes have successively higher boost strengths as measured by the boost applied at Nyquist frequency.

Table 3-1 taken from the [How to Tune TI PCIe Gen5 Redrivers](#) application note estimates boosts for every EQ Index in the Gen 5 redriver architecture. Note that the individual redriver products differ in the exact amount of boost for each setting, this table is for illustrative purposes only and the product data sheets can be consulted during project design.

**Table 3-1. Generic EQ Index Boosts for TI PCIe Gen5 Redrivers**

Equalization Selection	Typical EQ Boost	
	Gain at 8GHz (dB)	Gain at 16GHz (dB)
0	2.0	3.0
1	3.5	5.0
2	5.0	7.0
3	7.0	9.0
4	8.0	12.0
5	9.0	16.0
6	9.8	17.0
7	10.2	18.0
8	10.8	18.5
9	11.2	19.0
10	11.8	19.5
11	12.2	20.0
12	12.8	20.5
13	13.2	21.0
14	13.8	21.5
15	14.2	22.0
16	14.8	22.5
17	15.2	23.0
18	15.6	23.5
19	16.0	24.0

As mentioned before, insertion loss is commonly measured at the Nyquist frequency. The basic intuition is that a low EQ index with low boost at Nyquist is intended to compensate for a small amount of insertion loss, and higher EQ indexes with higher boosts can compensate for higher amounts of insertion loss. In most applications, this simplified view is sufficient for the use and tuning for the redriver.

In certain situations where the electromagnetic characteristics of the loss profile are quite different from simple PCB traces, or the signal performance margin is small and needs fine-tuning to optimize, then the filter activity at non-Nyquist frequencies can also be taken into account. Even consecutive EQ indexes can have major differences in the combinations of amplifier settings, leading to differences in filter activity beyond what the boost at Nyquist figures can suggest.

For example, in Gen 5 devices, EQ Index 4 and EQ Index 5 are consecutive and have similar boosts at Nyquist (approximately 8dB and 10dB at 16GHz respectively on the DS320PR810), but the amplifier configurations are unlike, as shown in the images of the TI SigCon Architect GUI software in [Figure 3-5](#):

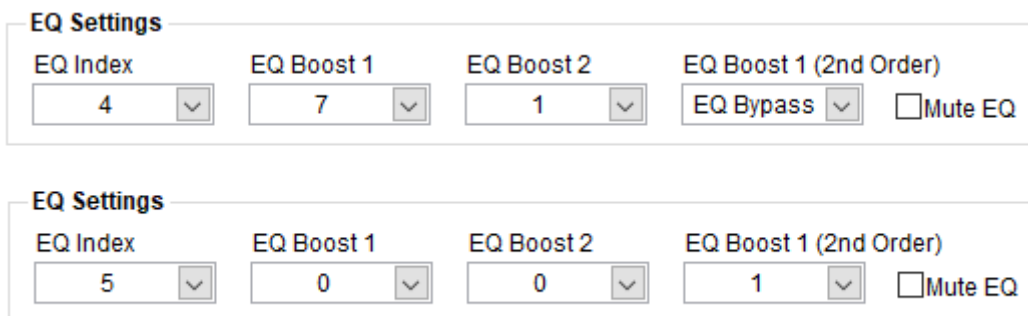

**Figure 3-5. Comparison of EQ Index 4 and EQ Index 5**

EQ Index 4 provides a high amount of boost centered at Nyquist frequency and slightly above, due to the EQ Boost 1 and EQ Boost 2 values, while EQ Boost 1 (2nd order) is bypassed. EQ Index 5 relies on EQ Boost 1 (2nd order) and therefore has more activity at the lower to medium frequency range in addition to the boost at Nyquist frequency.

For these reasons, selecting an appropriate EQ Index for an application can not be always as simple as calculating the amount of reach extension needed in a PCIe link and then picking the closest EQ Index based on values from the device data sheet. This can provide a starting point for further tuning, but is possible that better performance is achieved other nearby settings where the fine details of the filter shaping are a closer match for the system's actual loss profile. This can be explored during the board design process through signal integrity simulations and tested when tuning the redriver once the board has been manufactured.

## 4 Over-Equalization and Redriver Placement

A redriver performs best when compensating for degradation that has already happened to an incoming signal by the time it enters the redriver's RX inputs. In this situation, the redriver only needs to boost the degraded frequency content back to normal levels. If there is not much loss behind the redriver, the final receiver can see a good quality signal.

Sometimes, a redriver can be placed in a situation where the incoming signal has minimal degradation, and instead there is a relatively large amount of loss behind the redriver that still requires compensation. In this case, the redriver can try to preemptively compensate for the loss behind the redriver by over-equalizing the signal—meaning that the high frequency content is boosted above normal levels—with the expectation that the post-redriver channel loss can naturally roll off the excess by the time the signal reaches the final receiver.

Over-equalization produces visible distortions of the signal, typically as exaggerated edges, that can be seen on an oscilloscope or through the Eye Scan feature of TI Gen 5 redrivers. [Figure 4-1](#) shows an example of how over-equalization can be seen in Eye Scan: the over-equalized signal on the left panel has characteristic "horns" on the sides of the peak and a smaller flat region compared to the signal on the right panel that was provided a more normal amount of equalization. For more details on Eye Scan, refer to the [Eye Scan With TI PCI-Express Gen5.0 Redrivers](#) application note.

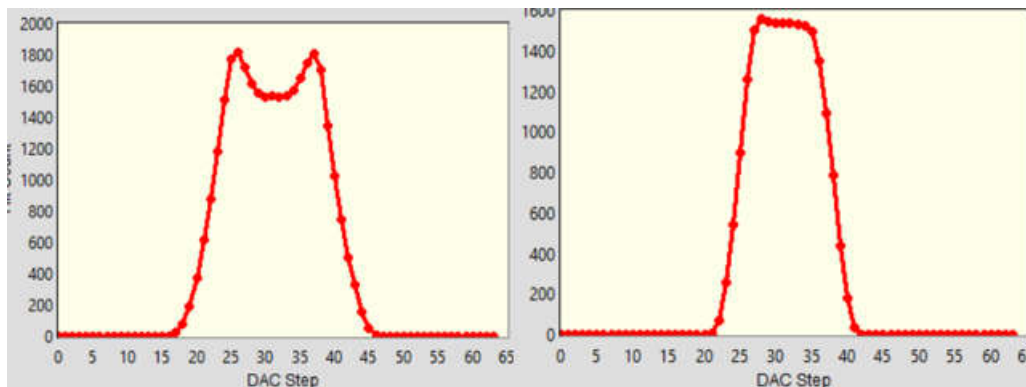
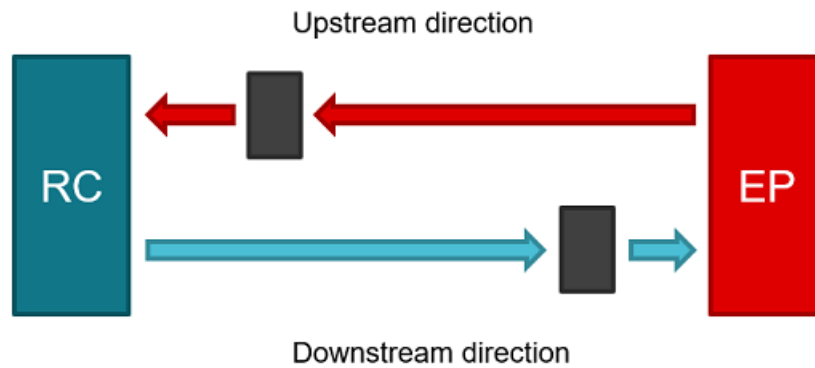

**Figure 4-1. Eye Scan Plot of Over-Equalized and Normal Signal**

This method of preemptive compensation can often be used successfully with small amounts of over-equalization, but caution is warranted: for a number of reasons, over-equalizing a signal is not as clean of a process as applying a normal amount of equalization to a degraded signal. The amplifiers in the device can have difficulty operating in the linear region when applying excess amounts of equalization, resulting in compression or clipping effects similar to those seen in overdriven audio signals. Thus, high amounts of over-equalization can result in distortion that does not properly roll off, reducing the signal quality seen by the final receiver.

Because of this asymmetry in the performance of equalization compared to over-equalization, careful placement can contribute to the successful use of redrivers in a system. Unidirectional redrivers that handle upstream and downstream directions with separate devices can be placed at different locations; the downstream redrivers can be placed closer to the endpoint, and the upstream redrivers can be placed closer to the root complex. This way, redrivers for both directions have the majority of the loss front-loaded for best performance.





**Figure 4-2. Unidirectional Redriver Placement**

Bidirectional redrivers that handle both upstream and downstream directions in one device can be placed in the middle of the loss channel so that both directions can have similar performance. Otherwise, one direction can encounter more problems with over-equalization than the other. Some systems can have inherently different performance in the upstream and downstream directions due to varying TX and RX performance by the root complex and endpoint; if this is the case, an off-center placement of a bidirectional redriver can be beneficial if supported by simulation results and past experience. Note that in a bidirectional redriver, it is still possible to configure the EQ settings separately for each direction as needed.

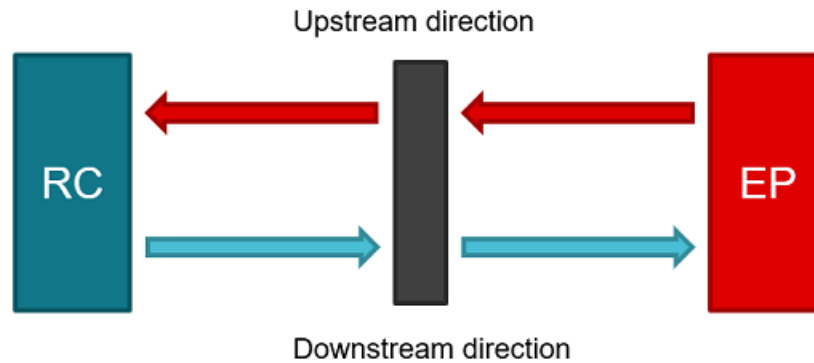

**Figure 4-3. Bidirectional Redriver Placement**

Signal integrity simulations using device IBIS-AMI or S-parameter models can be used to help evaluate redriver placement in the early stages of board layout design by distributing the total link loss in different amounts before and after the redriver, and checking the behavior of both directions. After architecture and space constraints are accounted for and the final placement is selected, the next step is to carefully design the PCB layout to reduce signal impairments and provide as much performance margin for the redriver as possible. For more details, refer to the [High-Speed PCB Layout for PCIe Gen 5](#) application note.

## 5 Summary

Equalization is a powerful analog capability that is used by almost all PCIe signal conditioning devices. By compensating for insertion loss in the signal path, the reach of the entire link can be extended, and linear redrivers that focus on equalization can perform this invisibly without interrupting the activities of the root complex and endpoint. There are still a number of more subtle factors such as filter shaping and device placement that can influence the performance of the redriver. Therefore, a deeper fundamental understanding of equalization can aid the successful implementation of PCIe redrivers, from the earliest stages of board design to the final stages of system testing and validation. For more device-specific information, resources, and support, visit the redriver product pages on [TI.com](https://www.ti.com).

## 6 References

- Texas Instruments, [DS320PR810 Eight-Channel Linear Redriver for PCIe 5.0, CXL 1.1](#), data sheet.
- Texas Instruments, [How to Tune TI PCIe Gen5 Redrivers](#), application note.
- Texas Instruments, [Eye Scan With TI PCI-Express Gen5.0 Redrivers](#), application note.
- Texas Instruments, [High-Speed PCB Layout for PCIe Gen 5](#), application note.

## IMPORTANT NOTICE AND DISCLAIMER

TI PROVIDES TECHNICAL AND RELIABILITY DATA (INCLUDING DATA SHEETS), DESIGN RESOURCES (INCLUDING REFERENCE DESIGNS), APPLICATION OR OTHER DESIGN ADVICE, WEB TOOLS, SAFETY INFORMATION, AND OTHER RESOURCES "AS IS" AND WITH ALL FAULTS, AND DISCLAIMS ALL WARRANTIES, EXPRESS AND IMPLIED, INCLUDING WITHOUT LIMITATION ANY IMPLIED WARRANTIES OF MERCHANTABILITY, FITNESS FOR A PARTICULAR PURPOSE OR NON-INFRINGEMENT OF THIRD PARTY INTELLECTUAL PROPERTY RIGHTS.

These resources are intended for skilled developers designing with TI products. You are solely responsible for (1) selecting the appropriate TI products for your application, (2) designing, validating and testing your application, and (3) ensuring your application meets applicable standards, and any other safety, security, regulatory or other requirements.

These resources are subject to change without notice. TI grants you permission to use these resources only for development of an application that uses the TI products described in the resource. Other reproduction and display of these resources is prohibited. No license is granted to any other TI intellectual property right or to any third party intellectual property right. TI disclaims responsibility for, and you will fully indemnify TI and its representatives against, any claims, damages, costs, losses, and liabilities arising out of your use of these resources.

TI's products are provided subject to [TI's Terms of Sale](#) or other applicable terms available either on [ti.com](https://www.ti.com) or provided in conjunction with such TI products. TI's provision of these resources does not expand or otherwise alter TI's applicable warranties or warranty disclaimers for TI products.

TI objects to and rejects any additional or different terms you may have proposed.

Mailing Address: Texas Instruments, Post Office Box 655303, Dallas, Texas 75265  
Copyright © 2024, Texas Instruments Incorporated