

## DS90UB926QSEVB User's Guide

---

LIST OF FIGURES .....	1
LIST OF TABLES .....	1
1. INTRODUCTION .....	2
1.1. CONTENTS OF DS90UB926QSEVB .....	2
1.2. HIGHLIGHTS OF EVB .....	2
1.3. OPERATION – QUICK SETUP .....	3
1.4. TROUBLE SHOOTING THE EVB .....	3
2. BOARD SETUP DETAILS .....	4
2.1. POWER CONNECTIONS .....	4
2.2. FPD-LINK III CONNECTION .....	4
2.3. FACTORY SET SWITCH SETTINGS AND JUMPERS DEFAULT CONFIGURATION .....	4
2.4. LVCMOS OUTPUT CONNECTOR DESCRIPTION .....	5
3. APPENDIX – I2C, INTEGRATED SPA DONGLE .....	6
3.1. I2C SPA DONGLE HOOKUP .....	6
3.2. IDX BOARD DEFAULT ADDRESS .....	6
3.3. ALP SOFTWARE SETUP .....	7
3.3.1. SYSTEM REQUIREMENTS .....	7
3.3.2. CD CONTENTS .....	7
3.3.3. INSTALLATION OF THE ALP SOFTWARE .....	7
3.3.4. INSTALLATION OF THE USB DRIVER .....	8
3.3.5. STARTUP - SOFTWARE DESCRIPTION .....	8
3.3.6. TROUBLE SHOOTING ALP SOFTWARE .....	14
4. EYE MONITOR – CMLOP/N .....	16
5. APPENDIX – USE OF OPTIONAL ROSENBERGER HSD CONNECTOR (J1) .....	16
6. APPENDIX – USE OF OPTIONAL MINI-B USB CONNECTOR (J2) .....	17
7. APPENDIX - BOARD LAYOUT .....	17
8. SCHEMATIC .....	24
9. BILL OF MATERIALS .....	29

### LIST OF FIGURES

Figure 1: DS90UB926Q EVB .....	2
Figure 2: Factory Switch (S1,S2,S3,S4,S5) and Jumper (JP2) Configuration .....	5
Figure 3: Initial ALP Screen .....	9
Figure 4: TOP View .....	18
Figure 5: Bottom View .....	19
Figure 6: TOP Layer .....	20
Figure 7: GND Layer .....	21
Figure 8: PWR Layer .....	22
Figure 9: BOTTOM Layer .....	23

### LIST OF TABLES

Table 1: Bill of Materials .....	29
----------------------------------	----

## 1. Introduction

The Texas Instruments DS90UB926QSEVB evaluation kit (EVB) provides an easy way to evaluate the operation and performance of the DS90UB926Q 2.975Gbps FPD-Link III deserializer.

### 1.1. Contents of DS90UB926QSEVB

1- DS90UB926Q EVB, 1- CD with ALP software, 1- USB cable

### 1.2. Highlights of EVB

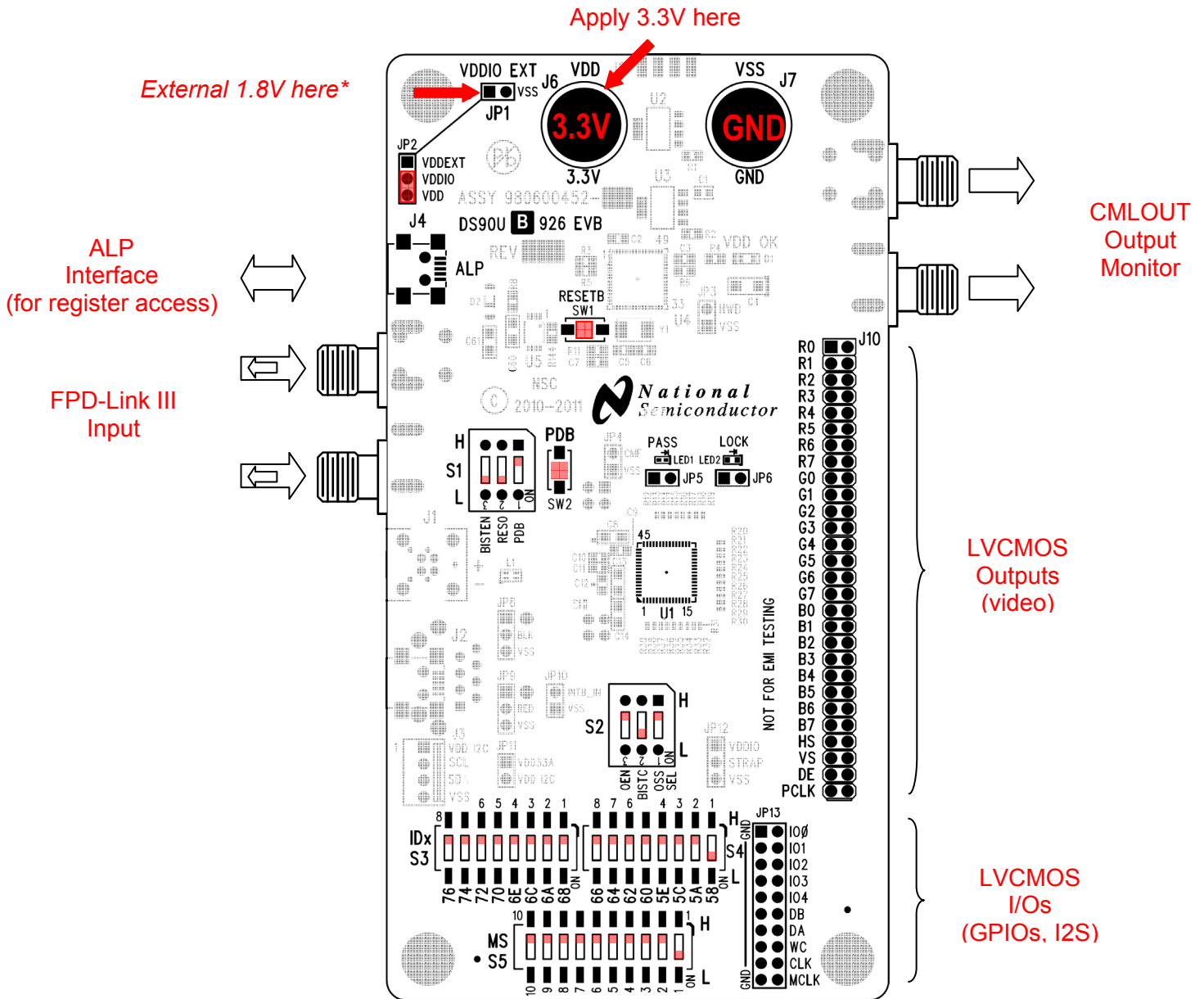

**Figure 1: DS90UB926Q EVB**

\* The default factory configuration is VDDIO = 3.3V. 3.3V does not have to be applied externally. To interface to 1.8V inputs, 1.8V must be applied externally. For VDDIO = 1.8V, move jumper on JP2 to short pins 1 and 2.

### 1.3. Operation – Quick Setup

**Make sure S1, S2, S3, S4, S5, and JP2 are configured as shown in Figure 1.**

- 1) Turn on the serializer and apply PCLK.  
Typically this would be the DS90UB925Q EVB.
- 2) If interfacing to 3.3V LVCMOS, skip this step, otherwise:  
when interfacing to 1.8V LVCMOS inputs (downstream device), move factory jumper from pin-2/3 to pin 1 to connect to pin-1/2 and apply 1.8V power to pin 1 of JP1. This will connect the external 1.8V to the DS90UB926Q VDDIO, otherwise skip this step.

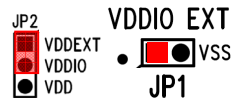

- 3) Apply 3.3V power to the DS90UB926Q VDD.



- 4) Look for the green LED2 to light up on the DS90UB926Q EVB. If the green LED is lit and stable, then the DS90UB926Q is **LOCKED** to the FPD-Link III serial stream. To be absolutely sure the DS90UB926Q is locked, use a scope to monitor off JP6 (pin 1 = LOCK, pin 2 = VSS).



**CONGRATULATIONS, you are up and running!**  
If not continue to the next step...

### 1.4. Trouble Shooting the EVB

- 1) Check power supply polarity!!! Warning: reverse supply polarity can damage the board.
- 2) Check to make sure there is sufficient current by checking that the voltage (3.3V) is correct at J6.
- 3) Check polarity of SER to DES cable interface. e.g. SER DOUT+ is going to RIN+ of DES and vice versa.
- 4) Check to make sure there is a FPD-Link III signal by probing on **both** C10 AND C11.
- 5) Go back to figure 1 and double check factory settings.

## 2. Board Setup Details

This section describes, in detail, the connectors and jumpers on the board as well as how to properly connect, set up, and use the DS90UB926Q EVB.

### 2.1. Power Connections

- 1) Connect ground to J7.
- 2) Connect an external 3.3V into J6. This is the core voltage of the DS90UB926Q.

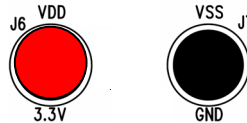

- 3) For VDDIO = 1.8V, connect ground to pin 2 of JP1.
- 4) Connect an external 1.8V into pin 1 of JP1. This is VDDIO power.

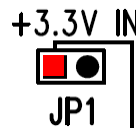

### 2.2. FPD-Link III Connection

**J12, J13** – is the default SMA connector. Apply an FPD-Link III serial stream into J12 and J13. Note: J12 goes to RxIN+, J13 goes to RxIN- of the DS90UB926Q. Typically the serializer will be the DS90UB925Q.

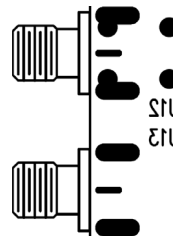

### 2.3. Factory Set Switch Settings and Jumpers Default Configuration

**S1, S2, S3, S4, S5, and JP2** are factory configured as shown in Figure 2 for plug and play operation. For each of these 3-pin headers JP2, a jumper must be placed as shown.

- 1) The S1 switch is factory set as shown below.  
The PDB switch is set *HIGH* and will turn on the DS90UB926Q upon power up.



SW2 is a momentary switch. Instead of toggling switch 1 of S1 to do a PDB toggle, press SW2 to do a PDB toggle.

- 2) The S2 switch is factory set as shown below.  
The OEN and OSS\_SEL switch are set *HIGH* and will enable the DS90UB926Q outputs to toggle upon power up.

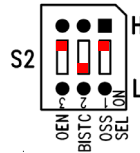

- 3) The S3 and S4 switches are factory set as shown below.  
All switches are set *HIGH* except 58 on S4. This sets IDx address to 58. Note only one switch is allowed *LOW* at a time.

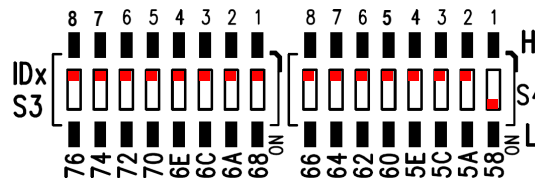

- 4) The S5 switch is factory set as shown below.  
All switches are set *HIGH* except 1. This sets MODE\_SEL address to 1. Note only one switch is allowed *LOW* at a time.

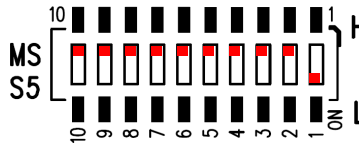

- 5) On JP2, a 2-pin jumper is factory placed as shown below.  
The jumper sets VDDIO to 3.3V. Note 3.3V does not need to be applied externally.



**Figure 2: Factory Switch (S1,S2,S3,S4,S5) and Jumper (JP2) Configuration**

## 2.4. LVCMOS Output Connector Description

**J10 – R[7:0], G[7:0], B[7:0], HS, VS, DE, PCLK** is the output connector for the DS90UB926Q data outputs. These are the LVCMOS outputs of the DS90UB926Q, which are the odd numbered pins (left side pins on the board). The even numbered pins (right side pins on the board) go to pin 2 (labeled “STRAP”) of JP12. The factory configuration has a jumper resistor R145 that ties the even numbered pins (STRAP) to ground.

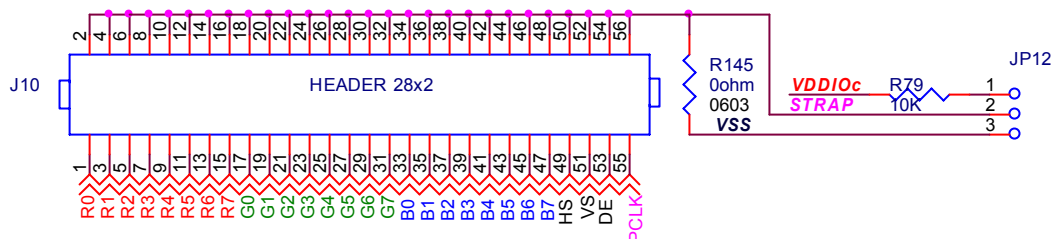

### 3. Appendix – I2C, integrated SPA Dongle

#### 3.1. I2C SPA Dongle Hookup

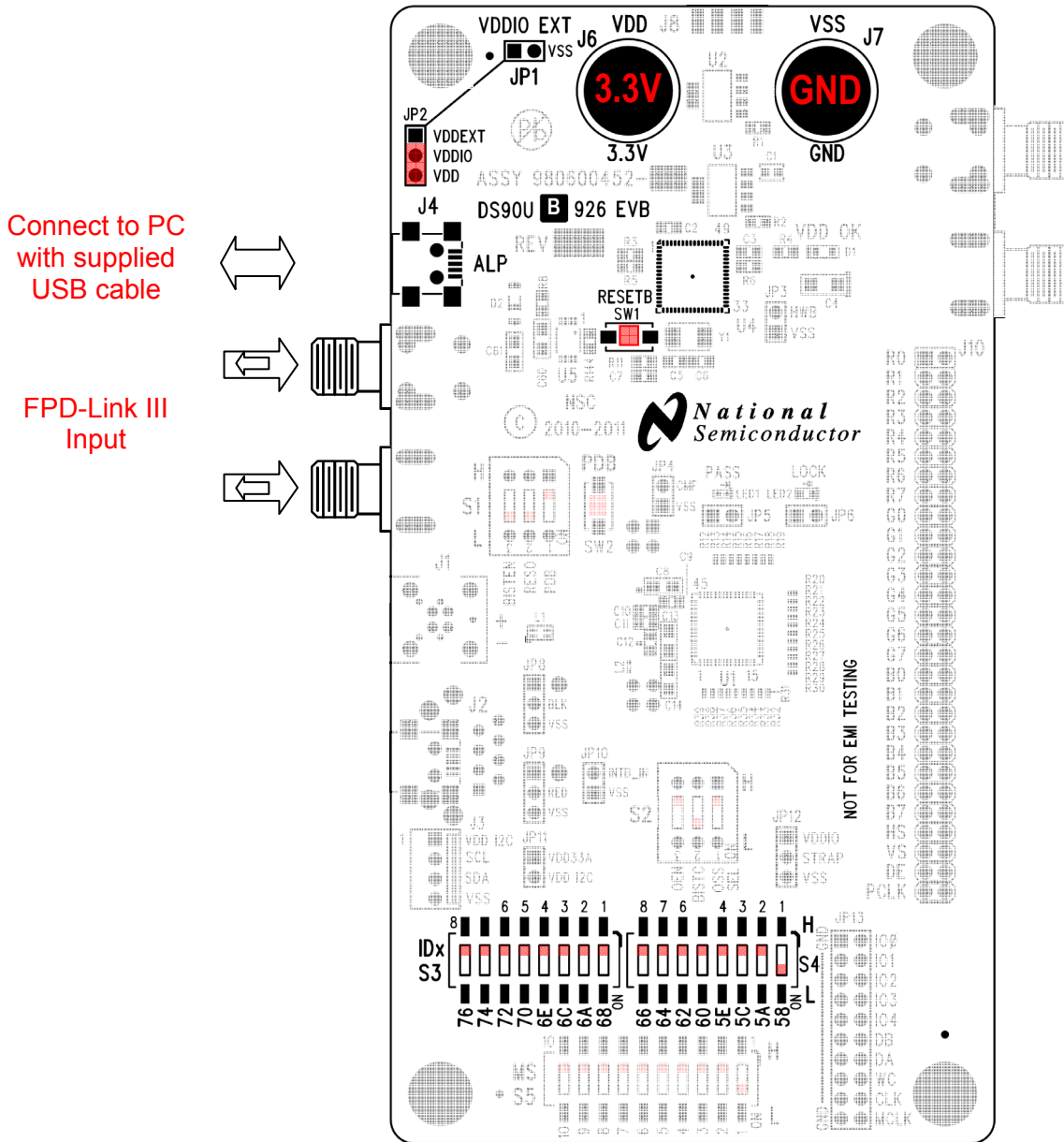

#### 3.2. IDx Board Default Address

The IDx address on the EVB has been preset at 58.

### 3.3. ALP Software Setup

#### 3.3.1. System Requirements

**Operating System:** Windows XP or Vista  
**USB:** 2.0

#### 3.3.2. CD contents

Extract the “ALPF\_XXXXXXXXX\_xxx\_xxxx.exe” file to a temporary location that can be deleted later.

**Make sure J4 on the DS90UB926 is connected to a PC USB port with the supplied USB cable and power is applied to the DS90UB926 EVB**

The following installation instructions are for the Windows XP Operating System.

#### 3.3.3. Installation of the ALP software

Execute the ALP Setup Wizard program called “ALPF\_monthdayyear\_major version\_minor version.exe” that was extracted to a temporary location on the local drive of your PC.

There are 7 steps to the installation once the setup wizard is started:

1. Select the “Next” button.
2. Select “I accept the agreement” and then select the “Next” button.
3. Select the location to install the ALP software and then select the “Next” button.
4. Select the location for the start menu shortcut and then select the “Next” button.
5. There will then be a screen that allows the creation of a desktop and Quick Launch icon. After selecting the desired choices select the “Next” button.
6. Select the “Install” button, and the software will then be installed to the selected location.
7. Uncheck “Launch Analog LaunchPAD” and select the “Finish” button. The ALP software will start if “Launch Analog LaunchPAD” is checked, but it will not be useful until the USB driver is installed.

Connect J4 of the DS90UB926Q EVB board to a PC/laptop with the supplied mini USB cable. Power the DS90UB926Q EVB board with a 3.3 VDC power supply. The “Found New Hardware Wizard” will open on the PC/laptop. Proceed to the next section to install the USB driver.

### 3.3.4. Installation of the USB driver

There are 6 steps to install the USB driver:

1. Select “No, not at this time” then select the “Next” button.
2. Select “Install from a list or specific location” then select the “Next” button.
3. Select “Search for the best driver in these locations”. Uncheck “Search removable media” and check “Include this location in the search”.
4. Browse to the Install Directory which is typically located at “C:\Program Files\National Semiconductor Corp\Analog LaunchPAD\vx.x.x\Drivers” and select the “Next” button. Windows should find the driver.
5. Select “Continue Anyway”.
6. Select the “Finish” button.

The software installation is complete. The ALP software may now be launched, as described in the next section.

### 3.3.5. Startup - Software Description

Make sure all the software has been installed and the hardware is powered on and connected to the PC. Execute “Analog LaunchPAD” from the start menu. The default start menu location is “Programs\National Semiconductor Corp\Analog LaunchPAD vx.x.x\Analog LaunchPAD”.





The application should come up in the state shown in the figure below. If it does not, see “Trouble Shooting” at the end of this document.

Under the Devices tab click on “DS90UB926” to select the device and open up the device profile and its associated tabs.

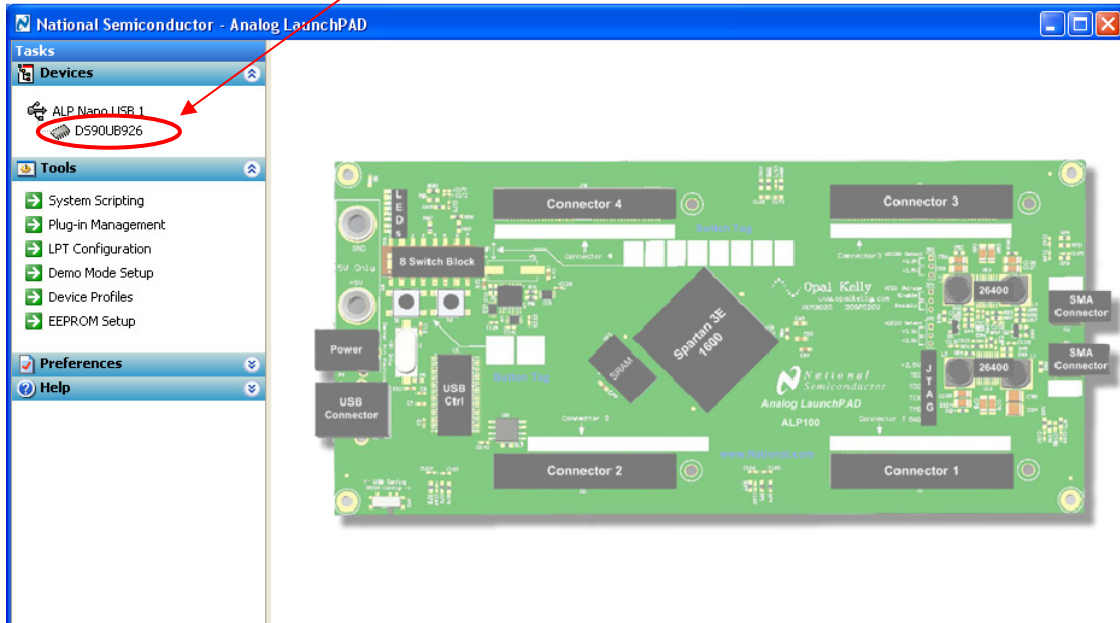

**Figure 3: Initial ALP Screen**

After selecting the DS90UB926, the following screen should appear.

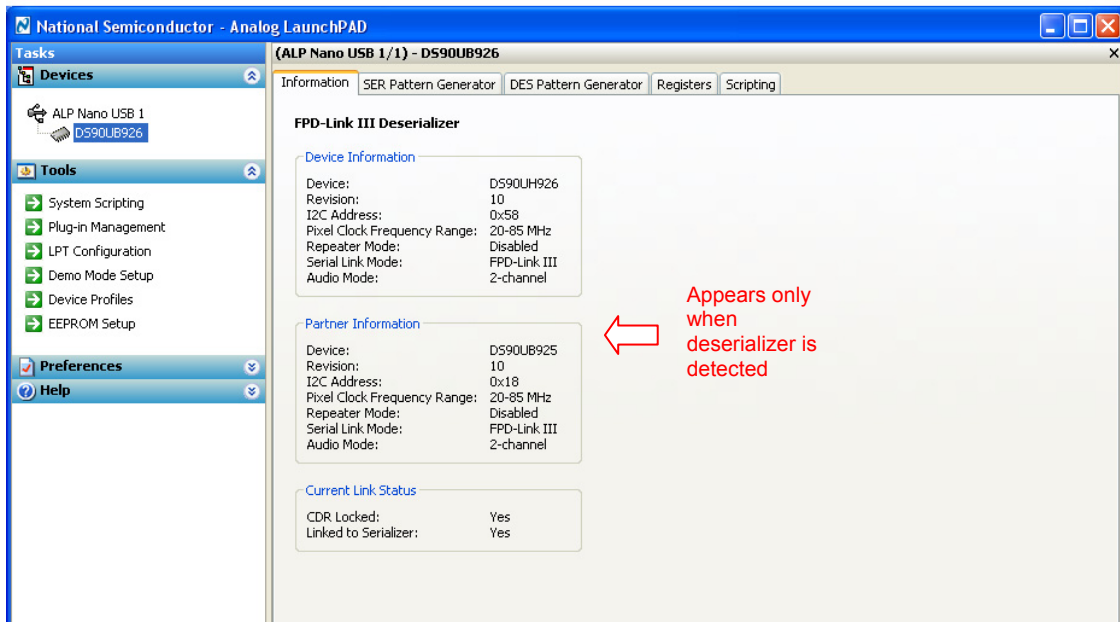

## Information Tab

The Information tab is shown below. Please note the device revision could be different.

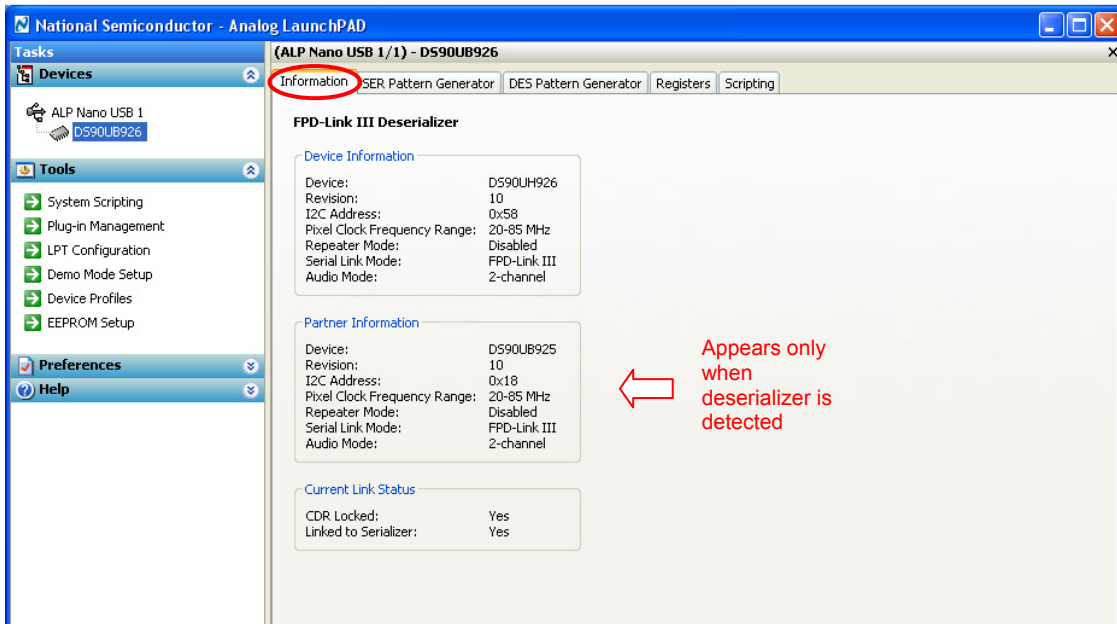

## SER Pattern Generator Tab

The SER Pattern Generator tab is shown below.

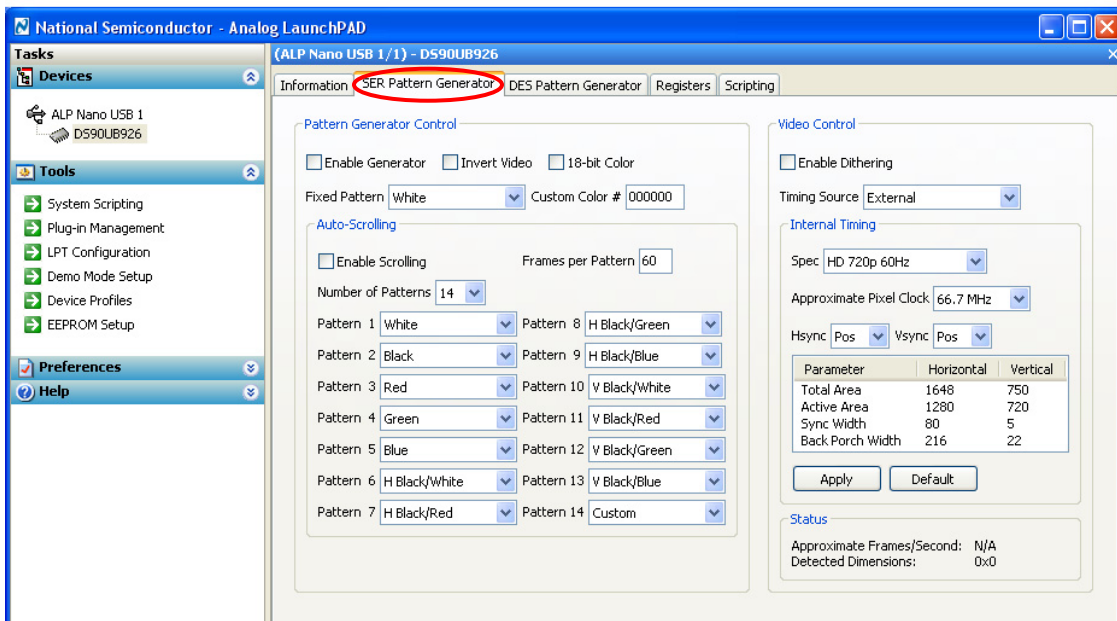

## DES Pattern Generator Tab

The DES Pattern Generator tab is shown below.

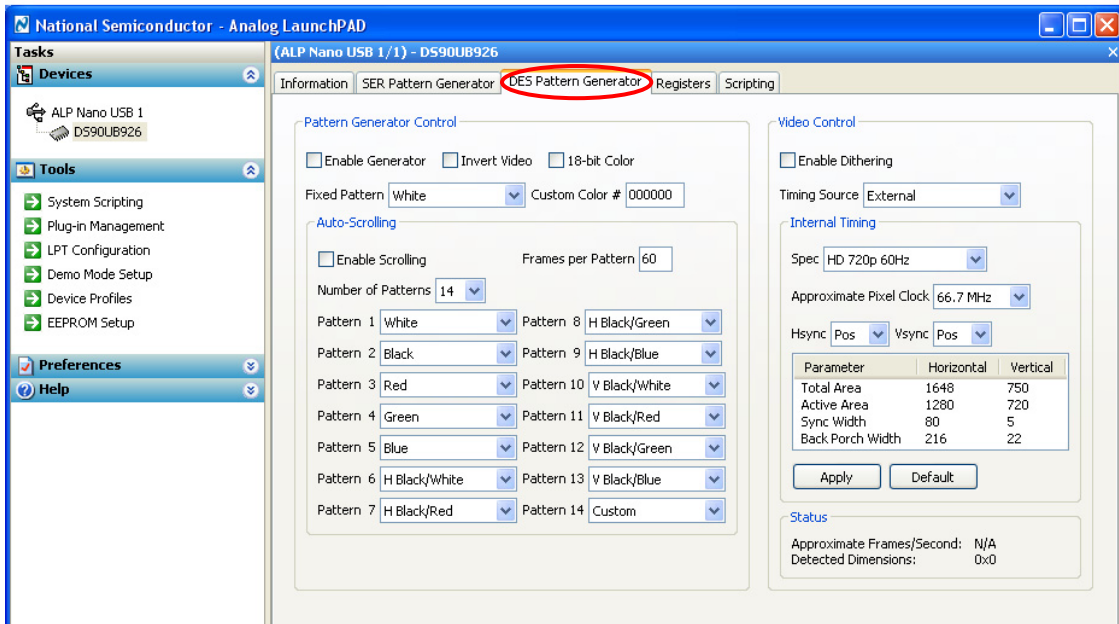

## Registers Tab

The Registers tab is shown below.

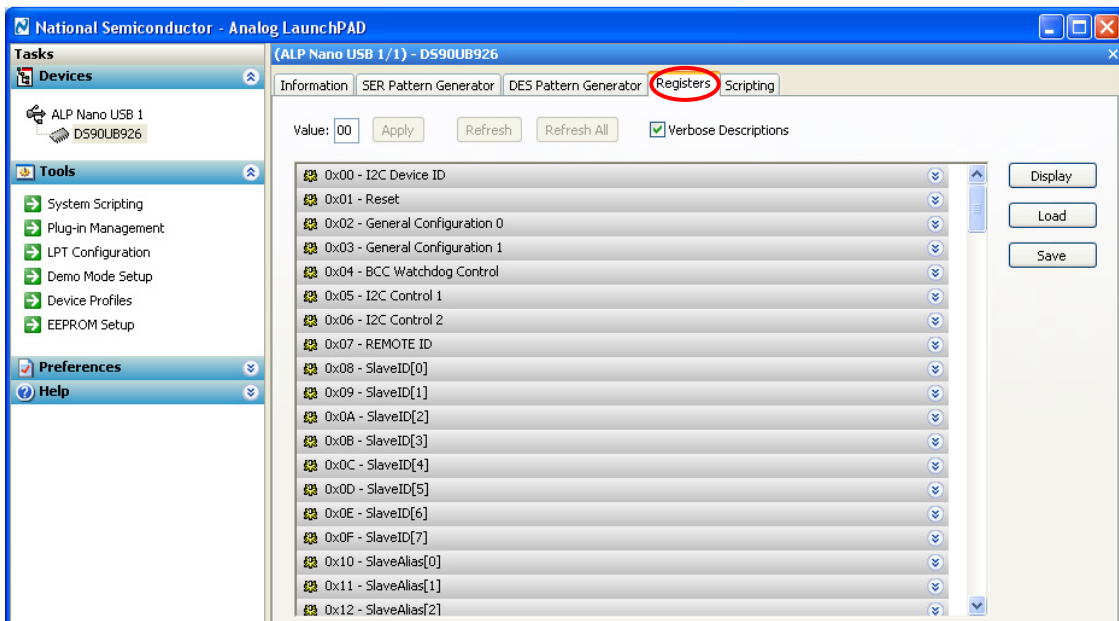

## Registers Tab – Address 0x00 selected

Address 0x00 selected as shown below. Note that the “Value:” box, Value: 58, will now show the hex value of that register.

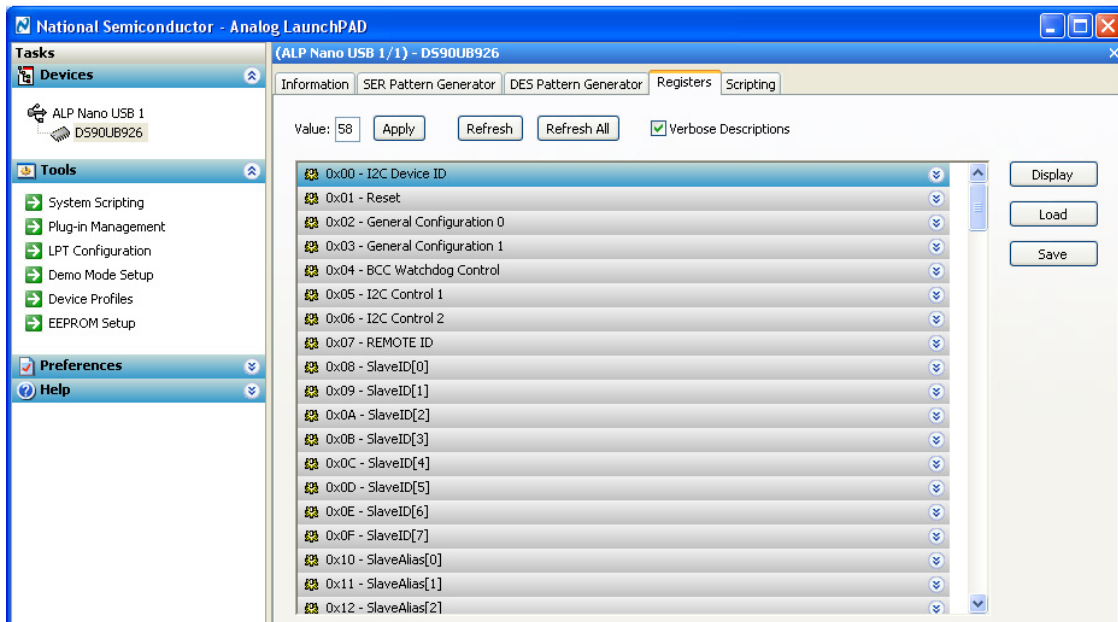

## Registers Tab – Address 0x00 expanded

By double clicking on the Address bar



or a single click on  Address 0x00 expanded reveals contents by bits. Any register address displayed can be expanded.

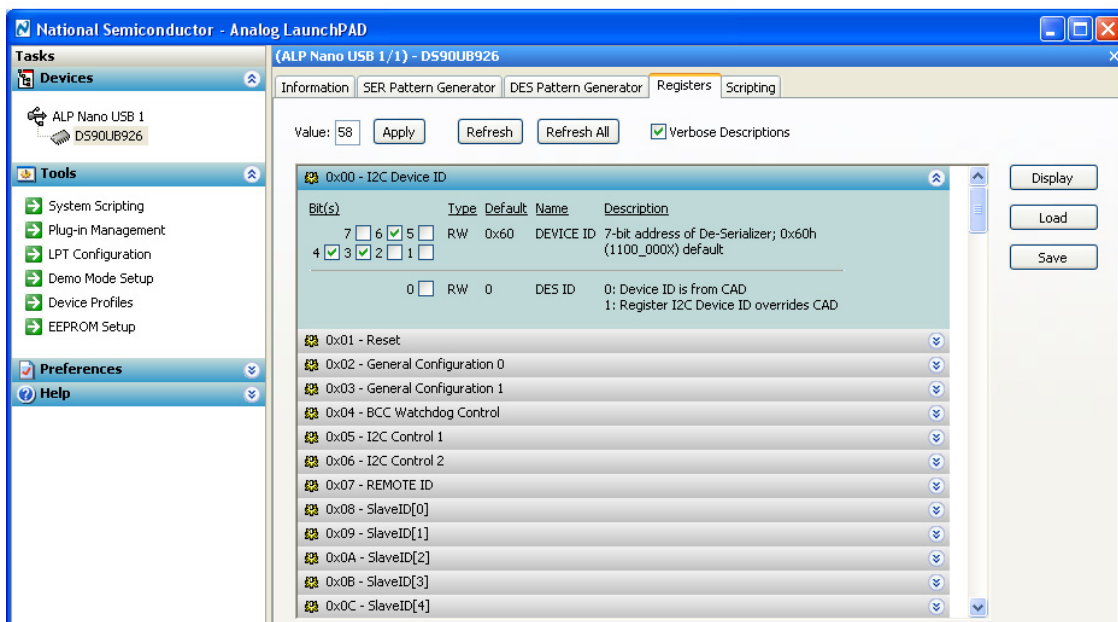

**Type**

Any RW Type register, **RW**, can be written into by writing the hex value into the “Value:” box, Value:  or putting the pointer into the individual register bit(s) box by a left mouse click to put a check mark (indicating a “1”) or unchecking to remove the check mark (indicating a “0”). Click the “Apply” button to write to the register, and “refresh” to see the new value of the selected (highlighted) register.

Bit(s)								
	7	<input type="checkbox"/>	6	<input checked="" type="checkbox"/>	5	<input type="checkbox"/>		
4	<input checked="" type="checkbox"/>	3	<input checked="" type="checkbox"/>	2	<input type="checkbox"/>	1	<input type="checkbox"/>	
							0	<input type="checkbox"/>

The box toggles on every mouse click.

## Scripting Tab

The Scripting tab is shown below. Usage is not described in this document.

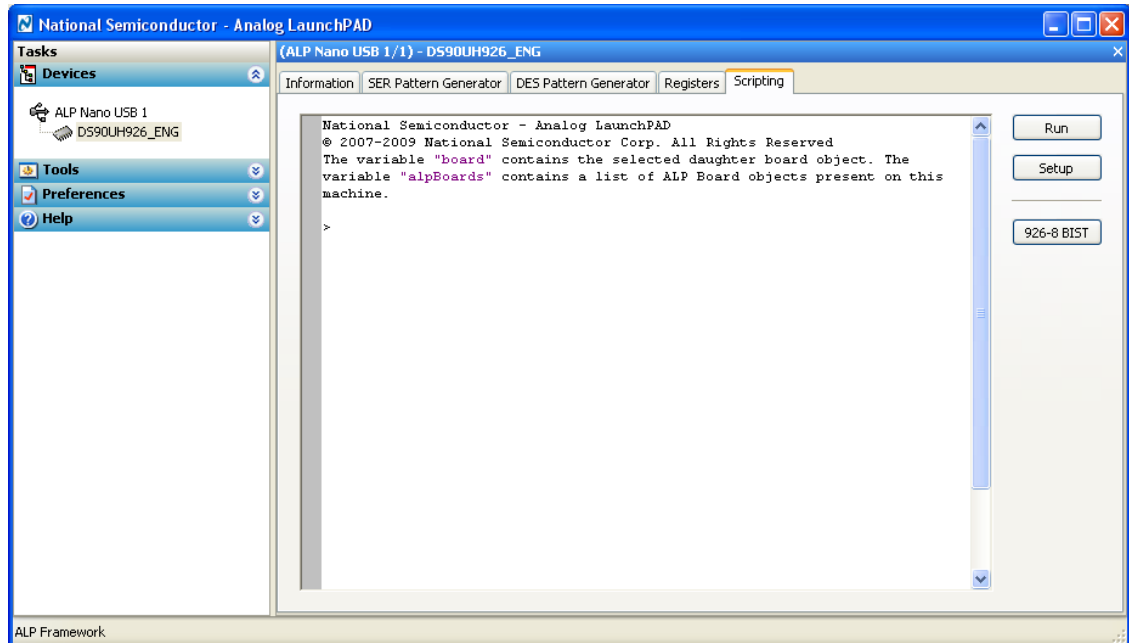

### 3.3.6. Trouble Shooting ALP Software

If the following window opens after starting the ALP software, double check the hardware setup.

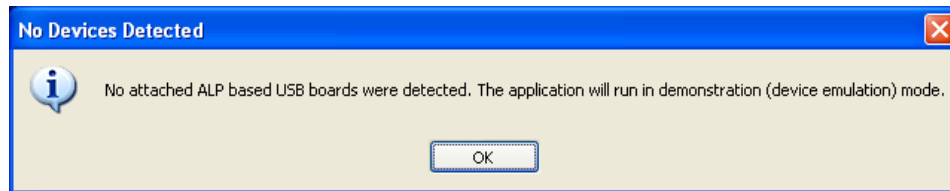

#### Analog LaunchPAD No Devices Error

It may also be that the USB driver is not installed. Check the device manager. There should be an “NSC ALP Nano Atmel” device under the “Universal Serial Bus Controllers” as shown below.

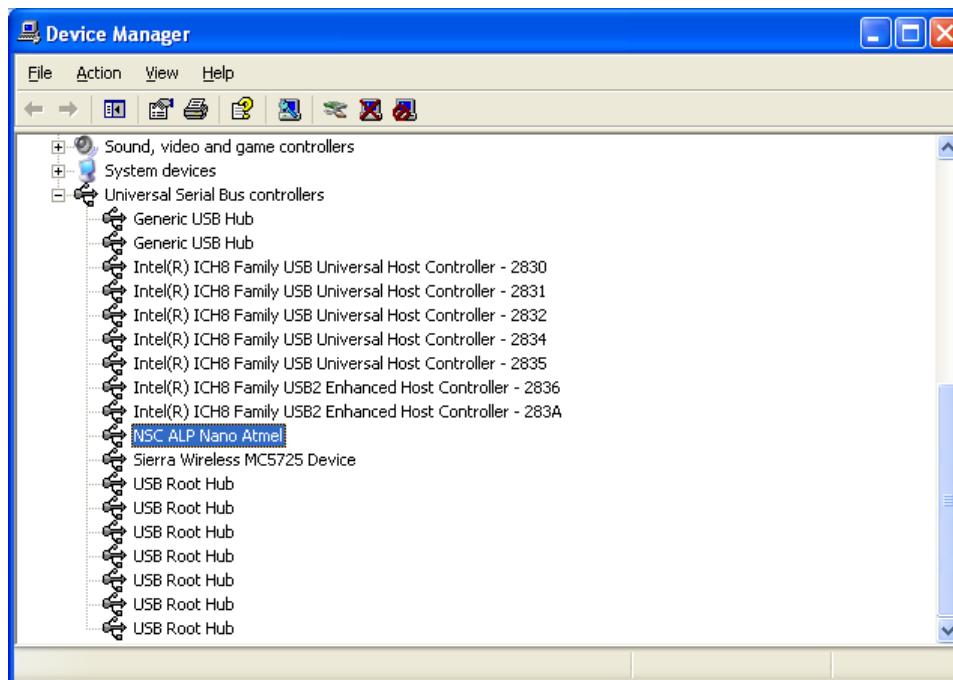

#### Windows XP, Analog LaunchPAD USB Driver

The software should start with only “DS90UB926Q” in the “Devices” pull down menu. If there are more devices then the software is most likely in demo mode. When the ALP is operating in demo mode there is a “(Demo Mode)” indication in the lower left of the application status bar as shown below.

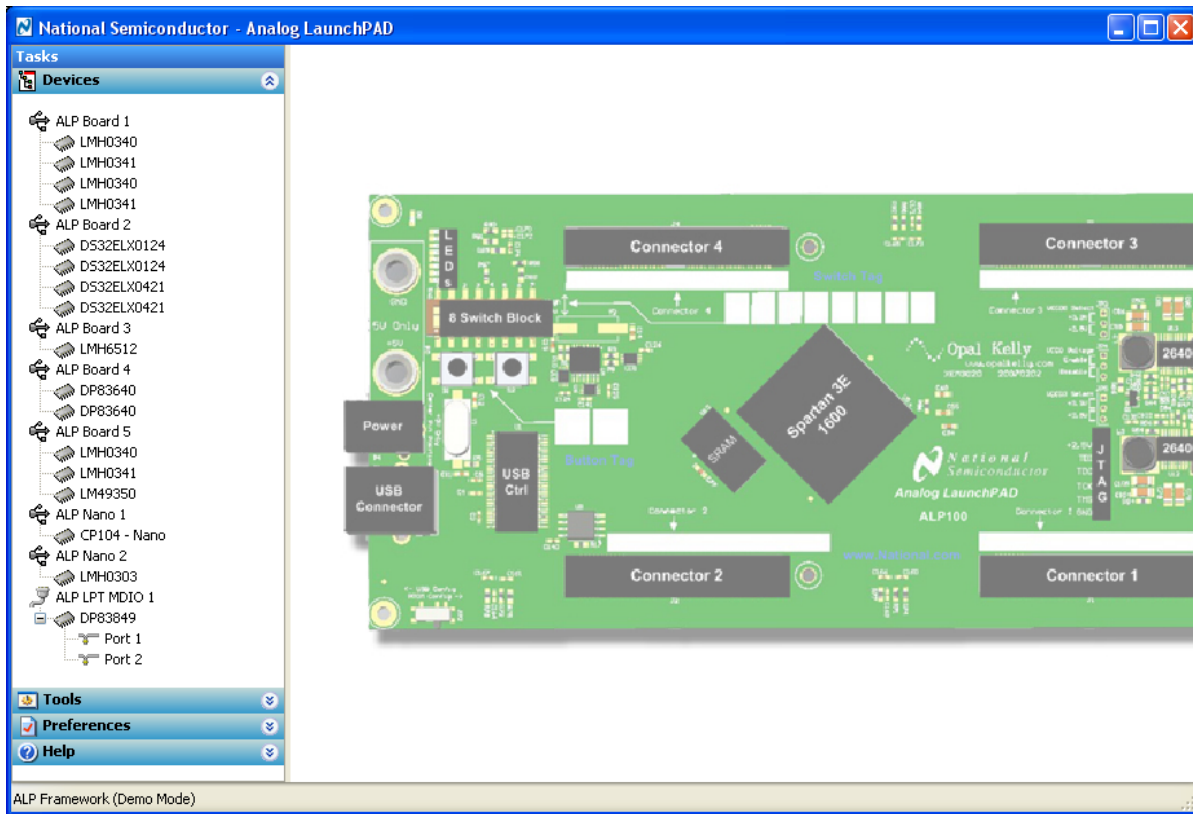

### Analog LaunchPAD in Demo Mode

Disable the demo mode by selecting the “Preferences” pull down menu and unchecking “Enable Demo Mode”.

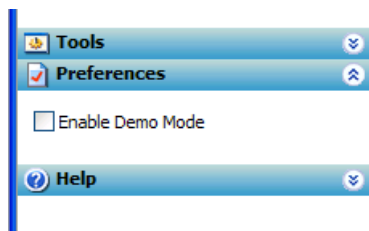

### Analog LaunchPAD Preferences Menu

After demo mode is disabled, the ALP software will poll the ALP hardware. The ALP software will update and have only “DS90UB926Q” under the “Devices” pull down menu.

#### 4. Eye Monitor – CMLOP/N

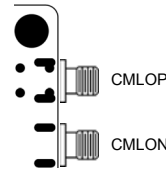

Top view of CML access points (upper right hand side of EVB when looking at the front side of the EVB). Connector J15 connects CMLOP and J16 connects to CMLON.

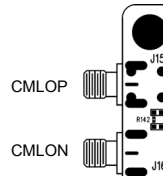

Bottom view of CML access points (upper left hand side of the EVB when looking at the back side of the EVB).

CMLOP/N must be enabled by register,  $0x56[3] = 0$ , to be able to monitor the FPD-Link III serial stream.

#### 5. Appendix – Use of optional Rosenberger HSD connector (J1)

Unpopulate R68 and R71 0201 sized  $0\Omega$  resistor. R68 and R71 pads are on the back side of the EVM. This will cut the stub traces to J12 and J13 (SMAs). Populate J1 (Rosenberger HSD connector).

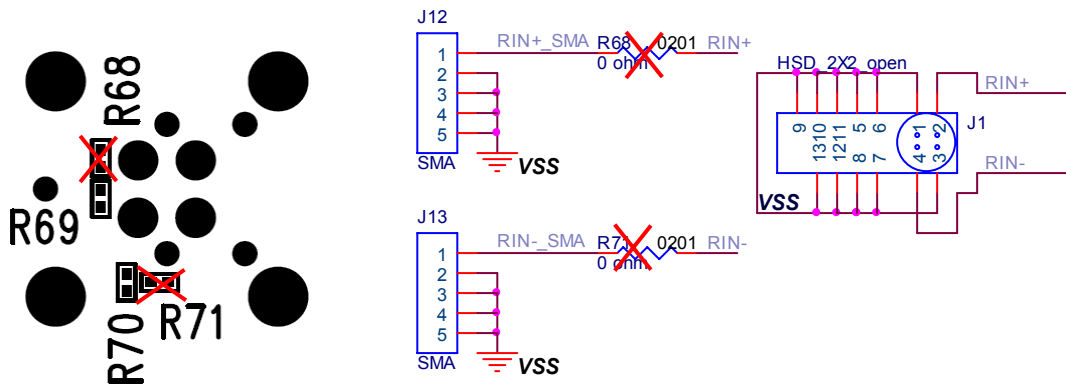



## 6. Appendix – Use of optional mini-B USB connector (J2)

Use this option when connecting to standard DS90UR905Q EVB.

Populate R69 and R70 with 0201 sized  $0\Omega$  resistor (suggest Panasonic ERJ-1GE0R00C or equivalent). R69 and R70 pads are on the back side of the EVM under J1. This will connect J2. Ideally, J1 (Rosenberger HSD connector) should be removed to eliminate the stub.

Warning: R68 and R71 should not be populated when using J2.

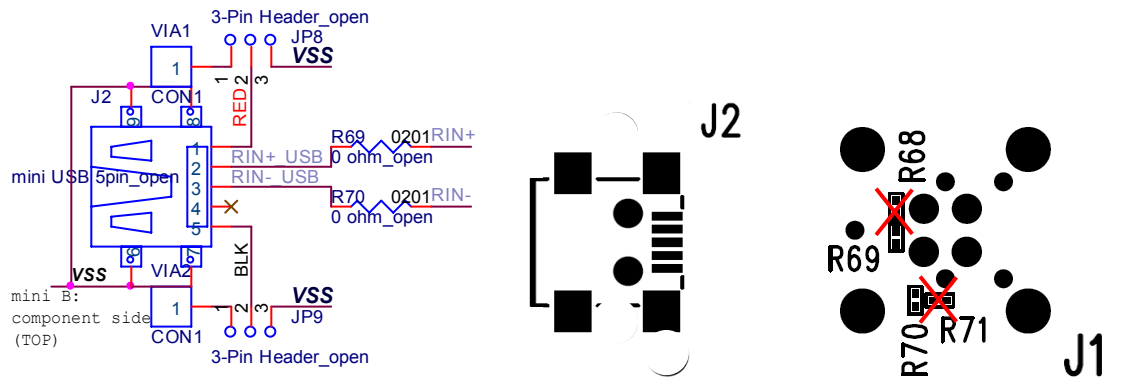

Add a two pin jumper on JP8 and JP9; this will ground the unused wires in the USB cable.

## 7. Appendix - Board Layout

Figure 5, Figure 6, Figure 7, and Figure 8 show the board layout for the DS90UB926Q EVB.

The DS90UB926Q is a 4-layer board (TOP / GND / PWR / BOTTOM). The  $50\Omega$  microstrip trace on the top layer of the board is referenced to GND, and the  $100\Omega$  differential traces are referenced to GND.

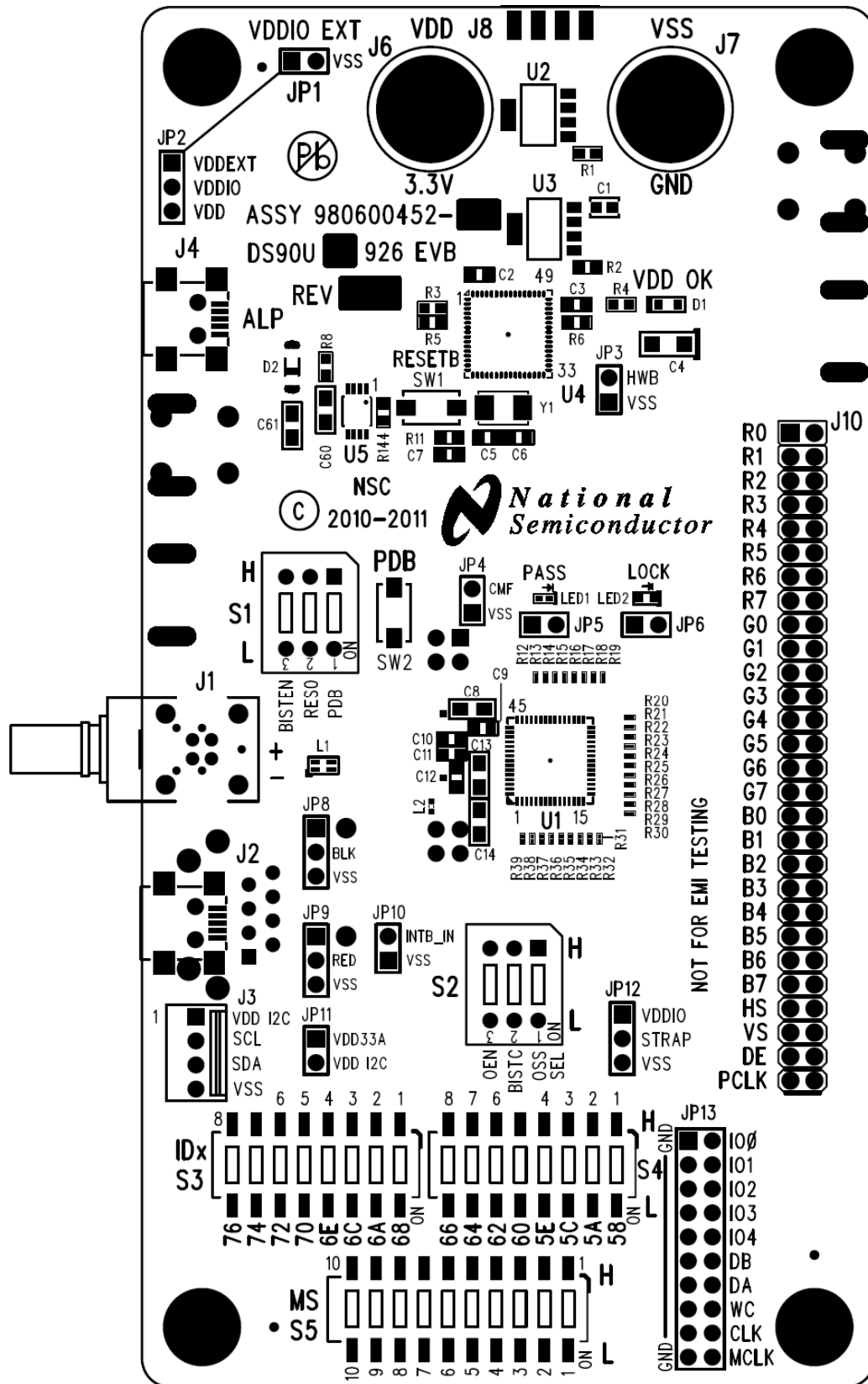

Figure 4: TOP View

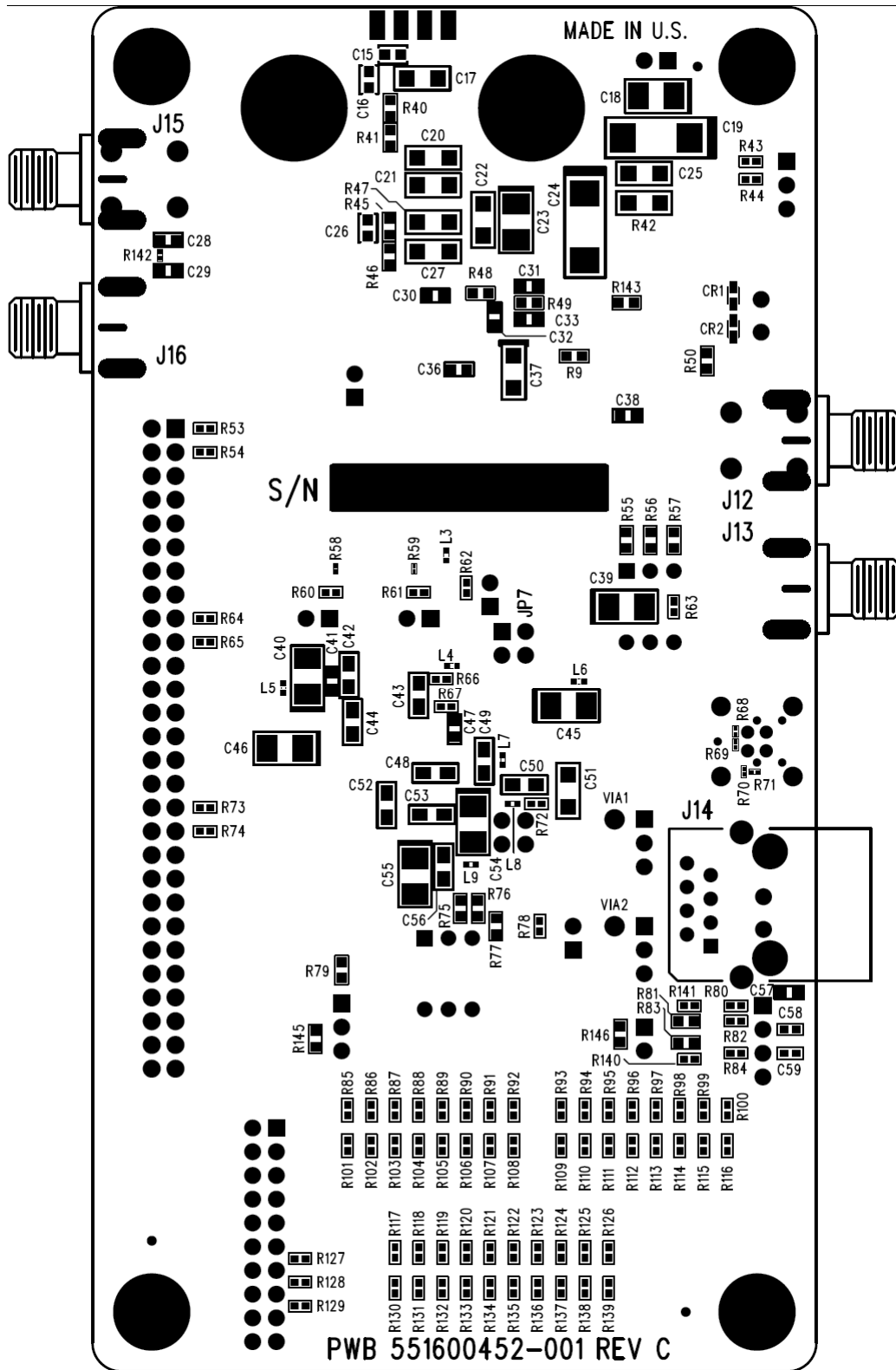

Figure 5: Bottom View

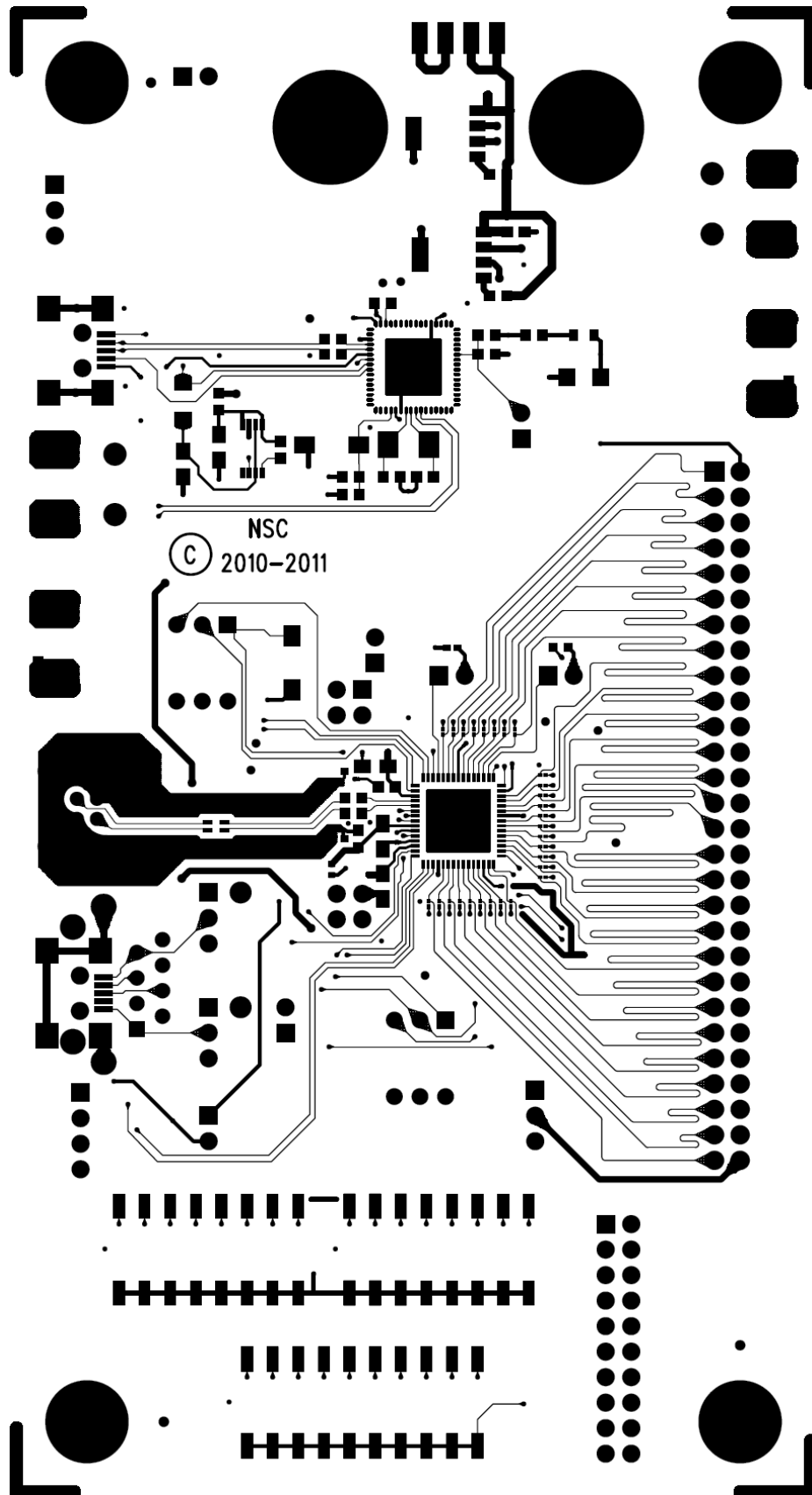

Figure 6: TOP Layer

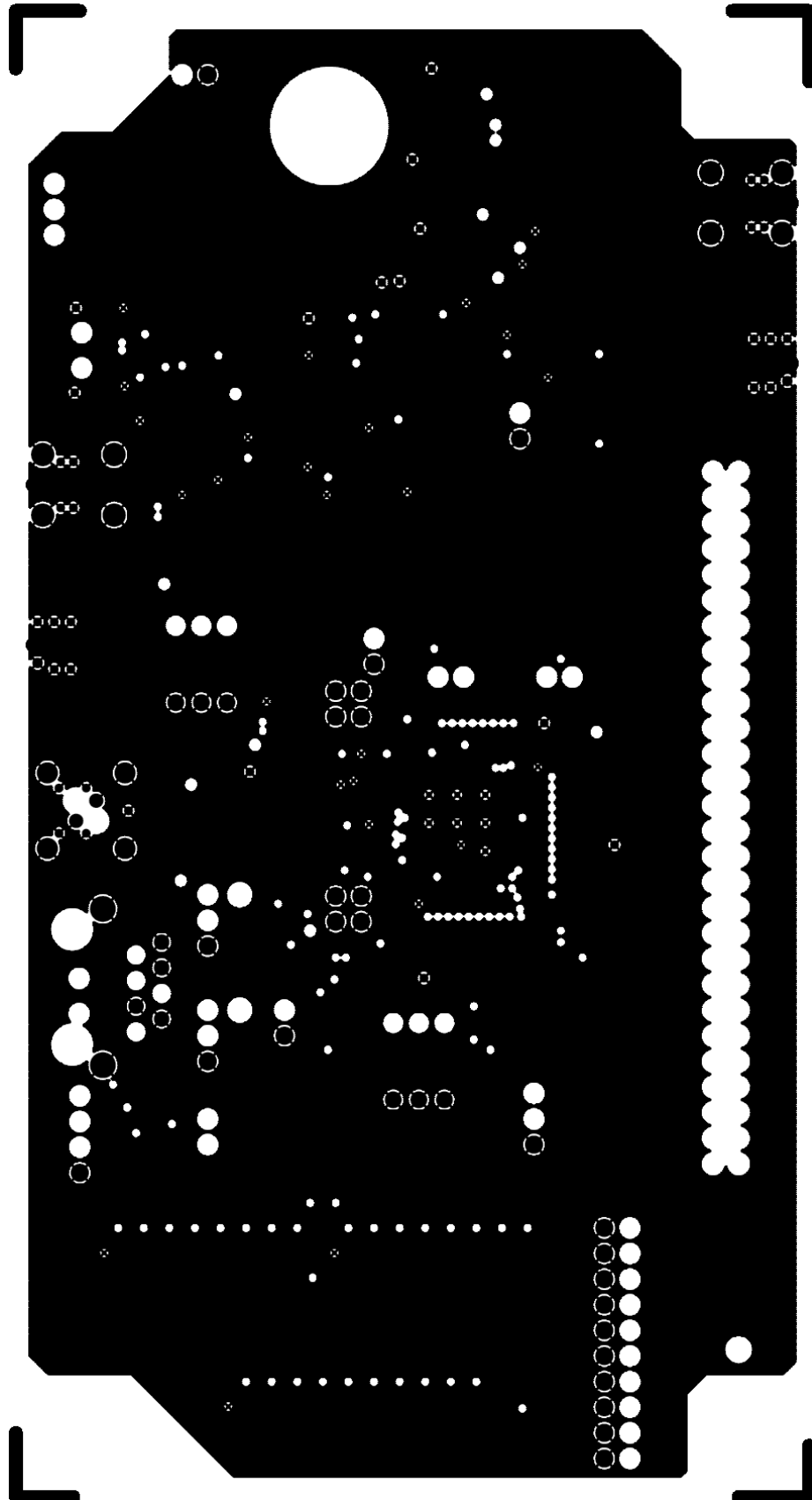
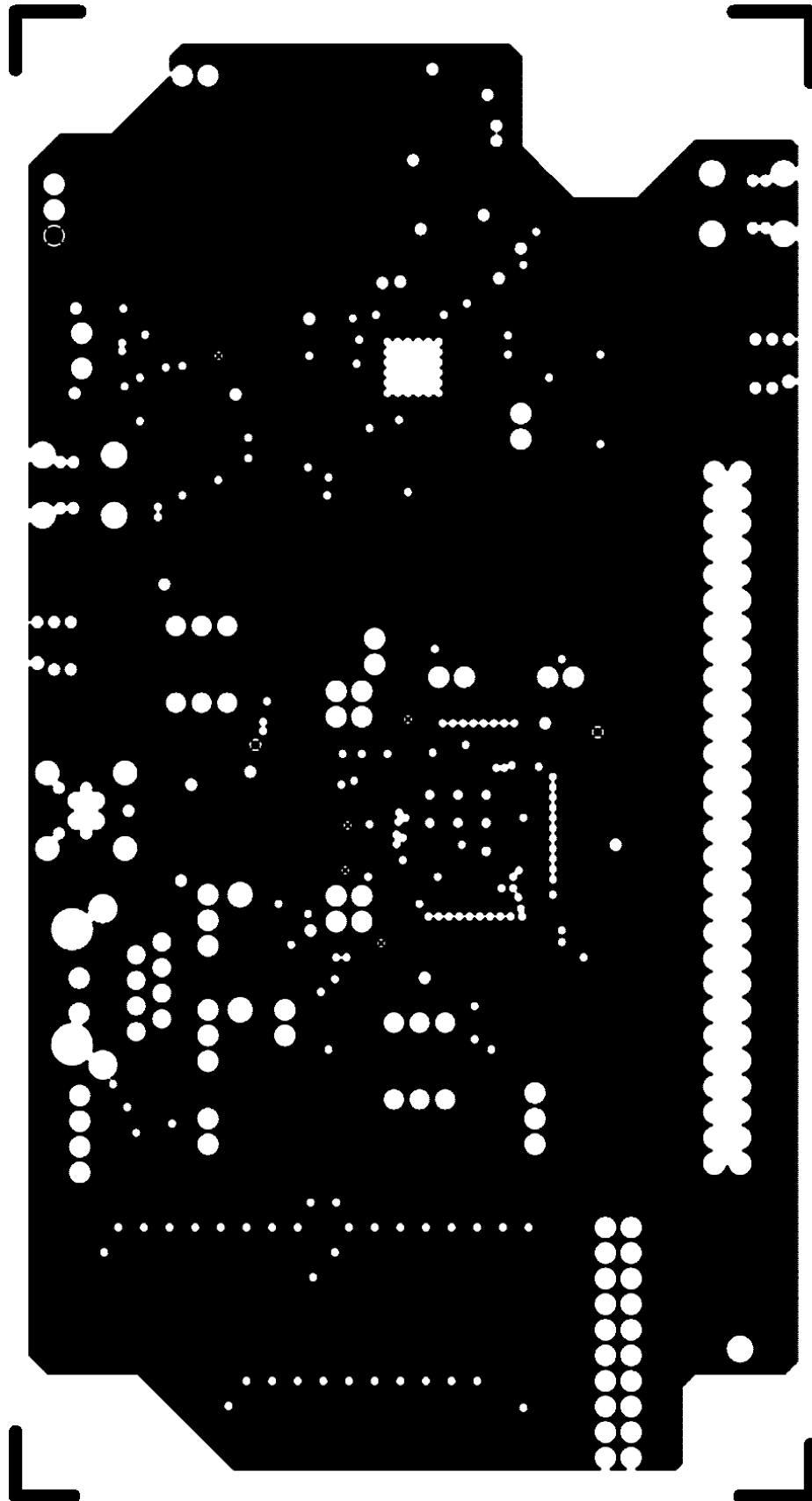

Figure 7: GND Layer



**Figure 8: PWR Layer**

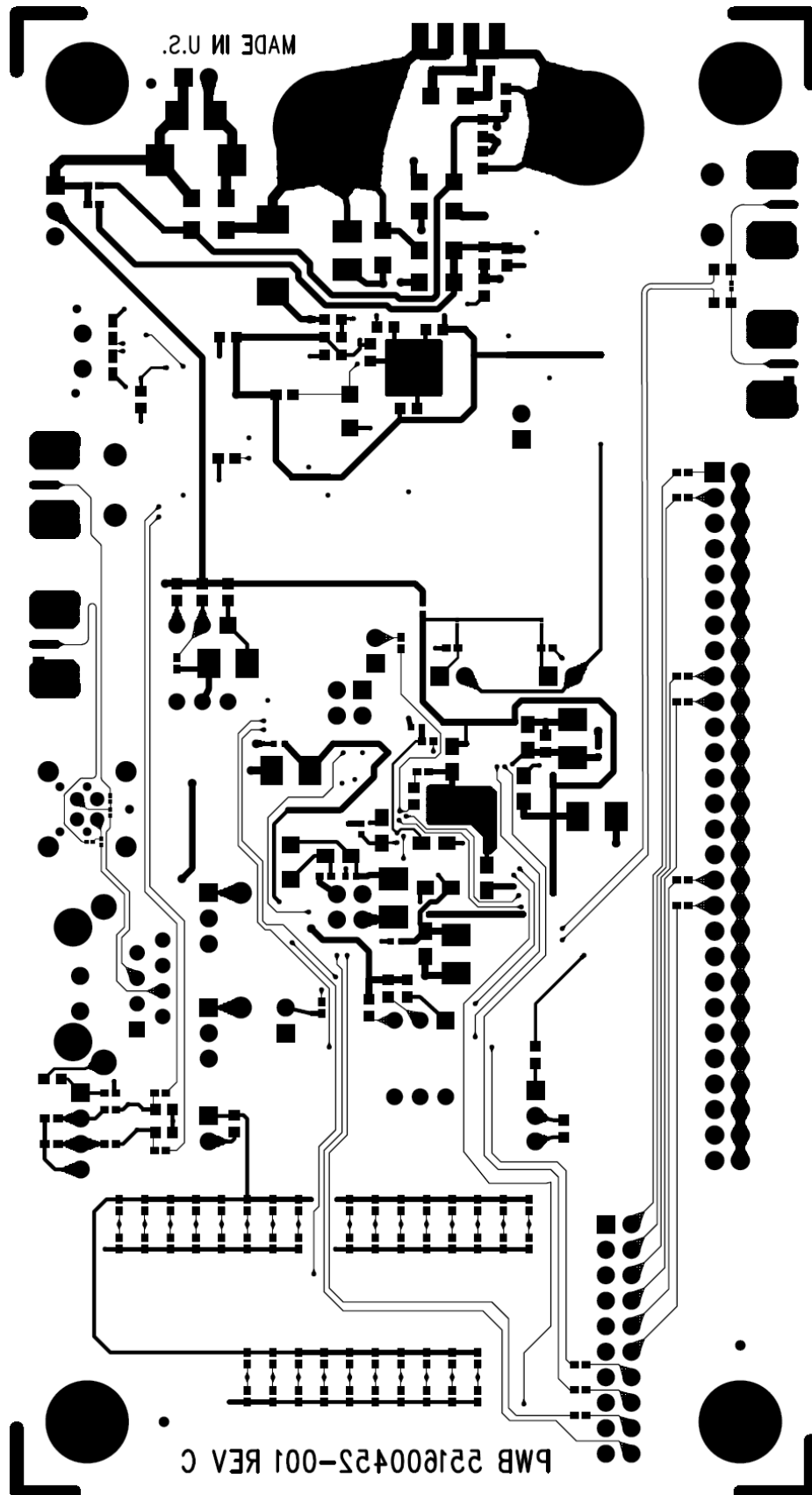
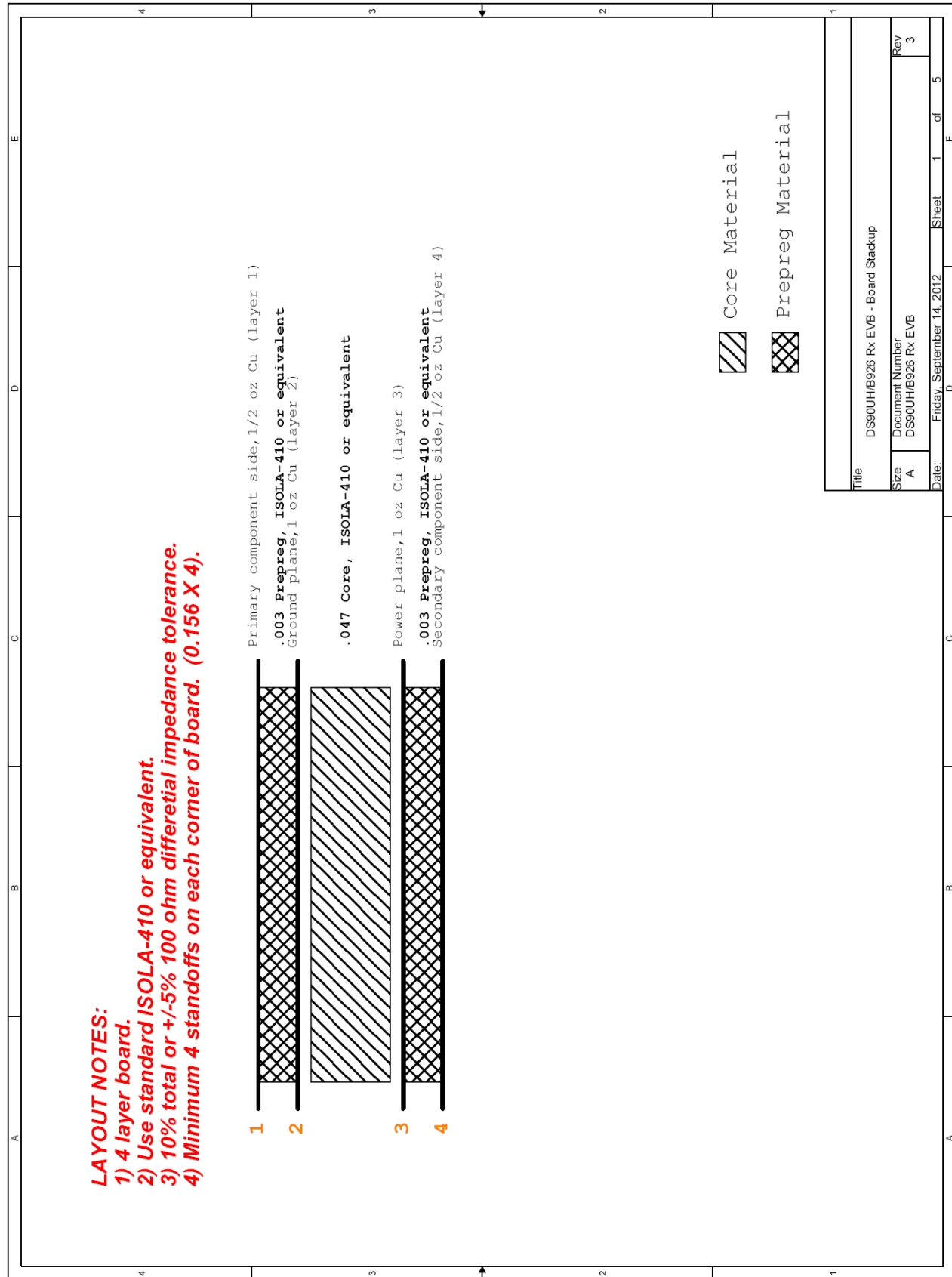

Figure 9: BOTTOM Layer

## 8. Schematic







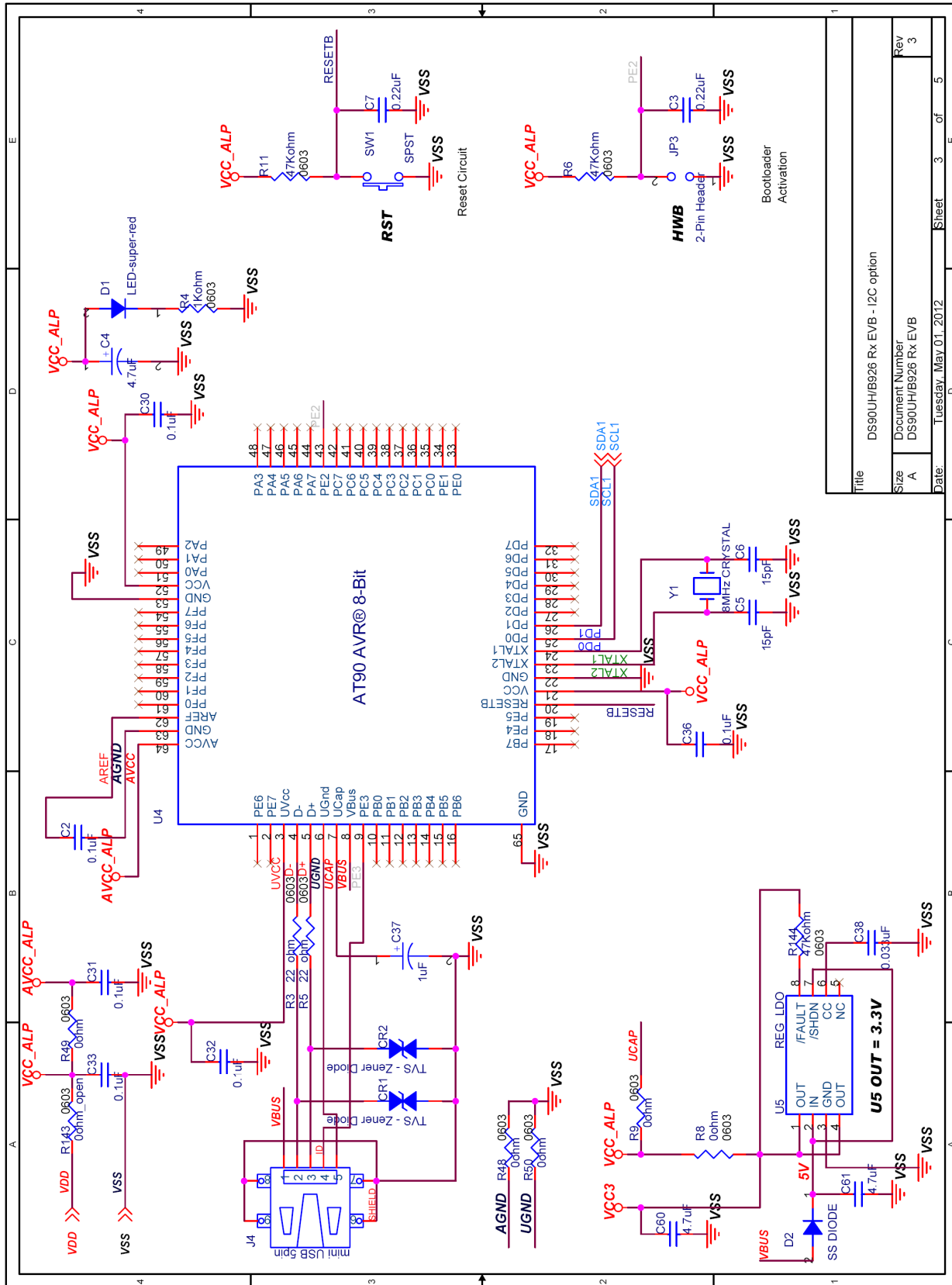

Title		DS90UB926 Rx EVB - I2C option		
Size	Document Number	DS90UB926 Rx EVB		
A	Rev	3		
Date:	Tuesday, May 01, 2012	Sheet	3	of 5

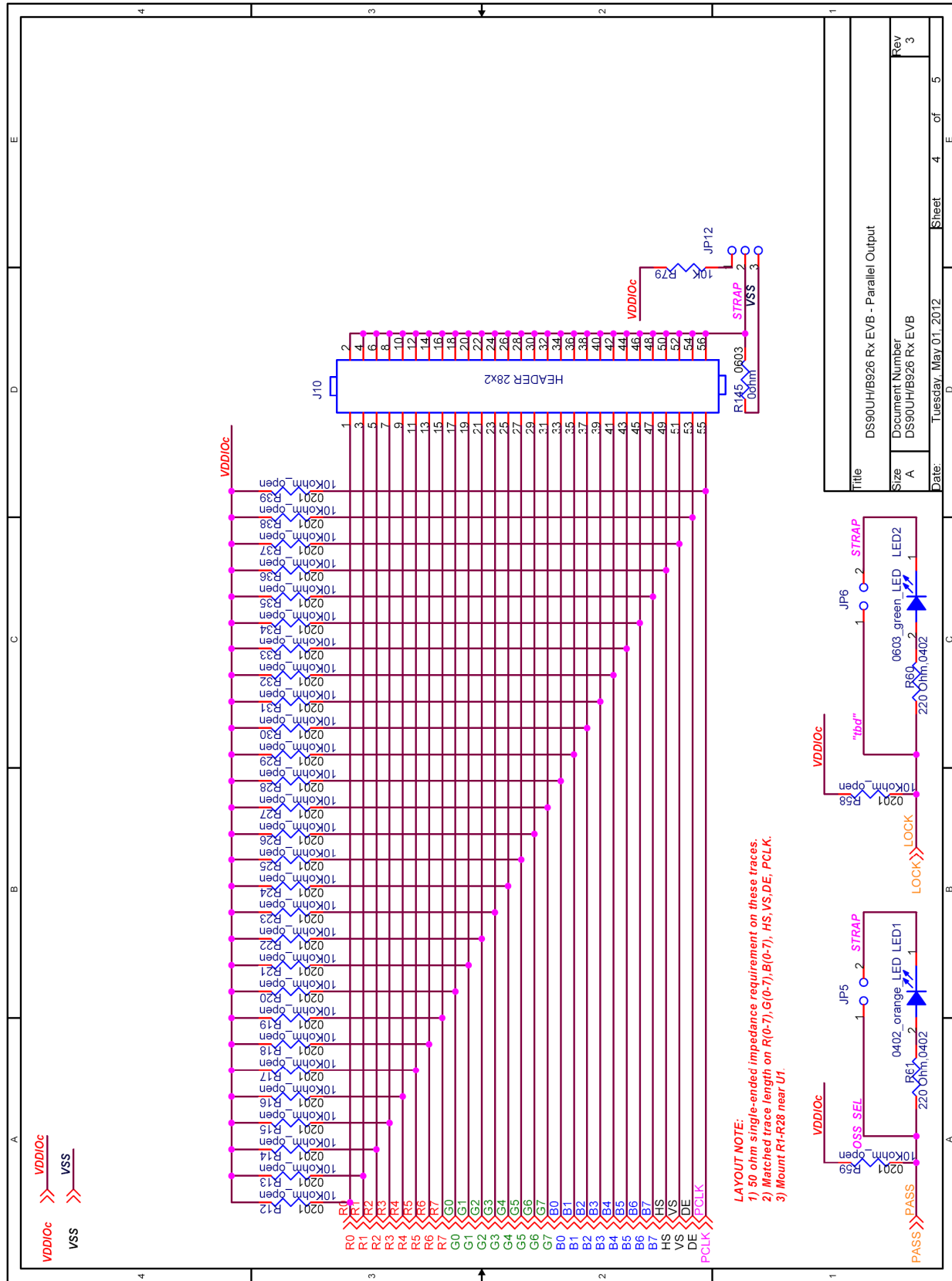

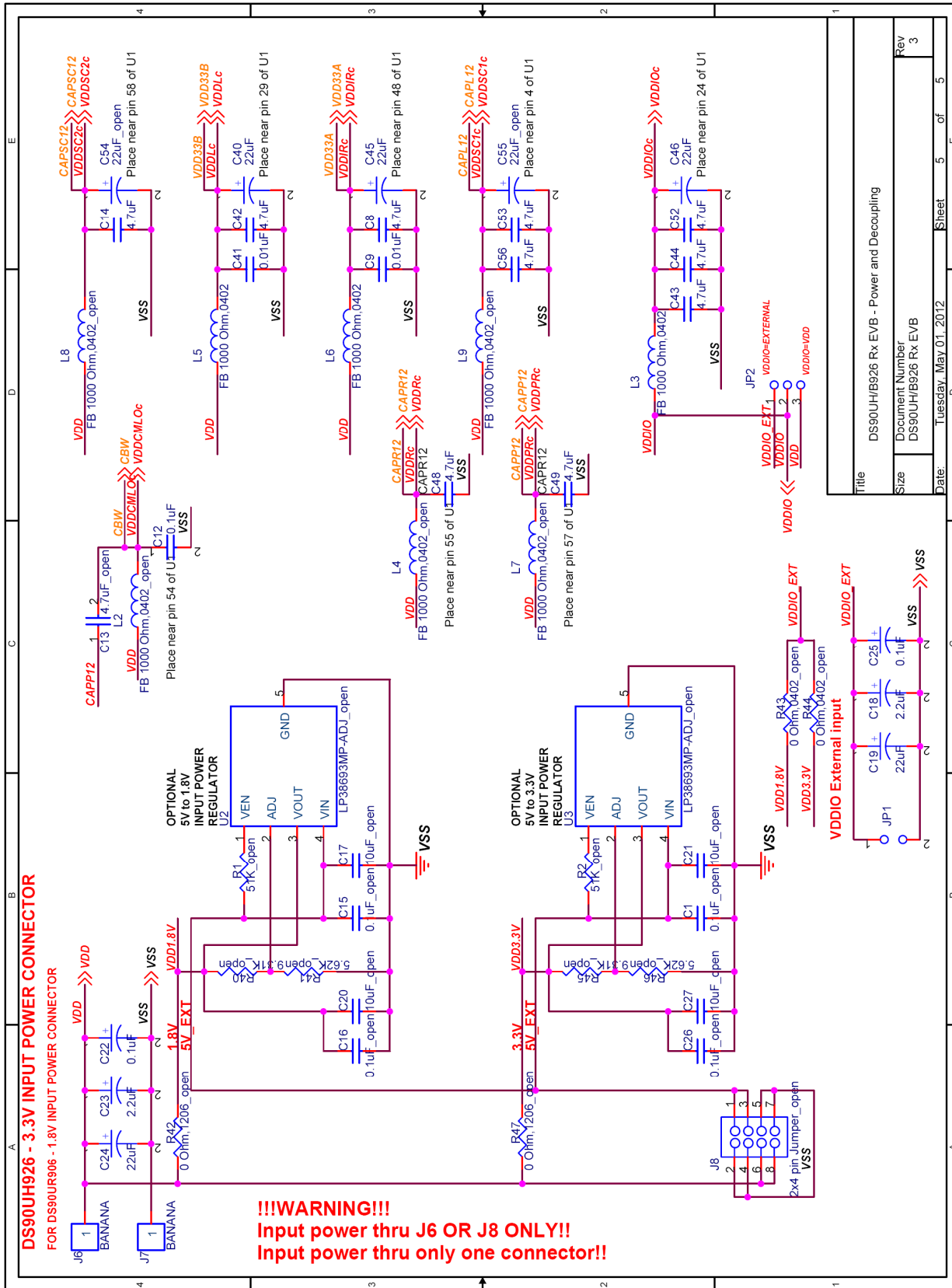

## 9. Bill of Materials

Qty	Reference	Part	PCB Footprint	Comments	MFR	MFR Part#
		DS90UH/B926 Rx EVB	Revision: 3			
		Bill Of Materials				
2	CR2,CR1	TVS - Zener Diode	0603 [1608 metric]	SUPPRESSOR ESD 24VDC 0603 SMD	Littelfuse Inc	PGB1010603MR
6	C2,C30,C31,C32,C33,C36	0.1uF	CAP/HDC-0603	CAP CER .1UF 50V 10% X7R 0603	Murata Electronics	GRM188R71H104KA93D
2	C7,C3	0.22uF	CAP/HDC-0603	CAP CER .22UF 50V Y5V 0603	TDK Corporation	C1608Y5V1H224Z
1	C4	4.7uF	CAP/3216-18 (EIA) 1206	CAPACITOR TANT 4.7UF 16V 10% SMD	Kemet	T491A475K016AT
2	C5,C6	15pF	CAP/HDC-0603	CAP CERAMIC 15PF 50V NPO 0603	Kemet	C0603C150J5GACTU
12	C8,C14,C42,C43,C44,C48,C49,C52,C53,C56,C60,C61	4.7uF	CAP/HDC-0805	CAP CER 4.7UF 16V X7R 0805	Murata	490-5332-1-ND
2	C41,C9	0.01uF	CAP/HDC-0603	CAP CERAMIC .01UF 100V X7R 0603	KEMET	C0603C103K1RACTU
4	C10,C11,C12,C47	0.1uF	CAP/HDC-0603	CAP CER .1UF 50V X7R 0603	Murata	GCM188R71H104KA57D
2	C18,C23	2.2uF	3528-21_EIA	CAPACITOR TANT 2.2UF 20V 10% SMD	KEMET	T491B225K020AT
2	C19,C24	22uF	CAP/N	CAP TANTALUM 22UF 25V 20% SMD	nichicon	F931E226MNC
2	C22,C25	0.1uF	CAP/HDC-1206	CAP .10UF 50V CERAMIC X7R 1206	KEMET	C1206C104K5RACTU
2	C28,C29	0.1uF	CAP/HDC-0603	CAP CERAMIC .1UF 50V X7R 0603	Panasonic	ECJ-1VB1H104K
1	C37	1uF	CAP/3216-18 (EIA) 1206	CAPACITOR TANT 1.0UF 16V 10% SMD	Kemet	T491A105K016AT
1	C38	0.033uF	CAP/HDC-0603	CAP CERM 33000PF 5% 50V X7R 0603	AVX Corporation	0603C3331AT2A
4	C39,C40,C45,C46	22uF	CAP/EIA-B 3528-21	CAPACITOR TANT 22UF 16V 20% SMD	Kemet	T494B226M016AT
1	C50	4.7uF	CAP/HDC-0805	CAP CER 4.7UF 16V X7R 0805	Murata	GCM21BR71C475KA73L
1	C57	0.1uF	CAP/HDC-0603	CAP .1UF ±10% 25V CERAMIC X7R 0603	Panasonic	ECJ-1VB1E104K
2	C59,C58	4.7pF	CAP/HDC-0402	CAP CERAMIC 4.7PF 25V C0G 0402	Panasonic	ECD-G0E4R7C
1	D1	LED-super-red	SMT/0805 (2012 Metric)	LED TOPLED 630NM SUP RED CLR SMD	Osram Opto Semiconductors Inc	LS M67K-H2L1-1-0-2-R18-Z
1	D2	SS DIODE	MELF (LL-34)	DIODE HI CONDUCTANCE 100V LL-34	Fairchild Semiconductor Corporation	FDL4148
2	JP1,JP3	2-Pin Header	Header/2P	CONN HEADER VERT .100 2POS 30AU	AMP/Tyco	87220-2
1	JP2	3-Pin Header	Header/3P	CONN HEADER VERT .100 3POS 15AU	Tyco	87224-3
1	JP13	2X10-Pin Header	Header/2X10P	CONN HEADER VERT .100 20POS 30AU	AMP/TYCO	87215-7
1	J3	IDC1x4	IDC-1x4	CONN HEADER 4POS .100 VERT GOLD	Electronics Corp	22-11-2042
1	J4	mini USB 5pin	mini_USB_surface_mount	CONN RECEPT MINI USB2.0 5POS	Hirose	UX60-MB-5ST
2	J6,J7	BANANA	CON/BANANA-S	BANANA-female (non-insulated)	Johnson	108-0740-001
1	J10	HEADER 28x2	2x28 0.1"	CONN HEADER VERT 56POS .100 30AU. Cut 60 POS or use AMP part #2-87215-9.	AMP/TYCO	3-87215-0
4	J12,J13,J15,J16	SMA	Edge mount	End Launch Jack Receptacle - Tab Contact	Johnson Components	142-0701-851
1	LED1	0402_orange_LED	0402 SMT	LED ORN/CLEAR 610NM 0402 SMD	Lumex Opto/Components Inc	SML-LX04025OC-TR
1	LED2	0603_green_LED	0603 [Super Thin]	LED GREEN CLEAR THIN 0603 SMD	Lite-On Inc	L1ST-C191GKT
1	L1	2 = 90 ohm	L/HDC-0805	CHOKO COIL COMMON MODE 280MA SMD	Murata	DLW215N900H02L
3	L3,L5,L6	FB 1000 Ohm,0402	RES_HDC-0402	FERRITE CHIP 1000 OHM 0402	Murata	BLM15AX1025N1D
2	R3,R5	22 ohm	RES/HDC-0603	RES 22 OHM 1/16W 3000PPM 5% 0603	Panasonic	ERA-V3J220V
1	R4	1kohm	RES/HDC-0603	RES 1.0K OHM 1/16W .1% 0603 SMD	Panasonic	ERA-3AE8102V
2	R6,R11	47kohm	RES/HDC-0603	RES 47K OHM 1/16W .1% 0603 SMD	Panasonic	ERA-3AE8473V
7	R8,R9,R48,R49,R50,R145,R146	0ohm	RES/HDC-0603	RES ZERO OHM 1/10W 5% 0603 SMD	Panasonic	ERJ-3GEY0R00V
7	R55,R56,R57,R75,R76,R77,R79	10K	RES/HDC-0603	RES 10.0K OHM 1/10W 1% 0603 SMD	Panasonic	ERJ-3EKF1002V
2	R60,R61	220 Ohm,0402	RES/HDC-0402	RES 220 OHM 1/10W 5% 0402 SMD	Panasonic	ERJ-2GEJ221X
11	R63,R66,R72,R80,R82,R84,R127,R128,R129,R140,R141	0 Ohm,0402	RES/HDC-0402	RES ZERO OHM 1/16W 5% 0402 SMD	Panasonic	ERJ-2GEJ0R00X
1	R67	0.10 Ohm,0402	RES/HDC-0402	RESISTOR .10 OHM 1/8W 1% 0402	Panasonic	ERJ-2B5FR10X
2	R68,R71	0 ohm	RES/HDC-0201	RES 0.0 OHM 1/20W 5% 0201 SMD	Panasonic	ERJ-1GEOR00C
2	R83,R81	4.7k	RES/HDC-0603	RES 4.7K OHM 1/10W 5% 0603 SMD	Panasonic	ERJ-3GEY472V
2	R86,R118	294K Ohm,0402	RES/HDC-0402	RES 294K OHM 1/10W 1% 0402 SMD	Panasonic	ERJ-2RKF2943X
2	R119,R87	280K Ohm,0402	RES/HDC-0402	RES 280K OHM 1/10W 1% 0402 SMD	Panasonic	ERJ-2RKF2803X
1	R88	270K Ohm,0402	RES/HDC-0402	RES 270K OHM 1/10W 1% 0402 SMD	Panasonic	ERJ-2RKF2703X
1	R89	267K Ohm,0402	RES/HDC-0402	RES 267K OHM 1/10W 1% 0402 SMD	Panasonic	ERJ-2RKF2673X
2	R120,R90	240K Ohm,0402	RES/HDC-0402	RES 240K OHM 1/10W 1% 0402 SMD	Panasonic	ERJ-2RKF2403X
3	R91,R116,R139	243K Ohm,0402	RES/HDC-0402	RES 243K OHM 1/10W 1% 0402 SMD	Panasonic	ERJ-2RKF2433X
2	R92,R121	226K Ohm,0402	RES/HDC-0402	RES 226K OHM 1/10W 1% 0402 SMD	Panasonic	ERJ-2RKF2263X
3	R93,R115,R138	210K Ohm,0402	RES/HDC-0402	RES 210K OHM 1/10W 1% 0402 SMD	Panasonic	ERJ-2RKF2103X
2	R94,R122	196K Ohm,0402	RES/HDC-0402	RES 196K OHM 1/10W 1% 0402 SMD	Panasonic	ERJ-2RKF1963X
1	R95	182K Ohm,0402	RES/HDC-0402	RES 182K OHM 1/10W 1% 0402 SMD	Panasonic	ERJ-2RKF1823X
2	R123,R96	169K Ohm,0402	RES/HDC-0402	RES 169K OHM 1/10W 1% 0402 SMD	Panasonic	ERJ-2RKF1693X
1	R97	154K Ohm,0402	RES/HDC-0402	RES 154K OHM 1/10W 1% 0402 SMD	Panasonic	ERJ-2RKF1543X
2	R98,R124	137K Ohm,0402	RES/HDC-0402	RES 137K OHM 1/10W 1% 0402 SMD	Panasonic	ERJ-2RKF1373X
2	R125,R99	124K Ohm,0402	RES/HDC-0402	RES 124K OHM 1/10W 1% 0402 SMD	Panasonic	ERJ-2RKF1243X
3	R100,R107,R126	90.9K Ohm,0402	RES/HDC-0402	RES 90.9K OHM 1/10W 1% 0402 SMD	Panasonic	ERJ-2RKF9092X
4	R101,R102,R130,R131	40.2K Ohm,0402	RES/HDC-0402	RES 40.2K OHM 1/10W 1% 0402 SMD	Panasonic	ERJ-2RKF4022X
2	R103,R132	49.9K Ohm,0402	RES/HDC-0402	RES 49.9K OHM 1/10W 1% 0402 SMD	Panasonic	ERJ-2RKF4992X
1	R104	60.4K Ohm,0402	RES/HDC-0402	RES 60.4K OHM 1/10W 1% 0402 SMD	Panasonic	ERJ-2RKF6042X
1	R105	71.5K Ohm,0402	RES/HDC-0402	RES 71.5K OHM 1/10W 1% 0402 SMD	Panasonic	ERJ-2RKF7152X
2	R133,R106	76.8K Ohm,0402	RES/HDC-0402	RES 76.8K OHM 1/10W 1% 0402 SMD	Panasonic	ERJ-2RKF7682X
2	R134,R108	102K Ohm,0402	RES/HDC-0402	RES 102K OHM 1/10W 1% 0402 SMD	Panasonic	ERJ-2RKF1023X
1	R109	115K Ohm,0402	RES/HDC-0402	RES 115K OHM 1/10W 1% 0402 SMD	Panasonic	ERJ-2RKF1153X
2	R110,R135	130K Ohm,0402	RES/HDC-0402	RES 130K OHM 1/10W 1% 0402 SMD	Panasonic	ERJ-2RKF1303X
1	R111	147K Ohm,0402	RES/HDC-0402	RES 147K OHM 1/10W 1% 0402 SMD	Panasonic	ERJ-2RKF1473X
2	R112,R136	165K Ohm,0402	RES/HDC-0402	RES 165K OHM 1/10W 1% 0402 SMD	Panasonic	ERJ-2RKF1653X
1	R113	180K Ohm,0402	RES/HDC-0402	RES 180K OHM 1/10W 1% 0402 SMD	Panasonic	ERJ-2RKF1803X
2	R137,R114	191K Ohm,0402	RES/HDC-0402	RES 191K OHM 1/10W 1% 0402 SMD	Panasonic	ERJ-2RKF1913X
1	R142	100 ohm	RES/HDC-0201	RES 100 OHM 1/20W .5% 0201 SMD	Susumu	RR0306P-101-D
1	R144	47kohm	RES/HDC-0603	RES 47K OHM 1/10W 5% 0603 SMD	Panasonic	ERJ-3GEY473V
2	SW1,SW2	SPST		SWITCH TACT	APM Components	ADTSM31NV
2	S2,S1	SW DIP-3	DIP-6	SWITCH DIP EXTENDED SEALED 3POS	Grayhill	78B03ST
2	S3,S4	SW SMD-8	SMD-20	SWITCH TAPE SEAL 8 POS SMD	CTS	219-8MST
1	S5	SW SMD-10	SMD-20	SWITCH TAPE SEAL 10 POS SMD	Electrocomponents CTS	219-10MST
1	U1	DS90UH/B926Q	60ld LLP		National	DS90UH926Q or DS90UB926Q
1	U4	AT90 AVR* 8-Bit	64QFN	IC AVR MCU 128K 64QFN	Atmel	AT90USB1287-16MU
1	U5	REG_LDO	SMT/8-MSOP	IC REG LDO 300MA 3.3V 8MSOP	National Semiconductor	LP3982IMM-3.3/NOPB
1	Y1	8MHz CRYSTAL	5.0mm x 3.2mm	CRYSTAL 8.000 MHZ 18PF SMD	Abracon Corporation	ABM3-8.000MHZ-D2Y-T

Table 1: Bill of Materials

## EVALUATION BOARD/KIT/MODULE (EVM) ADDITIONAL TERMS

Texas Instruments (TI) provides the enclosed Evaluation Board/Kit/Module (EVM) under the following conditions: The user assumes all responsibility and liability for proper and safe handling of the goods. Further, the user indemnifies TI from all claims arising from the handling or use of the goods.

Should this evaluation board/kit not meet the specifications indicated in the User's Guide, the board/kit may be returned within 30 days from the date of delivery for a full refund. THE FOREGOING LIMITED WARRANTY IS THE EXCLUSIVE WARRANTY MADE BY SELLER TO BUYER AND IS IN LIEU OF ALL OTHER WARRANTIES, EXPRESSED, IMPLIED, OR STATUTORY, INCLUDING ANY WARRANTY OF MERCHANTABILITY OR FITNESS FOR ANY PARTICULAR PURPOSE. EXCEPT TO THE EXTENT OF THE INDEMNITY SET FORTH ABOVE, NEITHER PARTY SHALL BE LIABLE TO THE OTHER FOR ANY INDIRECT, SPECIAL, INCIDENTAL, OR CONSEQUENTIAL DAMAGES.

Please read the User's Guide and, specifically, the Warnings and Restrictions notice in the User's Guide prior to handling the product. This notice contains important safety information about temperatures and voltages. For additional information on TI's environmental and/or safety programs, please visit [www.ti.com/esh](http://www.ti.com/esh) or contact TI.

No license is granted under any patent right or other intellectual property right of TI covering or relating to any machine, process, or combination in which such TI products or services might be or are used. TI currently deals with a variety of customers for products, and therefore our arrangement with the user is not exclusive. TI assumes no liability for applications assistance, customer product design, software performance, or infringement of patents or services described herein.

### REGULATORY COMPLIANCE INFORMATION

As noted in the EVM User's Guide and/or EVM itself, this EVM and/or accompanying hardware may or may not be subject to the Federal Communications Commission (FCC) and Industry Canada (IC) rules.

For EVMs **not** subject to the above rules, this evaluation board/kit/module is intended for use for ENGINEERING DEVELOPMENT, DEMONSTRATION OR EVALUATION PURPOSES ONLY and is not considered by TI to be a finished end product fit for general consumer use. It generates, uses, and can radiate radio frequency energy and has not been tested for compliance with the limits of computing devices pursuant to part 15 of FCC or ICES-003 rules, which are designed to provide reasonable protection against radio frequency interference. Operation of the equipment may cause interference with radio communications, in which case the user at his own expense will be required to take whatever measures may be required to correct this interference.

#### General Statement for EVMs including a radio

*User Power/Frequency Use Obligations:* This radio is intended for development/professional use only in legally allocated frequency and power limits. Any use of radio frequencies and/or power availability of this EVM and its development application(s) must comply with local laws governing radio spectrum allocation and power limits for this evaluation module. It is the user's sole responsibility to only operate this radio in legally acceptable frequency space and within legally mandated power limitations. Any exceptions to this are strictly prohibited and unauthorized by Texas Instruments unless user has obtained appropriate experimental/development licenses from local regulatory authorities, which is responsibility of user including its acceptable authorization.

#### For EVMs annotated as FCC – FEDERAL COMMUNICATIONS COMMISSION Part 15 Compliant

##### Caution

This device complies with part 15 of the FCC Rules. Operation is subject to the following two conditions: (1) This device may not cause harmful interference, and (2) this device must accept any interference received, including interference that may cause undesired operation.

Changes or modifications not expressly approved by the party responsible for compliance could void the user's authority to operate the equipment.

#### FCC Interference Statement for Class A EVM devices

This equipment has been tested and found to comply with the limits for a Class A digital device, pursuant to part 15 of the FCC Rules. These limits are designed to provide reasonable protection against harmful interference when the equipment is operated in a commercial environment. This equipment generates, uses, and can radiate radio frequency energy and, if not installed and used in accordance with the instruction manual, may cause harmful interference to radio communications. Operation of this equipment in a residential area is likely to cause harmful interference in which case the user will be required to correct the interference at his own expense.

#### **FCC Interference Statement for Class B EVM devices**

This equipment has been tested and found to comply with the limits for a Class B digital device, pursuant to part 15 of the FCC Rules. These limits are designed to provide reasonable protection against harmful interference in a residential installation. This equipment generates, uses and can radiate radio frequency energy and, if not installed and used in accordance with the instructions, may cause harmful interference to radio communications. However, there is no guarantee that interference will not occur in a particular installation. If this equipment does cause harmful interference to radio or television reception, which can be determined by turning the equipment off and on, the user is encouraged to try to correct the interference by one or more of the following measures:

- Reorient or relocate the receiving antenna.
- Increase the separation between the equipment and receiver.
- Connect the equipment into an outlet on a circuit different from that to which the receiver is connected.
- Consult the dealer or an experienced radio/TV technician for help.

#### **For EVMs annotated as IC – INDUSTRY CANADA Compliant**

This Class A or B digital apparatus complies with Canadian ICES-003.

Changes or modifications not expressly approved by the party responsible for compliance could void the user's authority to operate the equipment.

#### **Concerning EVMs including radio transmitters**

This device complies with Industry Canada licence-exempt RSS standard(s). Operation is subject to the following two conditions: (1) this device may not cause interference, and (2) this device must accept any interference, including interference that may cause undesired operation of the device.

#### **Concerning EVMs including detachable antennas**

Under Industry Canada regulations, this radio transmitter may only operate using an antenna of a type and maximum (or lesser) gain approved for the transmitter by Industry Canada. To reduce potential radio interference to other users, the antenna type and its gain should be so chosen that the equivalent isotropically radiated power (e.i.r.p.) is not more than that necessary for successful communication.

This radio transmitter has been approved by Industry Canada to operate with the antenna types listed in the user guide with the maximum permissible gain and required antenna impedance for each antenna type indicated. Antenna types not included in this list, having a gain greater than the maximum gain indicated for that type, are strictly prohibited for use with this device.

Cet appareil numérique de la classe A ou B est conforme à la norme NMB-003 du Canada.

Les changements ou les modifications pas expressément approuvés par la partie responsable de la conformité ont pu vider l'autorité de l'utilisateur pour actionner l'équipement.

#### **Concernant les EVMs avec appareils radio**

Le présent appareil est conforme aux CNR d'Industrie Canada applicables aux appareils radio exempts de licence. L'exploitation est autorisée aux deux conditions suivantes : (1) l'appareil ne doit pas produire de brouillage, et (2) l'utilisateur de l'appareil doit accepter tout brouillage radioélectrique subi, même si le brouillage est susceptible d'en compromettre le fonctionnement.

#### **Concernant les EVMs avec antennes détachables**

Conformément à la réglementation d'Industrie Canada, le présent émetteur radio peut fonctionner avec une antenne d'un type et d'un gain maximal (ou inférieur) approuvé pour l'émetteur par Industrie Canada. Dans le but

de réduire les risques de brouillage radioélectrique à l'intention des autres utilisateurs, il faut choisir le type d'antenne et son gain de sorte que la puissance isotrope rayonnée équivalente (p.i.r.e.) ne dépasse pas l'intensité nécessaire à l'établissement d'une communication satisfaisante.

Le présent émetteur radio a été approuvé par Industrie Canada pour fonctionner avec les types d'antenne énumérés dans le manuel d'usage et ayant un gain admissible maximal et l'impédance requise pour chaque type d'antenne. Les types d'antenne non inclus dans cette liste, ou dont le gain est supérieur au gain maximal indiqué, sont strictement interdits pour l'exploitation de l'émetteur.

### **[Important Notice for Users of this Product in Japan]**

#### **This development kit is NOT certified as Confirming to Technical Regulations of Radio Law of Japan**

If you use this product in Japan, you are required by Radio Law of Japan to follow the instructions below with respect to this product:

1. Use this product in a shielded room or any other test facility as defined in the notification #173 issued by Ministry of Internal Affairs and Communications on March 28, 2006, based on Sub-section 1.1 of Article 6 of the Ministry's Rule for Enforcement of Radio Law of Japan,
2. Use this product only after you obtained the license of Test Radio Station as provided in Radio Law of Japan with respect to this product, or
3. Use of this product only after you obtained the Technical Regulations Conformity Certification as provided in Radio Law of Japan with respect to this product. Also, please do not transfer this product, unless you give the same notice above to the transferee. Please note that if you could not follow the instructions above, you will be subject to penalties of Radio Law of Japan.

**Texas Instruments Japan Limited**  
**(address) 24-1, Nishi-Shinjuku 6 chome, Shinjuku-ku, Tokyo, Japan**

<http://www.tij.co.jp>

#### **【ご使用にあたっての注】**

本開発キットは技術基準適合証明を受けておりません。

本製品のご使用に際しては、電波法遵守のため、以下のいずれかの措置を取っていただく必要がありますのでご注意ください。

1. 電波法施行規則第6条第1項第1号に基づく平成18年3月28日総務省告示第173号で定められた電波暗室等の試験設備でご使用いただく。
2. 実験局の免許を取得後ご使用いただく。
3. 技術基準適合証明を取得後ご使用いただく。

なお、本製品は、上記の「ご使用にあたっての注意」を譲渡先、移転先に通知しない限り、譲渡、移転できないものとします。

上記を遵守頂けない場合は、電波法の罰則が適用される可能性があることをご留意ください。

日本テキサス・インスツルメンツ株式会社

東京都新宿区西新宿6丁目24番1号

西新宿三井ビル

<http://www.tij.co.jp>



## **EVALUATION BOARD/KIT/MODULE (EVM) WARNINGS, RESTRICTIONS AND DISCLAIMERS**

**For Feasibility Evaluation Only, in Laboratory/Development Environments.** Unless otherwise indicated, this EVM is not a finished electrical equipment and not intended for consumer use. It is intended solely for use for preliminary feasibility evaluation in laboratory/development environments by technically qualified electronics experts who are familiar with the dangers and application risks associated with handling electrical mechanical components, systems and subsystems. It should not be used as all or part of a finished end product.

Your Sole Responsibility and Risk. You acknowledge, represent and agree that:

1. You have unique knowledge concerning Federal, State and local regulatory requirements (including but not limited to Food and Drug Administration regulations, if applicable) which relate to your products and which relate to your use (and/or that of your employees, affiliates, contractors or designees) of the EVM for evaluation, testing and other purposes.
2. You have full and exclusive responsibility to assure the safety and compliance of your products with all such laws and other applicable regulatory requirements, and also to assure the safety of any activities to be conducted by you and/or your employees, affiliates, contractors or designees, using the EVM. Further, you are responsible to assure that any interfaces (electronic and/or mechanical) between the EVM and any human body are designed with suitable isolation and means to safely limit accessible leakage currents to minimize the risk of electrical shock hazard.
3. You will employ reasonable safeguards to ensure that your use of the EVM will not result in any property damage, injury or death, even if the EVM should fail to perform as described or expected.
4. You will take care of proper disposal and recycling of the EVM's electronic components and packing materials.

**Certain Instructions.** It is important to operate this EVM within TI's recommended specifications and environmental considerations per the user guidelines. Exceeding the specified EVM ratings (including but not limited to input and output voltage, current, power, and environmental ranges) may cause property damage, personal injury or death. If there are questions concerning these ratings please contact a TI field representative prior to connecting interface electronics including input power and intended loads. Any loads applied outside of the specified output range may result in unintended and/or inaccurate operation and/or possible permanent damage to the EVM and/or interface electronics. Please consult the EVM User's Guide prior to connecting any load to the EVM output. If there is uncertainty as to the load specification, please contact a TI field representative. During normal operation, some circuit components may have case temperatures greater than 60°C as long as the input and output are maintained at a normal ambient operating temperature. These components include but are not limited to linear regulators, switching transistors, pass transistors, and current sense resistors which can be identified using the EVM schematic located in the EVM User's Guide. When placing measurement probes near these devices during normal operation, please be aware that these devices may be very warm to the touch. As with all electronic evaluation tools, only qualified personnel knowledgeable in electronic measurement and diagnostics normally found in development environments should use these EVMs.

**Agreement to Defend, Indemnify and Hold Harmless.** You agree to defend, indemnify and hold TI, its licensors and their representatives harmless from and against any and all claims, damages, losses, expenses, costs and liabilities (collectively, "Claims") arising out of or in connection with any use of the EVM that is not in accordance with the terms of the agreement. This obligation shall apply whether Claims arise under law of tort or contract or any other legal theory, and even if the EVM fails to perform as described or expected.

**Safety-Critical or Life-Critical Applications.** If you intend to evaluate the components for possible use in safety critical applications (such as life support) where a failure of the TI product would reasonably be expected to cause severe personal injury or death, such as devices which are classified as FDA Class III or similar classification, then you must specifically notify TI of such intent and enter into a separate Assurance and Indemnity Agreement.

## IMPORTANT NOTICE FOR TI REFERENCE DESIGNS

Texas Instruments Incorporated ("TI") reference designs are solely intended to assist designers ("Buyers") who are developing systems that incorporate TI semiconductor products (also referred to herein as "components"). Buyer understands and agrees that Buyer remains responsible for using its independent analysis, evaluation and judgment in designing Buyer's systems and products.

TI reference designs have been created using standard laboratory conditions and engineering practices. **TI has not conducted any testing other than that specifically described in the published documentation for a particular reference design.** TI may make corrections, enhancements, improvements and other changes to its reference designs.

Buyers are authorized to use TI reference designs with the TI component(s) identified in each particular reference design and to modify the reference design in the development of their end products. HOWEVER, NO OTHER LICENSE, EXPRESS OR IMPLIED, BY ESTOPPEL OR OTHERWISE TO ANY OTHER TI INTELLECTUAL PROPERTY RIGHT, AND NO LICENSE TO ANY THIRD PARTY TECHNOLOGY OR INTELLECTUAL PROPERTY RIGHT, IS GRANTED HEREIN, including but not limited to any patent right, copyright, mask work right, or other intellectual property right relating to any combination, machine, or process in which TI components or services are used. Information published by TI regarding third-party products or services does not constitute a license to use such products or services, or a warranty or endorsement thereof. Use of such information may require a license from a third party under the patents or other intellectual property of the third party, or a license from TI under the patents or other intellectual property of TI.

TI REFERENCE DESIGNS ARE PROVIDED "AS IS". TI MAKES NO WARRANTIES OR REPRESENTATIONS WITH REGARD TO THE REFERENCE DESIGNS OR USE OF THE REFERENCE DESIGNS, EXPRESS, IMPLIED OR STATUTORY, INCLUDING ACCURACY OR COMPLETENESS. TI DISCLAIMS ANY WARRANTY OF TITLE AND ANY IMPLIED WARRANTIES OF MERCHANTABILITY, FITNESS FOR A PARTICULAR PURPOSE, QUIET ENJOYMENT, QUIET POSSESSION, AND NON-INFRINGEMENT OF ANY THIRD PARTY INTELLECTUAL PROPERTY RIGHTS WITH REGARD TO TI REFERENCE DESIGNS OR USE THEREOF. TI SHALL NOT BE LIABLE FOR AND SHALL NOT DEFEND OR INDEMNIFY BUYERS AGAINST ANY THIRD PARTY INFRINGEMENT CLAIM THAT RELATES TO OR IS BASED ON A COMBINATION OF COMPONENTS PROVIDED IN A TI REFERENCE DESIGN. IN NO EVENT SHALL TI BE LIABLE FOR ANY ACTUAL, SPECIAL, INCIDENTAL, CONSEQUENTIAL OR INDIRECT DAMAGES, HOWEVER CAUSED, ON ANY THEORY OF LIABILITY AND WHETHER OR NOT TI HAS BEEN ADVISED OF THE POSSIBILITY OF SUCH DAMAGES, ARISING IN ANY WAY OUT OF TI REFERENCE DESIGNS OR BUYER'S USE OF TI REFERENCE DESIGNS.

TI reserves the right to make corrections, enhancements, improvements and other changes to its semiconductor products and services per JESD46, latest issue, and to discontinue any product or service per JESD48, latest issue. Buyers should obtain the latest relevant information before placing orders and should verify that such information is current and complete. All semiconductor products are sold subject to TI's terms and conditions of sale supplied at the time of order acknowledgment.

TI warrants performance of its components to the specifications applicable at the time of sale, in accordance with the warranty in TI's terms and conditions of sale of semiconductor products. Testing and other quality control techniques for TI components are used to the extent TI deems necessary to support this warranty. Except where mandated by applicable law, testing of all parameters of each component is not necessarily performed.

TI assumes no liability for applications assistance or the design of Buyers' products. Buyers are responsible for their products and applications using TI components. To minimize the risks associated with Buyers' products and applications, Buyers should provide adequate design and operating safeguards.

Reproduction of significant portions of TI information in TI data books, data sheets or reference designs is permissible only if reproduction is without alteration and is accompanied by all associated warranties, conditions, limitations, and notices. TI is not responsible or liable for such altered documentation. Information of third parties may be subject to additional restrictions.

Buyer acknowledges and agrees that it is solely responsible for compliance with all legal, regulatory and safety-related requirements concerning its products, and any use of TI components in its applications, notwithstanding any applications-related information or support that may be provided by TI. Buyer represents and agrees that it has all the necessary expertise to create and implement safeguards that anticipate dangerous failures, monitor failures and their consequences, lessen the likelihood of dangerous failures and take appropriate remedial actions. Buyer will fully indemnify TI and its representatives against any damages arising out of the use of any TI components in Buyer's safety-critical applications.

In some cases, TI components may be promoted specifically to facilitate safety-related applications. With such components, TI's goal is to help enable customers to design and create their own end-product solutions that meet applicable functional safety standards and requirements. Nonetheless, such components are subject to these terms.

No TI components are authorized for use in FDA Class III (or similar life-critical medical equipment) unless authorized officers of the parties have executed an agreement specifically governing such use.

Only those TI components that TI has specifically designated as military grade or "enhanced plastic" are designed and intended for use in military/aerospace applications or environments. Buyer acknowledges and agrees that any military or aerospace use of TI components that have **not** been so designated is solely at Buyer's risk, and Buyer is solely responsible for compliance with all legal and regulatory requirements in connection with such use.

TI has specifically designated certain components as meeting ISO/TS16949 requirements, mainly for automotive use. In any case of use of non-designated products, TI will not be responsible for any failure to meet ISO/TS16949.