



ABSTRACT

This report discusses the results of the total ionizing dose (TID) testing for the Texas Instruments TPS7H6013-SP radiation hardness-assured 1.3A, 2.5A, half-bridge gate driver. The study was done to determine TID effects at 100krad(Si) High Dose Rate (HDR). The results show that all samples pass within device specified test limits.

Table of Contents

1 Device Information	2
1.1 Product Description.....	2
1.2 Device Details.....	2
2 Total Dose Test Setup	3
2.1 Test Overview.....	3
2.2 Test Description and Facilities.....	3
2.3 Test Setup Details.....	3
2.4 Test Configuration and Condition.....	5
3 TID Characterization Test Results	6
3.1 TID Characterization Results Summary.....	6
3.2 Data Sheet Electrical Parameters.....	6
4 Applicable and Reference Documents	10
4.1 Applicable Documents.....	10
4.2 Reference Documents.....	10
A Appendix: HDR TID Report	11

Trademarks

All trademarks are the property of their respective owners.

1 Device Information

1.1 Product Description

The TPS7H6013-SP is a 60V radiation-hardness-assured, high voltage gate driver for GaN FETs for space applications. The TPS7H6013-SP is designed for high frequency, high-efficiency applications. The driver features adjustable dead time capability, small 30ns propagation delay and 5.5ns high-side and low-side matching. This part also includes internal high-side and low-side LDOs which specifies a drive voltage of 5V regardless of supply voltage. The TPS7H6013-SP is packaged in a ceramic 48-HBX (CFP) package.

1.2 Device Details

Testing was performed per MIL-STD-883, Test Method 1019, with a sample size per MIL-PRF-38535, Appendix C, test condition A (high dose rate).

Table 1-1. Device and Exposure Details

RHA TID Details: Up to 100 krad(Si)	
TI Part Number	TPS7H6013-SP
Orderable Number	5962R2220102VXC
Device function	Half Bridge Gate Driver
Die Name	RTPS7H6003A0VM
Package	48-pin CFP (HBX)
Technology	LBC7 (250nm Linear BiCMOS)
Quantity tested	HDR : <ul style="list-style-type: none"> • Three biased and three unbiased units at 10krad(Si) levels • Three biased and three unbiased units at 50krad(Si) levels • Five biased and five unbiased units at 100krad(Si) levels • One correlation unit
Lot Accept/Reject	Passes 100 krad(Si), no observed fails
HDR radiation facility	Texas Instruments CLAB Dallas, Texas
Die Lot Number and Assembly Lot Number	2349610T11-18 / 4000351MTT
HDR Dose Rate	186.7 rad(Si) / s
HDR Radiation Source	Gammacell 220 Excel (GC-220E) Co-60
Irradiation and Test Temperature	Ambient, room temperature controlled to 25°C ±6°C per MIL-STD-883 and MIL-STD-750

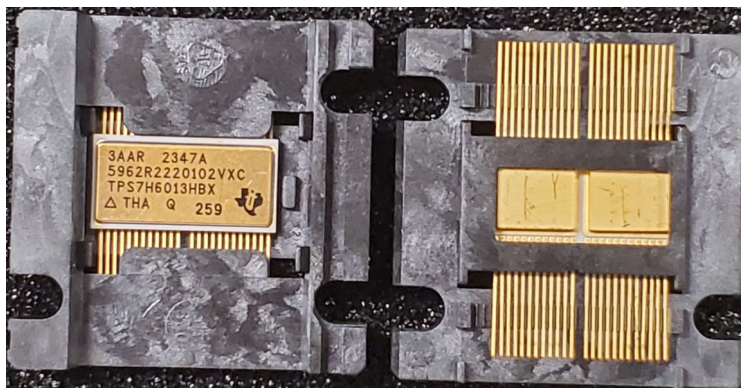

Figure 1-1. TPS7H6013-SP Device Used in Exposure

2 Total Dose Test Setup

2.1 Test Overview

The TPS7H6013-SP was tested according to MIL-STD-883, Test Method 1019.9. For this testing, conditions A and D were used. For this test, the product was irradiated up to the target radiation level, and then put through full electrical parametric testing on the production Automated Test Equipment (ATE). All devices remained functional passing all parametric test limits.

2.2 Test Description and Facilities

The TPS7H6013-SP HDR exposure was performed on biased devices in a Co-60 gammacell at the TI Dallas C-Lab facility in Dallas, Texas. The unattenuated dose rate of this cell is 186.7rad(Si) / s. After exposure, the devices were packed in dry ice (per MIL-STD-883 Method 1019.9 section 3.10) and post-radiation electrical testing at TI's Dallas Forest Lane facility. Test limit guard bands are set within SMD electrical test limits. Post-radiation measurements were taken within 30 minutes after removing device from the dry ice container. The devices were allowed to reach room temperature prior to electrical post-radiation measurements.

2.3 Test Setup Details

The devices under HDR exposure were tested in two conditions, biased and unbiased, as described in the following sections.

2.3.1 Unbiased

For the unbiased HDR conditions, the exposure was performed with all pins grounded.

2.3.2 Biased

Figure 2-2 show HDR bias diagram & schematic.

Table 2-1. DUT Power Supply Bias and Vout measurements

Power Supply Bias				
	Edge Connector	BUS	Typical	Comments
Power Supply	BUS A	VIN	14VDC	14VDC - Fixed power supply
	BUS D	BOOT	14VDC	14VDCWRTSW - Floating power supply WRT to SW
	BUS B	ASW	0-50V	Increase HV gradually. Recommend using safety interlock HV protection when working with high voltage.
DUT Vout Measurements				
VOUT Test Points	TP_PGOOD	ON	5V	LS is ON
	TP_LO	PWM_LI	1.8V	PWM mode
	TP_HO	PWM_LI DC WRT ASW	3.51V	PWM mode
	TP_SW	SW = PSW = ASW	0-50V	SW = PSW = ASW
	PWM_LI	DUT Mon	1.85V	DUT monitor edge connector

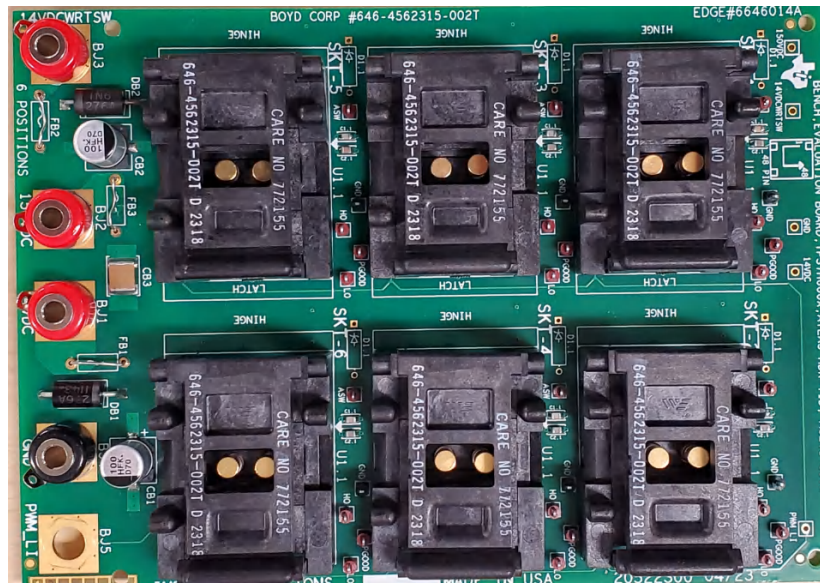

Figure 2-1. HDR TID Hardware

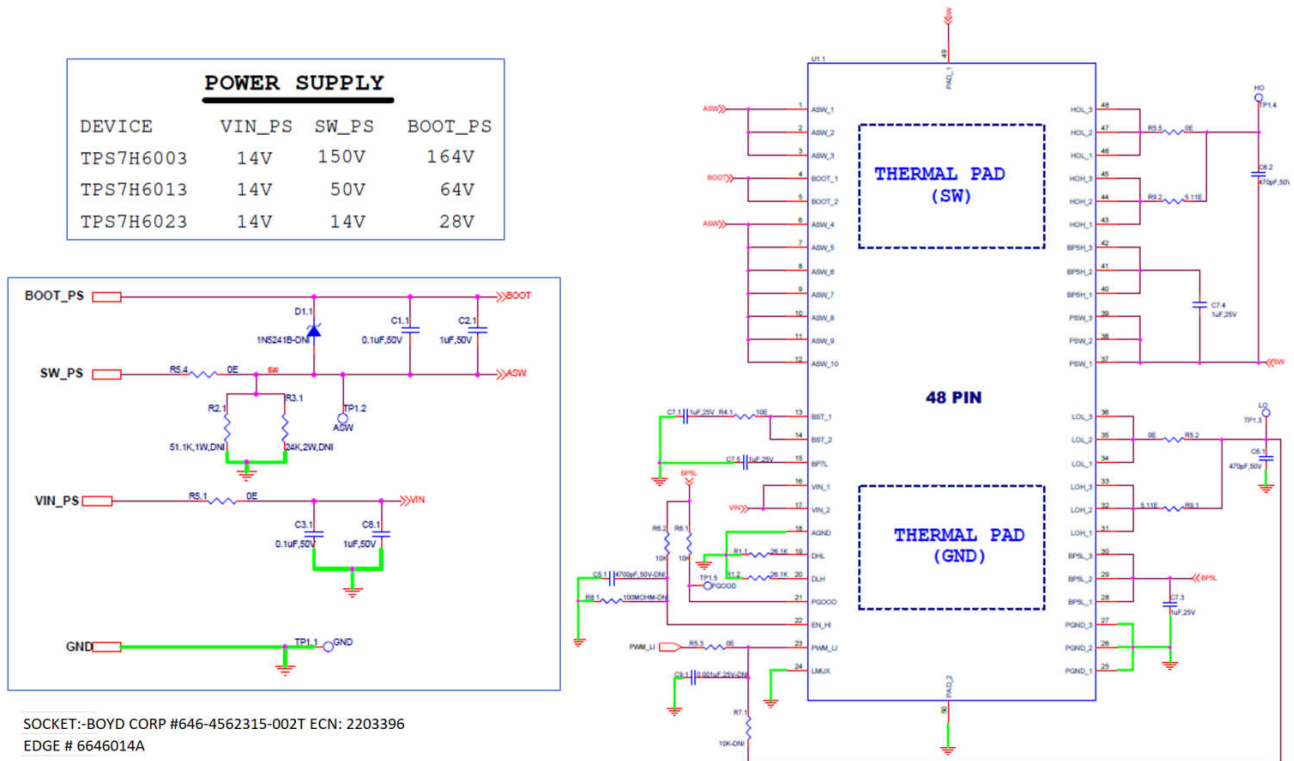

Figure 2-2. HDR TID Bias Diagram

2.4 Test Configuration and Condition

HDR devices were stressed up to 100krad(Si) for biased and unbiased conditions.

Table 2-2. HDR Biased Device Information

Total Samples: 11 units + 1 control		
Exposure Levels:		
10krad(Si)	50krad(Si)	100krad(Si)
182, 202, 204	259, 346, 347	354, 363, 366, 383, 417

Table 2-3. HDR Unbiased Device Information

Total Samples: 11 units + 1 control		
Exposure Levels:		
10krad(Si)	50krad(Si)	100krad(Si)
418, 419, 443	462, 478, 503	513, 526, 532, 533, 534

3 TID Characterization Test Results

3.1 TID Characterization Results Summary

The results show that all TPS7H6013-SP devices are fully functional and within specification limits up to 100krad(Si) HDR. Overall, the TPS7H6013-SP show a strong degree of hardness to TID HDR exposure levels at 100krad(Si) under biased and unbiased conditions. Performance is measured based on the difference between pre- and post-irradiation with respect to SMD electrical minimum and maximum specification. The measurements taken post-irradiation for each sample set showed a marginal shift for most parameters at each dose level for both biased and unbiased. (see [Section 3.2](#) for the electrical parameters). Note that test numbers are listed only for parameters tested post-TID.

See [Appendix A](#) for HDR report.

3.2 Data Sheet Electrical Parameters

Specifications are at ambient temperature $T_A = 25^\circ\text{C}$, $V_{IN} = 10\text{V}$ to 14V , $V_{BP5L} = V_{BP5H} = 5\text{V}$, and no load on LOH, LOL, HOH, and HOL (unless otherwise noted).

Table 3-1. TPS7H60x3-SP Data Sheet Electrical Parameters

Parameter		Test Conditions		MIN	MAX	UNIT	Test Number
SUPPLY CURRENTS							
I_{QLS}	Low-side quiescent current	$V_{IN} = 12\text{V}$, $BOOT = 10\text{V}$	MODE = PWM, EN = 0V		6.8	mA	35.0, 36.0, 37.0
			MODE = IIM, LI = HI = 0V		8		35.2, 36.2, 37.2
I_{QHS}	High-side quiescent current	$V_{IN} = 12\text{V}$, $BOOT = 10\text{V}$	MODE = PWM, EN = 0V		6.3	mA	35.1, 36.1, 37.1
			MODE = IIM, LI = HI = 0V		6.3		35.3, 36.3, 37.3
I_{OP_LS}	Low-side operating current	MODE = PWM, no load for HOL and HOH	f = 500kHz		9	mA	35.6, 36.6, 37.6
			f = 1MHz		11		35.8, 36.8, 37.8
			f = 2MHz		16		35.10, 36.10, 37.10
			f = 5MHz		30		35.12, 36.12, 37.12
		MODE = IIM, no load for HOL and HOH	f = 500kHz		9		35.14, 36.14, 37.14
			f = 1MHz		12		35.16, 36.16, 37.16
			f = 2MHz		17		35.18, 36.18, 37.18
			f = 5MHz		30		35.20, 36.20, 37.20
I_{OP_HS}	High-side operating current	MODE = PWM, no load for HOL and HOH	f = 500kHz		6.5	mA	35.7, 36.7, 37.7
			f = 1MHz		8		35.9, 36.9, 37.9
			f = 2MHz		10.5		35.11, 36.11, 37.11
			f = 5MHz		17.5		35.13, 36.13, 37.13
		MODE = IIM, no load for HOL and HOH	f = 500kHz		6.5		35.15, 36.15, 37.15
			f = 1MHz		8		35.17, 36.17, 37.17
			f = 2MHz		10.5		35.19, 36.19, 37.19
			f = 5MHz		15		35.21, 36.21, 37.21
GATE DRIVER							
V_{OL}	Low-level output voltage	$I_{OL} = 100\text{mA}$			0.15	V	45.0, 46.0, 47.0

Table 3-1. TPS7H60x3-SP Data Sheet Electrical Parameters (continued)

Parameter		Test Conditions	MIN	MAX	UNIT	Test Number
BP5x – V _{OH}	High-level output voltage	I _{OH} = 100mA		0.3	V	45.2, 46.2, 47.2
I _{OH}	Peak source current	HOH, LOH = 0V, BP5x = 5V	0.7	2.3	A	50.0, 50.1, 51.0, 51.1, 52.0, 52.1
I _{OL}	Peak sink current	HOL, LOL = 5V, BP5x = 5V	1.6	4.6	A	50.2, 51.2, 52.2
INTERNAL REGULATORS						
V _{BP5L}	Low-side 5V regulator output voltage	C _{BP5L} = 1μF	4.75	5.175	V	60.1, 60.4, 60.7, 60.10, 60.13, 60.16, 60.19, 60.22, 61.1, 61.4, 61.7, 61.10, 61.13, 61.16, 61.19, 61.22, 62.1, 62.4, 62.7, 62.10, 62.13, 62.16, 62.19, 62.22
V _{BP5H}	High-side 5V regulator output voltage	C _{BP5H} = 1μF	4.75	5.175	V	60.2, 60.5, 60.8, 60.11, 60.14, 60.17, 60.20, 60.23, 61.2, 61.5, 61.8, 61.11, 61.14, 61.17, 61.20, 61.23, 62.2, 62.5, 62.8, 62.11, 62.14, 62.17, 62.20, 62.23
V _{BP7L}	7V regulator output voltage	C _{BP7L} = 1μF	6.65	7.35	V	60.0, 60.3, 60.6, 60.9, 60.12, 60.15, 60.18, 60.21, 61.0, 61.3, 61.6, 61.9, 61.12, 61.15, 61.18, 61.21, 61.23, 62.0, 62.3, 62.6, 62.9, 62.12, 62.15, 62.18, 62.21
UNDERVOLTAGE PROTECTION						
BP5H _R	BP5H UVLO rising threshold	C _{BP5H} = 1μF	4	4.5	V	85.1, 86.1, 87.1 ⁽¹⁾
BP5H _F	BP5H UVLO falling threshold	C _{BP5H} = 1μF	3.8	4.3	V	85.2, 86.2, 87.2 ⁽¹⁾
BP5L _R	BP5L UVLO rising threshold	C _{BP5L} = 1μF	4	4.5	V	80.1, 81.1, 82.1 ⁽¹⁾
BP5L _F	BP5L UVLO falling threshold	C _{BP5L} = 1μF	3.8	4.3	V	80.2, 81.2, 82.2 ⁽¹⁾
BP7L _R	BP7L UVLO rising threshold	C _{BP7L} = 1μF	6.2	6.8	V	80.4, 81.4, 82.4 ⁽¹⁾
BP7L _F	BP7L UVLO falling threshold	C _{BP7L} = 1μF	5.9	6.5	V	80.5, 81.5, 82.5 ⁽¹⁾
VIN _R	VIN UVLO rising threshold		8	9	V	70
VIN _F	VIN UVLO falling threshold		7.5	8.5	V	70.1
BOOT _R	BOOT UVLO rising threshold		6.6	7.4	V	75
BOOT _F	BOOT UVLO falling threshold		6.2	7	V	75.1
INPUT PINS						
V _{IR}	Input rising edge threshold		1.80	2.65	V	90.0, 91.0, 92.0, 90.3, 91.3, 92.3

Table 3-1. TPS7H60x3-SP Data Sheet Electrical Parameters (continued)

Parameter		Test Conditions	MIN	MAX	UNIT	Test Number	
V_{IF}	Input falling edge threshold		1.15	1.85	V	90.1, 91.1, 92.1, 90.4, 91.4, 92.4	
R_{PD}	Input pull-down resistance	$V = 2.15V$ applied at input (EN_HI or PWM_LI)	100	400	k Ω	90.6, 90.7, 91.6, 91.7, 92.6, 92.7	
PROGRAMMABLE DEAD TIME							
T_{DLH}	LO off to HO on dead time	MODE = PWM, LO falling to HO rising (90% to 10%), $f \leq 2MHz$	RLH = 3.32k Ω	0	10	ns	95.0, 95.5, 95.10, 96.0, 96.5, 96.10, 97.0, 97.5, 97.10
			RLH = 11.8k Ω	8	15.5		95.1, 95.6, 95.11, 96.1, 96.6, 96.11, 97.1, 97.6, 97.11
			RLH = 21k Ω	15.5	24		95.2, 95.7, 95.12, 96.2, 96.7, 96.12, 97.2, 97.7, 97.12
			RLH = 52.3k Ω	36	59		95.3, 95.8, 95.13, 96.3, 96.8, 96.13, 97.3, 97.8, 97.13
			RLH = 105k Ω	74	113.5		95.4, 95.9, 95.14, 96.4, 96.9, 96.14, 97.4, 97.9, 97.14
T_{DHL}	HO off to LO on dead time	MODE = PWM, HO falling to LO rising (90% to 10%), $f \leq 2MHz$	RHL = 7.87k Ω	0	10	ns	95.19, 95.24, 95.29, 96.19, 96.24, 96.29, 97.19, 97.24, 97.29
			RHL = 13.3k Ω	6	15		95.20, 95.25, 95.30, 96.20, 96.25, 96.30, 97.20, 97.25, 97.30
			RHL = 23.7k Ω	16	24.5		95.21, 95.26, 95.31, 96.21, 96.26, 96.31, 97.21, 97.26, 97.31
			RHL = 57.6k Ω	44	61		95.22, 95.27, 95.32, 96.22, 96.27, 96.32, 97.22, 97.27, 97.32
			RHL = 113k Ω	86	125		95.23, 95.28, 95.33, 96.23, 96.28, 96.33, 97.23, 97.28, 97.33
BOOTSTRAP DIODE SWITCH							
	Bootstrap diode switch parallel resistance	$I_{BST_SW} = 1mA$	0.8	1.2	k Ω	100.1, 101.1, 102.1	
POWER GOOD							
	Logic-low output	$I_{FLT} = 1mA$		0.4	V	105.0, 106.0, 107.0	
	PGOOD internal resistance	BP5L = 5V, BP7L = 7V, VIN = 12V	0.7	1.9	M Ω	105.2, 106.2, 107.2	
	Minimum BP5L voltage for valid PGOOD output			2.45	V	105.1, 106.1, 107.1	

(1) Tests are only tested in production or SPI Test Mode.

Table 3-2. TPS7H60x3-SP Switching Characteristics

Parameter		Test Conditions		MIN	MAX	UNIT	Test Number
t _{LPHL}	LO turnoff propagation delay	MODE = PWM	PWM rising to LOL falling		48	ns	110.0, 111.0, 112.0
		MODE = IIM	LI falling to LOL falling		38	ns	110.3, 110.7, 111.3, 111.7, 112.3, 112.7
t _{LPLH}	LO turnon propagation delay	MODE = IIM	LI rising to LOH rising		38	ns	110.2, 110.6, 111.2, 111.6, 112.2, 112.6
t _{HPHL}	HO turnoff propagation delay	MODE = PWM	PWM falling to HOL falling		50	ns	110.1, 111.1, 112.1
		MODE = IIM	HI falling to HOL falling		40		110.5, 110.9, 111.5, 111.9, 112.5, 112.9
t _{HPLH}	HO turnon propagation delay	MODE = IIM	HI rising to HOH rising		40	ns	110.4, 110.8, 111.4, 111.8, 112.4, 112.8
t _{MON}	Delay matching LO on and HO off	MODE = IIM			12	ns	110.1, 111.1, 112.1, 110.12, 111.12, 112.12
t _{MOFF}	Delay matching LO off and HO on	MODE = IIM			4	ns	110.11, 110.13, 111.11, 111.13, 112.11, 112.13
t _{HRC}	HO rise time	C _L = 1000pF	10% to 90%		7.5	ns	115, 116, 117
t _{LRC}	LO rise time				7.5	ns	115.2, 116.2, 117.2
t _{HFC}	HO fall time		90% to 10%		5.5	ns	115.1, 116.1, 117.1
t _{LFC}	LO fall time				5.5	ns	115.3, 116.3, 117.3
t _{PW_IIM}	Minimum input pulse width (turn-on)	MODE = IIM			8	ns	120, 120.2, 120.4, 121, 121.2, 121.4, 122, 122.2, 122.4
t _{PW_IIM_OFF}	Minimum input pulse width (turn-off)	MODE = IIM			12	ns	120.1, 120.3, 120.5, 121.1, 121.3, 121.5, 122.1, 122.3, 122.5

4 Applicable and Reference Documents

4.1 Applicable Documents

- Texas Instruments, [TPS7H60x3-SP Radiation-Hardness-Assured 1.3-A, 2.5-A, Half-Bridge GaN FET Gate Driver](#), data sheet.
- Texas Instruments, [TPS7H60x3EVM-CVAL Evaluation Module User's Guide](#), EVM user's guide.
- Texas Instruments, [TPS7H60x3-SP Single-Event Effects \(SEE\) Report](#), radiation report.

4.2 Reference Documents

Texas Instruments total ionizing dose radiation (total dose) test procedure follows the standards put forth in MIL-STD-883 TM 1019. The document can be found at the DLA website.

A Appendix: HDR TID Report

This appendix provides the TPS7H6013-SP HDR TID report data.

TID "HDR" Report
5962R2220102VXC

TID "HDR" Report
5962R2220102VXC

		35.0 Iq LS VIN PWM VIN 10V	
Test Site		DAL	DAL
Tester		ETS364	ETS364
Test Number		EB672303	EB672303
Unit		mA	mA
Max Limit		6.8	6.8
Min Limit		1	1

Krad	Serial #	Pre_HDR_6013	Post_HDR_6013	Delta
0	1	4.435	4.380	-0.055
0	2	4.192	4.151	-0.041
10	182	4.127	4.127	0.000
10	202	4.220	4.257	0.037
10	204	4.431	4.183	-0.247
11	418	4.451	4.331	-0.120
11	419	4.370	4.272	-0.098
11	443	4.267	4.305	0.038
50	259	4.315	4.461	0.146
50	346	4.363	4.475	0.112
50	347	4.157	4.262	0.105
51	462	4.297	4.305	0.009
51	478	4.410	4.249	-0.161
51	503	4.276	4.475	0.199
100	354	4.368	4.657	0.289
100	363	4.307	4.663	0.355
100	366	4.445	4.688	0.243
100	383	4.280	4.757	0.477
100	417	4.309	4.555	0.246
101	513	4.296	4.542	0.247
101	526	4.193	4.493	0.300
101	532	4.277	4.547	0.269
101	533	4.207	4.511	0.303
101	534	4.335	4.639	0.303
	Max	4.451	4.757	0.477
	Average	4.305	4.429	0.123
	Min	4.127	4.127	-0.247
	Std Dev	0.092	0.183	0.187

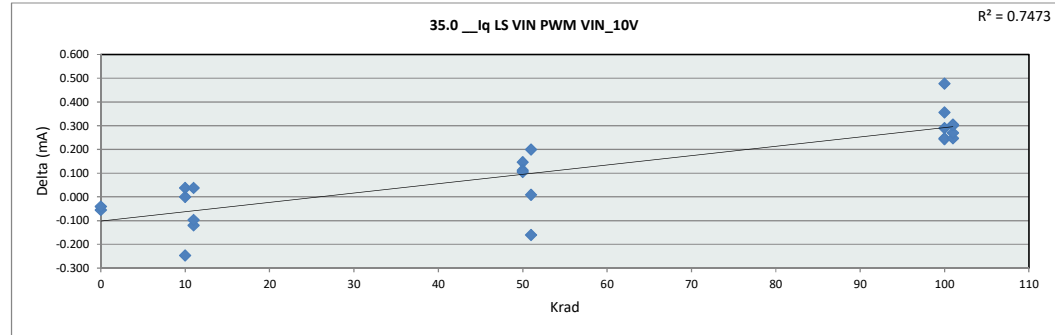

		35.0 Iq LS VIN PWM VIN 10	
Test Site		DAL	
Tester		ETS364	
Test Number		EB672303	
Max Limit		6.8	mA
Min Limit		1	mA

	0	10	11	50	51	100	101
LL	1.000	1.000	1.000	1.000	1.000	1.000	1.000
Min	4.151	4.127	4.272	4.262	4.249	4.555	4.493
Average	4.265	4.189	4.303	4.399	4.343	4.664	4.546
Max	4.380	4.257	4.331	4.475	4.475	4.757	4.639
UL	6.800	6.800	6.800	6.800	6.800	6.800	6.800

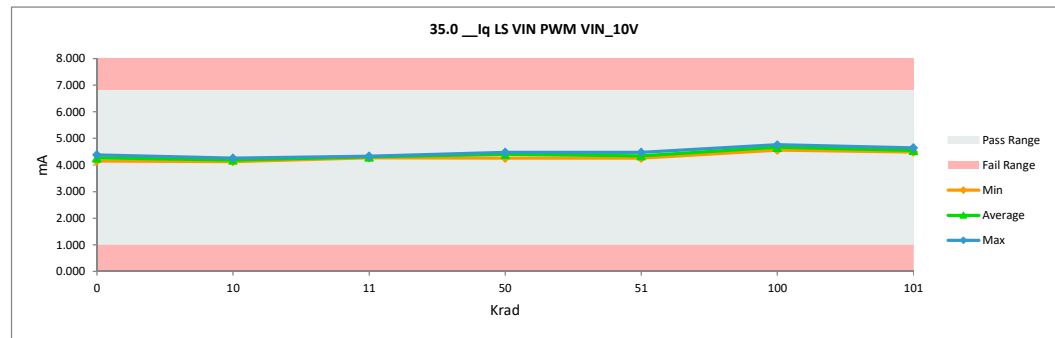

TID "HDR" Report
5962R2220102VXC

35.1 Iq HS BOOT PWM VIN_10		
Test Site	DAL	DAL
Tester	ETS364	ETS364
Test Number	EB672303	EB672303
Unit	mA	mA
Max Limit	6.3	6.3
Min Limit	1	1

Krad	Serial #	Pre_HDR_6013	Post_HDR_6013	Delta
0	1	3.620	3.561	-0.060
0	2	3.549	3.506	-0.043
10	182	3.582	3.570	-0.012
10	202	3.663	3.687	0.024
10	204	3.711	3.715	0.003
11	418	3.498	3.760	0.262
11	419	3.759	3.744	-0.015
11	443	3.548	3.634	0.086
50	259	3.616	3.739	0.123
50	346	3.775	3.924	0.149
50	347	3.617	3.783	0.167
51	462	3.780	3.776	-0.004
51	478	3.605	3.731	0.127
51	503	3.526	3.694	0.168
100	354	3.647	3.957	0.310
100	363	3.681	3.982	0.301
100	366	3.577	3.808	0.230
100	383	3.527	3.884	0.356
100	417	3.622	3.803	0.181
101	513	3.746	4.010	0.265
101	526	3.456	3.689	0.232
101	532	3.702	3.897	0.195
101	533	3.594	3.833	0.239
101	534	3.617	3.804	0.187
Max		3.780	4.010	0.356
Average		3.626	3.770	0.145
Min		3.456	3.506	-0.060
Std Dev		0.088	0.131	0.122

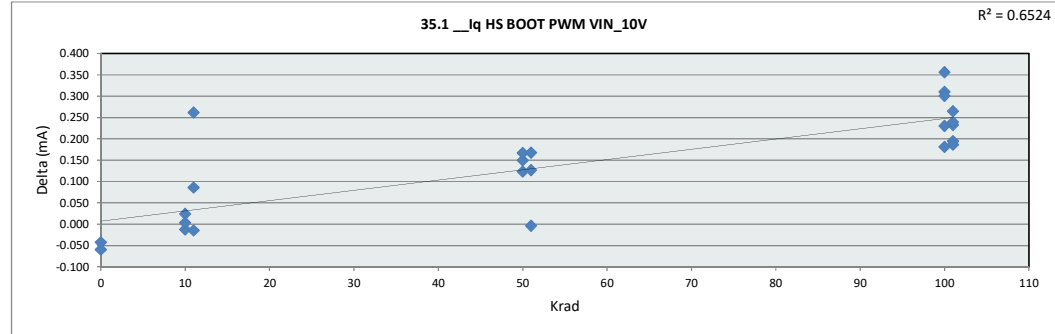

35.1 Iq HS BOOT PWM VIN		
Test Site	DAL	
Tester	ETS364	
Test Number	EB672303	
Max Limit	6.3	mA
Min Limit	1	mA

Krad	0	10	11	50	51	100	101
LL	1.000	1.000	1.000	1.000	1.000	1.000	1.000
Min	3.506	3.570	3.634	3.739	3.694	3.803	3.689
Average	3.533	3.657	3.713	3.816	3.734	3.887	3.846
Max	3.561	3.715	3.760	3.924	3.776	3.982	4.010
UL	6.300	6.300	6.300	6.300	6.300	6.300	6.300

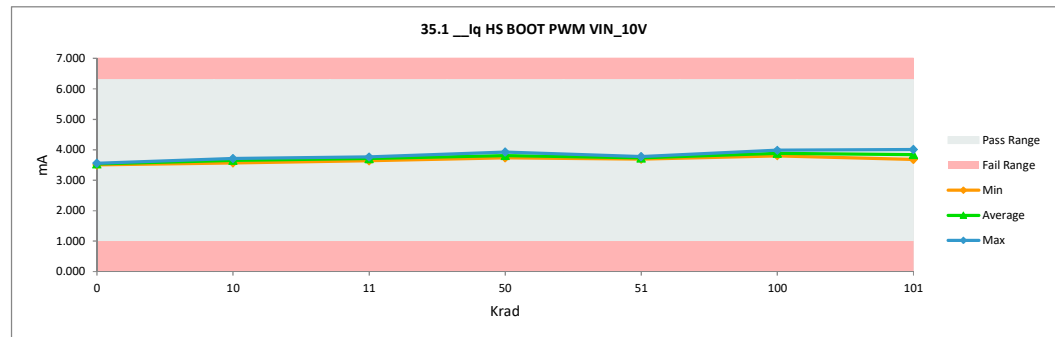

TID "HDR" Report
5962R2220102VXC

35.2 __Iq LS VIN IIM Interlock V		
Test Site	DAL	DAL
Tester	ETS364	ETS364
Test Number	EB672303	EB672303
Unit	mA	mA
Max Limit	8	8
Min Limit	1	1

Krad	Serial #	Pre_HDR_6013	Post_HDR_6013	Delta
0	1	4.364	4.308	-0.056
0	2	4.120	4.081	-0.040
10	182	4.057	4.057	0.000
10	202	4.149	4.187	0.037
10	204	4.359	4.113	-0.246
11	418	4.380	4.260	-0.120
11	419	4.299	4.202	-0.097
11	443	4.195	4.234	0.038
50	259	4.245	4.389	0.144
50	346	4.291	4.403	0.112
50	347	4.087	4.190	0.103
51	462	4.226	4.233	0.007
51	478	4.339	4.180	-0.160
51	503	4.205	4.404	0.199
100	354	4.298	4.585	0.287
100	363	4.237	4.590	0.353
100	366	4.374	4.615	0.241
100	383	4.209	4.684	0.475
100	417	4.239	4.480	0.242
101	513	4.225	4.471	0.247
101	526	4.122	4.421	0.299
101	532	4.206	4.472	0.267
101	533	4.138	4.440	0.302
101	534	4.265	4.569	0.305
	Max	4.380	4.684	0.475
	Average	4.235	4.357	0.122
	Min	4.057	4.057	-0.246
	Std Dev	0.092	0.182	0.186

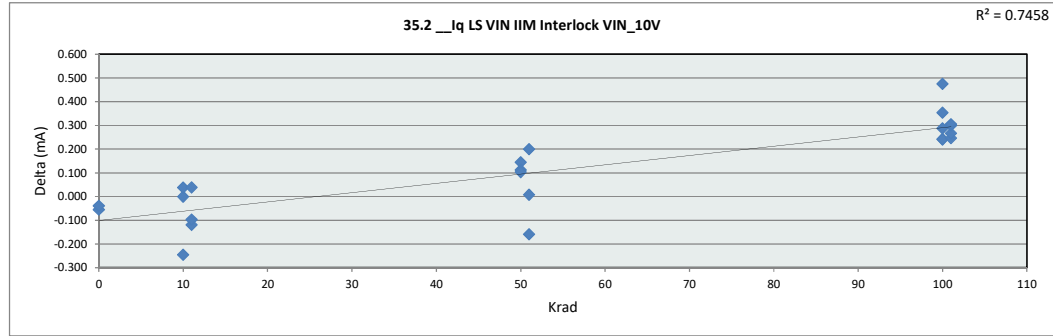

35.2 __Iq LS VIN IIM Interlock		
Test Site	DAL	
Tester	ETS364	
Test Number	EB672303	
Max Limit	8	mA
Min Limit	1	mA

Krad	0	10	11	50	51	100	101
LL	1.000	1.000	1.000	1.000	1.000	1.000	1.000
Min	4.081	4.057	4.202	4.190	4.180	4.480	4.421
Average	4.194	4.119	4.232	4.328	4.272	4.591	4.475
Max	4.308	4.187	4.260	4.403	4.404	4.684	4.569
UL	8.000	8.000	8.000	8.000	8.000	8.000	8.000

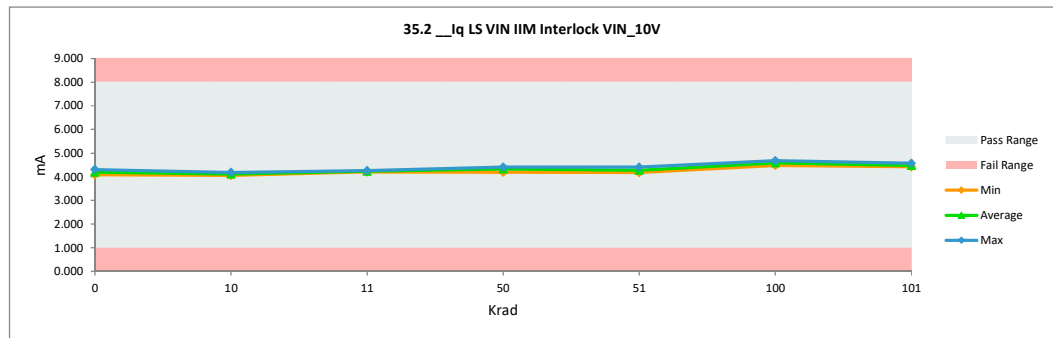

TID "HDR" Report
5962R2220102VXC

35.3 Iq HS BOOT IIM Interlock		
Test Site	DAL	DAL
Tester	ETS364	ETS364
Test Number	EB672303	EB672303
Unit	mA	mA
Max Limit	6.3	6.3
Min Limit	1	1

Krad	Serial #	Pre_HDR_6013	Post_HDR_6013	Delta
0	1	3.620	3.560	-0.060
0	2	3.549	3.506	-0.043
10	182	3.582	3.570	-0.012
10	202	3.664	3.687	0.023
10	204	3.711	3.714	0.003
11	418	3.497	3.759	0.262
11	419	3.758	3.744	-0.014
11	443	3.548	3.634	0.086
50	259	3.616	3.738	0.122
50	346	3.774	3.923	0.149
50	347	3.618	3.783	0.165
51	462	3.780	3.776	-0.004
51	478	3.604	3.730	0.126
51	503	3.526	3.693	0.167
100	354	3.647	3.959	0.312
100	363	3.681	3.981	0.300
100	366	3.577	3.807	0.230
100	383	3.527	3.883	0.356
100	417	3.622	3.802	0.180
101	513	3.746	4.009	0.263
101	526	3.456	3.687	0.231
101	532	3.703	3.897	0.195
101	533	3.593	3.832	0.239
101	534	3.617	3.804	0.187
Max		3.780	4.009	0.356
Average		3.626	3.770	0.144
Min		3.456	3.506	-0.060
Std Dev		0.088	0.131	0.122

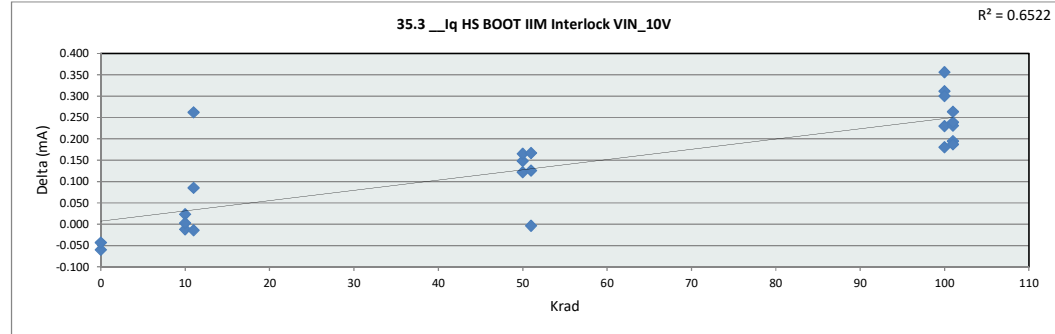

35.3 Iq HS BOOT IIM Interlock		
Test Site	DAL	
Tester	ETS364	
Test Number	EB672303	
Max Limit	6.3	mA
Min Limit	1	mA

Krad	0	10	11	50	51	100	101
LL	1.000	1.000	1.000	1.000	1.000	1.000	1.000
Min	3.506	3.570	3.634	3.738	3.693	3.802	3.687
Average	3.533	3.657	3.713	3.815	3.733	3.887	3.846
Max	3.560	3.714	3.759	3.923	3.776	3.981	4.009
UL	6.300	6.300	6.300	6.300	6.300	6.300	6.300

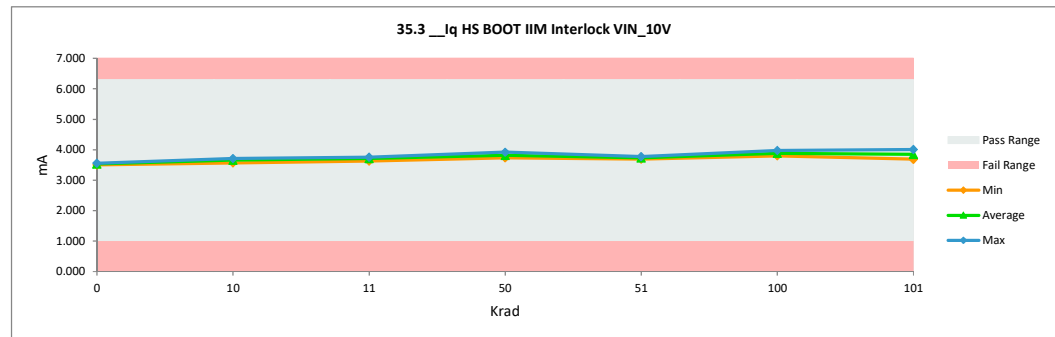

TID "HDR" Report
5962R2220102VXC

35.6 Iop LS VIN PWM 500kHz		
Test Site	DAL	DAL
Tester	ETS364	ETS364
Test Number	EB672303	EB672303
Unit	mA	mA
Max Limit	9	9
Min Limit	1	1

Krad	Serial #	Pre_HDR_6013	Post_HDR_6013	Delta
0	1	6.542	6.496	-0.046
0	2	6.252	6.218	-0.035
10	182	6.178	6.168	-0.010
10	202	6.270	6.292	0.022
10	204	6.451	6.271	-0.180
11	418	6.448	6.429	-0.019
11	419	6.358	6.379	0.022
11	443	6.284	6.362	0.078
50	259	6.355	6.442	0.087
50	346	6.427	6.477	0.050
50	347	6.269	6.308	0.040
51	462	6.253	6.323	0.071
51	478	6.471	6.215	-0.256
51	503	6.336	6.462	0.126
100	354	6.457	6.635	0.178
100	363	6.397	6.613	0.216
100	366	6.512	6.654	0.142
100	383	6.267	6.746	0.479
100	417	6.316	6.553	0.237
101	513	6.334	6.446	0.112
101	526	6.340	6.486	0.146
101	532	6.330	6.466	0.137
101	533	6.229	6.424	0.195
101	534	6.361	6.538	0.177
Max		6.542	6.746	0.479
Average		6.351	6.433	0.082
Min		6.178	6.168	-0.256
Std Dev		0.095	0.148	0.145

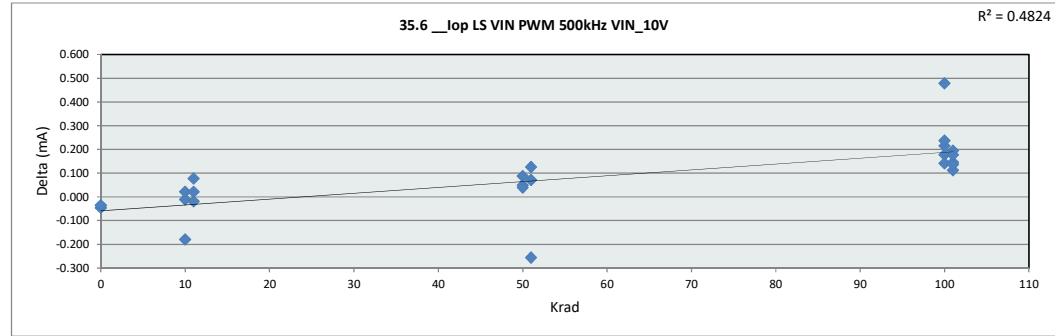

35.6 Iop LS VIN PWM 500kHz		
Test Site	DAL	
Tester	ETS364	
Test Number	EB672303	
Max Limit	9	mA
Min Limit	1	mA

Krad	0	10	11	50	51	100	101
LL	1.000	1.000	1.000	1.000	1.000	1.000	1.000
Min	6.218	6.168	6.362	6.308	6.215	6.553	6.424
Average	6.357	6.244	6.390	6.409	6.333	6.640	6.472
Max	6.496	6.292	6.429	6.477	6.462	6.746	6.538
UL	9.000	9.000	9.000	9.000	9.000	9.000	9.000

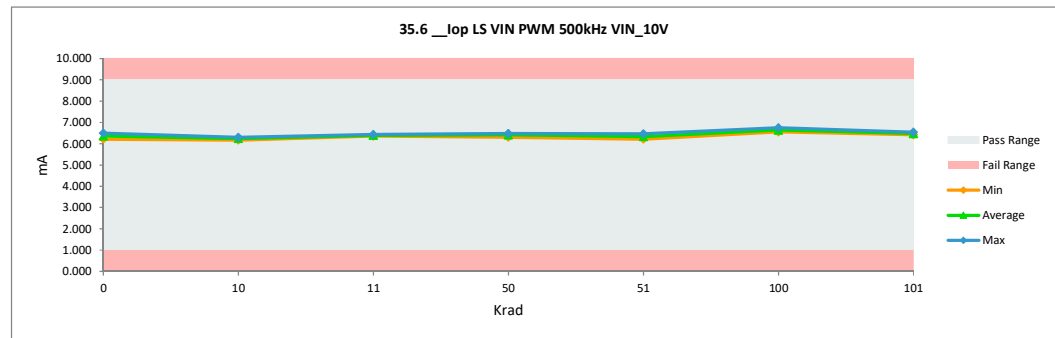

TID "HDR" Report
5962R2220102VXC

35.7 Iop HS BOOT PWM 500kHz		
Test Site	DAL	DAL
Tester	ETS364	ETS364
Test Number	EB672303	EB672303
Unit	mA	mA
Max Limit	6.5	6.5
Min Limit	1	1

Krad	Serial #	Pre_HDR_6013	Post_HDR_6013	Delta
0	1	4.445	4.386	-0.059
0	2	4.379	4.337	-0.042
10	182	4.408	4.397	-0.011
10	202	4.492	4.515	0.023
10	204	4.543	4.545	0.002
11	418	4.323	4.594	0.271
11	419	4.588	4.572	-0.016
11	443	4.378	4.460	0.082
50	259	4.442	4.565	0.123
50	346	4.600	4.749	0.150
50	347	4.447	4.615	0.168
51	462	4.608	4.609	0.000
51	478	4.427	4.561	0.135
51	503	4.359	4.525	0.165
100	354	4.474	4.786	0.312
100	363	4.504	4.813	0.309
100	366	4.401	4.631	0.230
100	383	4.356	4.709	0.354
100	417	4.446	4.634	0.188
101	513	4.570	4.836	0.266
101	526	4.285	4.519	0.234
101	532	4.534	4.726	0.192
101	533	4.417	4.655	0.238
101	534	4.441	4.627	0.186
	Max	4.608	4.836	0.354
	Average	4.453	4.599	0.146
	Min	4.285	4.337	-0.059
	Std Dev	0.088	0.131	0.123

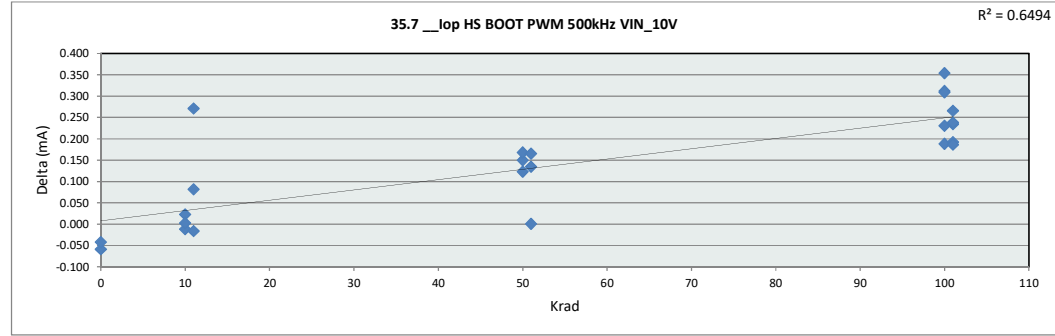

35.7 Iop HS BOOT PWM 500		
Test Site	DAL	
Tester	ETS364	
Test Number	EB672303	
Max Limit	6.5	mA
Min Limit	1	mA

Krad	0	10	11	50	51	100	101
LL	1.000	1.000	1.000	1.000	1.000	1.000	1.000
Min	4.337	4.397	4.460	4.565	4.525	4.631	4.519
Average	4.361	4.486	4.542	4.643	4.565	4.715	4.673
Max	4.386	4.545	4.594	4.749	4.609	4.813	4.836
UL	6.500	6.500	6.500	6.500	6.500	6.500	6.500

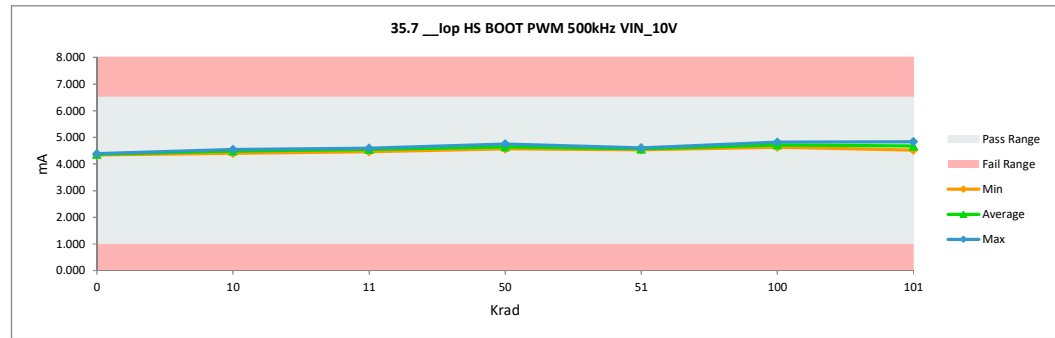

TID "HDR" Report
5962R2220102VXC

35.8 Iop LS VIN PWM 1MHz VIN_10V		
Test Site	DAL	DAL
Tester	ETS364	ETS364
Test Number	EB672303	EB672303
Unit	mA	mA
Max Limit	11	11
Min Limit	1	1

Krad	Serial #	Pre_HDR_6013	Post_HDR_6013	Delta
0	1	8.239	8.192	-0.047
0	2	7.945	7.910	-0.035
10	182	7.858	7.854	-0.003
10	202	7.958	7.987	0.029
10	204	8.148	7.972	-0.176
11	418	8.138	8.133	-0.005
11	419	8.046	8.074	0.028
11	443	7.968	8.048	0.080
50	259	8.034	8.142	0.108
50	346	8.115	8.183	0.067
50	347	7.962	8.024	0.062
51	462	7.940	8.047	0.108
51	478	8.156	7.924	-0.232
51	503	8.030	8.176	0.146
100	354	8.160	8.370	0.210
100	363	8.084	8.335	0.251
100	366	8.202	8.377	0.175
100	383	7.945	8.471	0.526
100	417	7.999	8.290	0.290
101	513	8.026	8.168	0.142
101	526	8.032	8.206	0.174
101	532	8.029	8.198	0.169
101	533	7.919	8.150	0.230
101	534	8.050	8.255	0.205
Max		8.239	8.471	0.526
Average		8.041	8.145	0.104
Min		7.858	7.854	-0.232
Std Dev		0.097	0.158	0.156

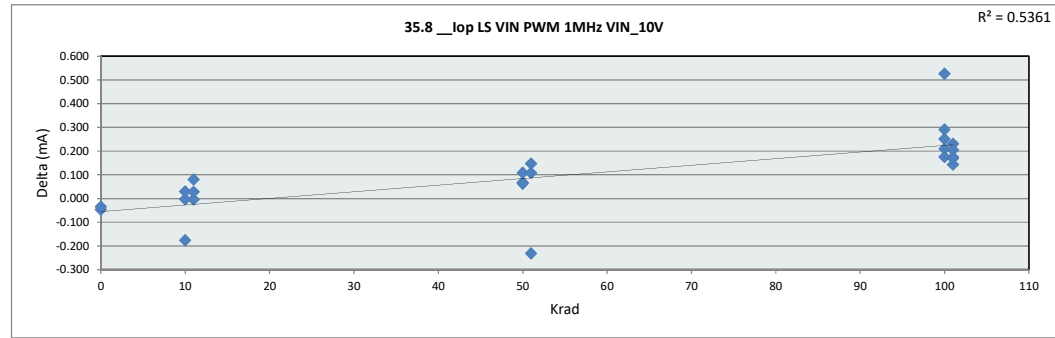

35.8 Iop LS VIN PWM 1MHz		
Test Site	DAL	
Tester	ETS364	
Test Number	EB672303	
Max Limit	11	mA
Min Limit	1	mA

Krad	0	10	11	50	51	100	101
LL	1.000	1.000	1.000	1.000	1.000	1.000	1.000
Min	7.910	7.855	8.048	8.024	7.924	8.290	8.150
Average	8.051	7.938	8.085	8.116	8.049	8.369	8.196
Max	8.192	7.987	8.133	8.183	8.176	8.471	8.255
UL	11.000	11.000	11.000	11.000	11.000	11.000	11.000

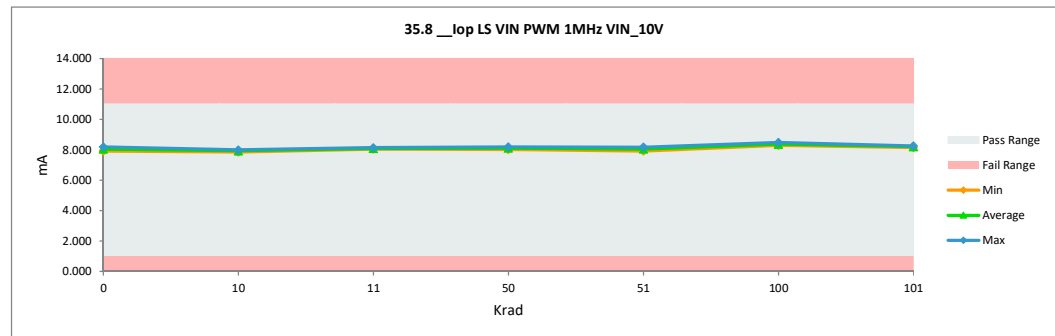

TID "HDR" Report
5962R2220102VXC

35.9 Iop HS BOOT PWM 1MHz		
Test Site	DAL	DAL
Tester	ETS364	ETS364
Test Number	EB672303	EB672303
Unit	mA	mA
Max Limit	8	8
Min Limit	1	1

Krad	Serial #	Pre_HDR_6013	Post_HDR_6013	Delta
0	1	5.268	5.210	-0.059
0	2	5.211	5.167	-0.045
10	182	5.229	5.219	-0.010
10	202	5.318	5.344	0.027
10	204	5.373	5.375	0.001
11	418	5.147	5.425	0.278
11	419	5.413	5.397	-0.016
11	443	5.205	5.284	0.079
50	259	5.265	5.387	0.122
50	346	5.421	5.574	0.154
50	347	5.275	5.444	0.169
51	462	5.434	5.436	0.002
51	478	5.248	5.390	0.142
51	503	5.188	5.355	0.167
100	354	5.300	5.616	0.316
100	363	5.326	5.642	0.316
100	366	5.224	5.454	0.231
100	383	5.181	5.536	0.355
100	417	5.268	5.459	0.191
101	513	5.394	5.657	0.263
101	526	5.111	5.348	0.237
101	532	5.359	5.549	0.190
101	533	5.238	5.479	0.241
101	534	5.262	5.444	0.182
Max		5.434	5.657	0.355
Average		5.277	5.425	0.147
Min		5.111	5.167	-0.059
Std Dev		0.088	0.131	0.124

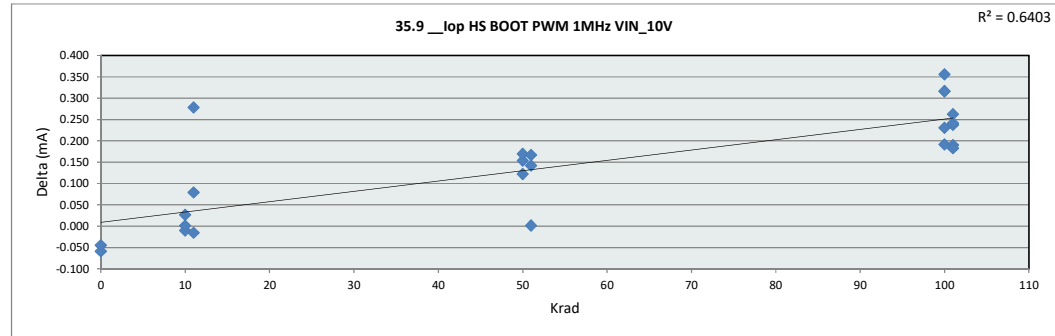

35.9 Iop HS BOOT PWM 1MHz		
Test Site	DAL	
Tester	ETS364	
Test Number	EB672303	
Max Limit	8	mA
Min Limit	1	mA

Krad	0	10	11	50	51	100	101
LL	1.000	1.000	1.000	1.000	1.000	1.000	1.000
Min	5.167	5.219	5.284	5.388	5.355	5.454	5.348
Average	5.188	5.313	5.369	5.469	5.394	5.542	5.495
Max	5.210	5.375	5.425	5.574	5.436	5.642	5.657
UL	8.000	8.000	8.000	8.000	8.000	8.000	8.000

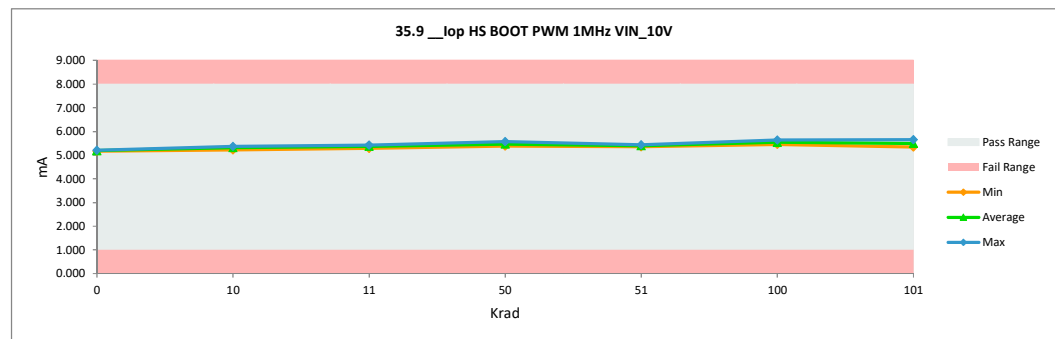

TID "HDR" Report
5962R2220102VXC

35.10_Iop LS VIN PWM 2MHz V		
Test Site	DAL	DAL
Tester	ETS364	ETS364
Test Number	EB672303	EB672303
Unit	mA	mA
Max Limit	16	16
Min Limit	1	1

Krad	Serial #	Pre_HDR_6013	Post_HDR_6013	Delta
0	1	11.615	11.562	-0.053
0	2	11.315	11.273	-0.042
10	182	11.201	11.205	0.004
10	202	11.311	11.352	0.042
10	204	11.545	11.359	-0.186
11	418	11.522	11.518	-0.003
11	419	11.429	11.457	0.028
11	443	11.340	11.401	0.061
50	259	11.388	11.551	0.163
50	346	11.479	11.602	0.124
50	347	11.324	11.450	0.126
51	462	11.327	11.480	0.153
51	478	11.533	11.349	-0.184
51	503	11.396	11.585	0.189
100	354	11.543	11.850	0.307
100	363	11.459	11.781	0.323
100	366	11.556	11.812	0.257
100	383	11.310	11.922	0.612
100	417	11.370	11.767	0.397
101	513	11.390	11.613	0.222
101	526	11.392	11.644	0.252
101	532	11.409	11.660	0.251
101	533	11.281	11.609	0.329
101	534	11.409	11.690	0.281
Max		11.615	11.922	0.612
Average		11.410	11.562	0.152
Min		11.201	11.205	-0.186
Std Dev		0.103	0.187	0.187

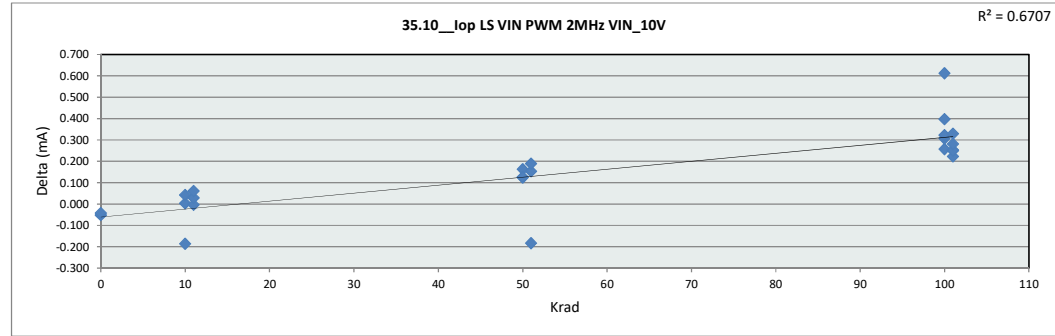

35.10_Iop LS VIN PWM 2MHz		
Test Site	DAL	
Tester	ETS364	
Test Number	EB672303	
Max Limit	16	mA
Min Limit	1	mA

Krad	0	10	11	50	51	100	101
LL	1.000	1.000	1.000	1.000	1.000	1.000	1.000
Min	11.273	11.205	11.401	11.450	11.349	11.767	11.609
Average	11.418	11.306	11.459	11.534	11.471	11.827	11.643
Max	11.562	11.359	11.518	11.602	11.585	11.922	11.690
UL	16.000	16.000	16.000	16.000	16.000	16.000	16.000

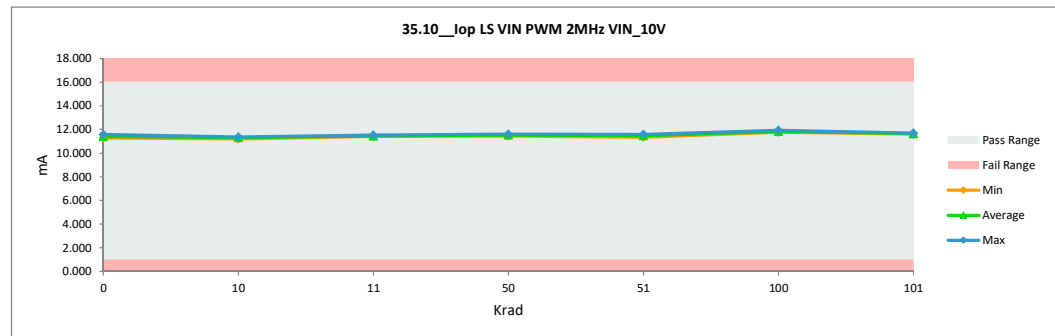

TID "HDR" Report
5962R2220102VXC

35.11_Iop HS BOOT PWM 2MHz		
Test Site	DAL	DAL
Tester	ETS364	ETS364
Test Number	EB672303	EB672303
Unit	mA	mA
Max Limit	10.5	10.5
Min Limit	1	1

Krad	Serial #	Pre_HDR_6013	Post_HDR_6013	Delta
0	1	6.934	6.874	-0.060
0	2	6.872	6.832	-0.040
10	182	6.898	6.888	-0.010
10	202	6.990	7.017	0.028
10	204	7.050	7.042	-0.008
11	418	6.816	7.110	0.294
11	419	7.080	7.071	-0.008
11	443	6.879	6.945	0.066
50	259	6.915	7.022	0.107
50	346	7.085	7.239	0.154
50	347	6.930	7.127	0.197
51	462	7.095	7.102	0.007
51	478	6.899	7.071	0.172
51	503	6.866	7.024	0.158
100	354	6.970	7.281	0.310
100	363	6.991	7.308	0.317
100	366	6.878	7.084	0.207
100	383	6.857	7.177	0.320
100	417	6.934	7.133	0.199
101	513	7.058	7.294	0.236
101	526	6.780	7.003	0.223
101	532	7.037	7.190	0.152
101	533	6.903	7.128	0.225
101	534	6.908	7.061	0.153
	Max	7.095	7.308	0.320
	Average	6.943	7.084	0.142
	Min	6.780	6.832	-0.060
	Std Dev	0.088	0.127	0.120

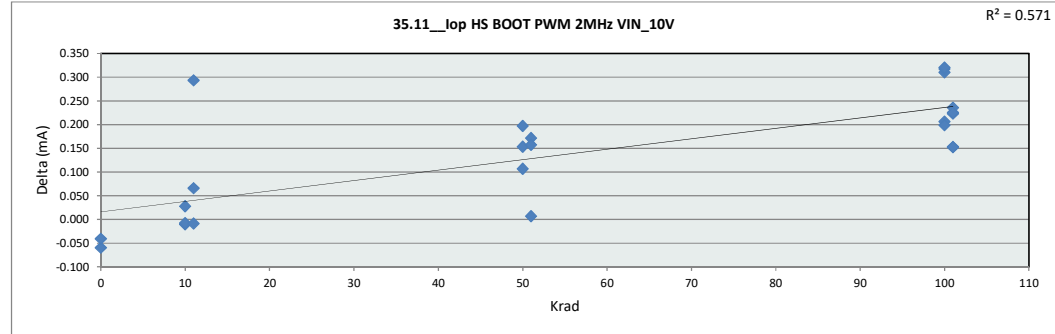

35.11_Iop HS BOOT PWM 2M		
Test Site	DAL	
Tester	ETS364	
Test Number	EB672303	
Max Limit	10.5	mA
Min Limit	1	mA

Krad	0	10	11	50	51	100	101
LL	1.000	1.000	1.000	1.000	1.000	1.000	1.000
Min	6.832	6.888	6.945	7.022	7.024	7.084	7.003
Average	6.853	6.982	7.042	7.129	7.066	7.197	7.135
Max	6.874	7.042	7.110	7.239	7.102	7.308	7.294
UL	10.500	10.500	10.500	10.500	10.500	10.500	10.500

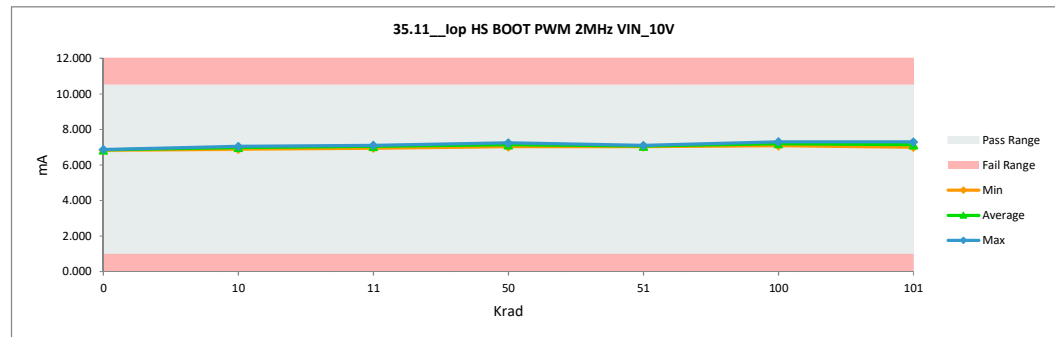

TID "HDR" Report
5962R2220102VXC

35.12 Iop LS VIN PWM 5MHz V

Test Site	DAL	DAL
Tester	ETS364	ETS364
Test Number	EB672303	EB672303
Unit	mA	mA
Max Limit	30	30
Min Limit	1	1

Krad	Serial #	Pre_HDR_6013	Post_HDR_6013	Delta
0	1	18.192	18.097	-0.095
0	2	17.959	20.099	2.139
10	182	17.732	17.821	0.090
10	202	17.943	18.116	0.173
10	204	18.293	17.919	-0.374
11	418	17.975	18.435	0.460
11	419	18.256	18.296	0.040
11	443	17.769	18.222	0.453
50	259	18.618	18.861	0.244
50	346	18.370	18.762	0.392
50	347	19.412	17.875	-1.537
51	462	18.408	18.391	-0.017
51	478	17.990	18.096	0.106
51	503	18.154	18.704	0.549
100	354	18.463	19.138	0.675
100	363	18.299	20.882	2.583
100	366	18.608	19.077	0.469
100	383	18.074	19.114	1.040
100	417	17.707	18.884	1.177
101	513	18.069	18.740	0.671
101	526	17.816	18.804	0.989
101	532	18.154	18.924	0.770
101	533	17.718	18.838	1.120
101	534	18.519	18.940	0.421
Max		19.412	20.882	2.583
Average		18.187	18.710	0.522
Min		17.707	17.821	-1.537
Std Dev		0.382	0.695	0.802

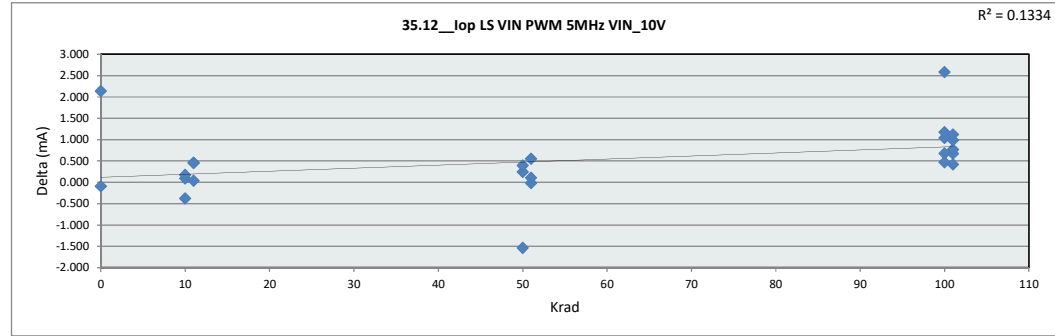

35.12 Iop LS VIN PWM 5MHz

Test Site	DAL
Tester	ETS364
Test Number	EB672303
Max Limit	30 mA
Min Limit	1 mA

Krad	0	10	11	50	51	100	101
LL	1.000	1.000	1.000	1.000	1.000	1.000	1.000
Min	18.097	17.821	18.222	17.875	18.096	18.884	18.740
Average	19.098	17.952	18.318	18.500	18.397	19.419	18.849
Max	20.099	18.116	18.435	18.861	18.704	20.882	18.940
UL	30.000	30.000	30.000	30.000	30.000	30.000	30.000

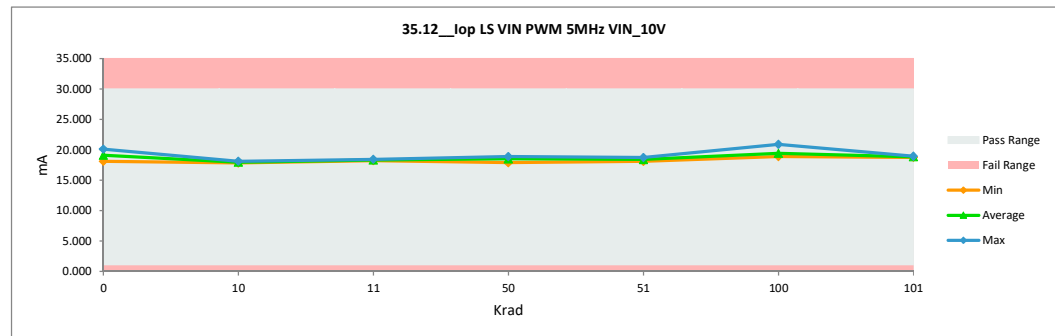

TID "HDR" Report
5962R2220102VXC

35.13_Iop HS BOOT PWM 5MHz				
Test Site	DAL	DAL		
Tester	ETS364	ETS364		
Test Number	EB672303	EB672303		
Unit	mA	mA		
Max Limit	17.5	17.5		
Min Limit	1	1		
Krad	Serial #	Pre_HDR_6013	Post_HDR_6013	Delta
0	1	13.015	13.089	0.075
0	2	10.846	10.803	-0.043
10	182	12.202	12.024	-0.178
10	202	13.188	12.726	-0.462
10	204	13.756	13.794	0.038
11	418	12.785	12.632	-0.152
11	419	13.300	13.143	-0.158
11	443	12.780	11.741	-1.039
50	259	11.022	10.740	-0.282
50	346	12.986	12.072	-0.914
50	347	13.249	13.596	0.348
51	462	13.276	11.324	-1.952
51	478	13.239	12.415	-0.825
51	503	12.819	11.564	-1.255
100	354	13.547	11.450	-2.097
100	363	13.430	12.024	-1.406
100	366	10.979	10.639	-0.340
100	383	12.470	10.826	-1.644
100	417	12.785	11.866	-0.919
101	513	12.915	11.346	-1.569
101	526	12.363	10.603	-1.760
101	532	12.632	11.027	-1.605
101	533	13.502	11.192	-2.310
101	534	10.904	10.502	-0.401
	Max	13.756	13.794	0.348
	Average	12.666	11.798	-0.869
	Min	10.846	10.502	-2.310
	Std Dev	0.876	0.976	0.781

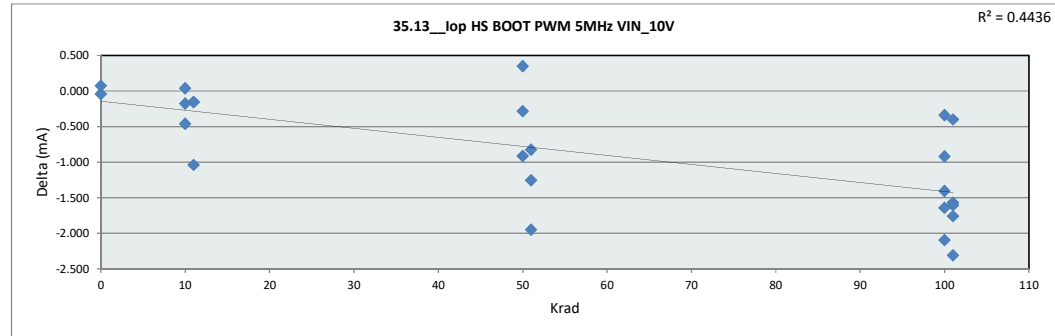

35.13_Iop HS BOOT PWM 5M							
Test Site	DAL						
Tester	ETS364						
Test Number	EB672303						
Max Limit	17.5 mA						
Min Limit	1 mA						
Krad	0	10	11	50	51	100	101
LL	1.000	1.000	1.000	1.000	1.000	1.000	1.000
Min	10.803	12.024	11.741	10.740	11.324	10.639	10.502
Average	11.946	12.848	12.505	12.136	11.768	11.361	10.934
Max	13.089	13.794	13.143	13.596	12.415	12.024	11.346
UL	17.500	17.500	17.500	17.500	17.500	17.500	17.500

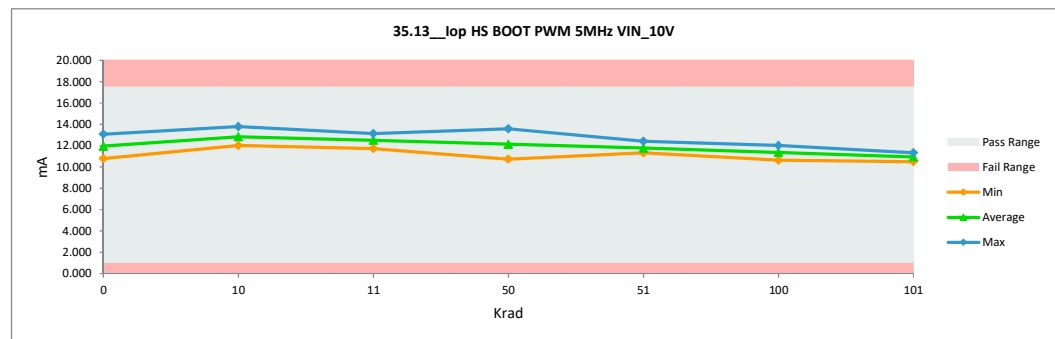

TID "HDR" Report
5962R2220102VXC

35.14_Iop LS VIN IIM Interlock

Test Site	DAL	DAL
Tester	ETS364	ETS364
Test Number	EB672303	EB672303
Unit	mA	mA
Max Limit	9	9
Min Limit	1	1

Krad	Serial #	Pre_HDR_6013	Post_HDR_6013	Delta
0	1	5.969	5.913	-0.056
0	2	5.704	5.664	-0.040
10	182	5.632	5.629	-0.003
10	202	5.723	5.760	0.037
10	204	5.928	5.710	-0.218
11	418	5.943	5.859	-0.084
11	419	5.856	5.805	-0.052
11	443	5.761	5.809	0.048
50	259	5.813	5.958	0.146
50	346	5.869	5.979	0.110
50	347	5.678	5.780	0.102
51	462	5.772	5.821	0.049
51	478	5.918	5.747	-0.171
51	503	5.783	5.971	0.188
100	354	5.886	6.172	0.286
100	363	5.828	6.167	0.339
100	366	5.957	6.197	0.241
100	383	5.766	6.279	0.513
100	417	5.800	6.077	0.277
101	513	5.793	6.022	0.229
101	526	5.732	6.005	0.273
101	532	5.780	6.033	0.253
101	533	5.701	5.995	0.294
101	534	5.833	6.120	0.287
Max		5.969	6.279	0.513
Average		5.809	5.936	0.127
Min		5.632	5.629	-0.218
Std Dev		0.092	0.180	0.180

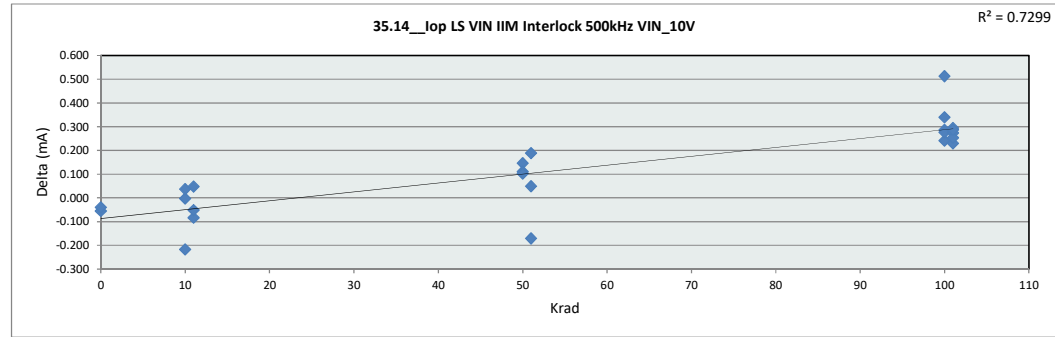

35.14_Iop LS VIN IIM Interlo

Test Site	DAL
Tester	ETS364
Test Number	EB672303
Max Limit	9 mA
Min Limit	1 mA

Krad	0	10	11	50	51	100	101
LL	1.000	1.000	1.000	1.000	1.000	1.000	1.000
Min	5.664	5.629	5.805	5.780	5.747	6.077	5.995
Average	5.789	5.699	5.824	5.906	5.846	6.179	6.035
Max	5.913	5.760	5.859	5.979	5.971	6.279	6.120
UL	9.000	9.000	9.000	9.000	9.000	9.000	9.000

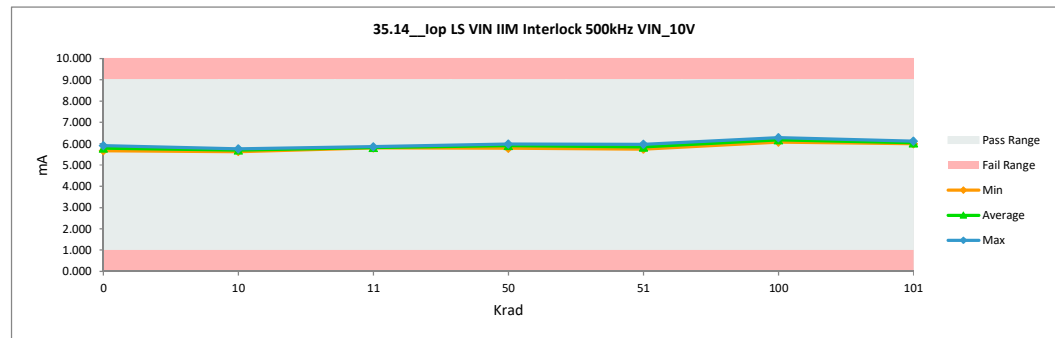

TID "HDR" Report
5962R2220102VXC

35.15 Iop HS BOOT IIM Interlock 500kHz VIN_10V		
Test Site	DAL	DAL
Tester	ETS364	ETS364
Test Number	EB672303	EB672303
Unit	mA	mA
Max Limit	6.5	6.5
Min Limit	1	1

Krad	Serial #	Pre_HDR_6013	Post_HDR_6013	Delta
0	1	4.444	4.387	-0.058
0	2	4.379	4.337	-0.042
10	182	4.409	4.399	-0.009
10	202	4.491	4.516	0.025
10	204	4.542	4.546	0.004
11	418	4.324	4.596	0.272
11	419	4.587	4.574	-0.013
11	443	4.375	4.461	0.086
50	259	4.440	4.564	0.124
50	346	4.597	4.749	0.153
50	347	4.446	4.615	0.168
51	462	4.608	4.608	0.000
51	478	4.427	4.561	0.134
51	503	4.357	4.523	0.167
100	354	4.476	4.789	0.313
100	363	4.507	4.812	0.305
100	366	4.401	4.632	0.231
100	383	4.353	4.710	0.357
100	417	4.447	4.630	0.183
101	513	4.570	4.834	0.264
101	526	4.285	4.516	0.231
101	532	4.536	4.726	0.190
101	533	4.417	4.654	0.237
101	534	4.438	4.627	0.188
	Max	4.608	4.834	0.357
	Average	4.452	4.599	0.146
	Min	4.285	4.337	-0.058
	Std Dev	0.088	0.131	0.122

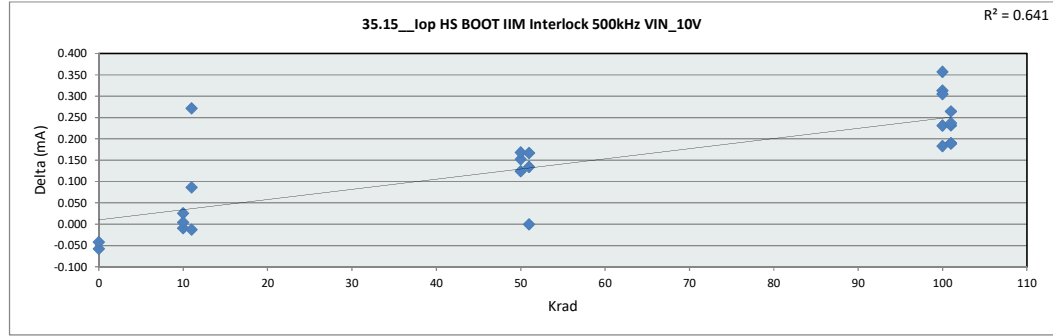

35.15 Iop HS BOOT IIM Interlock 500kHz VIN_10V		
Test Site	DAL	
Tester	ETS364	
Test Number	EB672303	
Max Limit	6.5	mA
Min Limit	1	mA

Krad	0	10	11	50	51	100	101
LL	1.000	1.000	1.000	1.000	1.000	1.000	1.000
Min	4.337	4.399	4.461	4.564	4.523	4.630	4.516
Average	4.362	4.487	4.544	4.642	4.564	4.715	4.671
Max	4.387	4.546	4.596	4.749	4.608	4.812	4.835
UL	6.500	6.500	6.500	6.500	6.500	6.500	6.500

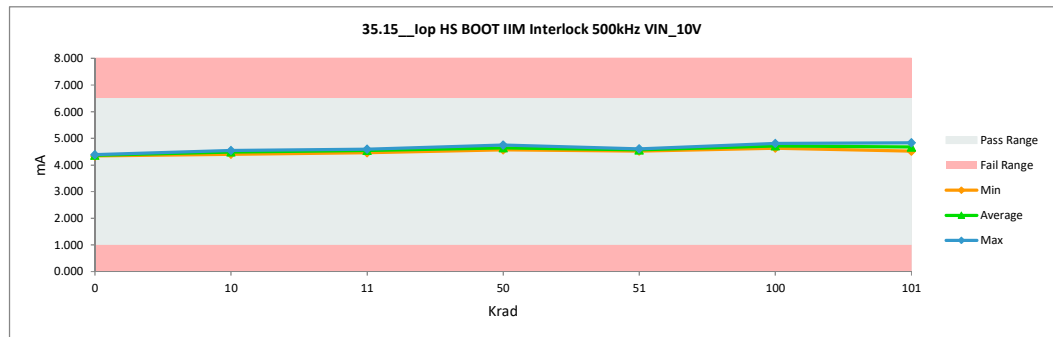

TID "HDR" Report
5962R2220102VXC

35.16_Iop LS VIN IIM Interlock

Test Site	DAL	DAL
Tester	ETS364	ETS364
Test Number	EB672303	EB672303
Unit	mA	mA
Max Limit	12	12
Min Limit	1	1

Krad	Serial #	Pre_HDR_6013	Post_HDR_6013	Delta
0	1	7.438	7.379	-0.059
0	2	7.168	7.124	-0.045
10	182	7.084	7.087	0.002
10	202	7.177	7.223	0.046
10	204	7.394	7.180	-0.214
11	418	7.407	7.333	-0.074
11	419	7.320	7.272	-0.049
11	443	7.218	7.264	0.046
50	259	7.269	7.438	0.169
50	346	7.328	7.456	0.128
50	347	7.139	7.263	0.123
51	462	7.235	7.312	0.077
51	478	7.375	7.227	-0.148
51	503	7.246	7.457	0.211
100	354	7.357	7.677	0.319
100	363	7.284	7.664	0.380
100	366	7.417	7.692	0.275
100	383	7.221	7.776	0.555
100	417	7.254	7.584	0.330
101	513	7.257	7.518	0.261
101	526	7.195	7.503	0.308
101	532	7.252	7.537	0.285
101	533	7.160	7.492	0.332
101	534	7.297	7.612	0.315
	Max	7.438	7.776	0.555
	Average	7.271	7.420	0.149
	Min	7.084	7.087	-0.214
	Std Dev	0.095	0.193	0.193

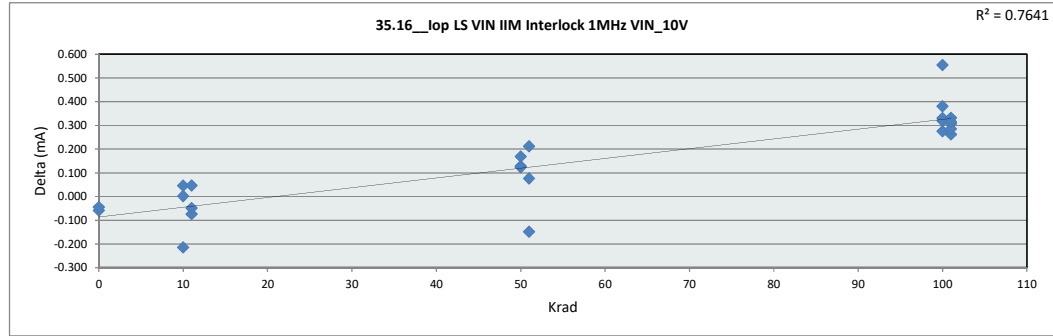

35.16_Iop LS VIN IIM Interlo

Test Site	DAL
Tester	ETS364
Test Number	EB672303
Max Limit	12 mA
Min Limit	1 mA

Krad	0	10	11	50	51	100	101
LL	1.000	1.000	1.000	1.000	1.000	1.000	1.000
Min	7.124	7.087	7.264	7.263	7.227	7.584	7.492
Average	7.251	7.163	7.290	7.385	7.332	7.679	7.533
Max	7.379	7.223	7.333	7.456	7.457	7.776	7.612
UL	12.000	12.000	12.000	12.000	12.000	12.000	12.000

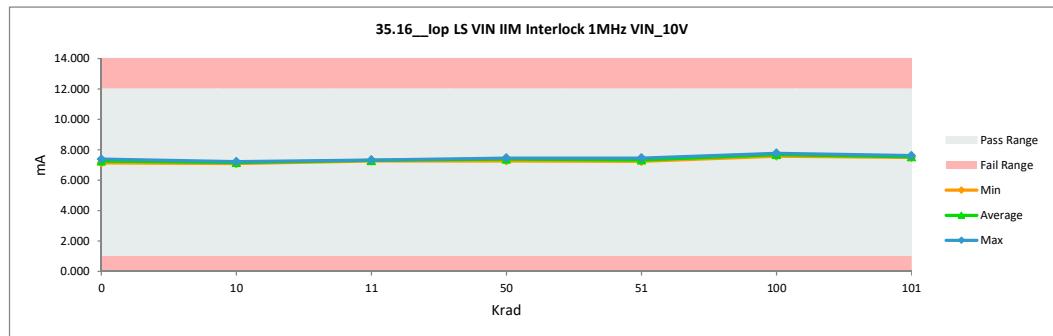

TID "HDR" Report
5962R2220102VXC

35.17__Iop HS BOOT IIM Interlock		
Test Site	DAL	
Tester	ETS364	
Test Number	EB672303	
Unit	mA	
Max Limit	8	
Min Limit	1	

Krad	Serial #	Pre_HDR_6013	Post_HDR_6013	Delta
0	1	5.268	5.210	-0.058
0	2	5.206	5.165	-0.042
10	182	5.236	5.223	-0.013
10	202	5.315	5.340	0.025
10	204	5.372	5.375	0.003
11	418	5.149	5.428	0.279
11	419	5.413	5.402	-0.011
11	443	5.201	5.286	0.085
50	259	5.260	5.385	0.125
50	346	5.419	5.571	0.152
50	347	5.271	5.443	0.172
51	462	5.435	5.438	0.003
51	478	5.246	5.390	0.144
51	503	5.189	5.353	0.164
100	354	5.304	5.619	0.315
100	363	5.330	5.634	0.304
100	366	5.221	5.455	0.233
100	383	5.179	5.534	0.355
100	417	5.273	5.458	0.186
101	513	5.394	5.655	0.261
101	526	5.110	5.341	0.231
101	532	5.362	5.552	0.191
101	533	5.240	5.477	0.237
101	534	5.260	5.445	0.185
	Max	5.435	5.655	0.355
	Average	5.277	5.424	0.147
	Min	5.110	5.165	-0.058
	Std Dev	0.088	0.130	0.122

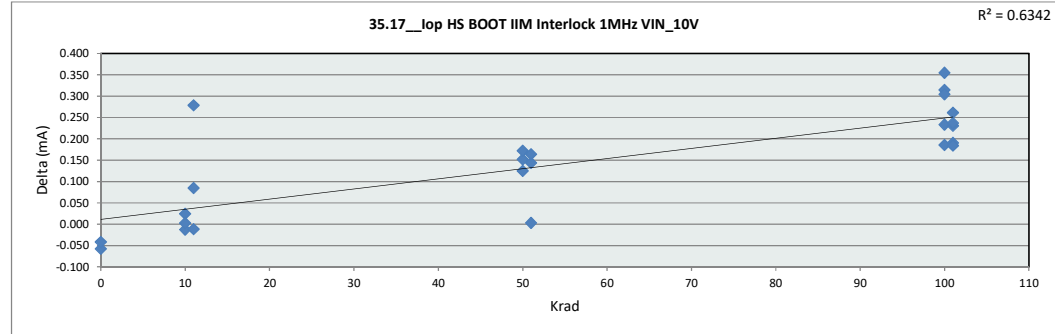

35.17__Iop HS BOOT IIM Interlock		
Test Site	DAL	
Tester	ETS364	
Test Number	EB672303	
Max Limit	8 mA	
Min Limit	1 mA	

Krad	0	10	11	50	51	100	101
LL	1.000	1.000	1.000	1.000	1.000	1.000	1.000
Min	5.165	5.223	5.286	5.385	5.353	5.455	5.341
Average	5.187	5.313	5.372	5.466	5.393	5.540	5.494
Max	5.210	5.375	5.428	5.571	5.438	5.634	5.655
UL	8.000	8.000	8.000	8.000	8.000	8.000	8.000

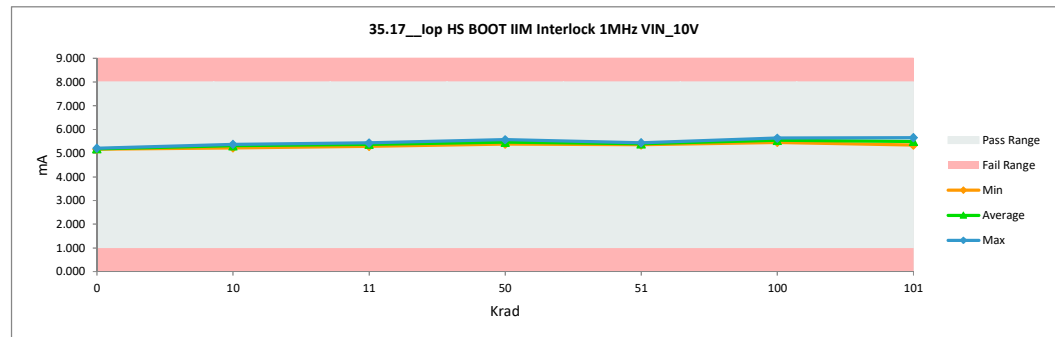

TID "HDR" Report
5962R2220102VXC

35.18_Iop LS VIN IIM Interlock

Test Site	DAL	DAL
Tester	ETS364	ETS364
Test Number	EB672303	EB672303
Unit	mA	mA
Max Limit	17	17
Min Limit	1	1

Krad	Serial #	Pre_HDR_6013	Post_HDR_6013	Delta
0	1	10.368	10.304	-0.064
0	2	10.085	10.038	-0.048
10	182	9.983	9.992	0.010
10	202	10.081	10.138	0.057
10	204	10.322	10.111	-0.211
11	418	10.327	10.273	-0.054
11	419	10.238	10.201	-0.037
11	443	10.123	10.170	0.046
50	259	10.177	10.390	0.213
50	346	10.237	10.409	0.172
50	347	10.055	10.224	0.168
51	462	10.151	10.290	0.139
51	478	10.278	10.182	-0.096
51	503	10.169	10.421	0.252
100	354	10.290	10.684	0.394
100	363	10.194	10.652	0.458
100	366	10.328	10.677	0.348
100	383	10.125	10.766	0.641
100	417	10.159	10.589	0.431
101	513	10.182	10.505	0.323
101	526	10.116	10.490	0.374
101	532	10.186	10.537	0.351
101	533	10.071	10.483	0.412
101	534	10.217	10.592	0.375
Max		10.368	10.766	0.641
Average		10.186	10.380	0.194
Min		9.983	9.992	-0.211
Std Dev		0.099	0.221	0.220

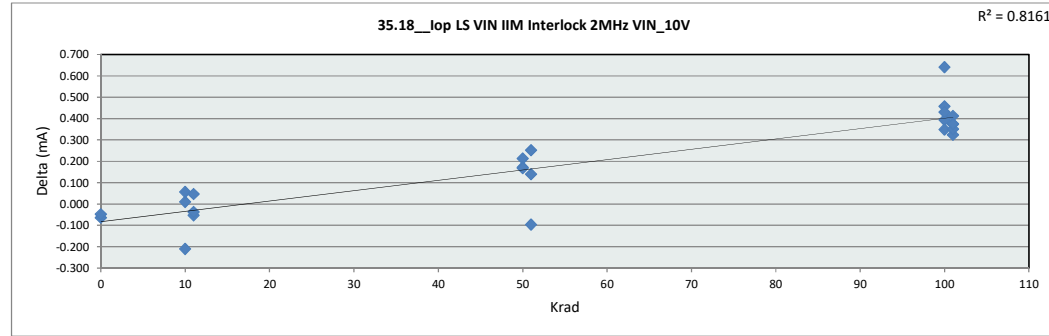

35.18_Iop LS VIN IIM Interlo

Test Site	DAL
Tester	ETS364
Test Number	EB672303
Max Limit	17 mA
Min Limit	1 mA

Krad	0	10	11	50	51	100	101
LL	1.000	1.000	1.000	1.000	1.000	1.000	1.000
Min	10.038	9.992	10.170	10.224	10.182	10.589	10.483
Average	10.171	10.080	10.215	10.341	10.298	10.674	10.521
Max	10.304	10.138	10.273	10.409	10.421	10.766	10.592
UL	17.000	17.000	17.000	17.000	17.000	17.000	17.000

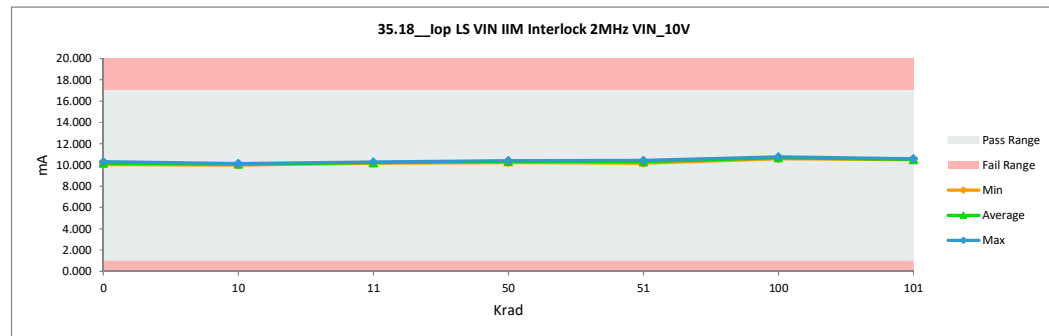

TID "HDR" Report
5962R2220102VXC

35.19_Iop HS BOOT IIM Interlock		
Test Site	DAL	
Tester	ETS364	
Test Number	EB672303	
Unit	mA	
Max Limit	10.5	
Min Limit	1	

Krad	Serial #	Pre_HDR_6013	Post_HDR_6013	Delta
0	1	6.908	6.851	-0.057
0	2	6.860	6.818	-0.042
10	182	6.882	6.870	-0.012
10	202	6.963	6.989	0.026
10	204	7.027	7.030	0.003
11	418	6.795	7.088	0.293
11	419	7.066	7.050	-0.016
11	443	6.846	6.932	0.086
50	259	6.897	7.026	0.129
50	346	7.052	7.207	0.154
50	347	6.918	7.094	0.176
51	462	7.083	7.091	0.008
51	478	6.890	7.042	0.152
51	503	6.845	7.006	0.161
100	354	6.953	7.271	0.318
100	363	6.973	7.280	0.307
100	366	6.862	7.092	0.231
100	383	6.827	7.179	0.352
100	417	6.917	7.105	0.188
101	513	7.031	7.292	0.261
101	526	6.756	6.992	0.235
101	532	7.015	7.204	0.189
101	533	6.878	7.114	0.236
101	534	6.895	7.077	0.182
	Max	7.083	7.292	0.352
	Average	6.922	7.071	0.148
	Min	6.756	6.818	-0.057
	Std Dev	0.088	0.128	0.123

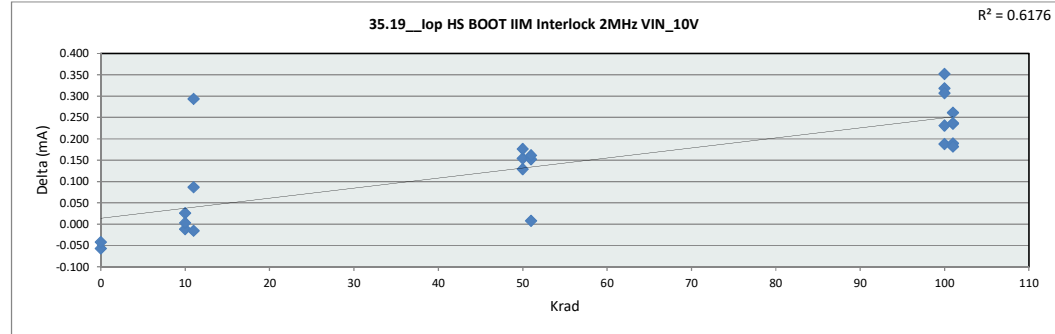

35.19_Iop HS BOOT IIM Interlock		
Test Site	DAL	
Tester	ETS364	
Test Number	EB672303	
Max Limit	10.5 mA	
Min Limit	1 mA	

Krad	0	10	11	50	51	100	101
LL	1.000	1.000	1.000	1.000	1.000	1.000	1.000
Min	6.818	6.870	6.932	7.026	7.006	7.092	6.992
Average	6.834	6.963	7.024	7.109	7.046	7.185	7.136
Max	6.851	7.030	7.088	7.207	7.091	7.280	7.292
UL	10.500	10.500	10.500	10.500	10.500	10.500	10.500

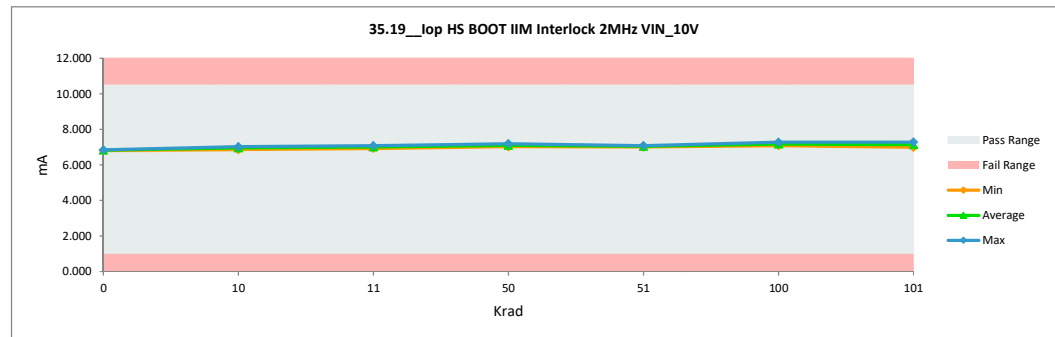

TID "HDR" Report
5962R2220102VXC

35.20 Top LS VIN IIM Interlock

Test Site	DAL	DAL
Tester	ETS364	ETS364
Test Number	EB672303	EB672303
Unit	mA	mA
Max Limit	30	30
Min Limit	1	1

Krad	Serial #	Pre_HDR_6013	Post_HDR_6013	Delta
0	1	19.437	19.393	-0.044
0	2	19.103	19.087	-0.015
10	182	18.966	19.013	0.047
10	202	19.070	19.191	0.121
10	204	19.385	19.218	-0.166
11	418	19.389	19.378	-0.011
11	419	19.251	19.294	0.042
11	443	19.117	19.167	0.049
50	259	19.163	19.531	0.369
50	346	19.256	19.561	0.304
50	347	19.112	19.415	0.303
51	462	19.170	19.523	0.353
51	478	19.273	19.328	0.055
51	503	19.231	19.604	0.373
100	354	19.369	19.994	0.625
100	363	19.215	19.923	0.708
100	366	19.362	19.895	0.534
100	383	19.135	20.034	0.898
100	417	19.140	19.913	0.772
101	513	19.233	19.756	0.523
101	526	19.197	19.758	0.560
101	532	19.270	19.823	0.553
101	533	19.102	19.761	0.659
101	534	19.270	19.809	0.540
Max		19.437	20.034	0.898
Average		19.217	19.557	0.340
Min		18.966	19.013	-0.166
Std Dev		0.116	0.307	0.300

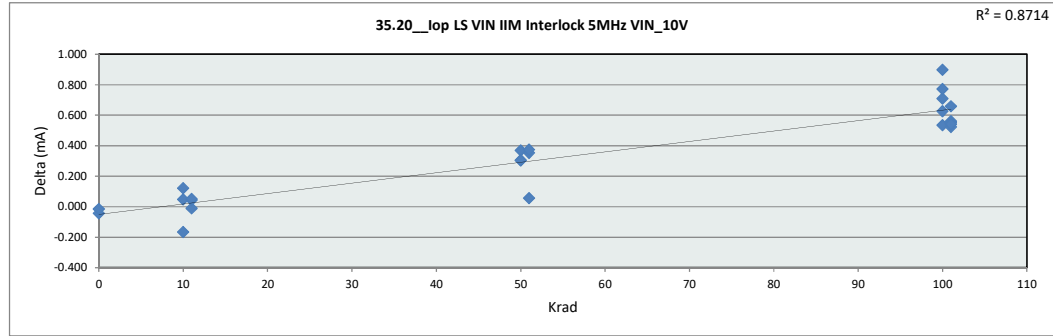

35.20 Top LS VIN IIM Interlo

Test Site	DAL
Tester	ETS364
Test Number	EB672303
Max Limit	30 mA
Min Limit	1 mA

Krad	0	10	11	50	51	100	101
LL	1.000	1.000	1.000	1.000	1.000	1.000	1.000
Min	19.087	19.013	19.167	19.415	19.328	19.895	19.756
Average	19.240	19.141	19.279	19.502	19.485	19.952	19.782
Max	19.393	19.218	19.378	19.561	19.604	20.034	19.823
UL	30.000	30.000	30.000	30.000	30.000	30.000	30.000

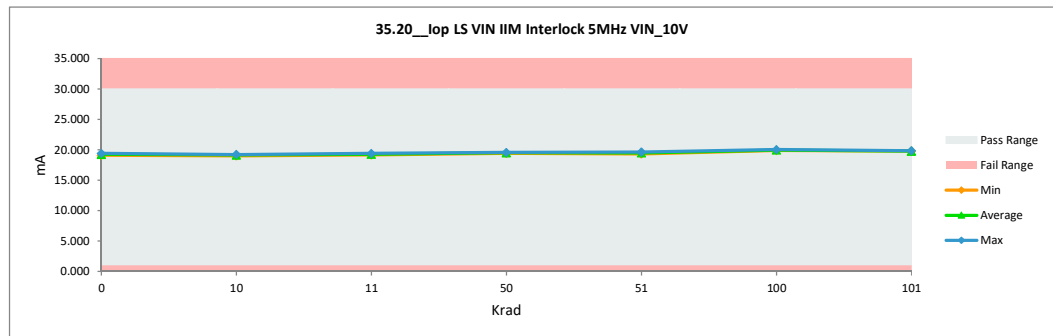

TID "HDR" Report
5962R2220102VXC

35.21_Iop HS BOOT IIM Interlock		
Test Site	DAL	DAL
Tester	ETS364	ETS364
Test Number	EB672303	EB672303
Unit	mA	mA
Max Limit	15	15
Min Limit	1	1

Krad	Serial #	Pre_HDR_6013	Post_HDR_6013	Delta
0	1	11.538	11.477	-0.060
0	2	11.568	11.518	-0.050
10	182	11.555	11.537	-0.018
10	202	11.655	11.691	0.036
10	204	11.705	11.710	0.004
11	418	11.444	11.780	0.336
11	419	11.745	11.718	-0.028
11	443	11.489	11.621	0.132
50	259	11.512	11.636	0.124
50	346	11.670	11.820	0.149
50	347	11.592	11.763	0.171
51	462	11.762	11.787	0.025
51	478	11.545	11.716	0.171
51	503	11.531	11.704	0.173
100	354	11.627	11.948	0.321
100	363	11.622	11.942	0.320
100	366	11.490	11.715	0.224
100	383	11.540	11.868	0.328
100	417	11.573	11.773	0.200
101	513	11.657	11.953	0.296
101	526	11.421	11.681	0.260
101	532	11.705	11.894	0.189
101	533	11.519	11.771	0.253
101	534	11.538	11.735	0.198
Max		11.762	11.953	0.336
Average		11.584	11.740	0.156
Min		11.421	11.477	-0.060
Std Dev		0.092	0.128	0.128

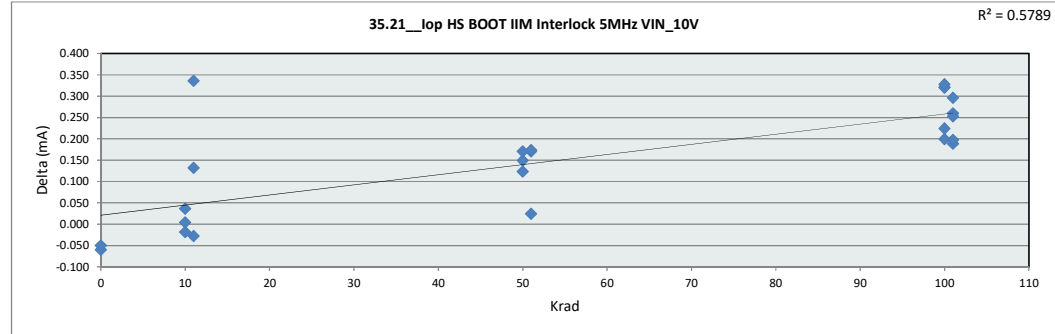

35.21_Iop HS BOOT IIM Interlock		
Test Site	DAL	
Tester	ETS364	
Test Number	EB672303	
Max Limit	15	mA
Min Limit	1	mA

	0	10	11	50	51	100	101
LL	1.000	1.000	1.000	1.000	1.000	1.000	1.000
Min	11.477	11.537	11.621	11.636	11.704	11.715	11.681
Average	11.498	11.646	11.706	11.740	11.736	11.849	11.807
Max	11.518	11.710	11.780	11.820	11.787	11.948	11.953
UL	15.000	15.000	15.000	15.000	15.000	15.000	15.000

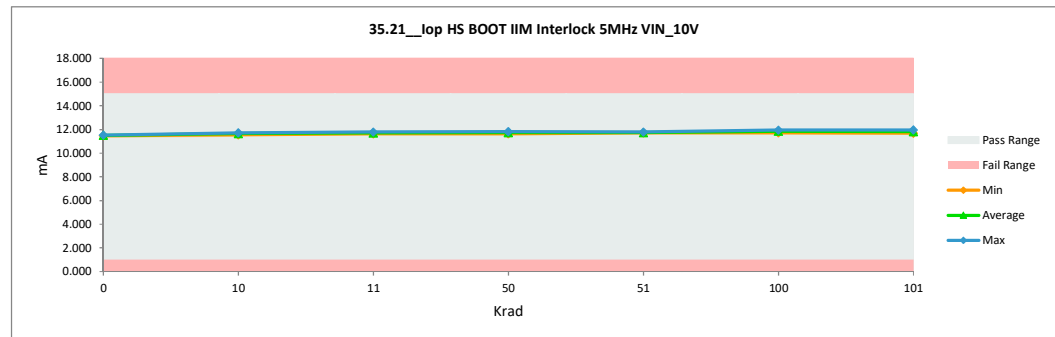

TID "HDR" Report
5962R2220102VXC

36.0 Iq LS VIN PWM VIN 12V		
Test Site	DAL	DAL
Tester	ETS364	ETS364
Test Number	EB672303	EB672303
Unit	mA	mA
Max Limit	6.8	6.8
Min Limit	1	1

Krad	Serial #	Pre_HDR_6013	Post_HDR_6013	Delta
0	1	4.457	4.402	-0.055
0	2	4.214	4.173	-0.041
10	182	4.149	4.147	-0.002
10	202	4.242	4.280	0.037
10	204	4.453	4.207	-0.246
11	418	4.474	4.355	-0.119
11	419	4.393	4.295	-0.098
11	443	4.288	4.327	0.039
50	259	4.338	4.483	0.145
50	346	4.385	4.497	0.112
50	347	4.180	4.284	0.104
51	462	4.319	4.329	0.010
51	478	4.432	4.272	-0.160
51	503	4.299	4.497	0.198
100	354	4.391	4.679	0.289
100	363	4.329	4.686	0.357
100	366	4.468	4.709	0.242
100	383	4.303	4.782	0.479
100	417	4.332	4.579	0.248
101	513	4.319	4.564	0.245
101	526	4.215	4.518	0.303
101	532	4.300	4.570	0.270
101	533	4.231	4.532	0.302
101	534	4.358	4.662	0.304
	Max	4.474	4.782	0.479
	Average	4.328	4.451	0.123
	Min	4.149	4.147	-0.246
	Std Dev	0.092	0.183	0.187

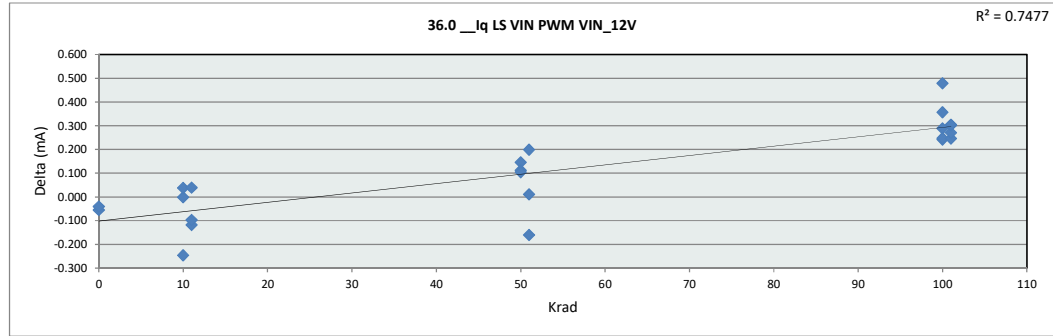

36.0 Iq LS VIN PWM VIN 12		
Test Site	DAL	
Tester	ETS364	
Test Number	EB672303	
Max Limit	6.8	mA
Min Limit	1	mA

Krad	0	10	11	50	51	100	101
LL	1.000	1.000	1.000	1.000	1.000	1.000	1.000
Min	4.173	4.147	4.295	4.284	4.272	4.579	4.518
Average	4.288	4.211	4.326	4.421	4.366	4.687	4.569
Max	4.402	4.280	4.355	4.497	4.498	4.782	4.662
UL	6.800	6.800	6.800	6.800	6.800	6.800	6.800

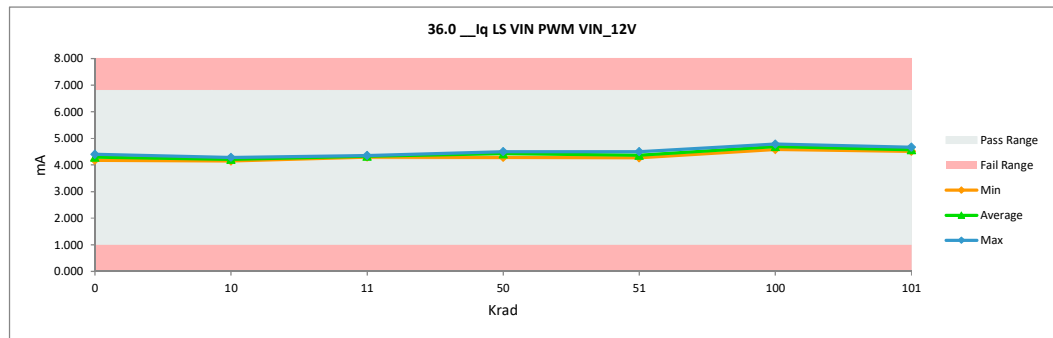

TID "HDR" Report
5962R2220102VXC

36.1 Iq HS BOOT PWM VIN_12		
Test Site	DAL	DAL
Tester	ETS364	ETS364
Test Number	EB672303	EB672303
Unit	mA	mA
Max Limit	6.3	6.3
Min Limit	1	1

Krad	Serial #	Pre_HDR_6013	Post_HDR_6013	Delta
0	1	3.643	3.582	-0.060
0	2	3.571	3.529	-0.043
10	182	3.604	3.591	-0.013
10	202	3.685	3.708	0.023
10	204	3.734	3.736	0.003
11	418	3.519	3.782	0.263
11	419	3.781	3.766	-0.015
11	443	3.569	3.656	0.087
50	259	3.638	3.761	0.123
50	346	3.797	3.947	0.149
50	347	3.639	3.803	0.164
51	462	3.801	3.798	-0.003
51	478	3.626	3.754	0.128
51	503	3.549	3.716	0.167
100	354	3.670	3.980	0.310
100	363	3.702	4.005	0.303
100	366	3.599	3.828	0.229
100	383	3.549	3.907	0.357
100	417	3.645	3.825	0.180
101	513	3.768	4.036	0.268
101	526	3.478	3.712	0.234
101	532	3.725	3.921	0.196
101	533	3.615	3.857	0.242
101	534	3.639	3.828	0.189
Max		3.801	4.036	0.357
Average		3.648	3.793	0.145
Min		3.478	3.529	-0.060
Std Dev		0.088	0.132	0.123

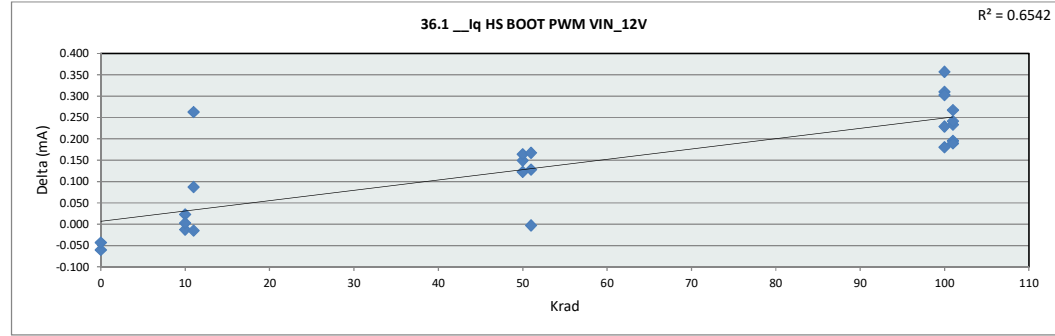

36.1 Iq HS BOOT PWM VIN		
Test Site	DAL	
Tester	ETS364	
Test Number	EB672303	
Max Limit	6.3	mA
Min Limit	1	mA

Krad	0	10	11	50	51	100	101
LL	1.000	1.000	1.000	1.000	1.000	1.000	1.000
Min	3.529	3.591	3.656	3.761	3.716	3.825	3.712
Average	3.555	3.678	3.735	3.837	3.756	3.909	3.871
Max	3.582	3.736	3.782	3.947	3.798	4.005	4.036
UL	6.300	6.300	6.300	6.300	6.300	6.300	6.300

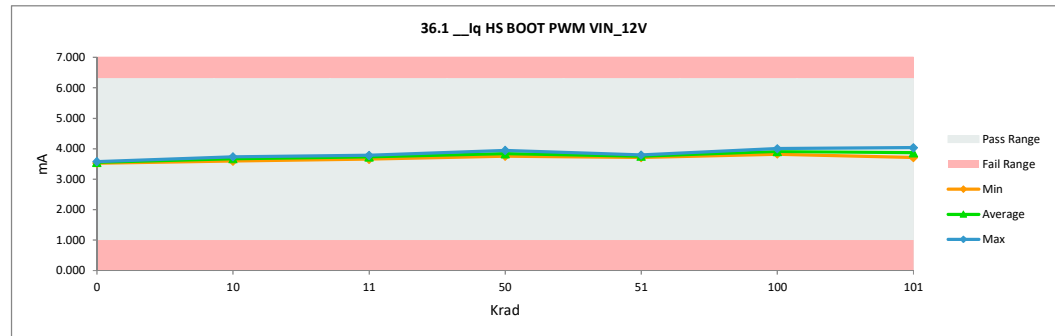

TID "HDR" Report
5962R2220102VXC

36.2 __Iq LS VIN IIM Interlock V		
Test Site	DAL	DAL
Tester	ETS364	ETS364
Test Number	EB672303	EB672303
Unit	mA	mA
Max Limit	8	8
Min Limit	1	1

Krad	Serial #	Pre_HDR_6013	Post_HDR_6013	Delta
0	1	4.386	4.331	-0.055
0	2	4.143	4.103	-0.040
10	182	4.078	4.077	-0.001
10	202	4.171	4.209	0.038
10	204	4.381	4.136	-0.245
11	418	4.402	4.284	-0.118
11	419	4.322	4.224	-0.098
11	443	4.218	4.255	0.038
50	259	4.267	4.411	0.144
50	346	4.313	4.424	0.110
50	347	4.110	4.213	0.103
51	462	4.249	4.257	0.007
51	478	4.362	4.200	-0.162
51	503	4.228	4.425	0.197
100	354	4.320	4.607	0.288
100	363	4.259	4.614	0.355
100	366	4.397	4.637	0.240
100	383	4.232	4.708	0.476
100	417	4.261	4.507	0.247
101	513	4.248	4.493	0.245
101	526	4.143	4.445	0.302
101	532	4.228	4.496	0.269
101	533	4.160	4.461	0.301
101	534	4.287	4.590	0.303
	Max	4.402	4.708	0.476
	Average	4.257	4.380	0.123
	Min	4.078	4.077	-0.245
	Std Dev	0.092	0.182	0.186

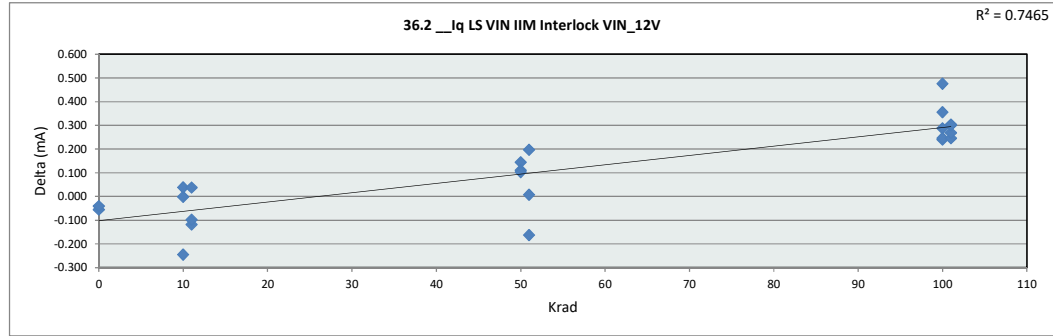

36.2 __Iq LS VIN IIM Interlock

Test Site	DAL	
Tester	ETS364	
Test Number	EB672303	
Max Limit	8	mA
Min Limit	1	mA

Krad	0	10	11	50	51	100	101
LL	1.000	1.000	1.000	1.000	1.000	1.000	1.000
Min	4.103	4.077	4.224	4.213	4.200	4.507	4.445
Average	4.217	4.141	4.255	4.350	4.294	4.615	4.497
Max	4.331	4.209	4.284	4.424	4.425	4.708	4.590
UL	8.000	8.000	8.000	8.000	8.000	8.000	8.000

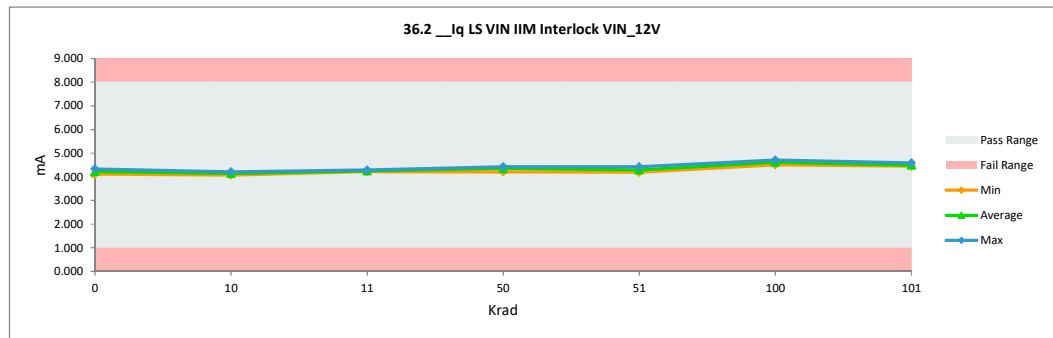

TID "HDR" Report
5962R2220102VXC

36.3 Iq HS BOOT IIM Interlock		
Test Site	DAL	DAL
Tester	ETS364	ETS364
Test Number	EB672303	EB672303
Unit	mA	mA
Max Limit	6.3	6.3
Min Limit	1	1

Krad	Serial #	Pre_HDR_6013	Post_HDR_6013	Delta
0	1	3.642	3.583	-0.059
0	2	3.571	3.528	-0.043
10	182	3.604	3.591	-0.013
10	202	3.685	3.708	0.023
10	204	3.734	3.736	0.002
11	418	3.519	3.783	0.263
11	419	3.781	3.766	-0.015
11	443	3.569	3.656	0.087
50	259	3.638	3.759	0.121
50	346	3.797	3.946	0.149
50	347	3.639	3.802	0.163
51	462	3.802	3.798	-0.004
51	478	3.626	3.753	0.127
51	503	3.548	3.715	0.167
100	354	3.669	3.981	0.312
100	363	3.703	4.005	0.302
100	366	3.599	3.829	0.230
100	383	3.549	3.908	0.359
100	417	3.644	3.824	0.180
101	513	3.768	4.036	0.267
101	526	3.478	3.711	0.233
101	532	3.725	3.922	0.198
101	533	3.615	3.856	0.240
101	534	3.638	3.826	0.187
	Max	3.802	4.036	0.359
	Average	3.648	3.793	0.145
	Min	3.478	3.528	-0.059
	Std Dev	0.088	0.132	0.123

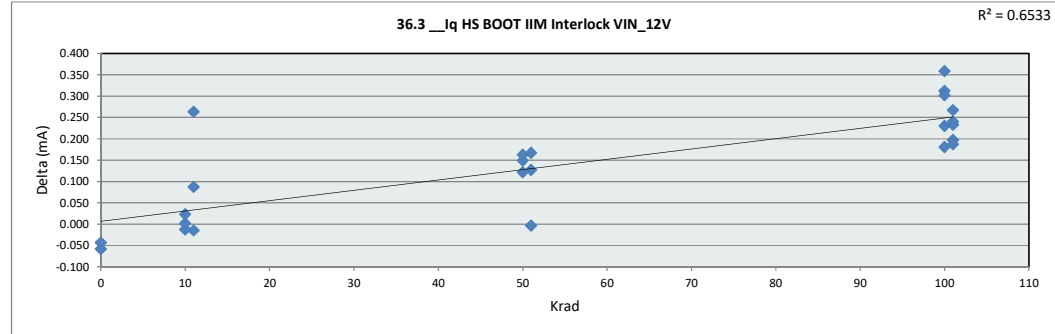

36.3 Iq HS BOOT IIM Interlock		
Test Site	DAL	
Tester	ETS364	
Test Number	EB672303	
Max Limit	6.3	mA
Min Limit	1	mA

Krad	0	10	11	50	51	100	101
LL	1.000	1.000	1.000	1.000	1.000	1.000	1.000
Min	3.528	3.591	3.656	3.759	3.715	3.824	3.711
Average	3.556	3.678	3.735	3.836	3.756	3.909	3.870
Max	3.583	3.736	3.783	3.946	3.798	4.005	4.036
UL	6.300	6.300	6.300	6.300	6.300	6.300	6.300

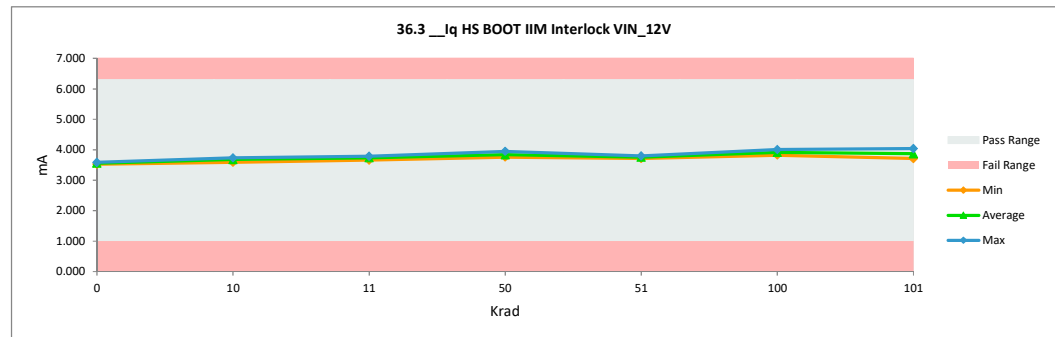

TID "HDR" Report
5962R2220102VXC

36.6 Iop LS VIN PWM 500kHz		
Test Site	DAL	DAL
Tester	ETS364	ETS364
Test Number	EB672303	EB672303
Unit	mA	mA
Max Limit	9	9
Min Limit	1	1

Krad	Serial #	Pre_HDR_6013	Post_HDR_6013	Delta
0	1	6.565	6.519	-0.046
0	2	6.277	6.242	-0.035
10	182	6.201	6.190	-0.011
10	202	6.294	6.318	0.024
10	204	6.474	6.295	-0.179
11	418	6.470	6.454	-0.016
11	419	6.383	6.403	0.020
11	443	6.307	6.386	0.079
50	259	6.378	6.465	0.087
50	346	6.450	6.501	0.051
50	347	6.292	6.334	0.042
51	462	6.276	6.348	0.071
51	478	6.495	6.237	-0.259
51	503	6.360	6.485	0.125
100	354	6.480	6.658	0.178
100	363	6.422	6.633	0.211
100	366	6.536	6.679	0.143
100	383	6.291	6.771	0.481
100	417	6.342	6.580	0.238
101	513	6.357	6.470	0.113
101	526	6.363	6.511	0.147
101	532	6.353	6.492	0.139
101	533	6.253	6.446	0.194
101	534	6.383	6.563	0.180
	Max	6.565	6.771	0.481
	Average	6.375	6.457	0.082
	Min	6.201	6.190	-0.259
	Std Dev	0.095	0.148	0.146

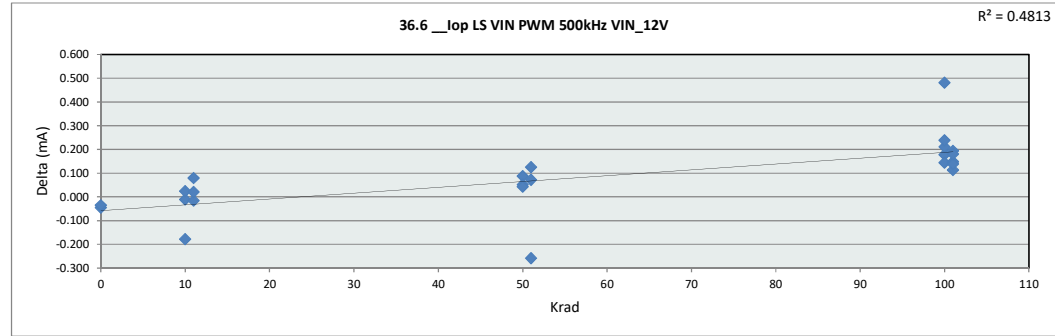

36.6 Iop LS VIN PWM 500kHz		
Test Site	DAL	
Tester	ETS364	
Test Number	EB672303	
Max Limit	9	mA
Min Limit	1	mA

Krad	0	10	11	50	51	100	101
LL	1.000	1.000	1.000	1.000	1.000	1.000	1.000
Min	6.242	6.190	6.386	6.334	6.237	6.580	6.446
Average	6.380	6.268	6.414	6.433	6.356	6.664	6.496
Max	6.519	6.318	6.454	6.501	6.485	6.771	6.563
UL	9.000	9.000	9.000	9.000	9.000	9.000	9.000

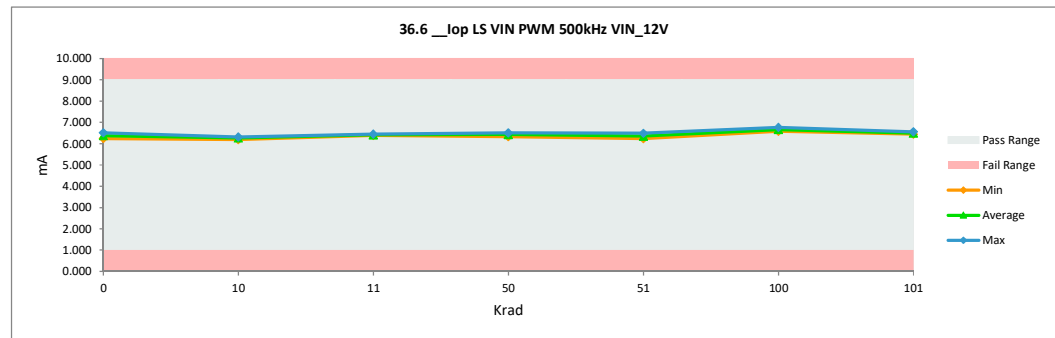

TID "HDR" Report
5962R2220102VXC

36.7 Iop HS BOOT PWM 500kHz		
Test Site	DAL	DAL
Tester	ETS364	ETS364
Test Number	EB672303	EB672303
Unit	mA	mA
Max Limit	6.5	6.5
Min Limit	1	1

Krad	Serial #	Pre_HDR_6013	Post_HDR_6013	Delta
0	1	4.468	4.407	-0.061
0	2	4.403	4.359	-0.044
10	182	4.429	4.415	-0.014
10	202	4.514	4.536	0.022
10	204	4.567	4.566	-0.001
11	418	4.345	4.617	0.272
11	419	4.609	4.594	-0.015
11	443	4.399	4.482	0.083
50	259	4.463	4.585	0.122
50	346	4.621	4.772	0.151
50	347	4.470	4.634	0.164
51	462	4.631	4.630	0.000
51	478	4.451	4.583	0.133
51	503	4.382	4.549	0.167
100	354	4.497	4.811	0.313
100	363	4.529	4.835	0.307
100	366	4.425	4.653	0.228
100	383	4.377	4.733	0.356
100	417	4.467	4.655	0.188
101	513	4.592	4.859	0.267
101	526	4.306	4.539	0.232
101	532	4.555	4.751	0.196
101	533	4.438	4.682	0.243
101	534	4.461	4.650	0.189
	Max	4.631	4.859	0.356
	Average	4.475	4.621	0.146
	Min	4.306	4.359	-0.061
	Std Dev	0.088	0.132	0.124

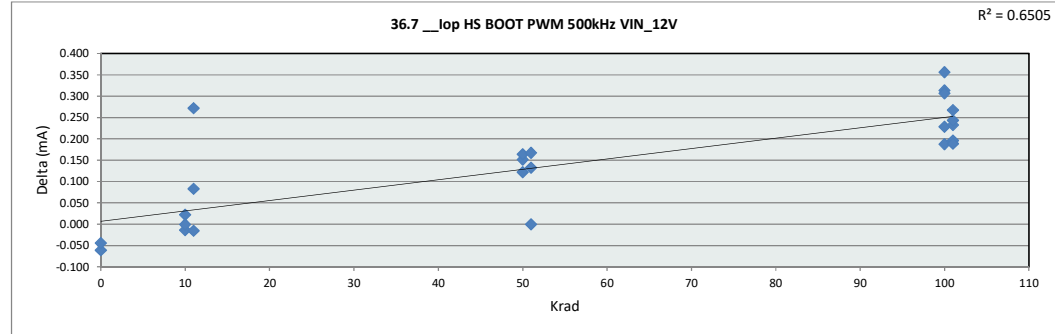

36.7 Iop HS BOOT PWM 500		
Test Site	DAL	
Tester	ETS364	
Test Number	EB672303	
Max Limit	6.5	mA
Min Limit	1	mA

Krad	0	10	11	50	51	100	101
LL	1.000	1.000	1.000	1.000	1.000	1.000	1.000
Min	4.359	4.415	4.482	4.585	4.549	4.653	4.539
Average	4.383	4.506	4.564	4.664	4.588	4.737	4.696
Max	4.407	4.566	4.617	4.772	4.630	4.835	4.860
UL	6.500	6.500	6.500	6.500	6.500	6.500	6.500

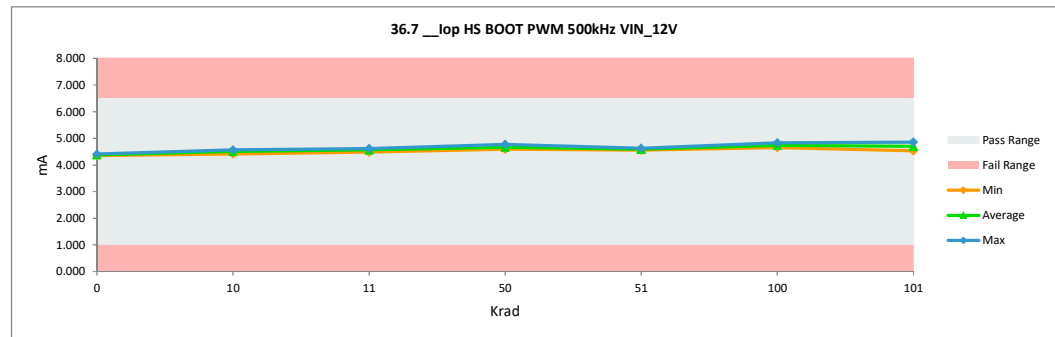

TID "HDR" Report
5962R2220102VXC

36.8 Iop LS VIN PWM 1MHz VIN_12V		
Test Site	DAL	DAL
Tester	ETS364	ETS364
Test Number	EB672303	EB672303
Unit	mA	mA
Max Limit	11	11
Min Limit	1	1

Krad	Serial #	Pre_HDR_6013	Post_HDR_6013	Delta
0	1	8.265	8.219	-0.046
0	2	7.970	7.935	-0.036
10	182	7.886	7.879	-0.007
10	202	7.984	8.013	0.029
10	204	8.174	7.999	-0.174
11	418	8.163	8.161	-0.002
11	419	8.072	8.102	0.030
11	443	7.991	8.073	0.081
50	259	8.061	8.170	0.110
50	346	8.141	8.210	0.068
50	347	7.987	8.052	0.065
51	462	7.968	8.075	0.106
51	478	8.182	7.949	-0.233
51	503	8.054	8.201	0.148
100	354	8.186	8.396	0.210
100	363	8.110	8.361	0.251
100	366	8.227	8.405	0.178
100	383	7.972	8.500	0.529
100	417	8.025	8.318	0.292
101	513	8.054	8.194	0.140
101	526	8.058	8.232	0.174
101	532	8.056	8.225	0.169
101	533	7.946	8.176	0.229
101	534	8.077	8.283	0.206
Max		8.265	8.500	0.529
Average		8.067	8.172	0.105
Min		7.886	7.879	-0.233
Std Dev		0.097	0.159	0.157

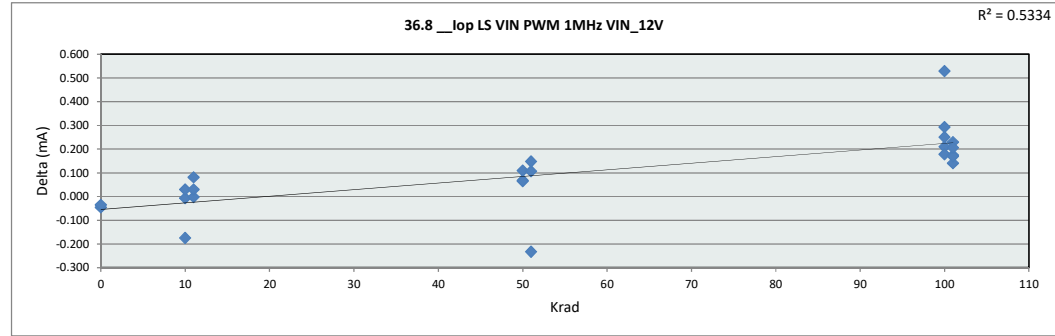

36.8 Iop LS VIN PWM 1MHz		
Test Site	DAL	
Tester	ETS364	
Test Number	EB672303	
Max Limit	11	mA
Min Limit	1	mA

Krad	0	10	11	50	51	100	101
LL	1.000	1.000	1.000	1.000	1.000	1.000	1.000
Min	7.935	7.879	8.073	8.052	7.949	8.318	8.176
Average	8.077	7.964	8.112	8.144	8.075	8.396	8.222
Max	8.219	8.013	8.161	8.210	8.202	8.501	8.283
UL	11.000	11.000	11.000	11.000	11.000	11.000	11.000

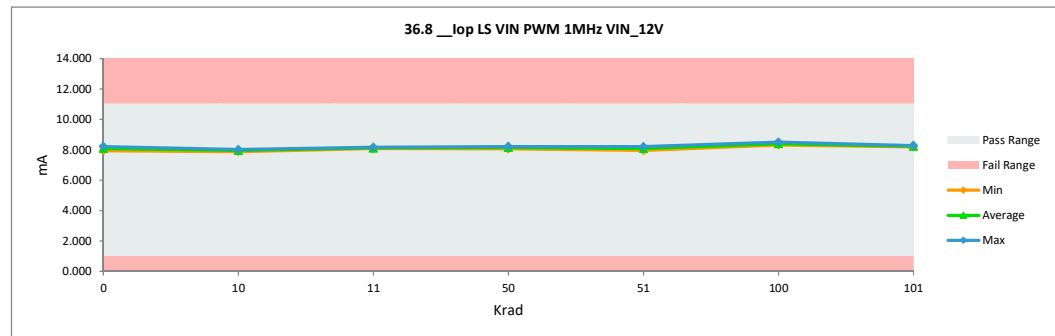

TID "HDR" Report
5962R2220102VXC

36.9 Iop HS BOOT PWM 1MHz		
Test Site	DAL	DAL
Tester	ETS364	ETS364
Test Number	EB672303	EB672303
Unit	mA	mA
Max Limit	8	8
Min Limit	1	1

Krad	Serial #	Pre_HDR_6013	Post_HDR_6013	Delta
0	1	5.289	5.232	-0.057
0	2	5.232	5.189	-0.043
10	182	5.253	5.241	-0.012
10	202	5.340	5.365	0.024
10	204	5.396	5.396	0.000
11	418	5.169	5.449	0.280
11	419	5.433	5.422	-0.011
11	443	5.226	5.306	0.080
50	259	5.288	5.410	0.123
50	346	5.443	5.596	0.153
50	347	5.297	5.464	0.167
51	462	5.457	5.456	-0.001
51	478	5.271	5.415	0.145
51	503	5.212	5.378	0.167
100	354	5.323	5.641	0.318
100	363	5.349	5.664	0.315
100	366	5.243	5.478	0.235
100	383	5.205	5.559	0.354
100	417	5.291	5.485	0.194
101	513	5.417	5.681	0.264
101	526	5.133	5.369	0.236
101	532	5.384	5.574	0.190
101	533	5.260	5.504	0.244
101	534	5.285	5.468	0.184
Max		5.457	5.681	0.354
Average		5.300	5.448	0.148
Min		5.133	5.189	-0.057
Std Dev		0.088	0.131	0.124

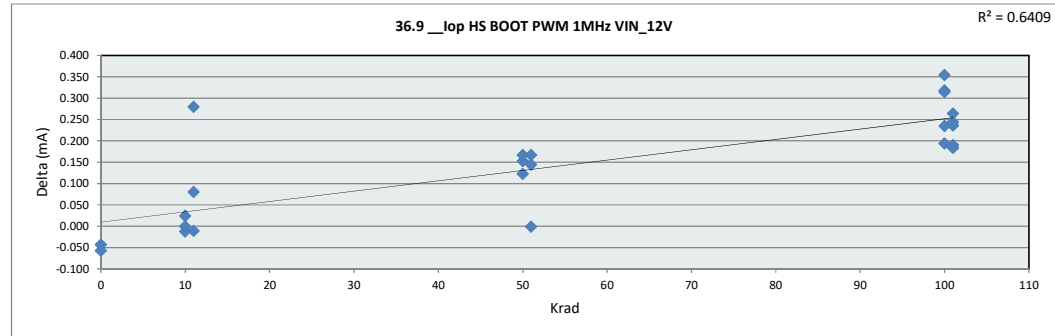

36.9 Iop HS BOOT PWM 1MHz		
Test Site	DAL	
Tester	ETS364	
Test Number	EB672303	
Max Limit	8	mA
Min Limit	1	mA

Krad	0	10	11	50	51	100	101
LL	1.000	1.000	1.000	1.000	1.000	1.000	1.000
Min	5.189	5.241	5.306	5.410	5.378	5.478	5.369
Average	5.210	5.334	5.392	5.490	5.417	5.565	5.519
Max	5.232	5.396	5.449	5.596	5.456	5.664	5.681
UL	8.000	8.000	8.000	8.000	8.000	8.000	8.000

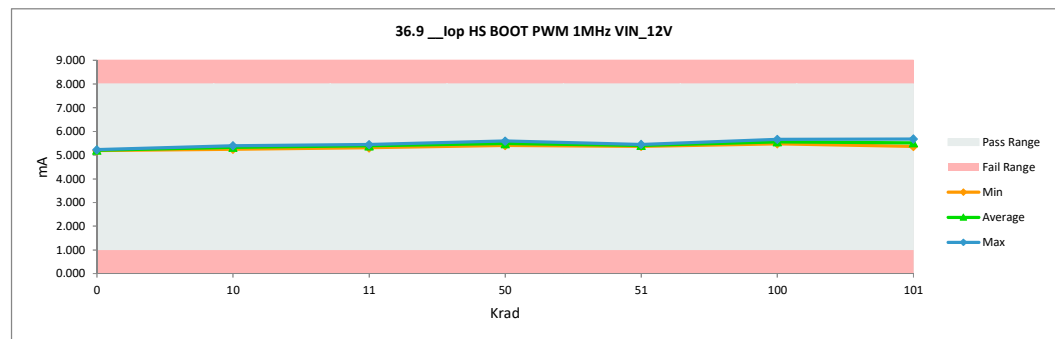

TID "HDR" Report
5962R2220102VXC

36.10_Iop LS VIN PWM 2MHz V		
Test Site	DAL	DAL
Tester	ETS364	ETS364
Test Number	EB672303	EB672303
Unit	mA	mA
Max Limit	16	16
Min Limit	1	1

Krad	Serial #	Pre_HDR_6013	Post_HDR_6013	Delta
0	1	11.645	11.594	-0.051
0	2	11.344	11.304	-0.041
10	182	11.232	11.236	0.004
10	202	11.342	11.384	0.041
10	204	11.579	11.391	-0.188
11	418	11.552	11.550	-0.003
11	419	11.459	11.488	0.029
11	443	11.371	11.432	0.061
50	259	11.419	11.583	0.164
50	346	11.513	11.634	0.122
50	347	11.355	11.483	0.127
51	462	11.358	11.509	0.152
51	478	11.562	11.379	-0.183
51	503	11.427	11.618	0.190
100	354	11.574	11.883	0.309
100	363	11.490	11.811	0.320
100	366	11.586	11.844	0.259
100	383	11.340	11.960	0.620
100	417	11.403	11.800	0.397
101	513	11.424	11.646	0.222
101	526	11.422	11.675	0.253
101	532	11.440	11.693	0.253
101	533	11.311	11.644	0.332
101	534	11.442	11.726	0.284
Max		11.645	11.960	0.620
Average		11.441	11.594	0.153
Min		11.232	11.236	-0.188
Std Dev		0.103	0.188	0.188

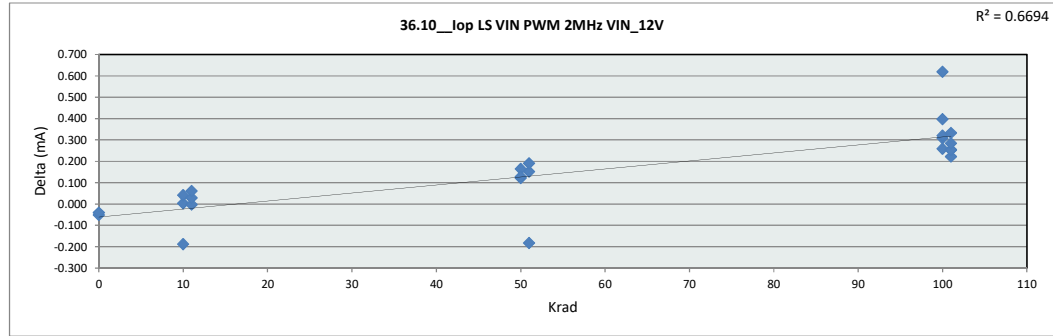

36.10_Iop LS VIN PWM 2MHz		
Test Site	DAL	
Tester	ETS364	
Test Number	EB672303	
Max Limit	16	mA
Min Limit	1	mA

Krad	0	10	11	50	51	100	101
LL	1.000	1.000	1.000	1.000	1.000	1.000	1.000
Min	11.304	11.236	11.432	11.483	11.379	11.800	11.644
Average	11.449	11.337	11.490	11.567	11.502	11.860	11.677
Max	11.594	11.391	11.550	11.635	11.618	11.960	11.726
UL	16.000	16.000	16.000	16.000	16.000	16.000	16.000

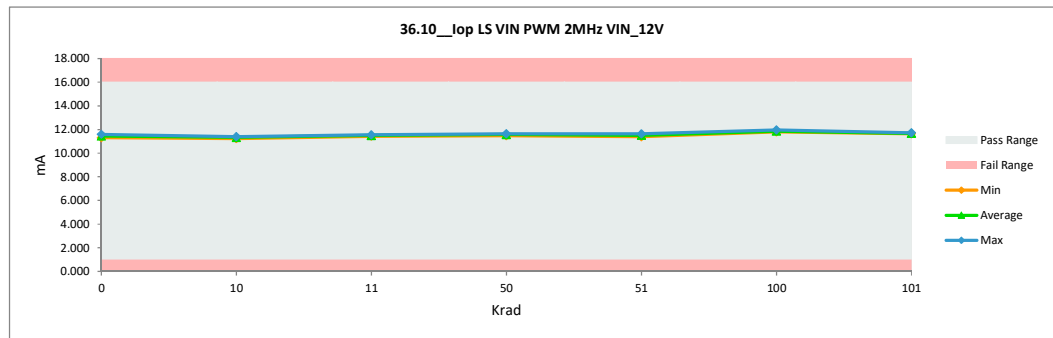

TID "HDR" Report
5962R2220102VXC

36.11_Iop HS BOOT PWM 2MHz

Test Site	DAL	DAL
Tester	ETS364	ETS364
Test Number	EB672303	EB672303
Unit	mA	mA
Max Limit	10.5	10.5
Min Limit	1	1

Krad	Serial #	Pre_HDR_6013	Post_HDR_6013	Delta
0	1	6.955	6.899	-0.056
0	2	6.896	6.856	-0.040
10	182	6.919	6.908	-0.011
10	202	7.010	7.040	0.029
10	204	7.072	7.063	-0.009
11	418	6.837	7.133	0.296
11	419	7.106	7.094	-0.011
11	443	6.902	6.966	0.064
50	259	6.937	7.043	0.106
50	346	7.108	7.260	0.152
50	347	6.953	7.146	0.192
51	462	7.117	7.122	0.006
51	478	6.922	7.094	0.173
51	503	6.890	7.047	0.158
100	354	6.995	7.303	0.308
100	363	7.012	7.330	0.318
100	366	6.899	7.105	0.206
100	383	6.877	7.200	0.324
100	417	6.957	7.153	0.196
101	513	7.082	7.319	0.238
101	526	6.804	7.025	0.222
101	532	7.060	7.215	0.155
101	533	6.924	7.153	0.229
101	534	6.932	7.082	0.151
Max		7.117	7.330	0.324
Average		6.965	7.107	0.141
Min		6.804	6.856	-0.056
Std Dev		0.088	0.127	0.120

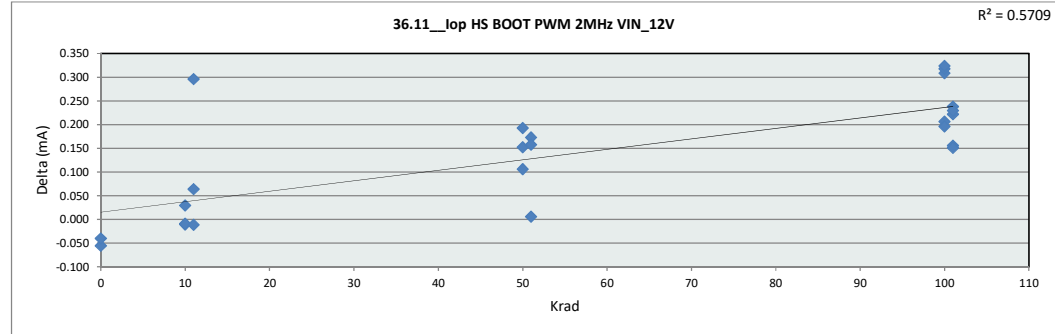

36.11_Iop HS BOOT PWM 2M

Test Site	DAL
Tester	ETS364
Test Number	EB672303
Max Limit	10.5 mA
Min Limit	1 mA

Krad	0	10	11	50	51	100	101
LL	1.000	1.000	1.000	1.000	1.000	1.000	1.000
Min	6.856	6.908	6.966	7.043	7.047	7.105	7.025
Average	6.877	7.004	7.064	7.150	7.088	7.218	7.159
Max	6.899	7.063	7.133	7.260	7.122	7.330	7.319
UL	10.500	10.500	10.500	10.500	10.500	10.500	10.500

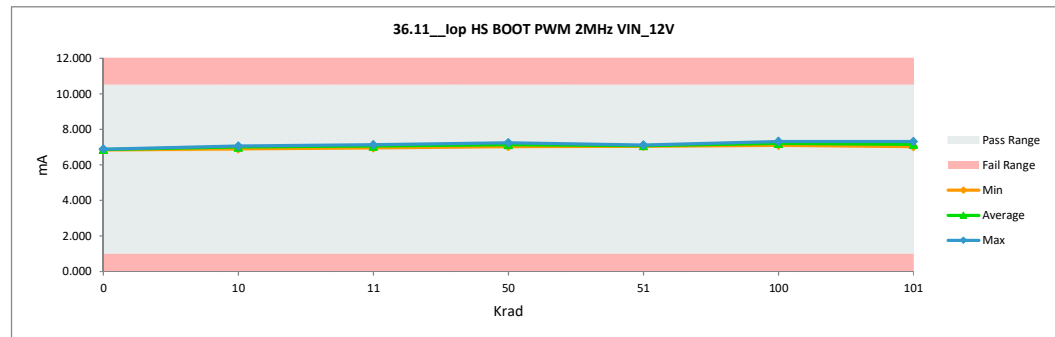

TID "HDR" Report
5962R2220102VXC

36.12_Iop LS VIN PWM 5MHz V		
Test Site	DAL	DAL
Tester	ETS364	ETS364
Test Number	EB672303	EB672303
Unit	mA	mA
Max Limit	30	30
Min Limit	1	1

Krad	Serial #	Pre_HDR_6013	Post_HDR_6013	Delta
0	1	18.223	18.119	-0.104
0	2	17.823	20.089	2.266
10	182	17.762	17.847	0.086
10	202	17.971	18.138	0.167
10	204	18.315	17.944	-0.371
11	418	18.000	18.462	0.462
11	419	18.287	18.329	0.042
11	443	17.791	18.250	0.459
50	259	18.643	18.890	0.246
50	346	18.399	18.791	0.392
50	347	19.186	17.897	-1.289
51	462	18.434	18.422	-0.012
51	478	18.018	18.117	0.099
51	503	18.181	18.732	0.551
100	354	18.484	19.166	0.682
100	363	18.328	20.929	2.601
100	366	18.639	19.106	0.467
100	383	18.104	19.144	1.040
100	417	17.727	18.905	1.178
101	513	18.096	18.766	0.670
101	526	17.825	18.836	1.011
101	532	18.180	18.950	0.769
101	533	17.742	18.867	1.125
101	534	18.546	18.966	0.420
	Max	19.186	20.929	2.601
	Average	18.196	18.736	0.540
	Min	17.727	17.847	-1.289
	Std Dev	0.356	0.696	0.790

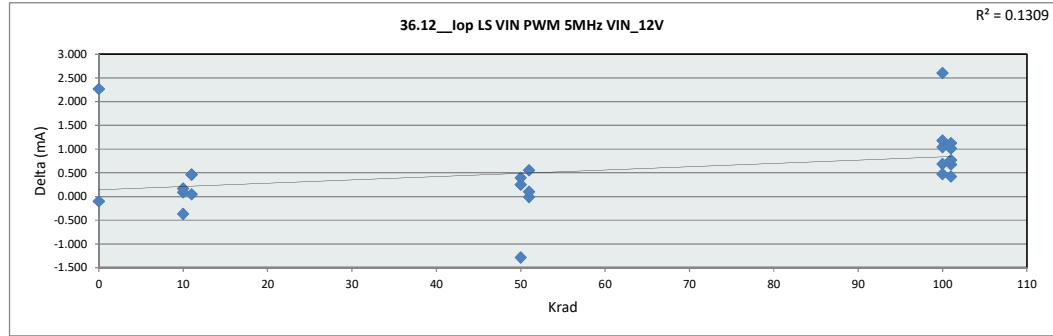

36.12_Iop LS VIN PWM 5MHz		
Test Site	DAL	
Tester	ETS364	
Test Number	EB672303	
Max Limit	30	mA
Min Limit	1	mA

	0	10	11	50	51	100	101
LL	1.000	1.000	1.000	1.000	1.000	1.000	1.000
Min	18.119	17.848	18.250	17.897	18.117	18.905	18.766
Average	19.104	17.976	18.347	18.526	18.423	19.450	18.877
Max	20.089	18.138	18.462	18.890	18.732	20.929	18.966
UL	30.000	30.000	30.000	30.000	30.000	30.000	30.000

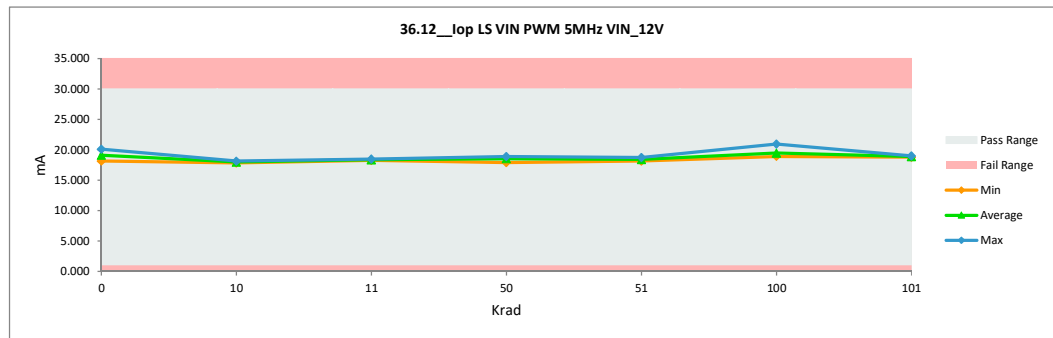

TID "HDR" Report
5962R2220102VXC

36.13_Iop HS BOOT PWM 5MHz

Test Site	DAL	DAL
Tester	ETS364	ETS364
Test Number	EB672303	EB672303
Unit	mA	mA
Max Limit	17.5	17.5
Min Limit	1	1

Krad	Serial #	Pre_HDR_6013	Post_HDR_6013	Delta
0	1	13.045	13.076	0.031
0	2	10.865	10.833	-0.031
10	182	12.222	12.038	-0.183
10	202	13.253	12.793	-0.460
10	204	13.798	13.818	0.020
11	418	12.866	12.664	-0.203
11	419	13.330	13.175	-0.154
11	443	12.858	11.764	-1.095
50	259	11.044	10.759	-0.285
50	346	13.066	12.103	-0.963
50	347	13.266	13.637	0.372
51	462	13.305	11.366	-1.939
51	478	13.242	12.398	-0.844
51	503	12.863	11.571	-1.292
100	354	13.585	11.523	-2.062
100	363	13.438	12.086	-1.352
100	366	10.944	10.654	-0.290
100	383	12.458	10.854	-1.604
100	417	12.816	11.912	-0.903
101	513	12.927	11.375	-1.553
101	526	12.379	10.643	-1.736
101	532	12.661	11.038	-1.624
101	533	13.555	11.199	-2.355
101	534	10.927	10.517	-0.410
Max		13.798	13.818	0.372
Average		12.696	11.825	-0.871
Min		10.865	10.517	-2.355
Std Dev		0.886	0.977	0.777

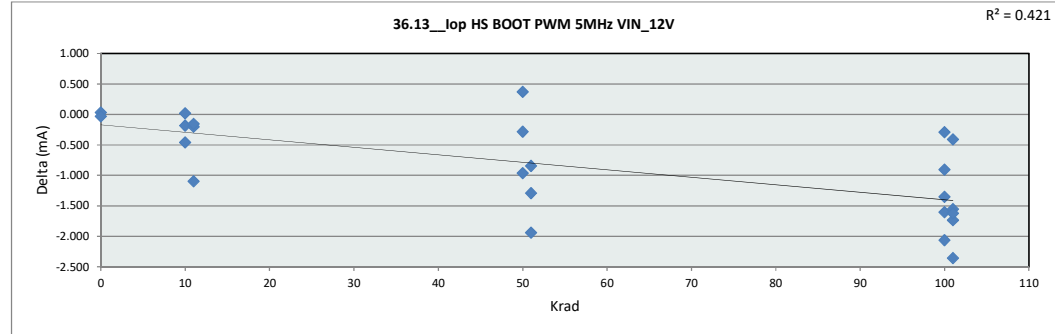

36.13_Iop HS BOOT PWM 5M

Test Site	DAL
Tester	ETS364
Test Number	EB672303
Max Limit	17.5 mA
Min Limit	1 mA

Krad	0	10	11	50	51	100	101
LL	1.000	1.000	1.000	1.000	1.000	1.000	1.000
Min	10.833	12.038	11.764	10.759	11.366	10.654	10.517
Average	11.955	12.883	12.534	12.167	11.778	11.406	10.954
Max	13.076	13.818	13.176	13.638	12.398	12.086	11.375
UL	17.500	17.500	17.500	17.500	17.500	17.500	17.500

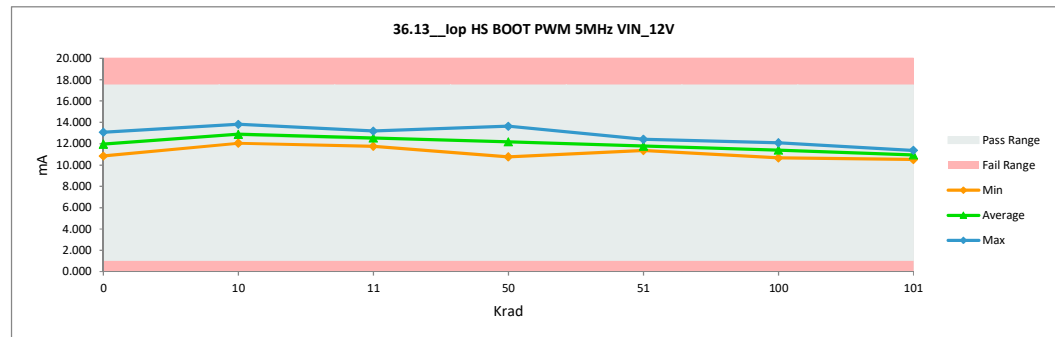

TID "HDR" Report
5962R2220102VXC

36.14_Top LS VIN IIM Interlock

Test Site	DAL	DAL
Tester	ETS364	ETS364
Test Number	EB672303	EB672303
Unit	mA	mA
Max Limit	9	9
Min Limit	1	1

Krad	Serial #	Pre_HDR_6013	Post_HDR_6013	Delta
0	1	5.993	5.938	-0.054
0	2	5.729	5.687	-0.042
10	182	5.654	5.651	-0.003
10	202	5.746	5.784	0.039
10	204	5.951	5.734	-0.217
11	418	5.966	5.882	-0.084
11	419	5.881	5.828	-0.054
11	443	5.786	5.832	0.047
50	259	5.836	5.981	0.145
50	346	5.891	6.001	0.109
50	347	5.702	5.805	0.103
51	462	5.798	5.844	0.045
51	478	5.942	5.769	-0.173
51	503	5.805	5.996	0.191
100	354	5.911	6.196	0.285
100	363	5.849	6.190	0.341
100	366	5.982	6.221	0.239
100	383	5.790	6.304	0.514
100	417	5.824	6.102	0.278
101	513	5.816	6.047	0.230
101	526	5.754	6.028	0.274
101	532	5.806	6.058	0.252
101	533	5.724	6.019	0.295
101	534	5.856	6.142	0.286
Max		5.993	6.304	0.514
Average		5.833	5.960	0.127
Min		5.654	5.651	-0.217
Std Dev		0.092	0.180	0.180

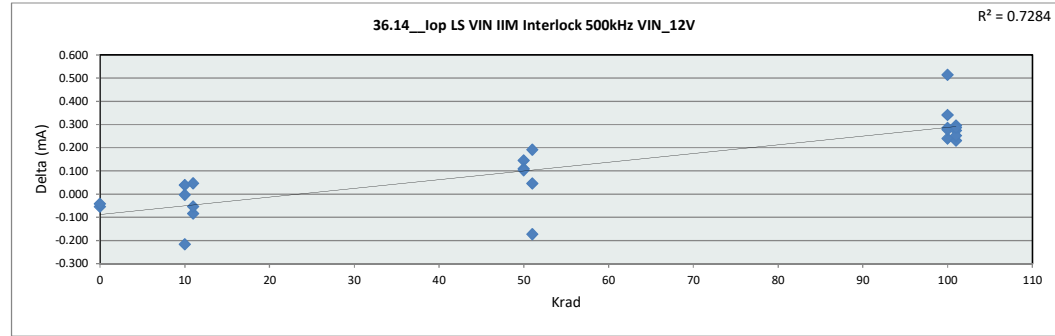

36.14_Top LS VIN IIM Interlo

Test Site	DAL
Tester	ETS364
Test Number	EB672303
Max Limit	9 mA
Min Limit	1 mA

	0	10	11	50	51	100	101
LL	1.000	1.000	1.000	1.000	1.000	1.000	1.000
Min	5.687	5.651	5.828	5.805	5.769	6.102	6.019
Average	5.813	5.723	5.847	5.929	5.870	6.203	6.059
Max	5.938	5.784	5.882	6.001	5.996	6.304	6.142
UL	9.000	9.000	9.000	9.000	9.000	9.000	9.000

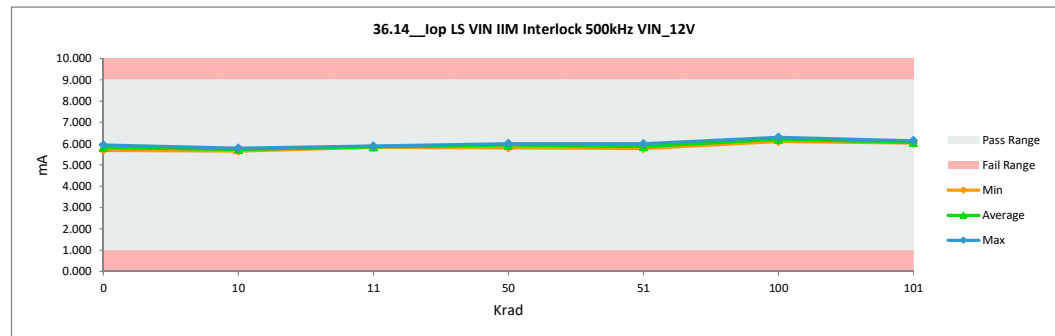

TID "HDR" Report
5962R2220102VXC

36.15 Iop HS BOOT IIM Interlock

Test Site	DAL	DAL
Tester	ETS364	ETS364
Test Number	EB672303	EB672303
Unit	mA	mA
Max Limit	6.5	6.5
Min Limit	1	1

Krad	Serial #	Pre_HDR_6013	Post_HDR_6013	Delta
0	1	4.467	4.409	-0.058
0	2	4.403	4.358	-0.045
10	182	4.431	4.420	-0.010
10	202	4.513	4.536	0.023
10	204	4.565	4.568	0.004
11	418	4.345	4.617	0.272
11	419	4.609	4.596	-0.013
11	443	4.396	4.484	0.089
50	259	4.463	4.583	0.121
50	346	4.620	4.768	0.148
50	347	4.469	4.634	0.165
51	462	4.631	4.630	-0.001
51	478	4.450	4.583	0.133
51	503	4.382	4.549	0.168
100	354	4.499	4.812	0.313
100	363	4.529	4.832	0.303
100	366	4.422	4.655	0.233
100	383	4.376	4.733	0.357
100	417	4.469	4.653	0.184
101	513	4.593	4.857	0.264
101	526	4.305	4.539	0.234
101	532	4.556	4.751	0.196
101	533	4.438	4.680	0.242
101	534	4.461	4.649	0.188
	Max	4.631	4.857	0.357
	Average	4.475	4.621	0.146
	Min	4.305	4.358	-0.058
	Std Dev	0.088	0.131	0.123

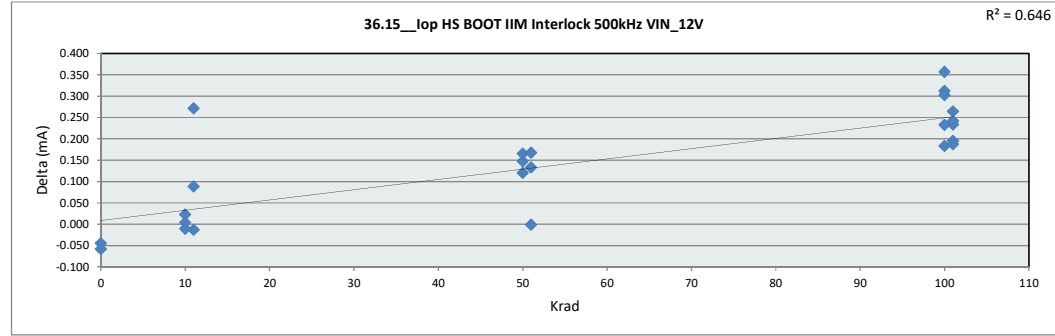

36.15 Iop HS BOOT IIM Interlock

Test Site	DAL
Tester	ETS364
Test Number	EB672303
Max Limit	6.5 mA
Min Limit	1 mA

Krad	0	10	11	50	51	100	101
LL	1.000	1.000	1.000	1.000	1.000	1.000	1.000
Min	4.358	4.420	4.485	4.583	4.550	4.653	4.539
Average	4.384	4.508	4.566	4.662	4.587	4.737	4.695
Max	4.409	4.568	4.617	4.768	4.630	4.832	4.857
UL	6.500	6.500	6.500	6.500	6.500	6.500	6.500

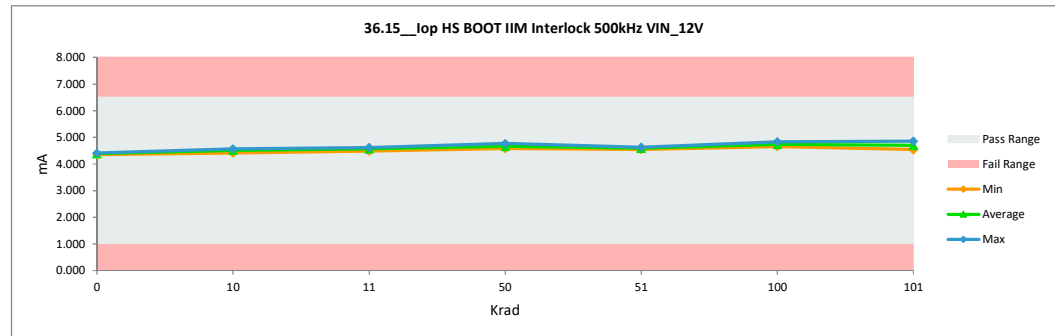

TID "HDR" Report
5962R2220102VXC

36.16_Iop LS VIN IIM Interlock

Test Site	DAL	DAL
Tester	ETS364	ETS364
Test Number	EB672303	EB672303
Unit	mA	mA
Max Limit	12	12
Min Limit	1	1

Krad	Serial #	Pre_HDR_6013	Post_HDR_6013	Delta
0	1	7.464	7.405	-0.058
0	2	7.192	7.150	-0.043
10	182	7.108	7.111	0.002
10	202	7.203	7.247	0.044
10	204	7.420	7.206	-0.214
11	418	7.432	7.358	-0.074
11	419	7.347	7.299	-0.048
11	443	7.243	7.292	0.049
50	259	7.297	7.464	0.168
50	346	7.353	7.483	0.130
50	347	7.164	7.291	0.127
51	462	7.260	7.339	0.080
51	478	7.399	7.251	-0.148
51	503	7.273	7.483	0.210
100	354	7.384	7.703	0.319
100	363	7.309	7.689	0.379
100	366	7.443	7.719	0.277
100	383	7.247	7.805	0.558
100	417	7.280	7.611	0.331
101	513	7.285	7.547	0.262
101	526	7.222	7.529	0.306
101	532	7.279	7.562	0.283
101	533	7.186	7.522	0.335
101	534	7.322	7.638	0.316
	Max	7.464	7.805	0.558
	Average	7.296	7.446	0.150
	Min	7.108	7.111	-0.214
	Std Dev	0.095	0.193	0.193

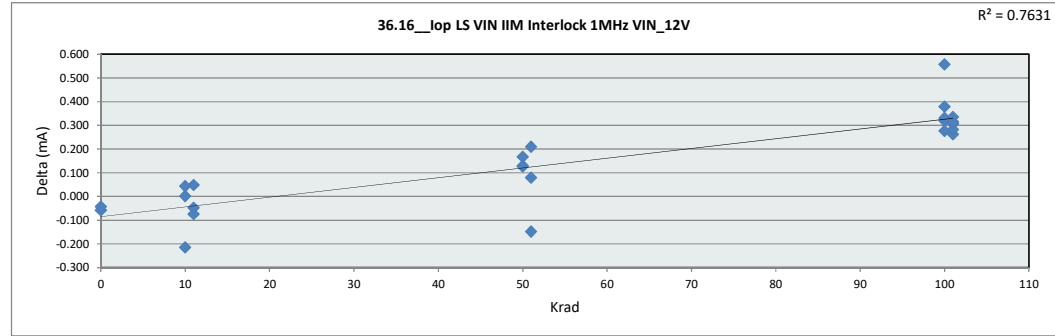

36.16_Iop LS VIN IIM Interlo

Test Site	DAL
Tester	ETS364
Test Number	EB672303
Max Limit	12 mA
Min Limit	1 mA

Krad	0	10	11	50	51	100	101
LL	1.000	1.000	1.000	1.000	1.000	1.000	1.000
Min	7.150	7.111	7.292	7.291	7.251	7.612	7.522
Average	7.278	7.188	7.316	7.413	7.358	7.706	7.559
Max	7.405	7.247	7.358	7.483	7.483	7.805	7.638
UL	12.000	12.000	12.000	12.000	12.000	12.000	12.000

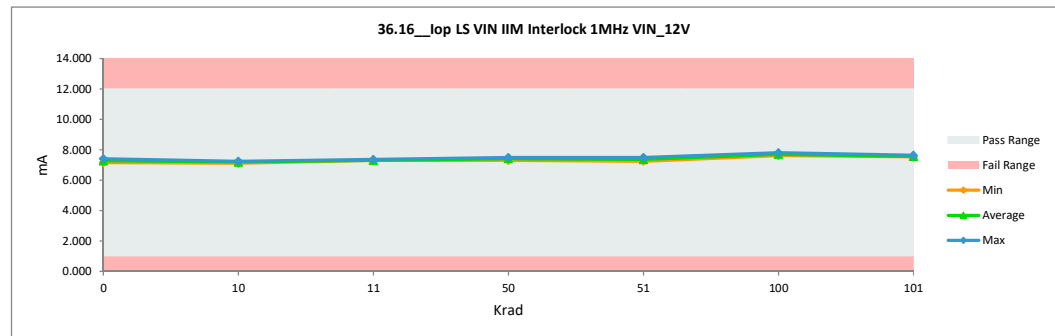

TID "HDR" Report
5962R2220102VXC

36.17__Iop HS BOOT IIM Interlock		
Test Site	DAL	DAL
Tester	ETS364	ETS364
Test Number	EB672303	EB672303
Unit	mA	mA
Max Limit	8	8
Min Limit	1	1

Krad	Serial #	Pre_HDR_6013	Post_HDR_6013	Delta
0	1	5.290	5.231	-0.059
0	2	5.230	5.188	-0.042
10	182	5.254	5.244	-0.011
10	202	5.338	5.361	0.023
10	204	5.394	5.397	0.003
11	418	5.171	5.451	0.280
11	419	5.437	5.422	-0.014
11	443	5.223	5.308	0.085
50	259	5.284	5.407	0.123
50	346	5.440	5.591	0.151
50	347	5.295	5.462	0.167
51	462	5.454	5.458	0.003
51	478	5.269	5.412	0.142
51	503	5.213	5.378	0.165
100	354	5.326	5.638	0.311
100	363	5.353	5.657	0.304
100	366	5.246	5.476	0.230
100	383	5.203	5.558	0.355
100	417	5.294	5.479	0.185
101	513	5.414	5.679	0.265
101	526	5.131	5.366	0.235
101	532	5.385	5.577	0.192
101	533	5.260	5.500	0.240
101	534	5.281	5.469	0.188
	Max	5.454	5.679	0.355
	Average	5.299	5.446	0.147
	Min	5.131	5.188	-0.059
	Std Dev	0.088	0.130	0.123

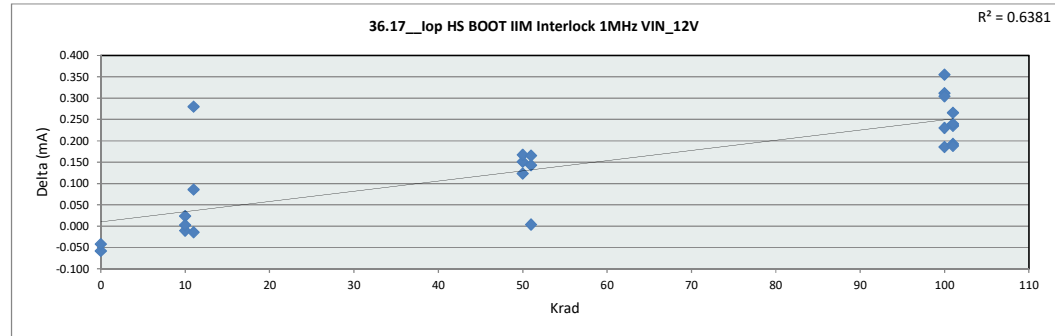

36.17__Iop HS BOOT IIM Interlock		
Test Site	DAL	
Tester	ETS364	
Test Number	EB672303	
Max Limit	8	mA
Min Limit	1	mA

Krad	0	10	11	50	51	100	101
LL	1.000	1.000	1.000	1.000	1.000	1.000	1.000
Min	5.188	5.244	5.308	5.407	5.378	5.476	5.366
Average	5.209	5.334	5.394	5.487	5.416	5.562	5.518
Max	5.231	5.397	5.451	5.591	5.458	5.657	5.679
UL	8.000	8.000	8.000	8.000	8.000	8.000	8.000

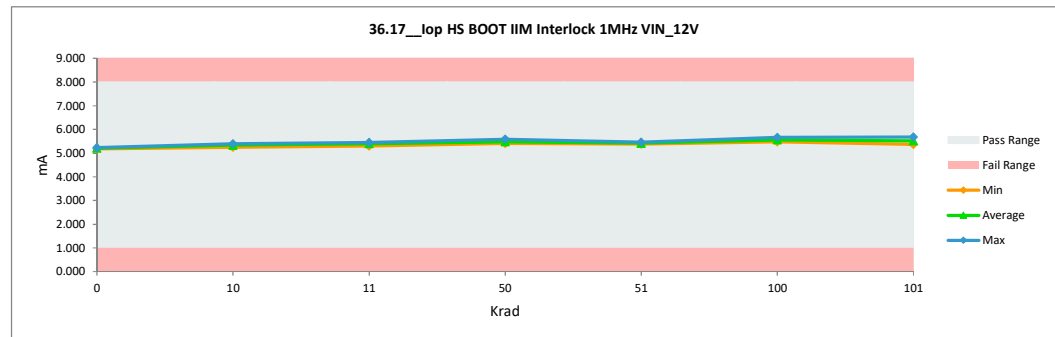

TID "HDR" Report
5962R2220102VXC

36.18_Iop LS VIN IIM Interlock

Test Site	DAL	DAL
Tester	ETS364	ETS364
Test Number	EB672303	EB672303
Unit	mA	mA
Max Limit	17	17
Min Limit	1	1

Krad	Serial #	Pre_HDR_6013	Post_HDR_6013	Delta
0	1	10.398	10.335	-0.063
0	2	10.114	10.069	-0.045
10	182	10.013	10.023	0.010
10	202	10.112	10.168	0.056
10	204	10.351	10.144	-0.206
11	418	10.357	10.304	-0.053
11	419	10.267	10.233	-0.034
11	443	10.153	10.200	0.047
50	259	10.208	10.421	0.212
50	346	10.269	10.439	0.170
50	347	10.086	10.257	0.170
51	462	10.180	10.324	0.144
51	478	10.310	10.211	-0.098
51	503	10.198	10.452	0.254
100	354	10.322	10.716	0.393
100	363	10.224	10.683	0.459
100	366	10.359	10.709	0.350
100	383	10.155	10.800	0.645
100	417	10.189	10.623	0.434
101	513	10.215	10.540	0.325
101	526	10.148	10.520	0.373
101	532	10.217	10.566	0.349
101	533	10.103	10.517	0.414
101	534	10.248	10.621	0.373
Max		10.398	10.800	0.645
Average		10.216	10.411	0.195
Min		10.013	10.023	-0.206
Std Dev		0.099	0.221	0.220

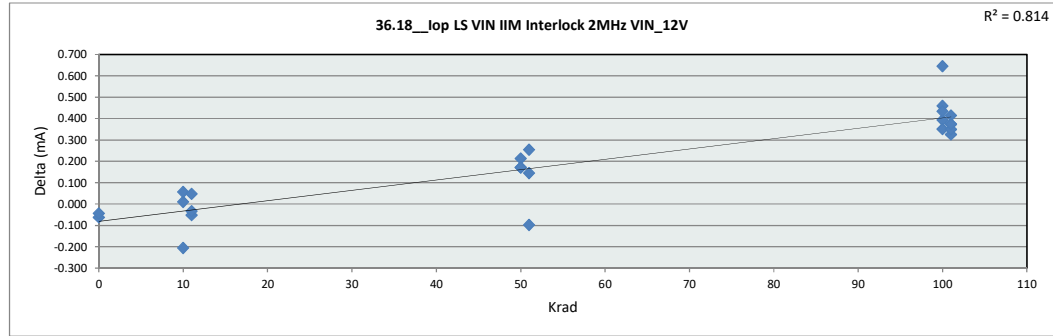

36.18_Iop LS VIN IIM Interlo

Test Site	DAL
Tester	ETS364
Test Number	EB672303
Max Limit	17 mA
Min Limit	1 mA

Krad	0	10	11	50	51	100	101
LL	1.000	1.000	1.000	1.000	1.000	1.000	1.000
Min	10.069	10.023	10.200	10.257	10.211	10.623	10.518
Average	10.202	10.112	10.245	10.372	10.329	10.706	10.553
Max	10.335	10.168	10.304	10.439	10.452	10.800	10.621
UL	17.000	17.000	17.000	17.000	17.000	17.000	17.000

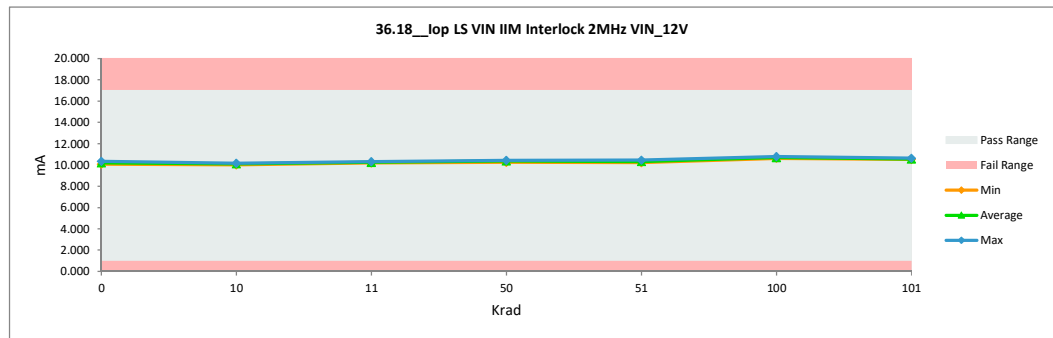

TID "HDR" Report
5962R2220102VXC

36.19_Iop HS BOOT IIM Interlock		
Test Site	DAL	
Tester	ETS364	
Test Number	EB672303	
Unit	mA	
Max Limit	10.5	
Min Limit	1	

Krad	Serial #	Pre_HDR_6013	Post_HDR_6013	Delta
0	1	6.931	6.872	-0.059
0	2	6.881	6.841	-0.041
10	182	6.903	6.891	-0.011
10	202	6.986	7.010	0.024
10	204	7.048	7.053	0.005
11	418	6.815	7.112	0.296
11	419	7.087	7.072	-0.015
11	443	6.868	6.954	0.086
50	259	6.920	7.045	0.125
50	346	7.076	7.227	0.151
50	347	6.942	7.118	0.175
51	462	7.107	7.110	0.002
51	478	6.909	7.064	0.156
51	503	6.869	7.032	0.163
100	354	6.975	7.293	0.318
100	363	6.996	7.306	0.310
100	366	6.883	7.115	0.232
100	383	6.850	7.201	0.352
100	417	6.939	7.127	0.188
101	513	7.055	7.318	0.263
101	526	6.780	7.014	0.234
101	532	7.040	7.225	0.185
101	533	6.899	7.135	0.236
101	534	6.916	7.101	0.185
	Max	7.107	7.318	0.352
	Average	6.945	7.093	0.148
	Min	6.780	6.841	-0.059
	Std Dev	0.088	0.129	0.124

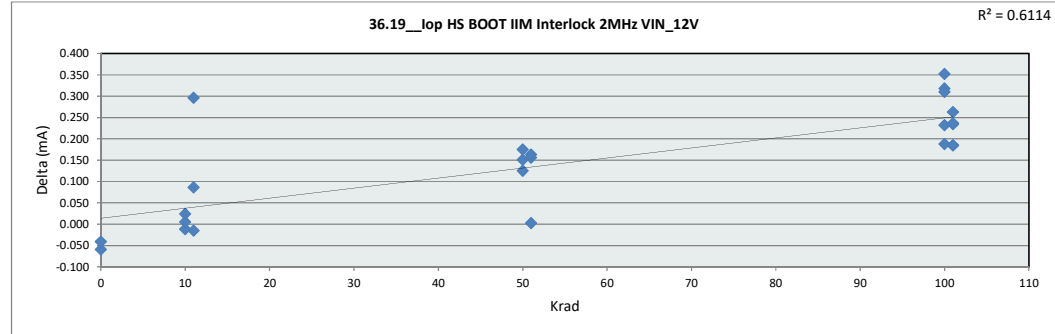

36.19_Iop HS BOOT IIM Interlock		
Test Site	DAL	
Tester	ETS364	
Test Number	EB672303	
Max Limit	10.5 mA	
Min Limit	1 mA	

	0	10	11	50	51	100	101
LL	1.000	1.000	1.000	1.000	1.000	1.000	1.000
Min	6.841	6.891	6.954	7.045	7.032	7.115	7.014
Average	6.856	6.985	7.046	7.130	7.069	7.208	7.159
Max	6.872	7.053	7.112	7.227	7.110	7.306	7.318
UL	10.500	10.500	10.500	10.500	10.500	10.500	10.500

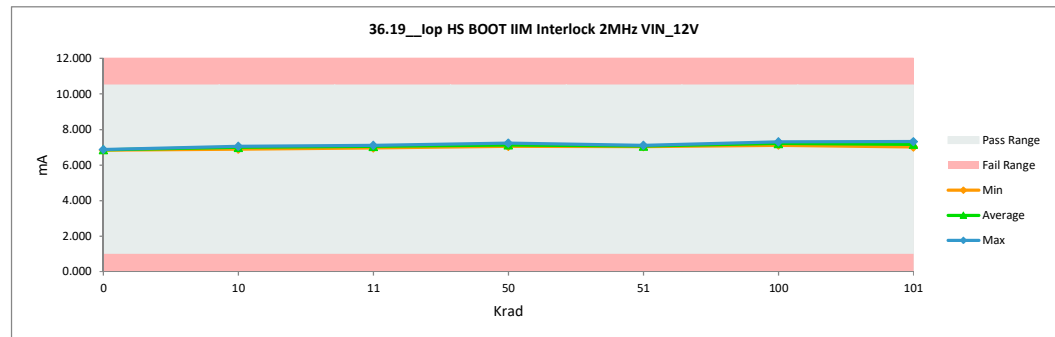

TID "HDR" Report
5962R2220102VXC

36.20_Iop LS VIN IIM Interlock		
Test Site	DAL	DAL
Tester	ETS364	ETS364
Test Number	EB672303	EB672303
Unit	mA	mA
Max Limit	30	30
Min Limit	1	1

Krad	Serial #	Pre_HDR_6013	Post_HDR_6013	Delta
0	1	19.491	19.448	-0.042
0	2	19.155	19.145	-0.010
10	182	19.014	19.065	0.052
10	202	19.120	19.243	0.123
10	204	19.441	19.269	-0.172
11	418	19.438	19.429	-0.008
11	419	19.302	19.343	0.041
11	443	19.169	19.217	0.048
50	259	19.215	19.584	0.369
50	346	19.305	19.613	0.308
50	347	19.165	19.473	0.308
51	462	19.226	19.572	0.346
51	478	19.327	19.385	0.058
51	503	19.287	19.657	0.371
100	354	19.416	20.051	0.635
100	363	19.264	19.979	0.715
100	366	19.412	19.957	0.544
100	383	19.187	20.094	0.906
100	417	19.195	19.967	0.772
101	513	19.292	19.814	0.522
101	526	19.250	19.812	0.562
101	532	19.319	19.878	0.559
101	533	19.154	19.823	0.669
101	534	19.324	19.863	0.539
	Max	19.491	20.094	0.906
	Average	19.269	19.612	0.342
	Min	19.014	19.065	-0.172
	Std Dev	0.117	0.309	0.302

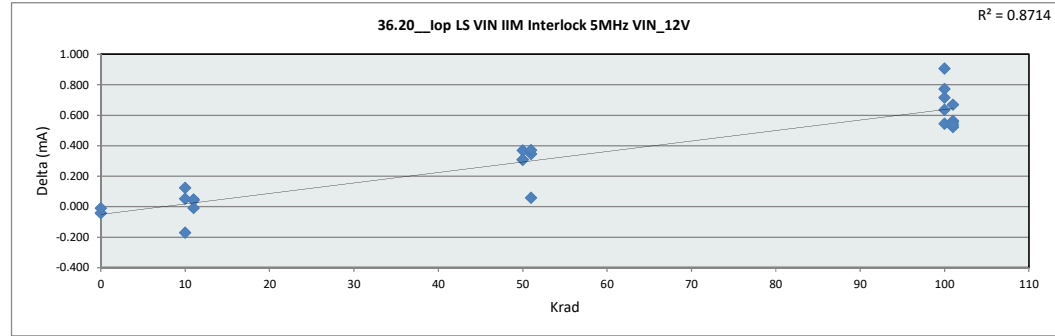

36.20_Iop LS VIN IIM Interlo		
Test Site	DAL	
Tester	ETS364	
Test Number	EB672303	
Max Limit	30	mA
Min Limit	1	mA

Krad	0	10	11	50	51	100	101
LL	1.000	1.000	1.000	1.000	1.000	1.000	1.000
Min	19.145	19.065	19.217	19.473	19.386	19.957	19.812
Average	19.297	19.192	19.330	19.557	19.538	20.010	19.838
Max	19.449	19.269	19.429	19.613	19.658	20.094	19.878
UL	30.000	30.000	30.000	30.000	30.000	30.000	30.000

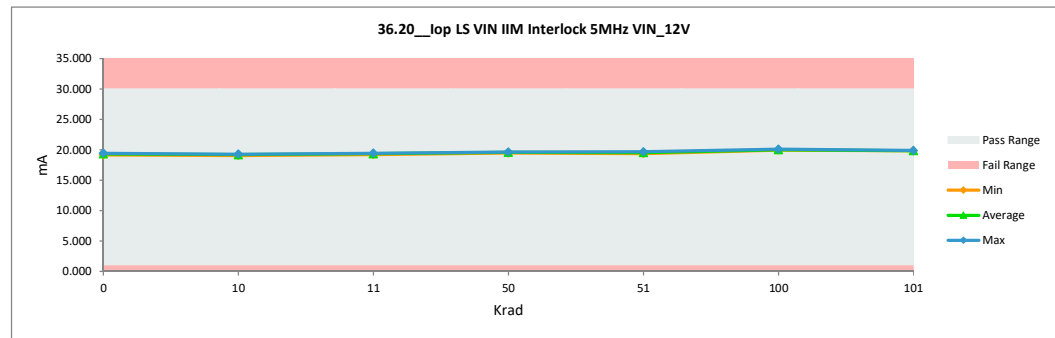

TID "HDR" Report
5962R2220102VXC

36.21 Iop HS BOOT IIM Interlock		
Test Site	DAL	DAL
Tester	ETS364	ETS364
Test Number	EB672303	EB672303
Unit	mA	mA
Max Limit	15	15
Min Limit	1	1

Krad	Serial #	Pre_HDR_6013	Post_HDR_6013	Delta
0	1	11.569	11.504	-0.064
0	2	11.586	11.543	-0.043
10	182	11.568	11.548	-0.020
10	202	11.677	11.710	0.032
10	204	11.730	11.722	-0.008
11	418	11.465	11.798	0.333
11	419	11.766	11.733	-0.033
11	443	11.511	11.643	0.133
50	259	11.533	11.651	0.117
50	346	11.683	11.841	0.157
50	347	11.612	11.780	0.168
51	462	11.790	11.808	0.018
51	478	11.561	11.742	0.181
51	503	11.556	11.728	0.172
100	354	11.643	11.970	0.327
100	363	11.638	11.972	0.335
100	366	11.510	11.743	0.233
100	383	11.565	11.883	0.318
100	417	11.604	11.782	0.178
101	513	11.681	11.975	0.294
101	526	11.446	11.706	0.260
101	532	11.730	11.922	0.192
101	533	11.541	11.795	0.254
101	534	11.564	11.759	0.194
Max		11.790	11.975	0.335
Average		11.605	11.761	0.155
Min		11.446	11.504	-0.064
Std Dev		0.092	0.129	0.130

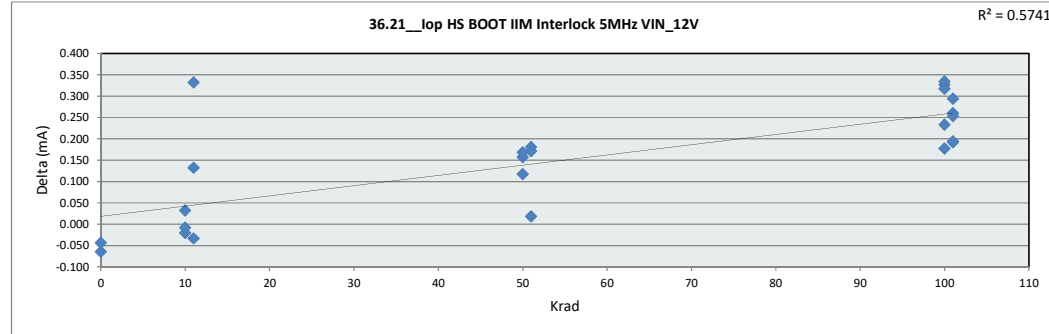

36.21 Iop HS BOOT IIM Interlock		
Test Site	DAL	
Tester	ETS364	
Test Number	EB672303	
Max Limit	15	mA
Min Limit	1	mA

Krad	0	10	11	50	51	100	101
LL	1.000	1.000	1.000	1.000	1.000	1.000	1.000
Min	11.504	11.548	11.643	11.651	11.728	11.743	11.706
Average	11.524	11.660	11.725	11.757	11.759	11.870	11.831
Max	11.543	11.722	11.798	11.841	11.808	11.972	11.975
UL	15.000	15.000	15.000	15.000	15.000	15.000	15.000

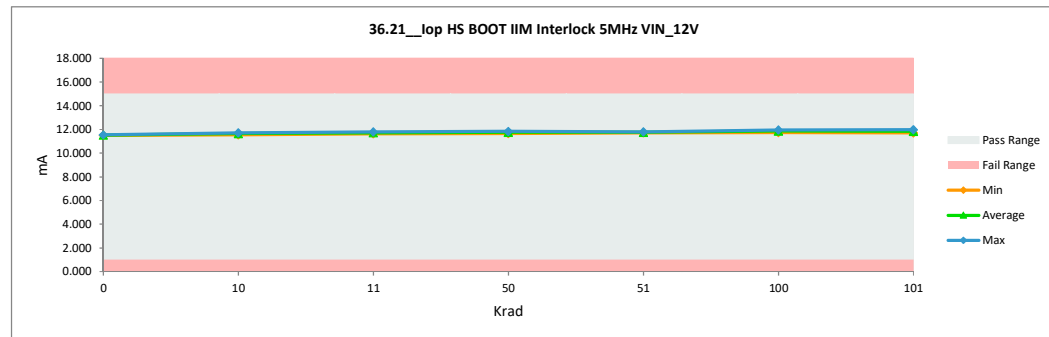

TID "HDR" Report
5962R2220102VXC

37.0 Iq LS VIN PWM VIN_14V		
Test Site	DAL	DAL
Tester	ETS364	ETS364
Test Number	EB672303	EB672303
Unit	mA	mA
Max Limit	6.8	6.8
Min Limit	1	1

Krad	Serial #	Pre_HDR_6013	Post_HDR_6013	Delta
0	1	4.480	4.424	-0.056
0	2	4.236	4.196	-0.040
10	182	4.169	4.168	-0.001
10	202	4.264	4.301	0.038
10	204	4.475	4.229	-0.246
11	418	4.497	4.379	-0.118
11	419	4.417	4.317	-0.100
11	443	4.310	4.351	0.041
50	259	4.361	4.506	0.145
50	346	4.408	4.519	0.111
50	347	4.203	4.306	0.104
51	462	4.342	4.351	0.009
51	478	4.455	4.292	-0.162
51	503	4.321	4.521	0.200
100	354	4.414	4.703	0.290
100	363	4.352	4.708	0.356
100	366	4.490	4.735	0.245
100	383	4.325	4.808	0.483
100	417	4.353	4.603	0.249
101	513	4.341	4.589	0.248
101	526	4.237	4.538	0.301
101	532	4.322	4.592	0.270
101	533	4.252	4.556	0.304
101	534	4.380	4.686	0.306
Max		4.497	4.808	0.483
Average		4.350	4.474	0.124
Min		4.169	4.168	-0.246
Std Dev		0.093	0.184	0.188

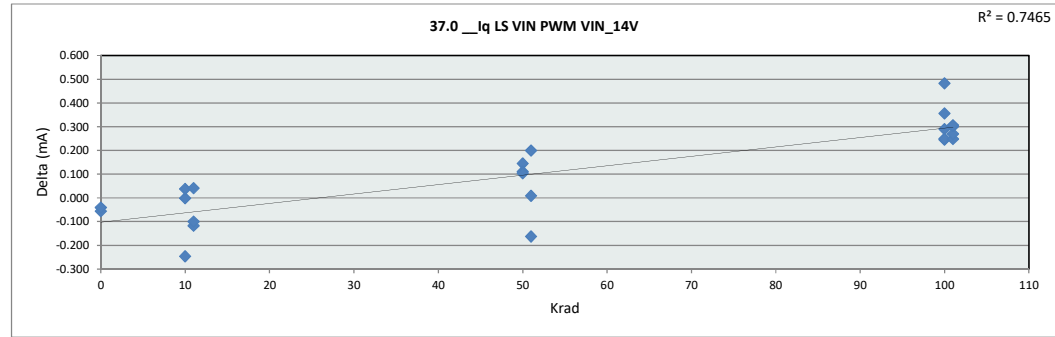

37.0 Iq LS VIN PWM VIN_14		
Test Site	DAL	
Tester	ETS364	
Test Number	EB672303	
Max Limit	6.8	mA
Min Limit	1	mA

Krad	0	10	11	50	51	100	101
LL	1.000	1.000	1.000	1.000	1.000	1.000	1.000
Min	4.196	4.168	4.317	4.306	4.292	4.603	4.539
Average	4.310	4.233	4.349	4.444	4.388	4.711	4.592
Max	4.424	4.302	4.379	4.519	4.521	4.808	4.686
UL	6.800	6.800	6.800	6.800	6.800	6.800	6.800

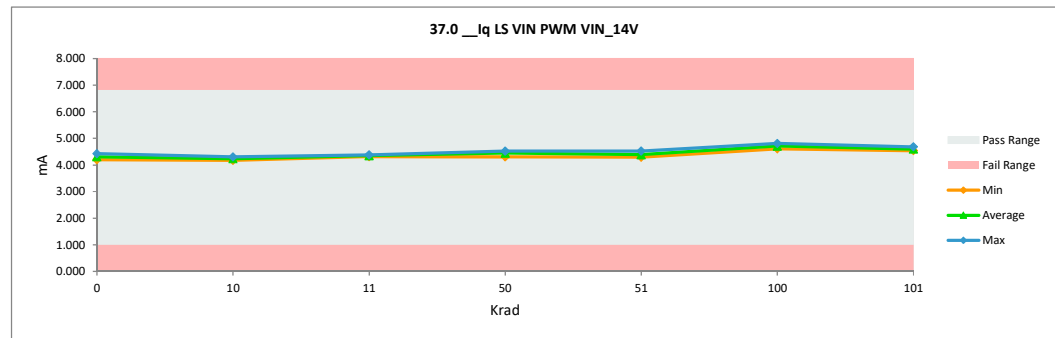

TID "HDR" Report
5962R2220102VXC

37.1 Iq HS BOOT PWM VIN_14		
Test Site	DAL	DAL
Tester	ETS364	ETS364
Test Number	EB672303	EB672303
Unit	mA	mA
Max Limit	6.3	6.3
Min Limit	1	1

Krad	Serial #	Pre_HDR_6013	Post_HDR_6013	Delta
0	1	3.686	3.627	-0.060
0	2	3.615	3.572	-0.043
10	182	3.646	3.633	-0.013
10	202	3.728	3.751	0.023
10	204	3.778	3.779	0.001
11	418	3.564	3.829	0.265
11	419	3.825	3.810	-0.016
11	443	3.611	3.700	0.089
50	259	3.682	3.803	0.121
50	346	3.842	3.990	0.148
50	347	3.683	3.846	0.163
51	462	3.846	3.843	-0.003
51	478	3.670	3.797	0.127
51	503	3.593	3.760	0.167
100	354	3.714	4.023	0.309
100	363	3.745	4.047	0.302
100	366	3.642	3.874	0.232
100	383	3.593	3.949	0.356
100	417	3.687	3.865	0.177
101	513	3.812	4.081	0.269
101	526	3.522	3.756	0.234
101	532	3.768	3.965	0.197
101	533	3.658	3.899	0.240
101	534	3.682	3.871	0.188
Max		3.846	4.081	0.356
Average		3.691	3.836	0.145
Min		3.522	3.572	-0.060
Std Dev		0.088	0.132	0.123

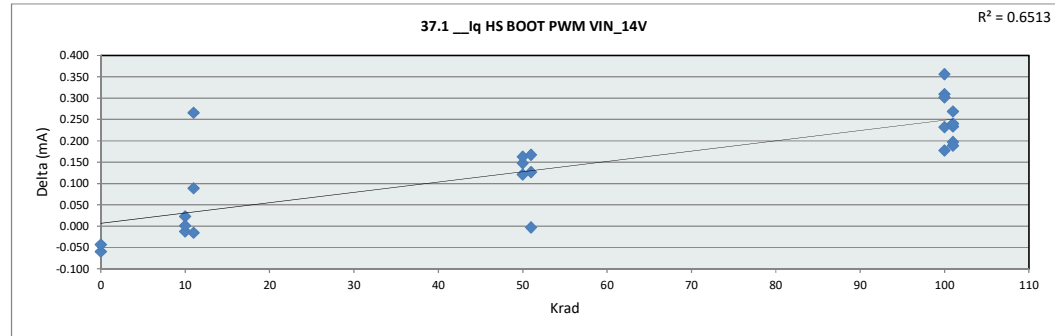

37.1 Iq HS BOOT PWM VIN		
Test Site	DAL	
Tester	ETS364	
Test Number	EB672303	
Max Limit	6.3	mA
Min Limit	1	mA

Krad	0	10	11	50	51	100	101
LL	1.000	1.000	1.000	1.000	1.000	1.000	1.000
Min	3.572	3.633	3.700	3.803	3.760	3.865	3.756
Average	3.599	3.721	3.780	3.880	3.800	3.952	3.914
Max	3.627	3.779	3.829	3.990	3.843	4.047	4.081
UL	6.300	6.300	6.300	6.300	6.300	6.300	6.300

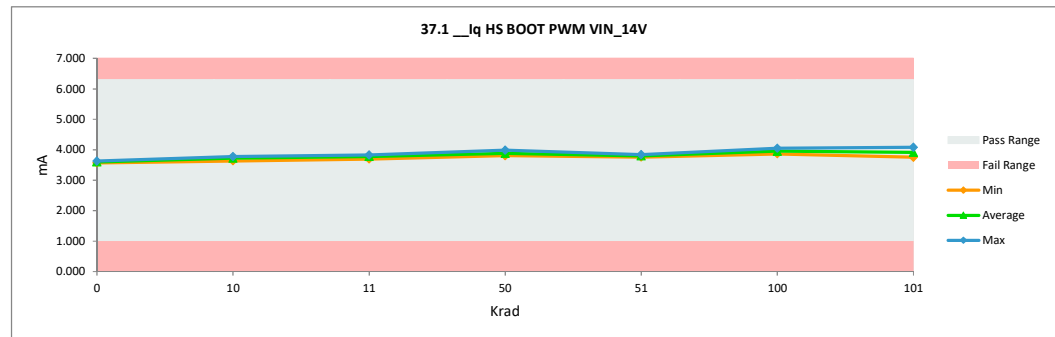

TID "HDR" Report
5962R2220102VXC

37.2 __Iq LS VIN IIM Interlock V		
Test Site	DAL	DAL
Tester	ETS364	ETS364
Test Number	EB672303	EB672303
Unit	mA	mA
Max Limit	8	8
Min Limit	1	1

Krad	Serial #	Pre_HDR_6013	Post_HDR_6013	Delta
0	1	4.409	4.353	-0.056
0	2	4.166	4.126	-0.040
10	182	4.100	4.098	-0.001
10	202	4.193	4.231	0.038
10	204	4.405	4.158	-0.247
11	418	4.425	4.307	-0.118
11	419	4.346	4.247	-0.099
11	443	4.239	4.279	0.040
50	259	4.289	4.433	0.144
50	346	4.337	4.448	0.111
50	347	4.132	4.236	0.104
51	462	4.273	4.279	0.005
51	478	4.385	4.221	-0.164
51	503	4.251	4.449	0.199
100	354	4.343	4.631	0.288
100	363	4.281	4.634	0.354
100	366	4.420	4.663	0.243
100	383	4.254	4.734	0.480
100	417	4.283	4.530	0.247
101	513	4.269	4.516	0.247
101	526	4.165	4.467	0.301
101	532	4.251	4.519	0.268
101	533	4.182	4.483	0.301
101	534	4.309	4.613	0.304
	Max	4.425	4.734	0.480
	Average	4.279	4.402	0.123
	Min	4.100	4.098	-0.247
	Std Dev	0.093	0.183	0.187

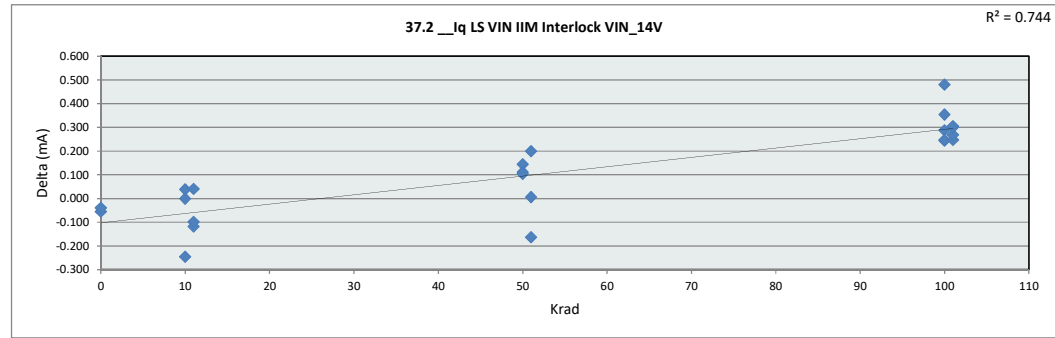

37.2 __Iq LS VIN IIM Interlock		
Test Site	DAL	
Tester	ETS364	
Test Number	EB672303	
Max Limit	8	mA
Min Limit	1	mA

Krad	0	10	11	50	51	100	101
LL	1.000	1.000	1.000	1.000	1.000	1.000	1.000
Min	4.126	4.098	4.247	4.236	4.221	4.530	4.467
Average	4.240	4.163	4.278	4.372	4.316	4.638	4.520
Max	4.353	4.231	4.307	4.448	4.449	4.734	4.613
UL	8.000	8.000	8.000	8.000	8.000	8.000	8.000

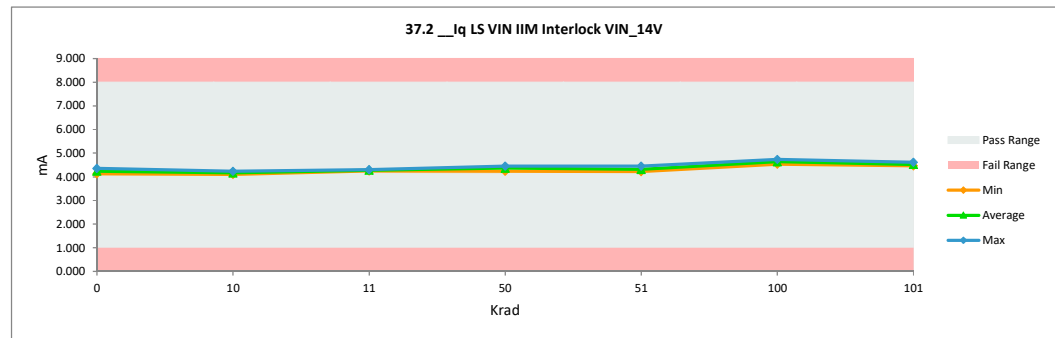

TID "HDR" Report
5962R2220102VXC

37.3 Iq HS BOOT IIM Interlock		
Test Site	DAL	DAL
Tester	ETS364	ETS364
Test Number	EB672303	EB672303
Unit	mA	mA
Max Limit	6.3	6.3
Min Limit	1	1

Krad	Serial #	Pre_HDR_6013	Post_HDR_6013	Delta
0	1	3.685	3.626	-0.059
0	2	3.615	3.572	-0.043
10	182	3.645	3.633	-0.012
10	202	3.728	3.751	0.023
10	204	3.778	3.779	0.001
11	418	3.563	3.828	0.264
11	419	3.825	3.810	-0.015
11	443	3.611	3.699	0.089
50	259	3.682	3.804	0.122
50	346	3.842	3.989	0.147
50	347	3.683	3.845	0.162
51	462	3.846	3.844	-0.001
51	478	3.670	3.796	0.127
51	503	3.594	3.760	0.166
100	354	3.714	4.024	0.311
100	363	3.745	4.049	0.304
100	366	3.642	3.873	0.231
100	383	3.593	3.949	0.357
100	417	3.687	3.866	0.180
101	513	3.812	4.080	0.268
101	526	3.522	3.756	0.234
101	532	3.769	3.966	0.198
101	533	3.658	3.900	0.241
101	534	3.682	3.869	0.187
Max		3.846	4.080	0.357
Average		3.691	3.836	0.145
Min		3.522	3.572	-0.059
Std Dev		0.089	0.132	0.123

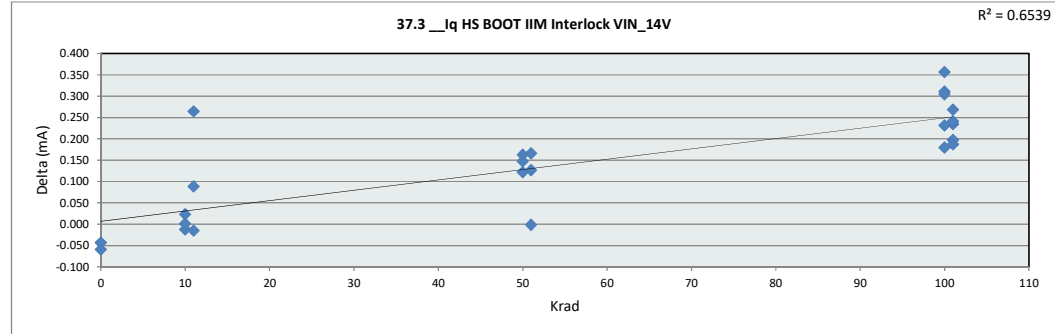

37.3 Iq HS BOOT IIM Interlock		
Test Site	DAL	
Tester	ETS364	
Test Number	EB672303	
Max Limit	6.3	mA
Min Limit	1	mA

	0	10	11	50	51	100	101
LL	1.000	1.000	1.000	1.000	1.000	1.000	1.000
Min	3.572	3.633	3.699	3.804	3.760	3.866	3.756
Average	3.599	3.721	3.779	3.880	3.800	3.952	3.914
Max	3.626	3.779	3.828	3.989	3.844	4.049	4.080
UL	6.300	6.300	6.300	6.300	6.300	6.300	6.300

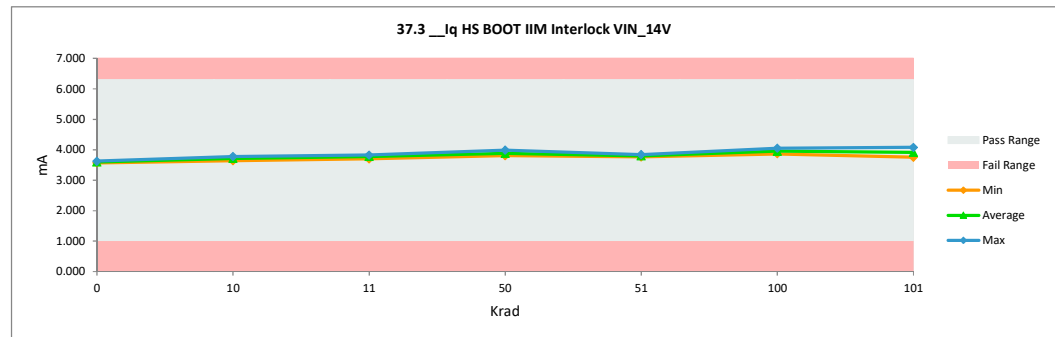

TID "HDR" Report
5962R2220102VXC

37.6 Iop LS VIN PWM 500kHz		
Test Site	DAL	DAL
Tester	ETS364	ETS364
Test Number	EB672303	EB672303
Unit	mA	mA
Max Limit	9	9
Min Limit	1	1

Krad	Serial #	Pre_HDR_6013	Post_HDR_6013	Delta
0	1	6.590	6.543	-0.047
0	2	6.298	6.264	-0.034
10	182	6.223	6.212	-0.011
10	202	6.318	6.341	0.023
10	204	6.497	6.319	-0.178
11	418	6.495	6.479	-0.016
11	419	6.407	6.428	0.021
11	443	6.329	6.408	0.079
50	259	6.401	6.489	0.089
50	346	6.473	6.524	0.050
50	347	6.314	6.358	0.044
51	462	6.301	6.372	0.072
51	478	6.520	6.260	-0.260
51	503	6.383	6.510	0.127
100	354	6.503	6.683	0.180
100	363	6.444	6.657	0.213
100	366	6.560	6.707	0.146
100	383	6.315	6.802	0.486
100	417	6.365	6.603	0.238
101	513	6.382	6.495	0.113
101	526	6.388	6.536	0.148
101	532	6.377	6.514	0.138
101	533	6.278	6.471	0.193
101	534	6.406	6.587	0.180
	Max	6.590	6.802	0.486
	Average	6.399	6.482	0.083
	Min	6.223	6.212	-0.260
	Std Dev	0.095	0.149	0.146

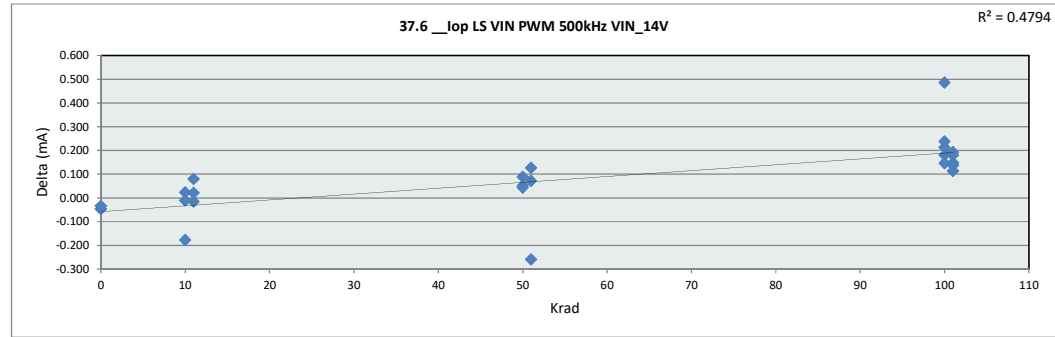

37.6 Iop LS VIN PWM 500kHz		
Test Site	DAL	
Tester	ETS364	
Test Number	EB672303	
Max Limit	9	mA
Min Limit	1	mA

Krad	0	10	11	50	51	100	101
LL	1.000	1.000	1.000	1.000	1.000	1.000	1.000
Min	6.264	6.212	6.408	6.358	6.260	6.603	6.471
Average	6.404	6.291	6.438	6.457	6.381	6.690	6.520
Max	6.543	6.341	6.479	6.524	6.510	6.802	6.587
UL	9.000	9.000	9.000	9.000	9.000	9.000	9.000

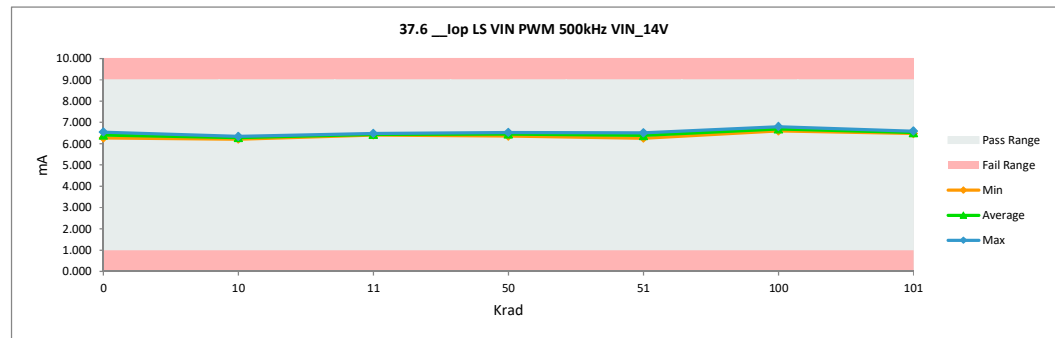

TID "HDR" Report
5962R2220102VXC

37.7 Iop HS BOOT PWM 500kHz		
Test Site	DAL	DAL
Tester	ETS364	ETS364
Test Number	EB672303	EB672303
Unit	mA	mA
Max Limit	6.5	6.5
Min Limit	1	1

Krad	Serial #	Pre_HDR_6013	Post_HDR_6013	Delta
0	1	4.512	4.451	-0.061
0	2	4.445	4.404	-0.042
10	182	4.470	4.457	-0.013
10	202	4.557	4.580	0.023
10	204	4.610	4.610	0.000
11	418	4.389	4.661	0.272
11	419	4.654	4.638	-0.016
11	443	4.440	4.524	0.084
50	259	4.508	4.629	0.121
50	346	4.667	4.816	0.149
50	347	4.512	4.678	0.166
51	462	4.673	4.674	0.002
51	478	4.495	4.627	0.132
51	503	4.425	4.592	0.167
100	354	4.542	4.854	0.312
100	363	4.570	4.879	0.308
100	366	4.466	4.699	0.233
100	383	4.424	4.775	0.352
100	417	4.513	4.697	0.184
101	513	4.638	4.902	0.265
101	526	4.350	4.588	0.238
101	532	4.599	4.794	0.196
101	533	4.484	4.726	0.242
101	534	4.507	4.691	0.184
	Max	4.673	4.902	0.352
	Average	4.519	4.664	0.146
	Min	4.350	4.404	-0.061
	Std Dev	0.088	0.132	0.123

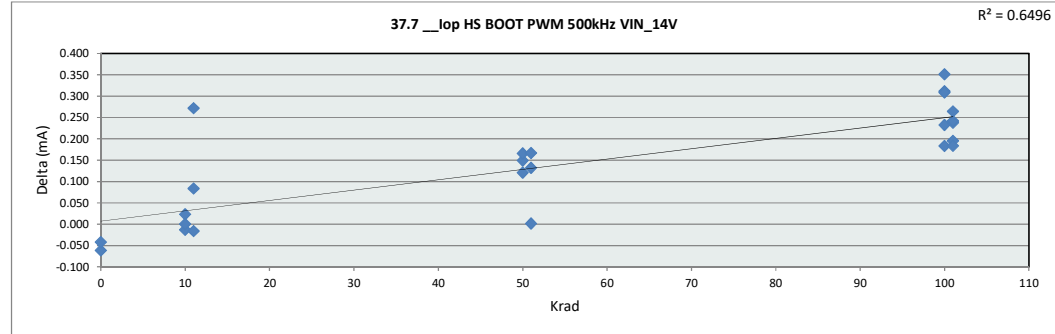

37.7 Iop HS BOOT PWM 500		
Test Site	DAL	
Tester	ETS364	
Test Number	EB672303	
Max Limit	6.5	mA
Min Limit	1	mA

Krad	0	10	11	50	51	100	101
LL	1.000	1.000	1.000	1.000	1.000	1.000	1.000
Min	4.404	4.457	4.524	4.629	4.592	4.697	4.588
Average	4.427	4.549	4.608	4.708	4.631	4.781	4.740
Max	4.451	4.610	4.661	4.816	4.674	4.879	4.902
UL	6.500	6.500	6.500	6.500	6.500	6.500	6.500

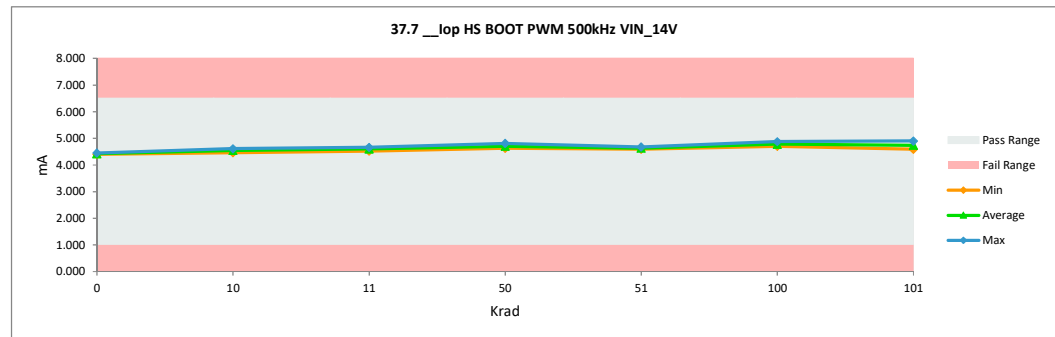

TID "HDR" Report
5962R2220102VXC

37.8 Iop LS VIN PWM 1MHz VIN_14V		
Test Site	DAL	DAL
Tester	ETS364	ETS364
Test Number	EB672303	EB672303
Unit	mA	mA
Max Limit	11	11
Min Limit	1	1

Krad	Serial #	Pre_HDR_6013	Post_HDR_6013	Delta
0	1	8.292	8.243	-0.049
0	2	7.996	7.960	-0.036
10	182	7.909	7.904	-0.005
10	202	8.008	8.038	0.030
10	204	8.200	8.025	-0.175
11	418	8.190	8.187	-0.003
11	419	8.099	8.126	0.027
11	443	8.015	8.100	0.084
50	259	8.087	8.193	0.106
50	346	8.167	8.234	0.067
50	347	8.012	8.078	0.066
51	462	7.993	8.101	0.107
51	478	8.209	7.974	-0.235
51	503	8.082	8.228	0.146
100	354	8.213	8.425	0.212
100	363	8.134	8.388	0.253
100	366	8.251	8.430	0.179
100	383	7.998	8.530	0.531
100	417	8.052	8.343	0.292
101	513	8.079	8.219	0.140
101	526	8.081	8.260	0.179
101	532	8.083	8.250	0.167
101	533	7.970	8.201	0.230
101	534	8.102	8.308	0.206
Max		8.292	8.530	0.531
Average		8.093	8.198	0.105
Min		7.909	7.904	-0.235
Std Dev		0.098	0.159	0.157

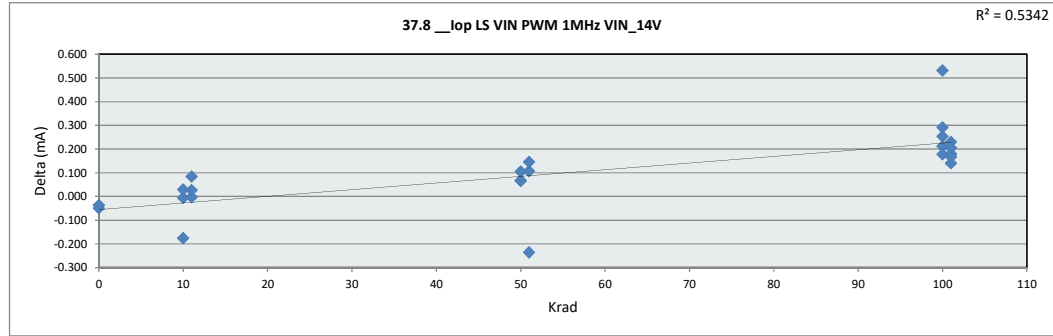

37.8 Iop LS VIN PWM 1MHz		
Test Site	DAL	
Tester	ETS364	
Test Number	EB672303	
Max Limit	11	mA
Min Limit	1	mA

Krad	0	10	11	50	51	100	101
LL	1.000	1.000	1.000	1.000	1.000	1.000	1.000
Min	7.960	7.904	8.100	8.078	7.974	8.343	8.201
Average	8.101	7.989	8.138	8.169	8.101	8.423	8.248
Max	8.243	8.038	8.187	8.235	8.228	8.530	8.308
UL	11.000	11.000	11.000	11.000	11.000	11.000	11.000

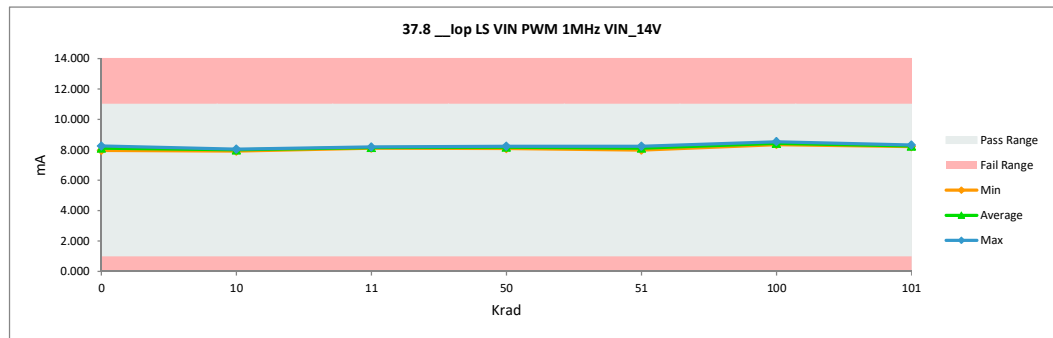

TID "HDR" Report
5962R2220102VXC

37.9 Iop HS BOOT PWM 1MHz		
Test Site	DAL	DAL
Tester	ETS364	ETS364
Test Number	EB672303	EB672303
Unit	mA	mA
Max Limit	8	8
Min Limit	1	1

Krad	Serial #	Pre_HDR_6013	Post_HDR_6013	Delta
0	1	5.334	5.275	-0.059
0	2	5.276	5.233	-0.042
10	182	5.294	5.284	-0.010
10	202	5.384	5.407	0.023
10	204	5.440	5.439	-0.001
11	418	5.216	5.495	0.279
11	419	5.478	5.464	-0.015
11	443	5.267	5.348	0.081
50	259	5.329	5.452	0.123
50	346	5.490	5.641	0.150
50	347	5.340	5.509	0.168
51	462	5.502	5.505	0.003
51	478	5.314	5.456	0.142
51	503	5.257	5.423	0.166
100	354	5.367	5.682	0.315
100	363	5.392	5.706	0.314
100	366	5.291	5.520	0.229
100	383	5.247	5.598	0.351
100	417	5.332	5.526	0.194
101	513	5.458	5.724	0.266
101	526	5.176	5.414	0.238
101	532	5.428	5.619	0.191
101	533	5.304	5.544	0.240
101	534	5.326	5.513	0.186
Max		5.502	5.724	0.351
Average		5.343	5.491	0.147
Min		5.176	5.233	-0.059
Std Dev		0.088	0.131	0.124

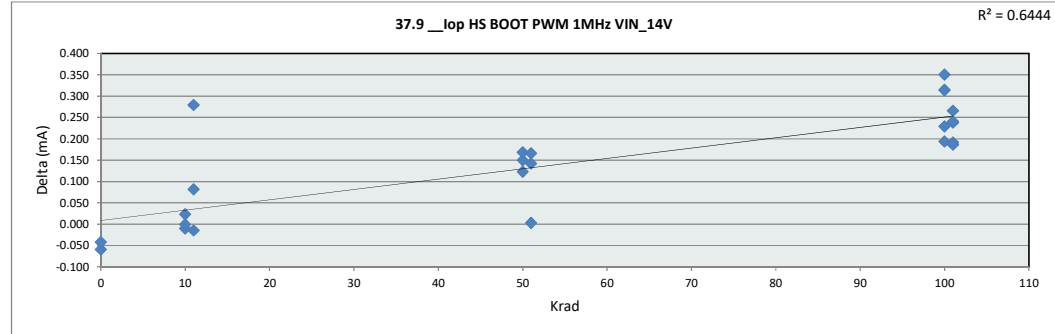

37.9 Iop HS BOOT PWM 1MHz		
Test Site	DAL	
Tester	ETS364	
Test Number	EB672303	
Max Limit	8	mA
Min Limit	1	mA

Krad	0	10	11	50	51	100	101
LL	1.000	1.000	1.000	1.000	1.000	1.000	1.000
Min	5.233	5.284	5.348	5.452	5.423	5.520	5.414
Average	5.254	5.376	5.436	5.534	5.461	5.606	5.563
Max	5.275	5.439	5.495	5.641	5.505	5.706	5.724
UL	8.000	8.000	8.000	8.000	8.000	8.000	8.000

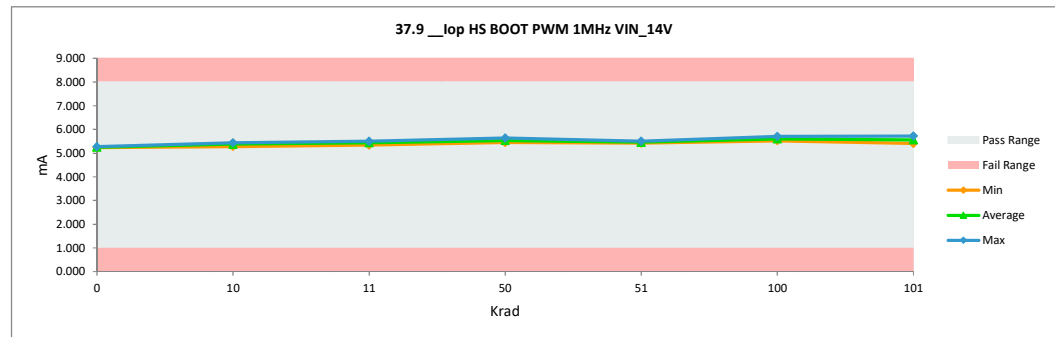

TID "HDR" Report 5962R2220102VXC

37.10_Iop LS VIN PWM 2MHz V		
Test Site	DAL	DAL
Tester	ETS364	ETS364
Test Number	EB672303	EB672303
Unit	mA	mA
Max Limit	16	16
Min Limit	1	1

Krad	Serial #	Pre_HDR_6013	Post_HDR_6013	Delta
0	1	11.675	11.624	-0.051
0	2	11.376	11.334	-0.042
10	182	11.260	11.265	0.004
10	202	11.372	11.414	0.042
10	204	11.610	11.422	-0.188
11	418	11.583	11.581	-0.002
11	419	11.491	11.519	0.027
11	443	11.402	11.460	0.059
50	259	11.450	11.615	0.165
50	346	11.541	11.666	0.125
50	347	11.384	11.512	0.127
51	462	11.387	11.540	0.153
51	478	11.594	11.409	-0.185
51	503	11.458	11.649	0.191
100	354	11.607	11.916	0.309
100	363	11.521	11.840	0.320
100	366	11.616	11.877	0.262
100	383	11.370	11.993	0.622
100	417	11.431	11.831	0.400
101	513	11.453	11.677	0.224
101	526	11.453	11.708	0.256
101	532	11.470	11.722	0.253
101	533	11.340	11.672	0.332
101	534	11.470	11.753	0.284
Max		11.675	11.993	0.622
Average		11.471	11.625	0.154
Min		11.260	11.265	-0.188
Std Dev		0.104	0.189	0.188

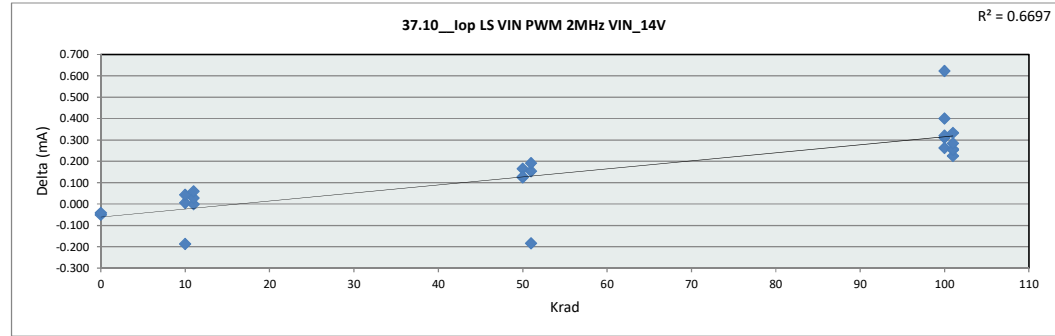

37.10_Iop LS VIN PWM 2MHz		
Test Site	DAL	
Tester	ETS364	
Test Number	EB672303	
Max Limit	16	mA
Min Limit	1	mA

Krad	0	10	11	50	51	100	101
LL	1.000	1.000	1.000	1.000	1.000	1.000	1.000
Min	11.334	11.265	11.460	11.512	11.409	11.831	11.672
Average	11.479	11.367	11.520	11.598	11.533	11.892	11.707
Max	11.624	11.422	11.581	11.666	11.649	11.993	11.754
UL	16.000	16.000	16.000	16.000	16.000	16.000	16.000

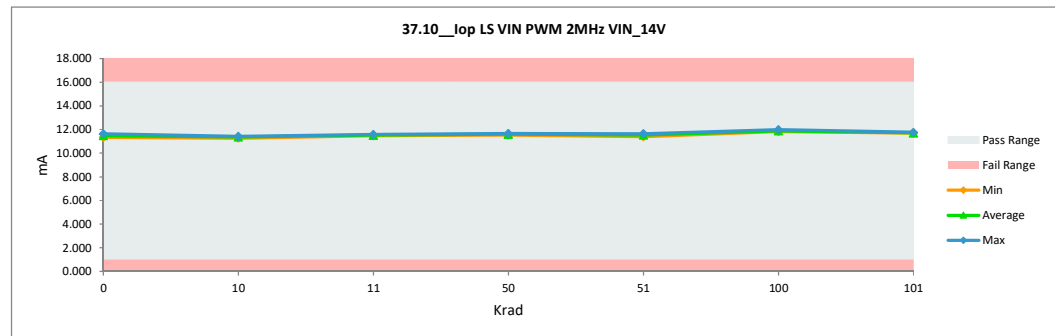

TID "HDR" Report
5962R2220102VXC

37.11_Iop HS BOOT PWM 2MHz		
Test Site	DAL	DAL
Tester	ETS364	ETS364
Test Number	EB672303	EB672303
Unit	mA	mA
Max Limit	10.5	10.5
Min Limit	1	1

Krad	Serial #	Pre_HDR_6013	Post_HDR_6013	Delta
0	1	7.000	6.943	-0.057
0	2	6.940	6.900	-0.039
10	182	6.964	6.952	-0.012
10	202	7.054	7.084	0.030
10	204	7.117	7.107	-0.010
11	418	6.884	7.181	0.297
11	419	7.150	7.137	-0.013
11	443	6.946	7.010	0.064
50	259	6.985	7.088	0.104
50	346	7.153	7.307	0.154
50	347	6.996	7.191	0.195
51	462	7.163	7.171	0.008
51	478	6.966	7.137	0.171
51	503	6.936	7.095	0.159
100	354	7.039	7.351	0.312
100	363	7.057	7.377	0.320
100	366	6.944	7.153	0.209
100	383	6.924	7.243	0.319
100	417	7.003	7.196	0.193
101	513	7.127	7.360	0.232
101	526	6.848	7.071	0.223
101	532	7.105	7.262	0.157
101	533	6.968	7.196	0.228
101	534	6.975	7.127	0.151
	Max	7.163	7.377	0.320
	Average	7.010	7.152	0.141
	Min	6.848	6.900	-0.057
	Std Dev	0.088	0.127	0.120

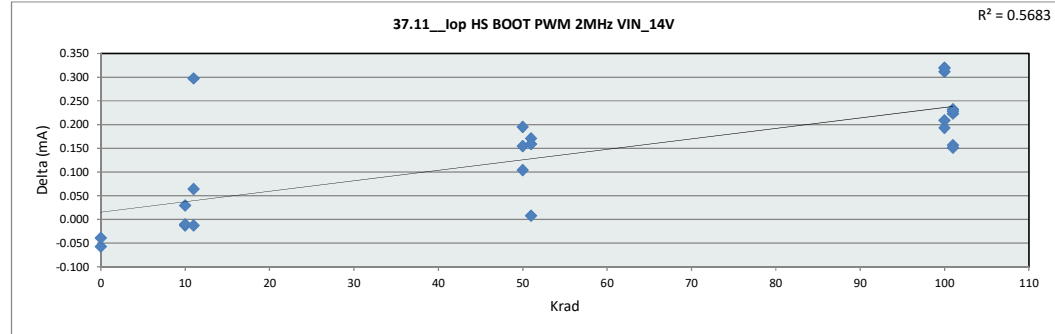

37.11_Iop HS BOOT PWM 2M		
Test Site	DAL	
Tester	ETS364	
Test Number	EB672303	
Max Limit	10.5	mA
Min Limit	1	mA

Krad	0	10	11	50	51	100	101
LL	1.000	1.000	1.000	1.000	1.000	1.000	1.000
Min	6.901	6.952	7.010	7.088	7.095	7.153	7.071
Average	6.922	7.047	7.110	7.195	7.135	7.264	7.203
Max	6.943	7.107	7.181	7.307	7.171	7.377	7.360
UL	10.500	10.500	10.500	10.500	10.500	10.500	10.500

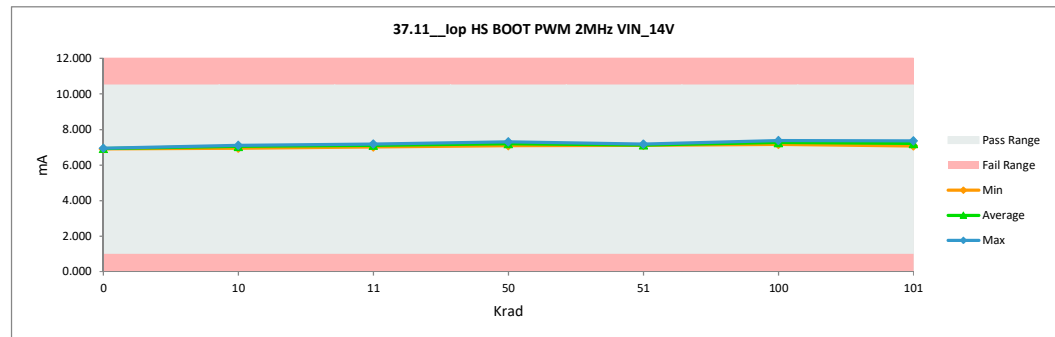

TID "HDR" Report
5962R2220102VXC

37.12_Iop LS VIN PWM 5MHz V		
Test Site	DAL	DAL
Tester	ETS364	ETS364
Test Number	EB672303	EB672303
Unit	mA	mA
Max Limit	30	30
Min Limit	1	1

Krad	Serial #	Pre_HDR_6013	Post_HDR_6013	Delta
0	1	18.247	18.137	-0.110
0	2	17.727	19.865	2.138
10	182	17.784	17.869	0.085
10	202	17.997	18.160	0.163
10	204	18.344	17.968	-0.377
11	418	18.024	18.483	0.459
11	419	18.316	18.354	0.039
11	443	17.813	18.277	0.463
50	259	18.670	18.913	0.244
50	346	18.425	18.817	0.392
50	347	18.500	17.928	-0.572
51	462	18.463	18.448	-0.016
51	478	18.044	18.127	0.084
51	503	18.212	18.761	0.549
100	354	18.518	19.192	0.675
100	363	18.352	20.978	2.626
100	366	18.662	19.134	0.472
100	383	18.125	19.173	1.049
100	417	17.746	18.946	1.201
101	513	18.119	18.794	0.675
101	526	17.836	18.860	1.024
101	532	18.202	18.973	0.771
101	533	17.768	18.890	1.122
101	534	18.571	18.994	0.423
	Max	18.670	20.978	2.626
	Average	18.186	18.752	0.566
	Min	17.727	17.869	-0.572
	Std Dev	0.303	0.681	0.722

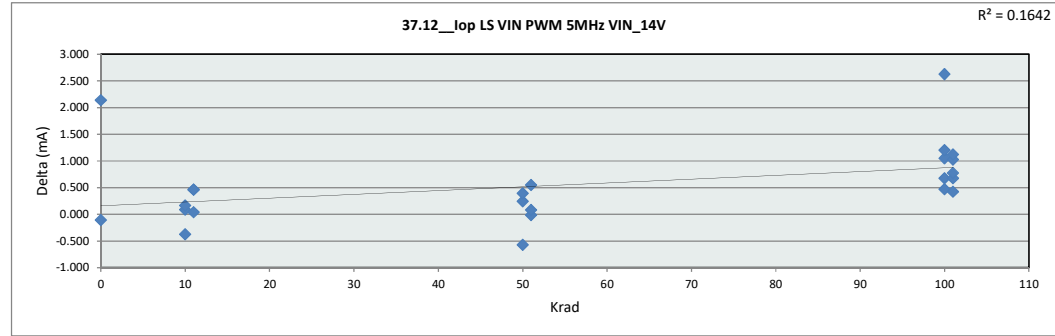

37.12_Iop LS VIN PWM 5MHz		
Test Site	DAL	
Tester	ETS364	
Test Number	EB672303	
Max Limit	30	mA
Min Limit	1	mA

	0	10	11	50	51	100	101
LL	1.000	1.000	1.000	1.000	1.000	1.000	1.000
Min	18.137	17.869	18.277	17.928	18.127	18.946	18.794
Average	19.001	17.999	18.371	18.553	18.445	19.485	18.902
Max	19.865	18.160	18.483	18.913	18.761	20.978	18.994
UL	30.000	30.000	30.000	30.000	30.000	30.000	30.000

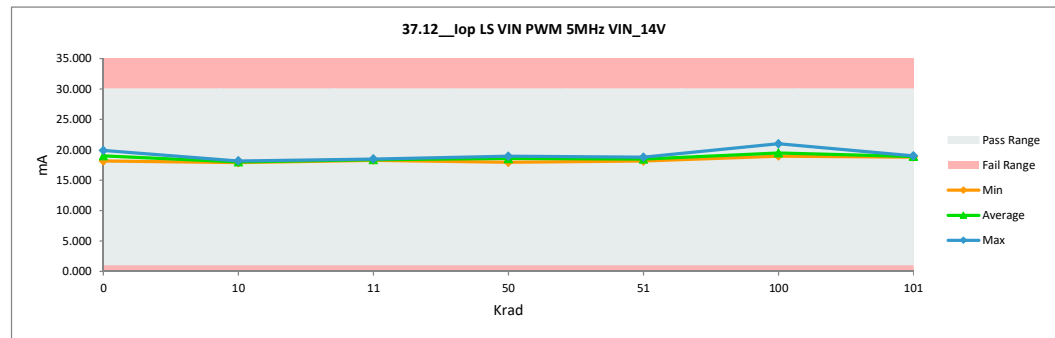

TID "HDR" Report
5962R2220102VXC

37.13_Iop HS BOOT PWM 5MHz		
Test Site	DAL	DAL
Tester	ETS364	ETS364
Test Number	EB672303	EB672303
Unit	mA	mA
Max Limit	17.5	17.5
Min Limit	1	1

Krad	Serial #	Pre_HDR_6013	Post_HDR_6013	Delta
0	1	13.103	13.190	0.087
0	2	10.910	10.880	-0.030
10	182	12.325	12.094	-0.231
10	202	13.286	12.826	-0.460
10	204	13.826	13.874	0.048
11	418	12.926	12.743	-0.183
11	419	13.377	13.233	-0.144
11	443	12.859	11.852	-1.008
50	259	11.085	10.799	-0.286
50	346	13.045	12.147	-0.898
50	347	13.321	13.665	0.344
51	462	13.355	11.410	-1.946
51	478	13.307	12.482	-0.825
51	503	12.907	11.626	-1.281
100	354	13.602	11.526	-2.075
100	363	13.512	12.080	-1.432
100	366	11.008	10.700	-0.308
100	383	12.500	10.919	-1.581
100	417	12.880	11.924	-0.956
101	513	13.022	11.424	-1.599
101	526	12.424	10.690	-1.734
101	532	12.778	11.084	-1.695
101	533	13.590	11.264	-2.327
101	534	10.989	10.570	-0.419
	Max	13.826	13.874	0.344
	Average	12.747	11.875	-0.872
	Min	10.910	10.570	-2.327
	Std Dev	0.881	0.981	0.783

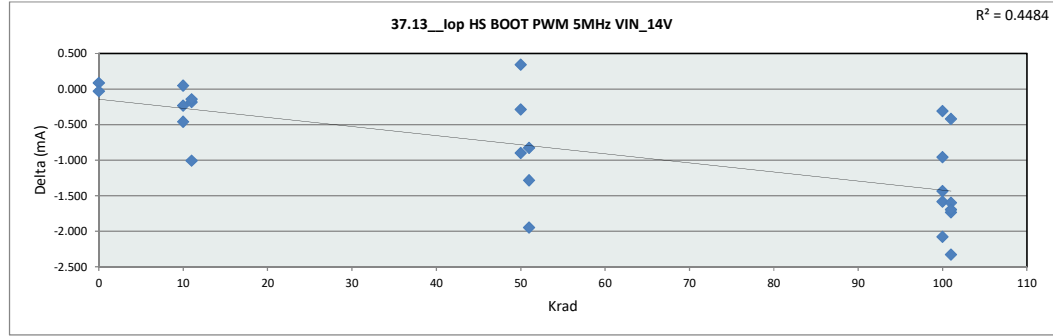

37.13_Iop HS BOOT PWM 5M		
Test Site	DAL	
Tester	ETS364	
Test Number	EB672303	
Max Limit	17.5	mA
Min Limit	1	mA

Krad	0	10	11	50	51	100	101
LL	1.000	1.000	1.000	1.000	1.000	1.000	1.000
Min	10.880	12.094	11.852	10.799	11.410	10.701	10.570
Average	12.035	12.931	12.609	12.204	11.839	11.430	11.006
Max	13.190	13.874	13.233	13.665	12.482	12.080	11.424
UL	17.500	17.500	17.500	17.500	17.500	17.500	17.500

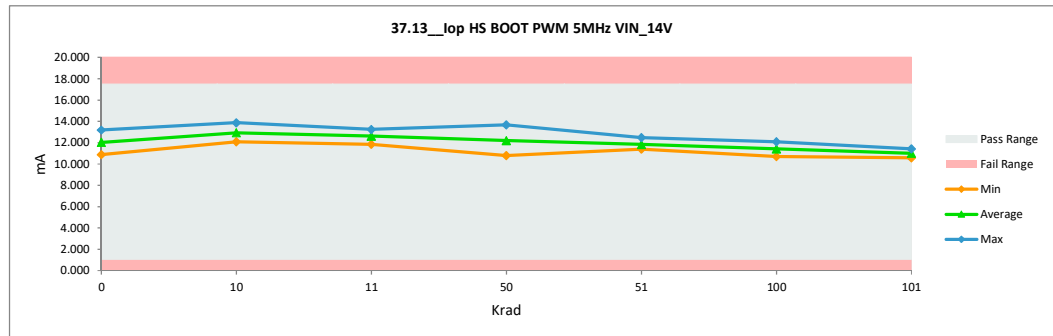

TID "HDR" Report
5962R2220102VXC

37.14_Iop LS VIN IIM Interlock

Test Site	DAL	DAL
Tester	ETS364	ETS364
Test Number	EB672303	EB672303
Unit	mA	mA
Max Limit	9	9
Min Limit	1	1

Krad	Serial #	Pre_HDR_6013	Post_HDR_6013	Delta
0	1	6.016	5.960	-0.056
0	2	5.753	5.711	-0.042
10	182	5.677	5.674	-0.003
10	202	5.771	5.807	0.037
10	204	5.975	5.758	-0.217
11	418	5.992	5.908	-0.084
11	419	5.907	5.852	-0.055
11	443	5.807	5.858	0.050
50	259	5.861	6.007	0.146
50	346	5.917	6.026	0.109
50	347	5.725	5.829	0.103
51	462	5.822	5.868	0.047
51	478	5.967	5.791	-0.176
51	503	5.832	6.019	0.187
100	354	5.937	6.221	0.285
100	363	5.872	6.215	0.343
100	366	6.006	6.247	0.240
100	383	5.813	6.331	0.518
100	417	5.847	6.128	0.282
101	513	5.841	6.071	0.230
101	526	5.777	6.053	0.276
101	532	5.831	6.082	0.251
101	533	5.747	6.041	0.293
101	534	5.882	6.167	0.285
Max		6.016	6.331	0.518
Average		5.857	5.984	0.127
Min		5.677	5.674	-0.217
Std Dev		0.093	0.181	0.181

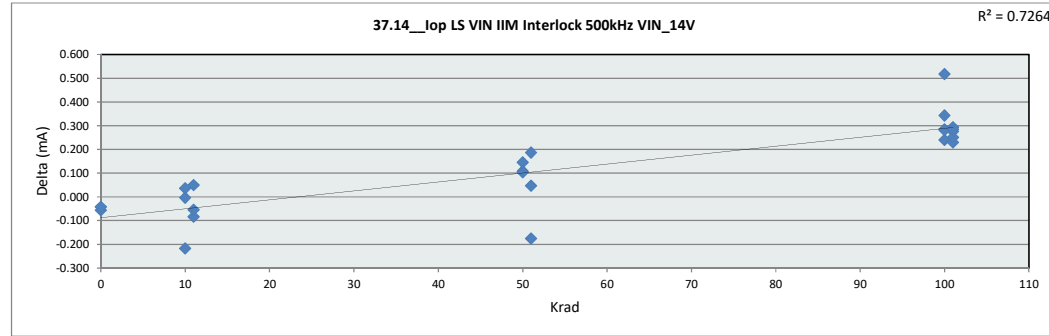

37.14_Iop LS VIN IIM Interlo

Test Site	DAL
Tester	ETS364
Test Number	EB672303
Max Limit	9 mA
Min Limit	1 mA

Krad	0	10	11	50	51	100	101
LL	1.000	1.000	1.000	1.000	1.000	1.000	1.000
Min	5.711	5.674	5.852	5.829	5.791	6.128	6.041
Average	5.835	5.746	5.873	5.954	5.893	6.229	6.083
Max	5.960	5.807	5.908	6.026	6.019	6.331	6.167
UL	9.000	9.000	9.000	9.000	9.000	9.000	9.000

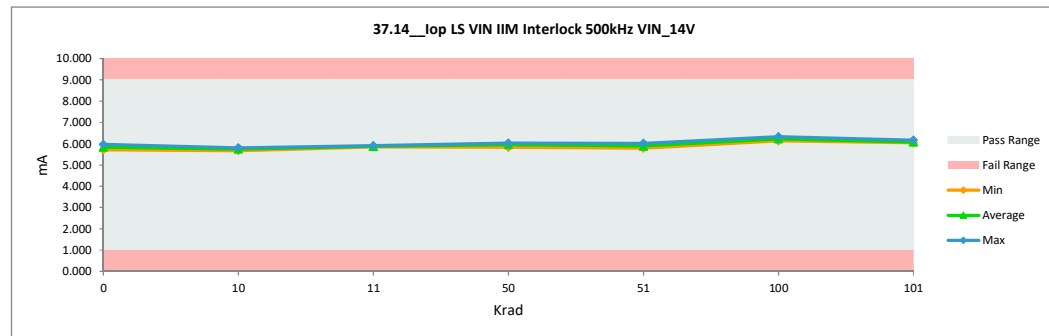

TID "HDR" Report
5962R2220102VXC

37.15 Iop HS BOOT IIM Interlock 500kHz VIN_14V		
Test Site	DAL	DAL
Tester	ETS364	ETS364
Test Number	EB672303	EB672303
Unit	mA	mA
Max Limit	6.5	6.5
Min Limit	1	1

Krad	Serial #	Pre_HDR_6013	Post_HDR_6013	Delta
0	1	4.509	4.453	-0.056
0	2	4.445	4.403	-0.042
10	182	4.473	4.460	-0.013
10	202	4.557	4.578	0.022
10	204	4.611	4.610	-0.001
11	418	4.392	4.664	0.272
11	419	4.653	4.640	-0.013
11	443	4.437	4.526	0.089
50	259	4.507	4.629	0.122
50	346	4.665	4.814	0.149
50	347	4.512	4.676	0.164
51	462	4.675	4.675	0.001
51	478	4.493	4.626	0.133
51	503	4.426	4.593	0.167
100	354	4.542	4.856	0.314
100	363	4.571	4.877	0.306
100	366	4.467	4.698	0.231
100	383	4.421	4.776	0.355
100	417	4.511	4.693	0.181
101	513	4.638	4.904	0.266
101	526	4.351	4.581	0.230
101	532	4.601	4.797	0.195
101	533	4.483	4.727	0.244
101	534	4.504	4.693	0.189
	Max	4.675	4.904	0.355
	Average	4.519	4.665	0.146
	Min	4.351	4.403	-0.056
	Std Dev	0.088	0.132	0.123

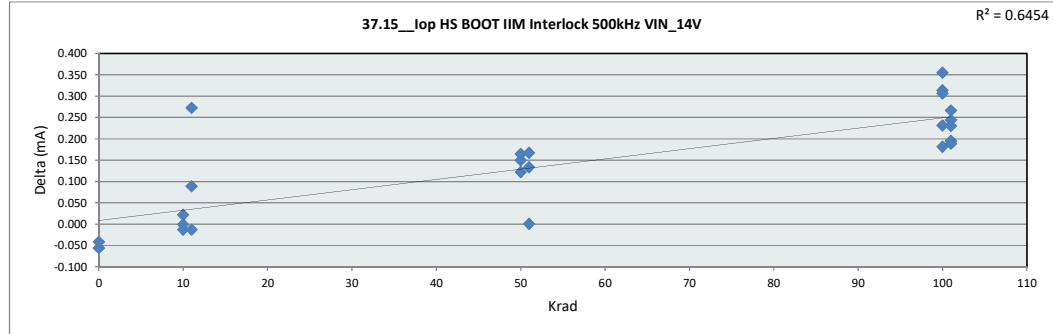

37.15 Iop HS BOOT IIM Interlock 500kHz VIN_14V		
Test Site	DAL	
Tester	ETS364	
Test Number	EB672303	
Max Limit	6.5	mA
Min Limit	1	mA

Krad	0	10	11	50	51	100	101
LL	1.000	1.000	1.000	1.000	1.000	1.000	1.000
Min	4.403	4.460	4.526	4.629	4.593	4.693	4.581
Average	4.428	4.550	4.610	4.707	4.632	4.780	4.740
Max	4.453	4.610	4.664	4.815	4.675	4.877	4.904
UL	6.500	6.500	6.500	6.500	6.500	6.500	6.500

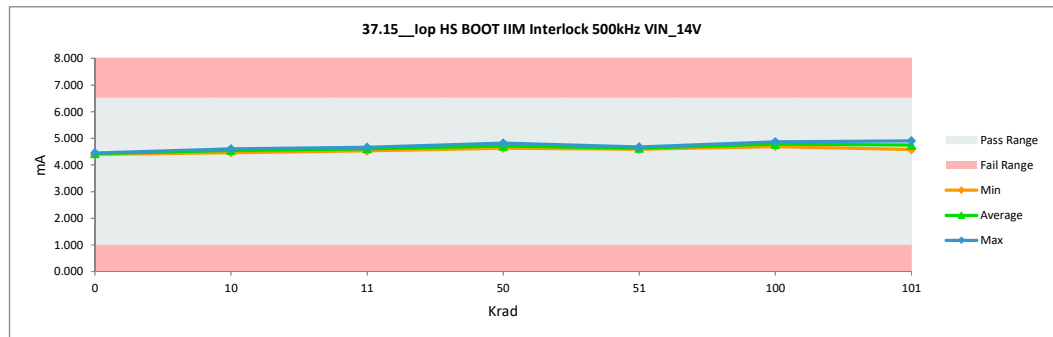

TID "HDR" Report
5962R2220102VXC

37.16_Iop LS VIN IIM Interlock		
Test Site	DAL	DAL
Tester	ETS364	ETS364
Test Number	EB672303	EB672303
Unit	mA	mA
Max Limit	12	12
Min Limit	1	1

Krad	Serial #	Pre_HDR_6013	Post_HDR_6013	Delta
0	1	7.489	7.431	-0.058
0	2	7.220	7.176	-0.044
10	182	7.133	7.136	0.003
10	202	7.229	7.273	0.044
10	204	7.446	7.231	-0.215
11	418	7.460	7.386	-0.074
11	419	7.372	7.324	-0.048
11	443	7.266	7.316	0.050
50	259	7.322	7.490	0.168
50	346	7.379	7.510	0.131
50	347	7.190	7.316	0.126
51	462	7.287	7.366	0.079
51	478	7.425	7.276	-0.149
51	503	7.298	7.510	0.212
100	354	7.410	7.730	0.320
100	363	7.335	7.715	0.380
100	366	7.468	7.746	0.278
100	383	7.271	7.832	0.561
100	417	7.306	7.638	0.332
101	513	7.309	7.573	0.264
101	526	7.246	7.553	0.307
101	532	7.304	7.589	0.284
101	533	7.211	7.544	0.333
101	534	7.346	7.664	0.318
	Max	7.489	7.832	0.561
	Average	7.322	7.472	0.150
	Min	7.133	7.136	-0.215
	Std Dev	0.095	0.194	0.194

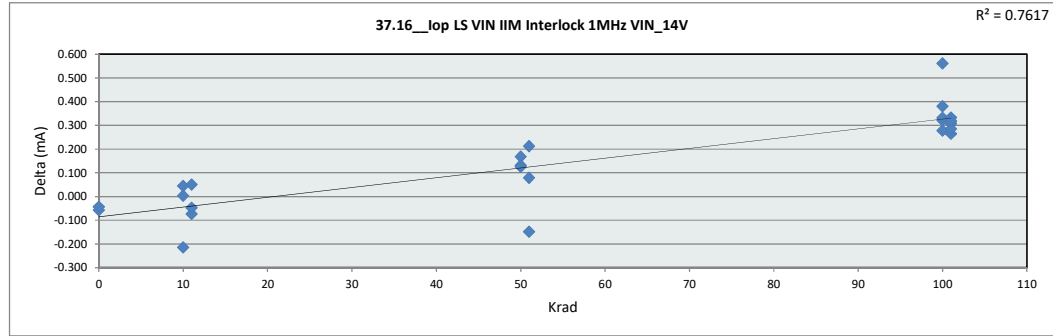

37.16_Iop LS VIN IIM Interlo		
Test Site	DAL	
Tester	ETS364	
Test Number	EB672303	
Max Limit	12	mA
Min Limit	1	mA

Krad	0	10	11	50	51	100	101
LL	1.000	1.000	1.000	1.000	1.000	1.000	1.000
Min	7.176	7.136	7.316	7.316	7.276	7.638	7.544
Average	7.304	7.213	7.342	7.439	7.384	7.732	7.585
Max	7.431	7.273	7.386	7.510	7.510	7.832	7.664
UL	12.000	12.000	12.000	12.000	12.000	12.000	12.000

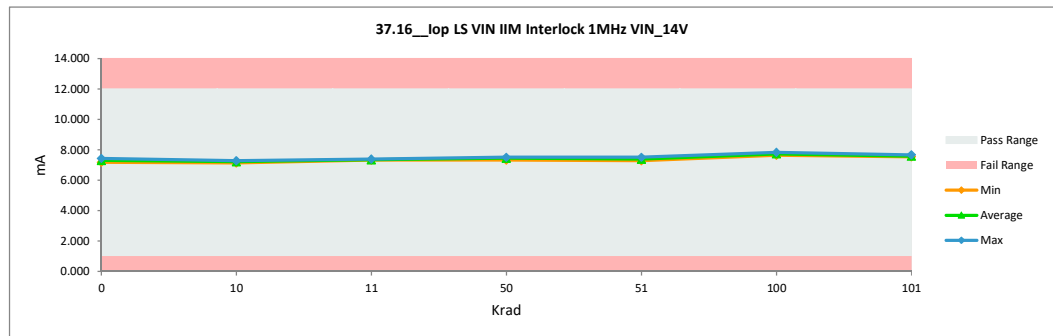

TID "HDR" Report
5962R2220102VXC

37.17__Iop HS BOOT IIM Interlock 1MHz VIN_14V		
Test Site	DAL	
Tester	ETS364	
Test Number	EB672303	
Unit	mA	
Max Limit	8	
Min Limit	1	

Krad	Serial #	Pre_HDR_6013	Post_HDR_6013	Delta
0	1	5.333	5.275	-0.058
0	2	5.272	5.231	-0.041
10	182	5.300	5.286	-0.014
10	202	5.381	5.407	0.026
10	204	5.439	5.442	0.003
11	418	5.214	5.497	0.283
11	419	5.481	5.467	-0.014
11	443	5.262	5.351	0.089
50	259	5.327	5.451	0.124
50	346	5.485	5.632	0.147
50	347	5.338	5.507	0.169
51	462	5.501	5.505	0.004
51	478	5.315	5.454	0.139
51	503	5.257	5.422	0.165
100	354	5.371	5.684	0.313
100	363	5.396	5.700	0.305
100	366	5.288	5.521	0.233
100	383	5.245	5.602	0.356
100	417	5.337	5.521	0.184
101	513	5.458	5.724	0.267
101	526	5.175	5.409	0.234
101	532	5.431	5.622	0.191
101	533	5.304	5.544	0.240
101	534	5.325	5.509	0.185
	Max	5.501	5.724	0.356
	Average	5.343	5.490	0.147
	Min	5.175	5.231	-0.058
	Std Dev	0.089	0.130	0.123

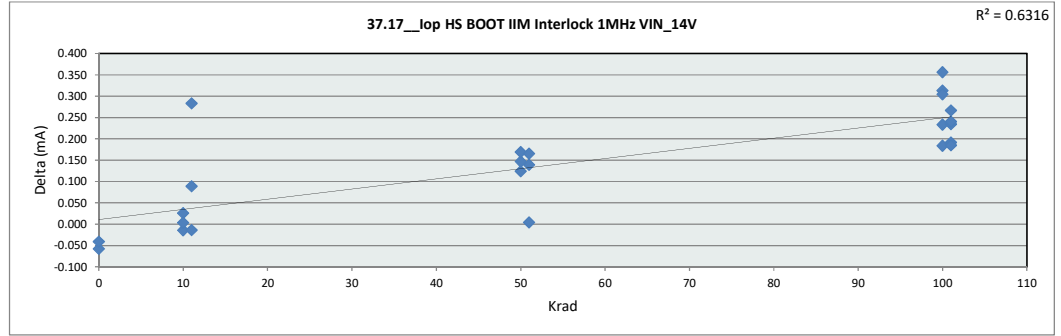

37.17__Iop HS BOOT IIM Interlock 1MHz VIN_14V		
Test Site	DAL	
Tester	ETS364	
Test Number	EB672303	
Max Limit	8	mA
Min Limit	1	mA

Krad	0	10	11	50	51	100	101
LL	1.000	1.000	1.000	1.000	1.000	1.000	1.000
Min	5.231	5.286	5.351	5.451	5.422	5.521	5.409
Average	5.253	5.378	5.438	5.530	5.460	5.605	5.562
Max	5.275	5.442	5.497	5.632	5.505	5.700	5.724
UL	8.000	8.000	8.000	8.000	8.000	8.000	8.000

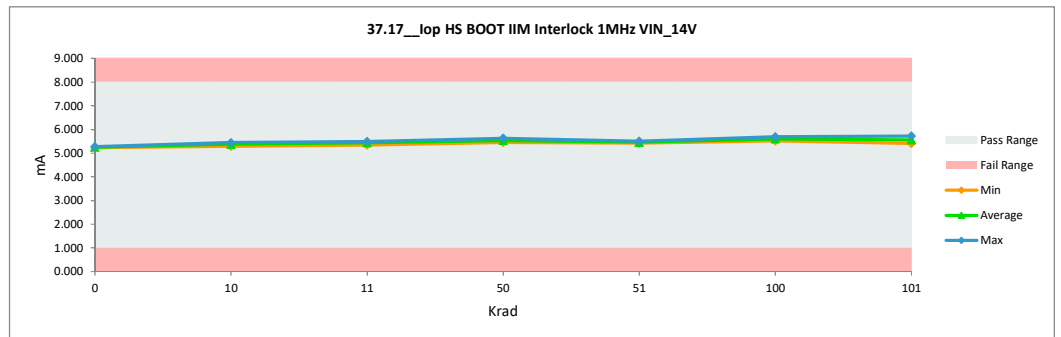

TID "HDR" Report
5962R2220102VXC

37.18_Iop LS VIN IIM Interlock

Test Site	DAL	DAL
Tester	ETS364	ETS364
Test Number	EB672303	EB672303
Unit	mA	mA
Max Limit	17	17
Min Limit	1	1

Krad	Serial #	Pre_HDR_6013	Post_HDR_6013	Delta
0	1	10.427	10.365	-0.062
0	2	10.144	10.097	-0.048
10	182	10.043	10.053	0.010
10	202	10.139	10.197	0.058
10	204	10.381	10.175	-0.206
11	418	10.388	10.336	-0.052
11	419	10.299	10.264	-0.036
11	443	10.181	10.230	0.049
50	259	10.237	10.450	0.213
50	346	10.299	10.471	0.172
50	347	10.118	10.288	0.170
51	462	10.211	10.354	0.144
51	478	10.340	10.239	-0.102
51	503	10.230	10.481	0.252
100	354	10.352	10.745	0.393
100	363	10.253	10.713	0.460
100	366	10.390	10.740	0.350
100	383	10.185	10.833	0.648
100	417	10.218	10.653	0.435
101	513	10.242	10.571	0.329
101	526	10.176	10.550	0.374
101	532	10.246	10.597	0.351
101	533	10.134	10.544	0.410
101	534	10.278	10.652	0.374
Max		10.427	10.833	0.648
Average		10.246	10.442	0.195
Min		10.043	10.053	-0.206
Std Dev		0.099	0.222	0.221

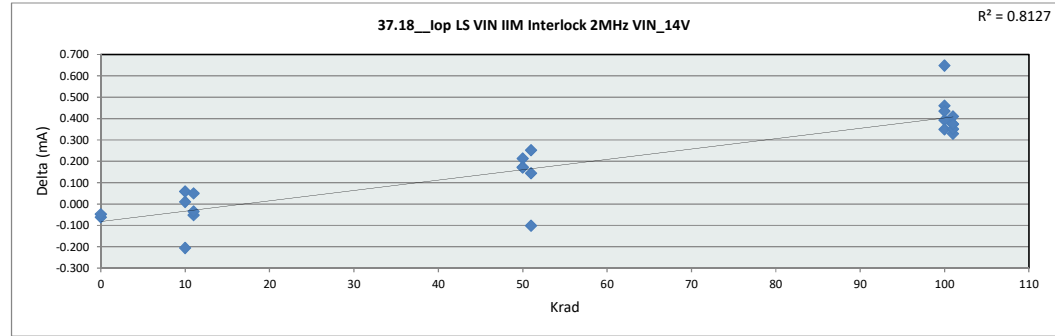

37.18_Iop LS VIN IIM Interlo

Test Site	DAL
Tester	ETS364
Test Number	EB672303
Max Limit	17 mA
Min Limit	1 mA

Krad	0	10	11	50	51	100	101
LL	1.000	1.000	1.000	1.000	1.000	1.000	1.000
Min	10.097	10.053	10.230	10.288	10.239	10.653	10.544
Average	10.231	10.142	10.277	10.403	10.358	10.737	10.583
Max	10.365	10.197	10.336	10.471	10.481	10.833	10.652
UL	17.000	17.000	17.000	17.000	17.000	17.000	17.000

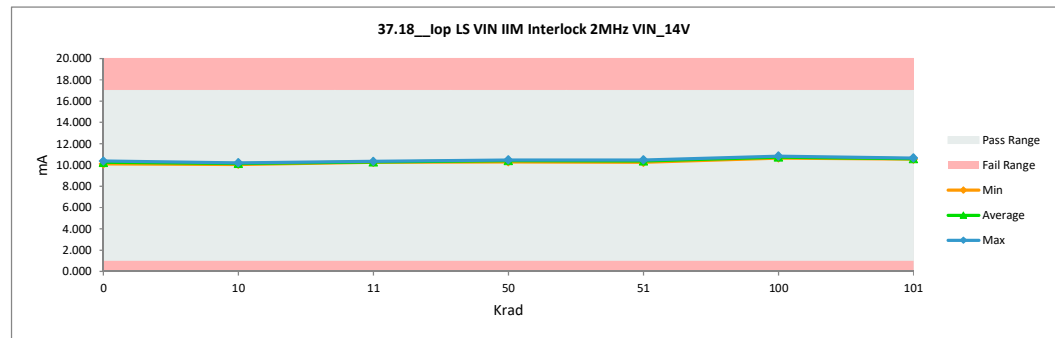

TID "HDR" Report
5962R2220102VXC

37.19_Iop HS BOOT IIM Interlock		
Test Site	DAL	DAL
Tester	ETS364	ETS364
Test Number	EB672303	EB672303
Unit	mA	mA
Max Limit	10.5	10.5
Min Limit	1	1

Krad	Serial #	Pre_HDR_6013	Post_HDR_6013	Delta
0	1	6.975	6.918	-0.057
0	2	6.926	6.884	-0.042
10	182	6.946	6.931	-0.015
10	202	7.028	7.054	0.026
10	204	7.095	7.097	0.002
11	418	6.859	7.158	0.299
11	419	7.132	7.117	-0.015
11	443	6.911	6.999	0.088
50	259	6.963	7.091	0.128
50	346	7.120	7.273	0.152
50	347	6.987	7.161	0.174
51	462	7.150	7.157	0.007
51	478	6.953	7.105	0.152
51	503	6.914	7.077	0.164
100	354	7.022	7.337	0.315
100	363	7.038	7.348	0.309
100	366	6.929	7.158	0.229
100	383	6.895	7.243	0.348
100	417	6.983	7.169	0.187
101	513	7.101	7.363	0.262
101	526	6.821	7.057	0.236
101	532	7.083	7.270	0.188
101	533	6.941	7.181	0.240
101	534	6.959	7.144	0.185
	Max	7.150	7.363	0.348
	Average	6.989	7.137	0.148
	Min	6.821	6.884	-0.057
	Std Dev	0.089	0.129	0.123

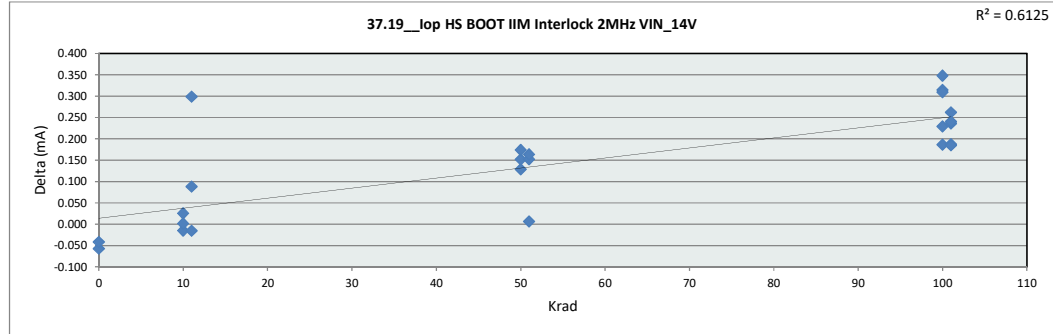

37.19_Iop HS BOOT IIM Interlock		
Test Site	DAL	
Tester	ETS364	
Test Number	EB672303	
Max Limit	10.5	mA
Min Limit	1	mA

Krad	0	10	11	50	51	100	101
LL	1.000	1.000	1.000	1.000	1.000	1.000	1.000
Min	6.884	6.931	6.999	7.091	7.078	7.158	7.057
Average	6.901	7.027	7.091	7.175	7.113	7.251	7.203
Max	6.918	7.097	7.158	7.273	7.157	7.348	7.363
UL	10.500	10.500	10.500	10.500	10.500	10.500	10.500

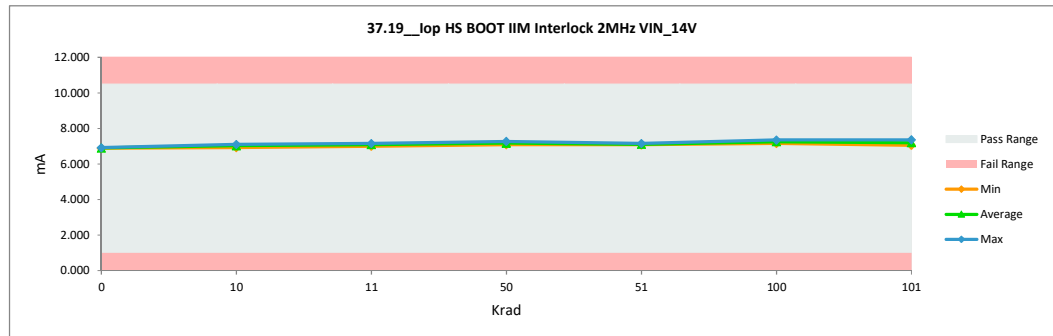

TID "HDR" Report
5962R2220102VXC

37.20_Iop LS VIN IIM Interlock		
Test Site	DAL	DAL
Tester	ETS364	ETS364
Test Number	EB672303	EB672303
Unit	mA	mA
Max Limit	30	30
Min Limit	1	1

Krad	Serial #	Pre_HDR_6013	Post_HDR_6013	Delta
0	1	19.537	19.496	-0.041
0	2	19.204	19.192	-0.012
10	182	19.066	19.111	0.045
10	202	19.168	19.289	0.120
10	204	19.489	19.321	-0.169
11	418	19.481	19.479	-0.003
11	419	19.351	19.391	0.040
11	443	19.212	19.259	0.047
50	259	19.261	19.635	0.374
50	346	19.359	19.663	0.304
50	347	19.212	19.521	0.308
51	462	19.268	19.619	0.351
51	478	19.373	19.424	0.051
51	503	19.332	19.705	0.373
100	354	19.470	20.098	0.628
100	363	19.316	20.026	0.710
100	366	19.462	20.004	0.543
100	383	19.235	20.146	0.911
100	417	19.234	20.020	0.786
101	513	19.343	19.865	0.522
101	526	19.293	19.860	0.567
101	532	19.365	19.922	0.557
101	533	19.196	19.869	0.673
101	534	19.370	19.910	0.539
	Max	19.537	20.146	0.911
	Average	19.317	19.659	0.343
	Min	19.066	19.111	-0.169
	Std Dev	0.117	0.310	0.303

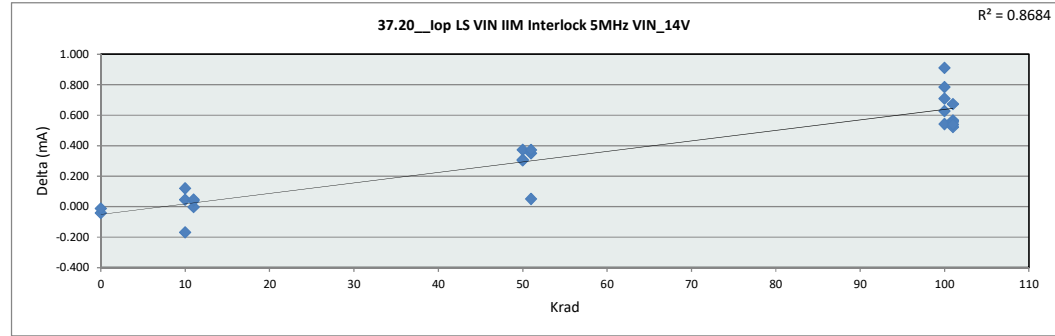

37.20_Iop LS VIN IIM Interlo		
Test Site	DAL	
Tester	ETS364	
Test Number	EB672303	
Max Limit	30	mA
Min Limit	1	mA

	0	10	11	50	51	100	101
LL	1.000	1.000	1.000	1.000	1.000	1.000	1.000
Min	19.192	19.111	19.259	19.521	19.424	20.005	19.860
Average	19.344	19.240	19.376	19.606	19.583	20.059	19.885
Max	19.496	19.321	19.479	19.663	19.705	20.146	19.922
UL	30.000	30.000	30.000	30.000	30.000	30.000	30.000

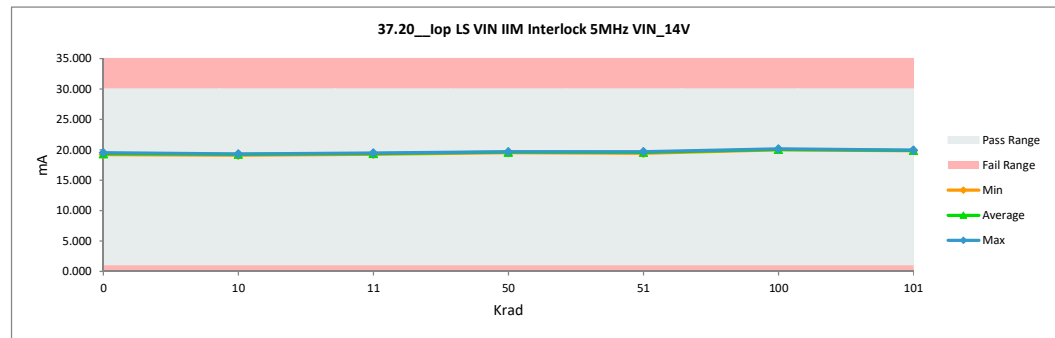

TID "HDR" Report
5962R2220102VXC

37.21_Iop HS BOOT IIM Interlock		
Test Site	DAL	DAL
Tester	ETS364	ETS364
Test Number	EB672303	EB672303
Unit	mA	mA
Max Limit	15	15
Min Limit	1	1

Krad	Serial #	Pre_HDR_6013	Post_HDR_6013	Delta
0	1	11.604	11.548	-0.056
0	2	11.631	11.590	-0.042
10	182	11.615	11.588	-0.027
10	202	11.715	11.745	0.030
10	204	11.777	11.771	-0.006
11	418	11.500	11.843	0.343
11	419	11.811	11.773	-0.037
11	443	11.552	11.683	0.131
50	259	11.577	11.699	0.122
50	346	11.737	11.887	0.149
50	347	11.658	11.822	0.164
51	462	11.825	11.847	0.022
51	478	11.606	11.776	0.170
51	503	11.605	11.770	0.165
100	354	11.693	12.008	0.314
100	363	11.686	12.005	0.319
100	366	11.554	11.787	0.233
100	383	11.607	11.927	0.321
100	417	11.633	11.829	0.196
101	513	11.726	12.017	0.291
101	526	11.489	11.742	0.253
101	532	11.774	11.959	0.185
101	533	11.577	11.838	0.261
101	534	11.604	11.800	0.196
	Max	11.825	12.017	0.343
	Average	11.648	11.802	0.154
	Min	11.489	11.548	-0.056
	Std Dev	0.093	0.128	0.128

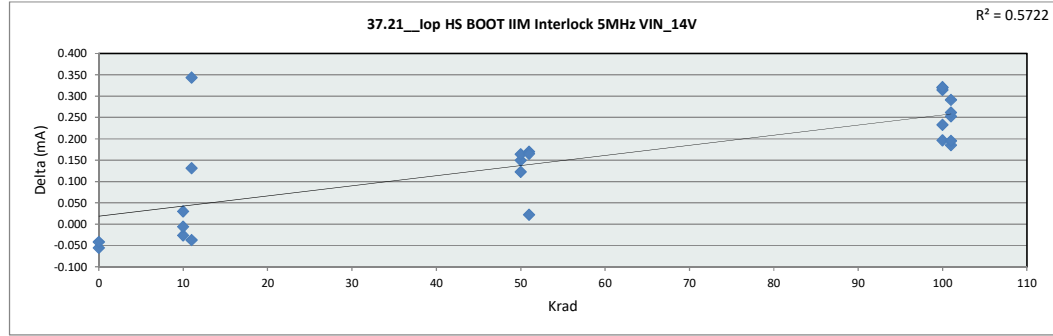

37.21_Iop HS BOOT IIM Interlock		
Test Site	DAL	
Tester	ETS364	
Test Number	EB672303	
Max Limit	15	mA
Min Limit	1	mA

Krad	0	10	11	50	51	100	101
LL	1.000	1.000	1.000	1.000	1.000	1.000	1.000
Min	11.548	11.588	11.683	11.699	11.770	11.787	11.742
Average	11.569	11.701	11.767	11.803	11.798	11.911	11.871
Max	11.590	11.771	11.843	11.887	11.847	12.008	12.017
UL	15.000	15.000	15.000	15.000	15.000	15.000	15.000

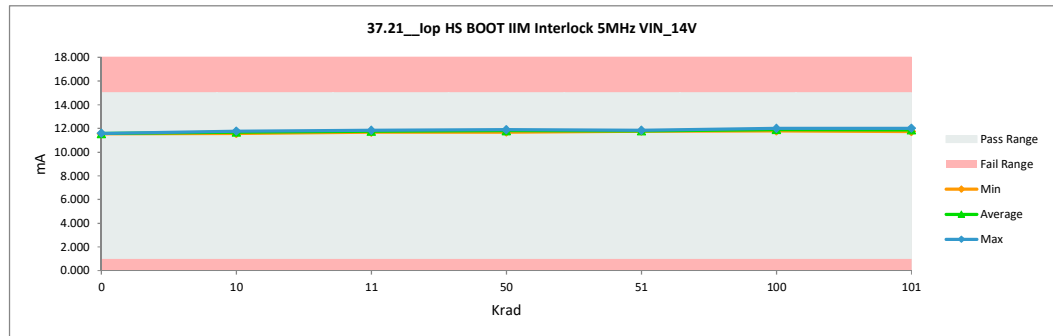

TID "HDR" Report
5962R2220102VXC

45.0 VOL LO VIN_10V		
Test Site	DAL	DAL
Tester	ETS364	ETS364
Test Number	EB672303	EB672303
Unit	V	V
Max Limit	0.15	0.15
Min Limit	0	0

Krad	Serial #	Pre_HDR_6013	Post_HDR_6013	Delta
0	1	0.069	0.067	-0.001
0	2	0.067	0.066	-0.001
10	182	0.067	0.065	-0.002
10	202	0.068	0.067	-0.001
10	204	0.068	0.065	-0.002
11	418	0.068	0.068	0.000
11	419	0.068	0.067	-0.001
11	443	0.068	0.070	0.002
50	259	0.068	0.066	-0.002
50	346	0.069	0.067	-0.002
50	347	0.068	0.067	-0.002
51	462	0.068	0.066	-0.002
51	478	0.068	0.066	-0.002
51	503	0.067	0.066	-0.001
100	354	0.068	0.066	-0.002
100	363	0.067	0.066	-0.001
100	366	0.068	0.066	-0.002
100	383	0.068	0.067	-0.001
100	417	0.068	0.067	-0.001
101	513	0.068	0.067	-0.002
101	526	0.067	0.065	-0.002
101	532	0.068	0.066	-0.002
101	533	0.069	0.067	-0.002
101	534	0.070	0.068	-0.002
Max		0.070	0.070	0.002
Average		0.068	0.067	-0.001
Min		0.067	0.065	-0.002
Std Dev		0.001	0.001	0.001

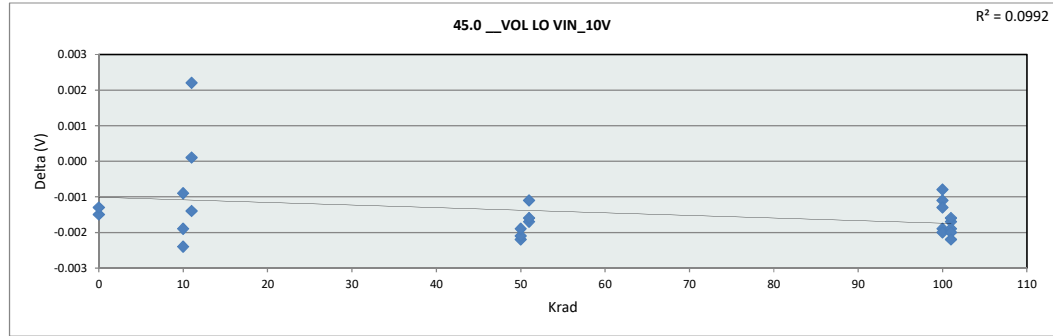

45.0 VOL LO VIN_10V		
Test Site	DAL	
Tester	ETS364	
Test Number	EB672303	
Max Limit	0.15	V
Min Limit	0	V

Krad	0	10	11	50	51	100	101
LL	0.000	0.000	0.000	0.000	0.000	0.000	0.000
Min	0.066	0.065	0.067	0.066	0.066	0.066	0.065
Average	0.067	0.066	0.068	0.067	0.066	0.066	0.066
Max	0.067	0.067	0.070	0.067	0.066	0.067	0.068
UL	0.150	0.150	0.150	0.150	0.150	0.150	0.150

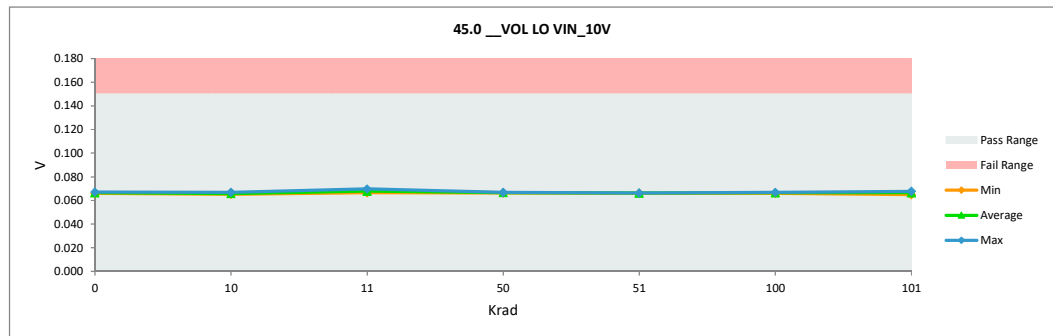

TID "HDR" Report
5962R2220102VXC

45.2_VOH Delta LO VIN_10V		
Test Site	DAL	DAL
Tester	ETS364	ETS364
Test Number	EB672303	EB672303
Unit	V	V
Max Limit	0.3	0.3
Min Limit	0	0

Krad	Serial #	Pre_HDR_6013	Post_HDR_6013	Delta
0	1	0.127	0.125	-0.002
0	2	0.126	0.124	-0.001
10	182	0.123	0.121	-0.002
10	202	0.125	0.125	0.000
10	204	0.126	0.124	-0.002
11	418	0.126	0.129	0.002
11	419	0.127	0.125	-0.002
11	443	0.126	0.128	0.002
50	259	0.126	0.126	0.000
50	346	0.126	0.125	-0.001
50	347	0.126	0.126	0.000
51	462	0.127	0.129	0.001
51	478	0.127	0.124	-0.003
51	503	0.128	0.128	0.001
100	354	0.127	0.127	0.001
100	363	0.126	0.126	-0.001
100	366	0.127	0.127	0.000
100	383	0.126	0.127	0.001
100	417	0.127	0.128	0.001
101	513	0.125	0.128	0.003
101	526	0.124	0.127	0.002
101	532	0.127	0.129	0.002
101	533	0.126	0.127	0.001
101	534	0.126	0.127	0.002
Max		0.128	0.129	0.003
Average		0.126	0.126	0.000
Min		0.123	0.121	-0.003
Std Dev		0.001	0.002	0.002

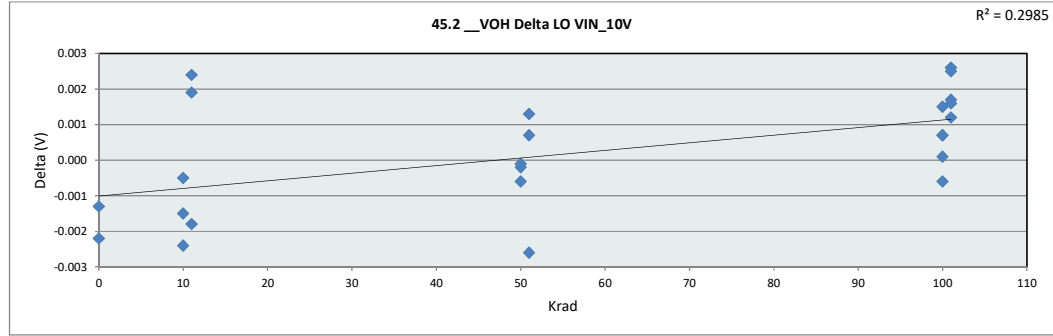

45.2_VOH Delta LO VIN_10V		
Test Site	DAL	
Tester	ETS364	
Test Number	EB672303	
Max Limit	0.3	V
Min Limit	0	V

Krad	0	10	11	50	51	100	101
LL	0.000	0.000	0.000	0.000	0.000	0.000	0.000
Min	0.124	0.121	0.125	0.125	0.124	0.126	0.127
Average	0.125	0.123	0.127	0.126	0.127	0.127	0.128
Max	0.125	0.125	0.129	0.126	0.129	0.128	0.129
UL	0.300	0.300	0.300	0.300	0.300	0.300	0.300

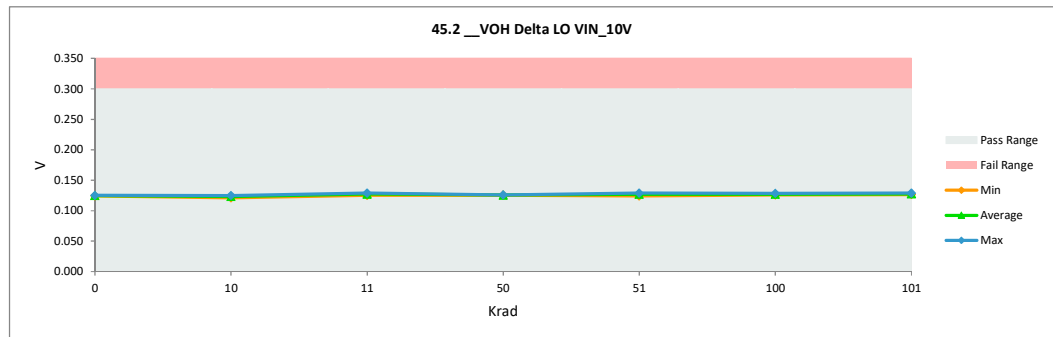

TID "HDR" Report
5962R2220102VXC

46.0 VOL LO VIN_12V		
Test Site	DAL	DAL
Tester	ETS364	ETS364
Test Number	EB672303	EB672303
Unit	V	V
Max Limit	0.15	0.15
Min Limit	0	0

Krad	Serial #	Pre_HDR_6013	Post_HDR_6013	Delta
0	1	0.069	0.067	-0.001
0	2	0.067	0.066	-0.001
10	182	0.067	0.065	-0.002
10	202	0.068	0.067	-0.001
10	204	0.068	0.065	-0.003
11	418	0.068	0.068	0.000
11	419	0.068	0.066	-0.001
11	443	0.068	0.070	0.002
50	259	0.068	0.066	-0.002
50	346	0.069	0.067	-0.002
50	347	0.068	0.066	-0.002
51	462	0.068	0.066	-0.002
51	478	0.068	0.066	-0.002
51	503	0.067	0.066	-0.001
100	354	0.068	0.066	-0.002
100	363	0.067	0.066	-0.001
100	366	0.068	0.066	-0.002
100	383	0.068	0.067	-0.001
100	417	0.068	0.067	-0.001
101	513	0.068	0.066	-0.002
101	526	0.067	0.065	-0.002
101	532	0.068	0.066	-0.002
101	533	0.069	0.067	-0.002
101	534	0.070	0.068	-0.002
Max		0.070	0.070	0.002
Average		0.068	0.066	-0.001
Min		0.067	0.065	-0.003
Std Dev		0.001	0.001	0.001

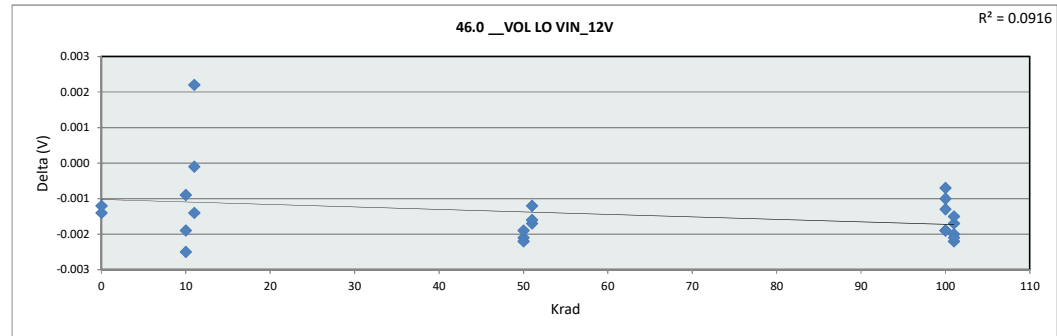

46.0 VOL LO VIN_12V		
Test Site	DAL	
Tester	ETS364	
Test Number	EB672303	
Max Limit	0.15	V
Min Limit	0	V

Krad	0	10	11	50	51	100	101
LL	0.000	0.000	0.000	0.000	0.000	0.000	0.000
Min	0.066	0.065	0.066	0.066	0.066	0.066	0.065
Average	0.067	0.066	0.068	0.066	0.066	0.066	0.066
Max	0.067	0.067	0.070	0.067	0.066	0.067	0.068
UL	0.150	0.150	0.150	0.150	0.150	0.150	0.150

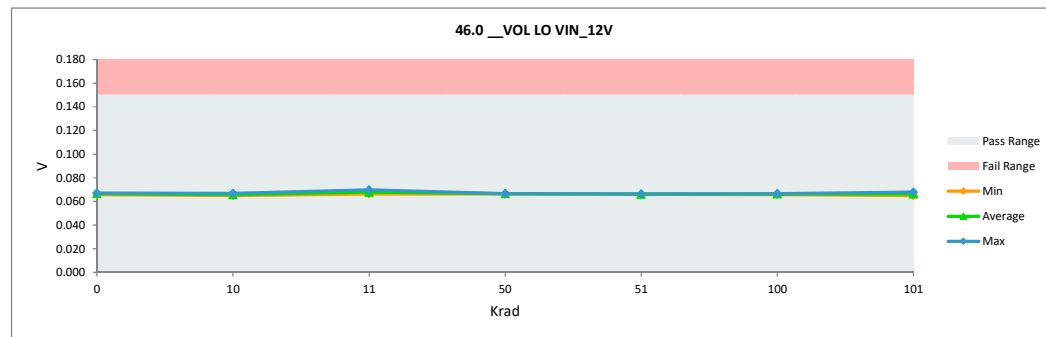

TID "HDR" Report
5962R2220102VXC

46.2_VOH Delta LO VIN_12V		
Test Site	DAL	DAL
Tester	ETS364	ETS364
Test Number	EB672303	EB672303
Unit	V	V
Max Limit	0.3	0.3
Min Limit	0	0

Krad	Serial #	Pre_HDR_6013	Post_HDR_6013	Delta
0	1	0.127	0.125	-0.002
0	2	0.125	0.124	-0.001
10	182	0.123	0.121	-0.002
10	202	0.125	0.125	0.000
10	204	0.126	0.124	-0.002
11	418	0.126	0.128	0.002
11	419	0.127	0.125	-0.002
11	443	0.126	0.128	0.002
50	259	0.126	0.126	0.000
50	346	0.126	0.125	-0.001
50	347	0.126	0.126	0.000
51	462	0.127	0.129	0.001
51	478	0.127	0.124	-0.003
51	503	0.127	0.128	0.001
100	354	0.127	0.127	0.000
100	363	0.126	0.125	-0.001
100	366	0.127	0.127	0.000
100	383	0.126	0.126	0.000
100	417	0.127	0.128	0.001
101	513	0.125	0.128	0.002
101	526	0.124	0.127	0.002
101	532	0.127	0.129	0.002
101	533	0.125	0.127	0.001
101	534	0.126	0.127	0.002
Max		0.127	0.129	0.002
Average		0.126	0.126	0.000
Min		0.123	0.121	-0.003
Std Dev		0.001	0.002	0.002

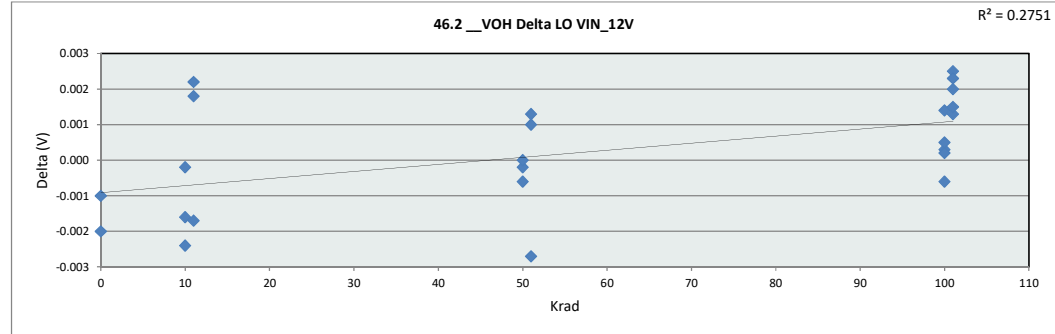

46.2_VOH Delta LO VIN_12V							
Test Site	DAL						
Tester	ETS364						
Test Number	EB672303						
Max Limit	0.3 V						
Min Limit	0 V						
Krad	0	10	11	50	51	100	101
LL	0.000	0.000	0.000	0.000	0.000	0.000	0.000
Min	0.124	0.121	0.125	0.125	0.124	0.126	0.127
Average	0.125	0.123	0.127	0.126	0.127	0.127	0.127
Max	0.125	0.125	0.128	0.126	0.129	0.129	0.129
UL	0.300	0.300	0.300	0.300	0.300	0.300	0.300

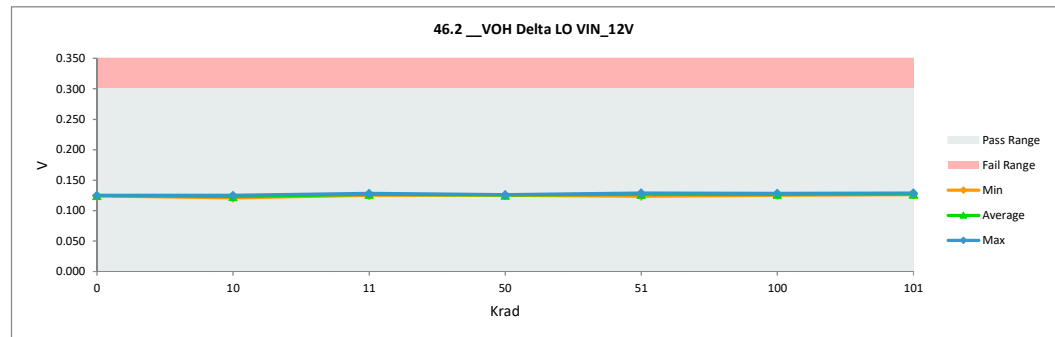

TID "HDR" Report
5962R2220102VXC

47.0 VOL LO VIN_14V		
Test Site	DAL	DAL
Tester	ETS364	ETS364
Test Number	EB672303	EB672303
Unit	V	V
Max Limit	0.15	0.15
Min Limit	0	0

Krad	Serial #	Pre_HDR_6013	Post_HDR_6013	Delta
0	1	0.069	0.067	-0.001
0	2	0.067	0.066	-0.001
10	182	0.067	0.065	-0.002
10	202	0.068	0.067	-0.001
10	204	0.068	0.065	-0.003
11	418	0.068	0.068	0.000
11	419	0.068	0.066	-0.001
11	443	0.067	0.070	0.002
50	259	0.068	0.066	-0.002
50	346	0.069	0.067	-0.002
50	347	0.068	0.066	-0.002
51	462	0.068	0.066	-0.002
51	478	0.068	0.066	-0.002
51	503	0.067	0.066	-0.001
100	354	0.068	0.066	-0.002
100	363	0.067	0.066	-0.001
100	366	0.068	0.066	-0.002
100	383	0.068	0.067	-0.001
100	417	0.068	0.067	-0.001
101	513	0.068	0.066	-0.002
101	526	0.067	0.065	-0.002
101	532	0.068	0.066	-0.002
101	533	0.069	0.067	-0.002
101	534	0.070	0.068	-0.002
Max		0.070	0.070	0.002
Average		0.068	0.066	-0.001
Min		0.067	0.065	-0.003
Std Dev		0.001	0.001	0.001

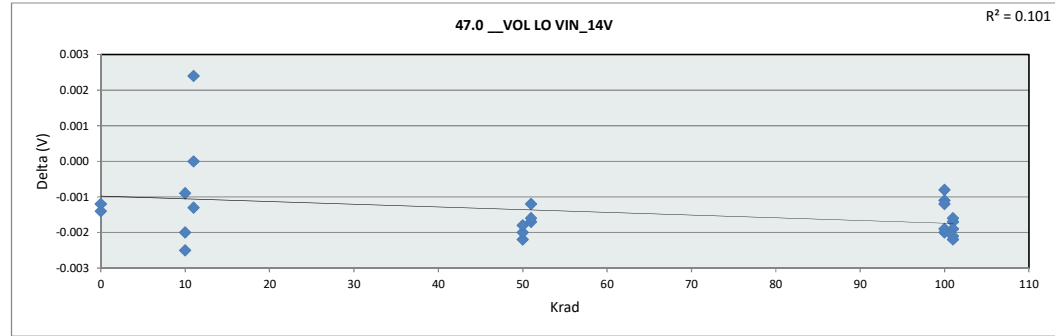

47.0 VOL LO VIN_14V		
Test Site	DAL	
Tester	ETS364	
Test Number	EB672303	
Max Limit	0.15	V
Min Limit	0	V

Krad	0	10	11	50	51	100	101
LL	0.000	0.000	0.000	0.000	0.000	0.000	0.000
Min	0.066	0.065	0.066	0.066	0.066	0.066	0.065
Average	0.067	0.066	0.068	0.067	0.066	0.066	0.066
Max	0.067	0.067	0.070	0.067	0.066	0.067	0.068
UL	0.150	0.150	0.150	0.150	0.150	0.150	0.150

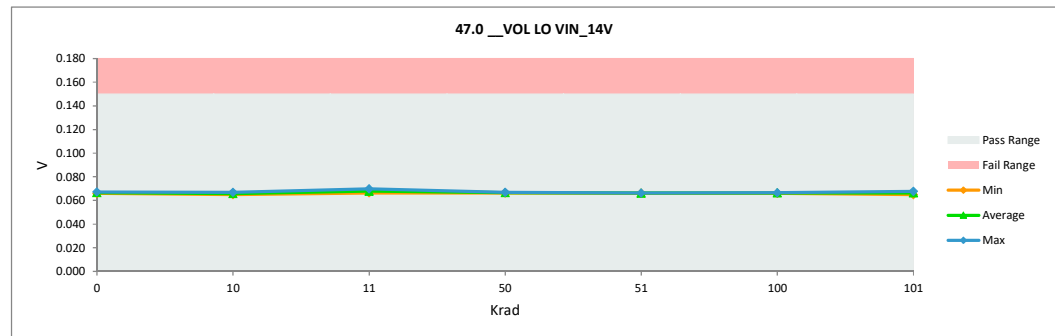

TID "HDR" Report
5962R2220102VXC

47.2_VOH Delta LO VIN_14V		
Test Site	DAL	DAL
Tester	ETS364	ETS364
Test Number	EB672303	EB672303
Unit	V	V
Max Limit	0.3	0.3
Min Limit	0	0

Krad	Serial #	Pre_HDR_6013	Post_HDR_6013	Delta
0	1	0.127	0.125	-0.002
0	2	0.125	0.124	-0.001
10	182	0.122	0.121	-0.001
10	202	0.125	0.125	0.000
10	204	0.126	0.124	-0.002
11	418	0.126	0.128	0.002
11	419	0.127	0.125	-0.002
11	443	0.126	0.128	0.002
50	259	0.126	0.125	0.000
50	346	0.126	0.125	0.000
50	347	0.126	0.126	0.000
51	462	0.127	0.129	0.001
51	478	0.127	0.124	-0.003
51	503	0.128	0.128	0.001
100	354	0.127	0.127	0.001
100	363	0.126	0.126	-0.001
100	366	0.127	0.127	0.000
100	383	0.126	0.127	0.001
100	417	0.127	0.128	0.001
101	513	0.126	0.128	0.002
101	526	0.124	0.127	0.002
101	532	0.127	0.129	0.002
101	533	0.126	0.127	0.001
101	534	0.126	0.127	0.002
Max		0.128	0.129	0.002
Average		0.126	0.126	0.000
Min		0.122	0.121	-0.003
Std Dev		0.001	0.002	0.002

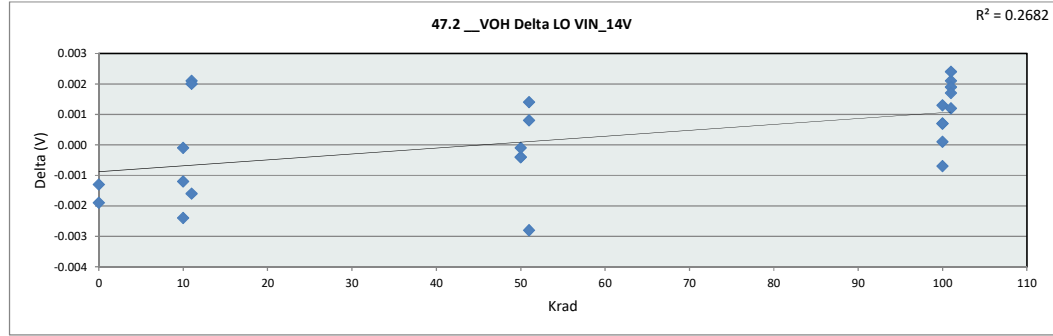

47.2_VOH Delta LO VIN_14V		
Test Site	DAL	
Tester	ETS364	
Test Number	EB672303	
Max Limit	0.3	V
Min Limit	0	V

Krad	0	10	11	50	51	100	101
LL	0.000	0.000	0.000	0.000	0.000	0.000	0.000
Min	0.124	0.121	0.125	0.125	0.124	0.126	0.127
Average	0.125	0.123	0.127	0.126	0.127	0.127	0.127
Max	0.125	0.125	0.128	0.126	0.129	0.128	0.129
UL	0.300	0.300	0.300	0.300	0.300	0.300	0.300

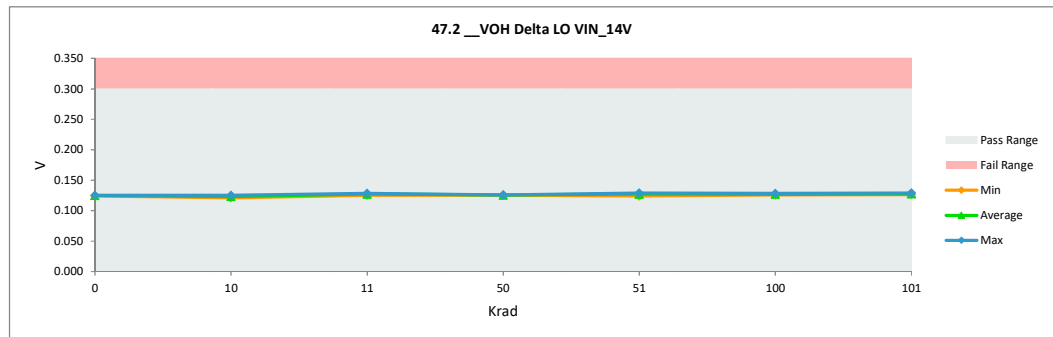

TID "HDR" Report
5962R2220102VXC

50.0 IOH LO VIN_10V		
Test Site	DAL	DAL
Tester	ETS364	ETS364
Test Number	EB672303	EB672303
Unit	A	A
Max Limit	2.3	2.3
Min Limit	0.7	0.7

Krad	Serial #	Pre_HDR_6013	Post_HDR_6013	Delta
0	1	1.267	1.279	0.012
0	2	1.283	1.291	0.009
10	182	1.322	1.328	0.006
10	202	1.291	1.289	-0.002
10	204	1.284	1.290	0.006
11	418	1.278	1.254	-0.023
11	419	1.274	1.285	0.011
11	443	1.287	1.276	-0.011
50	259	1.281	1.276	-0.006
50	346	1.290	1.286	-0.004
50	347	1.278	1.272	-0.007
51	462	1.277	1.242	-0.034
51	478	1.278	1.300	0.022
51	503	1.268	1.252	-0.017
100	354	1.272	1.256	-0.016
100	363	1.283	1.273	-0.010
100	366	1.277	1.262	-0.015
100	383	1.281	1.272	-0.009
100	417	1.280	1.250	-0.030
101	513	1.281	1.249	-0.032
101	526	1.294	1.263	-0.031
101	532	1.268	1.239	-0.028
101	533	1.291	1.263	-0.027
101	534	1.291	1.265	-0.026
Max		1.322	1.328	0.022
Average		1.282	1.271	-0.011
Min		1.267	1.239	-0.034
Std Dev		0.011	0.020	0.016

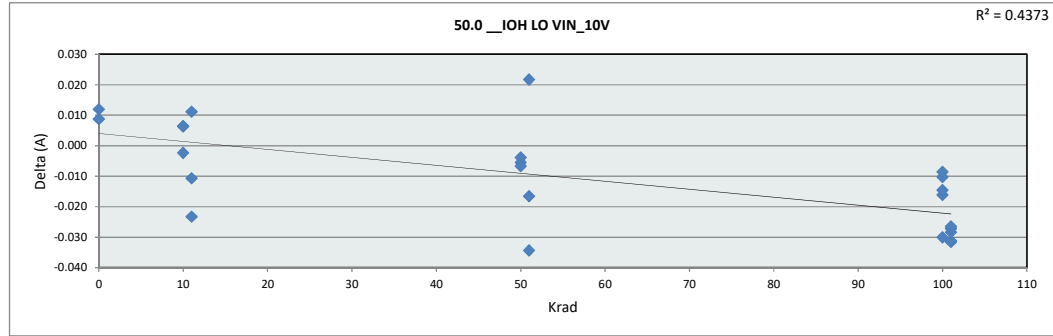

50.0 IOH LO VIN_10V		
Test Site	DAL	
Tester	ETS364	
Test Number	EB672303	
Max Limit	2.3	A
Min Limit	0.7	A

Krad	0	10	11	50	51	100	101
LL	0.700	0.700	0.700	0.700	0.700	0.700	0.700
Min	1.279	1.289	1.254	1.272	1.242	1.250	1.239
Average	1.285	1.302	1.272	1.278	1.265	1.263	1.256
Max	1.291	1.328	1.285	1.286	1.300	1.273	1.265
UL	2.300	2.300	2.300	2.300	2.300	2.300	2.300

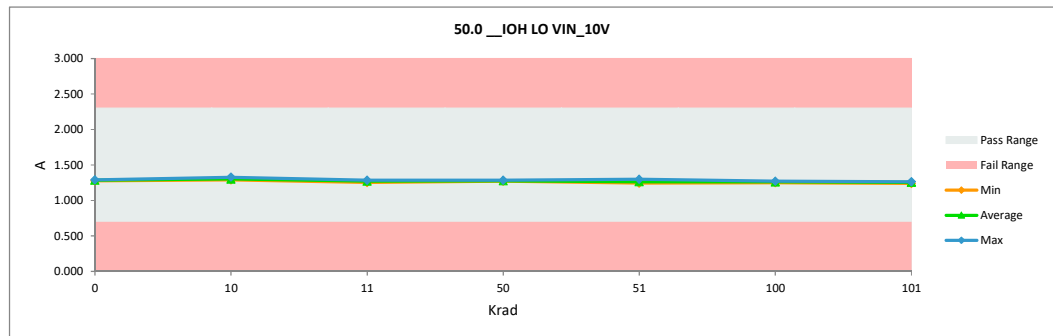

TID "HDR" Report
5962R2220102VXC

50.1 IOH HO VIN_10V		
Test Site	DAL	
Tester	ETS364	
Test Number	EB672303	EB672303
Unit	A	
Max Limit	2.3	
Min Limit	0.7	

Krad	Serial #	Pre_HDR_6013	Post_HDR_6013	Delta
0	1	1.275	1.288	0.013
0	2	1.280	1.289	0.009
10	182	1.303	1.307	0.005
10	202	1.291	1.288	-0.003
10	204	1.281	1.288	0.008
11	418	1.277	1.253	-0.024
11	419	1.275	1.286	0.012
11	443	1.293	1.270	-0.024
50	259	1.278	1.264	-0.013
50	346	1.299	1.286	-0.012
50	347	1.281	1.266	-0.015
51	462	1.279	1.241	-0.039
51	478	1.281	1.292	0.011
51	503	1.267	1.250	-0.016
100	354	1.262	1.231	-0.031
100	363	1.285	1.262	-0.024
100	366	1.278	1.249	-0.029
100	383	1.278	1.253	-0.026
100	417	1.287	1.240	-0.047
101	513	1.288	1.257	-0.030
101	526	1.291	1.260	-0.031
101	532	1.269	1.242	-0.027
101	533	1.288	1.261	-0.026
101	534	1.294	1.267	-0.027
Max		1.303	1.307	0.013
Average		1.282	1.266	-0.016
Min		1.262	1.231	-0.047
Std Dev		0.010	0.020	0.018

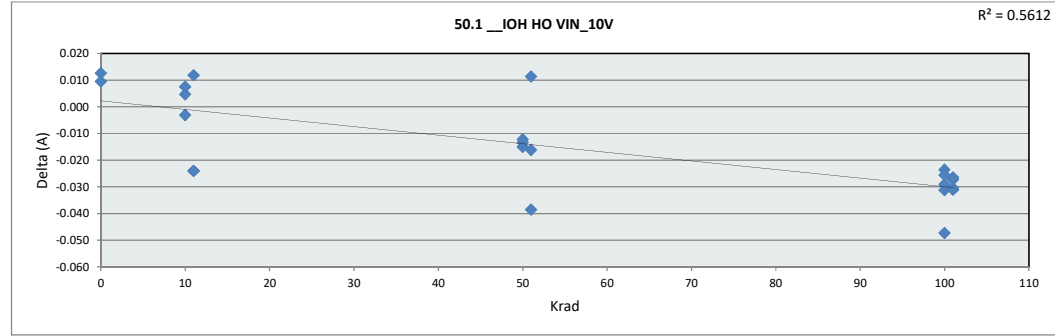

50.1 IOH HO VIN_10V		
Test Site	DAL	
Tester	ETS364	
Test Number	EB672303	
Max Limit	2.3	
Min Limit	0.7	

Krad	0	10	11	50	51	100	101
LL	0.700	0.700	0.700	0.700	0.700	0.700	0.700
Min	1.288	1.288	1.253	1.264	1.241	1.231	1.242
Average	1.288	1.295	1.270	1.272	1.261	1.247	1.257
Max	1.289	1.307	1.286	1.286	1.292	1.262	1.267
UL	2.300	2.300	2.300	2.300	2.300	2.300	2.300

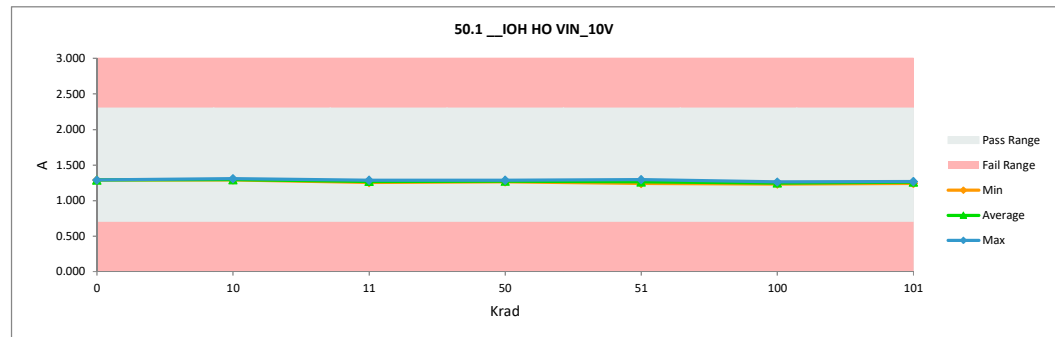

TID "HDR" Report
5962R2220102VXC

50.2_IOL LO VIN_10V		
Test Site	DAL	
Tester	ETS364	
Test Number	EB672303	
Unit	A	
Max Limit	4.6	
Min Limit	1.6	

Krad	Serial #	Pre_HDR_6013	Post_HDR_6013	Delta
0	1	2.529	2.557	0.029
0	2	2.574	2.599	0.024
10	182	2.568	2.609	0.041
10	202	2.551	2.569	0.018
10	204	2.553	2.603	0.050
11	418	2.561	2.534	-0.026
11	419	2.556	2.573	0.017
11	443	2.555	2.534	-0.021
50	259	2.534	2.601	0.067
50	346	2.551	2.624	0.072
50	347	2.543	2.607	0.064
51	462	2.562	2.611	0.050
51	478	2.549	2.624	0.075
51	503	2.549	2.602	0.053
100	354	2.551	2.645	0.095
100	363	2.572	2.627	0.055
100	366	2.539	2.628	0.088
100	383	2.542	2.654	0.112
100	417	2.547	2.632	0.085
101	513	2.546	2.642	0.096
101	526	2.561	2.655	0.093
101	532	2.553	2.650	0.097
101	533	2.539	2.635	0.096
101	534	2.517	2.612	0.095
Max		2.574	2.655	0.112
Average		2.550	2.610	0.059
Min		2.517	2.534	-0.026
Std Dev		0.013	0.035	0.038

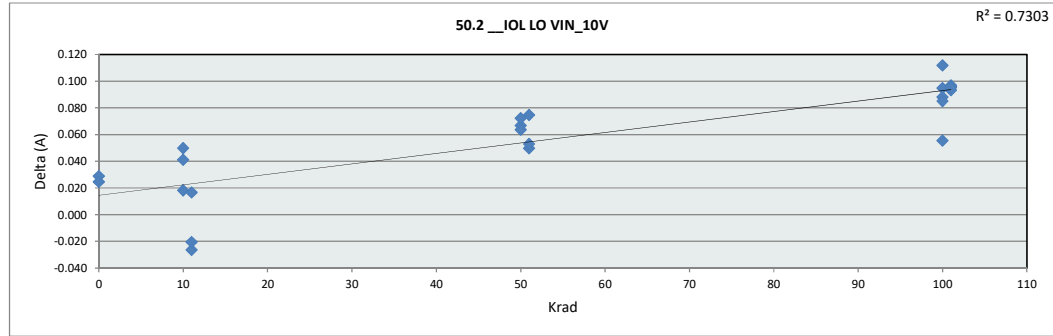

50.2_IOL LO VIN_10V		
Test Site	DAL	
Tester	ETS364	
Test Number	EB672303	
Max Limit	4.6	
Min Limit	1.6	

Krad	0	10	11	50	51	100	101
LL	1.600	1.600	1.600	1.600	1.600	1.600	1.600
Min	2.557	2.569	2.534	2.601	2.602	2.627	2.612
Average	2.578	2.594	2.547	2.611	2.613	2.637	2.639
Max	2.599	2.610	2.573	2.624	2.624	2.654	2.655
UL	4.600	4.600	4.600	4.600	4.600	4.600	4.600

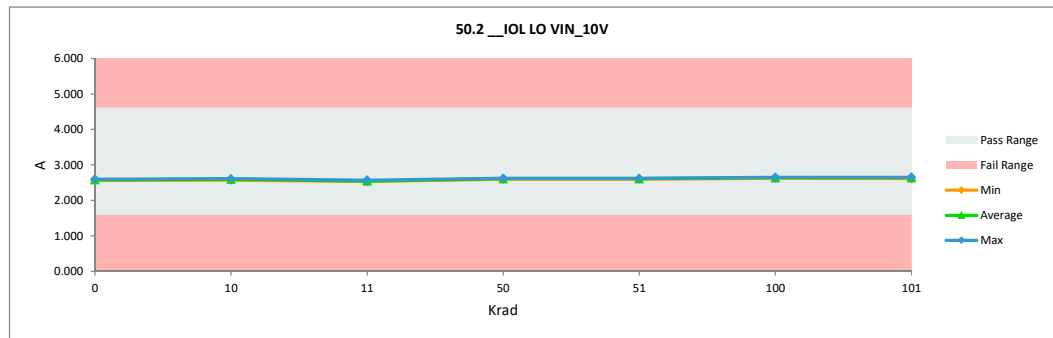

TID "HDR" Report
5962R2220102VXC

51.0 IOH LO VIN_12V		
Test Site	DAL	
Tester	ETS364	
Test Number	EB672303	EB672303
Unit	A	
Max Limit	2.3	
Min Limit	0.7	

Krad	Serial #	Pre_HDR_6013	Post_HDR_6013	Delta
0	1	1.267	1.279	0.012
0	2	1.283	1.291	0.009
10	182	1.322	1.328	0.006
10	202	1.291	1.289	-0.002
10	204	1.284	1.290	0.006
11	418	1.278	1.254	-0.023
11	419	1.274	1.285	0.011
11	443	1.286	1.276	-0.010
50	259	1.281	1.276	-0.006
50	346	1.290	1.286	-0.004
50	347	1.278	1.272	-0.006
51	462	1.277	1.242	-0.034
51	478	1.278	1.300	0.022
51	503	1.268	1.252	-0.016
100	354	1.272	1.256	-0.016
100	363	1.283	1.273	-0.010
100	366	1.277	1.262	-0.015
100	383	1.280	1.271	-0.009
100	417	1.279	1.250	-0.030
101	513	1.281	1.250	-0.031
101	526	1.293	1.263	-0.031
101	532	1.268	1.239	-0.028
101	533	1.290	1.263	-0.027
101	534	1.291	1.265	-0.026
Max		1.322	1.328	0.022
Average		1.282	1.271	-0.011
Min		1.267	1.239	-0.034
Std Dev		0.011	0.020	0.016

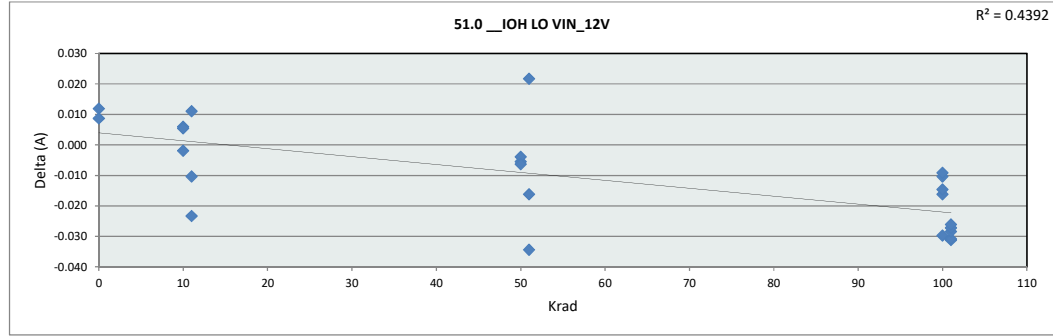

51.0 IOH LO VIN_12V		
Test Site	DAL	
Tester	ETS364	
Test Number	EB672303	
Max Limit	2.3	
Min Limit	0.7	

Krad	0	10	11	50	51	100	101
LL	0.700	0.700	0.700	0.700	0.700	0.700	0.700
Min	1.279	1.289	1.254	1.272	1.242	1.250	1.239
Average	1.285	1.302	1.272	1.278	1.265	1.262	1.256
Max	1.291	1.328	1.285	1.286	1.300	1.273	1.265
UL	2.300	2.300	2.300	2.300	2.300	2.300	2.300

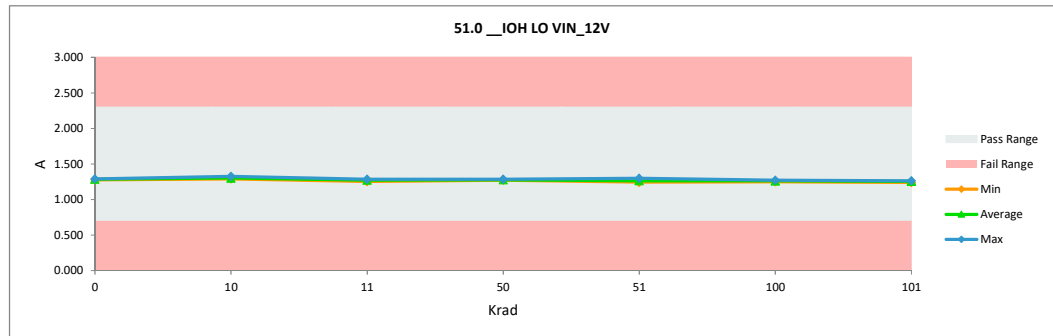

TID "HDR" Report
5962R2220102VXC

51.1 IOH HO VIN_12V		
Test Site	DAL	
Tester	ETS364	
Test Number	EB672303	EB672303
Unit	A	
Max Limit	2.3	
Min Limit	0.7	

Krad	Serial #	Pre_HDR_6013	Post_HDR_6013	Delta
0	1	1.275	1.287	0.013
0	2	1.280	1.289	0.009
10	182	1.302	1.307	0.005
10	202	1.291	1.288	-0.003
10	204	1.281	1.288	0.007
11	418	1.277	1.253	-0.024
11	419	1.275	1.287	0.012
11	443	1.293	1.270	-0.024
50	259	1.278	1.264	-0.013
50	346	1.299	1.286	-0.013
50	347	1.281	1.266	-0.015
51	462	1.280	1.240	-0.039
51	478	1.281	1.292	0.011
51	503	1.267	1.250	-0.016
100	354	1.262	1.231	-0.031
100	363	1.285	1.262	-0.023
100	366	1.278	1.249	-0.029
100	383	1.278	1.253	-0.026
100	417	1.286	1.240	-0.046
101	513	1.288	1.257	-0.030
101	526	1.290	1.260	-0.031
101	532	1.269	1.241	-0.028
101	533	1.288	1.261	-0.026
101	534	1.294	1.267	-0.027
Max		1.302	1.307	0.013
Average		1.282	1.266	-0.016
Min		1.262	1.231	-0.046
Std Dev		0.010	0.020	0.018

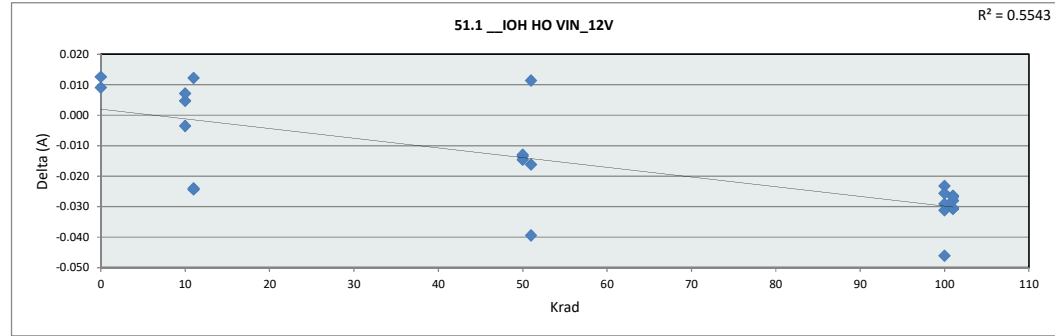

51.1 IOH HO VIN_12V		
Test Site	DAL	
Tester	ETS364	
Test Number	EB672303	
Max Limit	2.3	
Min Limit	0.7	

Krad	0	10	11	50	51	100	101
LL	0.700	0.700	0.700	0.700	0.700	0.700	0.700
Min	1.287	1.288	1.253	1.264	1.240	1.231	1.241
Average	1.288	1.294	1.270	1.272	1.261	1.247	1.257
Max	1.289	1.307	1.287	1.286	1.292	1.262	1.267
UL	2.300	2.300	2.300	2.300	2.300	2.300	2.300

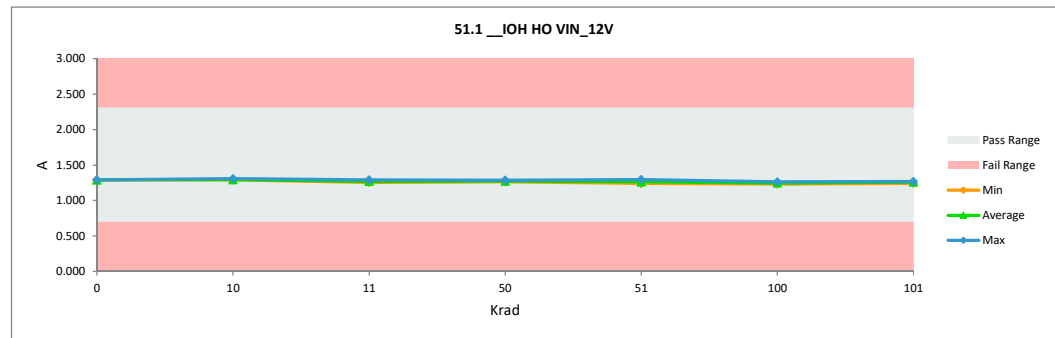

TID "HDR" Report
5962R2220102VXC

51.2_IOL LO VIN_12V		
Test Site	DAL	DAL
Tester	ETS364	ETS364
Test Number	EB672303	EB672303
Unit	A	A
Max Limit	4.6	4.6
Min Limit	1.6	1.6

Krad	Serial #	Pre_HDR_6013	Post_HDR_6013	Delta
0	1	2.529	2.557	0.028
0	2	2.574	2.598	0.024
10	182	2.568	2.609	0.041
10	202	2.551	2.569	0.018
10	204	2.553	2.603	0.049
11	418	2.561	2.534	-0.027
11	419	2.556	2.572	0.016
11	443	2.555	2.535	-0.020
50	259	2.534	2.600	0.066
50	346	2.551	2.623	0.073
50	347	2.543	2.607	0.064
51	462	2.562	2.611	0.049
51	478	2.549	2.624	0.075
51	503	2.549	2.602	0.053
100	354	2.551	2.645	0.094
100	363	2.571	2.626	0.055
100	366	2.539	2.627	0.088
100	383	2.542	2.654	0.112
100	417	2.547	2.632	0.085
101	513	2.546	2.641	0.096
101	526	2.561	2.654	0.093
101	532	2.553	2.650	0.097
101	533	2.539	2.635	0.096
101	534	2.517	2.612	0.095
	Max	2.574	2.654	0.112
	Average	2.550	2.609	0.059
	Min	2.517	2.534	-0.027
	Std Dev	0.013	0.034	0.038

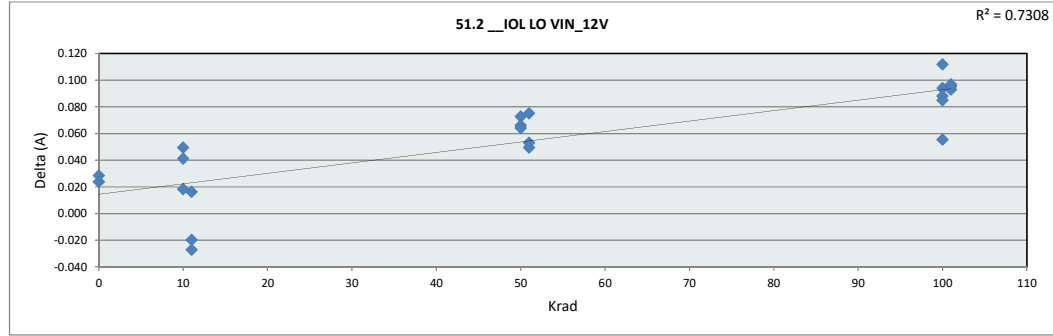

51.2_IOL LO VIN_12V		
Test Site	DAL	
Tester	ETS364	
Test Number	EB672303	
Max Limit	4.6	A
Min Limit	1.6	A

Krad	0	10	11	50	51	100	101
LL	1.600	1.600	1.600	1.600	1.600	1.600	1.600
Min	2.557	2.569	2.534	2.600	2.602	2.627	2.612
Average	2.577	2.594	2.547	2.610	2.612	2.637	2.638
Max	2.598	2.609	2.572	2.623	2.624	2.654	2.654
UL	4.600	4.600	4.600	4.600	4.600	4.600	4.600

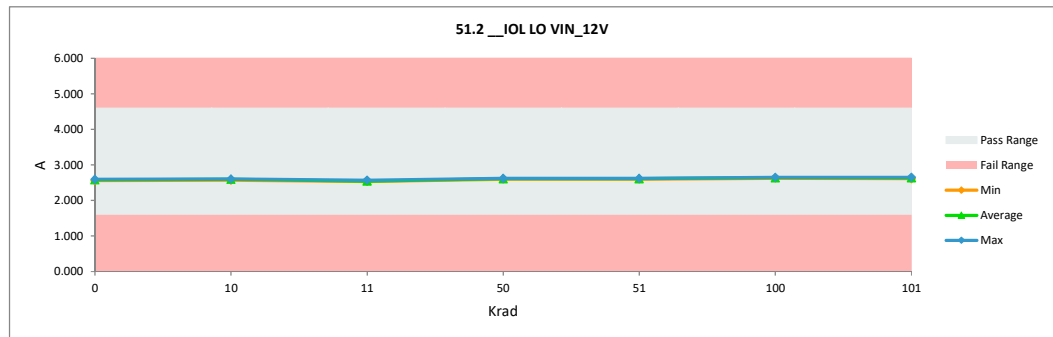

TID "HDR" Report
5962R2220102VXC

52.0 IOH LO VIN_14V		
Test Site	DAL	DAL
Tester	ETS364	ETS364
Test Number	EB672303	EB672303
Unit	A	A
Max Limit	2.3	2.3
Min Limit	0.7	0.7

Krad	Serial #	Pre_HDR_6013	Post_HDR_6013	Delta
0	1	1.267	1.279	0.012
0	2	1.283	1.291	0.008
10	182	1.321	1.328	0.007
10	202	1.291	1.289	-0.002
10	204	1.284	1.290	0.006
11	418	1.278	1.254	-0.023
11	419	1.274	1.285	0.011
11	443	1.286	1.276	-0.010
50	259	1.281	1.275	-0.006
50	346	1.290	1.286	-0.004
50	347	1.278	1.272	-0.007
51	462	1.277	1.243	-0.034
51	478	1.278	1.300	0.022
51	503	1.268	1.252	-0.016
100	354	1.272	1.256	-0.016
100	363	1.283	1.273	-0.010
100	366	1.277	1.263	-0.014
100	383	1.280	1.271	-0.009
100	417	1.279	1.250	-0.030
101	513	1.281	1.250	-0.031
101	526	1.293	1.263	-0.031
101	532	1.267	1.239	-0.028
101	533	1.291	1.263	-0.027
101	534	1.291	1.265	-0.026
Max		1.321	1.328	0.022
Average		1.282	1.271	-0.011
Min		1.267	1.239	-0.034
Std Dev		0.011	0.020	0.016

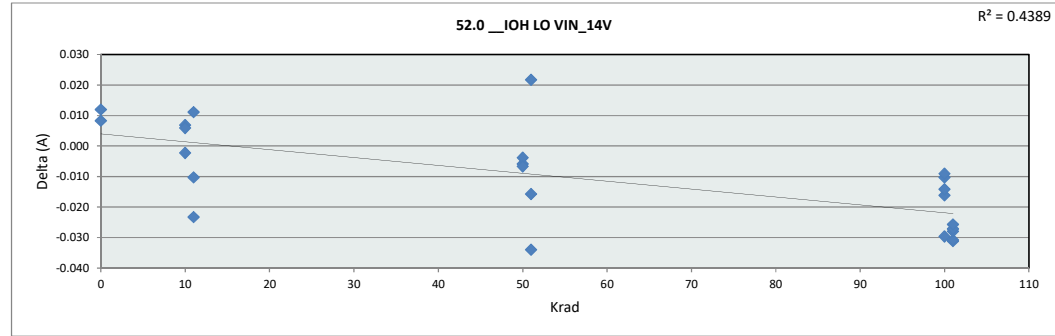

52.0 IOH LO VIN_14V		
Test Site	DAL	
Tester	ETS364	
Test Number	EB672303	
Max Limit	2.3	A
Min Limit	0.7	A

Krad	0	10	11	50	51	100	101
LL	0.700	0.700	0.700	0.700	0.700	0.700	0.700
Min	1.279	1.289	1.254	1.272	1.243	1.250	1.239
Average	1.285	1.302	1.272	1.278	1.265	1.263	1.256
Max	1.291	1.328	1.285	1.286	1.300	1.273	1.265
UL	2.300	2.300	2.300	2.300	2.300	2.300	2.300

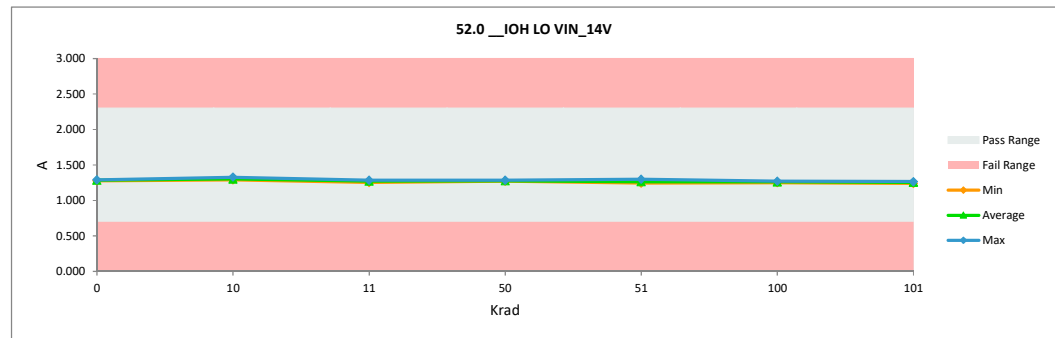

TID "HDR" Report
5962R2220102VXC

52.1 IOH HO VIN_14V		
Test Site	DAL	
Tester	ETS364	
Test Number	EB672303	EB672303
Unit	A	
Max Limit	2.3	
Min Limit	0.7	

Krad	Serial #	Pre_HDR_6013	Post_HDR_6013	Delta
0	1	1.275	1.288	0.013
0	2	1.280	1.289	0.009
10	182	1.303	1.307	0.004
10	202	1.291	1.288	-0.003
10	204	1.281	1.288	0.006
11	418	1.277	1.253	-0.024
11	419	1.274	1.287	0.013
11	443	1.293	1.270	-0.024
50	259	1.278	1.264	-0.013
50	346	1.299	1.286	-0.013
50	347	1.281	1.266	-0.015
51	462	1.280	1.240	-0.039
51	478	1.281	1.292	0.011
51	503	1.266	1.250	-0.016
100	354	1.262	1.231	-0.031
100	363	1.285	1.261	-0.024
100	366	1.278	1.249	-0.029
100	383	1.278	1.253	-0.026
100	417	1.287	1.240	-0.047
101	513	1.287	1.257	-0.030
101	526	1.290	1.259	-0.031
101	532	1.269	1.241	-0.028
101	533	1.288	1.261	-0.026
101	534	1.293	1.268	-0.026
Max		1.303	1.307	0.013
Average		1.282	1.266	-0.016
Min		1.262	1.231	-0.047
Std Dev		0.010	0.020	0.018

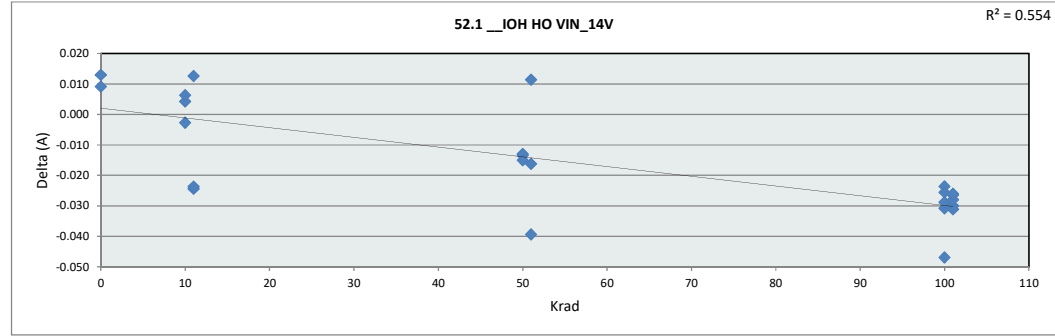

52.1 IOH HO VIN_14V		
Test Site	DAL	
Tester	ETS364	
Test Number	EB672303	
Max Limit	2.3	
Min Limit	0.7	

Krad	0	10	11	50	51	100	101
LL	0.700	0.700	0.700	0.700	0.700	0.700	0.700
Min	1.288	1.288	1.253	1.264	1.240	1.231	1.241
Average	1.288	1.294	1.270	1.272	1.261	1.247	1.257
Max	1.289	1.307	1.287	1.286	1.292	1.261	1.268
UL	2.300	2.300	2.300	2.300	2.300	2.300	2.300

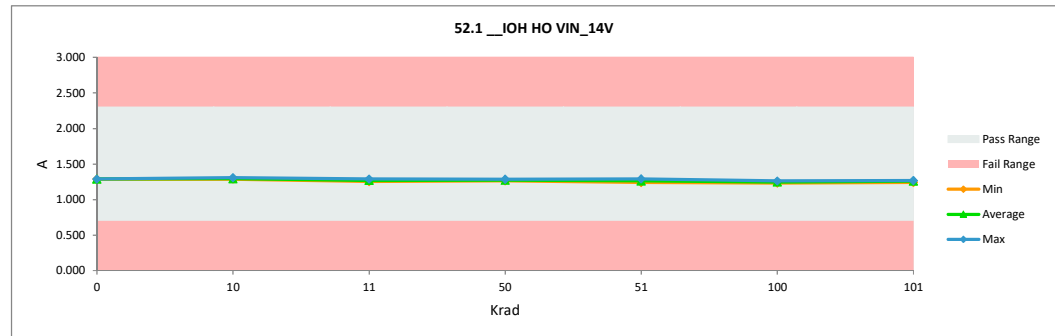

TID "HDR" Report
5962R2220102VXC

52.2_IOL LO VIN_14V		
Test Site	DAL	DAL
Tester	ETS364	ETS364
Test Number	EB672303	EB672303
Unit	A	A
Max Limit	4.6	4.6
Min Limit	1.6	1.6

Krad	Serial #	Pre_HDR_6013	Post_HDR_6013	Delta
0	1	2.529	2.557	0.028
0	2	2.575	2.598	0.024
10	182	2.568	2.609	0.041
10	202	2.551	2.569	0.018
10	204	2.553	2.602	0.049
11	418	2.561	2.534	-0.027
11	419	2.556	2.573	0.017
11	443	2.555	2.534	-0.020
50	259	2.534	2.600	0.066
50	346	2.551	2.623	0.072
50	347	2.543	2.607	0.064
51	462	2.562	2.611	0.049
51	478	2.549	2.624	0.075
51	503	2.549	2.601	0.053
100	354	2.551	2.644	0.094
100	363	2.571	2.626	0.055
100	366	2.539	2.627	0.088
100	383	2.542	2.654	0.112
100	417	2.547	2.632	0.085
101	513	2.546	2.641	0.095
101	526	2.560	2.654	0.093
101	532	2.553	2.649	0.096
101	533	2.538	2.634	0.096
101	534	2.517	2.612	0.095
Max		2.575	2.654	0.112
Average		2.550	2.609	0.059
Min		2.517	2.534	-0.027
Std Dev		0.013	0.034	0.038

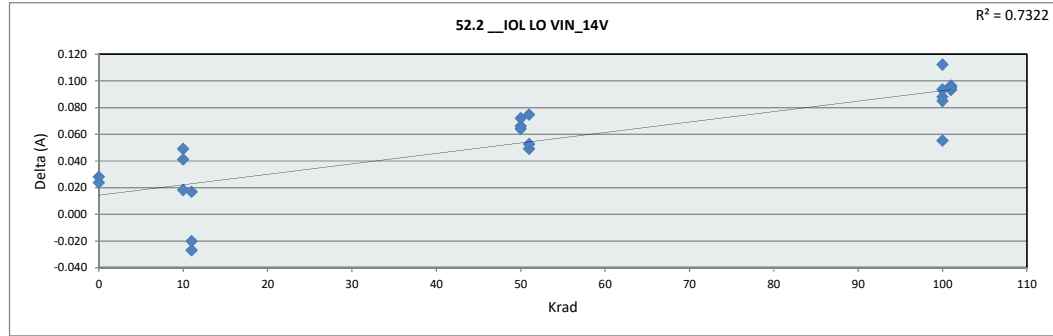

52.2_IOL LO VIN_14V		
Test Site	DAL	
Tester	ETS364	
Test Number	EB672303	
Max Limit	4.6	A
Min Limit	1.6	A

Krad	0	10	11	50	51	100	101
LL	1.600	1.600	1.600	1.600	1.600	1.600	1.600
Min	2.557	2.569	2.534	2.600	2.601	2.627	2.612
Average	2.578	2.593	2.547	2.610	2.612	2.637	2.638
Max	2.598	2.609	2.573	2.623	2.624	2.654	2.654
UL	4.600	4.600	4.600	4.600	4.600	4.600	4.600

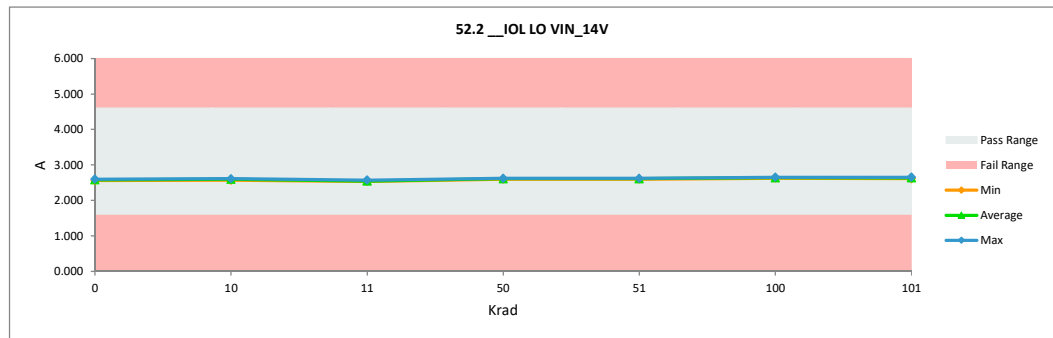

TID "HDR" Report
5962R2220102VXC

60.0 __V_BP7L PWM 500kHz VIN		
Test Site	DAL	DAL
Tester	ETS364	ETS364
Test Number	EB672303	EB672303
Unit	V	V
Max Limit	7.35	7.35
Min Limit	6.65	6.65

Krad	Serial #	Pre_HDR_6013	Post_HDR_6013	Delta
0	1	7.026	7.025	-0.001
0	2	6.986	6.986	-0.001
10	182	7.016	7.014	-0.002
10	202	7.036	7.034	-0.003
10	204	7.031	6.987	-0.044
11	418	7.032	7.032	0.000
11	419	7.019	6.997	-0.022
11	443	7.036	7.058	0.022
50	259	7.080	7.070	-0.009
50	346	7.061	7.042	-0.018
50	347	7.021	7.014	-0.007
51	462	7.068	7.016	-0.053
51	478	7.043	6.978	-0.065
51	503	7.049	7.041	-0.008
100	354	7.068	7.103	0.034
100	363	7.077	7.076	-0.001
100	366	7.011	6.986	-0.024
100	383	7.041	7.023	-0.019
100	417	7.098	7.124	0.026
101	513	7.061	7.042	-0.019
101	526	7.035	7.005	-0.030
101	532	7.031	7.007	-0.023
101	533	7.019	7.010	-0.008
101	534	7.059	7.038	-0.021
	Max	7.098	7.124	0.034
	Average	7.042	7.029	-0.012
	Min	6.986	6.978	-0.065
	Std Dev	0.026	0.037	0.023

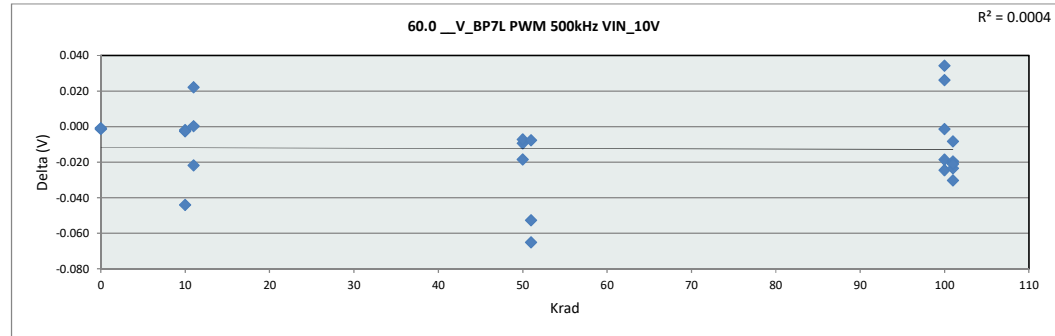

60.0 __V_BP7L PWM 500kHz V		
Test Site	DAL	
Tester	ETS364	
Test Number	EB672303	
Max Limit	7.35	V
Min Limit	6.65	V

Krad	0	10	11	50	51	100	101
LL	6.650	6.650	6.650	6.650	6.650	6.650	6.650
Min	6.986	6.987	6.997	7.014	6.978	6.986	7.005
Average	7.005	7.012	7.029	7.042	7.012	7.062	7.020
Max	7.025	7.034	7.058	7.070	7.041	7.124	7.042
UL	7.350	7.350	7.350	7.350	7.350	7.350	7.350

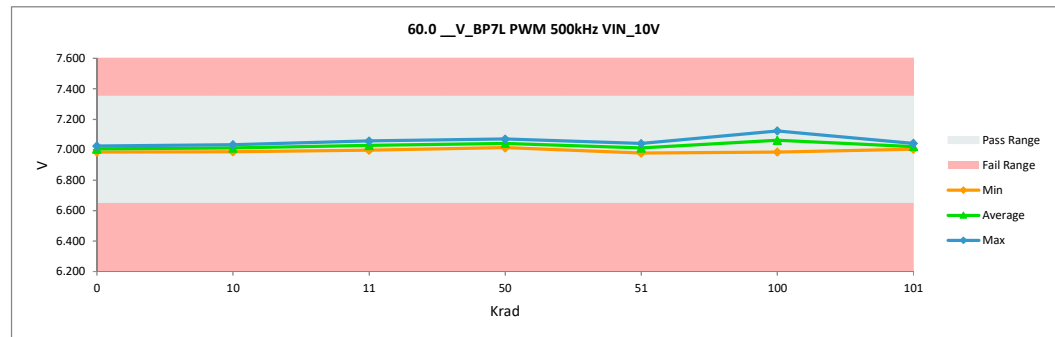

TID "HDR" Report 5962R2220102VXC

60.1 __V_BP5L PWM 500kHz VIN		
Test Site	DAL	DAL
Tester	ETS364	ETS364
Test Number	EB672303	EB672303
Unit	V	V
Max Limit	5.175	5.175
Min Limit	4.75	4.75

Krad	Serial #	Pre_HDR_6013	Post_HDR_6013	Delta
0	1	5.019	5.020	0.001
0	2	5.011	5.012	0.001
10	182	4.984	4.984	-0.001
10	202	4.990	4.988	-0.002
10	204	5.011	5.014	0.003
11	418	5.013	4.992	-0.021
11	419	5.014	4.997	-0.017
11	443	5.008	4.979	-0.029
50	259	4.999	4.996	-0.002
50	346	4.987	4.979	-0.008
50	347	5.000	4.998	-0.002
51	462	4.996	5.014	0.017
51	478	4.988	4.984	-0.004
51	503	4.991	4.986	-0.005
100	354	5.022	5.011	-0.011
100	363	5.002	5.006	0.005
100	366	4.991	4.990	-0.002
100	383	4.986	4.993	0.007
100	417	4.990	5.006	0.017
101	513	5.007	4.971	-0.036
101	526	5.010	4.985	-0.024
101	532	5.019	4.995	-0.025
101	533	5.002	5.006	0.004
101	534	5.009	4.976	-0.034
	Max	5.022	5.020	0.017
	Average	5.002	4.995	-0.007
	Min	4.984	4.971	-0.036
	Std Dev	0.012	0.014	0.015

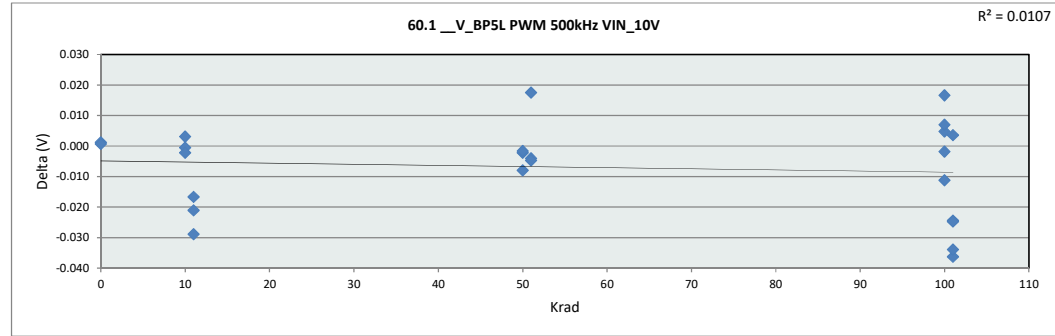

60.1 __V_BP5L PWM 500kHz V		
Test Site	DAL	
Tester	ETS364	
Test Number	EB672303	
Max Limit	5.175	V
Min Limit	4.75	V

Krad	0	10	11	50	51	100	101
LL	4.750	4.750	4.750	4.750	4.750	4.750	4.750
Min	5.012	4.984	4.979	4.979	4.984	4.990	4.971
Average	5.016	4.995	4.989	4.991	4.995	5.001	4.986
Max	5.020	5.014	4.997	4.998	5.014	5.011	5.006
UL	5.175	5.175	5.175	5.175	5.175	5.175	5.175

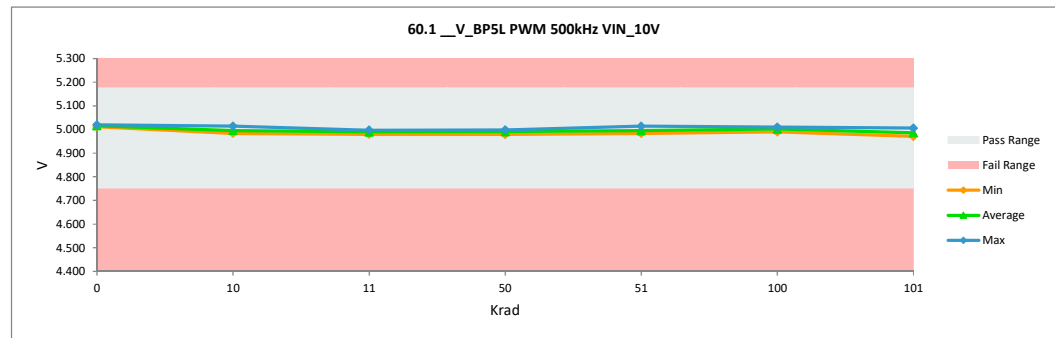

TID "HDR" Report
5962R2220102VXC

60.2 __V_BP5H PWM 500kHz VI		
Test Site	DAL	DAL
Tester	ETS364	ETS364
Test Number	EB672303	EB672303
Unit	V	V
Max Limit	5.175	5.175
Min Limit	4.75	4.75

Krad	Serial #	Pre_HDR_6013	Post_HDR_6013	Delta
0	1	5.000	5.001	0.000
0	2	5.017	5.017	0.001
10	182	4.997	4.995	-0.002
10	202	5.012	5.011	-0.001
10	204	5.020	5.018	-0.002
11	418	4.994	5.018	0.024
11	419	5.010	5.005	-0.006
11	443	5.008	4.988	-0.019
50	259	4.998	4.993	-0.005
50	346	4.994	4.988	-0.006
50	347	5.016	5.014	-0.002
51	462	5.009	5.004	-0.005
51	478	4.981	5.011	0.030
51	503	5.016	5.002	-0.014
100	354	5.009	5.007	-0.002
100	363	4.996	4.988	-0.008
100	366	4.989	4.983	-0.006
100	383	4.993	4.974	-0.019
100	417	5.003	4.998	-0.004
101	513	4.997	4.992	-0.005
101	526	4.993	4.998	0.005
101	532	5.008	4.985	-0.023
101	533	4.988	4.979	-0.009
101	534	4.985	4.969	-0.016
	Max	5.020	5.018	0.030
	Average	5.001	4.997	-0.004
	Min	4.981	4.969	-0.023
	Std Dev	0.011	0.014	0.012

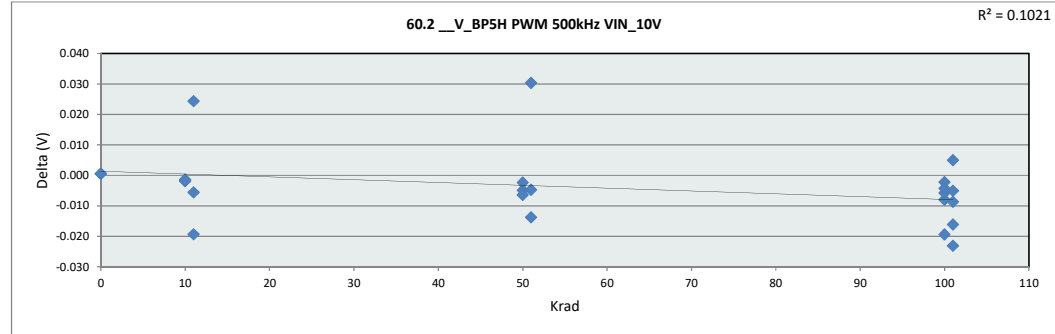

60.2 __V_BP5H PWM 500kHz		
Test Site	DAL	
Tester	ETS364	
Test Number	EB672303	
Max Limit	5.175	V
Min Limit	4.75	V

	0	10	11	50	51	100	101
LL	4.750	4.750	4.750	4.750	4.750	4.750	4.750
Min	5.001	4.995	4.988	4.988	5.002	4.974	4.969
Average	5.009	5.008	5.004	4.998	5.005	4.990	4.985
Max	5.017	5.018	5.018	5.018	5.014	5.011	5.007
UL	5.175	5.175	5.175	5.175	5.175	5.175	5.175

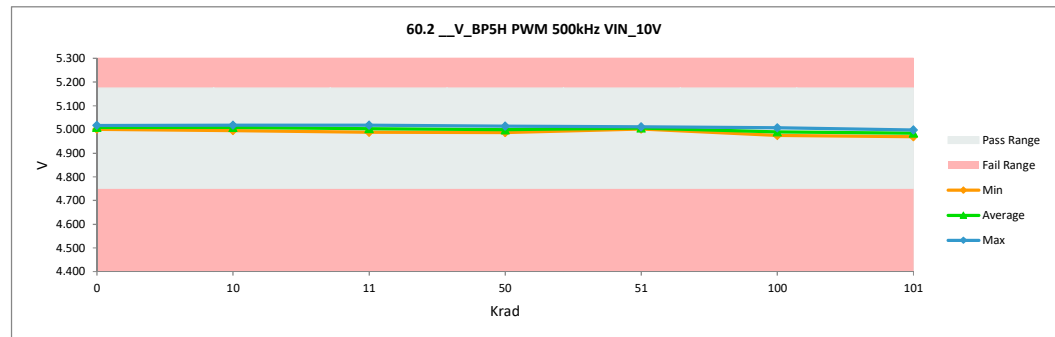

TID "HDR" Report
5962R2220102VXC

60.3 V_BP7L PWM 1MHz VIN		
Test Site	DAL	DAL
Tester	ETS364	ETS364
Test Number	EB672303	EB672303
Unit	V	V
Max Limit	7.35	7.35
Min Limit	6.65	6.65

Krad	Serial #	Pre_HDR_6013	Post_HDR_6013	Delta
0	1	7.022	7.020	-0.002
0	2	6.982	6.981	-0.001
10	182	7.011	7.009	-0.002
10	202	7.032	7.029	-0.003
10	204	7.027	6.983	-0.044
11	418	7.028	7.027	0.000
11	419	7.015	6.993	-0.022
11	443	7.031	7.054	0.022
50	259	7.075	7.066	-0.009
50	346	7.056	7.037	-0.019
50	347	7.016	7.010	-0.007
51	462	7.064	7.011	-0.053
51	478	7.039	6.973	-0.065
51	503	7.044	7.037	-0.008
100	354	7.064	7.099	0.035
100	363	7.072	7.072	0.000
100	366	7.006	6.981	-0.025
100	383	7.037	7.019	-0.018
100	417	7.094	7.120	0.026
101	513	7.056	7.036	-0.020
101	526	7.031	7.000	-0.031
101	532	7.026	7.002	-0.024
101	533	7.014	7.006	-0.008
101	534	7.055	7.033	-0.022
Max		7.094	7.120	0.035
Average		7.037	7.025	-0.012
Min		6.982	6.973	-0.065
Std Dev		0.026	0.037	0.023

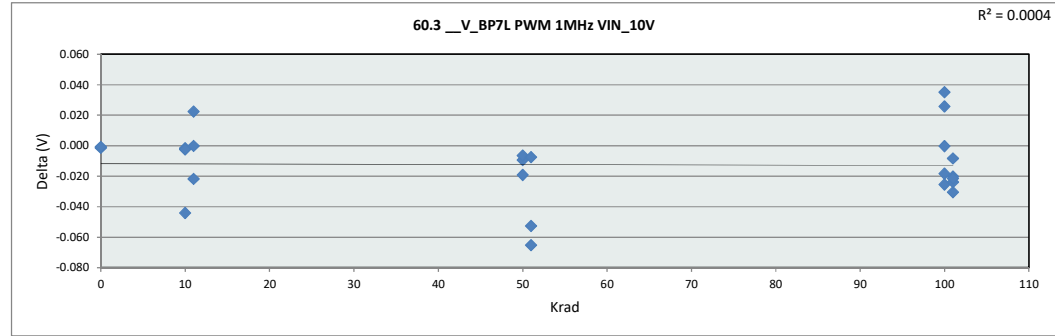

60.3 V_BP7L PWM 1MHz VIN		
Test Site	DAL	
Tester	ETS364	
Test Number	EB672303	
Max Limit	7.35	V
Min Limit	6.65	V

Krad	0	10	11	50	51	100	101
LL	6.650	6.650	6.650	6.650	6.650	6.650	6.650
Min	6.981	6.983	6.993	7.010	6.974	6.981	7.000
Average	7.001	7.007	7.025	7.037	7.007	7.058	7.016
Max	7.020	7.029	7.054	7.066	7.037	7.120	7.036
UL	7.350	7.350	7.350	7.350	7.350	7.350	7.350

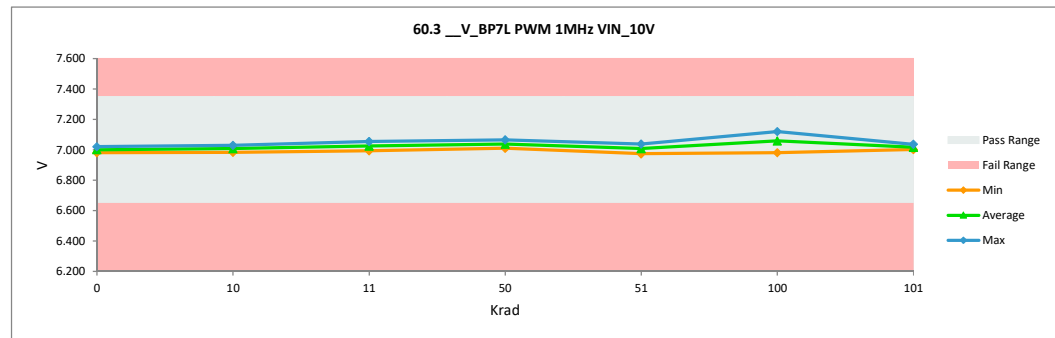

TID "HDR" Report 5962R2220102VXC

60.4 _V_BP5L PWM 1MHz VIN		
Test Site	DAL	
Tester	ETS364	
Test Number	EB672303	
Unit	V	
Max Limit	5.175	
Min Limit	4.75	

Krad	Serial #	Pre_HDR_6013	Post_HDR_6013	Delta
0	1	5.021	5.022	0.001
0	2	5.013	5.013	0.001
10	182	4.986	4.986	0.000
10	202	4.992	4.990	-0.002
10	204	5.013	5.016	0.003
11	418	5.014	4.993	-0.021
11	419	5.015	4.999	-0.017
11	443	5.010	4.981	-0.029
50	259	5.000	4.998	-0.002
50	346	4.989	4.981	-0.007
50	347	5.002	5.001	-0.001
51	462	4.998	5.016	0.018
51	478	4.989	4.986	-0.004
51	503	4.993	4.988	-0.004
100	354	5.024	5.013	-0.010
100	363	5.003	5.009	0.005
100	366	4.993	4.991	-0.001
100	383	4.988	4.995	0.008
100	417	4.991	5.008	0.017
101	513	5.009	4.972	-0.037
101	526	5.011	4.987	-0.024
101	532	5.021	4.996	-0.024
101	533	5.004	5.008	0.004
101	534	5.011	4.977	-0.034
	Max	5.024	5.022	0.018
	Average	5.004	4.997	-0.007
	Min	4.986	4.972	-0.037
	Std Dev	0.012	0.014	0.015

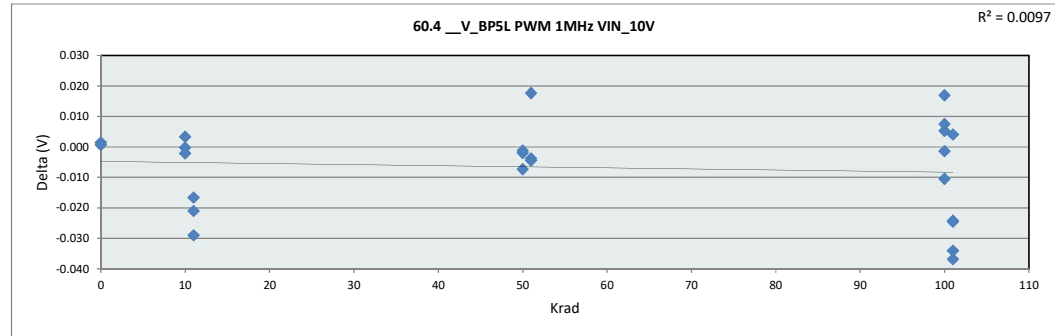

60.4 _V_BP5L PWM 1MHz VIN		
Test Site	DAL	
Tester	ETS364	
Test Number	EB672303	
Max Limit	5.175	
Min Limit	4.75	

	0	10	11	50	51	100	101
LL	4.750	4.750	4.750	4.750	4.750	4.750	4.750
Min	5.013	4.986	4.981	4.981	4.986	4.992	4.972
Average	5.018	4.997	4.991	4.993	4.997	5.003	4.988
Max	5.022	5.016	4.999	5.001	5.016	5.013	5.008
UL	5.175	5.175	5.175	5.175	5.175	5.175	5.175

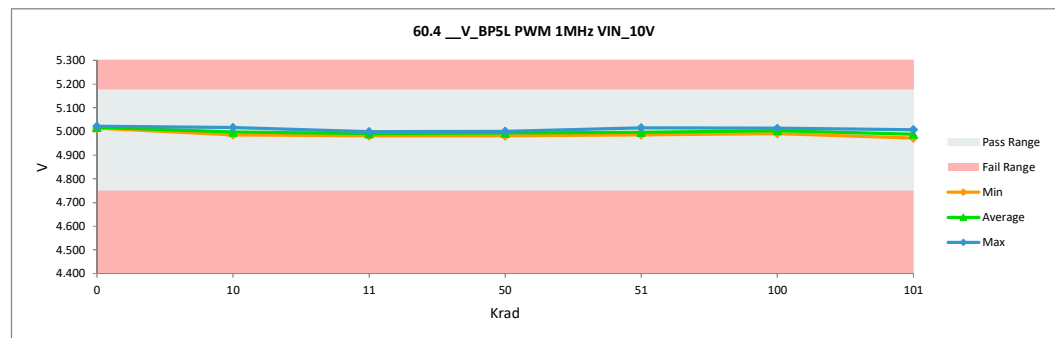

TID "HDR" Report
5962R2220102VXC

60.5_V_BP5H PWM 1MHz VIN		
Test Site	DAL	DAL
Tester	ETS364	ETS364
Test Number	EB672303	EB672303
Unit	V	V
Max Limit	5.175	5.175
Min Limit	4.75	4.75

Krad	Serial #	Pre_HDR_6013	Post_HDR_6013	Delta
0	1	5.001	5.001	0.001
0	2	5.017	5.018	0.001
10	182	4.998	4.996	-0.002
10	202	5.013	5.011	-0.001
10	204	5.020	5.019	-0.002
11	418	4.995	5.019	0.024
11	419	5.011	5.005	-0.005
11	443	5.008	4.989	-0.020
50	259	4.998	4.994	-0.005
50	346	4.994	4.988	-0.006
50	347	5.017	5.015	-0.002
51	462	5.009	5.004	-0.005
51	478	4.981	5.011	0.030
51	503	5.016	5.002	-0.014
100	354	5.010	5.007	-0.002
100	363	4.997	4.989	-0.008
100	366	4.989	4.984	-0.006
100	383	4.994	4.975	-0.020
100	417	5.003	4.999	-0.004
101	513	4.997	4.992	-0.005
101	526	4.993	4.998	0.005
101	532	5.009	4.986	-0.023
101	533	4.988	4.980	-0.009
101	534	4.986	4.970	-0.016
Max		5.020	5.019	0.030
Average		5.002	4.998	-0.004
Min		4.981	4.970	-0.023
Std Dev		0.011	0.014	0.012

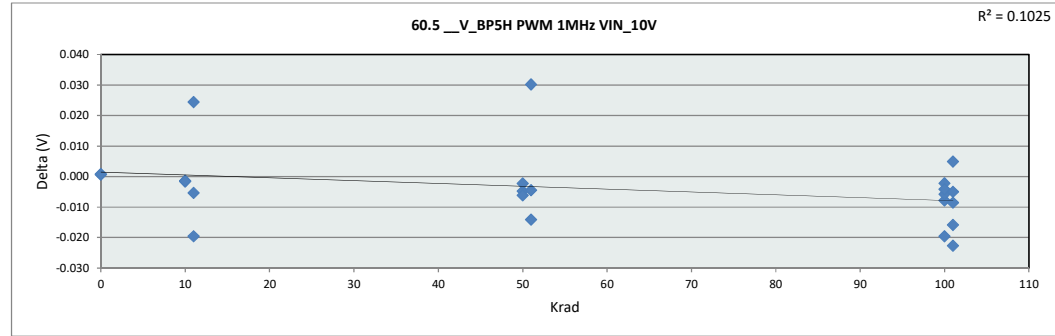

60.5_V_BP5H PWM 1MHz VI		
Test Site	DAL	
Tester	ETS364	
Test Number	EB672303	
Max Limit	5.175	V
Min Limit	4.75	V

	0	10	11	50	51	100	101
LL	4.750	4.750	4.750	4.750	4.750	4.750	4.750
Min	5.001	4.996	4.989	4.988	5.002	4.975	4.970
Average	5.010	5.009	5.004	4.999	5.006	4.991	4.985
Max	5.018	5.019	5.019	5.015	5.011	5.007	4.998
UL	5.175	5.175	5.175	5.175	5.175	5.175	5.175

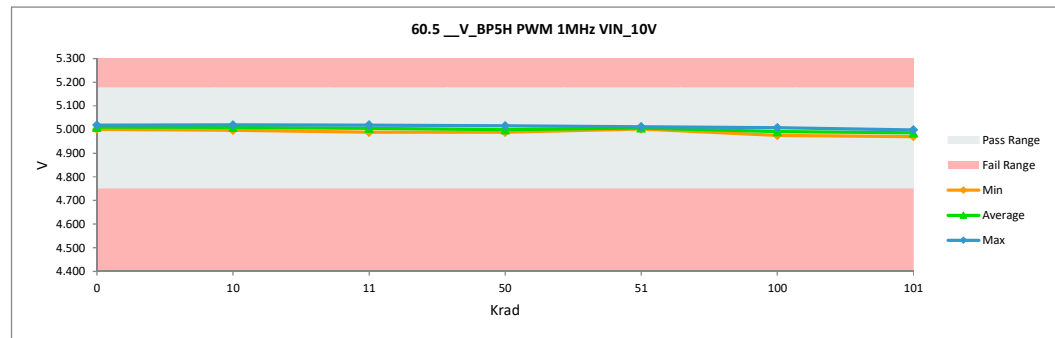

TID "HDR" Report
5962R2220102VXC

60.6 V_BP7L PWM 2MHz VIN		
Test Site	DAL	DAL
Tester	ETS364	ETS364
Test Number	EB672303	EB672303
Unit	V	V
Max Limit	7.35	7.35
Min Limit	6.65	6.65

Krad	Serial #	Pre_HDR_6013	Post_HDR_6013	Delta
0	1	7.014	7.011	-0.002
0	2	6.973	6.972	-0.001
10	182	7.002	7.000	-0.002
10	202	7.023	7.020	-0.002
10	204	7.018	6.974	-0.044
11	418	7.019	7.019	0.000
11	419	7.006	6.985	-0.021
11	443	7.023	7.046	0.023
50	259	7.066	7.057	-0.009
50	346	7.047	7.027	-0.020
50	347	7.008	7.002	-0.006
51	462	7.055	7.002	-0.053
51	478	7.030	6.965	-0.066
51	503	7.036	7.029	-0.008
100	354	7.055	7.091	0.036
100	363	7.063	7.065	0.001
100	366	6.998	6.972	-0.026
100	383	7.029	7.010	-0.018
100	417	7.086	7.111	0.025
101	513	7.048	7.027	-0.021
101	526	7.023	6.991	-0.032
101	532	7.018	6.992	-0.025
101	533	7.005	6.996	-0.009
101	534	7.046	7.024	-0.022
Max		7.086	7.111	0.036
Average		7.029	7.016	-0.013
Min		6.973	6.965	-0.066
Std Dev		0.026	0.037	0.023

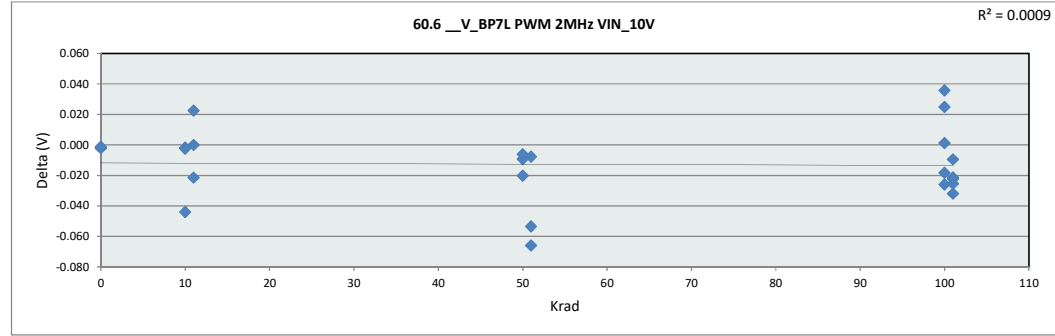

60.6 V_BP7L PWM 2MHz VIN		
Test Site	DAL	
Tester	ETS364	
Test Number	EB672303	
Max Limit	7.35	V
Min Limit	6.65	V

	0	10	11	50	51	100	101
LL	6.650	6.650	6.650	6.650	6.650	6.650	6.650
Min	6.972	6.974	6.985	7.002	6.965	6.972	6.992
Average	6.992	6.998	7.017	7.029	6.998	7.050	7.006
Max	7.011	7.020	7.046	7.057	7.029	7.111	7.027
UL	7.350	7.350	7.350	7.350	7.350	7.350	7.350

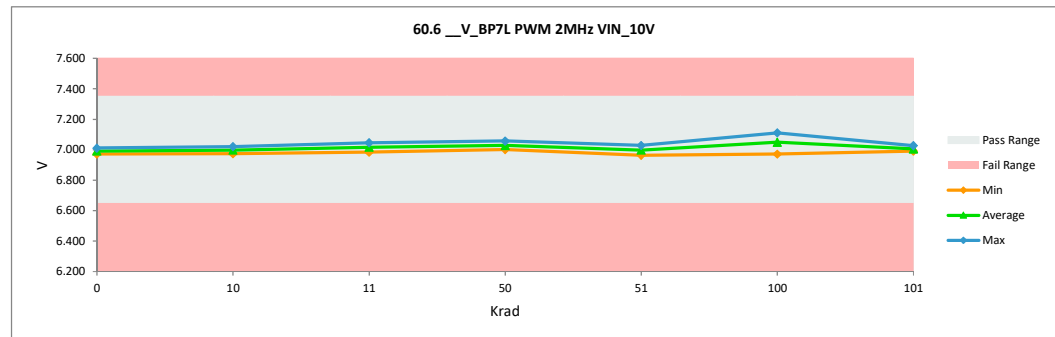

TID "HDR" Report
5962R2220102VXC

60.7 V_BP5L PWM 2MHz VIN		
Test Site	DAL	DAL
Tester	ETS364	ETS364
Test Number	EB672303	EB672303
Unit	V	V
Max Limit	5.175	5.175
Min Limit	4.75	4.75

Krad	Serial #	Pre_HDR_6013	Post_HDR_6013	Delta
0	1	5.024	5.025	0.001
0	2	5.016	5.017	0.001
10	182	4.990	4.990	0.000
10	202	4.995	4.993	-0.002
10	204	5.017	5.021	0.004
11	418	5.017	4.997	-0.020
11	419	5.019	5.002	-0.016
11	443	5.013	4.984	-0.030
50	259	5.004	5.003	-0.001
50	346	4.992	4.985	-0.006
50	347	5.005	5.005	0.000
51	462	5.002	5.020	0.018
51	478	4.993	4.989	-0.003
51	503	4.996	4.992	-0.004
100	354	5.027	5.018	-0.009
100	363	5.007	5.013	0.006
100	366	4.996	4.996	0.000
100	383	4.992	5.001	0.009
100	417	4.995	5.013	0.018
101	513	5.012	4.975	-0.037
101	526	5.015	4.990	-0.025
101	532	5.024	5.000	-0.024
101	533	5.007	5.012	0.005
101	534	5.015	4.980	-0.034
Max		5.027	5.025	0.018
Average		5.007	5.001	-0.006
Min		4.990	4.975	-0.037
Std Dev		0.012	0.014	0.015

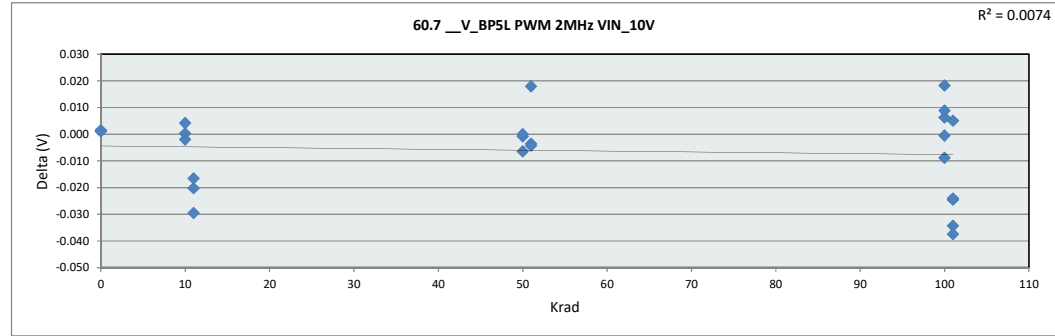

60.7 V_BP5L PWM 2MHz VIN		
Test Site	DAL	
Tester	ETS364	
Test Number	EB672303	
Max Limit	5.175	V
Min Limit	4.75	V

	0	10	11	50	51	100	101
LL	4.750	4.750	4.750	4.750	4.750	4.750	4.750
Min	5.017	4.990	4.984	4.986	4.989	4.996	4.975
Average	5.021	5.001	4.994	4.998	5.000	5.008	4.992
Max	5.026	5.021	5.002	5.005	5.020	5.018	5.012
UL	5.175	5.175	5.175	5.175	5.175	5.175	5.175

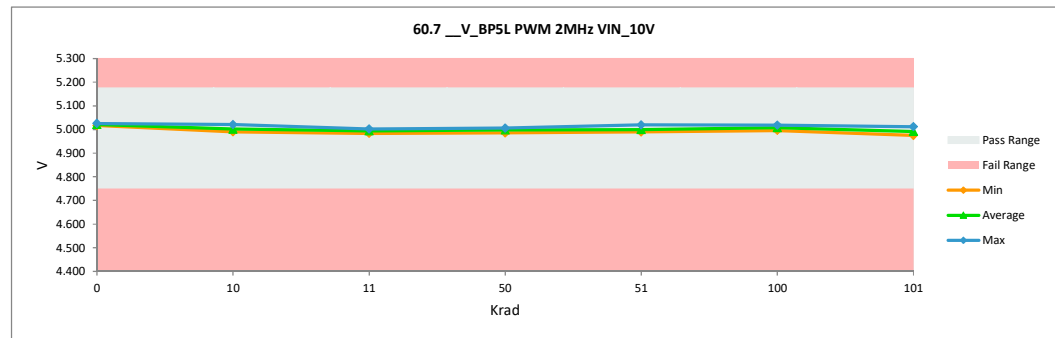

TID "HDR" Report
5962R2220102VXC

60.8_V_BP5H PWM 2MHz VIN		
Test Site	DAL	DAL
Tester	ETS364	ETS364
Test Number	EB672303	EB672303
Unit	V	V
Max Limit	5.175	5.175
Min Limit	4.75	4.75

Krad	Serial #	Pre_HDR_6013	Post_HDR_6013	Delta
0	1	5.002	5.003	0.001
0	2	5.019	5.019	0.001
10	182	4.999	4.997	-0.002
10	202	5.014	5.013	-0.001
10	204	5.022	5.020	-0.001
11	418	4.996	5.020	0.025
11	419	5.012	5.007	-0.005
11	443	5.009	4.990	-0.020
50	259	5.000	4.995	-0.005
50	346	4.996	4.990	-0.006
50	347	5.018	5.016	-0.002
51	462	5.010	5.006	-0.005
51	478	4.982	5.012	0.030
51	503	5.017	5.003	-0.014
100	354	5.011	5.008	-0.002
100	363	4.998	4.990	-0.008
100	366	4.991	4.985	-0.006
100	383	4.995	4.976	-0.020
100	417	5.004	5.000	-0.004
101	513	4.999	4.994	-0.005
101	526	4.995	5.000	0.005
101	532	5.010	4.987	-0.023
101	533	4.989	4.981	-0.008
101	534	4.987	4.971	-0.016
	Max	5.022	5.020	0.030
	Average	5.003	4.999	-0.004
	Min	4.982	4.971	-0.023
	Std Dev	0.011	0.014	0.012

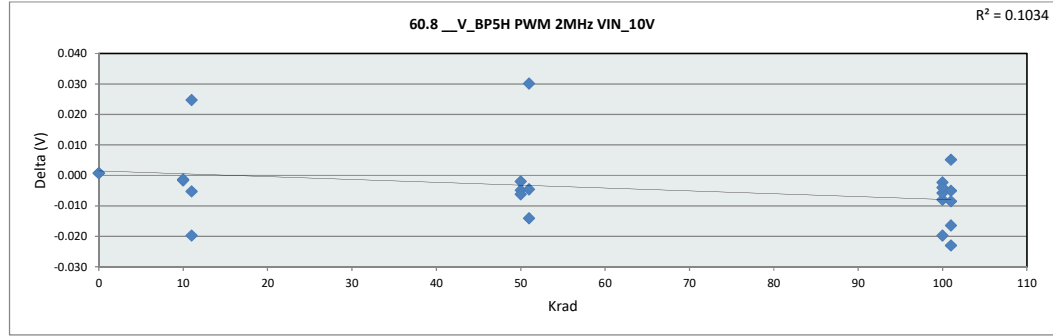

60.8_V_BP5H PWM 2MHz VI		
Test Site	DAL	
Tester	ETS364	
Test Number	EB672303	
Max Limit	5.175	V
Min Limit	4.75	V

	0	10	11	50	51	100	101
LL	4.750	4.750	4.750	4.750	4.750	4.750	4.750
Min	5.003	4.997	4.990	4.990	5.003	4.976	4.971
Average	5.011	5.010	5.006	5.000	5.007	4.992	4.986
Max	5.019	5.020	5.020	5.016	5.013	5.008	5.000
UL	5.175	5.175	5.175	5.175	5.175	5.175	5.175

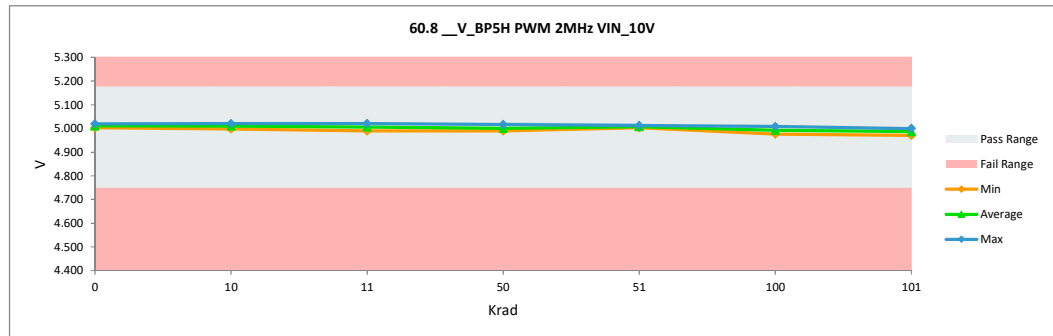

TID "HDR" Report
5962R2220102VXC

60.9 V_BP7L PWM 5MHz VIN		
Test Site	DAL	DAL
Tester	ETS364	ETS364
Test Number	EB672303	EB672303
Unit	V	V
Max Limit	7.35	7.35
Min Limit	6.65	6.65

Krad	Serial #	Pre_HDR_6013	Post_HDR_6013	Delta
0	1	7.021	7.019	-0.001
0	2	6.980	6.959	-0.021
10	182	7.010	7.010	0.000
10	202	7.029	7.029	-0.001
10	204	7.027	6.982	-0.045
11	418	7.027	7.026	-0.001
11	419	7.013	6.992	-0.022
11	443	7.031	7.052	0.021
50	259	7.073	7.064	-0.008
50	346	7.056	7.032	-0.024
50	347	7.005	7.012	0.007
51	462	7.063	7.010	-0.052
51	478	7.038	6.973	-0.065
51	503	7.044	7.036	-0.008
100	354	7.063	7.102	0.038
100	363	7.071	7.056	-0.015
100	366	7.004	6.976	-0.029
100	383	7.036	7.019	-0.016
100	417	7.094	7.120	0.027
101	513	7.056	7.033	-0.023
101	526	7.031	6.997	-0.034
101	532	7.025	6.999	-0.027
101	533	7.014	7.006	-0.008
101	534	7.054	7.032	-0.022
Max		7.094	7.120	0.038
Average		7.036	7.022	-0.014
Min		6.980	6.959	-0.065
Std Dev		0.026	0.038	0.024

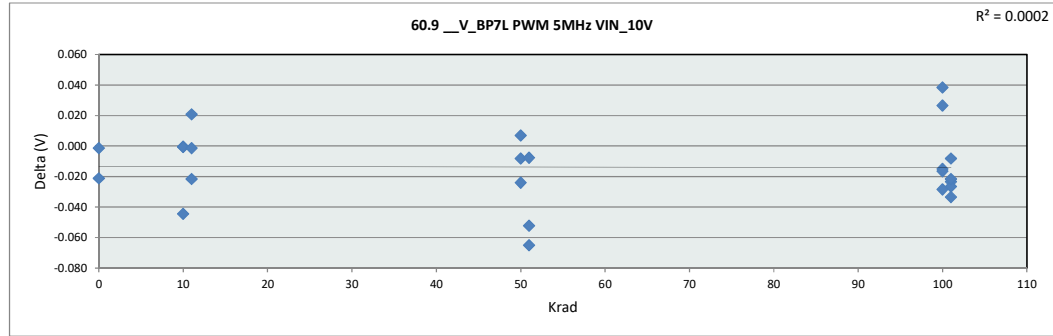

60.9 V_BP7L PWM 5MHz VIN		
Test Site	DAL	
Tester	ETS364	
Test Number	EB672303	
Max Limit	7.35	V
Min Limit	6.65	V

	0	10	11	50	51	100	101
LL	6.650	6.650	6.650	6.650	6.650	6.650	6.650
Min	6.959	6.982	6.992	7.012	6.973	6.976	6.997
Average	6.989	7.007	7.023	7.036	7.007	7.055	7.013
Max	7.019	7.029	7.052	7.065	7.036	7.120	7.033
UL	7.350	7.350	7.350	7.350	7.350	7.350	7.350

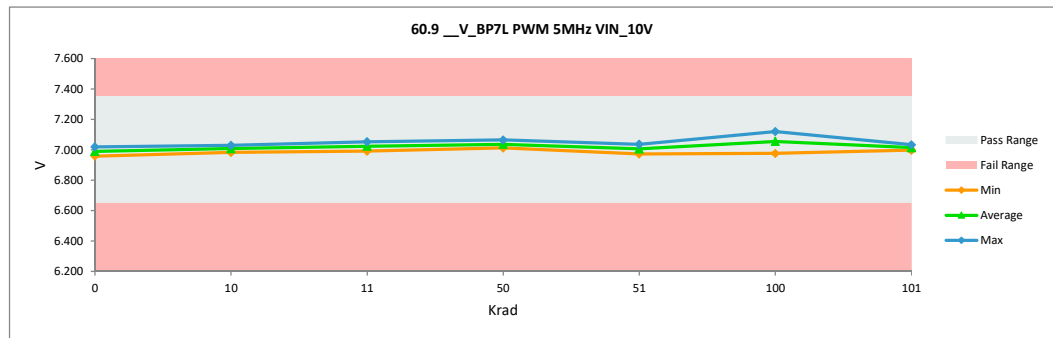

TID "HDR" Report
5962R2220102VXC

60.10_V_BP5L PWM 5MHz VIN		
Test Site	DAL	DAL
Tester	ETS364	ETS364
Test Number	EB672303	EB672303
Unit	V	V
Max Limit	5.175	5.175
Min Limit	4.75	4.75

Krad	Serial #	Pre_HDR_6013	Post_HDR_6013	Delta
0	1	5.020	5.021	0.001
0	2	5.012	5.014	0.002
10	182	4.986	4.986	0.000
10	202	4.992	4.990	-0.002
10	204	5.013	5.016	0.004
11	418	5.014	4.994	-0.021
11	419	5.016	4.999	-0.017
11	443	5.010	4.981	-0.029
50	259	5.001	4.999	-0.002
50	346	4.989	4.981	-0.008
50	347	5.002	5.001	-0.001
51	462	4.998	5.016	0.018
51	478	4.989	4.985	-0.004
51	503	4.993	4.989	-0.004
100	354	5.024	5.014	-0.010
100	363	5.003	5.017	0.014
100	366	4.993	4.992	-0.001
100	383	4.988	4.995	0.007
100	417	4.992	5.008	0.017
101	513	5.009	4.970	-0.039
101	526	5.011	4.986	-0.026
101	532	5.021	4.996	-0.025
101	533	5.004	5.009	0.005
101	534	5.011	4.977	-0.034
Max		5.024	5.021	0.018
Average		5.004	4.997	-0.006
Min		4.986	4.970	-0.039
Std Dev		0.012	0.014	0.016

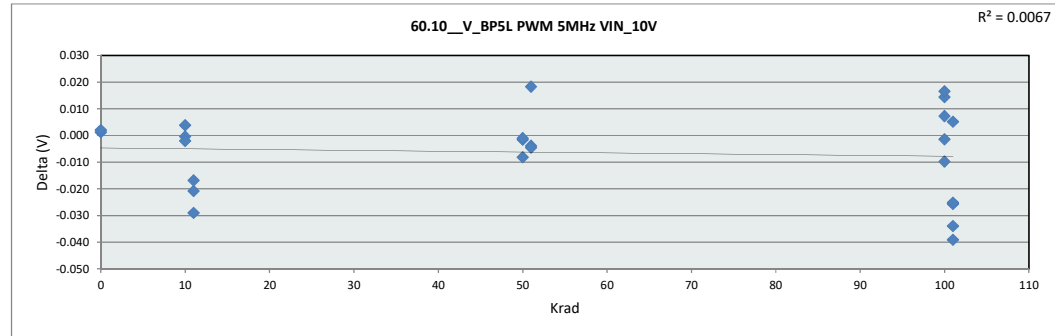

60.10_V_BP5L PWM 5MHz VI		
Test Site	DAL	
Tester	ETS364	
Test Number	EB672303	
Max Limit	5.175	V
Min Limit	4.75	V

Krad	0	10	11	50	51	100	101
LL	4.750	4.750	4.750	4.750	4.750	4.750	4.750
Min	5.014	4.986	4.981	4.981	4.985	4.992	4.970
Average	5.018	4.997	4.991	4.994	4.997	5.005	4.988
Max	5.021	5.016	4.999	5.001	5.016	5.017	5.009
UL	5.175	5.175	5.175	5.175	5.175	5.175	5.175

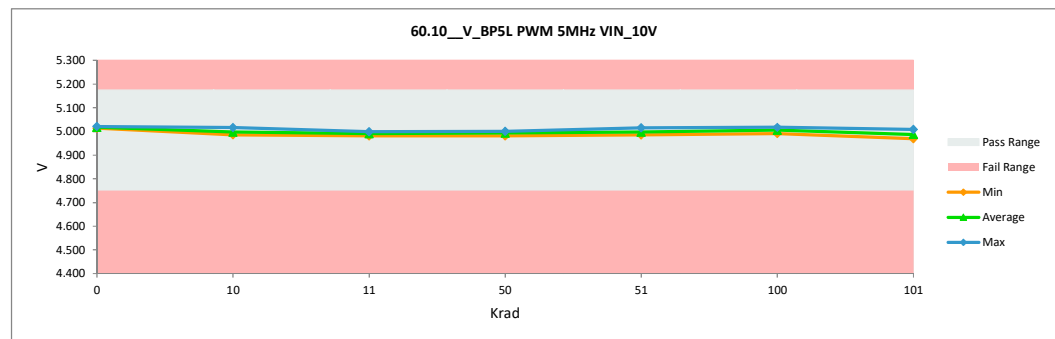

TID "HDR" Report
5962R2220102VXC

60.11_V_BP5H PWM 5MHz VIN		
Test Site	DAL	DAL
Tester	ETS364	ETS364
Test Number	EB672303	EB672303
Unit	V	V
Max Limit	5.175	5.175
Min Limit	4.75	4.75

Krad	Serial #	Pre_HDR_6013	Post_HDR_6013	Delta
0	1	5.003	5.004	0.001
0	2	5.020	5.021	0.001
10	182	5.001	4.999	-0.001
10	202	5.016	5.015	-0.001
10	204	5.024	5.023	-0.001
11	418	4.997	5.022	0.025
11	419	5.014	5.009	-0.005
11	443	5.011	4.991	-0.021
50	259	5.001	4.997	-0.003
50	346	4.997	4.991	-0.006
50	347	5.021	5.018	-0.003
51	462	5.013	5.007	-0.006
51	478	4.985	5.014	0.029
51	503	5.020	5.005	-0.015
100	354	5.012	5.010	-0.002
100	363	4.999	4.991	-0.008
100	366	4.992	4.987	-0.004
100	383	4.997	4.977	-0.020
100	417	5.006	5.002	-0.004
101	513	5.000	4.996	-0.004
101	526	4.996	5.003	0.007
101	532	5.011	4.989	-0.023
101	533	4.991	4.982	-0.009
101	534	4.988	4.973	-0.015
	Max	5.024	5.023	0.029
	Average	5.005	5.001	-0.004
	Min	4.985	4.973	-0.023
	Std Dev	0.011	0.014	0.012

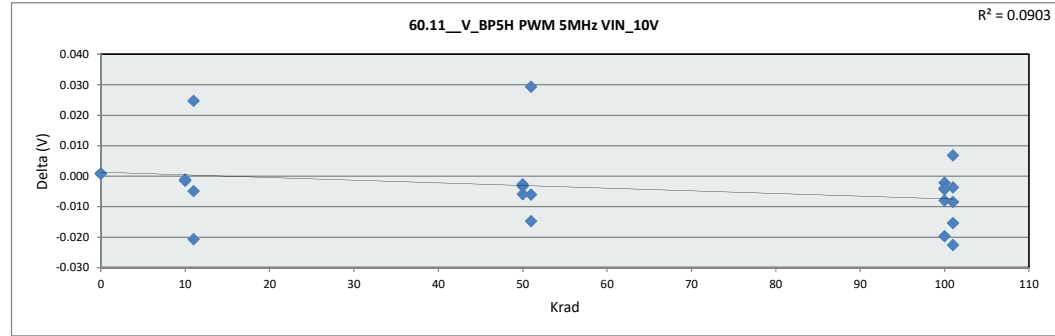

60.11_V_BP5H PWM 5MHz V1		
Test Site	DAL	
Tester	ETS364	
Test Number	EB672303	
Max Limit	5.175	V
Min Limit	4.75	V

Krad	0	10	11	50	51	100	101
LL	4.750	4.750	4.750	4.750	4.750	4.750	4.750
Min	5.004	4.999	4.991	4.992	5.005	4.977	4.973
Average	5.012	5.012	5.007	5.002	5.009	4.994	4.989
Max	5.021	5.023	5.022	5.018	5.014	5.010	5.003
UL	5.175	5.175	5.175	5.175	5.175	5.175	5.175

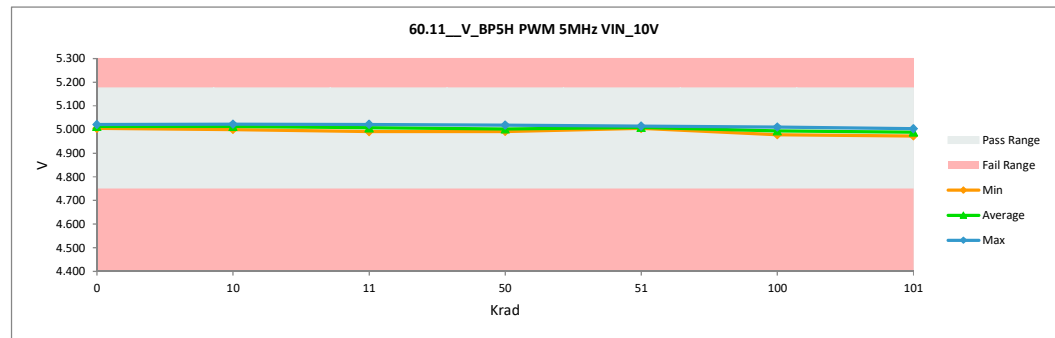

TID "HDR" Report
5962R2220102VXC

60.12_V_BP7L IIM 500kHz VIN		
Test Site	DAL	DAL
Tester	ETS364	ETS364
Test Number	EB672303	EB672303
Unit	V	V
Max Limit	7.35	7.35
Min Limit	6.65	6.65

Krad	Serial #	Pre_HDR_6013	Post_HDR_6013	Delta
0	1	7.026	7.025	-0.002
0	2	6.986	6.985	-0.001
10	182	7.016	7.014	-0.002
10	202	7.036	7.034	-0.003
10	204	7.031	6.987	-0.044
11	418	7.032	7.032	0.000
11	419	7.019	6.997	-0.022
11	443	7.036	7.058	0.022
50	259	7.080	7.070	-0.009
50	346	7.060	7.042	-0.019
50	347	7.021	7.014	-0.007
51	462	7.068	7.016	-0.053
51	478	7.043	6.978	-0.065
51	503	7.049	7.042	-0.007
100	354	7.068	7.103	0.035
100	363	7.077	7.076	-0.001
100	366	7.011	6.986	-0.025
100	383	7.041	7.023	-0.018
100	417	7.098	7.125	0.026
101	513	7.061	7.041	-0.020
101	526	7.035	7.005	-0.030
101	532	7.031	7.008	-0.023
101	533	7.018	7.010	-0.008
101	534	7.059	7.038	-0.021
Max		7.098	7.125	0.035
Average		7.042	7.029	-0.012
Min		6.986	6.978	-0.065
Std Dev		0.026	0.037	0.023

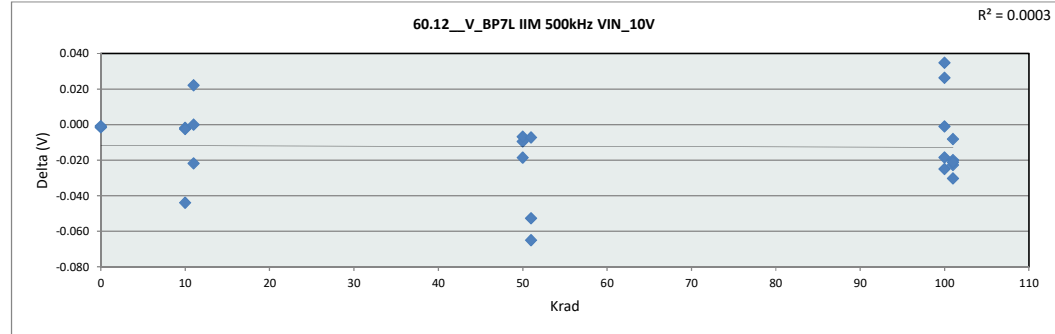

60.12_V_BP7L IIM 500kHz V		
Test Site	DAL	
Tester	ETS364	
Test Number	EB672303	
Max Limit	7.35	V
Min Limit	6.65	V

	0	10	11	50	51	100	101
LL	6.650	6.650	6.650	6.650	6.650	6.650	6.650
Min	6.985	6.987	6.997	7.014	6.978	6.986	7.005
Average	7.005	7.012	7.029	7.042	7.012	7.062	7.020
Max	7.025	7.034	7.058	7.070	7.042	7.125	7.041
UL	7.350	7.350	7.350	7.350	7.350	7.350	7.350

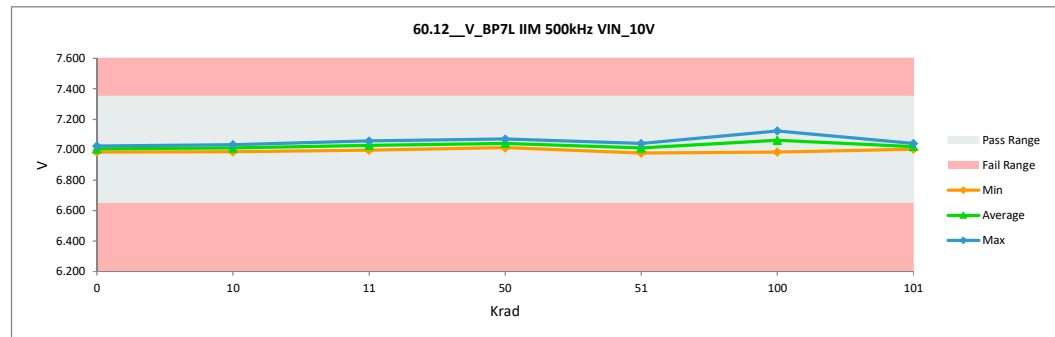

TID "HDR" Report
5962R2220102VXC

60.13_V_BP5L_IIM_500kHz_VIN		
Test Site	DAL	DAL
Tester	ETS364	ETS364
Test Number	EB672303	EB672303
Unit	V	V
Max Limit	5.175	5.175
Min Limit	4.75	4.75

Krad	Serial #	Pre_HDR_6013	Post_HDR_6013	Delta
0	1	5.019	5.020	0.001
0	2	5.011	5.012	0.001
10	182	4.984	4.984	-0.001
10	202	4.990	4.988	-0.002
10	204	5.011	5.014	0.003
11	418	5.013	4.992	-0.021
11	419	5.014	4.997	-0.017
11	443	5.008	4.979	-0.029
50	259	4.999	4.997	-0.002
50	346	4.987	4.979	-0.008
50	347	5.000	4.998	-0.001
51	462	4.996	5.014	0.018
51	478	4.988	4.984	-0.004
51	503	4.991	4.987	-0.004
100	354	5.022	5.011	-0.011
100	363	5.002	5.007	0.005
100	366	4.991	4.989	-0.002
100	383	4.986	4.993	0.007
100	417	4.990	5.006	0.016
101	513	5.007	4.970	-0.037
101	526	5.010	4.985	-0.025
101	532	5.019	4.995	-0.025
101	533	5.002	5.006	0.004
101	534	5.010	4.976	-0.034
	Max	5.022	5.020	0.018
	Average	5.002	4.995	-0.007
	Min	4.984	4.970	-0.037
	Std Dev	0.012	0.014	0.015

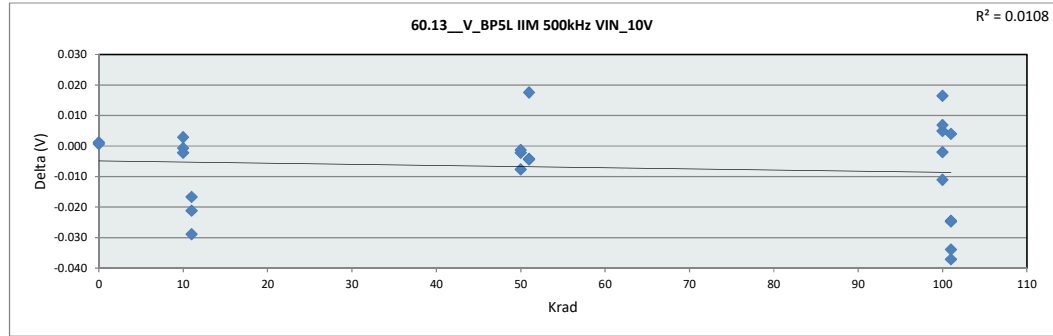

60.13_V_BP5L_IIM_500kHz_V		
Test Site	DAL	
Tester	ETS364	
Test Number	EB672303	
Max Limit	5.175	V
Min Limit	4.75	V

	0	10	11	50	51	100	101
LL	4.750	4.750	4.750	4.750	4.750	4.750	4.750
Min	5.012	4.984	4.979	4.979	4.984	4.989	4.970
Average	5.016	4.995	4.989	4.991	4.995	5.001	4.986
Max	5.020	5.014	4.997	4.999	5.014	5.011	5.006
UL	5.175	5.175	5.175	5.175	5.175	5.175	5.175

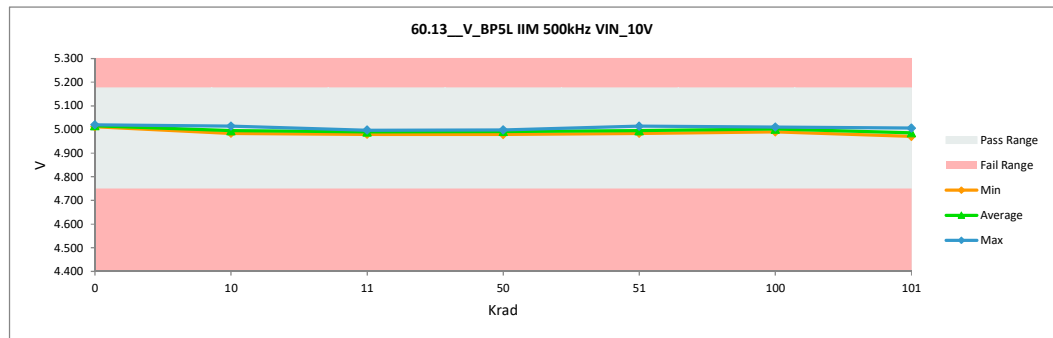

TID "HDR" Report
5962R2220102VXC

60.14_V_BP5H_IIM_500kHz_VIN		
Test Site	DAL	DAL
Tester	ETS364	ETS364
Test Number	EB672303	EB672303
Unit	V	V
Max Limit	5.175	5.175
Min Limit	4.75	4.75

Krad	Serial #	Pre_HDR_6013	Post_HDR_6013	Delta
0	1	5.000	5.001	0.001
0	2	5.016	5.017	0.001
10	182	4.997	4.995	-0.002
10	202	5.012	5.011	-0.001
10	204	5.020	5.018	-0.002
11	418	4.994	5.018	0.024
11	419	5.010	5.004	-0.006
11	443	5.008	4.988	-0.019
50	259	4.998	4.993	-0.005
50	346	4.994	4.988	-0.006
50	347	5.016	5.014	-0.003
51	462	5.009	5.004	-0.005
51	478	4.981	5.011	0.030
51	503	5.015	5.002	-0.014
100	354	5.009	5.007	-0.002
100	363	4.996	4.988	-0.008
100	366	4.989	4.983	-0.006
100	383	4.993	4.974	-0.019
100	417	5.003	4.998	-0.004
101	513	4.997	4.992	-0.005
101	526	4.992	4.997	0.005
101	532	5.008	4.985	-0.023
101	533	4.988	4.979	-0.009
101	534	4.985	4.970	-0.016
Max		5.020	5.018	0.030
Average		5.001	4.997	-0.004
Min		4.981	4.970	-0.023
Std Dev		0.011	0.014	0.012

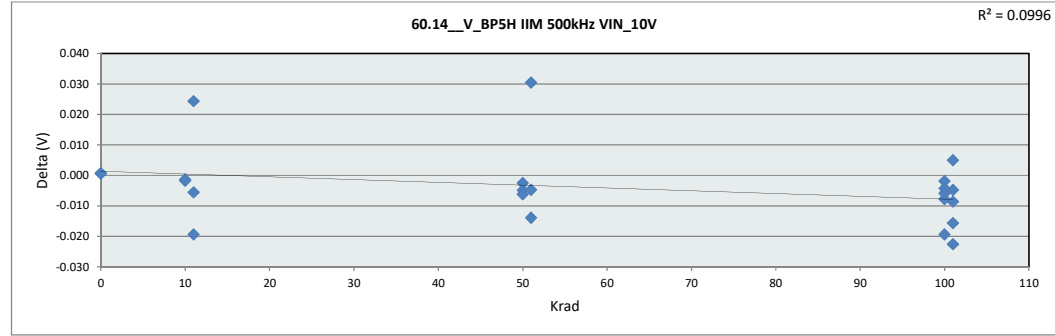

60.14_V_BP5H_IIM_500kHz_V		
Test Site	DAL	
Tester	ETS364	
Test Number	EB672303	
Max Limit	5.175	V
Min Limit	4.75	V

	0	10	11	50	51	100	101
LL	4.750	4.750	4.750	4.750	4.750	4.750	4.750
Min	5.001	4.995	4.988	4.988	5.002	4.974	4.970
Average	5.009	5.008	5.004	4.998	5.005	4.990	4.985
Max	5.017	5.018	5.018	5.018	5.014	5.011	5.007
UL	5.175	5.175	5.175	5.175	5.175	5.175	5.175

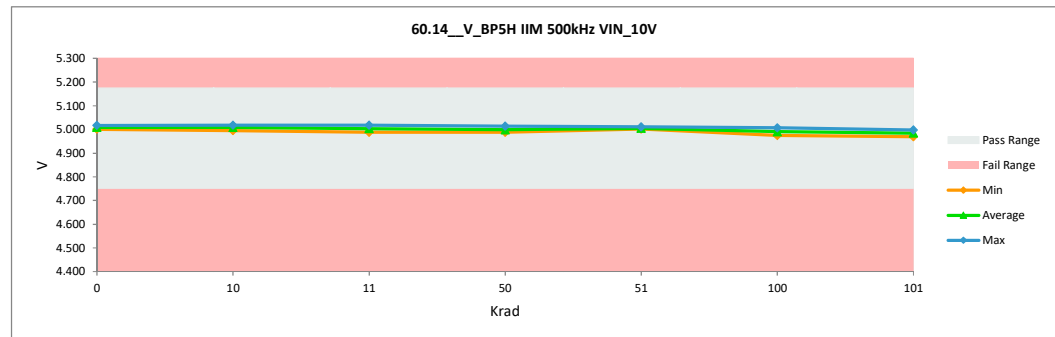

TID "HDR" Report
5962R2220102VXC

60.15_V_BP7L IIM 1MHz VIN		
Test Site	DAL	DAL
Tester	ETS364	ETS364
Test Number	EB672303	EB672303
Unit	V	V
Max Limit	7.35	7.35
Min Limit	6.65	6.65

Krad	Serial #	Pre_HDR_6013	Post_HDR_6013	Delta
0	1	7.022	7.020	-0.002
0	2	6.982	6.981	-0.001
10	182	7.011	7.009	-0.002
10	202	7.031	7.029	-0.003
10	204	7.027	6.983	-0.044
11	418	7.027	7.027	0.000
11	419	7.015	6.993	-0.022
11	443	7.031	7.053	0.022
50	259	7.075	7.066	-0.010
50	346	7.056	7.036	-0.019
50	347	7.016	7.010	-0.007
51	462	7.064	7.011	-0.053
51	478	7.039	6.973	-0.065
51	503	7.044	7.037	-0.007
100	354	7.064	7.099	0.035
100	363	7.072	7.072	0.000
100	366	7.006	6.981	-0.025
100	383	7.037	7.018	-0.018
100	417	7.094	7.120	0.026
101	513	7.057	7.036	-0.021
101	526	7.031	7.000	-0.031
101	532	7.026	7.003	-0.023
101	533	7.014	7.005	-0.008
101	534	7.055	7.033	-0.022
Max		7.094	7.120	0.035
Average		7.037	7.025	-0.012
Min		6.982	6.973	-0.065
Std Dev		0.026	0.037	0.023

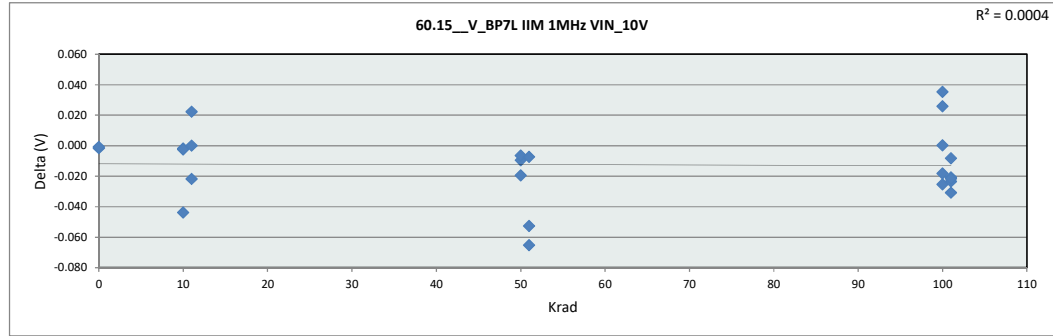

60.15_V_BP7L IIM 1MHz VIN		
Test Site	DAL	
Tester	ETS364	
Test Number	EB672303	
Max Limit	7.35	V
Min Limit	6.65	V

	0	10	11	50	51	100	101
LL	6.650	6.650	6.650	6.650	6.650	6.650	6.650
Min	6.981	6.983	6.993	7.010	6.973	6.981	7.000
Average	7.000	7.007	7.024	7.037	7.007	7.058	7.015
Max	7.020	7.029	7.053	7.066	7.037	7.120	7.036
UL	7.350	7.350	7.350	7.350	7.350	7.350	7.350

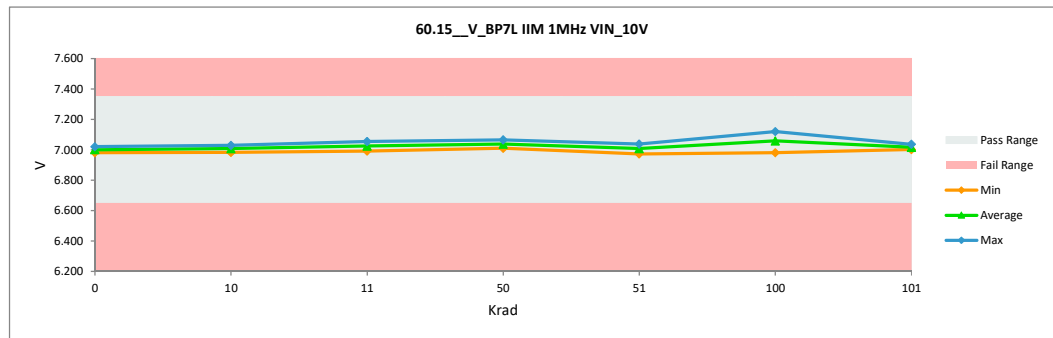

TID "HDR" Report
5962R2220102VXC

60.16_V_BP5L IIM 1MHz VIN		
Test Site	DAL	DAL
Tester	ETS364	ETS364
Test Number	EB672303	EB672303
Unit	V	V
Max Limit	5.175	5.175
Min Limit	4.75	4.75

Krad	Serial #	Pre_HDR_6013	Post_HDR_6013	Delta
0	1	5.021	5.022	0.001
0	2	5.013	5.014	0.001
10	182	4.986	4.986	0.000
10	202	4.992	4.990	-0.002
10	204	5.013	5.016	0.003
11	418	5.014	4.994	-0.021
11	419	5.016	4.999	-0.017
11	443	5.010	4.981	-0.029
50	259	5.000	4.998	-0.002
50	346	4.989	4.981	-0.007
50	347	5.002	5.001	-0.001
51	462	4.998	5.016	0.018
51	478	4.990	4.985	-0.004
51	503	4.993	4.988	-0.004
100	354	5.024	5.013	-0.011
100	363	5.003	5.008	0.005
100	366	4.993	4.991	-0.002
100	383	4.988	4.996	0.008
100	417	4.991	5.008	0.017
101	513	5.009	4.971	-0.037
101	526	5.011	4.987	-0.025
101	532	5.021	4.996	-0.024
101	533	5.004	5.008	0.004
101	534	5.011	4.977	-0.034
Max		5.024	5.022	0.018
Average		5.004	4.997	-0.007
Min		4.986	4.971	-0.037
Std Dev		0.012	0.014	0.015

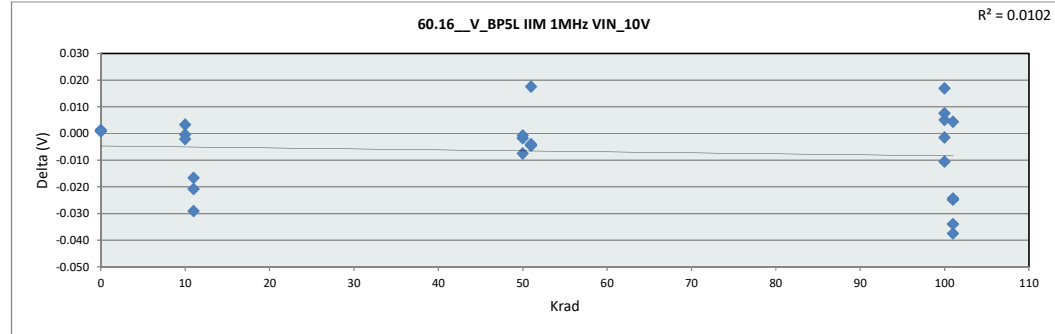

60.16_V_BP5L IIM 1MHz VIN		
Test Site	DAL	
Tester	ETS364	
Test Number	EB672303	
Max Limit	5.175	V
Min Limit	4.75	V

Krad	0	10	11	50	51	100	101
LL	4.750	4.750	4.750	4.750	4.750	4.750	4.750
Min	5.014	4.986	4.981	4.981	4.986	4.992	4.972
Average	5.018	4.997	4.991	4.993	4.996	5.003	4.988
Max	5.022	5.016	4.999	5.001	5.016	5.013	5.008
UL	5.175	5.175	5.175	5.175	5.175	5.175	5.175

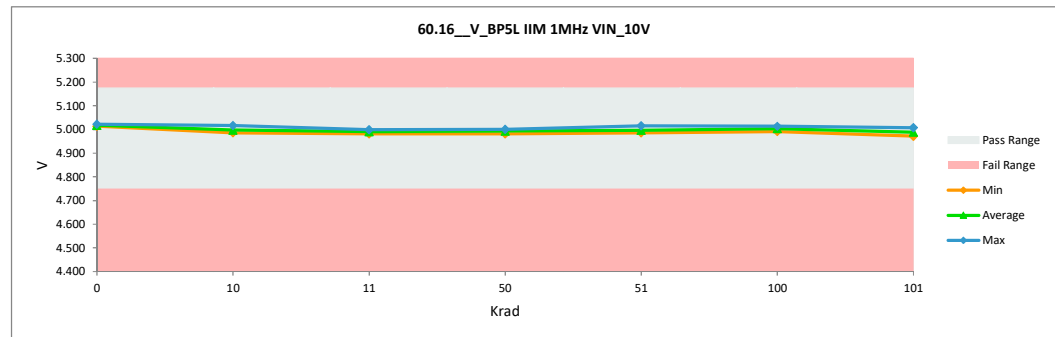

TID "HDR" Report
5962R2220102VXC

60.17_V_BP5H_IIM_1MHz_VIN		
Test Site	DAL	DAL
Tester	ETS364	ETS364
Test Number	EB672303	EB672303
Unit	V	V
Max Limit	5.175	5.175
Min Limit	4.75	4.75

Krad	Serial #	Pre_HDR_6013	Post_HDR_6013	Delta
0	1	5.000	5.001	0.001
0	2	5.017	5.018	0.001
10	182	4.998	4.996	-0.002
10	202	5.013	5.011	-0.001
10	204	5.020	5.019	-0.002
11	418	4.994	5.019	0.024
11	419	5.011	5.005	-0.006
11	443	5.008	4.988	-0.020
50	259	4.998	4.994	-0.005
50	346	4.995	4.988	-0.006
50	347	5.017	5.015	-0.002
51	462	5.009	5.004	-0.005
51	478	4.981	5.011	0.030
51	503	5.016	5.002	-0.014
100	354	5.010	5.007	-0.002
100	363	4.997	4.989	-0.008
100	366	4.989	4.983	-0.006
100	383	4.994	4.975	-0.019
100	417	5.003	4.999	-0.004
101	513	4.997	4.993	-0.004
101	526	4.993	4.998	0.005
101	532	5.008	4.986	-0.023
101	533	4.988	4.979	-0.009
101	534	4.986	4.970	-0.016
Max		5.020	5.019	0.030
Average		5.002	4.998	-0.004
Min		4.981	4.970	-0.023
Std Dev		0.011	0.014	0.012

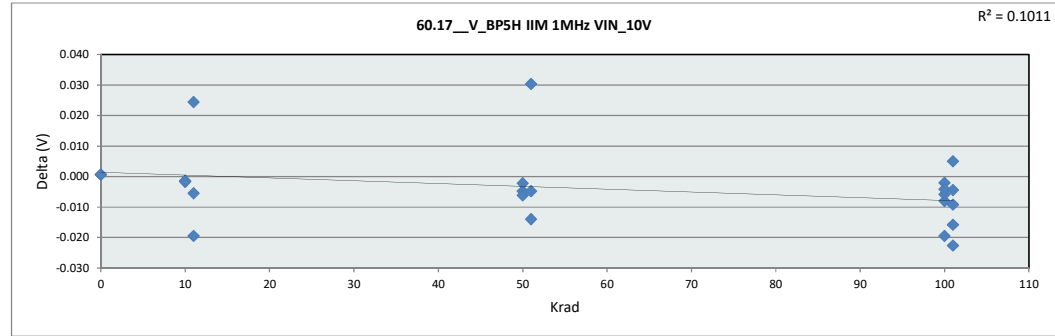

60.17_V_BP5H_IIM_1MHz_VIN		
Test Site	DAL	
Tester	ETS364	
Test Number	EB672303	
Max Limit	5.175	V
Min Limit	4.75	V

	0	10	11	50	51	100	101
LL	4.750	4.750	4.750	4.750	4.750	4.750	4.750
Min	5.001	4.996	4.988	4.988	5.002	4.975	4.970
Average	5.009	5.009	5.004	4.999	5.006	4.991	4.985
Max	5.018	5.019	5.019	5.015	5.011	5.007	4.998
UL	5.175	5.175	5.175	5.175	5.175	5.175	5.175

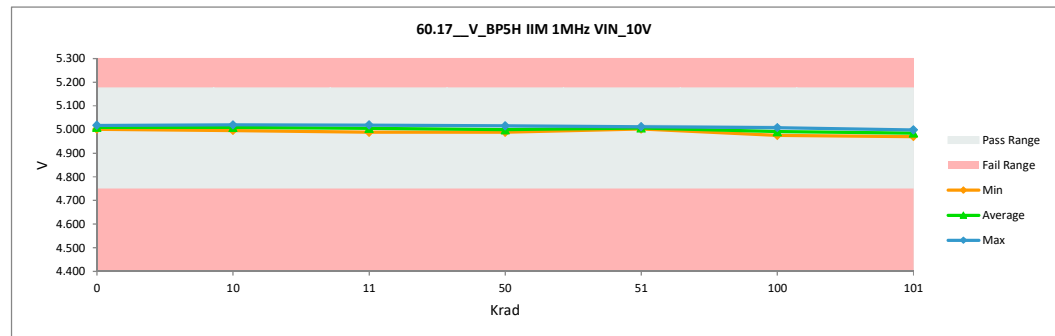

TID "HDR" Report
5962R2220102VXC

60.18_V_BP7L IIM 2MHz VIN		
Test Site	DAL	DAL
Tester	ETS364	ETS364
Test Number	EB672303	EB672303
Unit	V	V
Max Limit	7.35	7.35
Min Limit	6.65	6.65

Krad	Serial #	Pre_HDR_6013	Post_HDR_6013	Delta
0	1	7.013	7.011	-0.002
0	2	6.973	6.972	-0.001
10	182	7.002	7.000	-0.002
10	202	7.023	7.020	-0.003
10	204	7.018	6.973	-0.044
11	418	7.019	7.019	0.000
11	419	7.006	6.984	-0.022
11	443	7.023	7.046	0.023
50	259	7.066	7.057	-0.010
50	346	7.047	7.026	-0.021
50	347	7.007	7.001	-0.006
51	462	7.055	7.002	-0.053
51	478	7.030	6.965	-0.066
51	503	7.036	7.029	-0.008
100	354	7.055	7.091	0.036
100	363	7.063	7.065	0.002
100	366	6.998	6.971	-0.027
100	383	7.028	7.010	-0.018
100	417	7.086	7.111	0.025
101	513	7.048	7.026	-0.021
101	526	7.023	6.991	-0.032
101	532	7.018	6.992	-0.025
101	533	7.005	6.996	-0.009
101	534	7.046	7.023	-0.023
	Max	7.086	7.111	0.036
	Average	7.029	7.016	-0.013
	Min	6.973	6.965	-0.066
	Std Dev	0.026	0.037	0.023

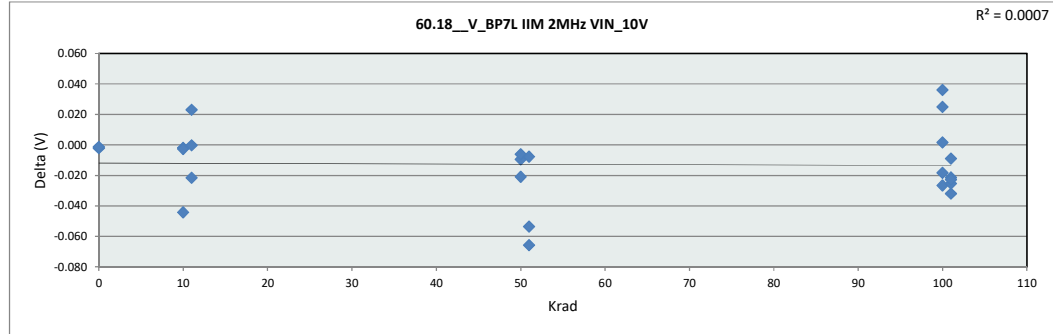

60.18_V_BP7L IIM 2MHz VIN		
Test Site	DAL	
Tester	ETS364	
Test Number	EB672303	
Max Limit	7.35	V
Min Limit	6.65	V

	0	10	11	50	51	100	101
LL	6.650	6.650	6.650	6.650	6.650	6.650	6.650
Min	6.972	6.974	6.984	7.001	6.965	6.971	6.991
Average	6.992	6.998	7.016	7.028	6.998	7.050	7.006
Max	7.011	7.020	7.046	7.057	7.029	7.111	7.026
UL	7.350	7.350	7.350	7.350	7.350	7.350	7.350

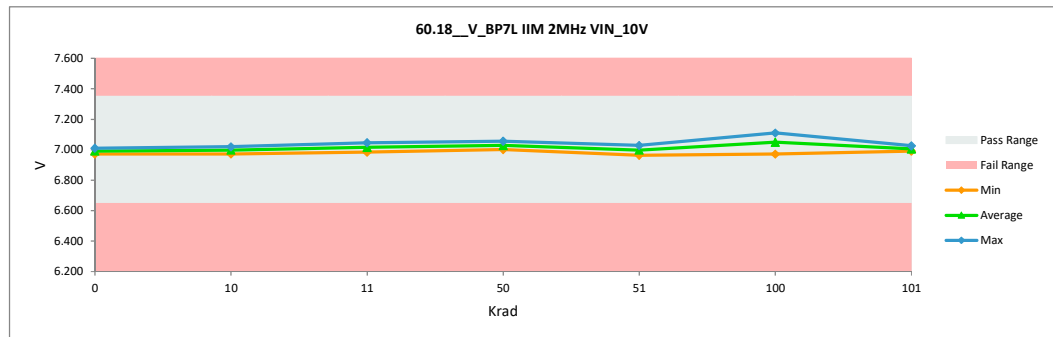

TID "HDR" Report
5962R2220102VXC

60.19_V_BP5L IIM 2MHz VIN		
Test Site	DAL	DAL
Tester	ETS364	ETS364
Test Number	EB672303	EB672303
Unit	V	V
Max Limit	5.175	5.175
Min Limit	4.75	4.75

Krad	Serial #	Pre_HDR_6013	Post_HDR_6013	Delta
0	1	5.024	5.026	0.002
0	2	5.016	5.017	0.001
10	182	4.990	4.990	0.000
10	202	4.995	4.993	-0.002
10	204	5.017	5.021	0.004
11	418	5.017	4.997	-0.020
11	419	5.019	5.003	-0.017
11	443	5.013	4.984	-0.029
50	259	5.004	5.003	-0.001
50	346	4.992	4.985	-0.007
50	347	5.005	5.005	0.000
51	462	5.002	5.020	0.018
51	478	4.993	4.989	-0.003
51	503	4.996	4.992	-0.004
100	354	5.028	5.018	-0.009
100	363	5.007	5.013	0.006
100	366	4.996	4.996	-0.001
100	383	4.992	5.001	0.009
100	417	4.995	5.013	0.018
101	513	5.012	4.975	-0.037
101	526	5.015	4.990	-0.025
101	532	5.024	5.000	-0.024
101	533	5.007	5.012	0.005
101	534	5.015	4.980	-0.034
Max		5.028	5.026	0.018
Average		5.007	5.001	-0.006
Min		4.990	4.975	-0.037
Std Dev		0.012	0.014	0.015

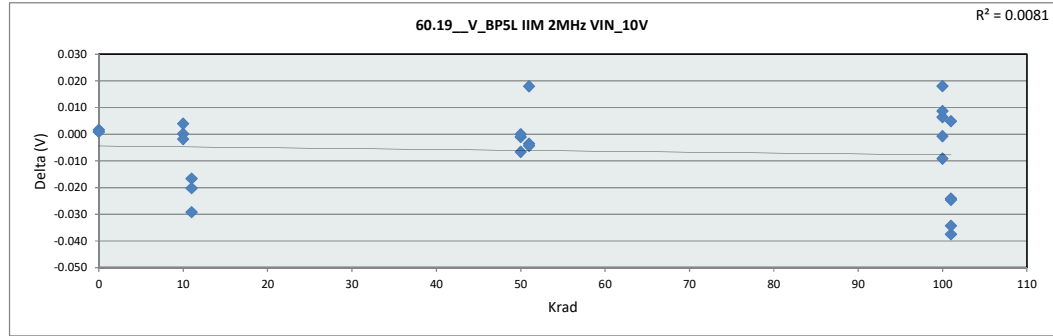

60.19_V_BP5L IIM 2MHz VIN		
Test Site	DAL	
Tester	ETS364	
Test Number	EB672303	
Max Limit	5.175	V
Min Limit	4.75	V

Krad	0	10	11	50	51	100	101
LL	4.750	4.750	4.750	4.750	4.750	4.750	4.750
Min	5.017	4.991	4.984	4.986	4.989	4.996	4.975
Average	5.022	5.002	4.995	4.998	5.000	5.008	4.991
Max	5.026	5.021	5.003	5.005	5.020	5.018	5.012
UL	5.175	5.175	5.175	5.175	5.175	5.175	5.175

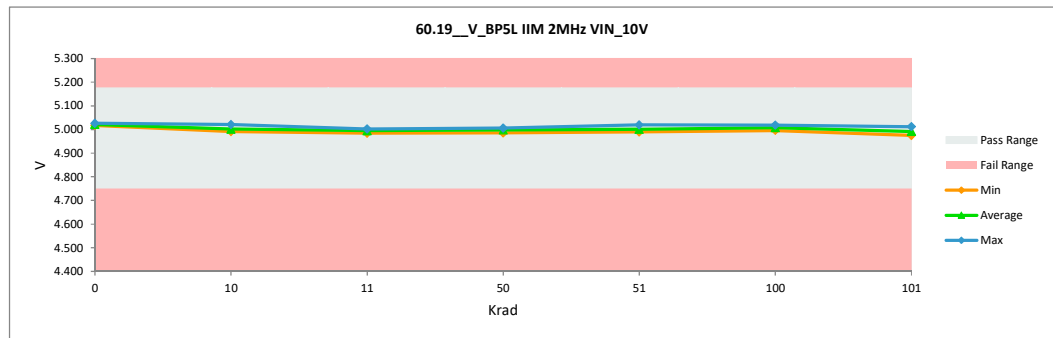

TID "HDR" Report
5962R2220102VXC

60.20_V_BP5H_IIM_2MHz_VIN		
Test Site	DAL	DAL
Tester	ETS364	ETS364
Test Number	EB672303	EB672303
Unit	V	V
Max Limit	5.175	5.175
Min Limit	4.75	4.75

Krad	Serial #	Pre_HDR_6013	Post_HDR_6013	Delta
0	1	5.001	5.002	0.001
0	2	5.018	5.019	0.001
10	182	4.999	4.997	-0.002
10	202	5.014	5.013	-0.001
10	204	5.021	5.020	-0.001
11	418	4.995	5.020	0.025
11	419	5.012	5.006	-0.005
11	443	5.009	4.989	-0.020
50	259	4.999	4.995	-0.005
50	346	4.996	4.990	-0.006
50	347	5.018	5.016	-0.002
51	462	5.010	5.005	-0.005
51	478	4.982	5.012	0.030
51	503	5.017	5.003	-0.014
100	354	5.011	5.008	-0.002
100	363	4.998	4.990	-0.008
100	366	4.990	4.984	-0.006
100	383	4.995	4.976	-0.020
100	417	5.004	5.000	-0.004
101	513	4.998	4.994	-0.005
101	526	4.994	5.000	0.005
101	532	5.009	4.987	-0.023
101	533	4.989	4.980	-0.009
101	534	4.987	4.971	-0.016
	Max	5.021	5.020	0.030
	Average	5.003	4.999	-0.004
	Min	4.982	4.971	-0.023
	Std Dev	0.011	0.014	0.012

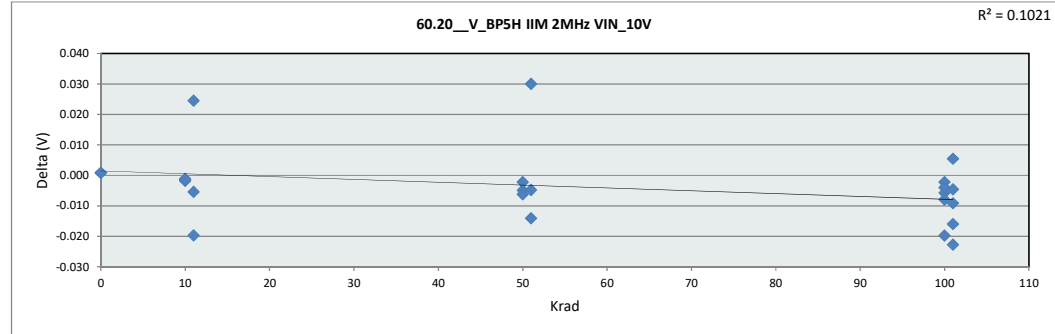

60.20_V_BP5H_IIM_2MHz_VIN		
Test Site	DAL	
Tester	ETS364	
Test Number	EB672303	
Max Limit	5.175	V
Min Limit	4.75	V

	0	10	11	50	51	100	101
LL	4.750	4.750	4.750	4.750	4.750	4.750	4.750
Min	5.002	4.997	4.989	4.990	5.003	4.976	4.971
Average	5.011	5.010	5.005	5.000	5.007	4.992	4.986
Max	5.019	5.020	5.020	5.016	5.012	5.008	5.000
UL	5.175	5.175	5.175	5.175	5.175	5.175	5.175

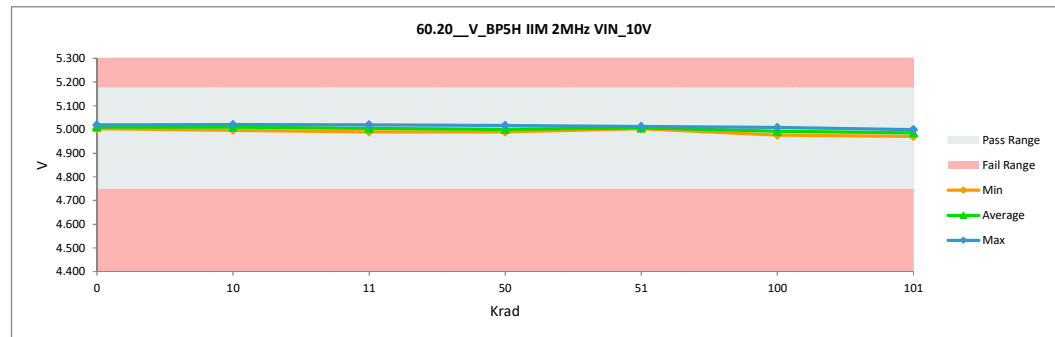

TID "HDR" Report
5962R2220102VXC

60.21_V_BP7L IIM 5MHz VIN		
Test Site	DAL	DAL
Tester	ETS364	ETS364
Test Number	EB672303	EB672303
Unit	V	V
Max Limit	7.35	7.35
Min Limit	6.65	6.65

Krad	Serial #	Pre_HDR_6013	Post_HDR_6013	Delta
0	1	6.988	6.984	-0.004
0	2	6.949	6.947	-0.002
10	182	6.976	6.974	-0.002
10	202	6.997	6.994	-0.002
10	204	6.992	6.948	-0.044
11	418	6.995	6.995	0.000
11	419	6.981	6.960	-0.021
11	443	6.998	7.022	0.024
50	259	7.040	7.031	-0.009
50	346	7.021	6.999	-0.022
50	347	6.982	6.977	-0.005
51	462	7.030	6.976	-0.054
51	478	7.006	6.938	-0.067
51	503	7.013	7.004	-0.009
100	354	7.030	7.066	0.036
100	363	7.037	7.043	0.005
100	366	6.973	6.947	-0.026
100	383	7.004	6.985	-0.019
100	417	7.063	7.085	0.022
101	513	7.021	6.998	-0.023
101	526	7.001	6.967	-0.034
101	532	6.993	6.965	-0.029
101	533	6.980	6.968	-0.011
101	534	7.021	6.997	-0.024
Max		7.063	7.085	0.036
Average		7.004	6.990	-0.013
Min		6.949	6.938	-0.067
Std Dev		0.026	0.037	0.024

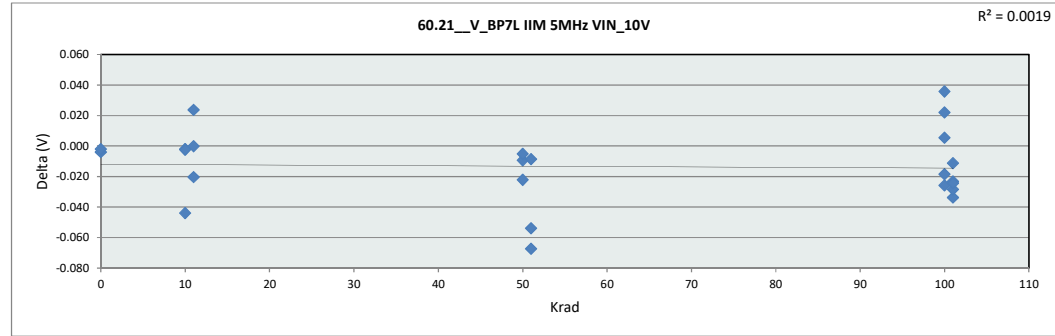

60.21_V_BP7L IIM 5MHz VIN		
Test Site	DAL	
Tester	ETS364	
Test Number	EB672303	
Max Limit	7.35	V
Min Limit	6.65	V

	0	10	11	50	51	100	101
LL	6.650	6.650	6.650	6.650	6.650	6.650	6.650
Min	6.947	6.948	6.960	6.977	6.938	6.947	6.965
Average	6.966	6.972	6.992	7.002	6.973	7.025	6.979
Max	6.984	6.994	7.022	7.031	7.004	7.085	6.998
UL	7.350	7.350	7.350	7.350	7.350	7.350	7.350

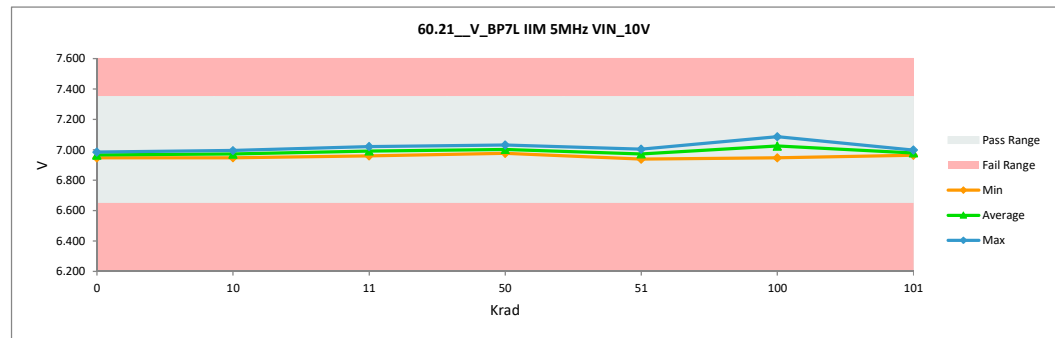

TID "HDR" Report
5962R2220102VXC

60.22_V_BP5L IIM 5MHz VIN		
Test Site	DAL	DAL
Tester	ETS364	ETS364
Test Number	EB672303	EB672303
Unit	V	V
Max Limit	5.175	5.175
Min Limit	4.75	4.75

Krad	Serial #	Pre_HDR_6013	Post_HDR_6013	Delta
0	1	5.037	5.040	0.003
0	2	5.029	5.031	0.002
10	182	5.005	5.007	0.002
10	202	5.007	5.006	-0.001
10	204	5.030	5.037	0.007
11	418	5.030	5.011	-0.018
11	419	5.032	5.016	-0.016
11	443	5.026	4.995	-0.031
50	259	5.017	5.019	0.002
50	346	5.005	5.001	-0.003
50	347	5.018	5.022	0.004
51	462	5.015	5.034	0.019
51	478	5.004	5.002	-0.002
51	503	5.009	5.005	-0.004
100	354	5.041	5.037	-0.004
100	363	5.019	5.028	0.009
100	366	5.008	5.010	0.002
100	383	5.006	5.019	0.013
100	417	5.008	5.030	0.022
101	513	5.024	4.986	-0.038
101	526	5.028	5.004	-0.024
101	532	5.036	5.013	-0.024
101	533	5.020	5.028	0.008
101	534	5.027	4.992	-0.035
Max		5.041	5.040	0.022
Average		5.020	5.016	-0.005
Min		5.004	4.986	-0.038
Std Dev		0.012	0.015	0.016

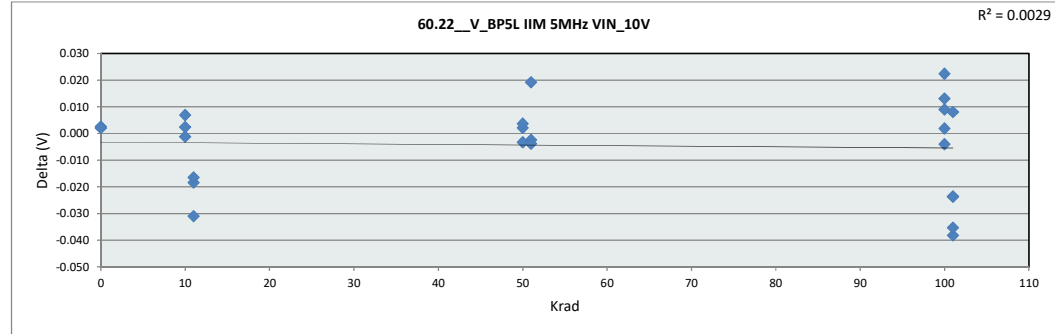

60.22_V_BP5L IIM 5MHz VIN		
Test Site	DAL	
Tester	ETS364	
Test Number	EB672303	
Max Limit	5.175	V
Min Limit	4.75	V

Krad	0	10	11	50	51	100	101
LL	4.750	4.750	4.750	4.750	4.750	4.750	4.750
Min	5.031	5.006	4.995	5.001	5.002	5.010	4.986
Average	5.035	5.017	5.007	5.014	5.014	5.025	5.005
Max	5.040	5.037	5.016	5.022	5.034	5.037	5.028
UL	5.175	5.175	5.175	5.175	5.175	5.175	5.175

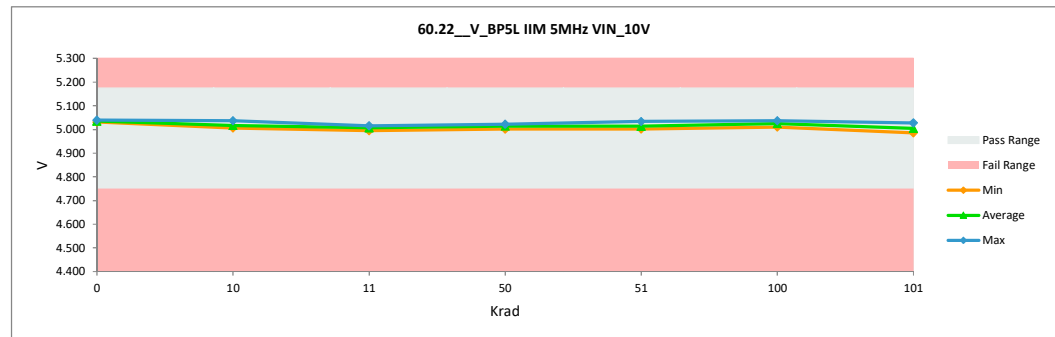

TID "HDR" Report
5962R2220102VXC

60.23_V_BP5H_IIM_5MHz_VIN		
Test Site	DAL	DAL
Tester	ETS364	ETS364
Test Number	EB672303	EB672303
Unit	V	V
Max Limit	5.175	5.175
Min Limit	4.75	4.75

Krad	Serial #	Pre_HDR_6013	Post_HDR_6013	Delta
0	1	5.005	5.006	0.001
0	2	5.022	5.023	0.001
10	182	5.003	5.001	-0.002
10	202	5.018	5.016	-0.001
10	204	5.025	5.024	-0.002
11	418	4.998	5.024	0.025
11	419	5.016	5.011	-0.005
11	443	5.013	4.992	-0.020
50	259	5.003	4.998	-0.005
50	346	5.000	4.994	-0.006
50	347	5.022	5.020	-0.002
51	462	5.014	5.009	-0.005
51	478	4.986	5.016	0.030
51	503	5.021	5.006	-0.015
100	354	5.014	5.012	-0.002
100	363	5.001	4.993	-0.008
100	366	4.994	4.988	-0.005
100	383	4.999	4.978	-0.021
100	417	5.008	5.004	-0.004
101	513	5.002	4.997	-0.004
101	526	4.998	5.005	0.007
101	532	5.013	4.990	-0.023
101	533	4.993	4.984	-0.009
101	534	4.991	4.974	-0.017
Max		5.025	5.024	0.030
Average		5.007	5.003	-0.004
Min		4.986	4.974	-0.023
Std Dev		0.011	0.014	0.012

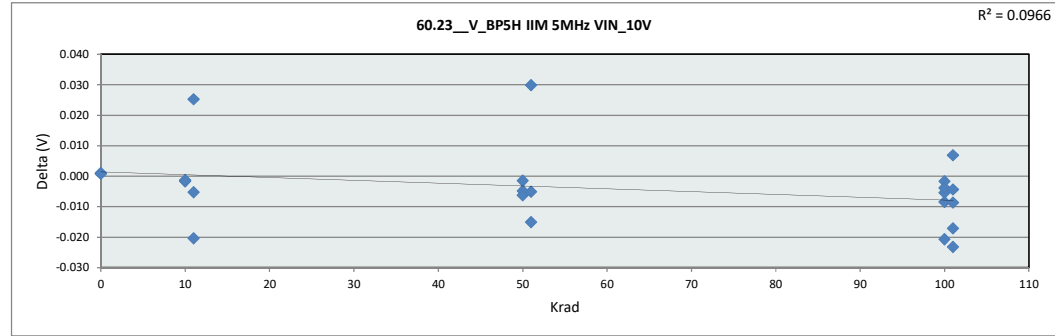

60.23_V_BP5H_IIM_5MHz_VIN		
Test Site	DAL	DAL
Tester	ETS364	ETS364
Test Number	EB672303	EB672303
Max Limit	5.175	5.175
Min Limit	4.75	4.75

Krad	0	10	11	50	51	100	101
LL	4.750	4.750	4.750	4.750	4.750	4.750	4.750
Min	5.006	5.001	4.993	4.994	5.006	4.978	4.974
Average	5.014	5.014	5.009	5.004	5.010	4.995	4.990
Max	5.023	5.024	5.024	5.020	5.016	5.012	5.005
UL	5.175	5.175	5.175	5.175	5.175	5.175	5.175

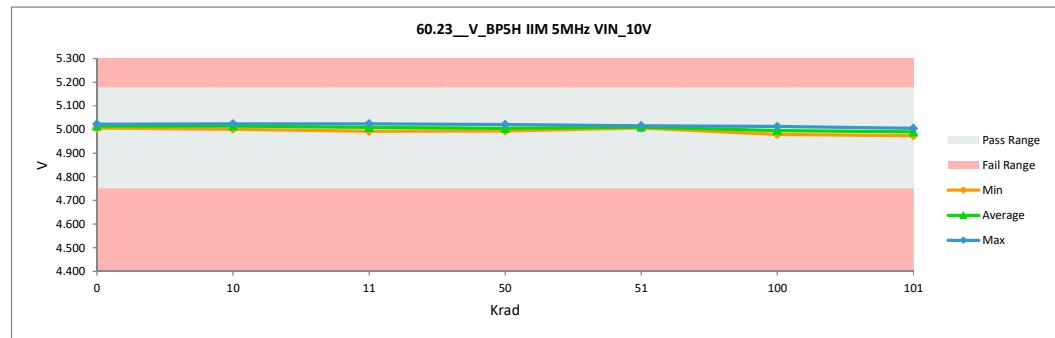

TID "HDR" Report 5962R2220102VXC

		61.0	V_BP7L PWM 500kHz VIN
Test Site		DAL	DAL
Tester		ETS364	ETS364
Test Number		EB672303	EB672303
Unit		V	V
Max Limit		7.35	7.35
Min Limit		6.65	6.65

Krad	Serial #	Pre_HDR_6013	Post_HDR_6013	Delta
0	1	7.027	7.025	-0.001
0	2	6.987	6.986	-0.001
10	182	7.016	7.015	-0.002
10	202	7.037	7.034	-0.003
10	204	7.032	6.988	-0.044
11	418	7.032	7.032	0.000
11	419	7.020	6.998	-0.022
11	443	7.036	7.058	0.022
50	259	7.081	7.071	-0.010
50	346	7.061	7.043	-0.018
50	347	7.021	7.014	-0.007
51	462	7.069	7.016	-0.053
51	478	7.044	6.979	-0.065
51	503	7.049	7.042	-0.008
100	354	7.069	7.103	0.035
100	363	7.077	7.076	-0.002
100	366	7.011	6.987	-0.024
100	383	7.042	7.023	-0.018
100	417	7.099	7.125	0.026
101	513	7.062	7.042	-0.020
101	526	7.036	7.005	-0.030
101	532	7.031	7.009	-0.022
101	533	7.019	7.011	-0.008
101	534	7.060	7.038	-0.021
Max		7.099	7.125	0.035
Average		7.042	7.030	-0.012
Min		6.987	6.979	-0.065
Std Dev		0.026	0.037	0.023

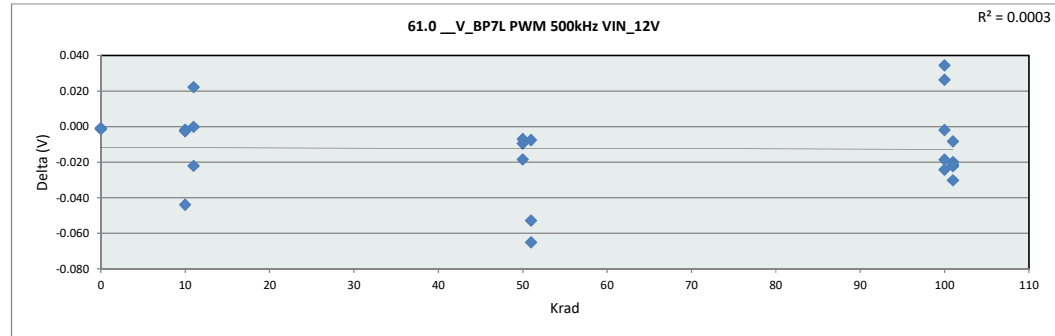

		61.0	V_BP7L PWM 500kHz V
Test Site		DAL	
Tester		ETS364	
Test Number		EB672303	
Max Limit		7.35	V
Min Limit		6.65	V

Krad	0	10	11	50	51	100	101
LL	6.650	6.650	6.650	6.650	6.650	6.650	6.650
Min	6.986	6.988	6.998	7.014	6.979	6.987	7.005
Average	7.006	7.012	7.029	7.043	7.012	7.063	7.021
Max	7.025	7.034	7.059	7.071	7.042	7.125	7.042
UL	7.350	7.350	7.350	7.350	7.350	7.350	7.350

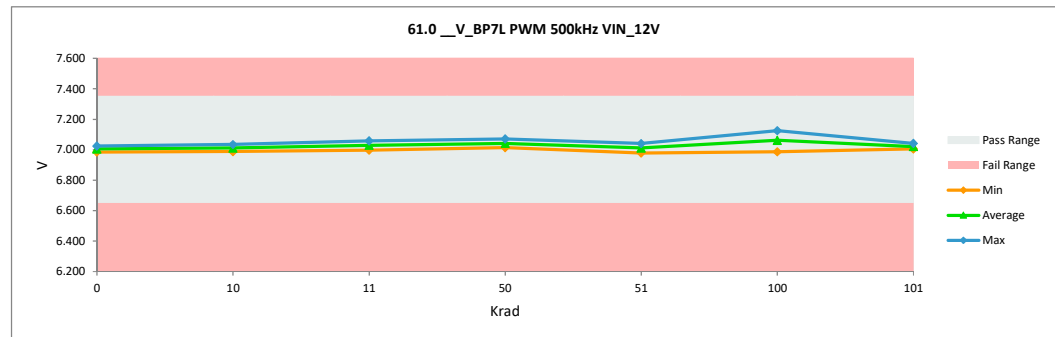

TID "HDR" Report 5962R2220102VXC

61.1 __V_BP5L PWM 500kHz VIN		
Test Site	DAL	DAL
Tester	ETS364	ETS364
Test Number	EB672303	EB672303
Unit	V	V
Max Limit	5.175	5.175
Min Limit	4.75	4.75

Krad	Serial #	Pre_HDR_6013	Post_HDR_6013	Delta
0	1	5.019	5.021	0.001
0	2	5.011	5.012	0.001
10	182	4.985	4.984	0.000
10	202	4.991	4.988	-0.002
10	204	5.012	5.015	0.003
11	418	5.013	4.992	-0.021
11	419	5.014	4.997	-0.017
11	443	5.009	4.979	-0.029
50	259	4.999	4.997	-0.002
50	346	4.987	4.979	-0.008
50	347	5.000	4.999	-0.002
51	462	4.997	5.014	0.018
51	478	4.988	4.984	-0.004
51	503	4.991	4.987	-0.005
100	354	5.022	5.011	-0.011
100	363	5.002	5.007	0.005
100	366	4.992	4.990	-0.002
100	383	4.986	4.993	0.007
100	417	4.990	5.006	0.016
101	513	5.008	4.971	-0.037
101	526	5.010	4.986	-0.024
101	532	5.019	4.995	-0.025
101	533	5.002	5.007	0.004
101	534	5.010	4.976	-0.034
Max		5.022	5.021	0.018
Average		5.002	4.995	-0.007
Min		4.985	4.971	-0.037
Std Dev		0.012	0.014	0.015

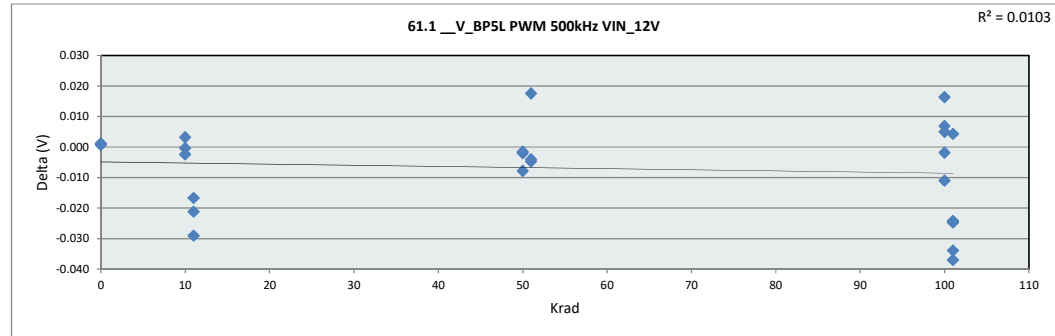

61.1 __V_BP5L PWM 500kHz V		
Test Site	DAL	
Tester	ETS364	
Test Number	EB672303	
Max Limit	5.175	V
Min Limit	4.75	V

	0	10	11	50	51	100	101
LL	4.750	4.750	4.750	4.750	4.750	4.750	4.750
Min	5.012	4.984	4.980	4.979	4.984	4.990	4.971
Average	5.016	4.996	4.990	4.992	4.995	5.002	4.987
Max	5.021	5.015	4.998	4.999	5.014	5.011	5.007
UL	5.175	5.175	5.175	5.175	5.175	5.175	5.175

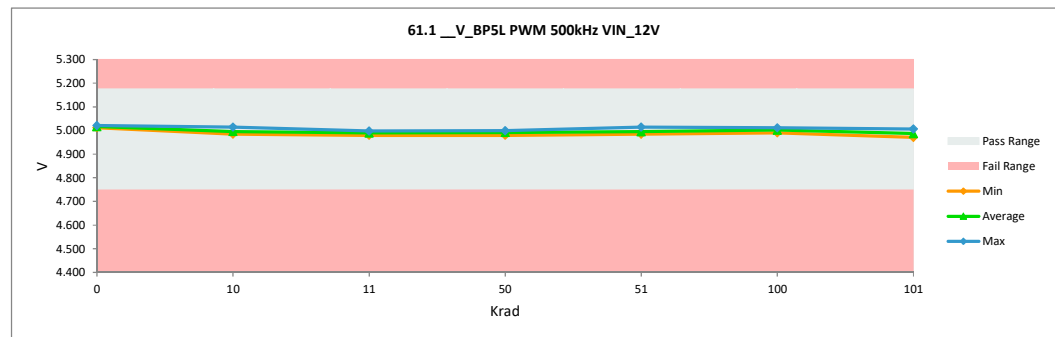

TID "HDR" Report
5962R2220102VXC

61.2 __V_BP5H PWM 500kHz VI		
Test Site	DAL	DAL
Tester	ETS364	ETS364
Test Number	EB672303	EB672303
Unit	V	V
Max Limit	5.175	5.175
Min Limit	4.75	4.75

Krad	Serial #	Pre_HDR_6013	Post_HDR_6013	Delta
0	1	5.000	5.001	0.001
0	2	5.017	5.017	0.001
10	182	4.997	4.995	-0.002
10	202	5.012	5.011	-0.001
10	204	5.020	5.018	-0.002
11	418	4.994	5.018	0.024
11	419	5.010	5.005	-0.005
11	443	5.008	4.988	-0.019
50	259	4.998	4.993	-0.005
50	346	4.994	4.988	-0.006
50	347	5.016	5.014	-0.002
51	462	5.009	5.004	-0.005
51	478	4.981	5.011	0.030
51	503	5.015	5.002	-0.014
100	354	5.009	5.007	-0.002
100	363	4.996	4.988	-0.008
100	366	4.989	4.983	-0.006
100	383	4.994	4.974	-0.019
100	417	5.003	4.998	-0.004
101	513	4.997	4.992	-0.005
101	526	4.992	4.997	0.004
101	532	5.008	4.985	-0.023
101	533	4.988	4.979	-0.009
101	534	4.985	4.970	-0.016
	Max	5.020	5.018	0.030
	Average	5.001	4.997	-0.004
	Min	4.981	4.970	-0.023
	Std Dev	0.011	0.014	0.012

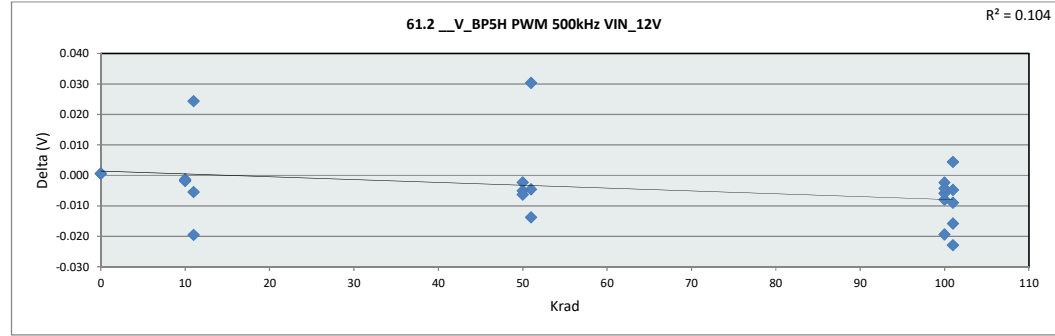

61.2 __V_BP5H PWM 500kHz		
Test Site	DAL	
Tester	ETS364	
Test Number	EB672303	
Max Limit	5.175	V
Min Limit	4.75	V

	0	10	11	50	51	100	101
LL	4.750	4.750	4.750	4.750	4.750	4.750	4.750
Min	5.001	4.995	4.988	4.988	5.002	4.974	4.970
Average	5.009	5.008	5.004	4.998	5.005	4.990	4.985
Max	5.017	5.018	5.018	5.018	5.014	5.007	4.997
UL	5.175	5.175	5.175	5.175	5.175	5.175	5.175

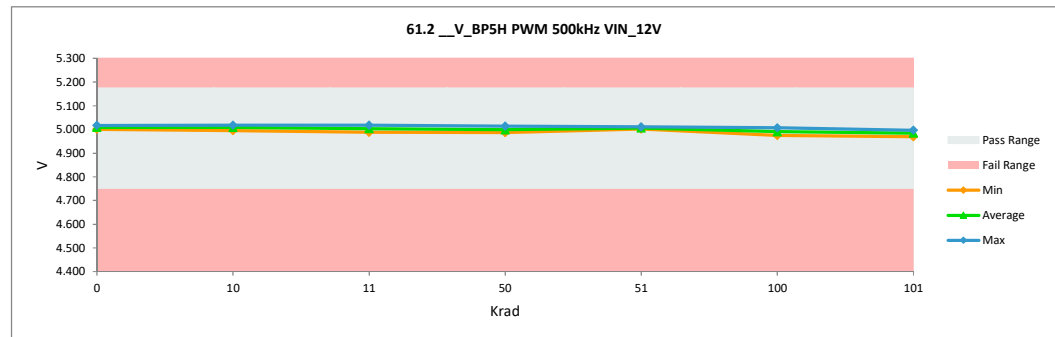

TID "HDR" Report
5962R2220102VXC

61.3 V_BP7L PWM 1MHz VIN		
Test Site	DAL	DAL
Tester	ETS364	ETS364
Test Number	EB672303	EB672303
Unit	V	V
Max Limit	7.35	7.35
Min Limit	6.65	6.65

Krad	Serial #	Pre_HDR_6013	Post_HDR_6013	Delta
0	1	7.023	7.021	-0.002
0	2	6.983	6.982	-0.001
10	182	7.012	7.010	-0.002
10	202	7.033	7.030	-0.003
10	204	7.028	6.984	-0.044
11	418	7.028	7.028	0.000
11	419	7.016	6.994	-0.022
11	443	7.032	7.055	0.022
50	259	7.076	7.067	-0.010
50	346	7.057	7.037	-0.019
50	347	7.017	7.011	-0.007
51	462	7.065	7.012	-0.053
51	478	7.040	6.975	-0.065
51	503	7.045	7.038	-0.008
100	354	7.065	7.100	0.035
100	363	7.073	7.072	-0.001
100	366	7.007	6.983	-0.025
100	383	7.038	7.019	-0.018
100	417	7.095	7.121	0.026
101	513	7.058	7.037	-0.020
101	526	7.032	7.001	-0.031
101	532	7.027	7.004	-0.023
101	533	7.015	7.006	-0.009
101	534	7.056	7.034	-0.022
Max		7.095	7.121	0.035
Average		7.038	7.026	-0.012
Min		6.983	6.975	-0.065
Std Dev		0.026	0.037	0.023

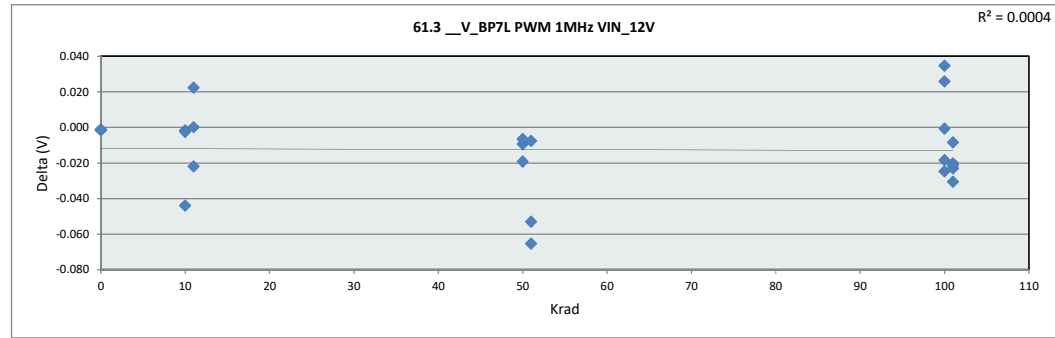

61.3 V_BP7L PWM 1MHz VIN		
Test Site	DAL	
Tester	ETS364	
Test Number	EB672303	
Max Limit	7.35	V
Min Limit	6.65	V

Krad	0	10	11	50	51	100	101
LL	6.650	6.650	6.650	6.650	6.650	6.650	6.650
Min	6.982	6.984	6.994	7.011	6.975	6.983	7.001
Average	7.002	7.008	7.026	7.038	7.008	7.059	7.017
Max	7.021	7.030	7.055	7.067	7.038	7.121	7.037
UL	7.350	7.350	7.350	7.350	7.350	7.350	7.350

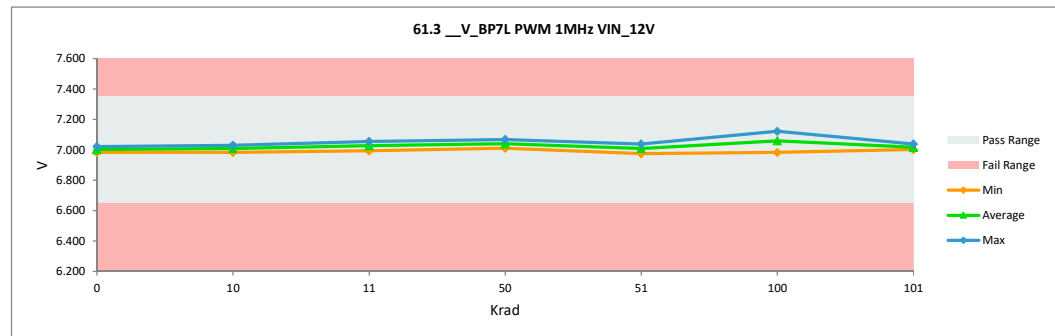

TID "HDR" Report
5962R2220102VXC

61.4 V_BP5L PWM 1MHz VIN		
Test Site	DAL	
Tester	ETS364	
Test Number	EB672303	EB672303
Unit	V	
Max Limit	5.175	5.175
Min Limit	4.75	4.75

Krad	Serial #	Pre_HDR_6013	Post_HDR_6013	Delta
0	1	5.021	5.023	0.001
0	2	5.013	5.014	0.001
10	182	4.987	4.987	0.000
10	202	4.993	4.991	-0.002
10	204	5.014	5.017	0.003
11	418	5.015	4.994	-0.021
11	419	5.016	4.999	-0.017
11	443	5.011	4.981	-0.029
50	259	5.001	4.999	-0.002
50	346	4.989	4.982	-0.007
50	347	5.003	5.002	-0.001
51	462	4.999	5.017	0.018
51	478	4.990	4.986	-0.004
51	503	4.993	4.989	-0.004
100	354	5.024	5.014	-0.010
100	363	5.004	5.010	0.006
100	366	4.994	4.993	-0.001
100	383	4.989	4.996	0.008
100	417	4.992	5.009	0.017
101	513	5.010	4.972	-0.037
101	526	5.012	4.987	-0.025
101	532	5.022	4.997	-0.024
101	533	5.004	5.009	0.005
101	534	5.012	4.978	-0.034
	Max	5.024	5.023	0.018
	Average	5.005	4.998	-0.007
	Min	4.987	4.972	-0.037
	Std Dev	0.012	0.014	0.015

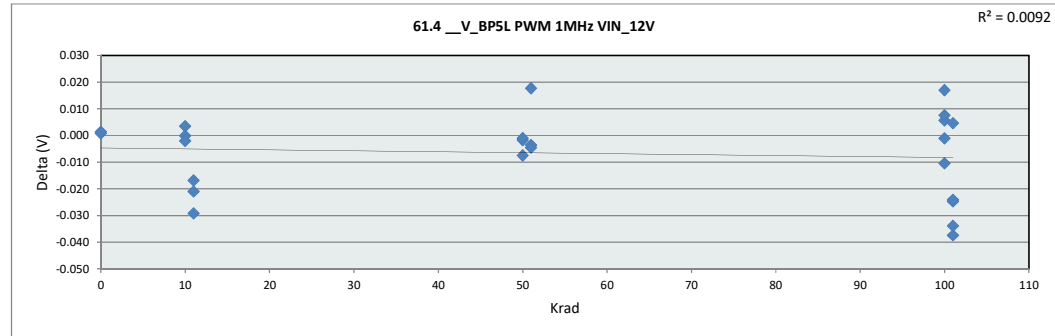

61.4 V_BP5L PWM 1MHz VIN		
Test Site	DAL	
Tester	ETS364	
Test Number	EB672303	
Max Limit	5.175	
Min Limit	4.75	

Krad	0	10	11	50	51	100	101
LL	4.750	4.750	4.750	4.750	4.750	4.750	4.750
Min	5.014	4.987	4.981	4.982	4.987	4.993	4.972
Average	5.019	4.998	4.992	4.994	4.997	5.004	4.989
Max	5.023	5.017	5.000	5.002	5.017	5.014	5.009
UL	5.175	5.175	5.175	5.175	5.175	5.175	5.175

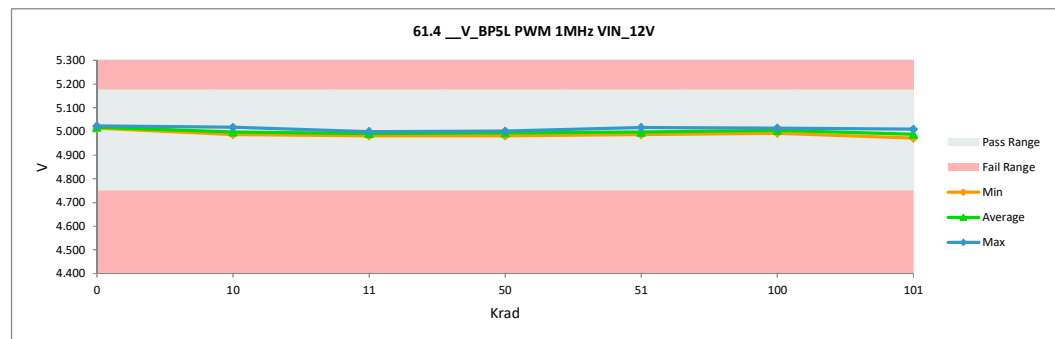

TID "HDR" Report
5962R2220102VXC

61.5_V_BP5H PWM 1MHz VIN		
Test Site	DAL	DAL
Tester	ETS364	ETS364
Test Number	EB672303	EB672303
Unit	V	V
Max Limit	5.175	5.175
Min Limit	4.75	4.75

Krad	Serial #	Pre_HDR_6013	Post_HDR_6013	Delta
0	1	5.001	5.001	0.001
0	2	5.017	5.018	0.001
10	182	4.998	4.996	-0.002
10	202	5.013	5.012	-0.001
10	204	5.020	5.019	-0.002
11	418	4.995	5.019	0.024
11	419	5.011	5.005	-0.006
11	443	5.008	4.989	-0.020
50	259	4.999	4.994	-0.005
50	346	4.995	4.988	-0.006
50	347	5.017	5.015	-0.002
51	462	5.009	5.005	-0.004
51	478	4.981	5.011	0.030
51	503	5.016	5.002	-0.014
100	354	5.010	5.007	-0.002
100	363	4.997	4.989	-0.008
100	366	4.990	4.984	-0.006
100	383	4.994	4.975	-0.020
100	417	5.003	4.999	-0.004
101	513	4.997	4.992	-0.005
101	526	4.993	4.998	0.005
101	532	5.009	4.986	-0.023
101	533	4.988	4.979	-0.009
101	534	4.986	4.970	-0.016
Max		5.020	5.019	0.030
Average		5.002	4.998	-0.004
Min		4.981	4.970	-0.023
Std Dev		0.011	0.014	0.012

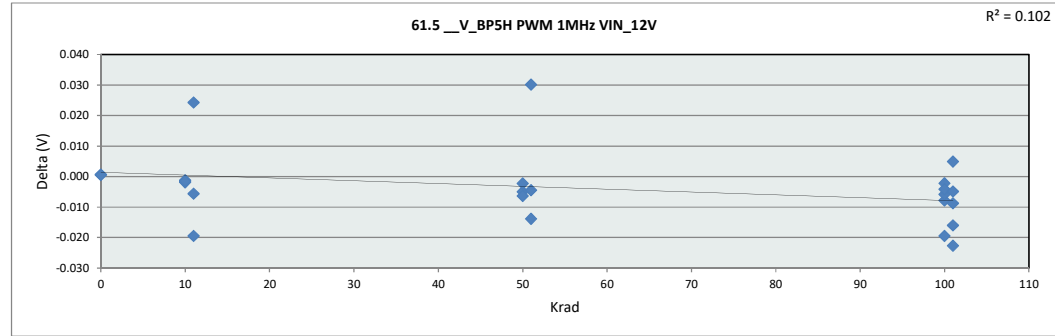

61.5_V_BP5H PWM 1MHz VI		
Test Site	DAL	
Tester	ETS364	
Test Number	EB672303	
Max Limit	5.175	V
Min Limit	4.75	V

Krad	0	10	11	50	51	100	101
LL	4.750	4.750	4.750	4.750	4.750	4.750	4.750
Min	5.001	4.996	4.989	4.988	5.002	4.975	4.970
Average	5.010	5.009	5.004	4.999	5.006	4.991	4.985
Max	5.018	5.019	5.019	5.015	5.011	5.007	4.998
UL	5.175	5.175	5.175	5.175	5.175	5.175	5.175

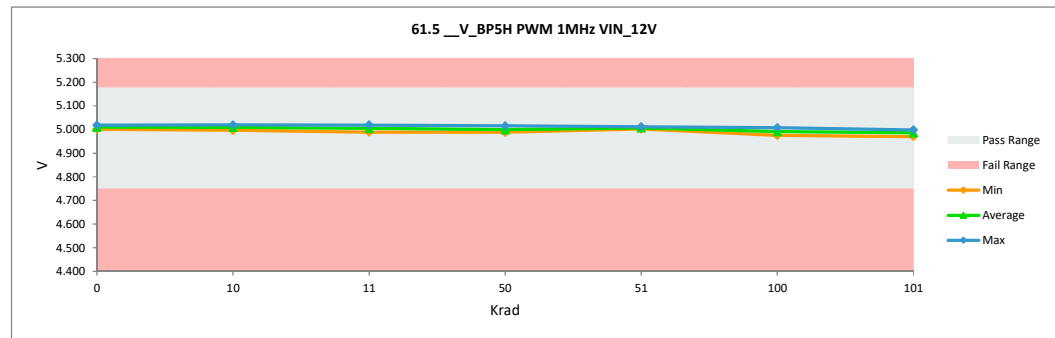

TID "HDR" Report
5962R2220102VXC

		61.6_V_BP7L PWM 2MHz VIN	DAL
Test Site		DAL	DAL
Tester		ETS364	ETS364
Test Number		EB672303	EB672303
Unit		V	V
Max Limit		7.35	7.35
Min Limit		6.65	6.65

Krad	Serial #	Pre_HDR_6013	Post_HDR_6013	Delta
0	1	7.015	7.013	-0.002
0	2	6.975	6.974	-0.001
10	182	7.004	7.003	-0.001
10	202	7.025	7.022	-0.002
10	204	7.020	6.976	-0.044
11	418	7.021	7.021	0.000
11	419	7.008	6.986	-0.022
11	443	7.025	7.048	0.023
50	259	7.068	7.059	-0.009
50	346	7.049	7.029	-0.020
50	347	7.010	7.003	-0.006
51	462	7.057	7.004	-0.053
51	478	7.033	6.967	-0.066
51	503	7.038	7.031	-0.008
100	354	7.057	7.093	0.036
100	363	7.065	7.066	0.001
100	366	7.000	6.974	-0.026
100	383	7.030	7.012	-0.018
100	417	7.088	7.113	0.025
101	513	7.050	7.029	-0.021
101	526	7.025	6.993	-0.032
101	532	7.020	6.995	-0.025
101	533	7.007	6.998	-0.009
101	534	7.048	7.026	-0.022
Max		7.088	7.113	0.036
Average		7.031	7.018	-0.013
Min		6.975	6.967	-0.066
Std Dev		0.026	0.037	0.023

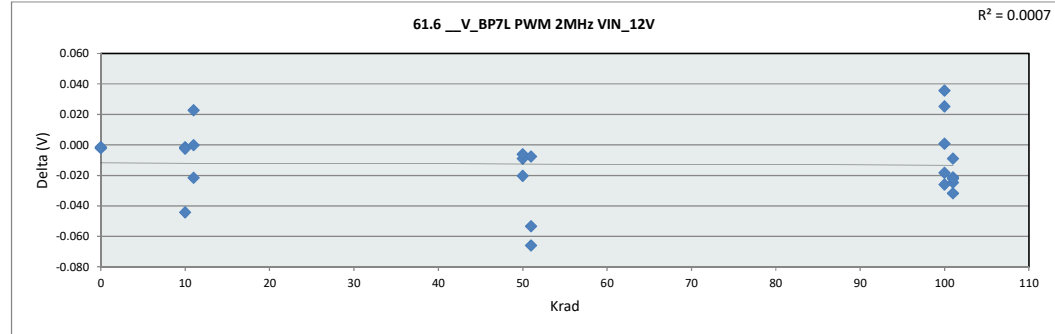

		61.6_V_BP7L PWM 2MHz VIN	DAL
Test Site		DAL	DAL
Tester		ETS364	ETS364
Test Number		EB672303	EB672303
Max Limit		7.35	V
Min Limit		6.65	V

Krad	0	10	11	50	51	100	101
LL	6.650	6.650	6.650	6.650	6.650	6.650	6.650
Min	6.974	6.976	6.986	7.004	6.967	6.974	6.993
Average	6.994	7.000	7.018	7.031	7.000	7.052	7.008
Max	7.013	7.022	7.048	7.059	7.031	7.113	7.029
UL	7.350	7.350	7.350	7.350	7.350	7.350	7.350

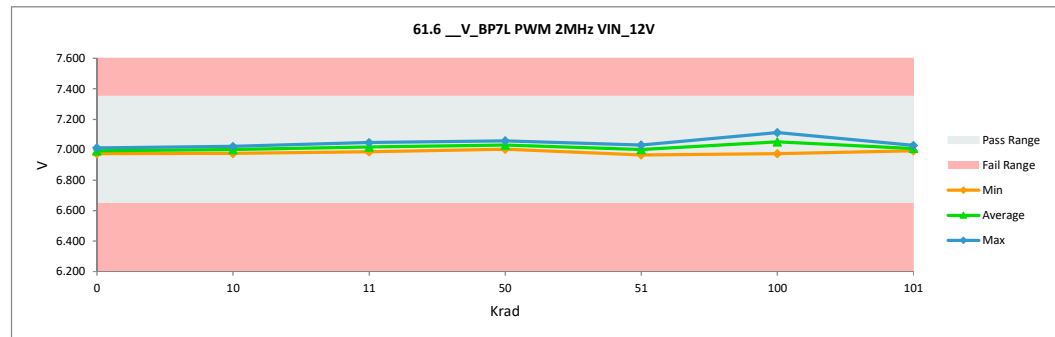

TID "HDR" Report
5962R2220102VXC

61.7 V_BP5L PWM 2MHz VIN		
Test Site	DAL	DAL
Tester	ETS364	ETS364
Test Number	EB672303	EB672303
Unit	V	V
Max Limit	5.175	5.175
Min Limit	4.75	4.75

Krad	Serial #	Pre_HDR_6013	Post_HDR_6013	Delta
0	1	5.026	5.027	0.002
0	2	5.018	5.019	0.001
10	182	4.992	4.992	0.000
10	202	4.997	4.995	-0.002
10	204	5.018	5.023	0.004
11	418	5.019	4.999	-0.020
11	419	5.021	5.004	-0.017
11	443	5.015	4.985	-0.030
50	259	5.005	5.005	-0.001
50	346	4.994	4.988	-0.006
50	347	5.007	5.007	0.000
51	462	5.003	5.022	0.018
51	478	4.994	4.991	-0.003
51	503	4.998	4.993	-0.004
100	354	5.029	5.020	-0.009
100	363	5.009	5.015	0.006
100	366	4.998	4.997	0.000
100	383	4.993	5.003	0.009
100	417	4.997	5.015	0.018
101	513	5.014	4.976	-0.037
101	526	5.016	4.992	-0.024
101	532	5.026	5.002	-0.024
101	533	5.009	5.015	0.006
101	534	5.016	4.982	-0.034
	Max	5.029	5.027	0.018
	Average	5.009	5.003	-0.006
	Min	4.992	4.976	-0.037
	Std Dev	0.012	0.014	0.015

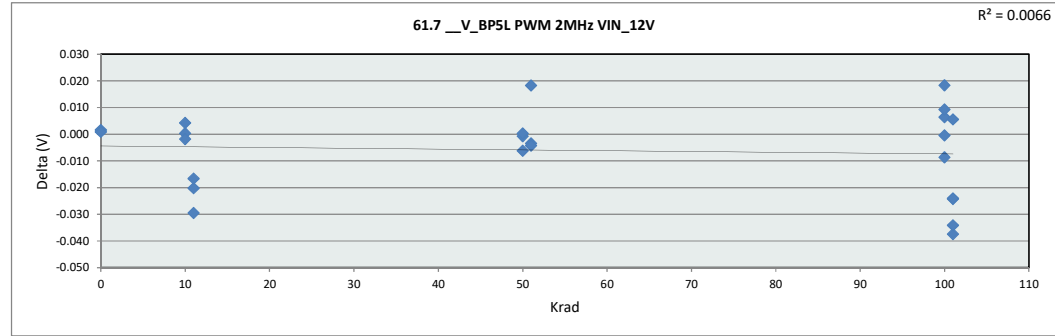

61.7 V_BP5L PWM 2MHz VIN							
Test Site	DAL						
Tester	ETS364						
Test Number	EB672303						
Max Limit	5.175 V						
Min Limit	4.75 V						
Krad	0	10	11	50	51	100	101
LL	4.750	4.750	4.750	4.750	4.750	4.750	4.750
Min	5.019	4.992	4.985	4.988	4.991	4.998	4.976
Average	5.023	5.003	4.996	5.000	5.002	5.010	4.993
Max	5.027	5.023	5.004	5.007	5.022	5.020	5.015
UL	5.175	5.175	5.175	5.175	5.175	5.175	5.175

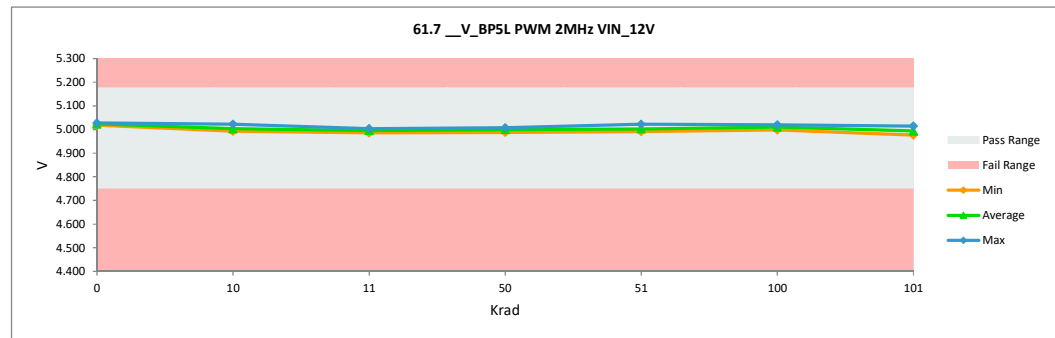

TID "HDR" Report
5962R2220102VXC

61.8_V_BP5H PWM 2MHz VIN		
Test Site	DAL	DAL
Tester	ETS364	ETS364
Test Number	EB672303	EB672303
Unit	V	V
Max Limit	5.175	5.175
Min Limit	4.75	4.75

Krad	Serial #	Pre_HDR_6013	Post_HDR_6013	Delta
0	1	5.002	5.003	0.001
0	2	5.019	5.020	0.001
10	182	4.999	4.998	-0.002
10	202	5.014	5.013	-0.001
10	204	5.022	5.020	-0.002
11	418	4.996	5.020	0.024
11	419	5.012	5.007	-0.005
11	443	5.010	4.990	-0.020
50	259	5.000	4.995	-0.005
50	346	4.996	4.990	-0.006
50	347	5.019	5.017	-0.002
51	462	5.010	5.006	-0.004
51	478	4.983	5.013	0.030
51	503	5.018	5.003	-0.014
100	354	5.011	5.009	-0.002
100	363	4.998	4.990	-0.008
100	366	4.991	4.985	-0.006
100	383	4.996	4.976	-0.020
100	417	5.005	5.001	-0.004
101	513	4.999	4.994	-0.005
101	526	4.995	5.000	0.005
101	532	5.010	4.987	-0.023
101	533	4.990	4.981	-0.009
101	534	4.988	4.971	-0.016
	Max	5.022	5.020	0.030
	Average	5.003	4.999	-0.004
	Min	4.983	4.971	-0.023
	Std Dev	0.011	0.014	0.012

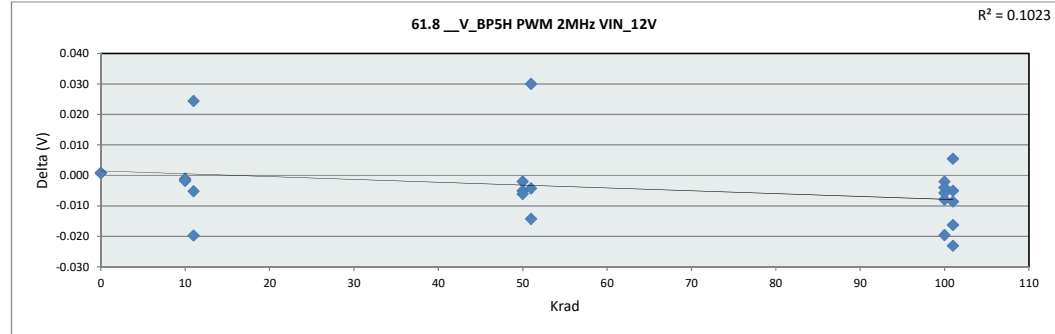

61.8_V_BP5H PWM 2MHz VI		
Test Site	DAL	
Tester	ETS364	
Test Number	EB672303	
Max Limit	5.175	V
Min Limit	4.75	V

	0	10	11	50	51	100	101
LL	4.750	4.750	4.750	4.750	4.750	4.750	4.750
Min	5.003	4.998	4.990	4.990	5.004	4.976	4.971
Average	5.011	5.010	5.006	5.001	5.007	4.992	4.987
Max	5.020	5.020	5.020	5.017	5.013	5.009	5.000
UL	5.175	5.175	5.175	5.175	5.175	5.175	5.175

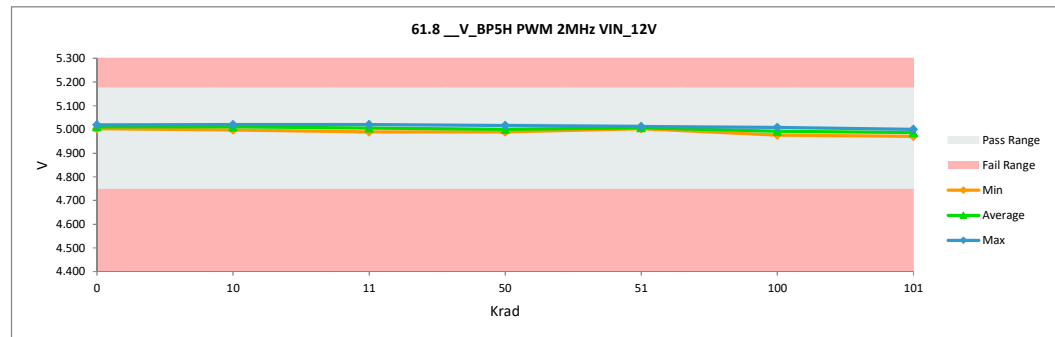

TID "HDR" Report
5962R2220102VXC

61.9 V_BP7L PWM 5MHz VIN		
Test Site	DAL	DAL
Tester	ETS364	ETS364
Test Number	EB672303	EB672303
Unit	V	V
Max Limit	7.35	7.35
Min Limit	6.65	6.65

Krad	Serial #	Pre_HDR_6013	Post_HDR_6013	Delta
0	1	7.022	7.020	-0.002
0	2	6.981	6.964	-0.016
10	182	7.011	7.010	0.000
10	202	7.030	7.029	-0.001
10	204	7.027	6.983	-0.044
11	418	7.028	7.026	-0.002
11	419	7.014	6.992	-0.022
11	443	7.032	7.053	0.021
50	259	7.073	7.065	-0.008
50	346	7.057	7.032	-0.024
50	347	7.010	7.012	0.002
51	462	7.063	7.011	-0.052
51	478	7.039	6.974	-0.065
51	503	7.044	7.036	-0.008
100	354	7.064	7.102	0.038
100	363	7.072	7.058	-0.013
100	366	7.005	6.976	-0.029
100	383	7.037	7.020	-0.016
100	417	7.094	7.121	0.026
101	513	7.057	7.033	-0.024
101	526	7.032	6.998	-0.034
101	532	7.026	6.999	-0.026
101	533	7.015	7.007	-0.008
101	534	7.054	7.033	-0.022
Max		7.094	7.121	0.038
Average		7.037	7.023	-0.014
Min		6.981	6.964	-0.065
Std Dev		0.026	0.038	0.024

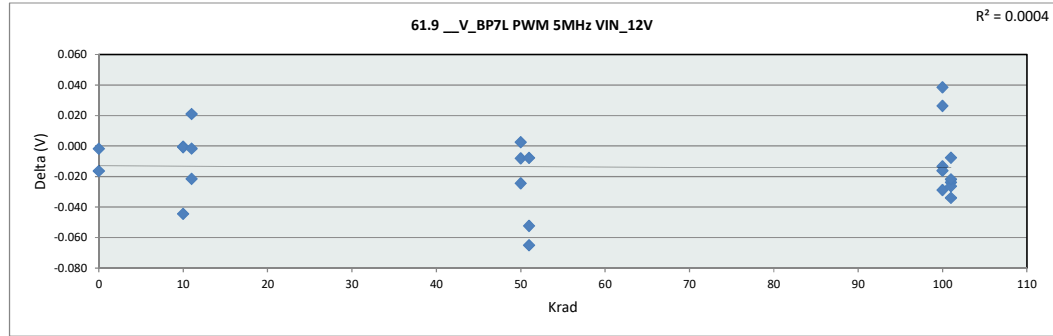

61.9 V_BP7L PWM 5MHz VIN		
Test Site	DAL	
Tester	ETS364	
Test Number	EB672303	
Max Limit	7.35	V
Min Limit	6.65	V

Krad	0	10	11	50	51	100	101
LL	6.650	6.650	6.650	6.650	6.650	6.650	6.650
Min	6.965	6.983	6.992	7.013	6.974	6.976	6.998
Average	6.992	7.007	7.024	7.037	7.007	7.056	7.014
Max	7.020	7.029	7.053	7.065	7.036	7.121	7.033
UL	7.350	7.350	7.350	7.350	7.350	7.350	7.350

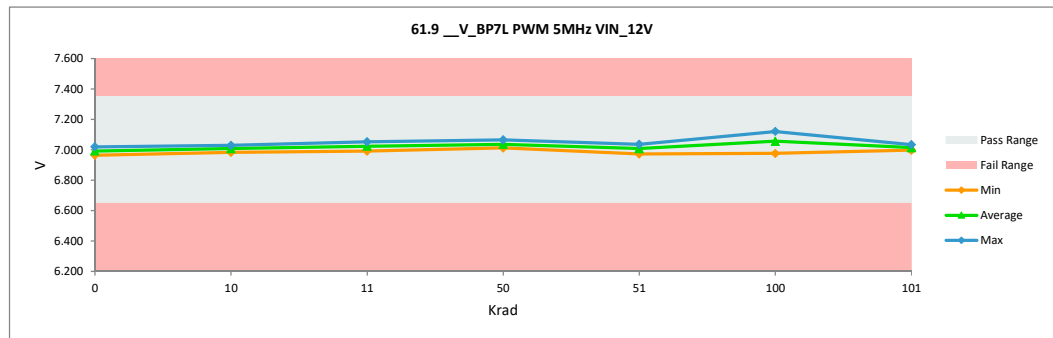

TID "HDR" Report
5962R2220102VXC

61.10_V_BP5L PWM 5MHz VIN		
Test Site	DAL	DAL
Tester	ETS364	ETS364
Test Number	EB672303	EB672303
Unit	V	V
Max Limit	5.175	5.175
Min Limit	4.75	4.75

Krad	Serial #	Pre_HDR_6013	Post_HDR_6013	Delta
0	1	5.021	5.022	0.001
0	2	5.013	5.017	0.003
10	182	4.987	4.986	-0.001
10	202	4.993	4.990	-0.002
10	204	5.013	5.017	0.004
11	418	5.015	4.994	-0.021
11	419	5.016	4.999	-0.017
11	443	5.010	4.981	-0.029
50	259	5.001	4.999	-0.002
50	346	4.989	4.981	-0.008
50	347	5.003	5.002	-0.001
51	462	4.998	5.017	0.018
51	478	4.990	4.986	-0.004
51	503	4.994	4.989	-0.005
100	354	5.024	5.015	-0.010
100	363	5.004	5.020	0.016
100	366	4.994	4.992	-0.001
100	383	4.988	4.995	0.007
100	417	4.992	5.009	0.016
101	513	5.010	4.970	-0.040
101	526	5.012	4.986	-0.026
101	532	5.022	4.997	-0.025
101	533	5.004	5.010	0.005
101	534	5.012	4.977	-0.034
Max		5.024	5.022	0.018
Average		5.004	4.998	-0.006
Min		4.987	4.970	-0.040
Std Dev		0.012	0.015	0.016

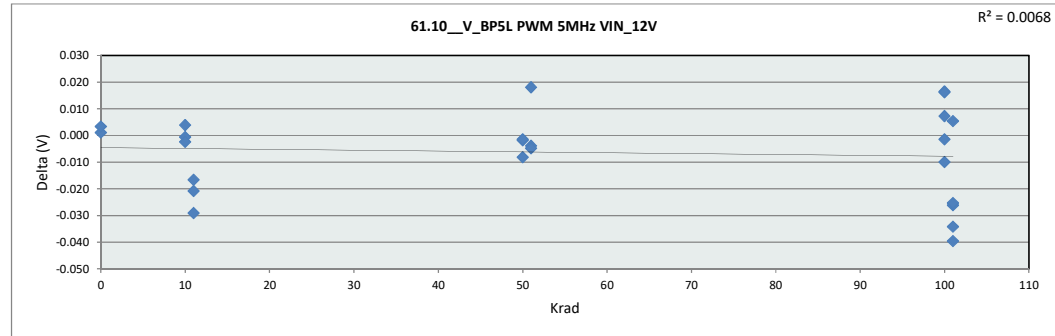

61.10_V_BP5L PWM 5MHz VI		
Test Site	DAL	
Tester	ETS364	
Test Number	EB672303	
Max Limit	5.175	V
Min Limit	4.75	V

Krad	0	10	11	50	51	100	101
LL	4.750	4.750	4.750	4.750	4.750	4.750	4.750
Min	5.017	4.986	4.981	4.981	4.986	4.992	4.970
Average	5.019	4.998	4.992	4.994	4.997	5.006	4.988
Max	5.022	5.017	5.000	5.002	5.017	5.020	5.010
UL	5.175	5.175	5.175	5.175	5.175	5.175	5.175

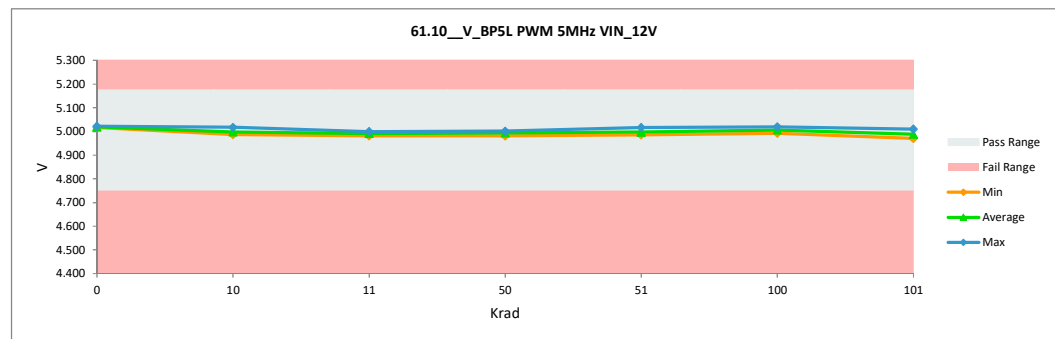

TID "HDR" Report
5962R2220102VXC

61.11_V_BP5H PWM 5MHz VIN		
Test Site	DAL	DAL
Tester	ETS364	ETS364
Test Number	EB672303	EB672303
Unit	V	V
Max Limit	5.175	5.175
Min Limit	4.75	4.75

Krad	Serial #	Pre_HDR_6013	Post_HDR_6013	Delta
0	1	5.004	5.005	0.001
0	2	5.021	5.022	0.001
10	182	5.002	5.001	-0.002
10	202	5.017	5.016	-0.002
10	204	5.025	5.024	-0.001
11	418	4.998	5.023	0.025
11	419	5.015	5.010	-0.005
11	443	5.012	4.992	-0.021
50	259	5.002	4.998	-0.003
50	346	4.998	4.993	-0.006
50	347	5.022	5.019	-0.002
51	462	5.014	5.008	-0.006
51	478	4.986	5.015	0.029
51	503	5.021	5.006	-0.015
100	354	5.013	5.011	-0.003
100	363	5.000	4.992	-0.008
100	366	4.993	4.988	-0.004
100	383	4.998	4.978	-0.020
100	417	5.007	5.003	-0.004
101	513	5.001	4.997	-0.004
101	526	4.997	5.004	0.006
101	532	5.012	4.989	-0.023
101	533	4.992	4.983	-0.009
101	534	4.989	4.974	-0.015
	Max	5.025	5.024	0.029
	Average	5.006	5.002	-0.004
	Min	4.986	4.974	-0.023
	Std Dev	0.011	0.014	0.012

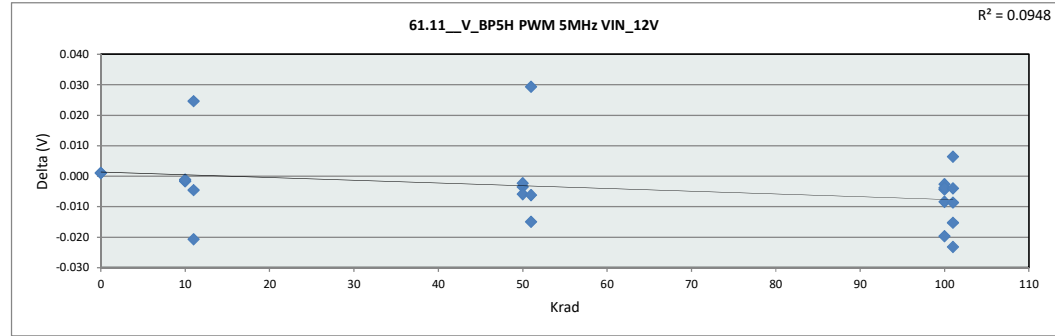

61.11_V_BP5H PWM 5MHz V1		
Test Site	DAL	
Tester	ETS364	
Test Number	EB672303	
Max Limit	5.175	V
Min Limit	4.75	V

	0	10	11	50	51	100	101
LL	4.750	4.750	4.750	4.750	4.750	4.750	4.750
Min	5.006	5.001	4.992	4.993	5.006	4.978	4.974
Average	5.014	5.013	5.008	5.003	5.009	4.994	4.989
Max	5.022	5.024	5.023	5.019	5.015	5.011	5.004
UL	5.175	5.175	5.175	5.175	5.175	5.175	5.175

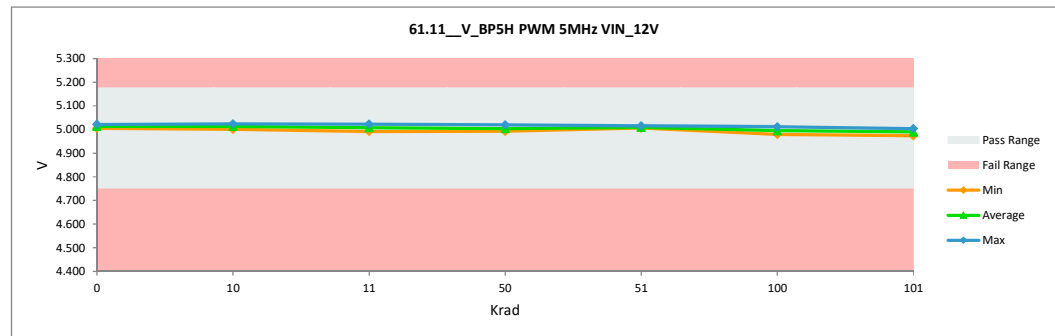

TID "HDR" Report
5962R2220102VXC

61.12_V_BP7L IIM 500kHz VIN		
Test Site	DAL	DAL
Tester	ETS364	ETS364
Test Number	EB672303	EB672303
Unit	V	V
Max Limit	7.35	7.35
Min Limit	6.65	6.65

Krad	Serial #	Pre_HDR_6013	Post_HDR_6013	Delta
0	1	7.027	7.025	-0.002
0	2	6.987	6.986	-0.001
10	182	7.016	7.014	-0.002
10	202	7.037	7.034	-0.002
10	204	7.032	6.988	-0.044
11	418	7.032	7.032	0.000
11	419	7.019	6.998	-0.022
11	443	7.036	7.058	0.022
50	259	7.081	7.071	-0.010
50	346	7.061	7.042	-0.019
50	347	7.021	7.014	-0.007
51	462	7.069	7.016	-0.053
51	478	7.043	6.979	-0.065
51	503	7.049	7.042	-0.007
100	354	7.069	7.103	0.034
100	363	7.077	7.075	-0.002
100	366	7.011	6.986	-0.025
100	383	7.042	7.023	-0.018
100	417	7.098	7.125	0.026
101	513	7.062	7.042	-0.020
101	526	7.036	7.005	-0.030
101	532	7.031	7.008	-0.023
101	533	7.019	7.011	-0.008
101	534	7.060	7.038	-0.021
Max		7.098	7.125	0.034
Average		7.042	7.030	-0.012
Min		6.987	6.979	-0.065
Std Dev		0.026	0.037	0.023

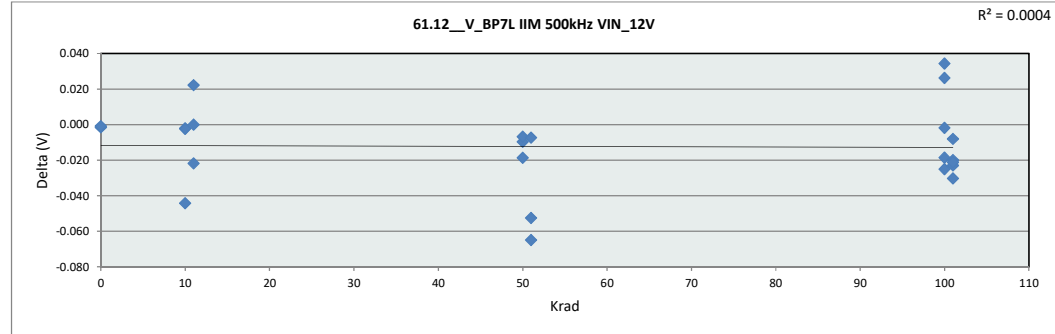

61.12_V_BP7L IIM 500kHz V		
Test Site	DAL	
Tester	ETS364	
Test Number	EB672303	
Max Limit	7.35	V
Min Limit	6.65	V

Krad	0	10	11	50	51	100	101
LL	6.650	6.650	6.650	6.650	6.650	6.650	6.650
Min	6.986	6.988	6.998	7.014	6.979	6.986	7.005
Average	7.006	7.012	7.029	7.043	7.012	7.063	7.021
Max	7.025	7.034	7.058	7.071	7.042	7.125	7.042
UL	7.350	7.350	7.350	7.350	7.350	7.350	7.350

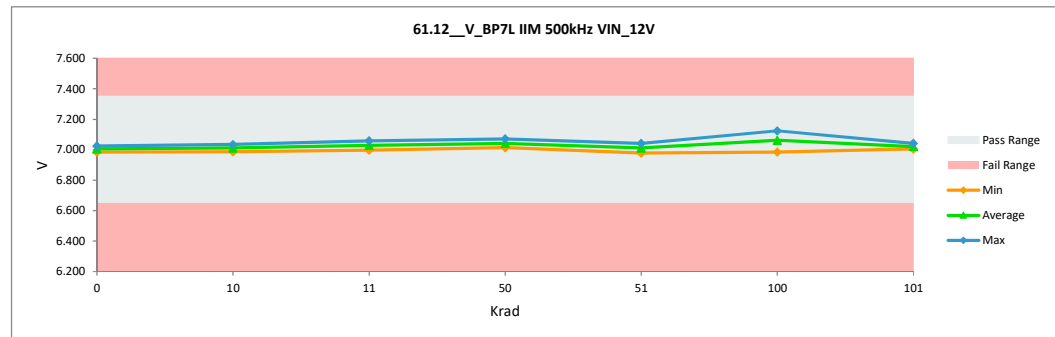

TID "HDR" Report
5962R2220102VXC

61.13_V_BP5L IIM 500kHz VIN		
Test Site	DAL	DAL
Tester	ETS364	ETS364
Test Number	EB672303	EB672303
Unit	V	V
Max Limit	5.175	5.175
Min Limit	4.75	4.75

Krad	Serial #	Pre_HDR_6013	Post_HDR_6013	Delta
0	1	5.019	5.021	0.001
0	2	5.011	5.012	0.001
10	182	4.984	4.984	0.000
10	202	4.991	4.988	-0.002
10	204	5.012	5.015	0.003
11	418	5.013	4.992	-0.021
11	419	5.014	4.997	-0.017
11	443	5.009	4.979	-0.029
50	259	4.999	4.997	-0.002
50	346	4.987	4.979	-0.008
50	347	5.000	4.999	-0.002
51	462	4.997	5.014	0.018
51	478	4.988	4.984	-0.004
51	503	4.991	4.987	-0.004
100	354	5.022	5.011	-0.011
100	363	5.002	5.007	0.005
100	366	4.992	4.990	-0.002
100	383	4.986	4.994	0.007
100	417	4.990	5.006	0.016
101	513	5.008	4.970	-0.037
101	526	5.010	4.985	-0.025
101	532	5.019	4.995	-0.024
101	533	5.002	5.006	0.004
101	534	5.010	4.976	-0.034
	Max	5.022	5.021	0.018
	Average	5.002	4.995	-0.007
	Min	4.984	4.970	-0.037
	Std Dev	0.012	0.014	0.015

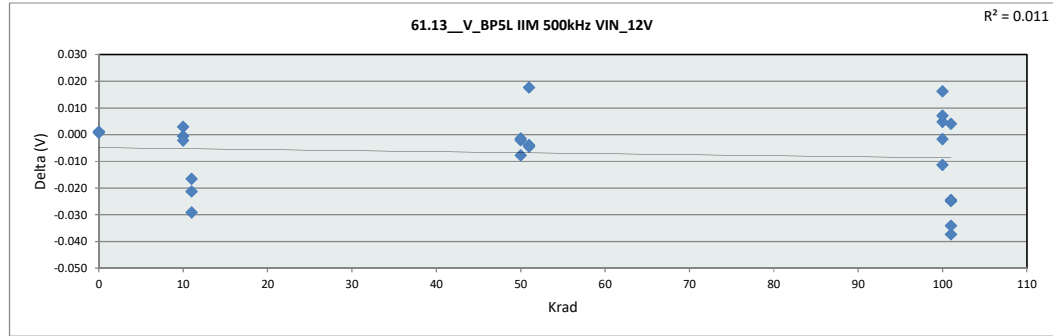

61.13_V_BP5L IIM 500kHz V		
Test Site	DAL	
Tester	ETS364	
Test Number	EB672303	
Max Limit	5.175	V
Min Limit	4.75	V

Krad	0	10	11	50	51	100	101
LL	4.750	4.750	4.750	4.750	4.750	4.750	4.750
Min	5.012	4.984	4.979	4.980	4.984	4.990	4.970
Average	5.016	4.996	4.990	4.992	4.995	5.001	4.987
Max	5.021	5.015	4.998	4.999	5.014	5.011	5.006
UL	5.175	5.175	5.175	5.175	5.175	5.175	5.175

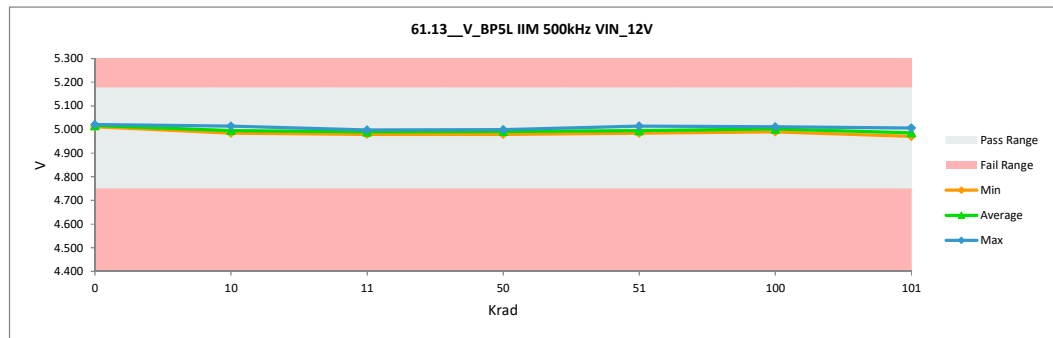

TID "HDR" Report
5962R2220102VXC

61.14_V_BP5H_IIM_500kHz_VIN		
Test Site	DAL	DAL
Tester	ETS364	ETS364
Test Number	EB672303	EB672303
Unit	V	V
Max Limit	5.175	5.175
Min Limit	4.75	4.75

Krad	Serial #	Pre_HDR_6013	Post_HDR_6013	Delta
0	1	5.000	5.001	0.001
0	2	5.017	5.017	0.001
10	182	4.997	4.995	-0.002
10	202	5.012	5.011	-0.001
10	204	5.020	5.018	-0.002
11	418	4.994	5.018	0.024
11	419	5.010	5.004	-0.006
11	443	5.007	4.988	-0.019
50	259	4.998	4.993	-0.005
50	346	4.994	4.987	-0.006
50	347	5.016	5.014	-0.002
51	462	5.008	5.004	-0.004
51	478	4.980	5.011	0.031
51	503	5.015	5.002	-0.014
100	354	5.009	5.007	-0.002
100	363	4.996	4.988	-0.008
100	366	4.989	4.983	-0.006
100	383	4.994	4.974	-0.019
100	417	5.003	4.998	-0.004
101	513	4.997	4.992	-0.005
101	526	4.992	4.997	0.005
101	532	5.008	4.985	-0.023
101	533	4.988	4.979	-0.009
101	534	4.985	4.969	-0.016
Max		5.020	5.018	0.031
Average		5.001	4.997	-0.004
Min		4.980	4.969	-0.023
Std Dev		0.011	0.014	0.012

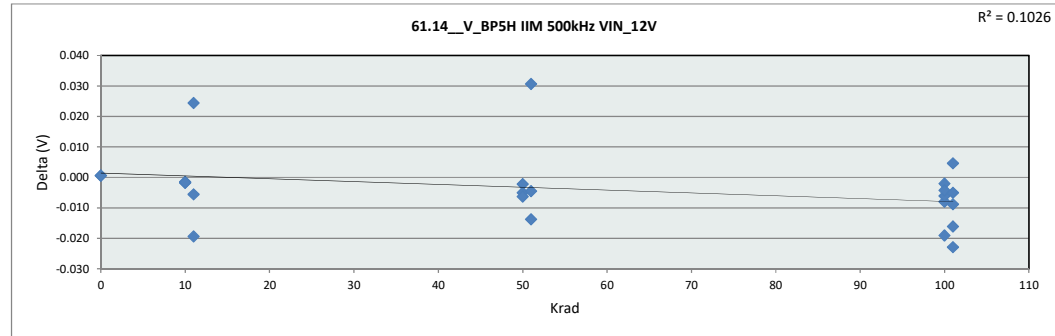

61.14_V_BP5H_IIM_500kHz_V		
Test Site	DAL	
Tester	ETS364	
Test Number	EB672303	
Max Limit	5.175	V
Min Limit	4.75	V

Krad	0	10	11	50	51	100	101
LL	4.750	4.750	4.750	4.750	4.750	4.750	4.750
Min	5.001	4.995	4.988	4.987	5.002	4.974	4.969
Average	5.009	5.008	5.004	4.998	5.005	4.990	4.984
Max	5.017	5.018	5.018	5.014	5.011	5.007	4.997
UL	5.175	5.175	5.175	5.175	5.175	5.175	5.175

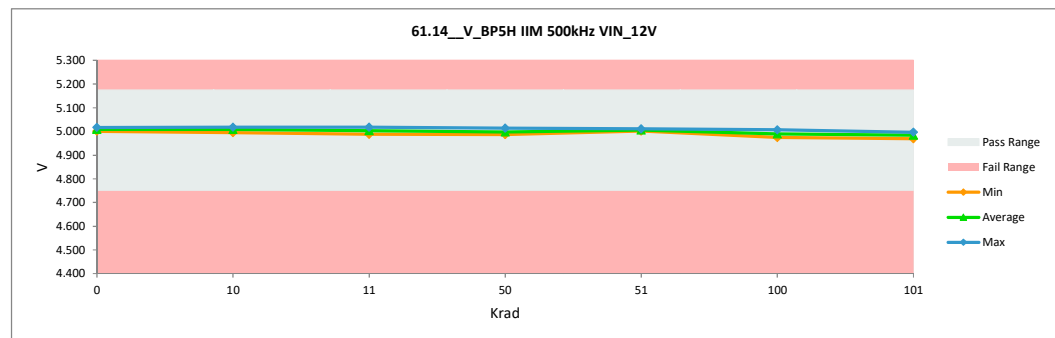

TID "HDR" Report
5962R2220102VXC

61.15_V_BP7L IIM 1MHz VIN		
Test Site	DAL	DAL
Tester	ETS364	ETS364
Test Number	EB672303	EB672303
Unit	V	V
Max Limit	7.35	7.35
Min Limit	6.65	6.65

Krad	Serial #	Pre_HDR_6013	Post_HDR_6013	Delta
0	1	7.023	7.021	-0.002
0	2	6.983	6.982	-0.001
10	182	7.012	7.010	-0.002
10	202	7.032	7.030	-0.002
10	204	7.028	6.983	-0.044
11	418	7.028	7.028	0.000
11	419	7.015	6.994	-0.022
11	443	7.032	7.055	0.023
50	259	7.076	7.067	-0.010
50	346	7.057	7.037	-0.020
50	347	7.017	7.011	-0.006
51	462	7.065	7.012	-0.053
51	478	7.040	6.974	-0.065
51	503	7.045	7.038	-0.008
100	354	7.065	7.100	0.035
100	363	7.073	7.072	-0.001
100	366	7.007	6.982	-0.025
100	383	7.038	7.019	-0.018
100	417	7.095	7.121	0.026
101	513	7.057	7.037	-0.020
101	526	7.032	7.001	-0.031
101	532	7.027	7.003	-0.024
101	533	7.015	7.007	-0.008
101	534	7.056	7.034	-0.022
Max		7.095	7.121	0.035
Average		7.038	7.026	-0.012
Min		6.983	6.974	-0.065
Std Dev		0.026	0.037	0.023

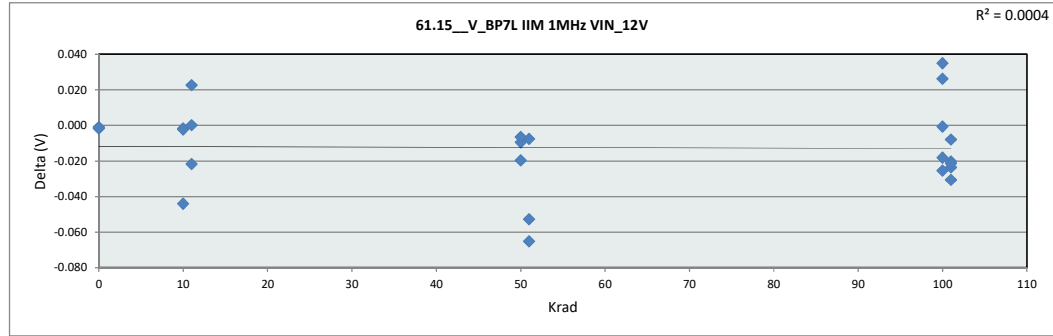

61.15_V_BP7L IIM 1MHz VIN		
Test Site	DAL	
Tester	ETS364	
Test Number	EB672303	
Max Limit	7.35	V
Min Limit	6.65	V

	0	10	11	50	51	100	101
LL	6.650	6.650	6.650	6.650	6.650	6.650	6.650
Min	6.982	6.983	6.994	7.011	6.974	6.982	7.001
Average	7.001	7.008	7.025	7.038	7.008	7.059	7.016
Max	7.021	7.030	7.055	7.067	7.038	7.121	7.037
UL	7.350	7.350	7.350	7.350	7.350	7.350	7.350

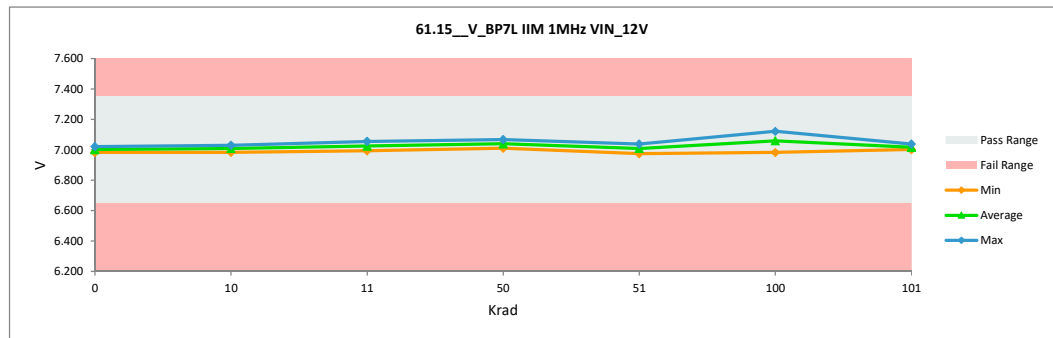

TID "HDR" Report
5962R2220102VXC

61.16_V_BP5L IIM 1MHz VIN		
Test Site	DAL	DAL
Tester	ETS364	ETS364
Test Number	EB672303	EB672303
Unit	V	V
Max Limit	5.175	5.175
Min Limit	4.75	4.75

Krad	Serial #	Pre_HDR_6013	Post_HDR_6013	Delta
0	1	5.022	5.023	0.001
0	2	5.014	5.014	0.001
10	182	4.987	4.987	0.000
10	202	4.993	4.991	-0.002
10	204	5.014	5.017	0.003
11	418	5.015	4.994	-0.021
11	419	5.016	5.000	-0.017
11	443	5.011	4.982	-0.029
50	259	5.001	4.999	-0.002
50	346	4.990	4.982	-0.007
50	347	5.003	5.002	-0.001
51	462	4.999	5.017	0.018
51	478	4.990	4.986	-0.004
51	503	4.993	4.989	-0.004
100	354	5.024	5.014	-0.010
100	363	5.004	5.010	0.005
100	366	4.994	4.993	-0.001
100	383	4.989	4.997	0.008
100	417	4.992	5.009	0.017
101	513	5.010	4.972	-0.037
101	526	5.012	4.987	-0.025
101	532	5.022	4.998	-0.024
101	533	5.005	5.009	0.005
101	534	5.012	4.978	-0.034
Max		5.024	5.023	0.018
Average		5.005	4.998	-0.007
Min		4.987	4.972	-0.037
Std Dev		0.012	0.014	0.015

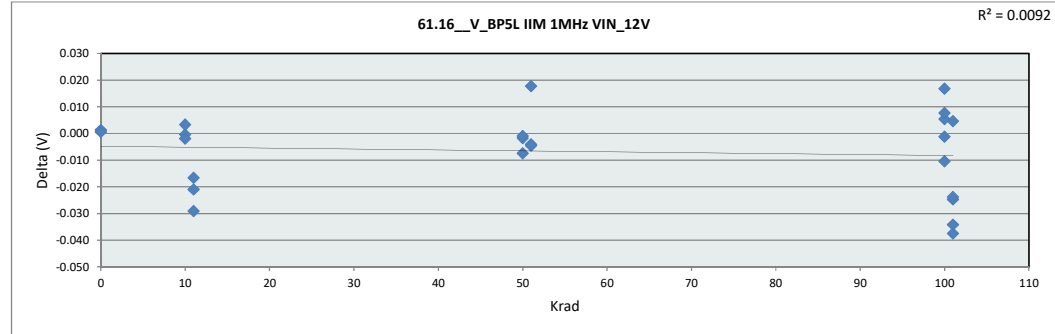

61.16_V_BP5L IIM 1MHz VIN		
Test Site	DAL	
Tester	ETS364	
Test Number	EB672303	
Max Limit	5.175	V
Min Limit	4.75	V

Krad	0	10	11	50	51	100	101
LL	4.750	4.750	4.750	4.750	4.750	4.750	4.750
Min	5.014	4.987	4.982	4.982	4.986	4.993	4.972
Average	5.019	4.998	4.992	4.994	4.997	5.004	4.989
Max	5.023	5.017	5.000	5.002	5.017	5.014	5.009
UL	5.175	5.175	5.175	5.175	5.175	5.175	5.175

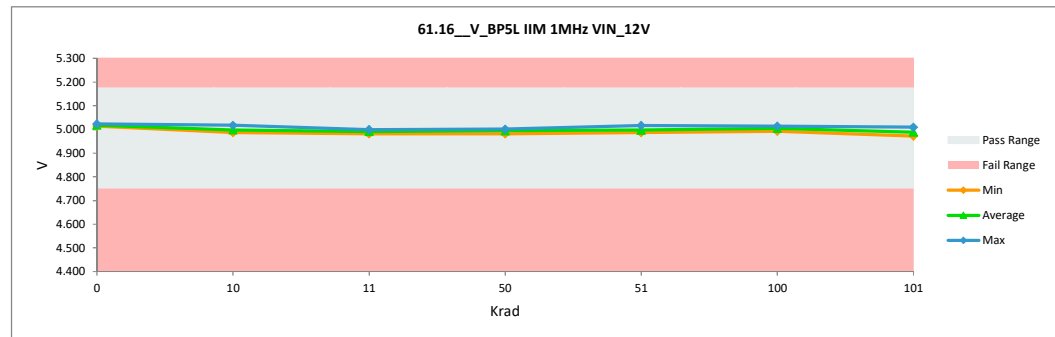

TID "HDR" Report
5962R2220102VXC

61.17_V_BP5H_IIM_1MHz_VIN		
Test Site	DAL	DAL
Tester	ETS364	ETS364
Test Number	EB672303	EB672303
Unit	V	V
Max Limit	5.175	5.175
Min Limit	4.75	4.75

Krad	Serial #	Pre_HDR_6013	Post_HDR_6013	Delta
0	1	5.001	5.001	0.001
0	2	5.017	5.018	0.000
10	182	4.998	4.996	-0.002
10	202	5.013	5.011	-0.001
10	204	5.020	5.019	-0.002
11	418	4.994	5.019	0.024
11	419	5.011	5.005	-0.006
11	443	5.008	4.988	-0.020
50	259	4.998	4.993	-0.005
50	346	4.994	4.988	-0.006
50	347	5.017	5.015	-0.002
51	462	5.009	5.004	-0.005
51	478	4.981	5.011	0.030
51	503	5.016	5.002	-0.014
100	354	5.009	5.007	-0.002
100	363	4.996	4.989	-0.008
100	366	4.989	4.983	-0.006
100	383	4.994	4.975	-0.019
100	417	5.003	4.999	-0.004
101	513	4.997	4.993	-0.005
101	526	4.993	4.998	0.005
101	532	5.008	4.985	-0.023
101	533	4.988	4.979	-0.009
101	534	4.986	4.970	-0.016
	Max	5.020	5.019	0.030
	Average	5.002	4.998	-0.004
	Min	4.981	4.970	-0.023
	Std Dev	0.011	0.014	0.012

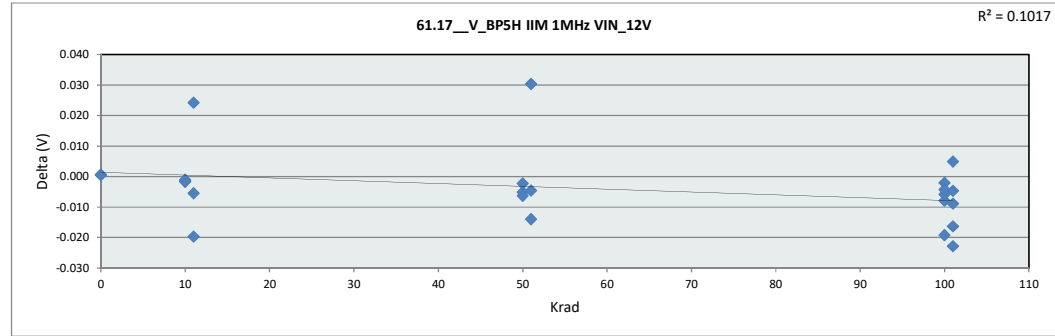

61.17_V_BP5H_IIM_1MHz_VIN		
Test Site	DAL	
Tester	ETS364	
Test Number	EB672303	
Max Limit	5.175	V
Min Limit	4.75	V

	0	10	11	50	51	100	101
LL	4.750	4.750	4.750	4.750	4.750	4.750	4.750
Min	5.001	4.996	4.988	4.988	5.002	4.975	4.970
Average	5.009	5.009	5.004	4.999	5.006	4.991	4.985
Max	5.018	5.019	5.019	5.015	5.012	5.007	4.998
UL	5.175	5.175	5.175	5.175	5.175	5.175	5.175

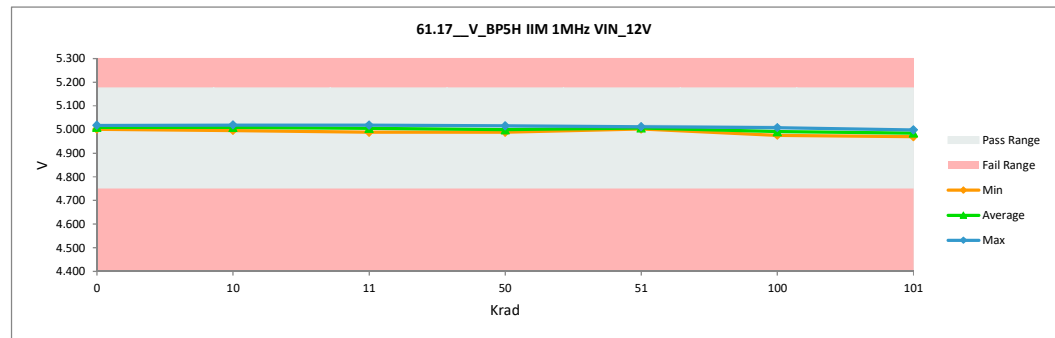

TID "HDR" Report
5962R2220102VXC

61.18_V_BP7L IIM 2MHz VIN		
Test Site	DAL	DAL
Tester	ETS364	ETS364
Test Number	EB672303	EB672303
Unit	V	V
Max Limit	7.35	7.35
Min Limit	6.65	6.65

Krad	Serial #	Pre_HDR_6013	Post_HDR_6013	Delta
0	1	7.015	7.013	-0.002
0	2	6.975	6.974	-0.001
10	182	7.004	7.002	-0.002
10	202	7.024	7.022	-0.002
10	204	7.020	6.976	-0.044
11	418	7.021	7.021	0.000
11	419	7.008	6.986	-0.021
11	443	7.024	7.047	0.023
50	259	7.068	7.059	-0.009
50	346	7.049	7.028	-0.021
50	347	7.010	7.003	-0.006
51	462	7.057	7.003	-0.053
51	478	7.032	6.966	-0.066
51	503	7.038	7.030	-0.008
100	354	7.057	7.093	0.036
100	363	7.065	7.066	0.001
100	366	6.999	6.973	-0.026
100	383	7.030	7.012	-0.018
100	417	7.088	7.113	0.025
101	513	7.049	7.028	-0.021
101	526	7.025	6.993	-0.032
101	532	7.019	6.995	-0.025
101	533	7.007	6.998	-0.009
101	534	7.048	7.025	-0.022
	Max	7.088	7.113	0.036
	Average	7.031	7.018	-0.013
	Min	6.975	6.966	-0.066
	Std Dev	0.026	0.037	0.023

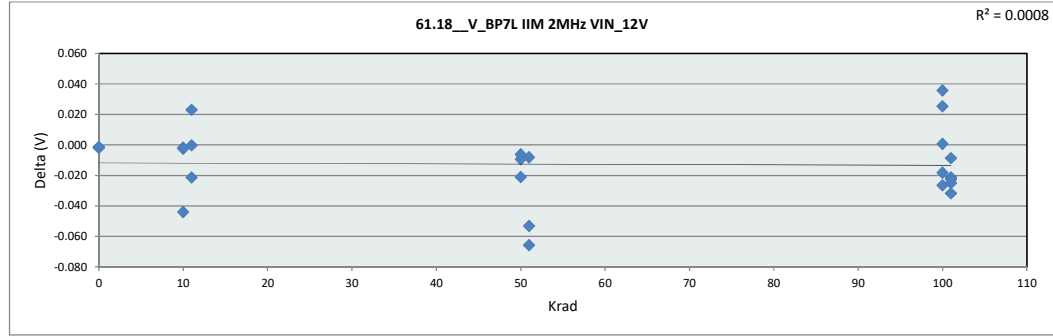

61.18_V_BP7L IIM 2MHz VIN		
Test Site	DAL	
Tester	ETS364	
Test Number	EB672303	
Max Limit	7.35	V
Min Limit	6.65	V

	0	10	11	50	51	100	101
LL	6.650	6.650	6.650	6.650	6.650	6.650	6.650
Min	6.974	6.976	6.986	7.003	6.966	6.973	6.993
Average	6.994	7.000	7.018	7.030	7.000	7.052	7.008
Max	7.013	7.022	7.047	7.059	7.030	7.113	7.028
UL	7.350	7.350	7.350	7.350	7.350	7.350	7.350

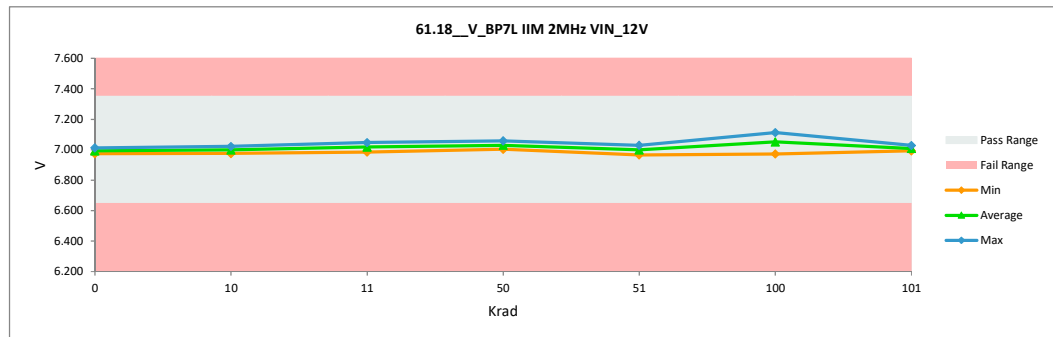

TID "HDR" Report
5962R2220102VXC

61.19_V_BP5L IIM 2MHz VIN		
Test Site	DAL	DAL
Tester	ETS364	ETS364
Test Number	EB672303	EB672303
Unit	V	V
Max Limit	5.175	5.175
Min Limit	4.75	4.75

Krad	Serial #	Pre_HDR_6013	Post_HDR_6013	Delta
0	1	5.026	5.028	0.002
0	2	5.018	5.019	0.001
10	182	4.992	4.992	0.000
10	202	4.997	4.995	-0.002
10	204	5.018	5.023	0.004
11	418	5.019	4.999	-0.020
11	419	5.021	5.004	-0.017
11	443	5.015	4.986	-0.029
50	259	5.005	5.005	-0.001
50	346	4.994	4.988	-0.006
50	347	5.007	5.007	0.000
51	462	5.003	5.022	0.018
51	478	4.995	4.991	-0.004
51	503	4.998	4.994	-0.004
100	354	5.029	5.020	-0.009
100	363	5.009	5.015	0.006
100	366	4.998	4.998	0.000
100	383	4.994	5.003	0.009
100	417	4.997	5.015	0.018
101	513	5.014	4.977	-0.037
101	526	5.017	4.992	-0.024
101	532	5.026	5.002	-0.024
101	533	5.009	5.015	0.006
101	534	5.016	4.982	-0.034
Max		5.029	5.028	0.018
Average		5.009	5.003	-0.006
Min		4.992	4.977	-0.037
Std Dev		0.012	0.014	0.015

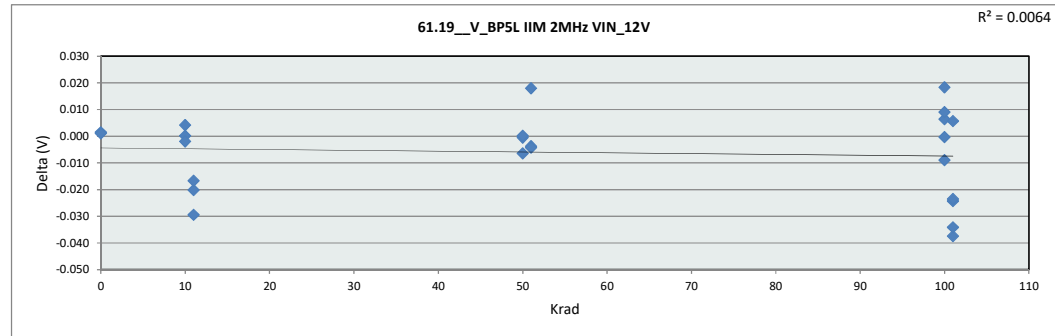

61.19_V_BP5L IIM 2MHz VIN		
Test Site	DAL	
Tester	ETS364	
Test Number	EB672303	
Max Limit	5.175	V
Min Limit	4.75	V

	0	10	11	50	51	100	101
LL	4.750	4.750	4.750	4.750	4.750	4.750	4.750
Min	5.019	4.992	4.986	4.988	4.991	4.998	4.977
Average	5.023	5.003	4.996	5.000	5.002	5.010	4.994
Max	5.028	5.023	5.004	5.007	5.022	5.020	5.015
UL	5.175	5.175	5.175	5.175	5.175	5.175	5.175

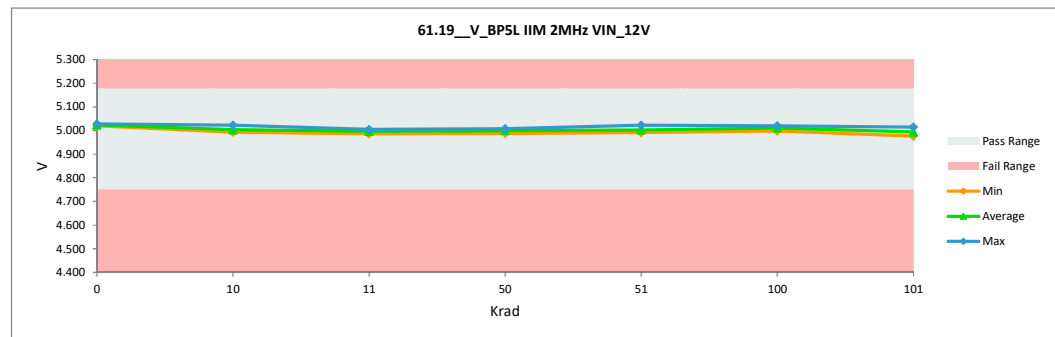

TID "HDR" Report
5962R2220102VXC

61.20_V_BP5H_IIM_2MHz_VIN		
Test Site	DAL	DAL
Tester	ETS364	ETS364
Test Number	EB672303	EB672303
Unit	V	V
Max Limit	5.175	5.175
Min Limit	4.75	4.75

Krad	Serial #	Pre_HDR_6013	Post_HDR_6013	Delta
0	1	5.002	5.002	0.001
0	2	5.019	5.019	0.001
10	182	4.999	4.997	-0.002
10	202	5.014	5.013	-0.001
10	204	5.022	5.020	-0.002
11	418	4.996	5.020	0.024
11	419	5.012	5.007	-0.006
11	443	5.009	4.990	-0.020
50	259	5.000	4.995	-0.005
50	346	4.996	4.990	-0.006
50	347	5.018	5.016	-0.002
51	462	5.010	5.006	-0.005
51	478	4.983	5.012	0.030
51	503	5.017	5.003	-0.014
100	354	5.011	5.009	-0.002
100	363	4.998	4.990	-0.008
100	366	4.991	4.985	-0.006
100	383	4.996	4.976	-0.019
100	417	5.004	5.000	-0.004
101	513	4.998	4.994	-0.005
101	526	4.994	4.999	0.005
101	532	5.010	4.987	-0.023
101	533	4.989	4.981	-0.009
101	534	4.987	4.971	-0.016
	Max	5.022	5.020	0.030
	Average	5.003	4.999	-0.004
	Min	4.983	4.971	-0.023
	Std Dev	0.011	0.014	0.012

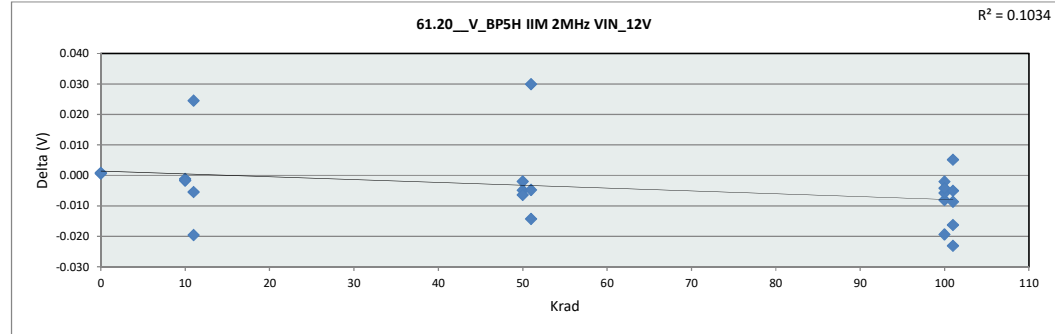

61.20_V_BP5H_IIM_2MHz_VIN		
Test Site	DAL	
Tester	ETS364	
Test Number	EB672303	
Max Limit	5.175	V
Min Limit	4.75	V

	0	10	11	50	51	100	101
LL	4.750	4.750	4.750	4.750	4.750	4.750	4.750
Min	5.002	4.998	4.990	4.990	5.003	4.976	4.971
Average	5.011	5.010	5.005	5.000	5.007	4.992	4.986
Max	5.019	5.020	5.020	5.016	5.013	5.009	5.000
UL	5.175	5.175	5.175	5.175	5.175	5.175	5.175

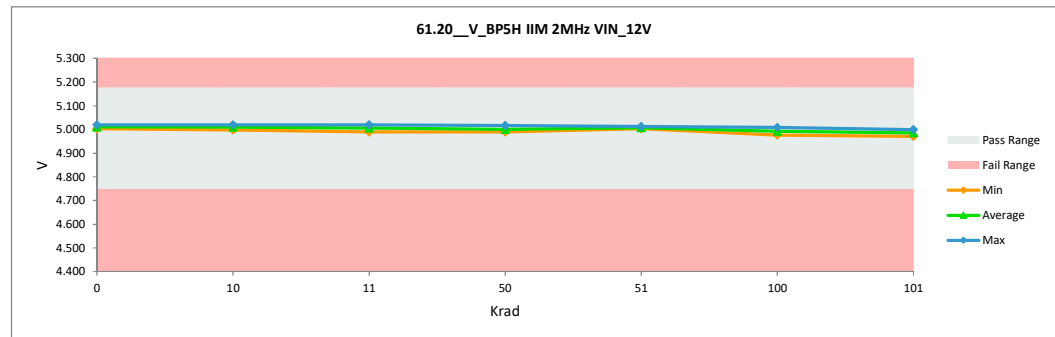

TID "HDR" Report
5962R2220102VXC

61.21_V_BP7L IIM 5MHz VIN		
Test Site	DAL	DAL
Tester	ETS364	ETS364
Test Number	EB672303	EB672303
Unit	V	V
Max Limit	7.35	7.35
Min Limit	6.65	6.65

Krad	Serial #	Pre_HDR_6013	Post_HDR_6013	Delta
0	1	6.993	6.989	-0.004
0	2	6.953	6.951	-0.002
10	182	6.981	6.979	-0.002
10	202	7.001	6.999	-0.002
10	204	6.997	6.953	-0.044
11	418	6.999	6.999	-0.001
11	419	6.985	6.965	-0.020
11	443	7.002	7.026	0.024
50	259	7.045	7.036	-0.009
50	346	7.026	7.004	-0.022
50	347	6.987	6.982	-0.005
51	462	7.034	6.980	-0.054
51	478	7.010	6.943	-0.067
51	503	7.017	7.009	-0.008
100	354	7.035	7.071	0.036
100	363	7.042	7.047	0.005
100	366	6.977	6.952	-0.026
100	383	7.008	6.990	-0.018
100	417	7.067	7.090	0.023
101	513	7.026	7.003	-0.023
101	526	7.005	6.971	-0.033
101	532	6.997	6.970	-0.028
101	533	6.984	6.974	-0.011
101	534	7.026	7.002	-0.024
	Max	7.067	7.090	0.036
	Average	7.008	6.995	-0.013
	Min	6.953	6.943	-0.067
	Std Dev	0.026	0.037	0.024

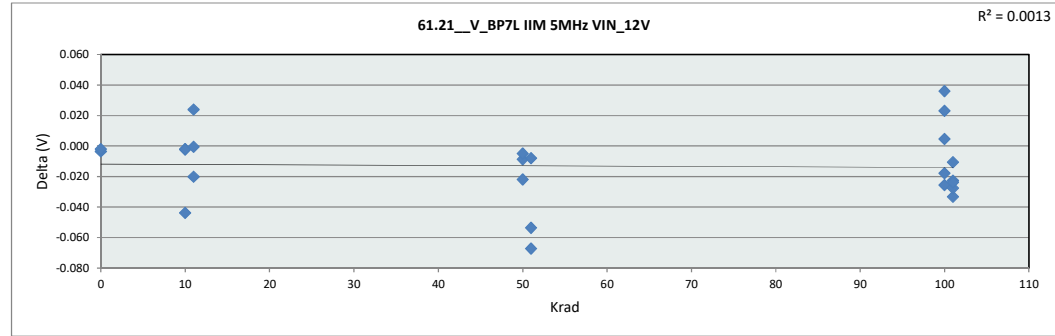

61.21_V_BP7L IIM 5MHz VIN		
Test Site	DAL	
Tester	ETS364	
Test Number	EB672303	
Max Limit	7.35	V
Min Limit	6.65	V

	0	10	11	50	51	100	101
LL	6.650	6.650	6.650	6.650	6.650	6.650	6.650
Min	6.951	6.953	6.965	6.982	6.943	6.952	6.970
Average	6.970	6.977	6.997	7.007	6.977	7.030	6.984
Max	6.989	6.999	7.026	7.036	7.009	7.090	7.003
UL	7.350	7.350	7.350	7.350	7.350	7.350	7.350

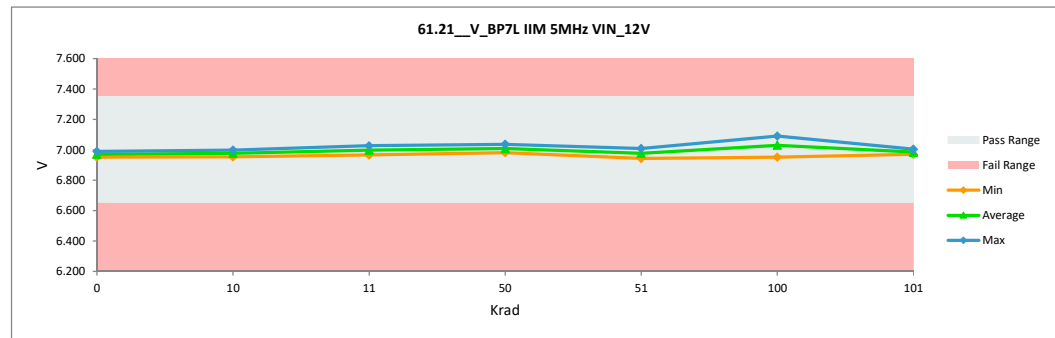

TID "HDR" Report
5962R2220102VXC

61.22_V_BP5L IIM 5MHz VIN		
Test Site	DAL	DAL
Tester	ETS364	ETS364
Test Number	EB672303	EB672303
Unit	V	V
Max Limit	5.175	5.175
Min Limit	4.75	4.75

Krad	Serial #	Pre_HDR_6013	Post_HDR_6013	Delta
0	1	5.042	5.044	0.003
0	2	5.033	5.036	0.002
10	182	5.010	5.012	0.003
10	202	5.012	5.011	-0.001
10	204	5.035	5.042	0.007
11	418	5.034	5.016	-0.018
11	419	5.036	5.020	-0.016
11	443	5.030	4.999	-0.031
50	259	5.021	5.024	0.003
50	346	5.009	5.007	-0.002
50	347	5.023	5.027	0.004
51	462	5.019	5.039	0.020
51	478	5.009	5.007	-0.002
51	503	5.013	5.009	-0.003
100	354	5.046	5.043	-0.003
100	363	5.024	5.034	0.010
100	366	5.013	5.015	0.002
100	383	5.010	5.025	0.015
100	417	5.012	5.035	0.023
101	513	5.029	4.991	-0.038
101	526	5.032	5.009	-0.023
101	532	5.041	5.018	-0.023
101	533	5.024	5.034	0.009
101	534	5.031	4.997	-0.035
Max		5.046	5.044	0.023
Average		5.025	5.020	-0.004
Min		5.009	4.991	-0.038
Std Dev		0.012	0.015	0.017

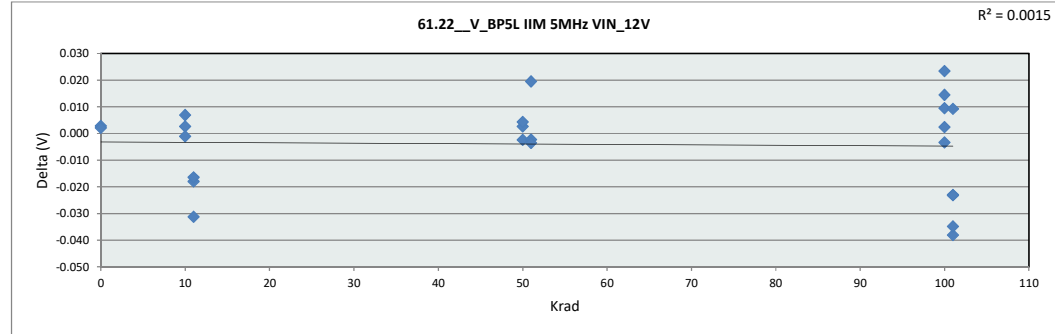

61.22_V_BP5L IIM 5MHz VIN		
Test Site	DAL	
Tester	ETS364	
Test Number	EB672303	
Max Limit	5.175	V
Min Limit	4.75	V

Krad	0	10	11	50	51	100	101
LL	4.750	4.750	4.750	4.750	4.750	4.750	4.750
Min	5.036	5.011	4.999	5.007	5.007	5.015	4.991
Average	5.040	5.022	5.012	5.019	5.018	5.030	5.010
Max	5.044	5.042	5.020	5.027	5.039	5.043	5.034
UL	5.175	5.175	5.175	5.175	5.175	5.175	5.175

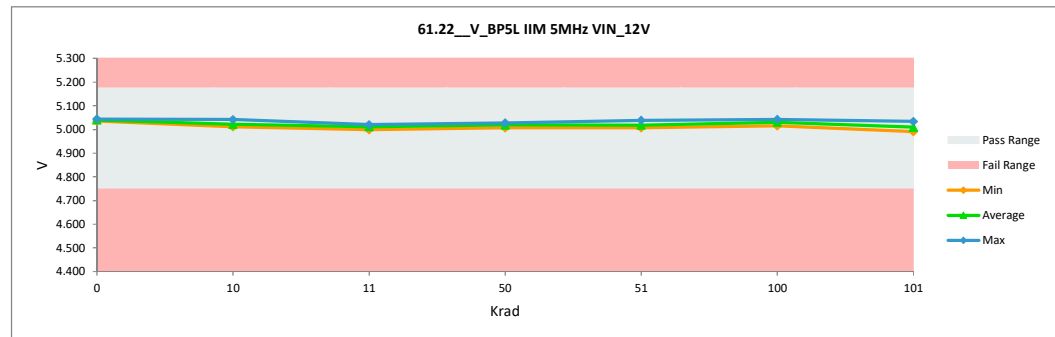

TID "HDR" Report
5962R2220102VXC

61.23_V_BP5H_IIM_5MHz_VIN		
Test Site	DAL	DAL
Tester	ETS364	ETS364
Test Number	EB672303	EB672303
Unit	V	V
Max Limit	5.175	5.175
Min Limit	4.75	4.75

Krad	Serial #	Pre_HDR_6013	Post_HDR_6013	Delta
0	1	5.005	5.006	0.001
0	2	5.023	5.024	0.001
10	182	5.004	5.002	-0.002
10	202	5.018	5.017	-0.001
10	204	5.026	5.024	-0.002
11	418	4.999	5.024	0.025
11	419	5.016	5.011	-0.005
11	443	5.014	4.993	-0.020
50	259	5.004	4.999	-0.005
50	346	5.000	4.994	-0.006
50	347	5.022	5.021	-0.002
51	462	5.015	5.010	-0.005
51	478	4.987	5.016	0.029
51	503	5.022	5.007	-0.015
100	354	5.015	5.013	-0.002
100	363	5.002	4.993	-0.009
100	366	4.995	4.989	-0.006
100	383	5.000	4.979	-0.021
100	417	5.009	5.004	-0.004
101	513	5.003	4.997	-0.005
101	526	4.999	5.005	0.006
101	532	5.014	4.990	-0.024
101	533	4.993	4.985	-0.009
101	534	4.991	4.975	-0.017
Max		5.026	5.024	0.029
Average		5.007	5.003	-0.004
Min		4.987	4.975	-0.024
Std Dev		0.011	0.014	0.012

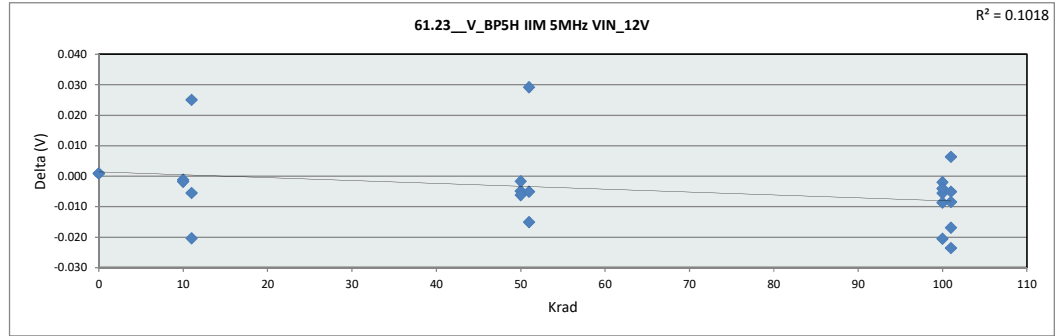

61.23_V_BP5H_IIM_5MHz_VIN		
Test Site	DAL	
Tester	ETS364	
Test Number	EB672303	
Max Limit	5.175	V
Min Limit	4.75	V

Krad	0	10	11	50	51	100	101
LL	4.750	4.750	4.750	4.750	4.750	4.750	4.750
Min	5.006	5.002	4.993	4.994	5.007	4.980	4.975
Average	5.015	5.014	5.009	5.004	5.011	4.996	4.990
Max	5.024	5.024	5.024	5.021	5.016	5.013	5.005
UL	5.175	5.175	5.175	5.175	5.175	5.175	5.175

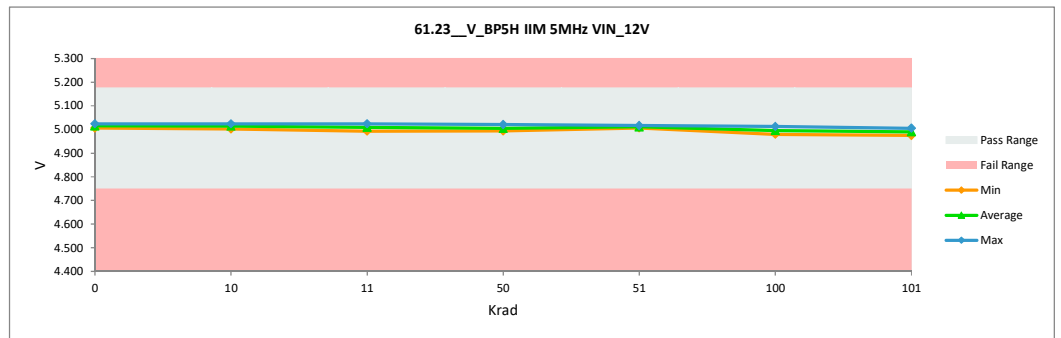

TID "HDR" Report
5962R2220102VXC

62.0 __V_BP7L PWM 500kHz VIN		
Test Site	DAL	DAL
Tester	ETS364	ETS364
Test Number	EB672303	EB672303
Unit	V	V
Max Limit	7.35	7.35
Min Limit	6.65	6.65

Krad	Serial #	Pre_HDR_6013	Post_HDR_6013	Delta
0	1	7.027	7.026	-0.001
0	2	6.987	6.986	-0.001
10	182	7.017	7.015	-0.002
10	202	7.037	7.035	-0.003
10	204	7.032	6.988	-0.044
11	418	7.032	7.032	0.000
11	419	7.020	6.998	-0.022
11	443	7.036	7.059	0.022
50	259	7.081	7.071	-0.009
50	346	7.062	7.043	-0.019
50	347	7.022	7.015	-0.007
51	462	7.069	7.016	-0.053
51	478	7.044	6.979	-0.065
51	503	7.050	7.042	-0.007
100	354	7.069	7.104	0.034
100	363	7.078	7.076	-0.002
100	366	7.012	6.987	-0.024
100	383	7.042	7.024	-0.018
100	417	7.099	7.127	0.028
101	513	7.062	7.043	-0.020
101	526	7.036	7.006	-0.030
101	532	7.032	7.009	-0.022
101	533	7.020	7.011	-0.008
101	534	7.060	7.039	-0.021
	Max	7.099	7.127	0.034
	Average	7.043	7.030	-0.012
	Min	6.987	6.979	-0.065
	Std Dev	0.026	0.037	0.023

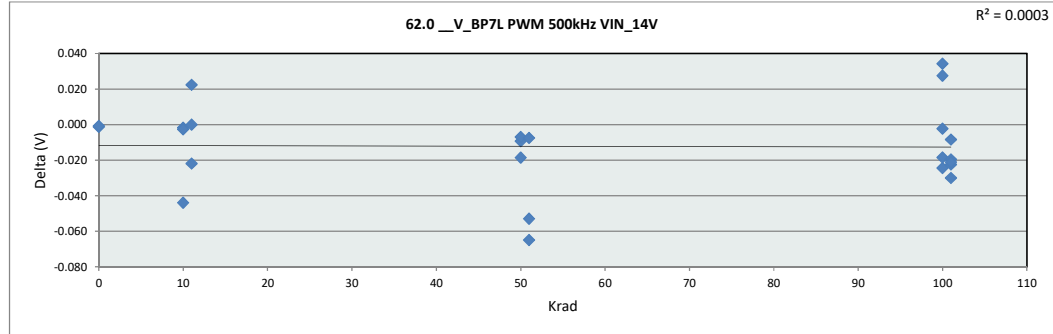

62.0 __V_BP7L PWM 500kHz V		
Test Site	DAL	
Tester	ETS364	
Test Number	EB672303	
Max Limit	7.35	V
Min Limit	6.65	V

Krad	0	10	11	50	51	100	101
LL	6.650	6.650	6.650	6.650	6.650	6.650	6.650
Min	6.986	6.988	6.998	7.015	6.979	6.987	7.006
Average	7.006	7.013	7.030	7.043	7.013	7.063	7.022
Max	7.026	7.035	7.059	7.072	7.042	7.127	7.043
UL	7.350	7.350	7.350	7.350	7.350	7.350	7.350

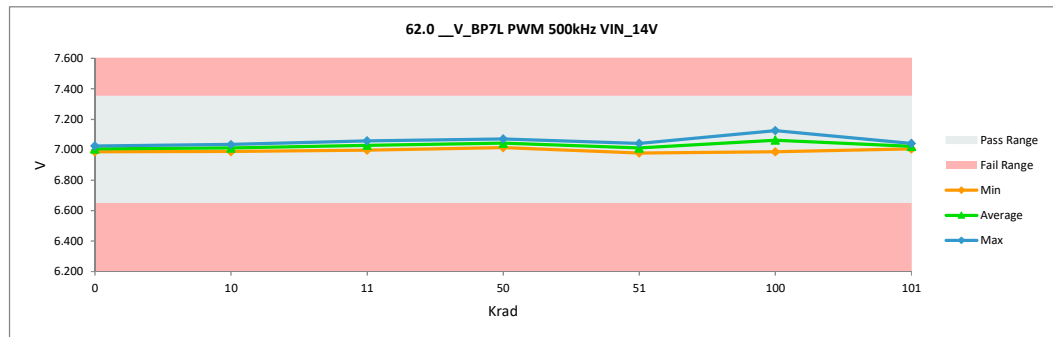

TID "HDR" Report
5962R2220102VXC

62.1 __V_BP5L PWM 500kHz VIN		
Test Site	DAL	DAL
Tester	ETS364	ETS364
Test Number	EB672303	EB672303
Unit	V	V
Max Limit	5.175	5.175
Min Limit	4.75	4.75

Krad	Serial #	Pre_HDR_6013	Post_HDR_6013	Delta
0	1	5.019	5.021	0.001
0	2	5.011	5.012	0.001
10	182	4.985	4.984	0.000
10	202	4.991	4.989	-0.002
10	204	5.012	5.015	0.003
11	418	5.014	4.992	-0.021
11	419	5.014	4.998	-0.017
11	443	5.009	4.980	-0.029
50	259	4.999	4.997	-0.002
50	346	4.988	4.980	-0.008
50	347	5.001	4.999	-0.002
51	462	4.997	5.014	0.017
51	478	4.989	4.984	-0.004
51	503	4.991	4.987	-0.004
100	354	5.022	5.011	-0.011
100	363	5.002	5.007	0.005
100	366	4.992	4.990	-0.002
100	383	4.987	4.994	0.007
100	417	4.990	5.007	0.016
101	513	5.008	4.971	-0.037
101	526	5.010	4.985	-0.025
101	532	5.020	4.995	-0.024
101	533	5.003	5.007	0.004
101	534	5.010	4.976	-0.034
	Max	5.022	5.021	0.017
	Average	5.003	4.996	-0.007
	Min	4.985	4.971	-0.037
	Std Dev	0.012	0.014	0.015

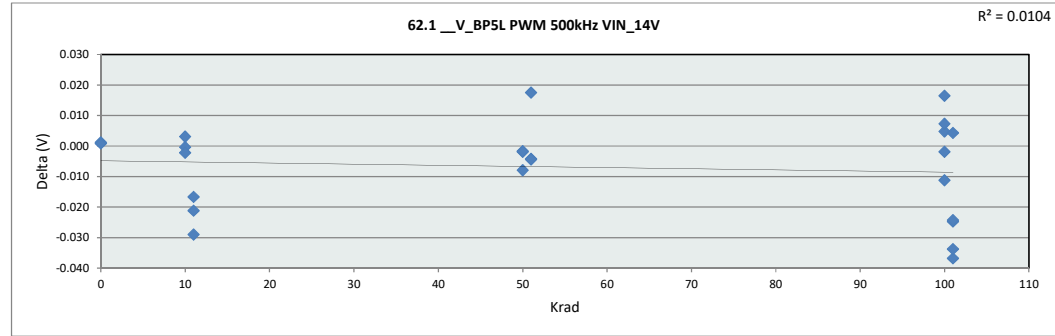

62.1 __V_BP5L PWM 500kHz V		
Test Site	DAL	
Tester	ETS364	
Test Number	EB672303	
Max Limit	5.175	V
Min Limit	4.75	V

Krad	0	10	11	50	51	100	101
LL	4.750	4.750	4.750	4.750	4.750	4.750	4.750
Min	5.012	4.984	4.980	4.980	4.984	4.990	4.971
Average	5.017	4.996	4.990	4.992	4.995	5.002	4.987
Max	5.021	5.015	4.998	4.999	5.014	5.011	5.007
UL	5.175	5.175	5.175	5.175	5.175	5.175	5.175

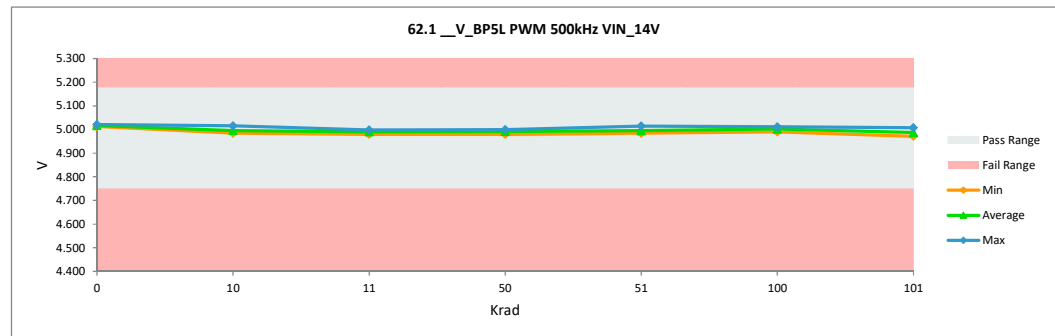

TID "HDR" Report
5962R2220102VXC

62.2 __V_BP5H PWM 500kHz VI		
Test Site	DAL	DAL
Tester	ETS364	ETS364
Test Number	EB672303	EB672303
Unit	V	V
Max Limit	5.175	5.175
Min Limit	4.75	4.75

Krad	Serial #	Pre_HDR_6013	Post_HDR_6013	Delta
0	1	5.000	5.001	0.000
0	2	5.017	5.017	0.001
10	182	4.997	4.995	-0.002
10	202	5.012	5.011	-0.001
10	204	5.020	5.018	-0.002
11	418	4.994	5.018	0.024
11	419	5.010	5.005	-0.006
11	443	5.008	4.988	-0.019
50	259	4.998	4.993	-0.005
50	346	4.994	4.988	-0.006
50	347	5.016	5.014	-0.003
51	462	5.008	5.004	-0.005
51	478	4.981	5.011	0.030
51	503	5.015	5.002	-0.014
100	354	5.009	5.006	-0.002
100	363	4.996	4.988	-0.008
100	366	4.989	4.983	-0.006
100	383	4.993	4.975	-0.019
100	417	5.003	4.998	-0.004
101	513	4.997	4.992	-0.005
101	526	4.992	4.997	0.005
101	532	5.008	4.985	-0.023
101	533	4.988	4.979	-0.008
101	534	4.985	4.970	-0.016
	Max	5.020	5.018	0.030
	Average	5.001	4.997	-0.004
	Min	4.981	4.970	-0.023
	Std Dev	0.011	0.014	0.012

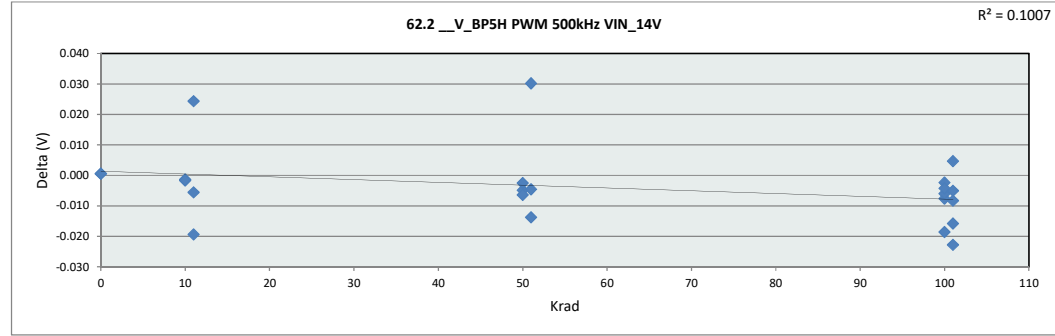

62.2 __V_BP5H PWM 500kHz		
Test Site	DAL	
Tester	ETS364	
Test Number	EB672303	
Max Limit	5.175	V
Min Limit	4.75	V

	0	10	11	50	51	100	101
LL	4.750	4.750	4.750	4.750	4.750	4.750	4.750
Min	5.001	4.995	4.988	4.988	5.002	4.975	4.970
Average	5.009	5.008	5.004	4.998	5.005	4.990	4.985
Max	5.017	5.018	5.018	5.018	5.014	5.007	4.997
UL	5.175	5.175	5.175	5.175	5.175	5.175	5.175

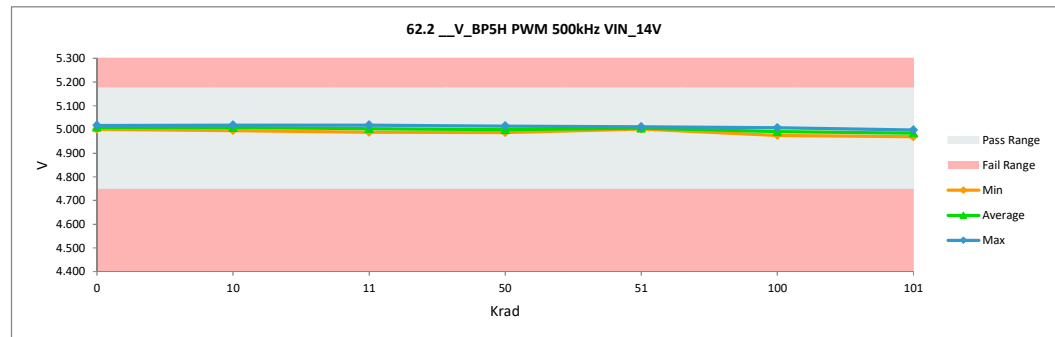

TID "HDR" Report
5962R2220102VXC

62.3 V_BP7L PWM 1MHz VIN		
Test Site	DAL	
Tester	ETS364	
Test Number	EB672303	EB672303
Unit	V	
Max Limit	7.35	
Min Limit	6.65	

Krad	Serial #	Pre_HDR_6013	Post_HDR_6013	Delta
0	1	7.023	7.022	-0.001
0	2	6.984	6.983	-0.001
10	182	7.013	7.011	-0.002
10	202	7.033	7.031	-0.002
10	204	7.028	6.984	-0.044
11	418	7.029	7.029	0.000
11	419	7.016	6.994	-0.022
11	443	7.033	7.055	0.022
50	259	7.077	7.068	-0.009
50	346	7.058	7.039	-0.019
50	347	7.018	7.011	-0.007
51	462	7.065	7.012	-0.053
51	478	7.041	6.976	-0.065
51	503	7.046	7.039	-0.007
100	354	7.066	7.101	0.035
100	363	7.074	7.073	-0.001
100	366	7.008	6.983	-0.025
100	383	7.038	7.021	-0.018
100	417	7.096	7.122	0.026
101	513	7.058	7.038	-0.020
101	526	7.032	7.002	-0.030
101	532	7.028	7.005	-0.023
101	533	7.016	7.007	-0.008
101	534	7.056	7.035	-0.022
	Max	7.096	7.122	0.035
	Average	7.039	7.027	-0.012
	Min	6.984	6.976	-0.065
	Std Dev	0.026	0.037	0.023

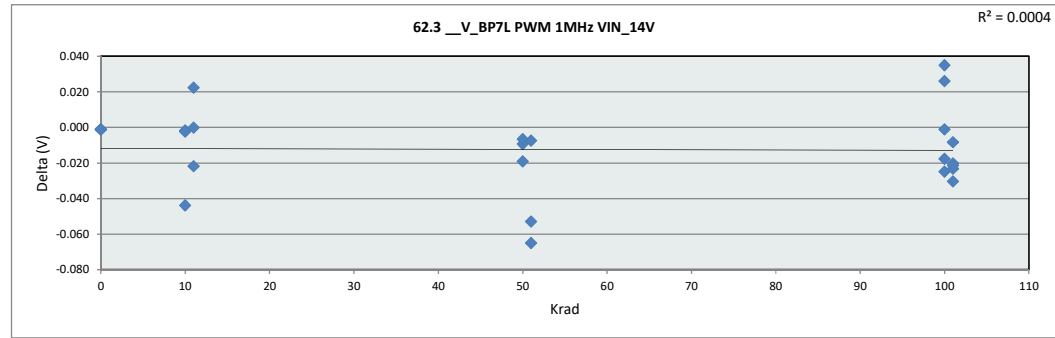

62.3 V_BP7L PWM 1MHz VIN		
Test Site	DAL	
Tester	ETS364	
Test Number	EB672303	
Max Limit	7.35	
Min Limit	6.65	

	0	10	11	50	51	100	101
LL	6.650	6.650	6.650	6.650	6.650	6.650	6.650
Min	6.983	6.985	6.994	7.011	6.976	6.983	7.002
Average	7.002	7.009	7.026	7.039	7.009	7.060	7.017
Max	7.022	7.031	7.055	7.068	7.039	7.122	7.038
UL	7.350	7.350	7.350	7.350	7.350	7.350	7.350

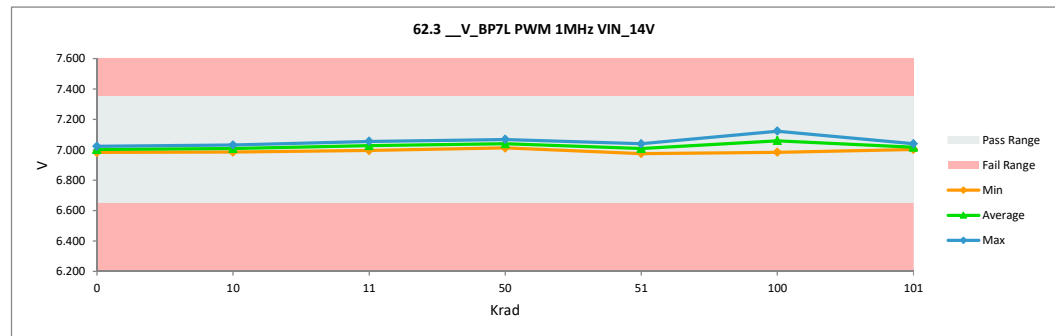

TID "HDR" Report
5962R2220102VXC

62.4 _V_BP5L PWM 1MHz VIN		
Test Site	DAL	
Tester	ETS364	
Test Number	EB672303	EB672303
Unit	V	
Max Limit	5.175	5.175
Min Limit	4.75	4.75

Krad	Serial #	Pre_HDR_6013	Post_HDR_6013	Delta
0	1	5.022	5.023	0.001
0	2	5.014	5.015	0.001
10	182	4.988	4.987	0.000
10	202	4.993	4.991	-0.002
10	204	5.014	5.018	0.003
11	418	5.016	4.995	-0.021
11	419	5.017	5.000	-0.017
11	443	5.011	4.982	-0.029
50	259	5.002	5.000	-0.001
50	346	4.990	4.983	-0.007
50	347	5.003	5.002	-0.001
51	462	4.999	5.017	0.018
51	478	4.991	4.987	-0.004
51	503	4.994	4.990	-0.004
100	354	5.025	5.015	-0.010
100	363	5.005	5.010	0.006
100	366	4.994	4.993	-0.001
100	383	4.989	4.997	0.008
100	417	4.993	5.010	0.017
101	513	5.010	4.973	-0.037
101	526	5.012	4.988	-0.024
101	532	5.022	4.998	-0.024
101	533	5.005	5.010	0.005
101	534	5.012	4.979	-0.034
	Max	5.025	5.023	0.018
	Average	5.005	4.998	-0.007
	Min	4.988	4.973	-0.037
	Std Dev	0.012	0.014	0.015

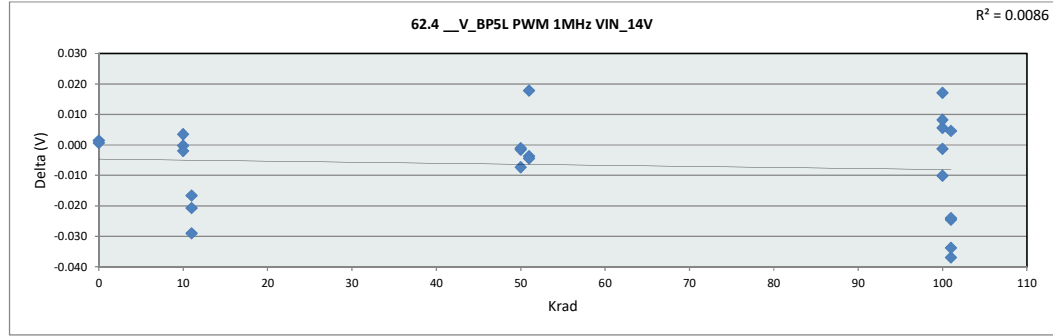

62.4 _V_BP5L PWM 1MHz VIN		
Test Site	DAL	
Tester	ETS364	
Test Number	EB672303	
Max Limit	5.175	
Min Limit	4.75	

	0	10	11	50	51	100	101
LL	4.750	4.750	4.750	4.750	4.750	4.750	4.750
Min	5.015	4.987	4.982	4.983	4.987	4.993	4.973
Average	5.019	4.999	4.992	4.995	4.998	5.005	4.990
Max	5.023	5.018	5.000	5.002	5.017	5.015	5.010
UL	5.175	5.175	5.175	5.175	5.175	5.175	5.175

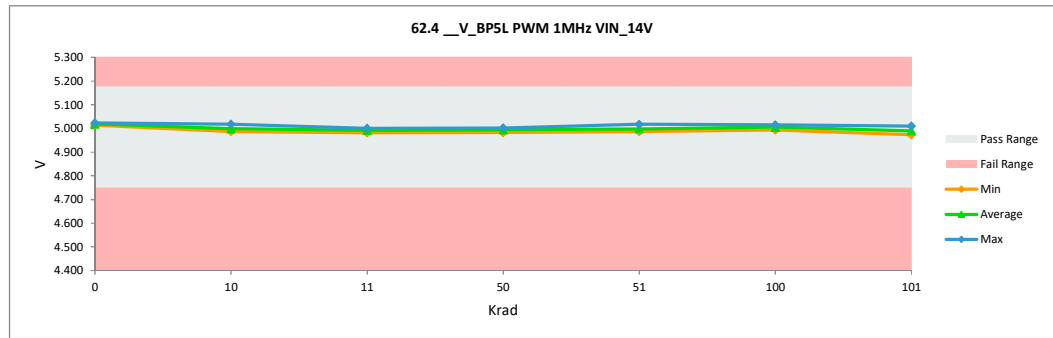

TID "HDR" Report
5962R2220102VXC

62.5_V_BP5H PWM 1MHz VIN		
Test Site	DAL	DAL
Tester	ETS364	ETS364
Test Number	EB672303	EB672303
Unit	V	V
Max Limit	5.175	5.175
Min Limit	4.75	4.75

Krad	Serial #	Pre_HDR_6013	Post_HDR_6013	Delta
0	1	5.001	5.001	0.001
0	2	5.017	5.018	0.001
10	182	4.998	4.996	-0.002
10	202	5.013	5.012	-0.001
10	204	5.020	5.019	-0.001
11	418	4.995	5.019	0.024
11	419	5.011	5.005	-0.005
11	443	5.008	4.989	-0.019
50	259	4.998	4.994	-0.005
50	346	4.995	4.988	-0.006
50	347	5.017	5.015	-0.002
51	462	5.009	5.005	-0.004
51	478	4.981	5.012	0.030
51	503	5.016	5.002	-0.014
100	354	5.010	5.007	-0.002
100	363	4.997	4.989	-0.008
100	366	4.990	4.984	-0.006
100	383	4.994	4.975	-0.019
100	417	5.003	4.999	-0.004
101	513	4.997	4.992	-0.005
101	526	4.993	4.998	0.005
101	532	5.009	4.986	-0.023
101	533	4.988	4.980	-0.009
101	534	4.986	4.970	-0.016
	Max	5.020	5.019	0.030
	Average	5.002	4.998	-0.004
	Min	4.981	4.970	-0.023
	Std Dev	0.011	0.014	0.012

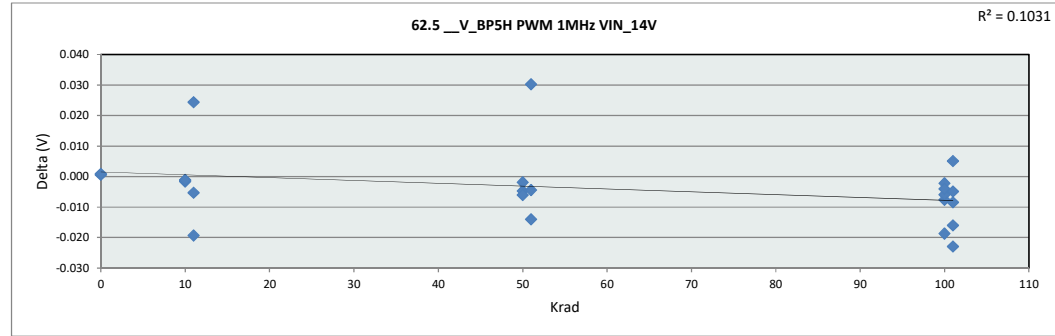

62.5_V_BP5H PWM 1MHz VI		
Test Site	DAL	
Tester	ETS364	
Test Number	EB672303	
Max Limit	5.175	V
Min Limit	4.75	V

Krad	0	10	11	50	51	100	101
LL	4.750	4.750	4.750	4.750	4.750	4.750	4.750
Min	5.001	4.996	4.989	4.988	5.002	4.975	4.970
Average	5.010	5.009	5.004	4.999	5.006	4.991	4.985
Max	5.018	5.019	5.019	5.015	5.012	5.007	4.998
UL	5.175	5.175	5.175	5.175	5.175	5.175	5.175

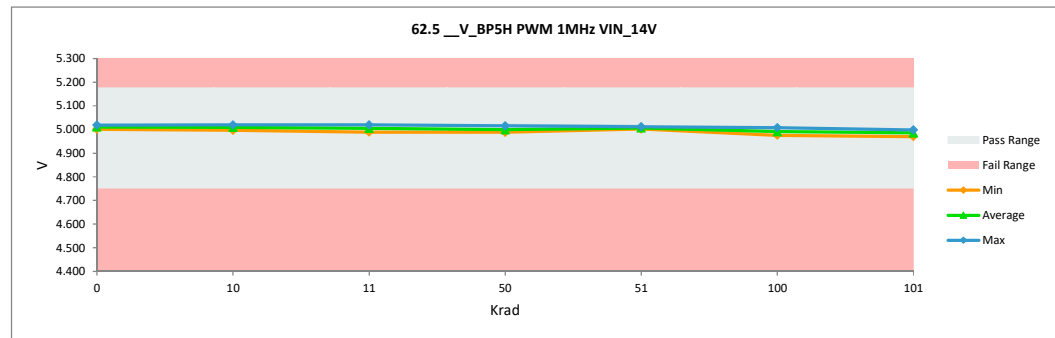

TID "HDR" Report
5962R2220102VXC

62.6 V_BP7L PWM 2MHz VIN		
Test Site	DAL	DAL
Tester	ETS364	ETS364
Test Number	EB672303	EB672303
Unit	V	V
Max Limit	7.35	7.35
Min Limit	6.65	6.65

Krad	Serial #	Pre_HDR_6013	Post_HDR_6013	Delta
0	1	7.017	7.015	-0.002
0	2	6.977	6.975	-0.001
10	182	7.006	7.004	-0.002
10	202	7.026	7.024	-0.002
10	204	7.021	6.977	-0.044
11	418	7.023	7.022	0.000
11	419	7.009	6.988	-0.022
11	443	7.026	7.049	0.023
50	259	7.070	7.061	-0.009
50	346	7.051	7.030	-0.020
50	347	7.011	7.005	-0.006
51	462	7.059	7.005	-0.053
51	478	7.034	6.968	-0.065
51	503	7.040	7.032	-0.008
100	354	7.059	7.095	0.036
100	363	7.067	7.068	0.001
100	366	7.001	6.975	-0.026
100	383	7.032	7.014	-0.018
100	417	7.089	7.115	0.026
101	513	7.051	7.030	-0.021
101	526	7.026	6.995	-0.032
101	532	7.021	6.997	-0.025
101	533	7.009	7.000	-0.009
101	534	7.049	7.027	-0.022
	Max	7.089	7.115	0.036
	Average	7.032	7.020	-0.013
	Min	6.977	6.968	-0.065
	Std Dev	0.026	0.037	0.023

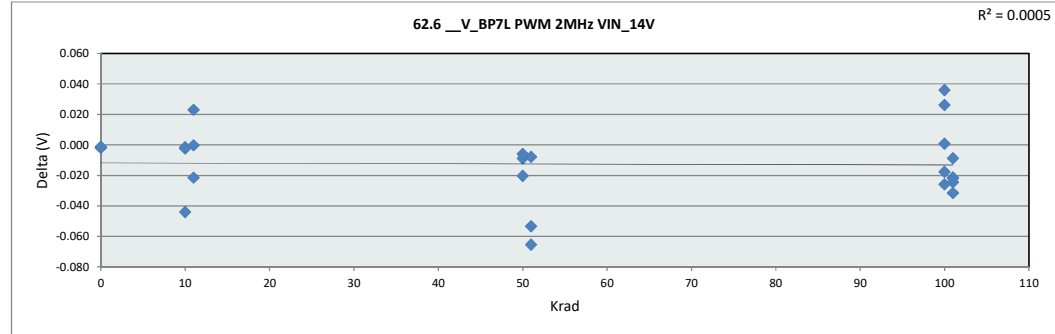

62.6 V_BP7L PWM 2MHz VIN		
Test Site	DAL	
Tester	ETS364	
Test Number	EB672303	
Max Limit	7.35	V
Min Limit	6.65	V

Krad	0	10	11	50	51	100	101
LL	6.650	6.650	6.650	6.650	6.650	6.650	6.650
Min	6.975	6.977	6.988	7.005	6.968	6.975	6.995
Average	6.995	7.002	7.020	7.032	7.002	7.053	7.010
Max	7.015	7.024	7.049	7.061	7.032	7.115	7.030
UL	7.350	7.350	7.350	7.350	7.350	7.350	7.350

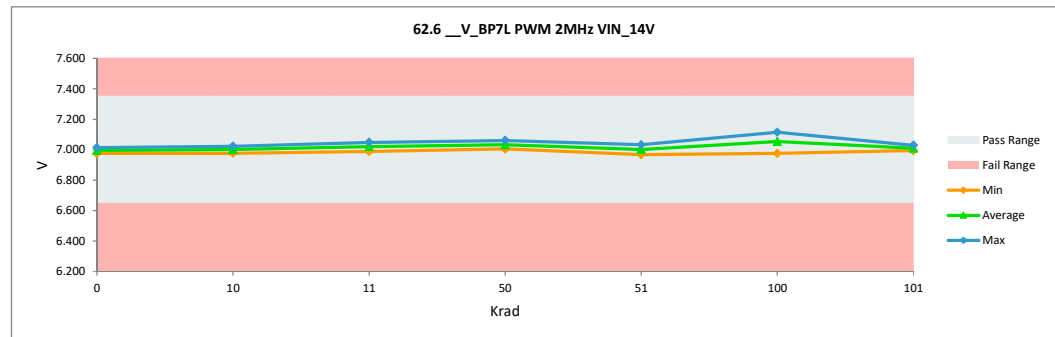

TID "HDR" Report
5962R2220102VXC

62.7 V_BP5L PWM 2MHz VIN		
Test Site	DAL	DAL
Tester	ETS364	ETS364
Test Number	EB672303	EB672303
Unit	V	V
Max Limit	5.175	5.175
Min Limit	4.75	4.75

Krad	Serial #	Pre_HDR_6013	Post_HDR_6013	Delta
0	1	5.027	5.029	0.002
0	2	5.019	5.020	0.001
10	182	4.993	4.994	0.000
10	202	4.998	4.996	-0.002
10	204	5.020	5.024	0.004
11	418	5.020	5.000	-0.020
11	419	5.022	5.005	-0.017
11	443	5.016	4.987	-0.029
50	259	5.007	5.006	-0.001
50	346	4.995	4.989	-0.006
50	347	5.008	5.009	0.000
51	462	5.005	5.023	0.018
51	478	4.995	4.992	-0.003
51	503	4.999	4.995	-0.004
100	354	5.030	5.022	-0.009
100	363	5.010	5.016	0.007
100	366	4.999	4.999	0.000
100	383	4.995	5.004	0.010
100	417	4.997	5.016	0.019
101	513	5.015	4.978	-0.037
101	526	5.017	4.994	-0.024
101	532	5.027	5.004	-0.023
101	533	5.010	5.016	0.006
101	534	5.017	4.984	-0.034
	Max	5.030	5.029	0.019
	Average	5.010	5.004	-0.006
	Min	4.993	4.978	-0.037
	Std Dev	0.012	0.014	0.015

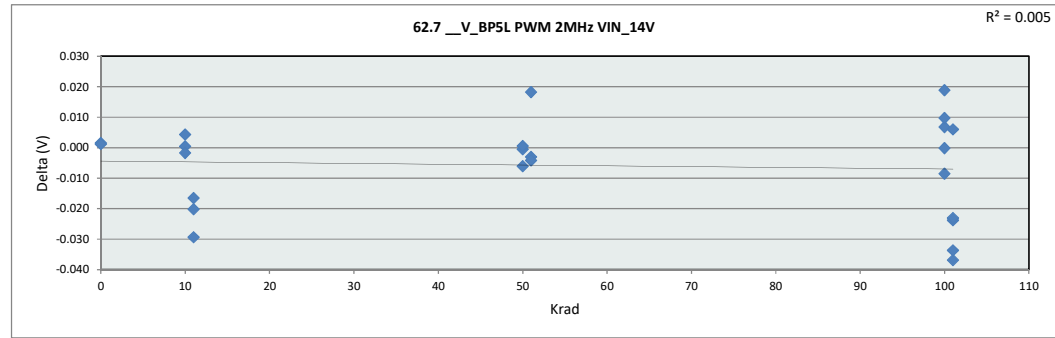

62.7 V_BP5L PWM 2MHz VIN		
Test Site	DAL	
Tester	ETS364	
Test Number	EB672303	
Max Limit	5.175	V
Min Limit	4.75	V

	0	10	11	50	51	100	101
LL	4.750	4.750	4.750	4.750	4.750	4.750	4.750
Min	5.020	4.994	4.987	4.989	4.992	4.999	4.978
Average	5.024	5.005	4.997	5.001	5.003	5.012	4.995
Max	5.029	5.024	5.005	5.009	5.023	5.022	5.016
UL	5.175	5.175	5.175	5.175	5.175	5.175	5.175

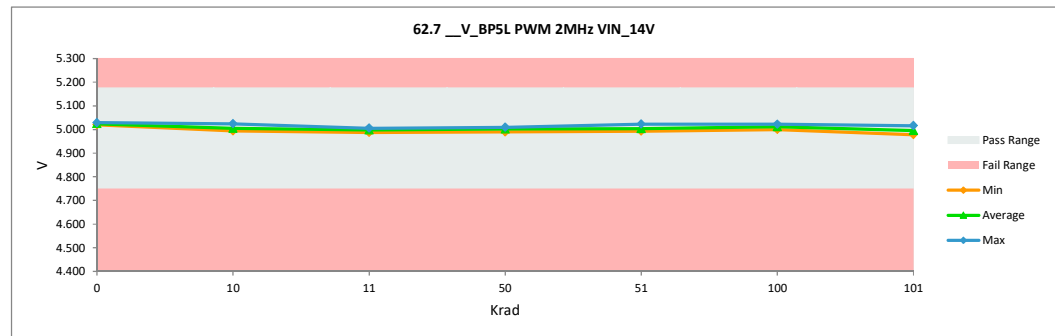

TID "HDR" Report
5962R2220102VXC

62.8_V_BP5H PWM 2MHz VIN		
Test Site	DAL	DAL
Tester	ETS364	ETS364
Test Number	EB672303	EB672303
Unit	V	V
Max Limit	5.175	5.175
Min Limit	4.75	4.75

Krad	Serial #	Pre_HDR_6013	Post_HDR_6013	Delta
0	1	5.003	5.003	0.001
0	2	5.019	5.020	0.001
10	182	5.000	4.998	-0.002
10	202	5.015	5.014	-0.001
10	204	5.022	5.021	-0.001
11	418	4.996	5.021	0.024
11	419	5.013	5.007	-0.005
11	443	5.010	4.990	-0.020
50	259	5.001	4.996	-0.005
50	346	4.996	4.990	-0.006
50	347	5.019	5.017	-0.002
51	462	5.011	5.006	-0.004
51	478	4.983	5.013	0.030
51	503	5.018	5.004	-0.014
100	354	5.011	5.009	-0.002
100	363	4.998	4.991	-0.008
100	366	4.991	4.985	-0.006
100	383	4.996	4.977	-0.019
100	417	5.005	5.001	-0.004
101	513	4.999	4.994	-0.005
101	526	4.995	5.000	0.005
101	532	5.010	4.987	-0.023
101	533	4.990	4.981	-0.009
101	534	4.988	4.972	-0.016
	Max	5.022	5.021	0.030
	Average	5.004	5.000	-0.004
	Min	4.983	4.972	-0.023
	Std Dev	0.011	0.014	0.012

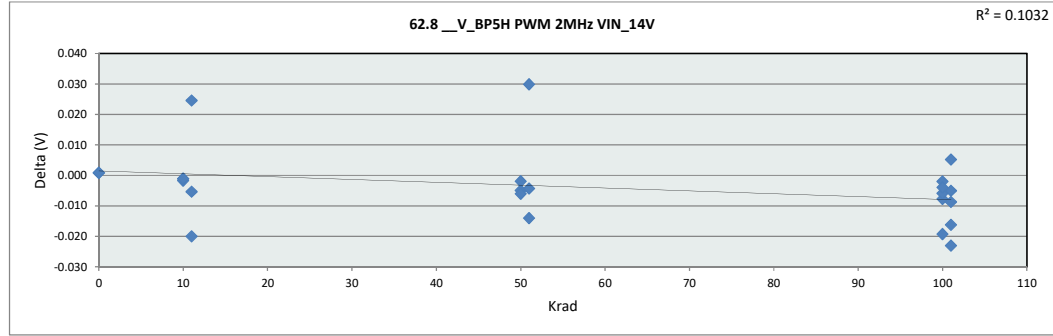

62.8_V_BP5H PWM 2MHz VI		
Test Site	DAL	
Tester	ETS364	
Test Number	EB672303	
Max Limit	5.175	V
Min Limit	4.75	V

	0	10	11	50	51	100	101
LL	4.750	4.750	4.750	4.750	4.750	4.750	4.750
Min	5.003	4.998	4.990	4.990	5.004	4.977	4.972
Average	5.012	5.011	5.006	5.001	5.008	4.993	4.987
Max	5.020	5.021	5.021	5.017	5.013	5.009	5.000
UL	5.175	5.175	5.175	5.175	5.175	5.175	5.175

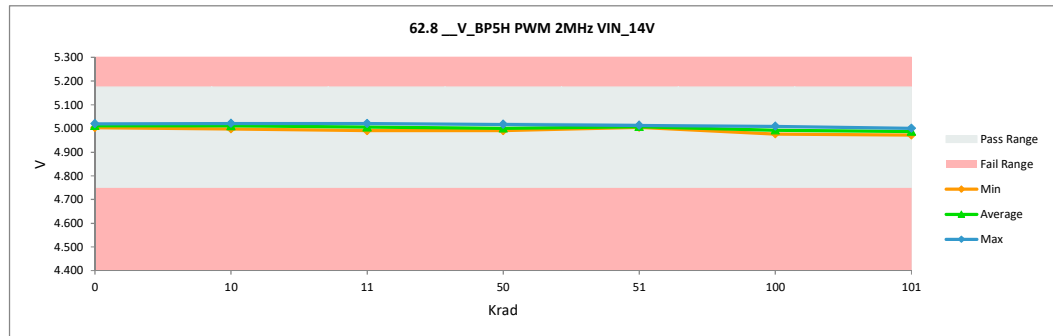

TID "HDR" Report
5962R2220102VXC

62.9_V_BP7L PWM 5MHz VIN		
Test Site	DAL	DAL
Tester	ETS364	ETS364
Test Number	EB672303	EB672303
Unit	V	V
Max Limit	7.35	7.35
Min Limit	6.65	6.65

Krad	Serial #	Pre_HDR_6013	Post_HDR_6013	Delta
0	1	7.022	7.020	-0.002
0	2	6.981	6.974	-0.007
10	182	7.011	7.011	-0.001
10	202	7.031	7.030	-0.001
10	204	7.028	6.983	-0.044
11	418	7.028	7.027	-0.002
11	419	7.015	6.993	-0.022
11	443	7.032	7.053	0.021
50	259	7.074	7.066	-0.008
50	346	7.057	7.033	-0.024
50	347	7.015	7.013	-0.002
51	462	7.064	7.011	-0.053
51	478	7.039	6.974	-0.065
51	503	7.045	7.037	-0.008
100	354	7.064	7.103	0.039
100	363	7.072	7.060	-0.012
100	366	7.005	6.977	-0.029
100	383	7.037	7.021	-0.016
100	417	7.095	7.122	0.027
101	513	7.058	7.034	-0.024
101	526	7.032	6.998	-0.034
101	532	7.026	7.000	-0.026
101	533	7.016	7.007	-0.008
101	534	7.055	7.033	-0.022
Max		7.095	7.122	0.039
Average		7.038	7.024	-0.013
Min		6.981	6.974	-0.065
Std Dev		0.026	0.037	0.023

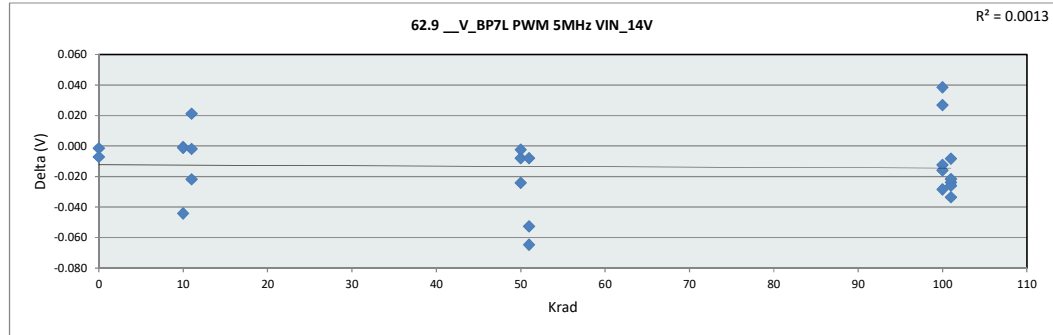

62.9_V_BP7L PWM 5MHz VIN		
Test Site	DAL	
Tester	ETS364	
Test Number	EB672303	
Max Limit	7.35	V
Min Limit	6.65	V

Krad	0	10	11	50	51	100	101
LL	6.650	6.650	6.650	6.650	6.650	6.650	6.650
Min	6.974	6.983	6.993	7.013	6.974	6.977	6.998
Average	6.997	7.008	7.024	7.037	7.007	7.056	7.015
Max	7.020	7.030	7.053	7.066	7.037	7.122	7.034
UL	7.350	7.350	7.350	7.350	7.350	7.350	7.350

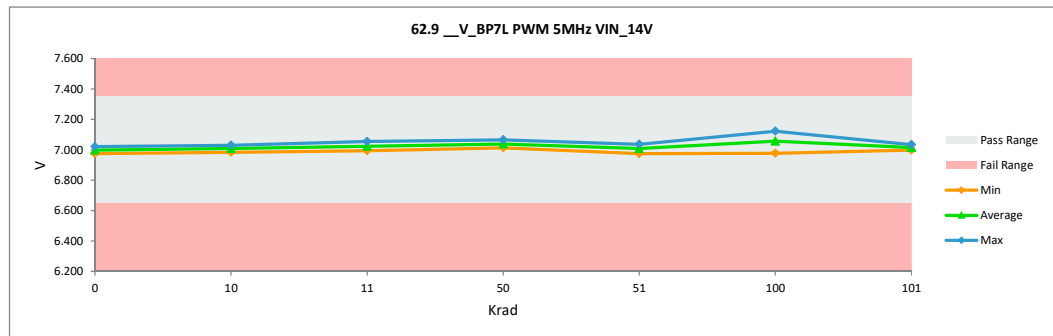

TID "HDR" Report
5962R2220102VXC

62.10_V_BP5L PWM 5MHz VIN		
Test Site	DAL	DAL
Tester	ETS364	ETS364
Test Number	EB672303	EB672303
Unit	V	V
Max Limit	5.175	5.175
Min Limit	4.75	4.75

Krad	Serial #	Pre_HDR_6013	Post_HDR_6013	Delta
0	1	5.021	5.023	0.001
0	2	5.014	5.016	0.002
10	182	4.988	4.987	-0.001
10	202	4.994	4.991	-0.003
10	204	5.014	5.018	0.004
11	418	5.016	4.995	-0.021
11	419	5.017	5.000	-0.017
11	443	5.011	4.982	-0.029
50	259	5.002	5.000	-0.002
50	346	4.990	4.982	-0.008
50	347	5.003	5.002	-0.001
51	462	4.999	5.017	0.018
51	478	4.991	4.986	-0.004
51	503	4.995	4.990	-0.005
100	354	5.025	5.015	-0.010
100	363	5.004	5.023	0.018
100	366	4.994	4.993	-0.001
100	383	4.989	4.996	0.007
100	417	4.993	5.009	0.016
101	513	5.010	4.971	-0.040
101	526	5.012	4.987	-0.026
101	532	5.022	4.998	-0.025
101	533	5.005	5.010	0.005
101	534	5.012	4.978	-0.034
Max		5.025	5.023	0.018
Average		5.005	4.999	-0.006
Min		4.988	4.971	-0.040
Std Dev		0.012	0.015	0.016

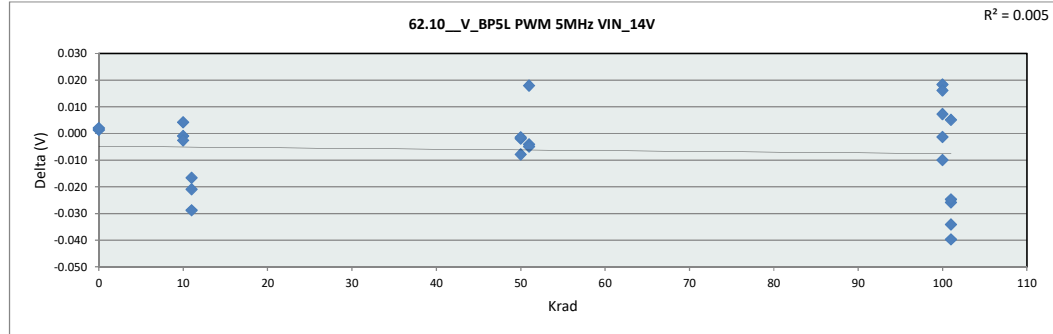

62.10_V_BP5L PWM 5MHz VI		
Test Site	DAL	
Tester	ETS364	
Test Number	EB672303	
Max Limit	5.175	V
Min Limit	4.75	V

Krad	0	10	11	50	51	100	101
LL	4.750	4.750	4.750	4.750	4.750	4.750	4.750
Min	5.016	4.987	4.982	4.982	4.987	4.993	4.971
Average	5.019	4.999	4.992	4.995	4.998	5.007	4.989
Max	5.023	5.018	5.000	5.002	5.017	5.023	5.010
UL	5.175	5.175	5.175	5.175	5.175	5.175	5.175

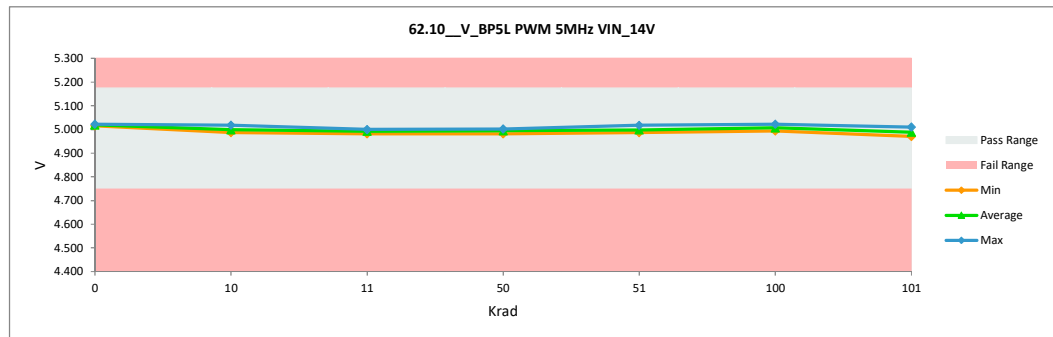

TID "HDR" Report
5962R2220102VXC

62.11_V_BP5H PWM 5MHz VIN		
Test Site	DAL	DAL
Tester	ETS364	ETS364
Test Number	EB672303	EB672303
Unit	V	V
Max Limit	5.175	5.175
Min Limit	4.75	4.75

Krad	Serial #	Pre_HDR_6013	Post_HDR_6013	Delta
0	1	5.006	5.007	0.001
0	2	5.022	5.023	0.001
10	182	5.004	5.002	-0.002
10	202	5.019	5.017	-0.001
10	204	5.027	5.026	-0.001
11	418	4.999	5.024	0.025
11	419	5.016	5.012	-0.005
11	443	5.014	4.993	-0.021
50	259	5.003	5.000	-0.004
50	346	5.000	4.994	-0.006
50	347	5.023	5.021	-0.003
51	462	5.016	5.009	-0.007
51	478	4.988	5.017	0.029
51	503	5.023	5.007	-0.016
100	354	5.015	5.012	-0.003
100	363	5.002	4.993	-0.009
100	366	4.994	4.990	-0.005
100	383	5.000	4.979	-0.020
100	417	5.009	5.005	-0.004
101	513	5.003	4.998	-0.005
101	526	4.999	5.005	0.006
101	532	5.014	4.991	-0.023
101	533	4.994	4.984	-0.009
101	534	4.991	4.975	-0.016
	Max	5.027	5.026	0.029
	Average	5.008	5.004	-0.004
	Min	4.988	4.975	-0.023
	Std Dev	0.011	0.014	0.012

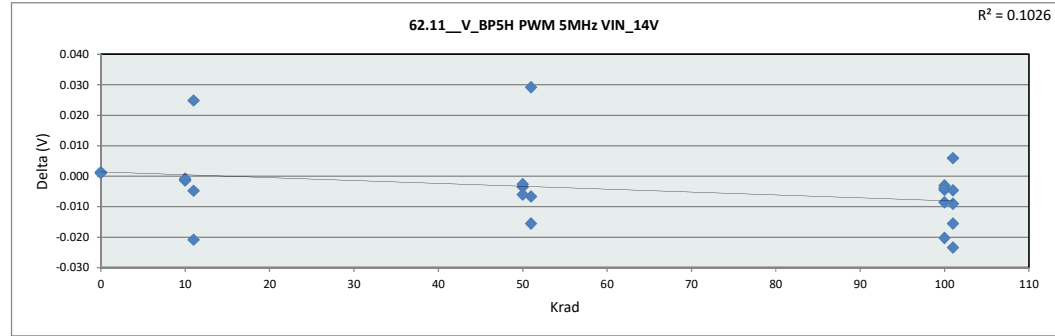

62.11_V_BP5H PWM 5MHz V1		
Test Site	DAL	
Tester	ETS364	
Test Number	EB672303	
Max Limit	5.175	V
Min Limit	4.75	V

Krad	0	10	11	50	51	100	101
LL	4.750	4.750	4.750	4.750	4.750	4.750	4.750
Min	5.007	5.002	4.993	4.994	5.007	4.979	4.975
Average	5.015	5.015	5.010	5.005	5.011	4.996	4.991
Max	5.023	5.026	5.024	5.021	5.017	5.012	5.005
UL	5.175	5.175	5.175	5.175	5.175	5.175	5.175

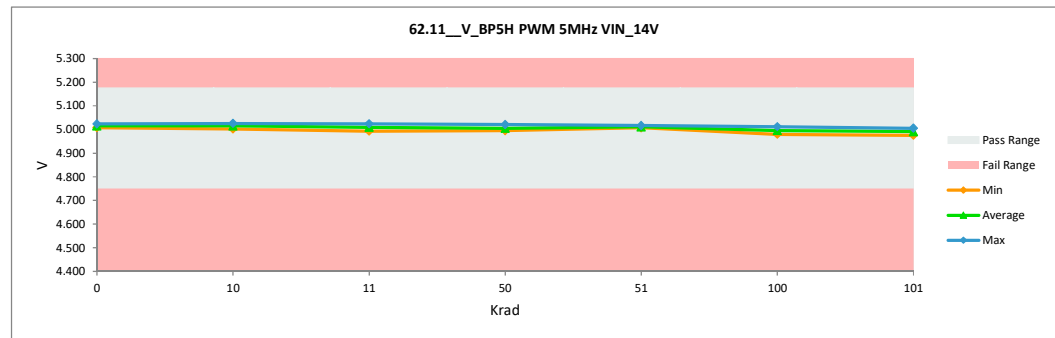

TID "HDR" Report
5962R2220102VXC

62.12_V_BP7L IIM 500kHz VIN		
Test Site	DAL	DAL
Tester	ETS364	ETS364
Test Number	EB672303	EB672303
Unit	V	V
Max Limit	7.35	7.35
Min Limit	6.65	6.65

Krad	Serial #	Pre_HDR_6013	Post_HDR_6013	Delta
0	1	7.027	7.026	-0.001
0	2	6.987	6.986	-0.001
10	182	7.016	7.015	-0.001
10	202	7.037	7.035	-0.002
10	204	7.032	6.988	-0.044
11	418	7.032	7.032	0.000
11	419	7.020	6.998	-0.022
11	443	7.036	7.059	0.023
50	259	7.081	7.071	-0.009
50	346	7.061	7.043	-0.019
50	347	7.021	7.015	-0.007
51	462	7.069	7.016	-0.053
51	478	7.044	6.979	-0.065
51	503	7.050	7.042	-0.007
100	354	7.069	7.103	0.035
100	363	7.078	7.076	-0.002
100	366	7.011	6.987	-0.024
100	383	7.042	7.024	-0.018
100	417	7.099	7.126	0.027
101	513	7.062	7.042	-0.020
101	526	7.036	7.006	-0.030
101	532	7.031	7.009	-0.022
101	533	7.019	7.011	-0.008
101	534	7.060	7.039	-0.021
	Max	7.099	7.126	0.035
	Average	7.043	7.030	-0.012
	Min	6.987	6.979	-0.065
	Std Dev	0.026	0.037	0.023

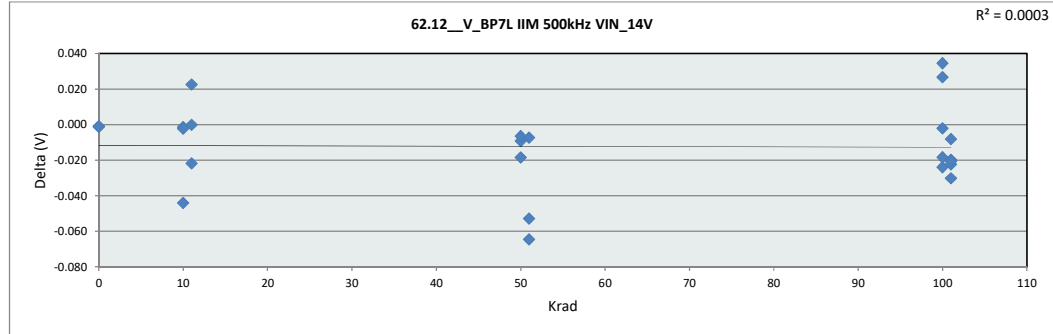

62.12_V_BP7L IIM 500kHz V		
Test Site	DAL	
Tester	ETS364	
Test Number	EB672303	
Max Limit	7.35	V
Min Limit	6.65	V

	0	10	11	50	51	100	101
LL	6.650	6.650	6.650	6.650	6.650	6.650	6.650
Min	6.986	6.988	6.998	7.015	6.979	6.987	7.006
Average	7.006	7.012	7.030	7.043	7.013	7.063	7.021
Max	7.026	7.035	7.059	7.071	7.042	7.126	7.042
UL	7.350	7.350	7.350	7.350	7.350	7.350	7.350

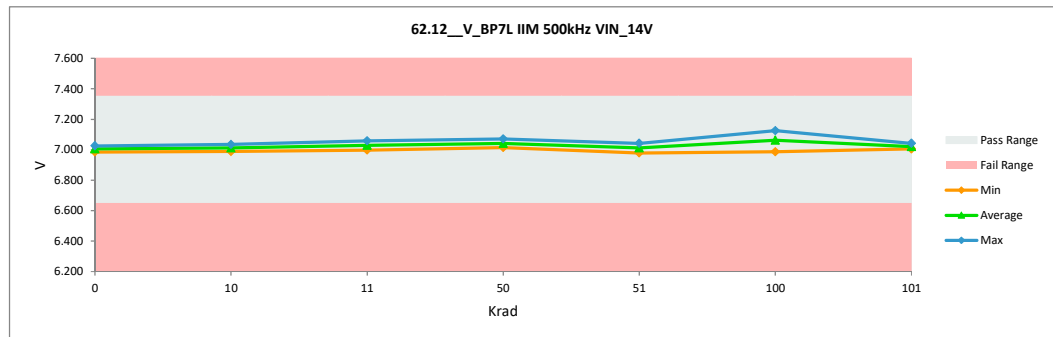

TID "HDR" Report
5962R2220102VXC

62.13_V_BP5L_IIM_500kHz_VIN		
Test Site	DAL	DAL
Tester	ETS364	ETS364
Test Number	EB672303	EB672303
Unit	V	V
Max Limit	5.175	5.175
Min Limit	4.75	4.75

Krad	Serial #	Pre_HDR_6013	Post_HDR_6013	Delta
0	1	5.020	5.021	0.001
0	2	5.012	5.012	0.001
10	182	4.985	4.984	0.000
10	202	4.991	4.989	-0.002
10	204	5.012	5.015	0.003
11	418	5.014	4.992	-0.022
11	419	5.014	4.998	-0.017
11	443	5.009	4.980	-0.029
50	259	4.999	4.997	-0.002
50	346	4.987	4.980	-0.008
50	347	5.001	4.999	-0.001
51	462	4.997	5.015	0.017
51	478	4.989	4.984	-0.004
51	503	4.992	4.987	-0.005
100	354	5.022	5.011	-0.011
100	363	5.002	5.007	0.005
100	366	4.992	4.990	-0.002
100	383	4.987	4.994	0.007
100	417	4.990	5.006	0.016
101	513	5.008	4.971	-0.037
101	526	5.010	4.985	-0.025
101	532	5.020	4.996	-0.024
101	533	5.003	5.007	0.004
101	534	5.010	4.976	-0.034
Max		5.022	5.021	0.017
Average		5.003	4.996	-0.007
Min		4.985	4.971	-0.037
Std Dev		0.012	0.014	0.015

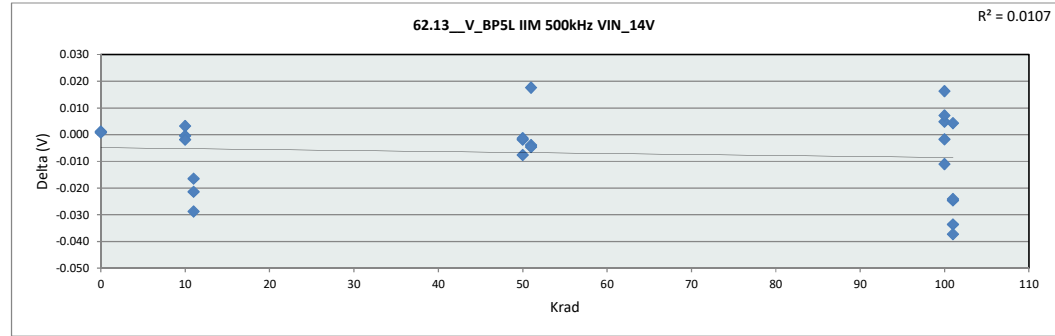

62.13_V_BP5L_IIM_500kHz_V		
Test Site	DAL	
Tester	ETS364	
Test Number	EB672303	
Max Limit	5.175	V
Min Limit	4.75	V

Krad	0	10	11	50	51	100	101
LL	4.750	4.750	4.750	4.750	4.750	4.750	4.750
Min	5.012	4.984	4.980	4.980	4.985	4.990	4.971
Average	5.017	4.996	4.990	4.992	4.995	5.002	4.987
Max	5.021	5.015	4.998	4.999	5.015	5.011	5.007
UL	5.175	5.175	5.175	5.175	5.175	5.175	5.175

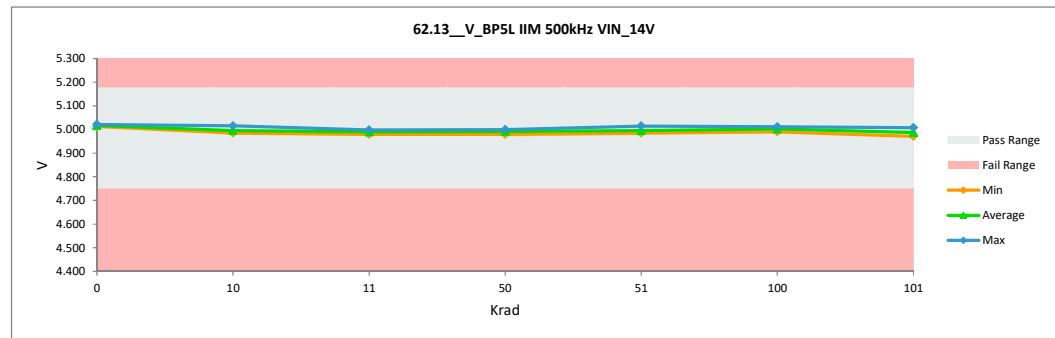

TID "HDR" Report
5962R2220102VXC

62.14_V_BP5H_IIM_500kHz_VIN		
Test Site	DAL	DAL
Tester	ETS364	ETS364
Test Number	EB672303	EB672303
Unit	V	V
Max Limit	5.175	5.175
Min Limit	4.75	4.75

Krad	Serial #	Pre_HDR_6013	Post_HDR_6013	Delta
0	1	5.000	5.000	0.001
0	2	5.017	5.017	0.001
10	182	4.997	4.995	-0.002
10	202	5.012	5.011	-0.001
10	204	5.019	5.018	-0.001
11	418	4.994	5.018	0.024
11	419	5.010	5.004	-0.006
11	443	5.007	4.988	-0.019
50	259	4.998	4.993	-0.005
50	346	4.994	4.987	-0.006
50	347	5.016	5.014	-0.002
51	462	5.008	5.004	-0.005
51	478	4.981	5.011	0.030
51	503	5.015	5.001	-0.014
100	354	5.009	5.006	-0.003
100	363	4.996	4.988	-0.008
100	366	4.989	4.983	-0.006
100	383	4.993	4.974	-0.019
100	417	5.002	4.998	-0.004
101	513	4.997	4.991	-0.005
101	526	4.992	4.997	0.005
101	532	5.008	4.985	-0.023
101	533	4.987	4.978	-0.009
101	534	4.985	4.969	-0.016
	Max	5.019	5.018	0.030
	Average	5.001	4.997	-0.004
	Min	4.981	4.969	-0.023
	Std Dev	0.011	0.014	0.012

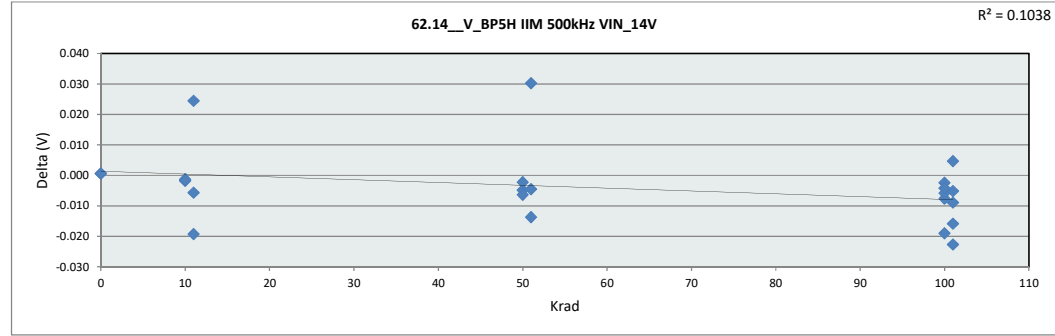

62.14_V_BP5H_IIM_500kHz_V		
Test Site	DAL	
Tester	ETS364	
Test Number	EB672303	
Max Limit	5.175	V
Min Limit	4.75	V

	0	10	11	50	51	100	101
LL	4.750	4.750	4.750	4.750	4.750	4.750	4.750
Min	5.000	4.995	4.988	4.987	5.001	4.974	4.969
Average	5.009	5.008	5.004	4.998	5.005	4.990	4.984
Max	5.017	5.018	5.018	5.014	5.011	5.006	4.997
UL	5.175	5.175	5.175	5.175	5.175	5.175	5.175

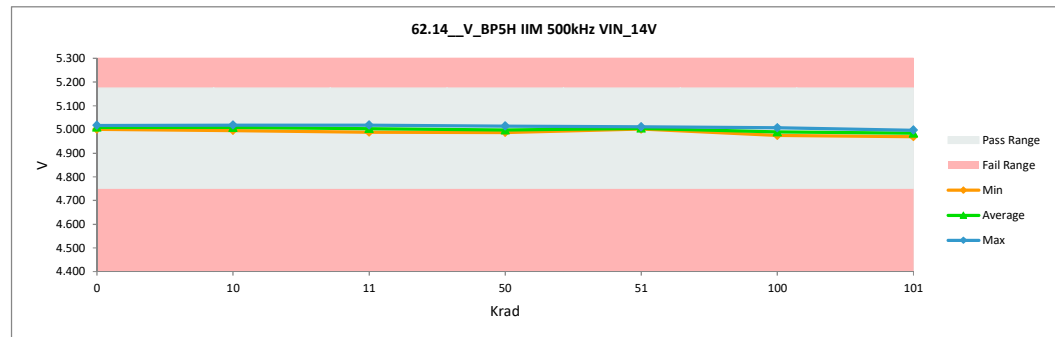

TID "HDR" Report
5962R2220102VXC

62.15_V_BP7L_IIM_1MHz_VIN_14V		
Test Site	DAL	DAL
Tester	ETS364	ETS364
Test Number	EB672303	EB672303
Unit	V	V
Max Limit	7.35	7.35
Min Limit	6.65	6.65

Krad	Serial #	Pre_HDR_6013	Post_HDR_6013	Delta
0	1	7.023	7.022	-0.001
0	2	6.983	6.983	-0.001
10	182	7.013	7.011	-0.002
10	202	7.033	7.031	-0.003
10	204	7.028	6.984	-0.044
11	418	7.029	7.029	0.000
11	419	7.016	6.994	-0.022
11	443	7.033	7.055	0.022
50	259	7.077	7.068	-0.009
50	346	7.058	7.038	-0.019
50	347	7.018	7.011	-0.007
51	462	7.065	7.012	-0.053
51	478	7.040	6.975	-0.065
51	503	7.046	7.039	-0.007
100	354	7.065	7.101	0.035
100	363	7.074	7.073	-0.001
100	366	7.008	6.983	-0.025
100	383	7.038	7.021	-0.018
100	417	7.095	7.122	0.027
101	513	7.058	7.038	-0.020
101	526	7.032	7.002	-0.031
101	532	7.028	7.006	-0.022
101	533	7.016	7.007	-0.008
101	534	7.056	7.035	-0.021
Max		7.095	7.122	0.035
Average		7.039	7.027	-0.012
Min		6.983	6.975	-0.065
Std Dev		0.026	0.037	0.023

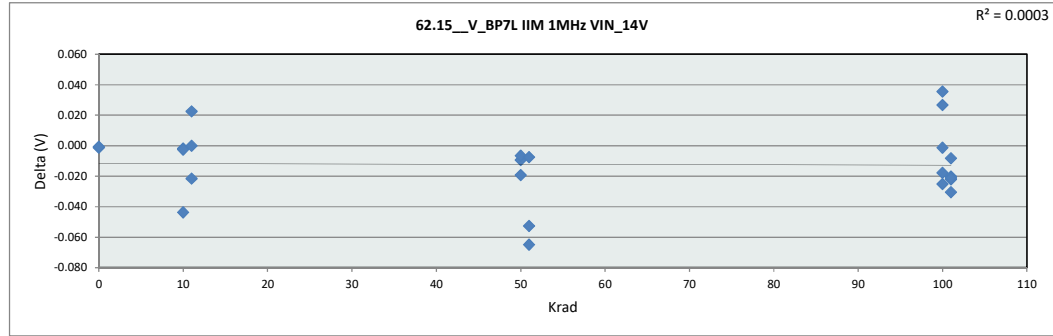

62.15_V_BP7L_IIM_1MHz_VIN		
Test Site	DAL	
Tester	ETS364	
Test Number	EB672303	
Max Limit	7.35	V
Min Limit	6.65	V

	0	10	11	50	51	100	101
LL	6.650	6.650	6.650	6.650	6.650	6.650	6.650
Min	6.983	6.984	6.994	7.011	6.975	6.983	7.002
Average	7.002	7.009	7.026	7.039	7.009	7.060	7.018
Max	7.022	7.031	7.055	7.068	7.039	7.122	7.038
UL	7.350	7.350	7.350	7.350	7.350	7.350	7.350

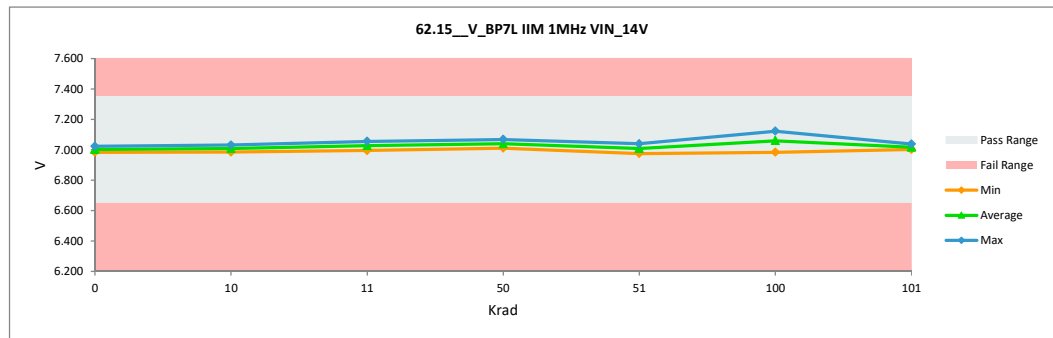

TID "HDR" Report
5962R2220102VXC

62.16_V_BP5L IIM 1MHz VIN		
Test Site	DAL	DAL
Tester	ETS364	ETS364
Test Number	EB672303	EB672303
Unit	V	V
Max Limit	5.175	5.175
Min Limit	4.75	4.75

Krad	Serial #	Pre_HDR_6013	Post_HDR_6013	Delta
0	1	5.022	5.023	0.002
0	2	5.014	5.015	0.001
10	182	4.988	4.988	0.000
10	202	4.993	4.991	-0.002
10	204	5.015	5.018	0.003
11	418	5.016	4.995	-0.021
11	419	5.017	5.000	-0.017
11	443	5.011	4.982	-0.029
50	259	5.002	5.000	-0.001
50	346	4.990	4.983	-0.007
50	347	5.003	5.002	-0.001
51	462	5.000	5.017	0.018
51	478	4.991	4.987	-0.004
51	503	4.994	4.989	-0.004
100	354	5.025	5.015	-0.010
100	363	5.005	5.010	0.006
100	366	4.994	4.993	-0.001
100	383	4.989	4.997	0.008
100	417	4.993	5.010	0.017
101	513	5.010	4.974	-0.037
101	526	5.013	4.988	-0.025
101	532	5.022	4.998	-0.024
101	533	5.005	5.010	0.005
101	534	5.012	4.979	-0.034
	Max	5.025	5.023	0.018
	Average	5.005	4.999	-0.007
	Min	4.988	4.974	-0.037
	Std Dev	0.012	0.014	0.015

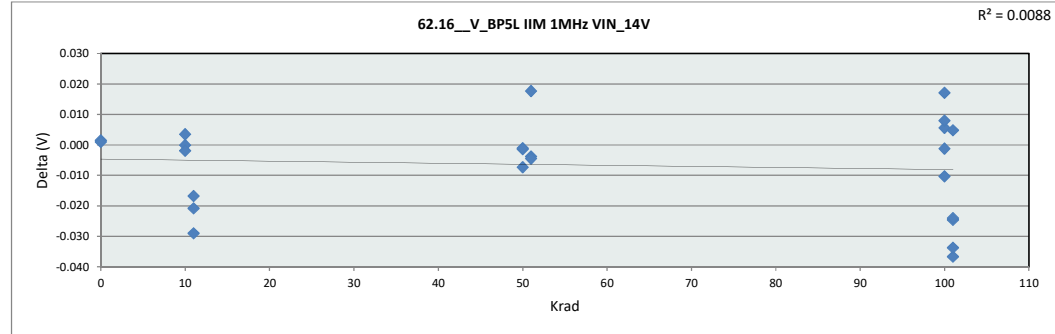

62.16_V_BP5L IIM 1MHz VIN		
Test Site	DAL	
Tester	ETS364	
Test Number	EB672303	
Max Limit	5.175	V
Min Limit	4.75	V

Krad	0	10	11	50	51	100	101
LL	4.750	4.750	4.750	4.750	4.750	4.750	4.750
Min	5.015	4.988	4.982	4.983	4.987	4.993	4.974
Average	5.019	4.999	4.992	4.995	4.998	5.005	4.990
Max	5.024	5.018	5.000	5.002	5.017	5.015	5.010
UL	5.175	5.175	5.175	5.175	5.175	5.175	5.175

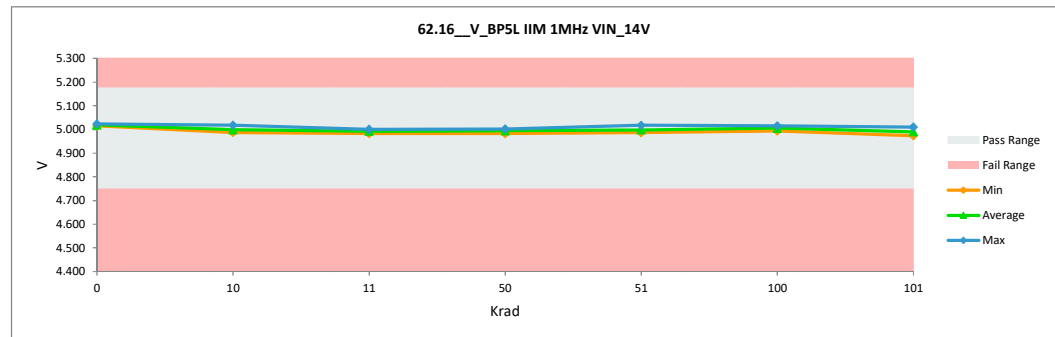

TID "HDR" Report
5962R2220102VXC

62.17_V_BP5H_IIM_1MHz_VIN		
Test Site	DAL	DAL
Tester	ETS364	ETS364
Test Number	EB672303	EB672303
Unit	V	V
Max Limit	5.175	5.175
Min Limit	4.75	4.75

Krad	Serial #	Pre_HDR_6013	Post_HDR_6013	Delta
0	1	5.001	5.001	0.001
0	2	5.017	5.018	0.001
10	182	4.998	4.996	-0.002
10	202	5.013	5.011	-0.001
10	204	5.020	5.019	-0.002
11	418	4.995	5.019	0.024
11	419	5.011	5.005	-0.006
11	443	5.008	4.989	-0.019
50	259	4.998	4.993	-0.005
50	346	4.994	4.988	-0.006
50	347	5.017	5.015	-0.002
51	462	5.009	5.004	-0.005
51	478	4.981	5.011	0.030
51	503	5.016	5.002	-0.014
100	354	5.010	5.007	-0.003
100	363	4.996	4.989	-0.008
100	366	4.990	4.984	-0.006
100	383	4.994	4.975	-0.019
100	417	5.003	4.999	-0.004
101	513	4.997	4.992	-0.005
101	526	4.993	4.998	0.005
101	532	5.008	4.986	-0.023
101	533	4.988	4.979	-0.009
101	534	4.986	4.970	-0.016
	Max	5.020	5.019	0.030
	Average	5.002	4.998	-0.004
	Min	4.981	4.970	-0.023
	Std Dev	0.011	0.014	0.012

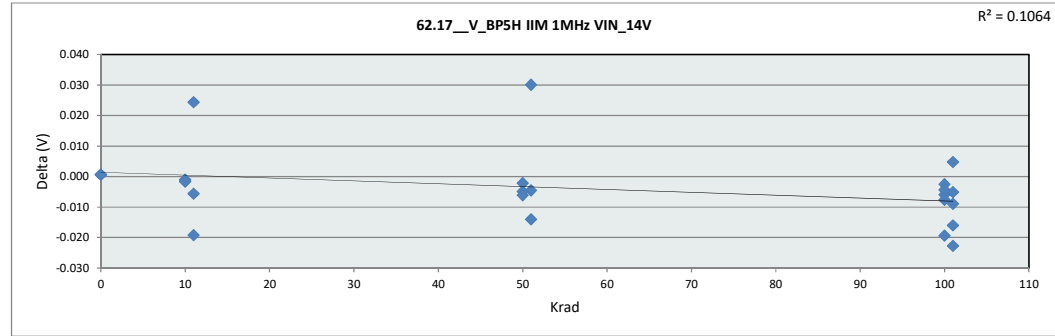

62.17_V_BP5H_IIM_1MHz_VIN		
Test Site	DAL	
Tester	ETS364	
Test Number	EB672303	
Max Limit	5.175	V
Min Limit	4.75	V

Krad	0	10	11	50	51	100	101
LL	4.750	4.750	4.750	4.750	4.750	4.750	4.750
Min	5.001	4.996	4.989	4.988	5.002	4.975	4.970
Average	5.010	5.009	5.004	4.999	5.006	4.991	4.985
Max	5.018	5.019	5.019	5.015	5.011	5.007	4.998
UL	5.175	5.175	5.175	5.175	5.175	5.175	5.175

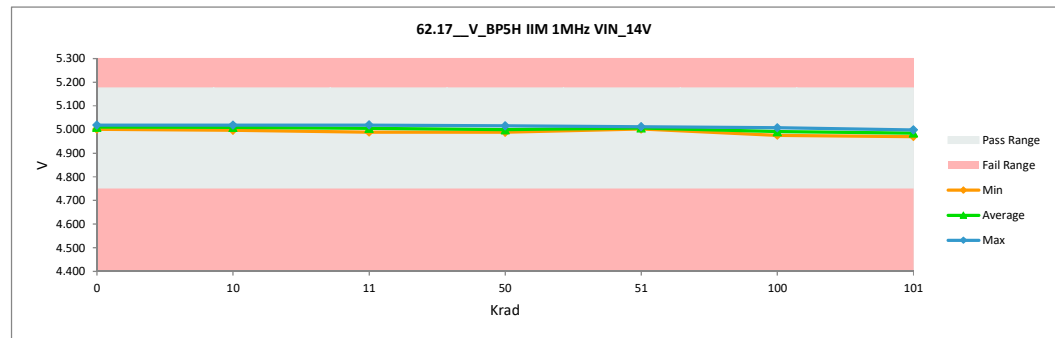

TID "HDR" Report
5962R2220102VXC

62.18_V_BP7L IIM 2MHz VIN		
Test Site	DAL	DAL
Tester	ETS364	ETS364
Test Number	EB672303	EB672303
Unit	V	V
Max Limit	7.35	7.35
Min Limit	6.65	6.65

Krad	Serial #	Pre_HDR_6013	Post_HDR_6013	Delta
0	1	7.016	7.015	-0.002
0	2	6.977	6.975	-0.001
10	182	7.005	7.004	-0.002
10	202	7.026	7.024	-0.002
10	204	7.021	6.977	-0.044
11	418	7.022	7.022	0.000
11	419	7.009	6.988	-0.021
11	443	7.026	7.048	0.023
50	259	7.070	7.061	-0.009
50	346	7.050	7.030	-0.021
50	347	7.011	7.005	-0.006
51	462	7.058	7.005	-0.053
51	478	7.034	6.968	-0.065
51	503	7.039	7.032	-0.007
100	354	7.058	7.095	0.036
100	363	7.067	7.067	0.000
100	366	7.001	6.975	-0.026
100	383	7.031	7.014	-0.017
100	417	7.089	7.115	0.026
101	513	7.051	7.030	-0.021
101	526	7.026	6.995	-0.031
101	532	7.021	6.997	-0.023
101	533	7.009	7.000	-0.009
101	534	7.049	7.027	-0.022
	Max	7.089	7.115	0.036
	Average	7.032	7.019	-0.012
	Min	6.977	6.968	-0.065
	Std Dev	0.026	0.037	0.023

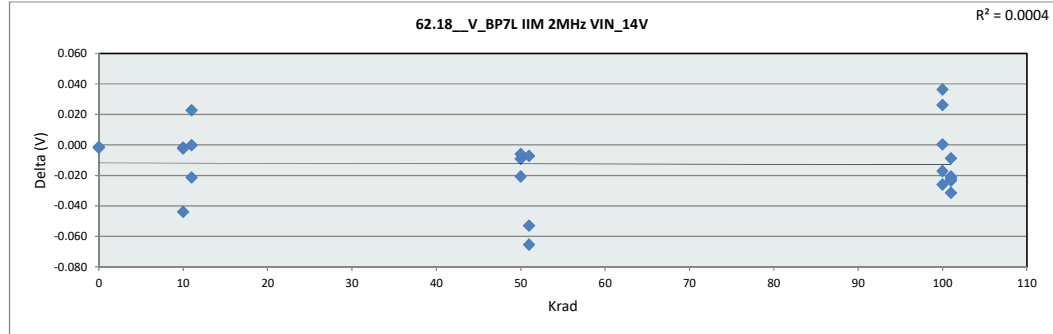

62.18_V_BP7L IIM 2MHz VIN		
Test Site	DAL	
Tester	ETS364	
Test Number	EB672303	
Max Limit	7.35	V
Min Limit	6.65	V

	0	10	11	50	51	100	101
LL	6.650	6.650	6.650	6.650	6.650	6.650	6.650
Min	6.975	6.977	6.988	7.005	6.968	6.975	6.995
Average	6.995	7.001	7.019	7.032	7.002	7.053	7.010
Max	7.015	7.024	7.048	7.061	7.032	7.115	7.030
UL	7.350	7.350	7.350	7.350	7.350	7.350	7.350

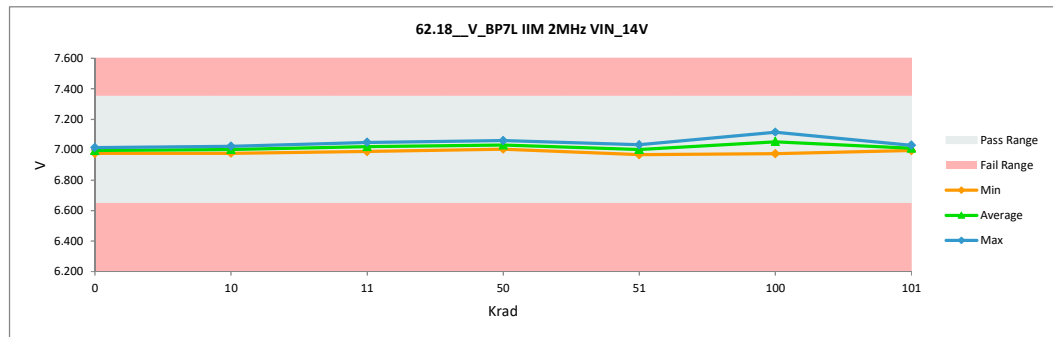

TID "HDR" Report
5962R2220102VXC

62.19_V_BP5L IIM 2MHz VIN		
Test Site	DAL	DAL
Tester	ETS364	ETS364
Test Number	EB672303	EB672303
Unit	V	V
Max Limit	5.175	5.175
Min Limit	4.75	4.75

Krad	Serial #	Pre_HDR_6013	Post_HDR_6013	Delta
0	1	5.027	5.029	0.002
0	2	5.019	5.020	0.001
10	182	4.993	4.994	0.001
10	202	4.998	4.997	-0.002
10	204	5.020	5.024	0.004
11	418	5.020	5.000	-0.020
11	419	5.022	5.005	-0.017
11	443	5.016	4.987	-0.030
50	259	5.007	5.006	0.000
50	346	4.995	4.989	-0.006
50	347	5.008	5.009	0.000
51	462	5.005	5.023	0.018
51	478	4.996	4.992	-0.003
51	503	4.999	4.995	-0.004
100	354	5.030	5.022	-0.008
100	363	5.010	5.016	0.007
100	366	4.999	4.999	0.000
100	383	4.995	5.004	0.010
100	417	4.998	5.016	0.018
101	513	5.015	4.978	-0.037
101	526	5.018	4.994	-0.024
101	532	5.027	5.003	-0.024
101	533	5.010	5.016	0.006
101	534	5.017	4.984	-0.034
Max		5.030	5.029	0.018
Average		5.010	5.004	-0.006
Min		4.993	4.978	-0.037
Std Dev		0.012	0.014	0.015

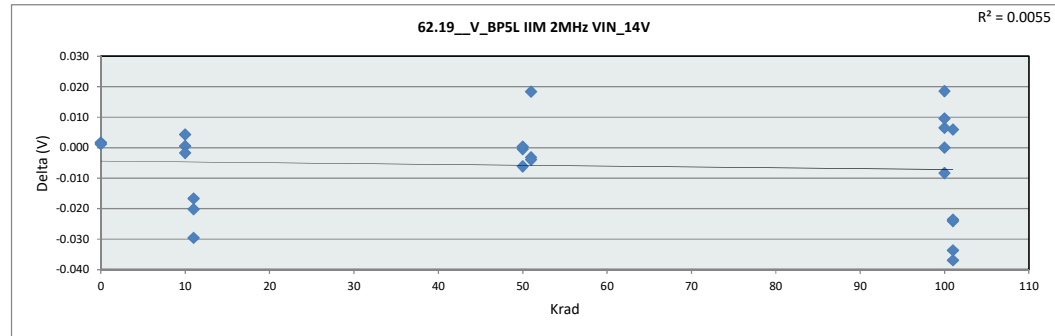

62.19_V_BP5L IIM 2MHz VIN		
Test Site	DAL	
Tester	ETS364	
Test Number	EB672303	
Max Limit	5.175	V
Min Limit	4.75	V

Krad	0	10	11	50	51	100	101
LL	4.750	4.750	4.750	4.750	4.750	4.750	4.750
Min	5.020	4.994	4.987	4.989	4.992	4.999	4.978
Average	5.025	5.005	4.998	5.001	5.003	5.012	4.995
Max	5.029	5.024	5.006	5.009	5.023	5.022	5.016
UL	5.175	5.175	5.175	5.175	5.175	5.175	5.175

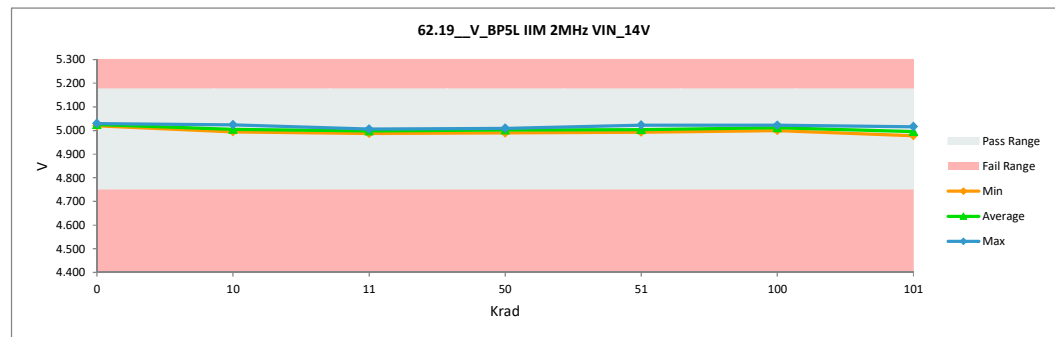

TID "HDR" Report
5962R2220102VXC

62.20_V_BP5H_IIM_2MHz_VIN		
Test Site	DAL	DAL
Tester	ETS364	ETS364
Test Number	EB672303	EB672303
Unit	V	V
Max Limit	5.175	5.175
Min Limit	4.75	4.75

Krad	Serial #	Pre_HDR_6013	Post_HDR_6013	Delta
0	1	5.002	5.003	0.001
0	2	5.019	5.020	0.001
10	182	5.000	4.998	-0.002
10	202	5.014	5.013	-0.001
10	204	5.022	5.020	-0.002
11	418	4.996	5.020	0.024
11	419	5.012	5.007	-0.006
11	443	5.010	4.990	-0.020
50	259	5.000	4.995	-0.005
50	346	4.996	4.990	-0.006
50	347	5.018	5.016	-0.002
51	462	5.011	5.006	-0.005
51	478	4.983	5.013	0.030
51	503	5.018	5.003	-0.014
100	354	5.011	5.009	-0.002
100	363	4.998	4.990	-0.008
100	366	4.991	4.985	-0.006
100	383	4.996	4.976	-0.020
100	417	5.005	5.000	-0.004
101	513	4.999	4.993	-0.005
101	526	4.995	5.000	0.005
101	532	5.010	4.987	-0.023
101	533	4.989	4.981	-0.009
101	534	4.988	4.971	-0.016
	Max	5.022	5.020	0.030
	Average	5.003	4.999	-0.004
	Min	4.983	4.971	-0.023
	Std Dev	0.011	0.014	0.012

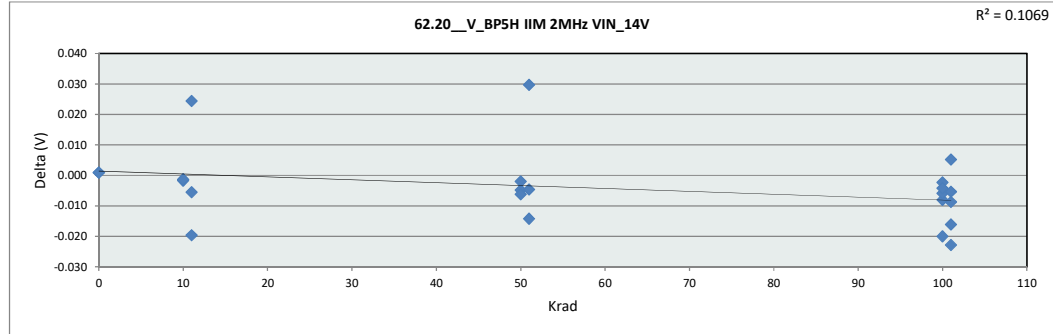

62.20_V_BP5H_IIM_2MHz_VIN		
Test Site	DAL	
Tester	ETS364	
Test Number	EB672303	
Max Limit	5.175	V
Min Limit	4.75	V

	0	10	11	50	51	100	101
LL	4.750	4.750	4.750	4.750	4.750	4.750	4.750
Min	5.003	4.998	4.990	4.990	5.004	4.976	4.971
Average	5.011	5.010	5.006	5.000	5.007	4.992	4.986
Max	5.020	5.020	5.020	5.016	5.013	5.009	5.000
UL	5.175	5.175	5.175	5.175	5.175	5.175	5.175

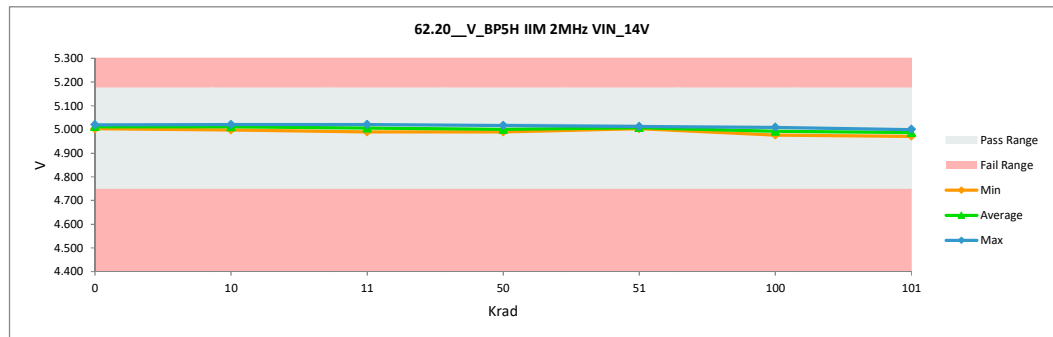

TID "HDR" Report
5962R2220102VXC

62.21_V_BP7L IIM 5MHz VIN		
Test Site	DAL	DAL
Tester	ETS364	ETS364
Test Number	EB672303	EB672303
Unit	V	V
Max Limit	7.35	7.35
Min Limit	6.65	6.65

Krad	Serial #	Pre_HDR_6013	Post_HDR_6013	Delta
0	1	6.996	6.993	-0.003
0	2	6.957	6.955	-0.002
10	182	6.984	6.983	-0.002
10	202	7.005	7.003	-0.002
10	204	7.001	6.957	-0.044
11	418	7.003	7.002	-0.001
11	419	6.989	6.968	-0.021
11	443	7.006	7.029	0.024
50	259	7.049	7.040	-0.009
50	346	7.030	7.008	-0.022
50	347	6.990	6.986	-0.005
51	462	7.038	6.984	-0.054
51	478	7.014	6.947	-0.067
51	503	7.020	7.012	-0.008
100	354	7.038	7.075	0.037
100	363	7.046	7.050	0.004
100	366	6.981	6.956	-0.025
100	383	7.012	6.994	-0.017
100	417	7.070	7.095	0.024
101	513	7.030	7.007	-0.022
101	526	7.008	6.975	-0.033
101	532	7.001	6.975	-0.026
101	533	6.988	6.978	-0.010
101	534	7.029	7.006	-0.023
Max		7.070	7.095	0.037
Average		7.012	6.999	-0.013
Min		6.957	6.947	-0.067
Std Dev		0.026	0.037	0.024

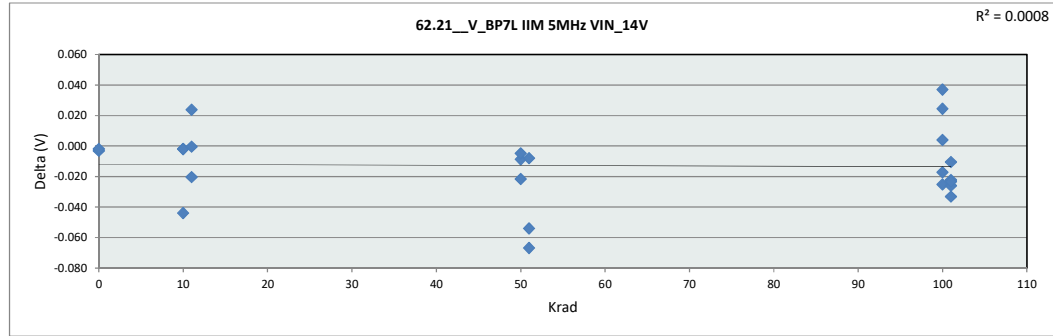

62.21_V_BP7L IIM 5MHz VIN		
Test Site	DAL	
Tester	ETS364	
Test Number	EB672303	
Max Limit	7.35	V
Min Limit	6.65	V

	0	10	11	50	51	100	101
LL	6.650	6.650	6.650	6.650	6.650	6.650	6.650
Min	6.955	6.957	6.968	6.986	6.947	6.956	6.975
Average	6.974	6.981	7.000	7.011	6.981	7.034	6.988
Max	6.993	7.003	7.029	7.040	7.012	7.095	7.007
UL	7.350	7.350	7.350	7.350	7.350	7.350	7.350

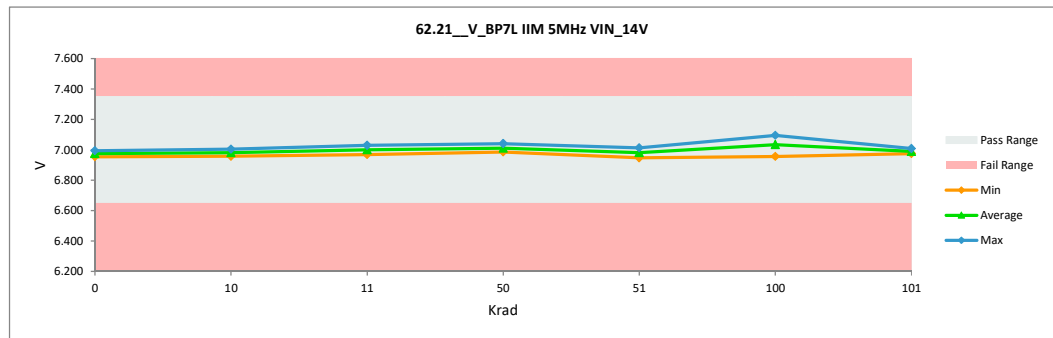

TID "HDR" Report
5962R2220102VXC

62.22_V_BP5L IIM 5MHz VIN		
Test Site	DAL	DAL
Tester	ETS364	ETS364
Test Number	EB672303	EB672303
Unit	V	V
Max Limit	5.175	5.175
Min Limit	4.75	4.75

Krad	Serial #	Pre_HDR_6013	Post_HDR_6013	Delta
0	1	5.045	5.048	0.003
0	2	5.036	5.039	0.002
10	182	5.013	5.016	0.003
10	202	5.015	5.014	-0.001
10	204	5.038	5.045	0.007
11	418	5.037	5.019	-0.018
11	419	5.040	5.023	-0.016
11	443	5.034	5.002	-0.031
50	259	5.025	5.027	0.003
50	346	5.013	5.010	-0.002
50	347	5.026	5.031	0.005
51	462	5.023	5.042	0.019
51	478	5.012	5.010	-0.002
51	503	5.016	5.013	-0.003
100	354	5.049	5.047	-0.003
100	363	5.027	5.037	0.010
100	366	5.016	5.019	0.003
100	383	5.013	5.029	0.015
100	417	5.014	5.039	0.024
101	513	5.032	4.995	-0.038
101	526	5.035	5.012	-0.023
101	532	5.044	5.021	-0.023
101	533	5.028	5.038	0.010
101	534	5.034	5.001	-0.034
	Max	5.049	5.048	0.024
	Average	5.028	5.024	-0.004
	Min	5.012	4.995	-0.038
	Std Dev	0.012	0.015	0.017

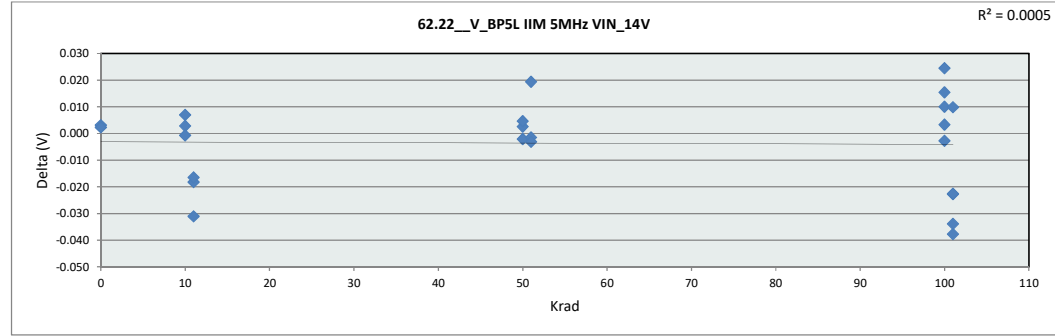

62.22_V_BP5L IIM 5MHz VIN		
Test Site	DAL	
Tester	ETS364	
Test Number	EB672303	
Max Limit	5.175	V
Min Limit	4.75	V

Krad	0	10	11	50	51	100	101
LL	4.750	4.750	4.750	4.750	4.750	4.750	4.750
Min	5.039	5.014	5.002	5.011	5.011	5.019	4.995
Average	5.043	5.025	5.015	5.023	5.022	5.034	5.013
Max	5.048	5.045	5.023	5.031	5.042	5.047	5.038
UL	5.175	5.175	5.175	5.175	5.175	5.175	5.175

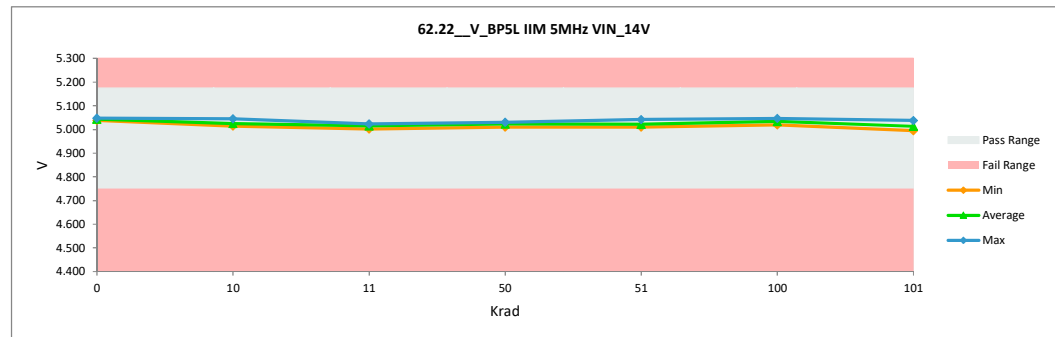

TID "HDR" Report
5962R2220102VXC

62.23_V_BP5H_IIM_5MHz_VIN		
Test Site	DAL	DAL
Tester	ETS364	ETS364
Test Number	EB672303	EB672303
Unit	V	V
Max Limit	5.175	5.175
Min Limit	4.75	4.75

Krad	Serial #	Pre_HDR_6013	Post_HDR_6013	Delta
0	1	5.007	5.008	0.001
0	2	5.025	5.026	0.001
10	182	5.005	5.004	-0.002
10	202	5.019	5.018	-0.001
10	204	5.027	5.025	-0.002
11	418	5.001	5.025	0.024
11	419	5.018	5.012	-0.006
11	443	5.015	4.995	-0.020
50	259	5.005	5.000	-0.005
50	346	5.001	4.994	-0.006
50	347	5.023	5.021	-0.002
51	462	5.016	5.011	-0.005
51	478	4.989	5.017	0.028
51	503	5.023	5.008	-0.015
100	354	5.016	5.014	-0.002
100	363	5.003	4.993	-0.009
100	366	4.997	4.990	-0.006
100	383	5.002	4.980	-0.022
100	417	5.010	5.005	-0.004
101	513	5.004	4.998	-0.005
101	526	5.000	5.006	0.006
101	532	5.015	4.991	-0.024
101	533	4.994	4.985	-0.009
101	534	4.993	4.976	-0.017
	Max	5.027	5.026	0.028
	Average	5.009	5.004	-0.004
	Min	4.989	4.976	-0.024
	Std Dev	0.011	0.014	0.012

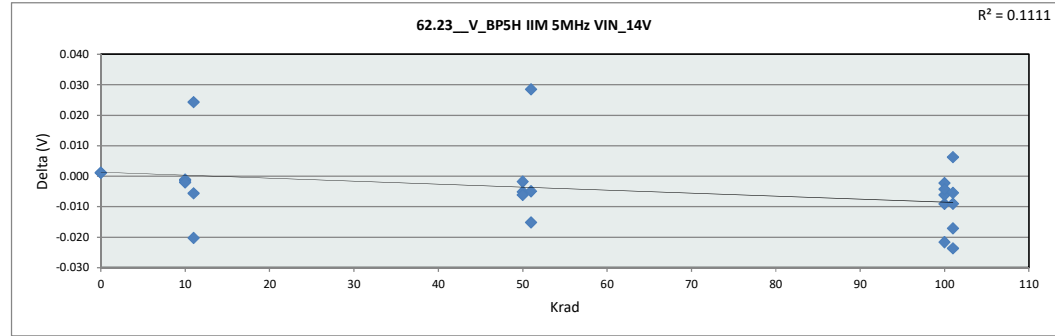

62.23_V_BP5H_IIM_5MHz_VIN		
Test Site	DAL	
Tester	ETS364	
Test Number	EB672303	
Max Limit	5.175	V
Min Limit	4.75	V

Krad	0	10	11	50	51	100	101
LL	4.750	4.750	4.750	4.750	4.750	4.750	4.750
Min	5.008	5.004	4.995	4.994	5.008	4.980	4.976
Average	5.017	5.015	5.011	5.005	5.012	4.997	4.991
Max	5.026	5.025	5.025	5.021	5.017	5.014	5.006
UL	5.175	5.175	5.175	5.175	5.175	5.175	5.175

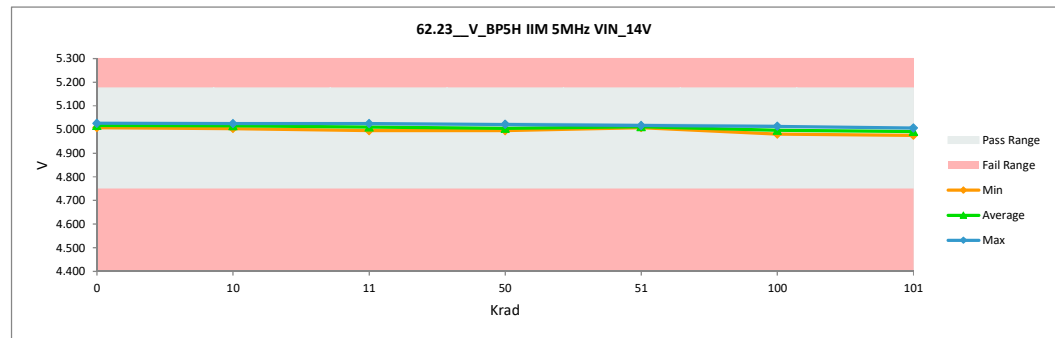

TID "HDR" Report
5962R2220102VXC

70.0 __UVLO VIN Rise Thresh		
Test Site	DAL	DAL
Tester	ETS364	ETS364
Test Number	EB672303	EB672303
Unit	V	V
Max Limit	9	9
Min Limit	8	8

Krad	Serial #	Pre_HDR_6013	Post_HDR_6013	Delta
0	1	8.575	8.575	0.000
0	2	8.590	8.595	0.005
10	182	8.600	8.595	-0.005
10	202	8.525	8.510	-0.015
10	204	8.650	8.645	-0.005
11	418	8.620	8.575	-0.045
11	419	8.585	8.550	-0.035
11	443	8.580	8.580	0.000
50	259	8.550	8.525	-0.025
50	346	8.590	8.530	-0.060
50	347	8.625	8.595	-0.030
51	462	8.610	8.595	-0.015
51	478	8.575	8.580	0.005
51	503	8.580	8.560	-0.020
100	354	8.650	8.585	-0.065
100	363	8.590	8.560	-0.030
100	366	8.580	8.530	-0.050
100	383	8.695	8.535	-0.160
100	417	8.640	8.635	-0.005
101	513	8.635	8.595	-0.040
101	526	8.645	8.605	-0.040
101	532	8.560	8.550	-0.010
101	533	8.740	8.710	-0.030
101	534	8.620	8.595	-0.025
Max		8.740	8.710	0.005
Average		8.609	8.580	-0.029
Min		8.525	8.510	-0.160
Std Dev		0.047	0.044	0.034

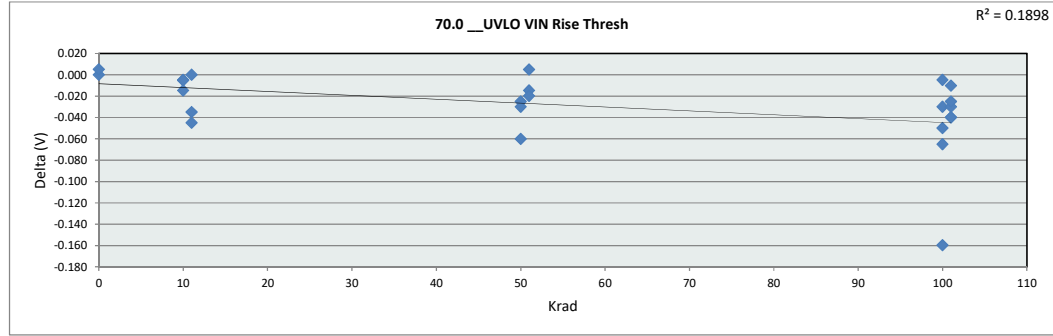

70.0 __UVLO VIN Rise Thresh		
Test Site	DAL	
Tester	ETS364	
Test Number	EB672303	
Max Limit	9	V
Min Limit	8	V

	0	10	11	50	51	100	101
LL	8.000	8.000	8.000	8.000	8.000	8.000	8.000
Min	8.575	8.510	8.550	8.525	8.560	8.530	8.550
Average	8.585	8.583	8.568	8.550	8.578	8.569	8.611
Max	8.595	8.645	8.580	8.595	8.595	8.635	8.710
UL	9.000	9.000	9.000	9.000	9.000	9.000	9.000

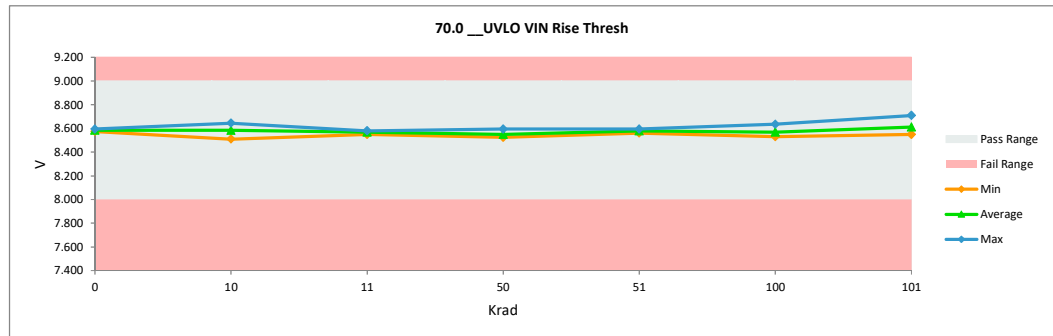

TID "HDR" Report
5962R2220102VXC

70.1 __UVLO VIN Fall Thresh		
Test Site	DAL	DAL
Tester	ETS364	ETS364
Test Number	EB672303	EB672303
Unit	V	V
Max Limit	8.5	8.5
Min Limit	7.5	7.5

Krad	Serial #	Pre_HDR_6013	Post_HDR_6013	Delta
0	1	8.040	8.045	0.005
0	2	8.055	8.060	0.005
10	182	8.070	8.060	-0.010
10	202	8.000	7.980	-0.020
10	204	8.115	8.110	-0.005
11	418	8.085	8.040	-0.045
11	419	8.050	8.015	-0.035
11	443	8.050	8.050	0.000
50	259	8.015	7.995	-0.020
50	346	8.055	8.000	-0.055
50	347	8.090	8.065	-0.025
51	462	8.080	8.060	-0.020
51	478	8.045	8.045	0.000
51	503	8.050	8.035	-0.015
100	354	8.115	8.055	-0.060
100	363	8.055	8.030	-0.025
100	366	8.050	8.000	-0.050
100	383	8.155	8.005	-0.150
100	417	8.100	8.095	-0.005
101	513	8.095	8.065	-0.030
101	526	8.110	8.070	-0.040
101	532	8.035	8.020	-0.015
101	533	8.195	8.170	-0.025
101	534	8.085	8.065	-0.020
Max		8.195	8.170	0.005
Average		8.075	8.047	-0.028
Min		8.000	7.980	-0.150
Std Dev		0.043	0.041	0.032

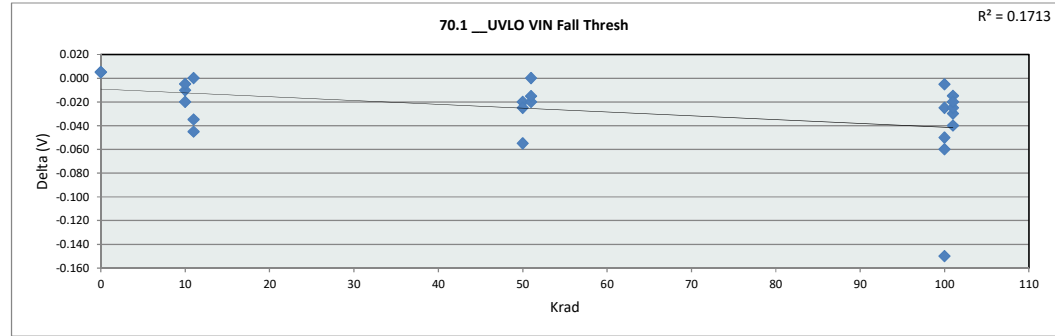

70.1 __UVLO VIN Fall Thresh		
Test Site	DAL	
Tester	ETS364	
Test Number	EB672303	
Max Limit	8.5	V
Min Limit	7.5	V

	0	10	11	50	51	100	101
LL	7.500	7.500	7.500	7.500	7.500	7.500	7.500
Min	8.045	7.980	8.015	7.995	8.035	8.000	8.020
Average	8.053	8.050	8.035	8.020	8.047	8.037	8.078
Max	8.060	8.110	8.050	8.065	8.060	8.095	8.170
UL	8.500	8.500	8.500	8.500	8.500	8.500	8.500

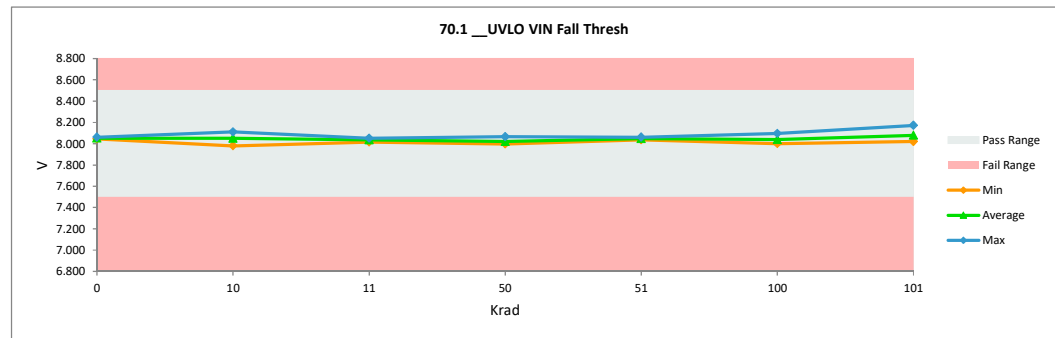

TID "HDR" Report
5962R2220102VXC

75.0 UVLO BOOT Rise Thresh		
Test Site	DAL	DAL
Tester	ETS364	ETS364
Test Number	EB672303	EB672303
Unit	V	V
Max Limit	7.4	7.4
Min Limit	6.6	6.6

Krad	Serial #	Pre_HDR_6013	Post_HDR_6013	Delta
0	1	7.093	7.093	0.000
0	2	7.128	7.128	0.000
10	182	7.057	7.068	0.010
10	202	7.073	7.093	0.020
10	204	7.123	7.142	0.020
11	418	7.073	7.073	0.000
11	419	7.093	7.082	-0.010
11	443	7.073	7.068	-0.005
50	259	7.157	7.157	0.000
50	346	7.123	7.102	-0.020
50	347	7.102	7.077	-0.025
51	462	7.112	7.008	-0.105
51	478	7.108	6.972	-0.135
51	503	7.098	7.082	-0.015
100	354	7.098	7.032	-0.065
100	363	7.112	7.068	-0.045
100	366	7.133	7.063	-0.070
100	383	7.068	7.017	-0.050
100	417	7.063	7.057	-0.005
101	513	7.102	7.082	-0.020
101	526	7.108	7.073	-0.035
101	532	7.038	7.013	-0.025
101	533	7.112	7.093	-0.020
101	534	7.128	7.112	-0.015
Max		7.157	7.157	0.020
Average		7.099	7.073	-0.026
Min		7.038	6.972	-0.135
Std Dev		0.028	0.043	0.037

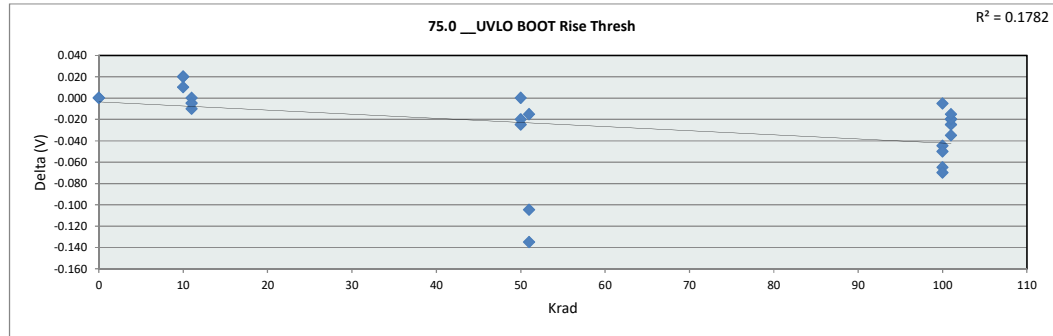

75.0 UVLO BOOT Rise Thresh		
Test Site	DAL	
Tester	ETS364	
Test Number	EB672303	
Max Limit	7.4	V
Min Limit	6.6	V

	0	10	11	50	51	100	101
LL	6.600	6.600	6.600	6.600	6.600	6.600	6.600
Min	7.093	7.068	7.068	7.078	6.973	7.018	7.013
Average	7.110	7.101	7.074	7.113	7.021	7.048	7.075
Max	7.128	7.142	7.082	7.158	7.082	7.068	7.112
UL	7.400	7.400	7.400	7.400	7.400	7.400	7.400

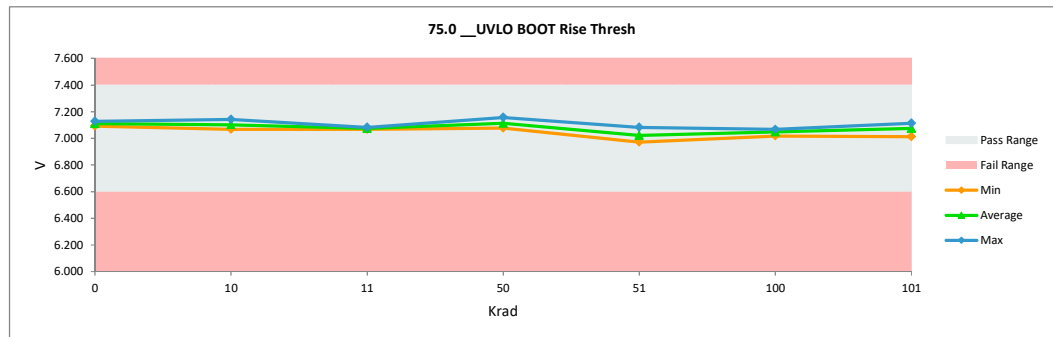

TID "HDR" Report
5962R2220102VXC

75.1 UVLO BOOT Fall Thresh		
Test Site	DAL	DAL
Tester	ETS364	ETS364
Test Number	EB672303	EB672303
Unit	V	V
Max Limit	7	7
Min Limit	6.2	6.2

Krad	Serial #	Pre_HDR_6013	Post_HDR_6013	Delta
0	1	6.652	6.652	0.000
0	2	6.688	6.688	0.000
10	182	6.617	6.628	0.010
10	202	6.638	6.648	0.010
10	204	6.673	6.698	0.025
11	418	6.633	6.633	0.000
11	419	6.652	6.638	-0.015
11	443	6.633	6.633	0.000
50	259	6.723	6.713	-0.010
50	346	6.682	6.657	-0.025
50	347	6.668	6.648	-0.020
51	462	6.668	6.578	-0.090
51	478	6.668	6.537	-0.130
51	503	6.657	6.638	-0.020
100	354	6.663	6.608	-0.055
100	363	6.668	6.633	-0.035
100	366	6.688	6.633	-0.055
100	383	6.628	6.588	-0.040
100	417	6.622	6.617	-0.005
101	513	6.663	6.642	-0.020
101	526	6.663	6.638	-0.025
101	532	6.597	6.578	-0.020
101	533	6.673	6.648	-0.025
101	534	6.682	6.668	-0.015
Max		6.723	6.713	0.025
Average		6.658	6.635	-0.023
Min		6.597	6.537	-0.130
Std Dev		0.027	0.039	0.033

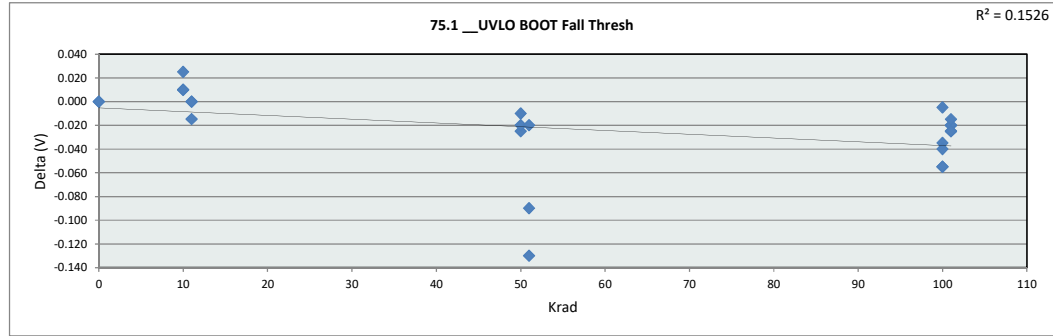

75.1 UVLO BOOT Fall Thresh		
Test Site	DAL	
Tester	ETS364	
Test Number	EB672303	
Max Limit	7	V
Min Limit	6.2	V

Krad	0	10	11	50	51	100	101
LL	6.200	6.200	6.200	6.200	6.200	6.200	6.200
Min	6.652	6.628	6.633	6.648	6.537	6.588	6.578
Average	6.670	6.658	6.634	6.673	6.584	6.616	6.635
Max	6.688	6.698	6.638	6.713	6.638	6.633	6.668
UL	7.000	7.000	7.000	7.000	7.000	7.000	7.000

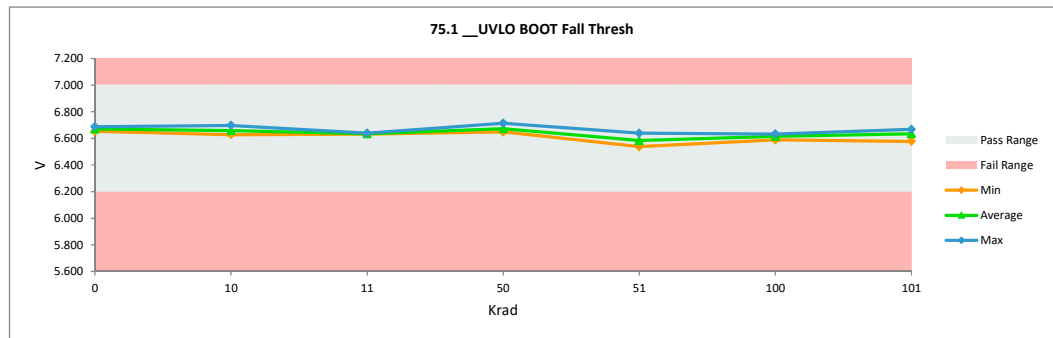

TID "HDR" Report
5962R2220102VXC

90.0_PWM_LI Rise Thresh VIN		
Test Site	DAL	DAL
Tester	ETS364	ETS364
Test Number	EB672303	EB672303
Unit	V	V
Max Limit	2.65	2.65
Min Limit	1.8	1.8

Krad	Serial #	Pre_HDR_6013	Post_HDR_6013	Delta
0	1	2.200	2.200	0.000
0	2	2.215	2.240	0.025
10	182	2.215	2.200	-0.015
10	202	2.205	2.185	-0.020
10	204	2.205	2.250	0.045
11	418	2.205	2.215	0.010
11	419	2.205	2.240	0.035
11	443	2.210	2.180	-0.030
50	259	2.250	2.145	-0.105
50	346	2.205	2.135	-0.070
50	347	2.200	2.165	-0.035
51	462	2.195	2.195	0.000
51	478	2.225	2.190	-0.035
51	503	2.305	2.210	-0.095
100	354	2.265	2.195	-0.070
100	363	2.210	2.145	-0.065
100	366	2.265	2.170	-0.095
100	383	2.240	2.150	-0.090
100	417	2.195	2.155	-0.040
101	513	2.270	2.150	-0.120
101	526	2.285	2.145	-0.140
101	532	2.250	2.090	-0.160
101	533	2.200	2.100	-0.100
101	534	2.265	2.090	-0.175
Max		2.305	2.250	0.045
Average		2.229	2.172	-0.056
Min		2.195	2.090	-0.175
Std Dev		0.033	0.044	0.061

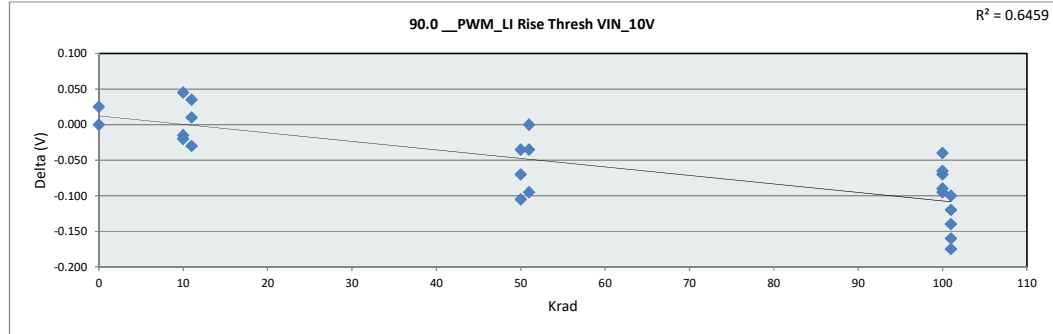

90.0_PWM_LI Rise Thresh V		
Test Site	DAL	
Tester	ETS364	
Test Number	EB672303	
Max Limit	2.65 V	
Min Limit	1.8 V	

Krad	0	10	11	50	51	100	101
LL	1.800	1.800	1.800	1.800	1.800	1.800	1.800
Min	2.200	2.185	2.180	2.135	2.190	2.145	2.090
Average	2.220	2.212	2.212	2.148	2.198	2.163	2.115
Max	2.240	2.250	2.240	2.165	2.210	2.195	2.150
UL	2.650	2.650	2.650	2.650	2.650	2.650	2.650

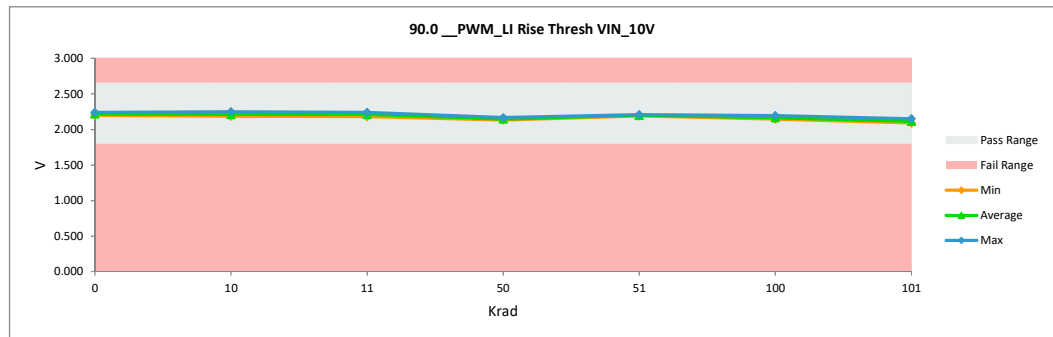

TID "HDR" Report
5962R2220102VXC

90.1 PWM_LI Fall Thresh VIN		
Test Site	DAL	DAL
Tester	ETS364	ETS364
Test Number	EB672303	EB672303
Unit	V	V
Max Limit	1.85	1.85
Min Limit	1.15	1.15

Krad	Serial #	Pre_HDR_6013	Post_HDR_6013	Delta
0	1	1.510	1.510	0.000
0	2	1.510	1.505	-0.005
10	182	1.445	1.455	0.010
10	202	1.450	1.445	-0.005
10	204	1.505	1.500	-0.005
11	418	1.420	1.490	0.070
11	419	1.420	1.430	0.010
11	443	1.470	1.450	-0.020
50	259	1.335	1.325	-0.010
50	346	1.455	1.480	0.025
50	347	1.460	1.430	-0.030
51	462	1.505	1.460	-0.045
51	478	1.435	1.400	-0.035
51	503	1.500	1.465	-0.035
100	354	1.520	1.480	-0.040
100	363	1.510	1.335	-0.175
100	366	1.500	1.410	-0.090
100	383	1.425	1.415	-0.010
100	417	1.500	1.480	-0.020
101	513	1.415	1.435	0.020
101	526	1.505	1.440	-0.065
101	532	1.455	1.450	-0.005
101	533	1.435	1.385	-0.050
101	534	1.430	1.440	0.010
Max		1.520	1.510	0.070
Average		1.463	1.442	-0.021
Min		1.335	1.325	-0.175
Std Dev		0.045	0.048	0.046

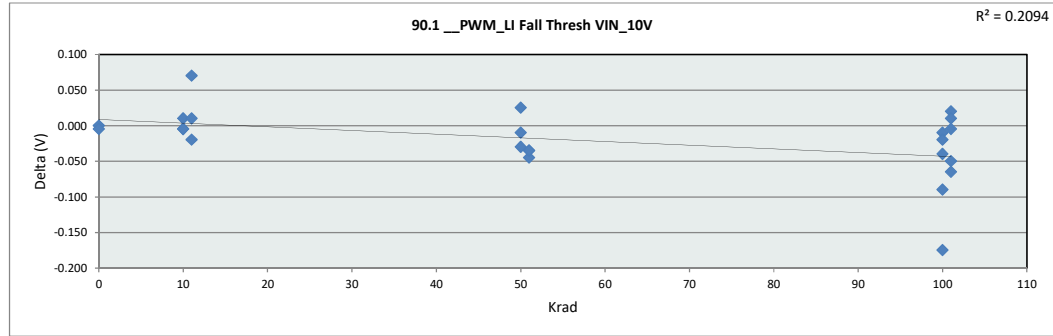

90.1 PWM_LI Fall Thresh VI		
Test Site	DAL	
Tester	ETS364	
Test Number	EB672303	
Max Limit	1.85	V
Min Limit	1.15	V

Krad	0	10	11	50	51	100	101
LL	1.150	1.150	1.150	1.150	1.150	1.150	1.150
Min	1.505	1.445	1.430	1.325	1.400	1.335	1.385
Average	1.508	1.467	1.457	1.412	1.442	1.424	1.430
Max	1.510	1.500	1.490	1.480	1.465	1.480	1.450
UL	1.850	1.850	1.850	1.850	1.850	1.850	1.850

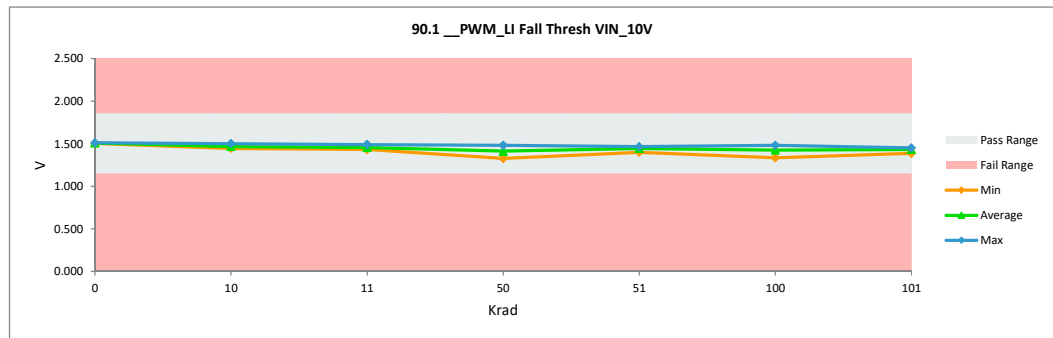

TID "HDR" Report
5962R2220102VXC

90.3 EN_HI Rise Thresh VIN		
Test Site	DAL	DAL
Tester	ETS364	ETS364
Test Number	EB672303	EB672303
Unit	V	V
Max Limit	2.65	2.65
Min Limit	1.8	1.8

Krad	Serial #	Pre_HDR_6013	Post_HDR_6013	Delta
0	1	2.240	2.220	-0.020
0	2	2.290	2.290	0.000
10	182	2.290	2.285	-0.005
10	202	2.260	2.255	-0.005
10	204	2.205	2.295	0.090
11	418	2.450	2.245	-0.205
11	419	2.315	2.245	-0.070
11	443	2.290	2.270	-0.020
50	259	2.350	2.305	-0.045
50	346	2.235	2.155	-0.080
50	347	2.315	2.245	-0.070
51	462	2.360	2.180	-0.180
51	478	2.345	2.280	-0.065
51	503	2.330	2.285	-0.045
100	354	2.270	2.120	-0.150
100	363	2.310	2.150	-0.160
100	366	2.220	2.135	-0.085
100	383	2.220	2.280	0.060
100	417	2.215	2.125	-0.090
101	513	2.345	2.235	-0.110
101	526	2.315	2.250	-0.065
101	532	2.340	2.215	-0.125
101	533	2.270	2.170	-0.100
101	534	2.265	2.150	-0.115
	Max	2.450	2.305	0.090
	Average	2.294	2.224	-0.069
	Min	2.205	2.120	-0.205
	Std Dev	0.058	0.060	0.071

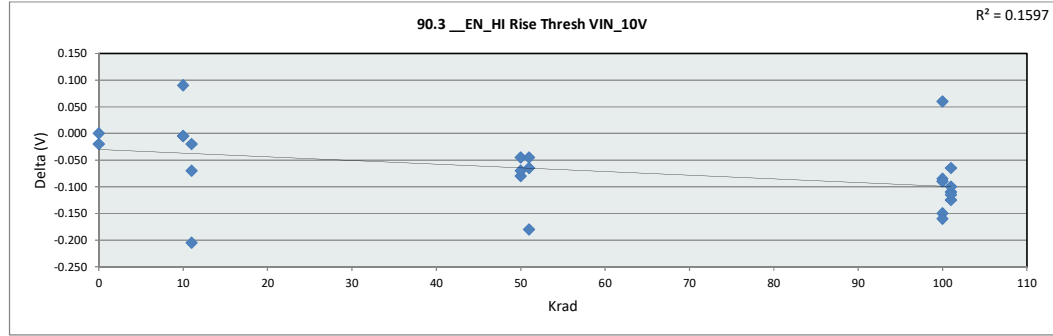

90.3 EN_HI Rise Thresh VIN		
Test Site	DAL	
Tester	ETS364	
Test Number	EB672303	
Max Limit	2.65	V
Min Limit	1.8	V

Krad	0	10	11	50	51	100	101
LL	1.800	1.800	1.800	1.800	1.800	1.800	1.800
Min	2.220	2.255	2.245	2.155	2.180	2.120	2.150
Average	2.255	2.278	2.253	2.235	2.248	2.162	2.204
Max	2.290	2.295	2.270	2.305	2.285	2.280	2.250
UL	2.650	2.650	2.650	2.650	2.650	2.650	2.650

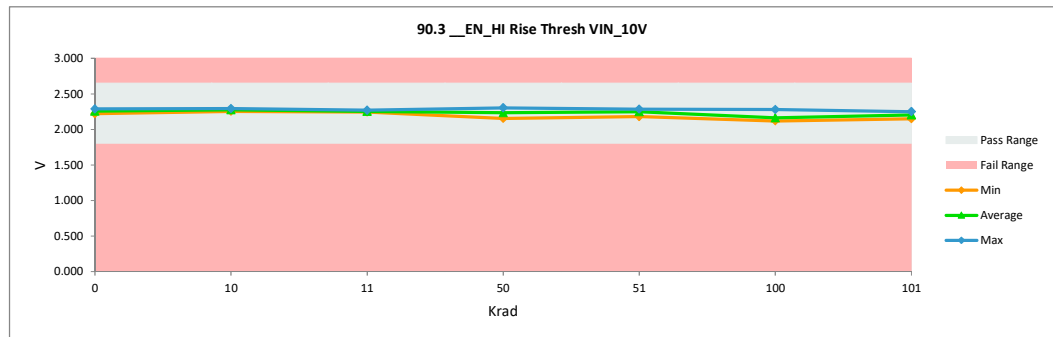

TID "HDR" Report
5962R2220102VXC

90.4 EN_HI Fall Thresh VIN_1		
Test Site	DAL	DAL
Tester	ETS364	ETS364
Test Number	EB672303	EB672303
Unit	V	V
Max Limit	1.85	1.85
Min Limit	1.15	1.15

Krad	Serial #	Pre_HDR_6013	Post_HDR_6013	Delta
0	1	1.520	1.485	-0.035
0	2	1.425	1.435	0.010
10	182	1.505	1.490	-0.015
10	202	1.435	1.425	-0.010
10	204	1.430	1.505	0.075
11	418	1.325	1.490	0.165
11	419	1.510	1.475	-0.035
11	443	1.505	1.415	-0.090
50	259	1.360	1.335	-0.025
50	346	1.455	1.405	-0.050
50	347	1.515	1.485	-0.030
51	462	1.450	1.470	0.020
51	478	1.505	1.390	-0.115
51	503	1.400	1.365	-0.035
100	354	1.515	1.445	-0.070
100	363	1.445	1.355	-0.090
100	366	1.405	1.460	0.055
100	383	1.405	1.350	-0.055
100	417	1.500	1.335	-0.165
101	513	1.500	1.380	-0.120
101	526	1.420	1.360	-0.060
101	532	1.410	1.365	-0.045
101	533	1.505	1.450	-0.055
101	534	1.515	1.445	-0.070
Max		1.520	1.505	0.165
Average		1.457	1.421	-0.035
Min		1.325	1.335	-0.165
Std Dev		0.056	0.056	0.068

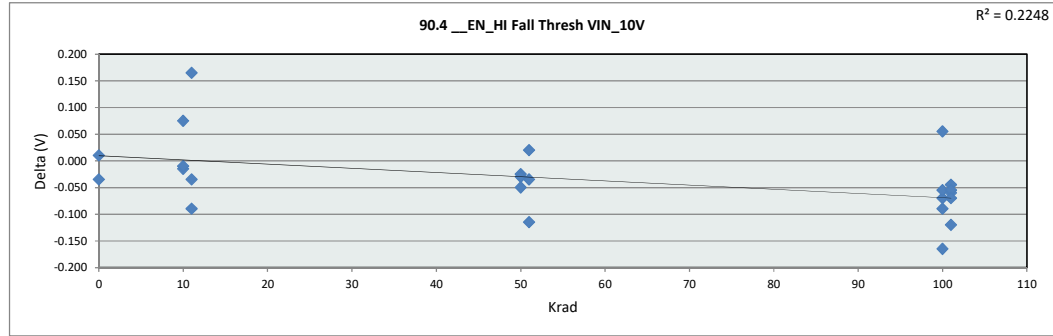

90.4 EN_HI Fall Thresh VIN		
Test Site	DAL	
Tester	ETS364	
Test Number	EB672303	
Max Limit	1.85 V	
Min Limit	1.15 V	

Krad	0	10	11	50	51	100	101
LL	1.150	1.150	1.150	1.150	1.150	1.150	1.150
Min	1.435	1.425	1.415	1.335	1.365	1.335	1.360
Average	1.460	1.473	1.460	1.408	1.408	1.389	1.400
Max	1.485	1.505	1.490	1.485	1.470	1.460	1.450
UL	1.850	1.850	1.850	1.850	1.850	1.850	1.850

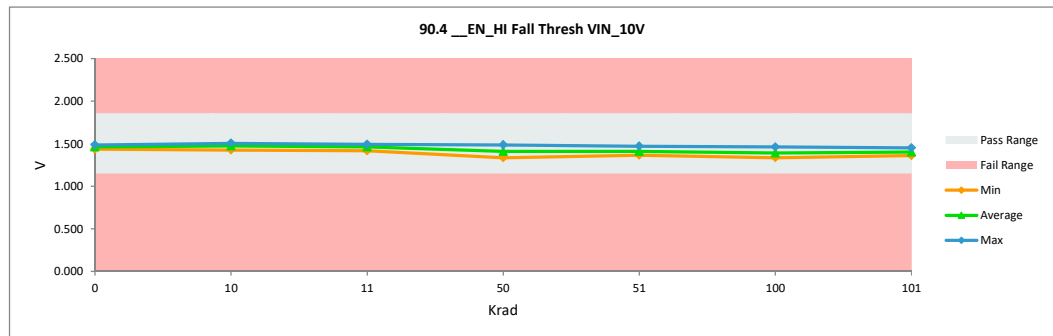

TID "HDR" Report
5962R2220102VXC

90.6 PWM_LI Pull Down Resis		
Test Site	DAL	DAL
Tester	ETS364	ETS364
Test Number	EB672303	EB672303
Unit	KOHMS	KOHMS
Max Limit	400	400
Min Limit	100	100

Krad	Serial #	Pre_HDR_6013	Post_HDR_6013	Delta
0	1	201.495	204.980	3.485
0	2	201.700	204.452	2.752
10	182	211.044	214.115	3.071
10	202	206.083	205.895	-0.188
10	204	198.941	207.993	9.052
11	418	198.316	192.459	-5.857
11	419	198.581	202.888	4.307
11	443	207.407	201.714	-5.693
50	259	198.956	200.229	1.273
50	346	198.309	200.241	1.932
50	347	201.384	202.281	0.897
51	462	200.096	195.612	-4.484
51	478	202.637	207.565	4.928
51	503	196.661	196.023	-0.638
100	354	200.502	201.427	0.925
100	363	204.086	201.272	-2.814
100	366	199.181	199.978	0.797
100	383	197.801	210.552	12.751
100	417	200.415	197.880	-2.535
101	513	199.807	199.266	-0.541
101	526	205.283	204.496	-0.787
101	532	198.746	198.688	-0.059
101	533	209.035	208.739	-0.295
101	534	203.091	203.101	0.010
Max		211.044	214.115	12.751
Average		201.648	202.577	0.929
Min		196.661	192.459	-5.857
Std Dev		3.771	5.008	4.202

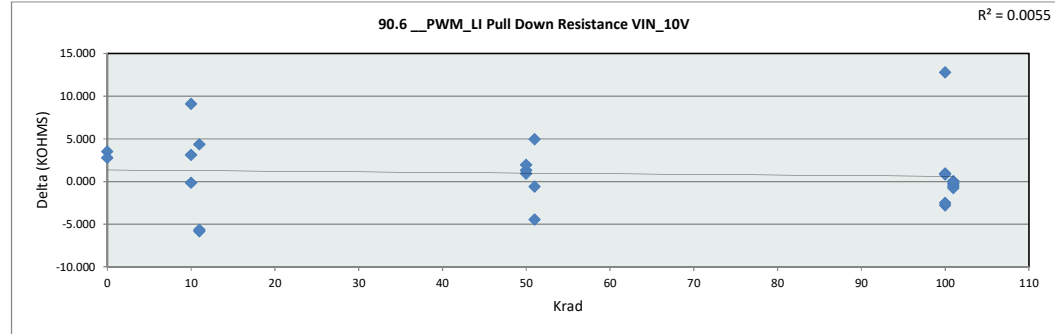

90.6 PWM_LI Pull Down Res		
Test Site	DAL	
Tester	ETS364	
Test Number	EB672303	
Max Limit	400	KOHMS
Min Limit	100	KOHMS

	0	10	11	50	51	100	101
LL	100.000	100.000	100.000	100.000	100.000	100.000	100.000
Min	204.452	205.895	192.459	200.229	195.612	197.880	198.688
Average	204.716	209.334	199.020	200.917	199.733	202.222	202.858
Max	204.980	214.115	202.888	202.281	207.565	210.552	208.739
UL	400.000	400.000	400.000	400.000	400.000	400.000	400.000

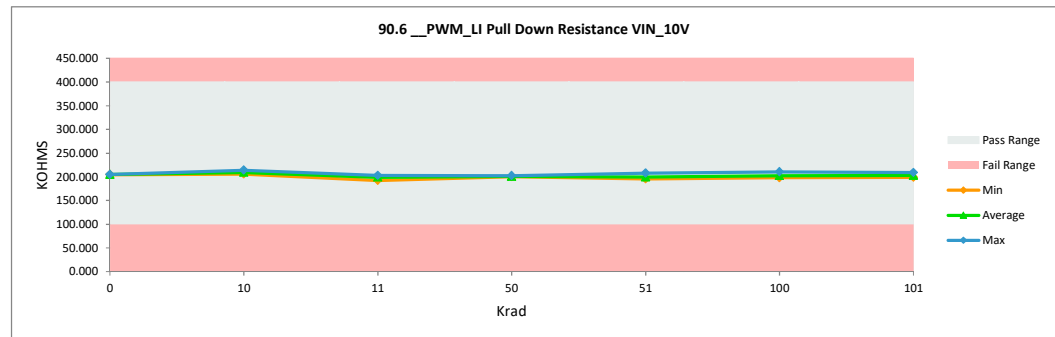

TID "HDR" Report
5962R2220102VXC

90.7 EN_HI Pull Down Resista		
Test Site	DAL	DAL
Tester	ETS364	ETS364
Test Number	EB672303	EB672303
Unit	KOHMS	KOHMS
Max Limit	400	400
Min Limit	100	100

Krad	Serial #	Pre_HDR_6013	Post_HDR_6013	Delta
0	1	199.821	203.311	3.491
0	2	201.534	204.249	2.716
10	182	209.058	212.146	3.088
10	202	206.305	206.145	-0.160
10	204	197.898	207.474	9.577
11	418	198.229	190.223	-8.006
11	419	197.072	201.693	4.622
11	443	207.332	201.303	-6.029
50	259	197.653	198.730	1.077
50	346	196.762	198.559	1.797
50	347	200.173	200.867	0.694
51	462	198.914	194.339	-4.575
51	478	202.667	207.317	4.650
51	503	195.573	194.883	-0.690
100	354	198.767	199.462	0.695
100	363	202.939	200.522	-2.418
100	366	198.348	198.898	0.549
100	383	198.227	210.156	11.929
100	417	200.278	196.537	-3.741
101	513	198.670	198.105	-0.565
101	526	204.860	204.065	-0.795
101	532	197.318	197.238	-0.080
101	533	207.280	206.976	-0.304
101	534	202.158	202.148	-0.009
Max		209.058	212.146	11.929
Average		200.743	201.473	0.730
Min		195.573	190.223	-8.006
Std Dev		3.794	5.244	4.382

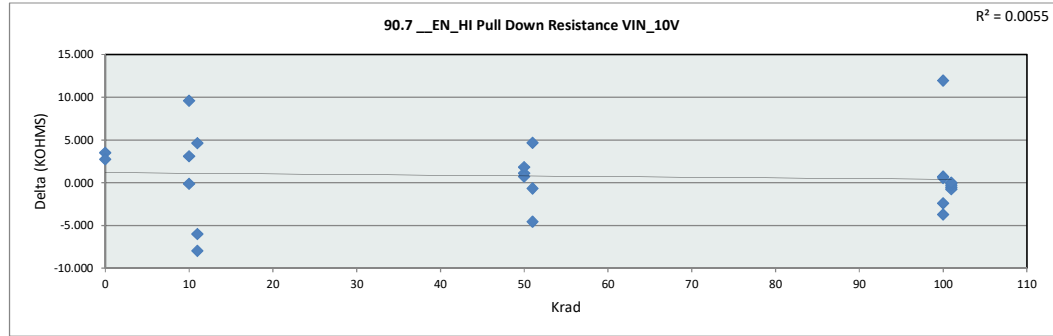

90.7 EN_HI Pull Down Resis		
Test Site	DAL	
Tester	ETS364	
Test Number	EB672303	
Max Limit	400	KOHMS
Min Limit	100	KOHMS

	0	10	11	50	51	100	101
LL	100.000	100.000	100.000	100.000	100.000	100.000	100.000
Min	203.311	206.145	190.223	198.559	194.339	196.537	197.238
Average	203.780	208.588	197.740	199.386	198.846	201.115	201.707
Max	204.250	212.146	201.694	200.867	207.317	210.156	206.976
UL	400.000	400.000	400.000	400.000	400.000	400.000	400.000

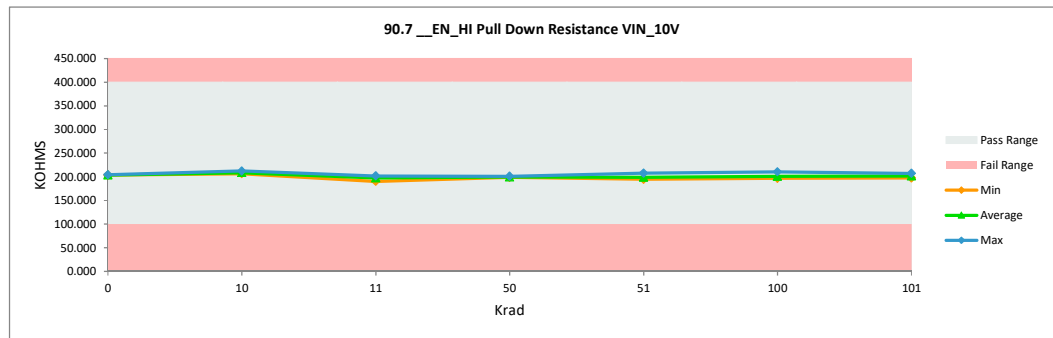

TID "HDR" Report
5962R2220102VXC

91.0_PWM_LI Rise Thresh VIN		
Test Site	DAL	DAL
Tester	ETS364	ETS364
Test Number	EB672303	EB672303
Unit	V	V
Max Limit	2.65	2.65
Min Limit	1.8	1.8

Krad	Serial #	Pre_HDR_6013	Post_HDR_6013	Delta
0	1	2.200	2.200	0.000
0	2	2.235	2.240	0.005
10	182	2.210	2.205	-0.005
10	202	2.195	2.185	-0.010
10	204	2.200	2.245	0.045
11	418	2.210	2.185	-0.025
11	419	2.205	2.225	0.020
11	443	2.210	2.180	-0.030
50	259	2.235	2.145	-0.090
50	346	2.200	2.135	-0.065
50	347	2.200	2.155	-0.045
51	462	2.195	2.200	0.005
51	478	2.225	2.170	-0.055
51	503	2.305	2.215	-0.090
100	354	2.270	2.180	-0.090
100	363	2.215	2.145	-0.070
100	366	2.270	2.175	-0.095
100	383	2.245	2.125	-0.120
100	417	2.235	2.145	-0.090
101	513	2.265	2.165	-0.100
101	526	2.290	2.150	-0.140
101	532	2.245	2.095	-0.150
101	533	2.195	2.100	-0.095
101	534	2.265	2.090	-0.175
Max		2.305	2.245	0.045
Average		2.230	2.169	-0.061
Min		2.195	2.090	-0.175
Std Dev		0.033	0.043	0.058

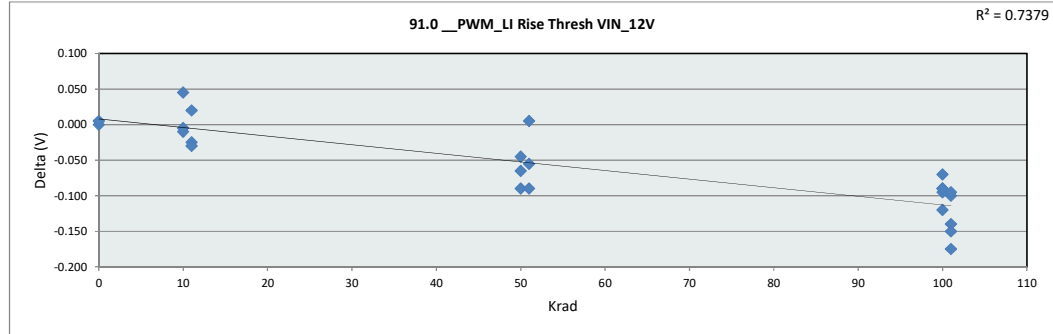

91.0_PWM_LI Rise Thresh V		
Test Site	DAL	
Tester	ETS364	
Test Number	EB672303	
Max Limit	2.65 V	
Min Limit	1.8 V	

Krad	0	10	11	50	51	100	101
LL	1.800	1.800	1.800	1.800	1.800	1.800	1.800
Min	2.200	2.185	2.180	2.135	2.170	2.125	2.090
Average	2.220	2.212	2.197	2.145	2.195	2.154	2.120
Max	2.240	2.245	2.225	2.155	2.215	2.180	2.165
UL	2.650	2.650	2.650	2.650	2.650	2.650	2.650

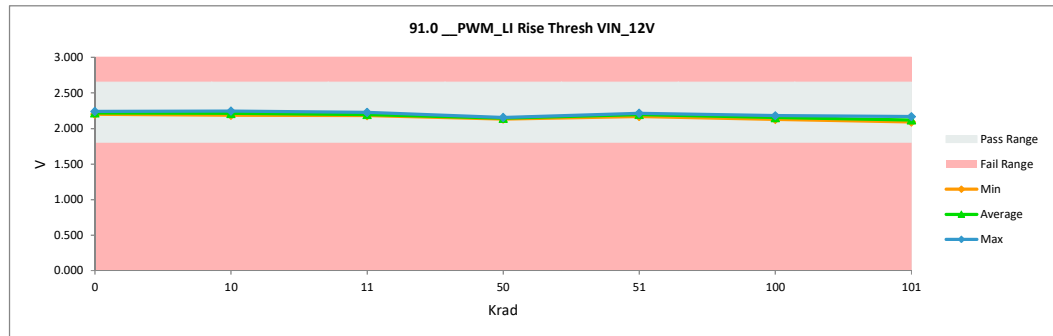

TID "HDR" Report
5962R2220102VXC

91.1 PWM_LI Fall Thresh VIN		
Test Site	DAL	DAL
Tester	ETS364	ETS364
Test Number	EB672303	EB672303
Unit	V	V
Max Limit	1.85	1.85
Min Limit	1.15	1.15

Krad	Serial #	Pre_HDR_6013	Post_HDR_6013	Delta
0	1	1.510	1.510	0.000
0	2	1.510	1.510	0.000
10	182	1.440	1.500	0.060
10	202	1.495	1.440	-0.055
10	204	1.470	1.495	0.025
11	418	1.425	1.490	0.065
11	419	1.415	1.420	0.005
11	443	1.435	1.465	0.030
50	259	1.345	1.325	-0.020
50	346	1.475	1.480	0.005
50	347	1.435	1.440	0.005
51	462	1.505	1.480	-0.025
51	478	1.435	1.415	-0.020
51	503	1.500	1.415	-0.085
100	354	1.520	1.480	-0.040
100	363	1.505	1.325	-0.180
100	366	1.500	1.405	-0.095
100	383	1.490	1.470	-0.020
100	417	1.500	1.480	-0.020
101	513	1.510	1.385	-0.125
101	526	1.505	1.440	-0.065
101	532	1.515	1.395	-0.120
101	533	1.495	1.385	-0.110
101	534	1.425	1.435	0.010
Max		1.520	1.510	0.065
Average		1.473	1.441	-0.032
Min		1.345	1.325	-0.180
Std Dev		0.044	0.053	0.061

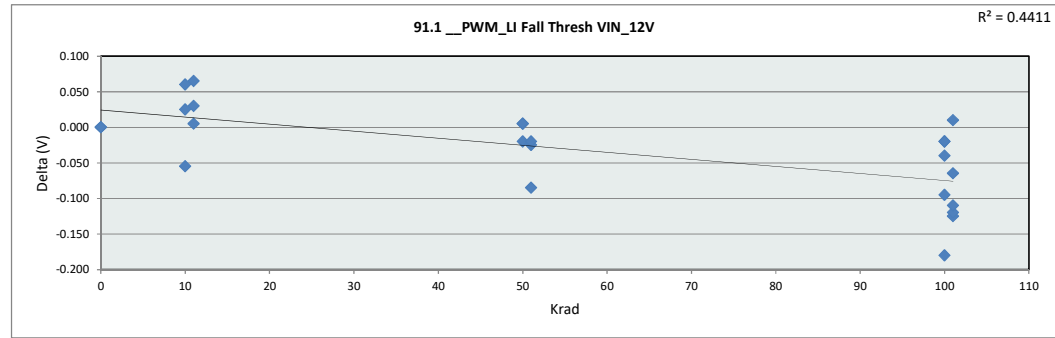

91.1 PWM_LI Fall Thresh VI		
Test Site	DAL	
Tester	ETS364	
Test Number	EB672303	
Max Limit	1.85	V
Min Limit	1.15	V

Krad	0	10	11	50	51	100	101
LL	1.150	1.150	1.150	1.150	1.150	1.150	1.150
Min	1.510	1.440	1.420	1.325	1.415	1.325	1.385
Average	1.510	1.478	1.458	1.415	1.437	1.432	1.408
Max	1.510	1.500	1.490	1.480	1.480	1.480	1.440
UL	1.850	1.850	1.850	1.850	1.850	1.850	1.850

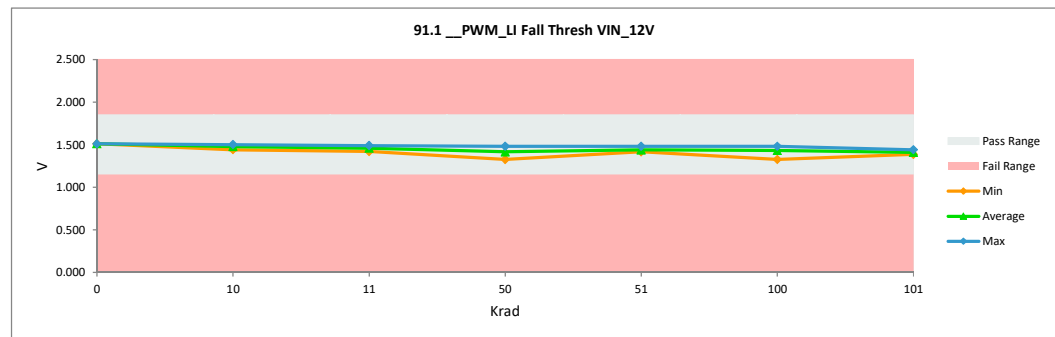

TID "HDR" Report
5962R2220102VXC

91.3 EN_HI Rise Thresh VIN		
Test Site	DAL	DAL
Tester	ETS364	ETS364
Test Number	EB672303	EB672303
Unit	V	V
Max Limit	2.65	2.65
Min Limit	1.8	1.8

Krad	Serial #	Pre_HDR_6013	Post_HDR_6013	Delta
0	1	2.230	2.230	0.000
0	2	2.295	2.270	-0.025
10	182	2.290	2.280	-0.010
10	202	2.255	2.260	0.005
10	204	2.210	2.265	0.055
11	418	2.460	2.255	-0.205
11	419	2.315	2.235	-0.080
11	443	2.290	2.280	-0.010
50	259	2.345	2.320	-0.025
50	346	2.235	2.155	-0.080
50	347	2.315	2.245	-0.070
51	462	2.370	2.145	-0.225
51	478	2.355	2.270	-0.085
51	503	2.330	2.280	-0.050
100	354	2.265	2.120	-0.145
100	363	2.310	2.165	-0.145
100	366	2.220	2.130	-0.090
100	383	2.215	2.265	0.050
100	417	2.190	2.145	-0.045
101	513	2.335	2.225	-0.110
101	526	2.305	2.250	-0.055
101	532	2.330	2.210	-0.120
101	533	2.255	2.190	-0.065
101	534	2.260	2.135	-0.125
Max		2.460	2.320	0.055
Average		2.291	2.222	-0.069
Min		2.190	2.120	-0.225
Std Dev		0.062	0.059	0.071

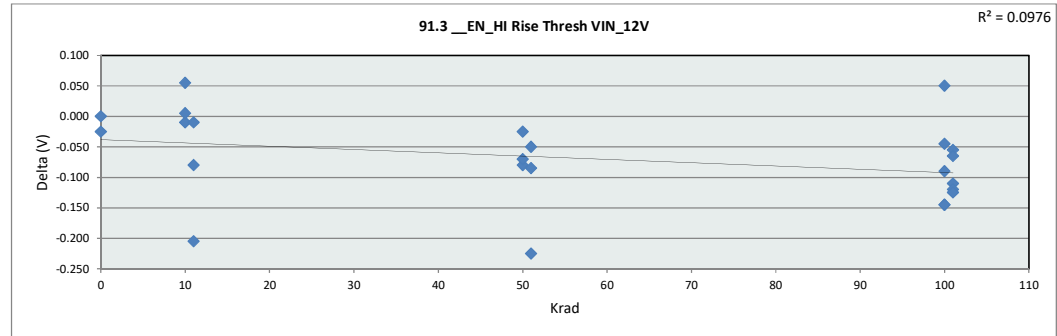

91.3 EN_HI Rise Thresh VIN		
Test Site	DAL	
Tester	ETS364	
Test Number	EB672303	
Max Limit	2.65	V
Min Limit	1.8	V

Krad	0	10	11	50	51	100	101
LL	1.800	1.800	1.800	1.800	1.800	1.800	1.800
Min	2.230	2.260	2.235	2.155	2.145	2.120	2.135
Average	2.250	2.268	2.257	2.240	2.232	2.165	2.202
Max	2.270	2.280	2.280	2.320	2.280	2.265	2.250
UL	2.650	2.650	2.650	2.650	2.650	2.650	2.650

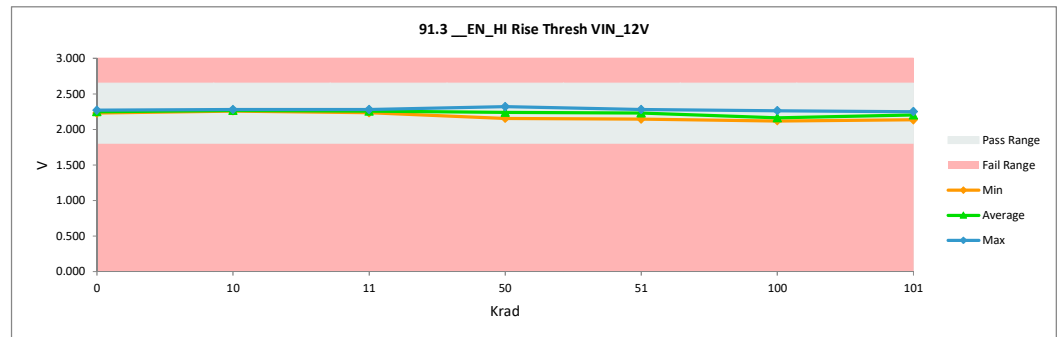

TID "HDR" Report
5962R2220102VXC

91.4 EN_HI Fall Thresh VIN_1		
Test Site	DAL	DAL
Tester	ETS364	ETS364
Test Number	EB672303	EB672303
Unit	V	V
Max Limit	1.85	1.85
Min Limit	1.15	1.15

Krad	Serial #	Pre_HDR_6013	Post_HDR_6013	Delta
0	1	1.520	1.460	-0.060
0	2	1.430	1.420	-0.010
10	182	1.505	1.495	-0.010
10	202	1.450	1.425	-0.025
10	204	1.405	1.500	0.095
11	418	1.335	1.485	0.150
11	419	1.470	1.470	0.000
11	443	1.505	1.485	-0.020
50	259	1.370	1.340	-0.030
50	346	1.455	1.405	-0.050
50	347	1.515	1.485	-0.030
51	462	1.450	1.405	-0.045
51	478	1.505	1.385	-0.120
51	503	1.395	1.355	-0.040
100	354	1.470	1.460	-0.010
100	363	1.505	1.360	-0.145
100	366	1.415	1.460	0.045
100	383	1.415	1.345	-0.070
100	417	1.505	1.335	-0.170
101	513	1.480	1.375	-0.105
101	526	1.435	1.360	-0.075
101	532	1.410	1.360	-0.050
101	533	1.470	1.450	-0.020
101	534	1.450	1.395	-0.055
Max		1.520	1.500	0.150
Average		1.453	1.417	-0.035
Min		1.335	1.335	-0.170
Std Dev		0.049	0.056	0.069

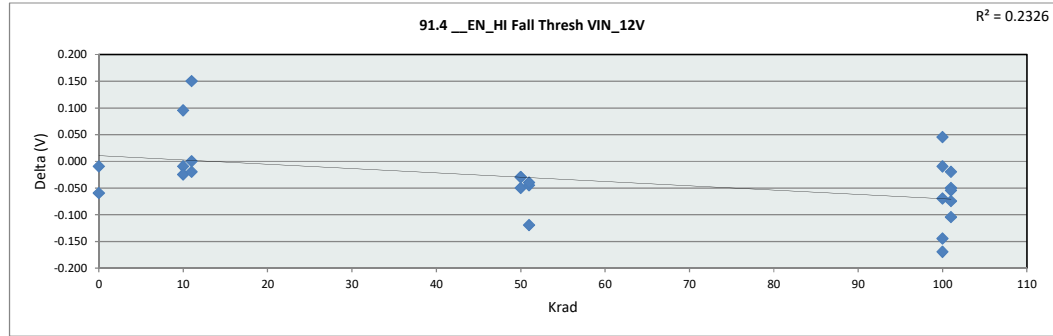

91.4 EN_HI Fall Thresh VIN		
Test Site	DAL	
Tester	ETS364	
Test Number	EB672303	
Max Limit	1.85	V
Min Limit	1.15	V

Krad	0	10	11	50	51	100	101
LL	1.150	1.150	1.150	1.150	1.150	1.150	1.150
Min	1.420	1.425	1.470	1.340	1.355	1.335	1.360
Average	1.440	1.473	1.480	1.410	1.382	1.392	1.388
Max	1.460	1.500	1.485	1.485	1.405	1.460	1.450
UL	1.850	1.850	1.850	1.850	1.850	1.850	1.850

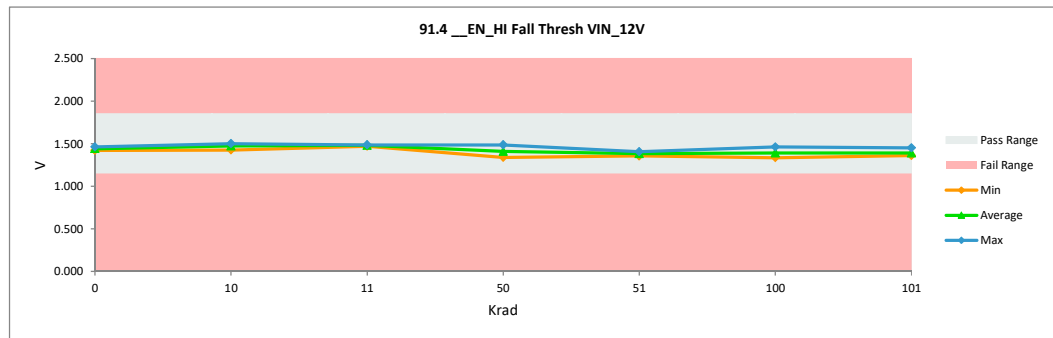

TID "HDR" Report
5962R2220102VXC

91.6_PWM_LI Pull Down Resis		
Test Site	DAL	DAL
Tester	ETS364	ETS364
Test Number	EB672303	EB672303
Unit	KOHMS	KOHMS
Max Limit	400	400
Min Limit	100	100

Krad	Serial #	Pre_HDR_6013	Post_HDR_6013	Delta
0	1	201.458	204.917	3.459
0	2	201.707	204.355	2.647
10	182	210.989	214.111	3.123
10	202	206.078	205.863	-0.215
10	204	198.927	207.880	8.953
11	418	198.310	192.432	-5.878
11	419	198.636	202.909	4.274
11	443	207.419	201.719	-5.700
50	259	198.888	200.209	1.321
50	346	198.271	200.246	1.975
50	347	201.424	202.340	0.916
51	462	200.101	195.645	-4.456
51	478	202.608	207.553	4.946
51	503	196.655	195.988	-0.667
100	354	200.513	201.451	0.939
100	363	204.051	201.340	-2.711
100	366	199.171	199.964	0.793
100	383	197.768	210.550	12.782
100	417	200.365	197.916	-2.448
101	513	199.791	199.221	-0.569
101	526	205.321	204.438	-0.883
101	532	198.733	198.718	-0.014
101	533	208.977	208.783	-0.195
101	534	203.070	203.114	0.044
Max		210.989	214.111	12.782
Average		201.635	202.569	0.935
Min		196.655	192.432	-5.878
Std Dev		3.766	5.000	4.191

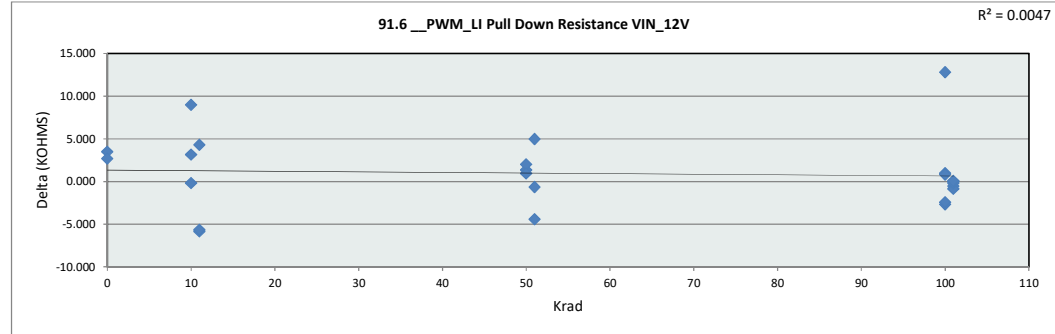

91.6_PWM_LI Pull Down Res		
Test Site	DAL	DAL
Tester	ETS364	ETS364
Test Number	EB672303	EB672303
Max Limit	400	KOHMS
Min Limit	100	KOHMS

	0	10	11	50	51	100	101
LL	100.000	100.000	100.000	100.000	100.000	100.000	100.000
Min	204.355	205.863	192.432	200.209	195.645	197.916	198.718
Average	204.636	209.285	199.020	200.932	199.729	202.244	202.855
Max	204.917	214.111	202.909	202.340	207.554	210.550	208.783
UL	400.000	400.000	400.000	400.000	400.000	400.000	400.000

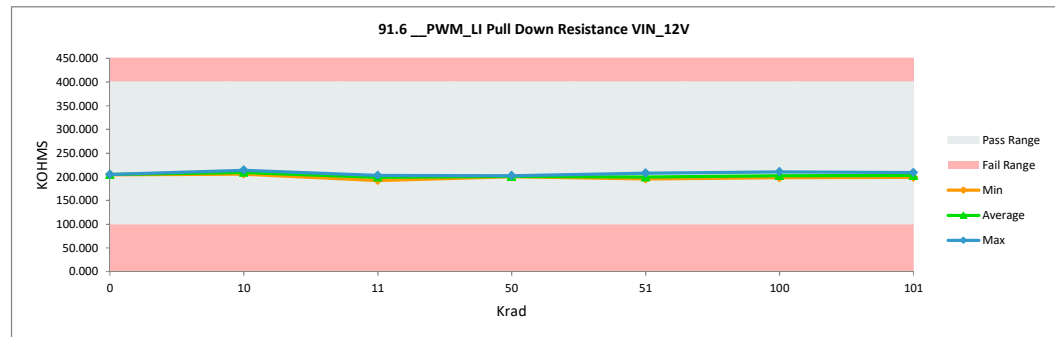

TID "HDR" Report
5962R2220102VXC

91.7 EN_HI Pull Down Resista

Test Site	DAL	DAL
Tester	ETS364	ETS364
Test Number	EB672303	EB672303
Unit	KOHMS	KOHMS
Max Limit	400	400
Min Limit	100	100

Krad	Serial #	Pre_HDR_6013	Post_HDR_6013	Delta
0	1	199.815	203.195	3.381
0	2	201.542	204.191	2.649
10	182	209.033	212.124	3.091
10	202	206.277	206.143	-0.135
10	204	197.903	207.389	9.486
11	418	198.191	190.231	-7.960
11	419	197.120	201.666	4.547
11	443	207.364	201.273	-6.090
50	259	197.611	198.707	1.097
50	346	196.744	198.510	1.765
50	347	200.158	200.882	0.724
51	462	198.871	194.354	-4.517
51	478	202.618	207.276	4.657
51	503	195.523	194.884	-0.639
100	354	198.743	199.460	0.716
100	363	202.945	200.535	-2.411
100	366	198.285	198.898	0.613
100	383	198.218	210.186	11.968
100	417	200.213	196.551	-3.662
101	513	198.662	198.062	-0.600
101	526	204.832	204.020	-0.812
101	532	197.306	197.213	-0.093
101	533	207.320	206.985	-0.336
101	534	202.173	202.153	-0.019
Max		209.033	212.124	11.968
Average		200.728	201.454	0.726
Min		195.523	190.231	-7.960
Std Dev		3.802	5.235	4.365

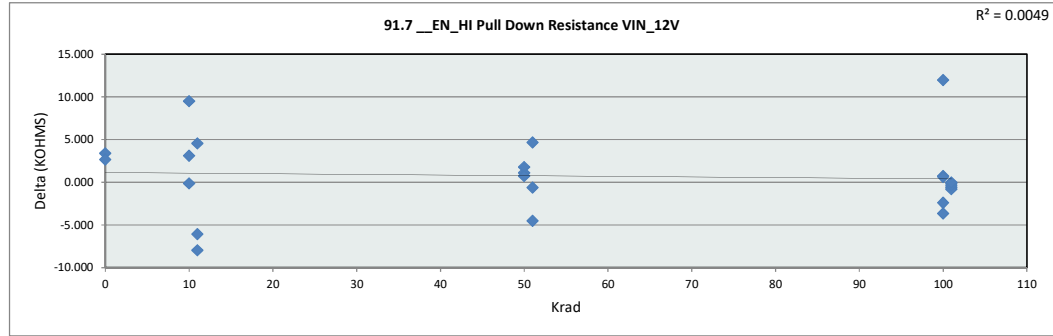

91.7 EN_HI Pull Down Resis

Test Site	DAL
Tester	ETS364
Test Number	EB672303
Max Limit	400 KOHMS
Min Limit	100 KOHMS

Krad	0	10	11	50	51	100	101
LL	100.000	100.000	100.000	100.000	100.000	100.000	100.000
Min	203.196	206.143	190.231	198.510	194.354	196.551	197.213
Average	203.693	208.552	197.724	199.366	198.838	201.126	201.687
Max	204.191	212.124	201.666	200.882	207.276	210.187	206.985
UL	400.000	400.000	400.000	400.000	400.000	400.000	400.000

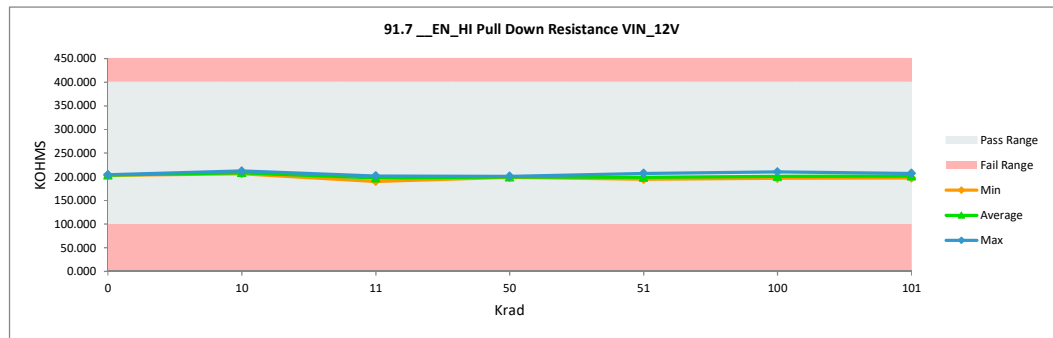

TID "HDR" Report
5962R2220102VXC

92.0_PWM_LI Rise Thresh VIN		
Test Site	DAL	DAL
Tester	ETS364	ETS364
Test Number	EB672303	EB672303
Unit	V	V
Max Limit	2.65	2.65
Min Limit	1.8	1.8

Krad	Serial #	Pre_HDR_6013	Post_HDR_6013	Delta
0	1	2.200	2.200	0.000
0	2	2.235	2.240	0.005
10	182	2.210	2.200	-0.010
10	202	2.200	2.185	-0.015
10	204	2.205	2.260	0.055
11	418	2.205	2.175	-0.030
11	419	2.205	2.235	0.030
11	443	2.210	2.180	-0.030
50	259	2.245	2.145	-0.100
50	346	2.205	2.135	-0.070
50	347	2.205	2.155	-0.050
51	462	2.195	2.200	0.005
51	478	2.225	2.175	-0.050
51	503	2.300	2.215	-0.085
100	354	2.265	2.195	-0.070
100	363	2.210	2.145	-0.065
100	366	2.270	2.180	-0.090
100	383	2.245	2.145	-0.100
100	417	2.230	2.160	-0.070
101	513	2.280	2.180	-0.100
101	526	2.290	2.150	-0.140
101	532	2.255	2.095	-0.160
101	533	2.195	2.100	-0.095
101	534	2.245	2.090	-0.155
Max		2.300	2.260	0.055
Average		2.230	2.172	-0.058
Min		2.195	2.090	-0.160
Std Dev		0.032	0.044	0.056

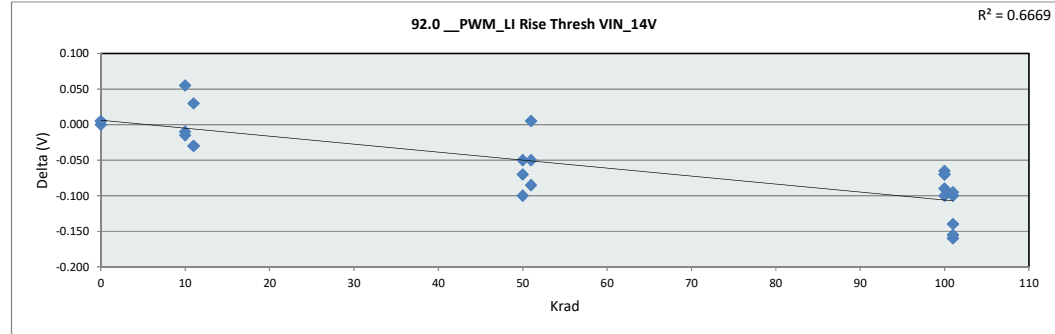

92.0_PWM_LI Rise Thresh V		
Test Site	DAL	
Tester	ETS364	
Test Number	EB672303	
Max Limit	2.65 V	
Min Limit	1.8 V	

Krad	0	10	11	50	51	100	101
LL	1.800	1.800	1.800	1.800	1.800	1.800	1.800
Min	2.200	2.185	2.175	2.135	2.175	2.145	2.090
Average	2.220	2.215	2.197	2.145	2.197	2.165	2.123
Max	2.240	2.260	2.235	2.155	2.215	2.195	2.180
UL	2.650	2.650	2.650	2.650	2.650	2.650	2.650

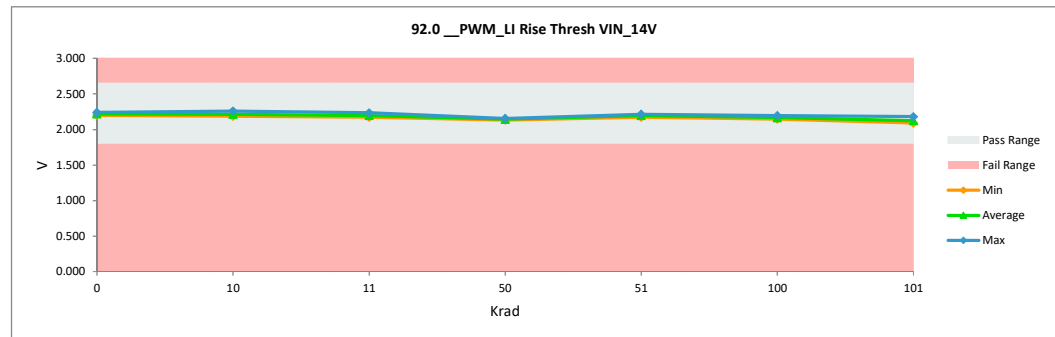

TID "HDR" Report
5962R2220102VXC

92.1 PWM_LI Fall Thresh VIN		
Test Site	DAL	DAL
Tester	ETS364	ETS364
Test Number	EB672303	EB672303
Unit	V	V
Max Limit	1.85	1.85
Min Limit	1.15	1.15

Krad	Serial #	Pre_HDR_6013	Post_HDR_6013	Delta
0	1	1.510	1.510	0.000
0	2	1.510	1.500	-0.010
10	182	1.445	1.500	0.055
10	202	1.435	1.450	0.015
10	204	1.505	1.495	-0.010
11	418	1.425	1.490	0.065
11	419	1.420	1.425	0.005
11	443	1.430	1.460	0.030
50	259	1.340	1.330	-0.010
50	346	1.500	1.480	-0.020
50	347	1.460	1.425	-0.035
51	462	1.505	1.475	-0.030
51	478	1.450	1.395	-0.055
51	503	1.500	1.465	-0.035
100	354	1.520	1.460	-0.060
100	363	1.510	1.340	-0.170
100	366	1.500	1.465	-0.035
100	383	1.435	1.420	-0.015
100	417	1.500	1.480	-0.020
101	513	1.415	1.430	0.015
101	526	1.505	1.440	-0.065
101	532	1.515	1.380	-0.135
101	533	1.435	1.435	0.000
101	534	1.420	1.440	0.020
Max		1.520	1.510	0.065
Average		1.466	1.445	-0.021
Min		1.340	1.330	-0.170
Std Dev		0.046	0.048	0.052

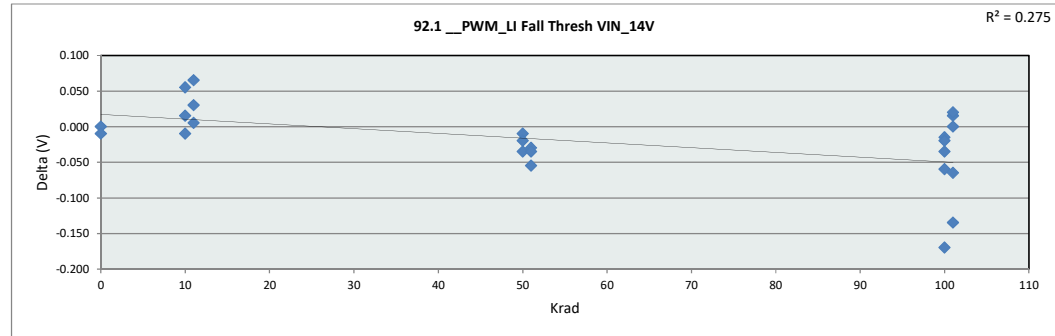

92.1 PWM_LI Fall Thresh VI		
Test Site	DAL	
Tester	ETS364	
Test Number	EB672303	
Max Limit	1.85	V
Min Limit	1.15	V

Krad	0	10	11	50	51	100	101
LL	1.150	1.150	1.150	1.150	1.150	1.150	1.150
Min	1.500	1.450	1.425	1.330	1.395	1.340	1.380
Average	1.505	1.482	1.458	1.412	1.445	1.433	1.425
Max	1.510	1.500	1.490	1.480	1.475	1.480	1.440
UL	1.850	1.850	1.850	1.850	1.850	1.850	1.850

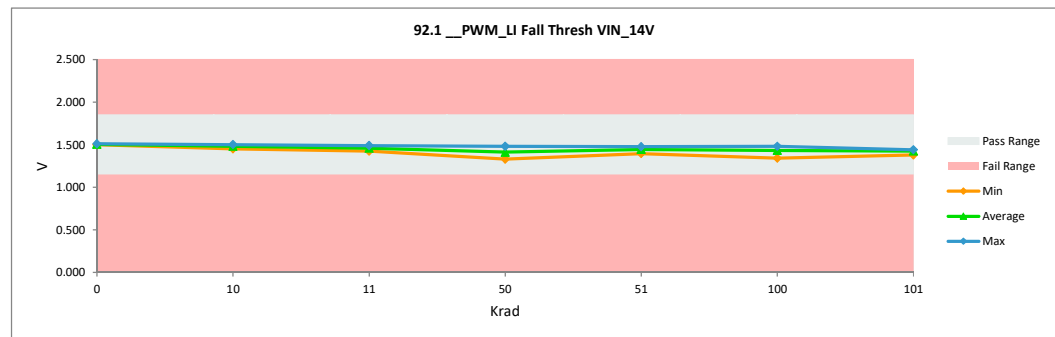

TID "HDR" Report
5962R2220102VXC

92.3 EN_HI Rise Thresh VIN		
Test Site	DAL	DAL
Tester	ETS364	ETS364
Test Number	EB672303	EB672303
Unit	V	V
Max Limit	2.65	2.65
Min Limit	1.8	1.8

Krad	Serial #	Pre_HDR_6013	Post_HDR_6013	Delta
0	1	2.215	2.220	0.005
0	2	2.285	2.295	0.010
10	182	2.285	2.295	0.010
10	202	2.260	2.255	-0.005
10	204	2.205	2.305	0.100
11	418	2.450	2.255	-0.195
11	419	2.315	2.240	-0.075
11	443	2.290	2.270	-0.020
50	259	2.340	2.325	-0.015
50	346	2.225	2.140	-0.085
50	347	2.305	2.240	-0.065
51	462	2.355	2.210	-0.145
51	478	2.350	2.265	-0.085
51	503	2.300	2.280	-0.020
100	354	2.270	2.120	-0.150
100	363	2.310	2.170	-0.140
100	366	2.220	2.130	-0.090
100	383	2.215	2.265	0.050
100	417	2.190	2.150	-0.040
101	513	2.345	2.230	-0.115
101	526	2.320	2.245	-0.075
101	532	2.335	2.210	-0.125
101	533	2.265	2.185	-0.080
101	534	2.265	2.135	-0.130
Max		2.450	2.325	0.100
Average		2.288	2.226	-0.062
Min		2.190	2.120	-0.195
Std Dev		0.060	0.060	0.071

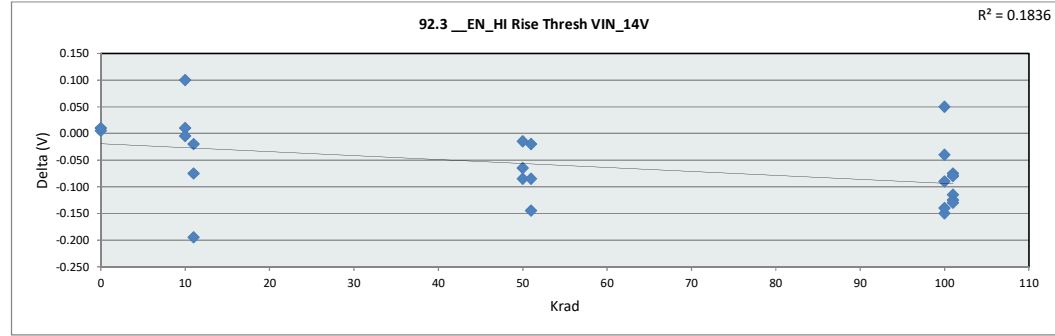

92.3 EN_HI Rise Thresh VIN		
Test Site	DAL	
Tester	ETS364	
Test Number	EB672303	
Max Limit	2.65	V
Min Limit	1.8	V

Krad	0	10	11	50	51	100	101
LL	1.800	1.800	1.800	1.800	1.800	1.800	1.800
Min	2.220	2.255	2.240	2.140	2.210	2.120	2.135
Average	2.258	2.285	2.255	2.235	2.252	2.167	2.201
Max	2.295	2.305	2.270	2.325	2.280	2.265	2.245
UL	2.650	2.650	2.650	2.650	2.650	2.650	2.650

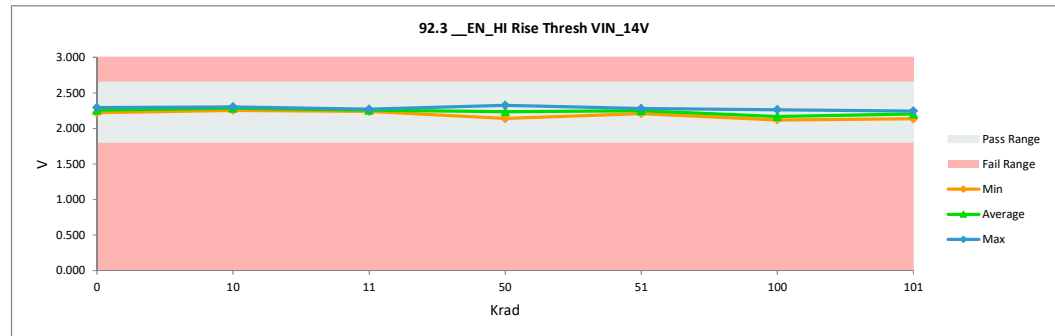

TID "HDR" Report
5962R2220102VXC

92.4 EN_HI Fall Thresh VIN_1		
Test Site	DAL	DAL
Tester	ETS364	ETS364
Test Number	EB672303	EB672303
Unit	V	V
Max Limit	1.85	1.85
Min Limit	1.15	1.15

Krad	Serial #	Pre_HDR_6013	Post_HDR_6013	Delta
0	1	1.495	1.490	-0.005
0	2	1.420	1.420	0.000
10	182	1.505	1.495	-0.010
10	202	1.440	1.430	-0.010
10	204	1.415	1.495	0.080
11	418	1.330	1.490	0.160
11	419	1.515	1.500	-0.015
11	443	1.505	1.435	-0.070
50	259	1.360	1.335	-0.025
50	346	1.455	1.460	0.005
50	347	1.515	1.485	-0.030
51	462	1.465	1.395	-0.070
51	478	1.505	1.380	-0.125
51	503	1.400	1.365	-0.035
100	354	1.520	1.440	-0.080
100	363	1.445	1.350	-0.095
100	366	1.405	1.460	0.055
100	383	1.405	1.350	-0.055
100	417	1.490	1.325	-0.165
101	513	1.450	1.385	-0.065
101	526	1.425	1.365	-0.060
101	532	1.400	1.370	-0.030
101	533	1.505	1.385	-0.120
101	534	1.515	1.405	-0.110
Max		1.520	1.500	0.160
Average		1.454	1.417	-0.036
Min		1.330	1.325	-0.165
Std Dev		0.054	0.057	0.070

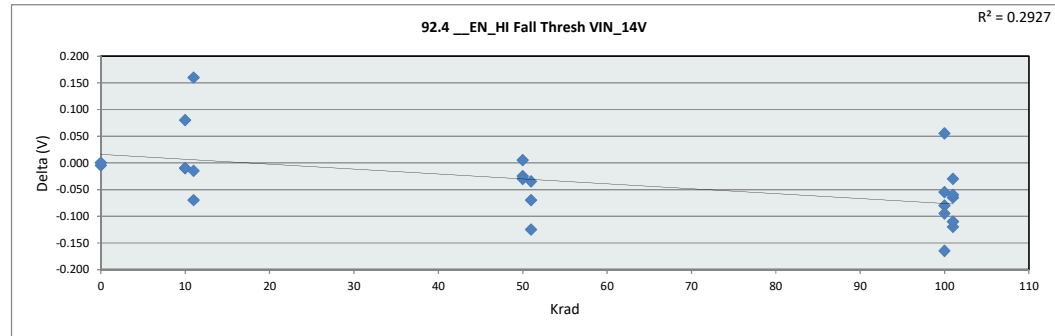

92.4 EN_HI Fall Thresh VIN

Test Site	DAL
Tester	ETS364
Test Number	EB672303
Max Limit	1.85 V
Min Limit	1.15 V

Krad	0	10	11	50	51	100	101
LL	1.150	1.150	1.150	1.150	1.150	1.150	1.150
Min	1.420	1.430	1.435	1.335	1.365	1.325	1.365
Average	1.455	1.473	1.475	1.427	1.380	1.385	1.382
Max	1.490	1.495	1.500	1.485	1.395	1.460	1.405
UL	1.850	1.850	1.850	1.850	1.850	1.850	1.850

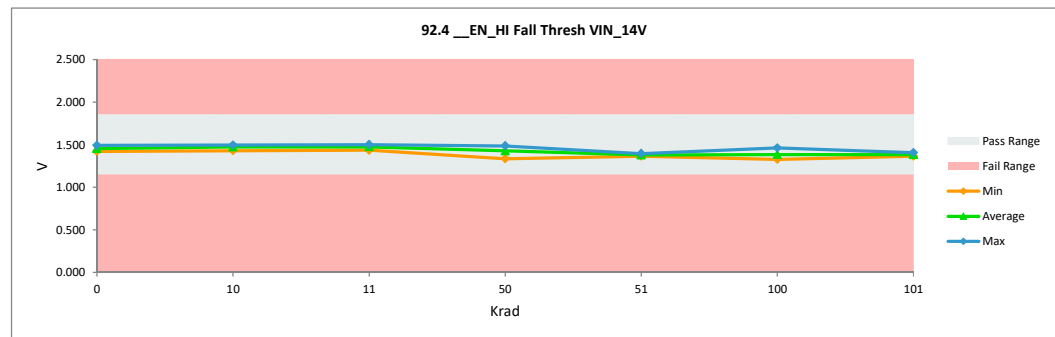

TID "HDR" Report
5962R2220102VXC

92.6_PWM_LI Pull Down Resis		
Test Site	DAL	DAL
Tester	ETS364	ETS364
Test Number	EB672303	EB672303
Unit	KOHMS	KOHMS
Max Limit	400	400
Min Limit	100	100

Krad	Serial #	Pre_HDR_6013	Post_HDR_6013	Delta
0	1	201.480	204.768	3.288
0	2	201.682	204.292	2.609
10	182	210.943	214.042	3.098
10	202	205.991	205.840	-0.151
10	204	198.949	207.880	8.931
11	418	198.278	192.428	-5.851
11	419	198.558	202.872	4.313
11	443	207.396	201.714	-5.682
50	259	198.912	200.161	1.249
50	346	198.278	200.198	1.920
50	347	201.376	202.270	0.894
51	462	200.061	195.641	-4.420
51	478	202.546	207.557	5.011
51	503	196.614	196.025	-0.589
100	354	200.427	201.408	0.981
100	363	203.976	201.316	-2.660
100	366	199.153	199.921	0.767
100	383	197.700	210.529	12.829
100	417	200.337	197.899	-2.438
101	513	199.731	199.111	-0.621
101	526	205.240	204.408	-0.832
101	532	198.738	198.666	-0.072
101	533	209.005	208.748	-0.258
101	534	203.024	203.050	0.026
Max		210.943	214.042	12.829
Average		201.600	202.531	0.931
Min		196.614	192.428	-5.851
Std Dev		3.762	4.992	4.184

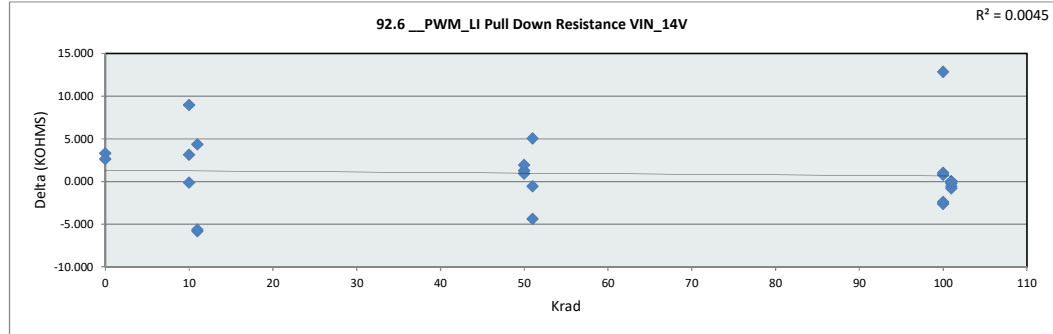

92.6_PWM_LI Pull Down Res		
Test Site	DAL	
Tester	ETS364	
Test Number	EB672303	
Max Limit	400	KOHMS
Min Limit	100	KOHMS

Krad	0	10	11	50	51	100	101
LL	100.000	100.000	100.000	100.000	100.000	100.000	100.000
Min	204.292	205.840	192.428	200.161	195.641	197.899	198.666
Average	204.530	209.254	199.004	200.876	199.741	202.215	202.796
Max	204.768	214.042	202.872	202.270	207.557	210.529	208.748
UL	400.000	400.000	400.000	400.000	400.000	400.000	400.000

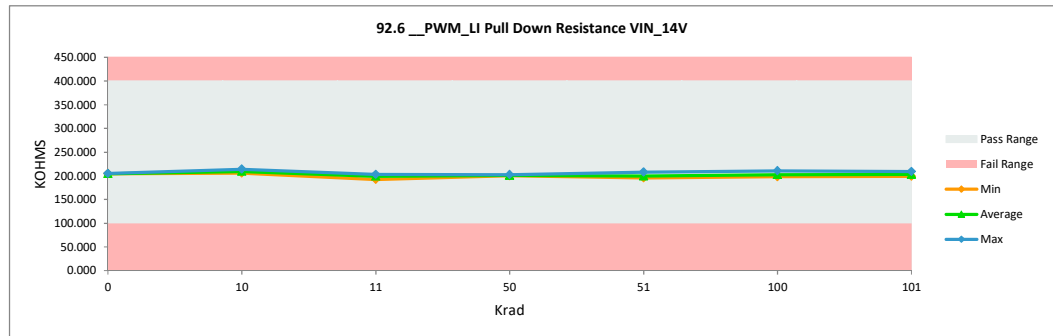

TID "HDR" Report
5962R2220102VXC

92.7 EN_HI Pull Down Resista		
Test Site	DAL	DAL
Tester	ETS364	ETS364
Test Number	EB672303	EB672303
Unit	KOHMS	KOHMS
Max Limit	400	400
Min Limit	100	100

Krad	Serial #	Pre_HDR_6013	Post_HDR_6013	Delta
0	1	199.816	203.085	3.269
0	2	201.507	204.131	2.624
10	182	208.991	212.041	3.050
10	202	206.245	206.075	-0.170
10	204	197.844	207.350	9.505
11	418	198.152	190.170	-7.981
11	419	197.049	201.657	4.607
11	443	207.301	201.258	-6.043
50	259	197.587	198.646	1.059
50	346	196.694	198.500	1.806
50	347	200.186	200.884	0.698
51	462	198.882	194.344	-4.538
51	478	202.577	207.250	4.674
51	503	195.493	194.882	-0.611
100	354	198.693	199.453	0.760
100	363	202.897	200.513	-2.383
100	366	198.286	198.834	0.548
100	383	198.144	210.159	12.015
100	417	200.163	196.568	-3.595
101	513	198.621	197.970	-0.650
101	526	204.809	203.954	-0.856
101	532	197.278	197.210	-0.068
101	533	207.249	207.011	-0.239
101	534	202.128	202.125	-0.002
Max		208.991	212.041	12.015
Average		200.691	201.420	0.728
Min		195.493	190.170	-7.981
Std Dev		3.798	5.229	4.367

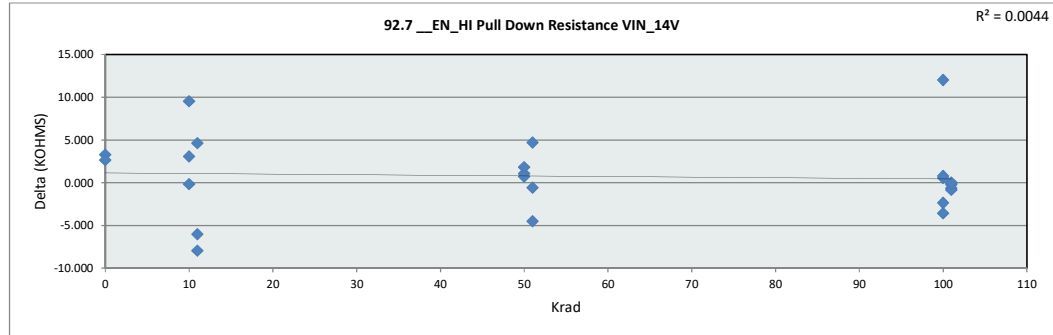

92.7 EN_HI Pull Down Resis		
Test Site	DAL	
Tester	ETS364	
Test Number	EB672303	
Max Limit	400	KOHMS
Min Limit	100	KOHMS

	0	10	11	50	51	100	101
LL	100.000	100.000	100.000	100.000	100.000	100.000	100.000
Min	203.085	206.075	190.170	198.500	194.344	196.568	197.210
Average	203.608	208.488	197.695	199.343	198.825	201.105	201.654
Max	204.131	212.041	201.657	200.884	207.250	210.159	207.011
UL	400.000	400.000	400.000	400.000	400.000	400.000	400.000

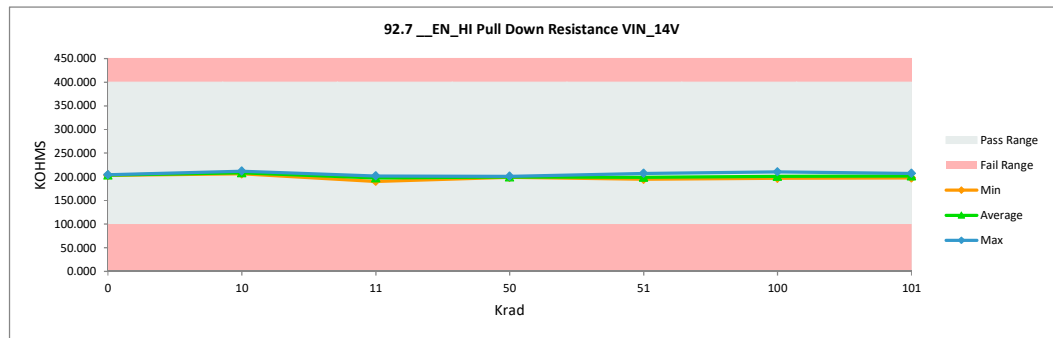

TID "HDR" Report
5962R2220102VXC

95.0 DLH Dead Time Min 500k		
Test Site	DAL	DAL
Tester	ETS364	ETS364
Test Number	EB672303	EB672303
Unit		
Max Limit	10	10
Min Limit	0	0

Krad	Serial #	Pre_HDR_6013	Post_HDR_6013	Delta
0	1	4.205	4.020	-0.185
0	2	4.253	4.175	-0.078
10	182	4.185	4.176	-0.009
10	202	3.946	3.564	-0.382
10	204	3.956	3.715	-0.241
11	418	4.323	4.387	0.064
11	419	3.815	4.130	0.315
11	443	3.560	4.634	1.075
50	259	4.618	4.654	0.036
50	346	3.590	3.759	0.169
50	347	3.243	3.417	0.174
51	462	4.033	3.869	-0.164
51	478	4.101	3.726	-0.375
51	503	4.714	4.820	0.105
100	354	4.205	4.573	0.368
100	363	3.801	3.618	-0.183
100	366	4.590	4.739	0.149
100	383	4.886	4.601	-0.285
100	417	3.419	4.291	0.872
101	513	4.259	4.484	0.225
101	526	4.327	4.378	0.051
101	532	4.209	4.652	0.443
101	533	3.396	4.166	0.770
101	534	4.460	5.015	0.555
Max		4.886	5.015	1.075
Average		4.087	4.232	0.145
Min		3.243	3.417	-0.382
Std Dev		0.432	0.444	0.386

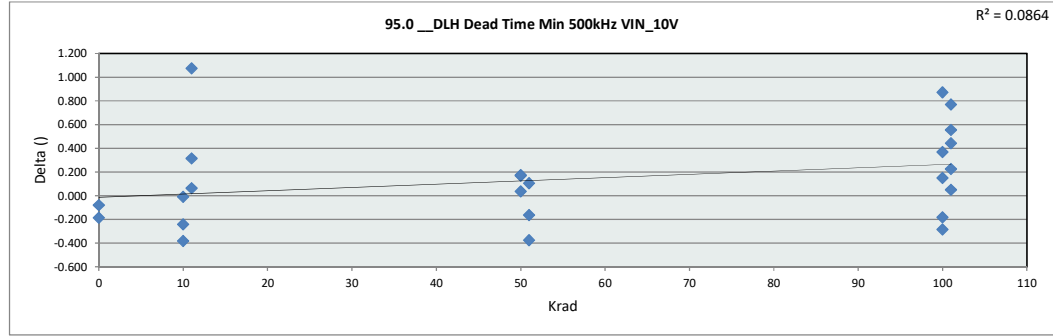

95.0 DLH Dead Time Min 500k	
Test Site	DAL
Tester	ETS364
Test Number	EB672303
Max Limit	10
Min Limit	0

Krad	0	10	11	50	51	100	101
LL	0.000	0.000	0.000	0.000	0.000	0.000	0.000
Min	4.020	3.564	4.130	3.417	3.726	3.618	4.166
Average	4.098	3.818	4.384	3.944	4.138	4.364	4.539
Max	4.175	4.176	4.634	4.654	4.820	4.739	5.015
UL	10.000	10.000	10.000	10.000	10.000	10.000	10.000

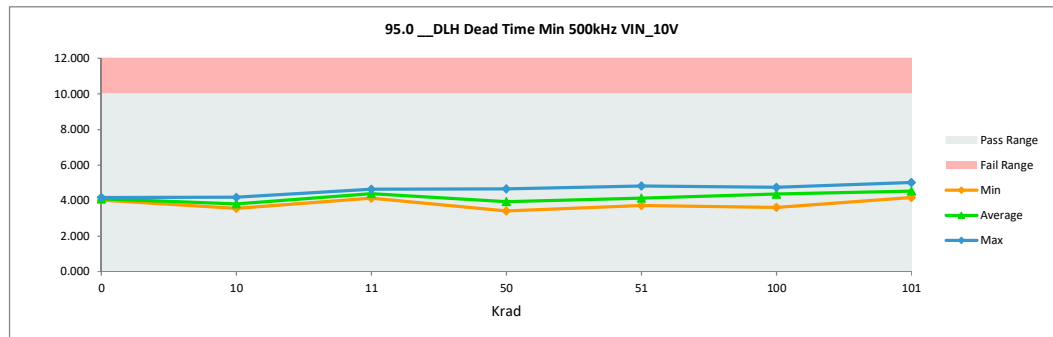

TID "HDR" Report
5962R2220102VXC

95.1 DLH Dead Time Small 500		
Test Site	DAL	DAL
Tester	ETS364	ETS364
Test Number	EB672303	EB672303
Unit		
Max Limit	15.5	15.5
Min Limit	8	8

Krad	Serial #	Pre_HDR_6013	Post_HDR_6013	Delta
0	1	11.555	11.327	-0.227
0	2	11.135	10.917	-0.218
10	182	11.462	11.423	-0.040
10	202	11.240	10.799	-0.441
10	204	11.504	11.365	-0.139
11	418	11.683	11.278	-0.404
11	419	11.421	11.392	-0.029
11	443	11.027	11.905	0.878
50	259	11.382	11.131	-0.251
50	346	11.082	10.701	-0.381
50	347	10.967	10.425	-0.542
51	462	11.600	10.344	-1.256
51	478	11.652	10.618	-1.033
51	503	11.857	11.645	-0.212
100	354	11.793	11.180	-0.614
100	363	11.162	10.150	-1.012
100	366	11.676	10.816	-0.860
100	383	12.401	10.931	-1.470
100	417	10.956	10.568	-0.388
101	513	11.511	10.604	-0.907
101	526	11.753	10.743	-1.010
101	532	11.456	10.819	-0.636
101	533	10.797	10.375	-0.422
101	534	11.261	10.800	-0.462
	Max	12.401	11.905	0.878
	Average	11.431	10.927	-0.503
	Min	10.797	10.150	-1.470
	Std Dev	0.358	0.442	0.487

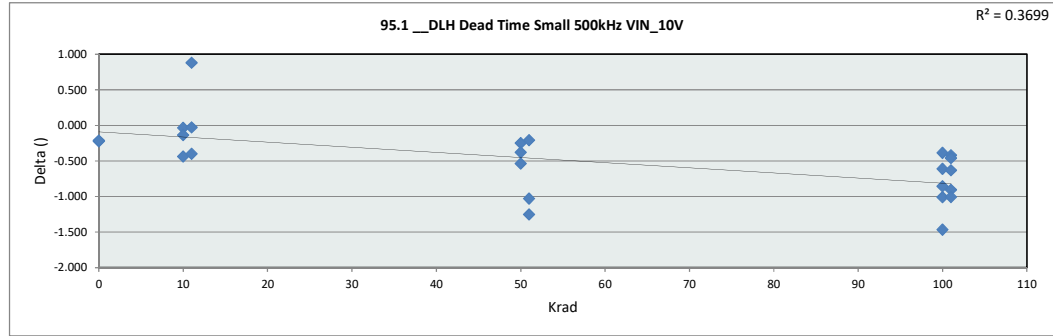

95.1 DLH Dead Time Small 5	
Test Site	DAL
Tester	ETS364
Test Number	EB672303
Max Limit	15.5
Min Limit	8

Krad	0	10	11	50	51	100	101
LL	8.000	8.000	8.000	8.000	8.000	8.000	8.000
Min	10.918	10.799	11.278	10.425	10.344	10.150	10.375
Average	11.122	11.196	11.525	10.753	10.869	10.729	10.668
Max	11.327	11.423	11.905	11.131	11.645	11.180	10.819
UL	15.500	15.500	15.500	15.500	15.500	15.500	15.500

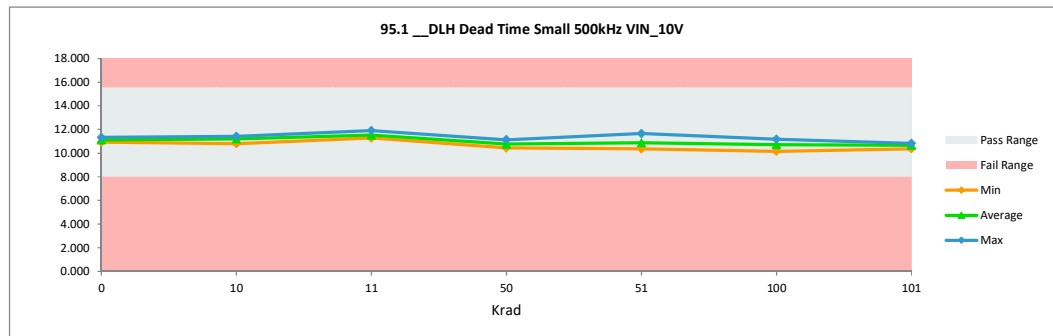

TID "HDR" Report
5962R2220102VXC

95.2 DLH Dead Time Mid 500k		
Test Site	DAL	DAL
Tester	ETS364	ETS364
Test Number	EB672303	EB672303
Unit		
Max Limit	24	24
Min Limit	15.5	15.5

Krad	Serial #	Pre_HDR_6013	Post_HDR_6013	Delta
0	1	19.915	20.049	0.134
0	2	19.267	19.268	0.001
10	182	20.198	20.095	-0.103
10	202	19.947	19.617	-0.330
10	204	20.461	20.289	-0.172
11	418	20.349	19.856	-0.493
11	419	19.973	19.827	-0.146
11	443	19.591	20.249	0.658
50	259	19.417	18.956	-0.461
50	346	19.462	18.953	-0.509
50	347	20.018	19.149	-0.869
51	462	20.279	18.698	-1.582
51	478	20.539	19.304	-1.235
51	503	20.316	19.733	-0.583
100	354	20.482	19.242	-1.240
100	363	19.896	18.395	-1.502
100	366	19.579	18.290	-1.289
100	383	20.739	19.004	-1.734
100	417	19.599	18.509	-1.090
101	513	20.118	18.357	-1.760
101	526	20.291	18.926	-1.364
101	532	19.862	18.813	-1.049
101	533	19.601	18.326	-1.275
101	534	19.436	18.133	-1.303
	Max	20.739	20.289	0.658
	Average	19.972	19.168	-0.804
	Min	19.267	18.133	-1.760
	Std Dev	0.411	0.669	0.659

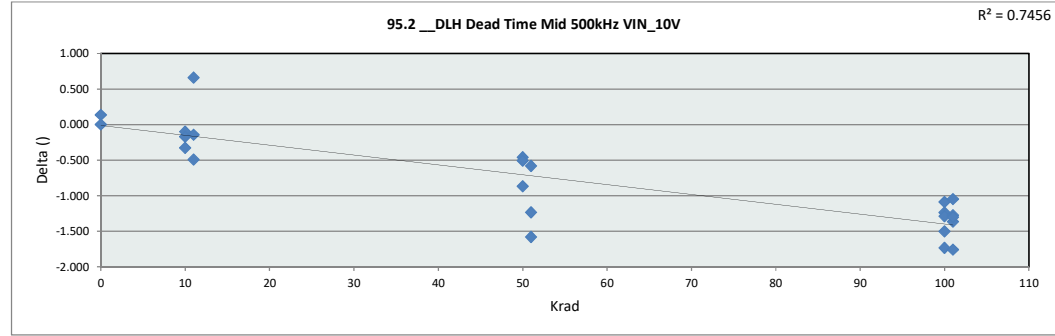

95.2 DLH Dead Time Mid 500k	
Test Site	DAL
Tester	ETS364
Test Number	EB672303
Max Limit	24
Min Limit	15.5

Krad	0	10	11	50	51	100	101
LL	15.500	15.500	15.500	15.500	15.500	15.500	15.500
Min	19.268	19.617	19.827	18.953	18.698	18.290	18.133
Average	19.659	20.000	19.977	19.019	19.245	18.688	18.511
Max	20.049	20.289	20.249	19.149	19.733	19.242	18.926
UL	24.000	24.000	24.000	24.000	24.000	24.000	24.000

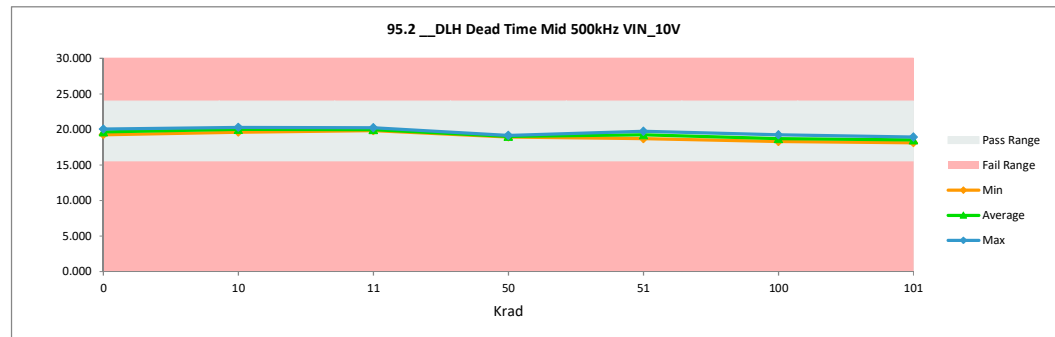

TID "HDR" Report
5962R2220102VXC

95.3 DLH Dead Time Large 500kHz VIN_10V		
Test Site	DAL	DAL
Tester	ETS364	ETS364
Test Number	EB672303	EB672303
Unit		
Max Limit	59	59
Min Limit	36	36

Krad	Serial #	Pre_HDR_6013	Post_HDR_6013	Delta
0	1	48.380	48.265	-0.116
0	2	46.223	46.360	0.137
10	182	48.163	48.053	-0.110
10	202	48.725	47.961	-0.764
10	204	49.427	49.170	-0.257
11	418	48.754	47.935	-0.819
11	419	48.537	48.333	-0.204
11	443	48.268	47.983	-0.285
50	259	45.944	44.497	-1.447
50	346	47.866	46.255	-1.611
50	347	49.612	47.427	-2.185
51	462	49.617	45.657	-3.960
51	478	49.711	47.131	-2.580
51	503	48.784	46.645	-2.139
100	354	49.107	45.819	-3.288
100	363	48.315	45.312	-3.002
100	366	46.238	43.282	-2.956
100	383	49.299	45.152	-4.148
100	417	48.115	45.623	-2.492
101	513	48.455	44.166	-4.289
101	526	48.933	45.362	-3.571
101	532	48.200	44.714	-3.486
101	533	48.522	45.086	-3.435
101	534	46.106	42.833	-3.272
Max		49.711	49.170	0.137
Average		48.304	46.209	-2.095
Min		45.944	42.833	-4.289
Std Dev		1.117	1.702	1.479

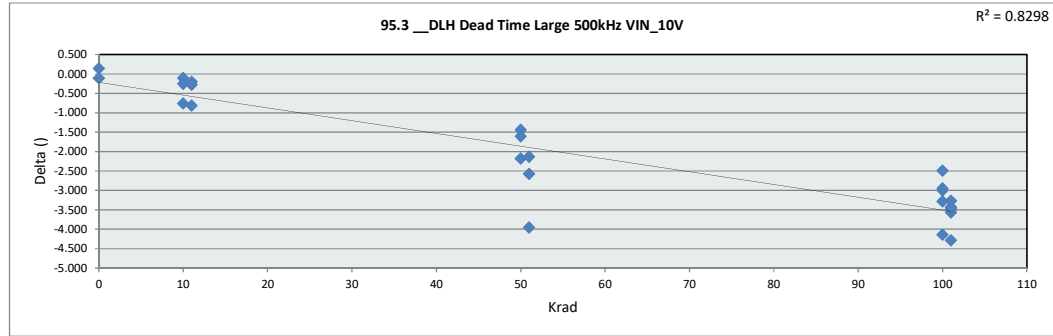

95.3 DLH Dead Time Large 500kHz VIN_10V	
Test Site	DAL
Tester	ETS364
Test Number	EB672303
Max Limit	59
Min Limit	36

Krad	0	10	11	50	51	100	101
LL	36.000	36.000	36.000	36.000	36.000	36.000	36.000
Min	46.360	47.961	47.935	44.497	45.657	43.282	42.833
Average	47.312	48.395	48.084	46.060	46.478	45.038	44.432
Max	48.265	49.170	48.333	47.427	47.131	45.819	45.362
UL	59.000	59.000	59.000	59.000	59.000	59.000	59.000

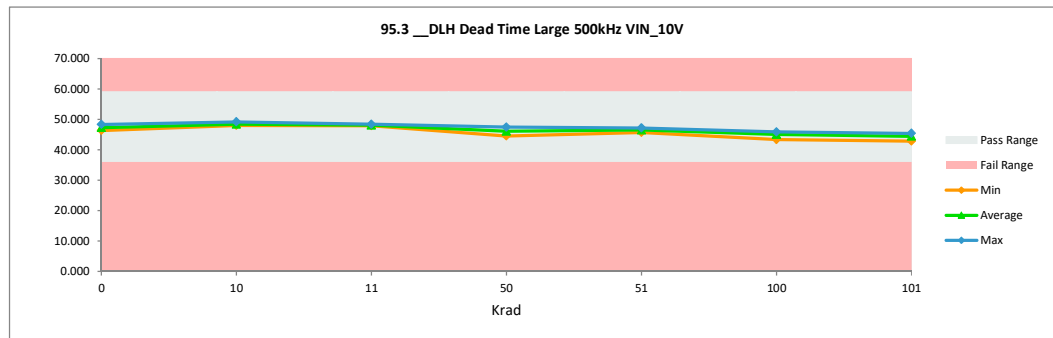

TID "HDR" Report
5962R2220102VXC

95.4 DLH Dead Time Max 500K		
Test Site	DAL	DAL
Tester	ETS364	ETS364
Test Number	EB672303	EB672303
Unit		
Max Limit	113.5	113.5
Min Limit	74	74

Krad	Serial #	Pre_HDR_6013	Post_HDR_6013	Delta
0	1	93.713	93.728	0.015
0	2	89.237	89.385	0.148
10	182	93.337	92.809	-0.528
10	202	94.046	92.948	-1.097
10	204	95.604	95.206	-0.398
11	418	94.157	92.746	-1.411
11	419	94.392	93.961	-0.431
11	443	93.538	91.675	-1.863
50	259	88.047	84.660	-3.388
50	346	92.426	88.456	-3.970
50	347	96.715	93.166	-3.550
51	462	97.034	88.751	-8.283
51	478	96.997	91.478	-5.518
51	503	94.423	89.824	-4.598
100	354	95.189	87.953	-7.236
100	363	94.051	87.819	-6.232
100	366	88.732	82.758	-5.975
100	383	94.930	86.313	-8.617
100	417	93.403	88.349	-5.054
101	513	93.824	85.590	-8.234
101	526	94.026	86.719	-7.308
101	532	93.280	85.463	-7.816
101	533	94.980	87.502	-7.478
101	534	88.553	81.941	-6.612
Max		97.034	95.206	0.148
Average		93.526	89.133	-4.393
Min		88.047	81.941	-8.617
Std Dev		2.520	3.674	3.042

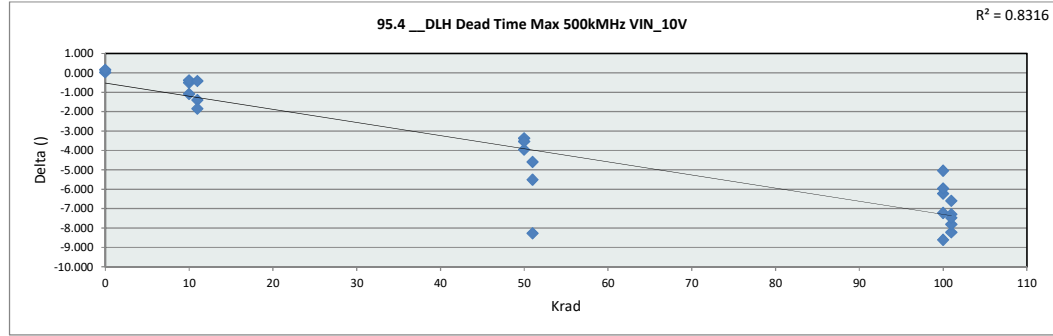

95.4 DLH Dead Time Max 50	
Test Site	DAL
Tester	ETS364
Test Number	EB672303
Max Limit	113.5
Min Limit	74

Krad	0	10	11	50	51	100	101
LL	74.000	74.000	74.000	74.000	74.000	74.000	74.000
Min	89.385	92.809	91.676	84.660	88.751	82.758	81.941
Average	91.557	93.655	92.794	88.760	90.018	86.638	85.443
Max	93.728	95.206	93.961	93.166	91.478	88.349	87.502
UL	113.500	113.500	113.500	113.500	113.500	113.500	113.500

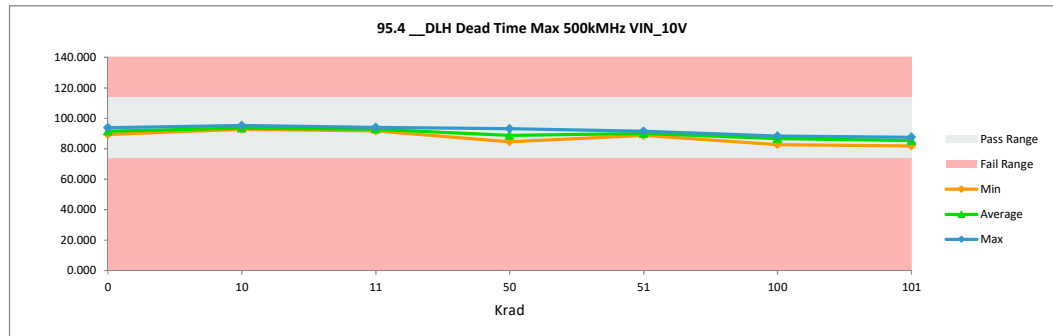

TID "HDR" Report
5962R2220102VXC

95.5 DLH Dead Time Min 1MHz		
Test Site	DAL	DAL
Tester	ETS364	ETS364
Test Number	EB672303	EB672303
Unit		
Max Limit	10	10
Min Limit	0	0

Krad	Serial #	Pre_HDR_6013	Post_HDR_6013	Delta
0	1	4.254	4.053	-0.201
0	2	4.314	4.290	-0.024
10	182	4.391	4.409	0.018
10	202	4.010	3.644	-0.366
10	204	4.050	4.076	0.026
11	418	4.449	4.539	0.090
11	419	3.912	4.098	0.186
11	443	3.743	4.661	0.918
50	259	4.504	4.852	0.348
50	346	3.792	3.877	0.085
50	347	3.516	3.539	0.023
51	462	3.873	4.018	0.145
51	478	4.115	3.777	-0.338
51	503	4.758	5.063	0.304
100	354	4.405	4.801	0.396
100	363	3.738	3.866	0.128
100	366	4.720	4.902	0.182
100	383	4.985	4.834	-0.151
100	417	3.758	4.385	0.627
101	513	4.446	4.721	0.275
101	526	4.467	4.631	0.164
101	532	4.148	4.851	0.702
101	533	3.625	4.046	0.421
101	534	4.713	4.974	0.261
	Max	4.985	5.063	0.918
	Average	4.195	4.371	0.176
	Min	3.516	3.539	-0.366
	Std Dev	0.400	0.460	0.305

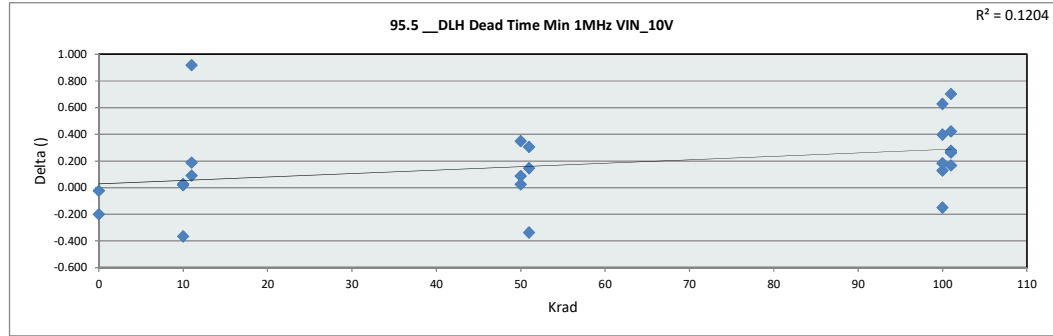

95.5 DLH Dead Time Min 1M	
Test Site	DAL
Tester	ETS364
Test Number	EB672303
Max Limit	10
Min Limit	0

Krad	0	10	11	50	51	100	101
LL	0.000	0.000	0.000	0.000	0.000	0.000	0.000
Min	4.053	3.644	4.098	3.539	3.777	3.866	4.046
Average	4.171	4.043	4.433	4.090	4.286	4.558	4.644
Max	4.290	4.409	4.661	4.852	5.063	4.902	4.974
UL	10.000	10.000	10.000	10.000	10.000	10.000	10.000

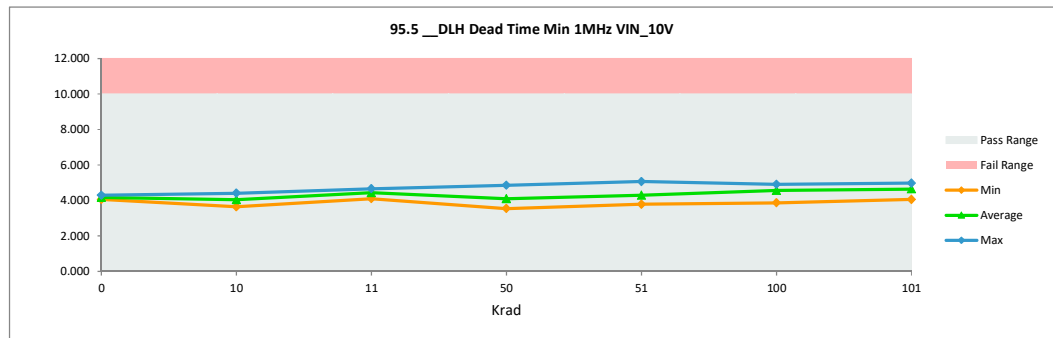

TID "HDR" Report
5962R2220102VXC

95.6 DLH Dead Time Small 1M		
Test Site	DAL	DAL
Tester	ETS364	ETS364
Test Number	EB672303	EB672303
Unit		
Max Limit	15.5	15.5
Min Limit	8	8

Krad	Serial #	Pre_HDR_6013	Post_HDR_6013	Delta
0	1	11.505	11.361	-0.144
0	2	10.901	10.869	-0.032
10	182	11.440	11.364	-0.076
10	202	11.177	10.928	-0.248
10	204	11.476	11.305	-0.172
11	418	11.719	11.406	-0.313
11	419	11.279	11.186	-0.094
11	443	10.972	11.583	0.611
50	259	11.386	11.050	-0.335
50	346	10.852	10.616	-0.236
50	347	10.788	10.250	-0.539
51	462	11.342	10.260	-1.082
51	478	11.651	10.616	-1.035
51	503	11.752	11.388	-0.364
100	354	11.727	10.986	-0.741
100	363	11.022	10.144	-0.878
100	366	11.393	10.871	-0.522
100	383	12.286	10.970	-1.316
100	417	10.907	10.496	-0.411
101	513	11.549	10.486	-1.063
101	526	11.614	10.651	-0.962
101	532	11.388	10.759	-0.629
101	533	10.817	10.338	-0.478
101	534	11.249	10.752	-0.496
	Max	12.286	11.583	0.611
	Average	11.341	10.860	-0.482
	Min	10.788	10.144	-1.316
	Std Dev	0.368	0.414	0.432

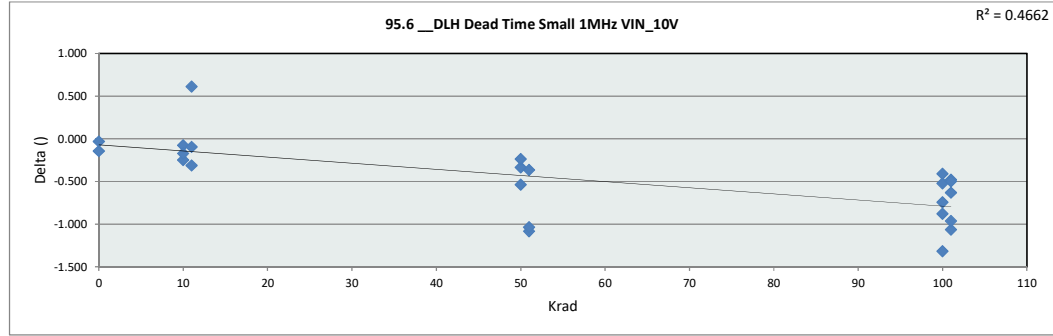

95.6 DLH Dead Time Small 1	
Test Site	DAL
Tester	ETS364
Test Number	EB672303
Max Limit	15.5
Min Limit	8

Krad	0	10	11	50	51	100	101
LL	8.000	8.000	8.000	8.000	8.000	8.000	8.000
Min	10.869	10.928	11.186	10.250	10.260	10.144	10.338
Average	11.115	11.199	11.392	10.639	10.755	10.693	10.597
Max	11.361	11.364	11.583	11.050	11.388	10.986	10.759
UL	15.500	15.500	15.500	15.500	15.500	15.500	15.500

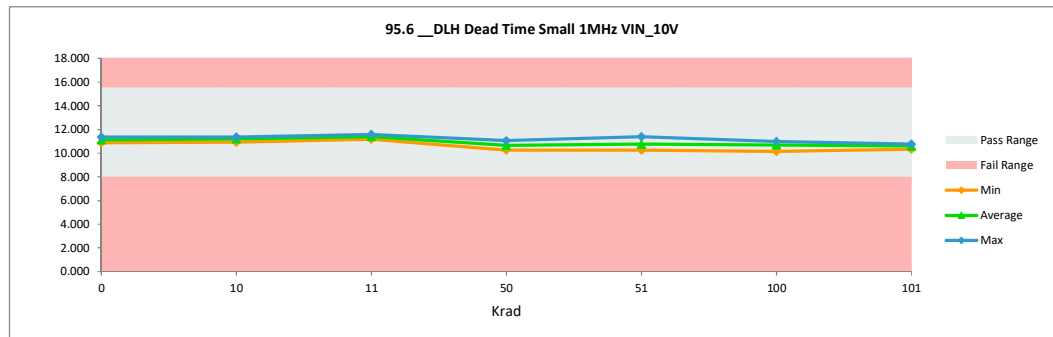

TID "HDR" Report
5962R2220102VXC

95.7 DLH Dead Time Mid 1MHz		
Test Site	DAL	DAL
Tester	ETS364	ETS364
Test Number	EB672303	EB672303
Unit		
Max Limit	24	24
Min Limit	15.5	15.5

Krad	Serial #	Pre_HDR_6013	Post_HDR_6013	Delta
0	1	19.730	19.597	-0.133
0	2	18.849	18.761	-0.088
10	182	19.643	19.523	-0.121
10	202	19.763	19.176	-0.587
10	204	19.850	19.800	-0.050
11	418	19.919	19.428	-0.490
11	419	19.684	19.393	-0.291
11	443	19.151	19.680	0.528
50	259	19.036	18.438	-0.598
50	346	19.279	18.519	-0.760
50	347	19.482	18.782	-0.700
51	462	20.007	18.379	-1.628
51	478	20.077	18.755	-1.322
51	503	19.957	19.287	-0.670
100	354	20.018	18.707	-1.311
100	363	19.415	17.913	-1.502
100	366	19.199	18.045	-1.155
100	383	20.525	18.623	-1.903
100	417	19.154	18.242	-0.912
101	513	19.785	17.958	-1.827
101	526	19.864	18.547	-1.317
101	532	19.570	18.494	-1.076
101	533	19.222	17.889	-1.333
101	534	18.923	18.002	-0.921
	Max	20.525	19.800	0.528
	Average	19.588	18.747	-0.840
	Min	18.849	17.889	-1.903
	Std Dev	0.420	0.605	0.623

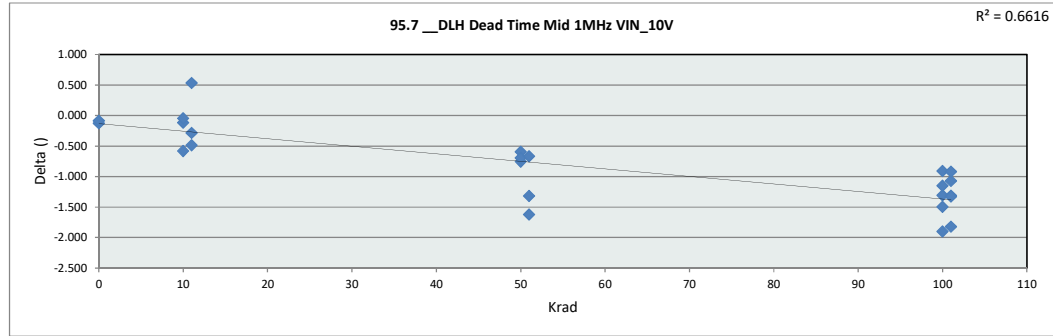

95.7 DLH Dead Time Mid 1M	
Test Site	DAL
Tester	ETS364
Test Number	EB672303
Max Limit	24
Min Limit	15.5

	0	10	11	50	51	100	101
LL	15.500	15.500	15.500	15.500	15.500	15.500	15.500
Min	18.762	19.176	19.393	18.438	18.379	17.913	17.889
Average	19.179	19.500	19.500	18.580	18.807	18.306	18.178
Max	19.597	19.800	19.680	18.782	19.287	18.707	18.547
UL	24.000	24.000	24.000	24.000	24.000	24.000	24.000

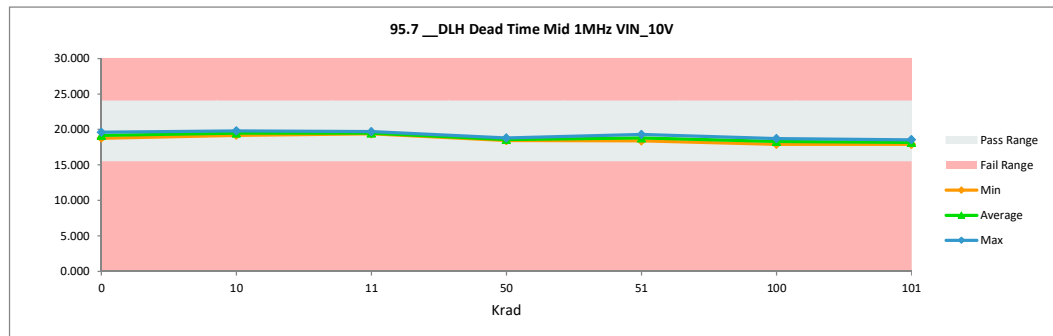

TID "HDR" Report
5962R2220102VXC

95.8 DLH Dead Time Large 1M		
Test Site	DAL	DAL
Tester	ETS364	ETS364
Test Number	EB672303	EB672303
Unit		
Max Limit	59	59
Min Limit	36	36

Krad	Serial #	Pre_HDR_6013	Post_HDR_6013	Delta
0	1	46.699	46.586	-0.113
0	2	44.686	44.585	-0.101
10	182	46.538	46.267	-0.271
10	202	47.012	46.339	-0.673
10	204	47.626	47.355	-0.271
11	418	46.920	46.144	-0.776
11	419	46.925	46.498	-0.427
11	443	46.421	46.080	-0.341
50	259	44.300	43.058	-1.242
50	346	46.127	44.471	-1.655
50	347	47.543	45.678	-1.866
51	462	47.809	44.050	-3.759
51	478	47.980	45.360	-2.620
51	503	47.148	44.986	-2.162
100	354	47.290	44.218	-3.072
100	363	46.553	43.519	-3.034
100	366	44.701	42.146	-2.556
100	383	47.681	43.514	-4.167
100	417	46.287	43.939	-2.348
101	513	46.696	42.709	-3.987
101	526	47.191	43.761	-3.431
101	532	46.329	43.102	-3.227
101	533	46.789	43.223	-3.566
101	534	44.450	41.822	-2.628
Max		47.980	47.355	-0.101
Average		46.571	44.559	-2.012
Min		44.300	41.822	-4.167
Std Dev		1.056	1.549	1.376

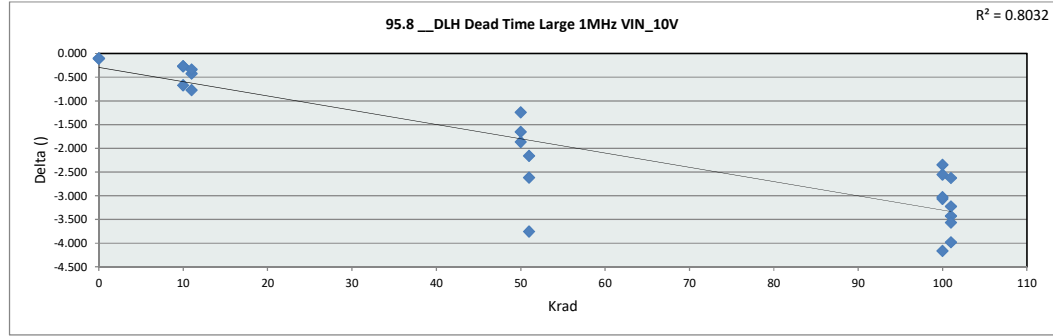

95.8 DLH Dead Time Large 1	
Test Site	DAL
Tester	ETS364
Test Number	EB672303
Max Limit	59
Min Limit	36

Krad	0	10	11	50	51	100	101
LL	36.000	36.000	36.000	36.000	36.000	36.000	36.000
Min	44.585	46.267	46.080	43.058	44.050	42.146	41.822
Average	45.585	46.654	46.241	44.402	44.799	43.467	42.923
Max	46.586	47.355	46.498	45.678	45.360	44.218	43.761
UL	59.000	59.000	59.000	59.000	59.000	59.000	59.000

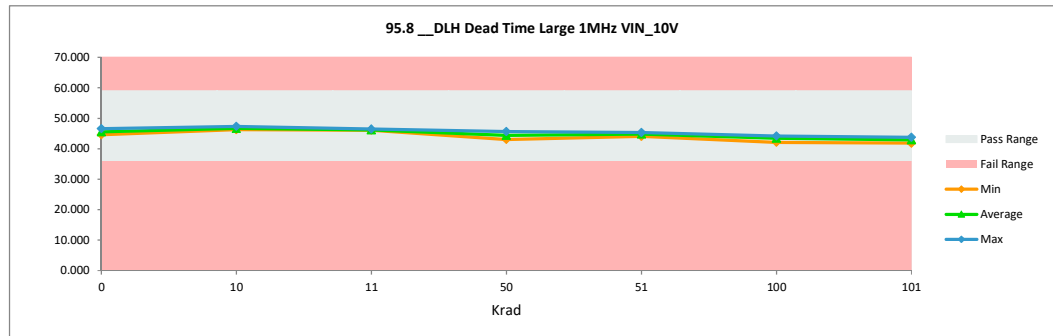

TID "HDR" Report
5962R2220102VXC

95.9 DLH Dead Time Max 1MHz		
Test Site	DAL	DAL
Tester	ETS364	ETS364
Test Number	EB672303	EB672303
Unit		
Max Limit	113.5	113.5
Min Limit	74	74

Krad	Serial #	Pre_HDR_6013	Post_HDR_6013	Delta
0	1	89.003	89.019	0.016
0	2	85.096	85.026	-0.070
10	182	88.983	88.403	-0.580
10	202	89.685	88.399	-1.285
10	204	91.348	91.060	-0.288
11	418	89.540	88.017	-1.523
11	419	89.770	89.422	-0.348
11	443	89.030	87.307	-1.723
50	259	83.933	80.933	-3.000
50	346	87.968	84.795	-3.172
50	347	92.410	88.768	-3.642
51	462	92.581	84.528	-8.053
51	478	92.668	87.327	-5.341
51	503	89.887	85.701	-4.186
100	354	90.689	84.087	-6.602
100	363	89.658	83.866	-5.792
100	366	84.602	79.231	-5.371
100	383	90.347	82.563	-7.784
100	417	88.902	84.329	-4.574
101	513	89.189	81.918	-7.271
101	526	89.484	82.807	-6.677
101	532	88.610	81.588	-7.022
101	533	90.260	83.420	-6.841
101	534	84.374	78.302	-6.072
Max		92.668	91.060	0.016
Average		89.084	85.034	-4.050
Min		83.933	78.302	-8.053
Std Dev		2.425	3.375	2.758

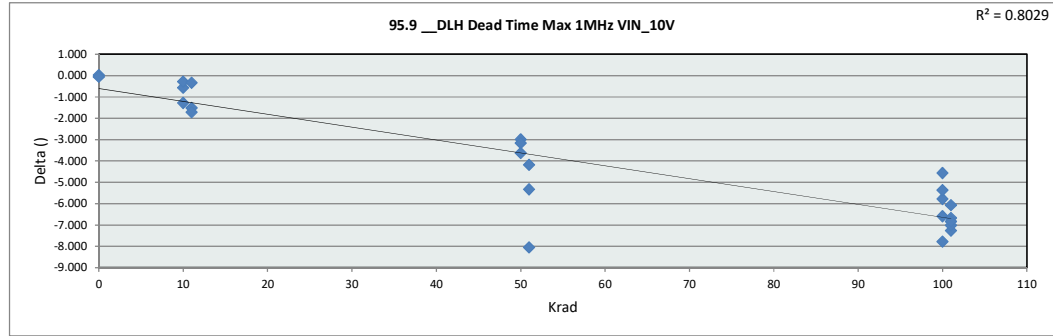

95.9 DLH Dead Time Max 1MHz	
Test Site	DAL
Tester	ETS364
Test Number	EB672303
Max Limit	113.5
Min Limit	74

	0	10	11	50	51	100	101
LL	74.000	74.000	74.000	74.000	74.000	74.000	74.000
Min	85.026	88.400	87.307	80.933	84.528	79.231	78.302
Average	87.022	89.287	88.249	84.832	85.852	82.815	81.607
Max	89.019	91.060	89.422	88.768	87.327	84.329	83.420
UL	113.500	113.500	113.500	113.500	113.500	113.500	113.500

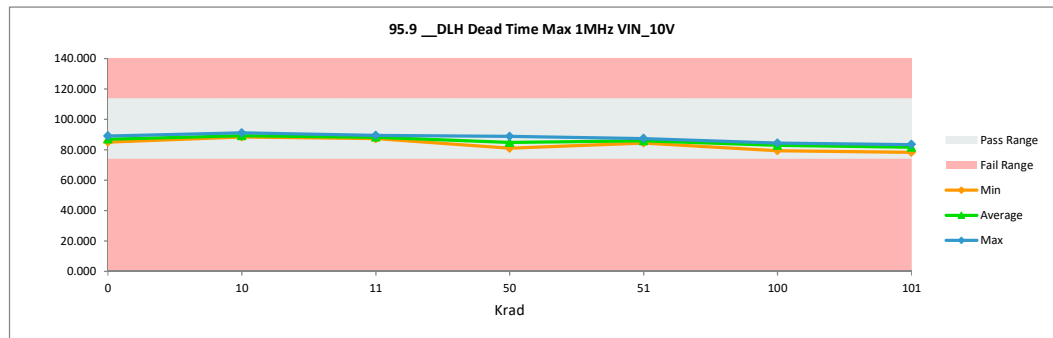

TID "HDR" Report
5962R2220102VXC

95.10_DLH Dead Time Min 2MH		
Test Site	DAL	DAL
Tester	ETS364	ETS364
Test Number	EB672303	EB672303
Unit		
Max Limit	10	10
Min Limit	0	0

Krad	Serial #	Pre_HDR_6013	Post_HDR_6013	Delta
0	1	4.311	4.192	-0.119
0	2	4.365	4.395	0.030
10	182	4.568	4.493	-0.075
10	202	4.024	3.904	-0.120
10	204	4.095	3.981	-0.114
11	418	4.492	4.520	0.029
11	419	4.156	4.344	0.187
11	443	3.628	4.859	1.231
50	259	4.679	4.942	0.264
50	346	4.015	3.978	-0.037
50	347	3.452	3.540	0.088
51	462	4.052	4.035	-0.017
51	478	4.310	3.878	-0.431
51	503	4.849	5.265	0.416
100	354	4.584	4.888	0.304
100	363	3.726	3.852	0.127
100	366	4.762	4.957	0.195
100	383	5.018	4.863	-0.156
100	417	3.652	4.540	0.888
101	513	4.596	4.659	0.063
101	526	4.455	4.674	0.218
101	532	4.318	4.938	0.620
101	533	3.791	4.310	0.519
101	534	4.685	5.114	0.429
	Max	5.018	5.265	1.231
	Average	4.274	4.463	0.189
	Min	3.452	3.540	-0.431
	Std Dev	0.421	0.466	0.363

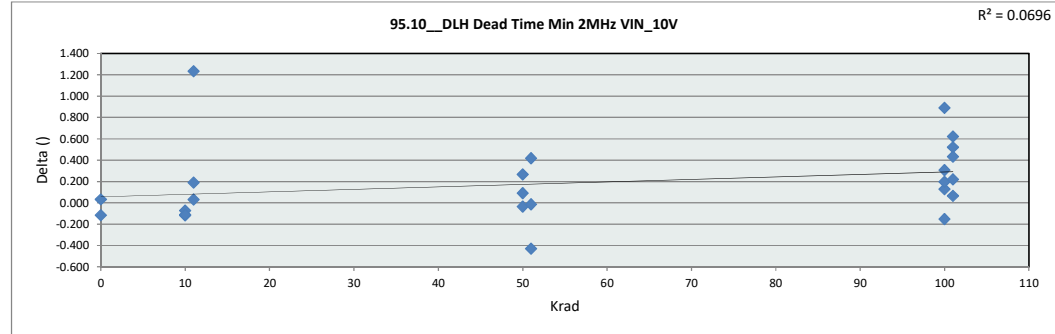

95.10_DLH Dead Time Min 2M	
Test Site	DAL
Tester	ETS364
Test Number	EB672303
Max Limit	10
Min Limit	0

Krad	0	10	11	50	51	100	101
LL	0.000	0.000	0.000	0.000	0.000	0.000	0.000
Min	4.192	3.904	4.344	3.540	3.879	3.853	4.310
Average	4.294	4.126	4.574	4.153	4.393	4.620	4.739
Max	4.395	4.493	4.859	4.942	5.265	4.957	5.114
UL	10.000	10.000	10.000	10.000	10.000	10.000	10.000

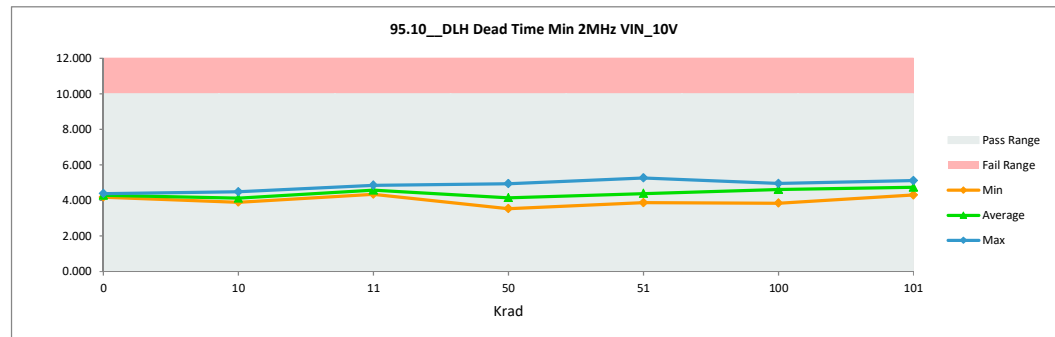

TID "HDR" Report
5962R2220102VXC

95.11_DLH Dead Time Small 2M		
Test Site	DAL	DAL
Tester	ETS364	ETS364
Test Number	EB672303	EB672303
Unit		
Max Limit	15.5	15.5
Min Limit	8	8

Krad	Serial #	Pre_HDR_6013	Post_HDR_6013	Delta
0	1	11.287	11.332	0.045
0	2	10.990	11.069	0.079
10	182	11.375	11.265	-0.110
10	202	11.160	10.719	-0.441
10	204	11.427	11.359	-0.067
11	418	11.636	11.251	-0.385
11	419	11.236	11.043	-0.193
11	443	10.807	11.670	0.863
50	259	11.195	11.091	-0.104
50	346	10.988	10.555	-0.433
50	347	10.838	10.417	-0.421
51	462	11.305	10.249	-1.056
51	478	11.416	10.748	-0.668
51	503	11.881	11.449	-0.432
100	354	11.616	11.101	-0.515
100	363	10.878	10.298	-0.579
100	366	11.521	10.656	-0.864
100	383	12.155	10.861	-1.294
100	417	10.736	10.433	-0.303
101	513	11.496	10.464	-1.031
101	526	11.413	10.703	-0.710
101	532	11.223	10.868	-0.356
101	533	10.748	10.306	-0.442
101	534	11.354	10.794	-0.561
Max		12.155	11.670	0.863
Average		11.278	10.863	-0.416
Min		10.736	10.249	-1.294
Std Dev		0.355	0.402	0.439

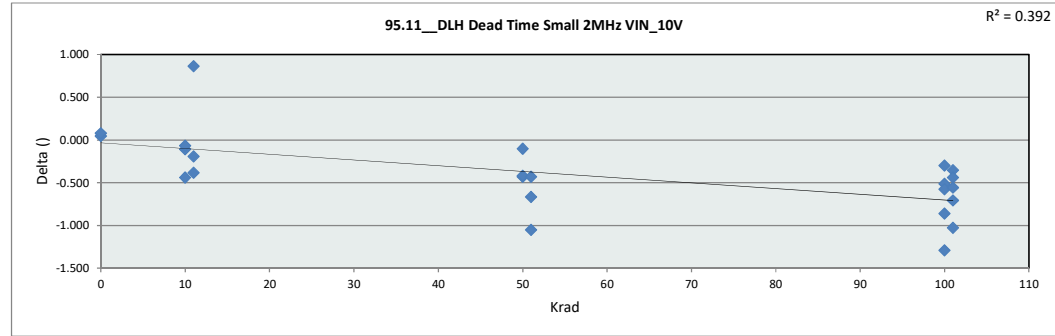

95.11_DLH Dead Time Small		
Test Site	DAL	
Tester	ETS364	
Test Number	EB672303	
Max Limit	15.5	
Min Limit	8	

Krad	0	10	11	50	51	100	101
LL	8.000	8.000	8.000	8.000	8.000	8.000	8.000
Min	11.069	10.719	11.043	10.417	10.249	10.298	10.306
Average	11.201	11.114	11.321	10.688	10.815	10.670	10.627
Max	11.332	11.359	11.670	11.091	11.449	11.101	10.868
UL	15.500	15.500	15.500	15.500	15.500	15.500	15.500

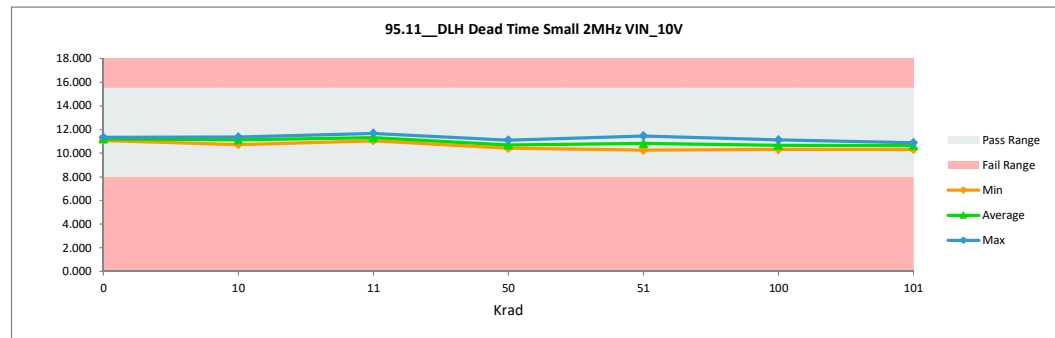

TID "HDR" Report
5962R2220102VXC

95.12_DLH Dead Time Mid 2MH		
Test Site	DAL	DAL
Tester	ETS364	ETS364
Test Number	EB672303	EB672303
Unit		
Max Limit	24	24
Min Limit	15.5	15.5

Krad	Serial #	Pre_HDR_6013	Post_HDR_6013	Delta
0	1	19.479	19.398	-0.081
0	2	18.766	18.811	0.045
10	182	19.474	19.409	-0.065
10	202	19.645	18.865	-0.780
10	204	20.045	19.623	-0.421
11	418	19.864	19.421	-0.443
11	419	19.359	19.239	-0.120
11	443	19.086	19.521	0.435
50	259	18.978	18.291	-0.687
50	346	18.978	18.599	-0.379
50	347	19.441	18.410	-1.031
51	462	19.654	18.179	-1.475
51	478	19.818	18.563	-1.255
51	503	19.727	19.152	-0.575
100	354	19.892	18.760	-1.132
100	363	19.345	17.941	-1.404
100	366	19.026	17.695	-1.330
100	383	20.442	18.424	-2.018
100	417	19.208	17.950	-1.258
101	513	19.561	17.901	-1.660
101	526	19.830	18.390	-1.440
101	532	19.550	18.275	-1.275
101	533	19.210	17.788	-1.422
101	534	18.898	17.731	-1.167
Max		20.442	19.623	0.435
Average		19.470	18.597	-0.872
Min		18.766	17.695	-2.018
Std Dev		0.408	0.618	0.633

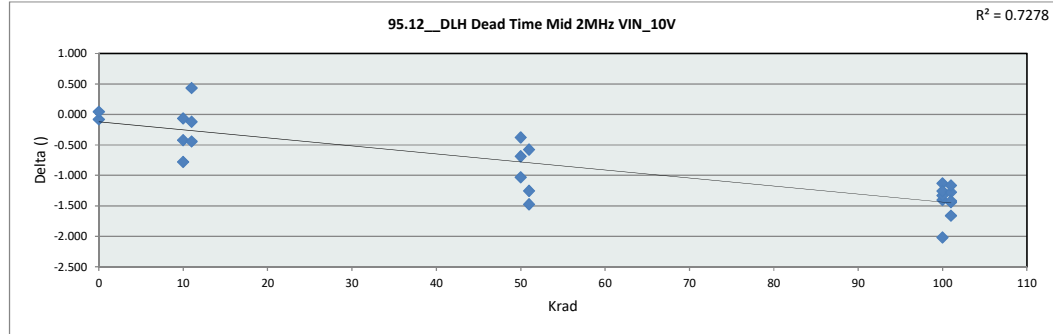

95.12_DLH Dead Time Mid 2M	
Test Site	DAL
Tester	ETS364
Test Number	EB672303
Max Limit	24
Min Limit	15.5

Krad	0	10	11	50	51	100	101
LL	15.500	15.500	15.500	15.500	15.500	15.500	15.500
Min	18.811	18.865	19.239	18.291	18.179	17.695	17.731
Average	19.105	19.299	19.394	18.434	18.631	18.154	18.017
Max	19.398	19.623	19.521	18.599	19.152	18.760	18.390
UL	24.000	24.000	24.000	24.000	24.000	24.000	24.000

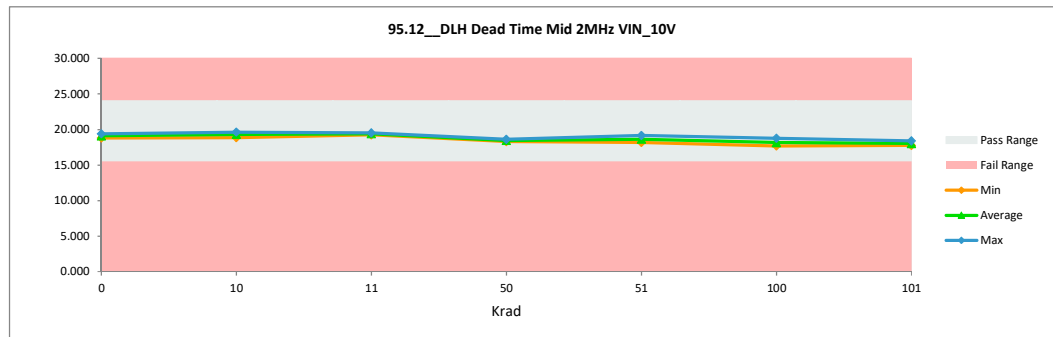

TID "HDR" Report
5962R2220102VXC

95.13 DLH Dead Time Large 2M		
Test Site	DAL	DAL
Tester	ETS364	ETS364
Test Number	EB672303	EB672303
Unit		
Max Limit	59	59
Min Limit	36	36

Krad	Serial #	Pre_HDR_6013	Post_HDR_6013	Delta
0	1	46.152	46.191	0.039
0	2	44.446	44.160	-0.287
10	182	46.347	46.033	-0.314
10	202	46.772	45.958	-0.813
10	204	47.306	46.998	-0.308
11	418	46.780	45.839	-0.941
11	419	46.579	46.216	-0.363
11	443	46.312	45.702	-0.610
50	259	44.239	42.790	-1.449
50	346	45.747	43.924	-1.823
50	347	47.266	45.299	-1.966
51	462	47.513	43.756	-3.757
51	478	47.765	45.112	-2.652
51	503	46.719	44.713	-2.007
100	354	46.932	43.803	-3.129
100	363	46.523	43.411	-3.112
100	366	44.339	41.846	-2.493
100	383	47.213	43.409	-3.804
100	417	46.023	43.699	-2.324
101	513	46.196	42.813	-3.383
101	526	46.923	43.495	-3.429
101	532	46.080	42.931	-3.149
101	533	46.390	43.000	-3.390
101	534	44.011	41.540	-2.471
Max		47.765	46.998	0.039
Average		46.274	44.277	-1.997
Min		44.011	41.540	-3.804
Std Dev		1.046	1.495	1.274

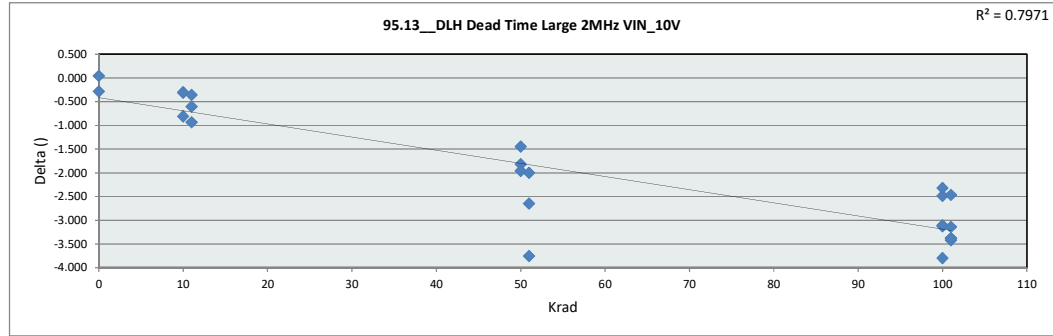

95.13 DLH Dead Time Large	
Test Site	DAL
Tester	ETS364
Test Number	EB672303
Max Limit	59
Min Limit	36

Krad	0	10	11	50	51	100	101
LL	36.000	36.000	36.000	36.000	36.000	36.000	36.000
Min	44.160	45.959	45.702	42.790	43.756	41.846	41.540
Average	45.175	46.330	45.919	44.005	44.527	43.234	42.756
Max	46.191	46.998	46.216	45.300	45.113	43.803	43.495
UL	59.000	59.000	59.000	59.000	59.000	59.000	59.000

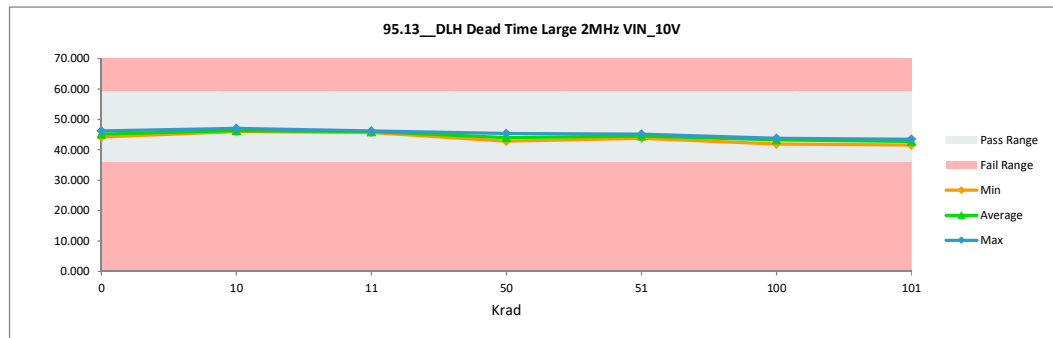

TID "HDR" Report
5962R2220102VXC

95.14_DLH Dead Time Max 2MHz		
Test Site	DAL	DAL
Tester	ETS364	ETS364
Test Number	EB672303	EB672303
Unit		
Max Limit	113.5	113.5
Min Limit	74	74

Krad	Serial #	Pre_HDR_6013	Post_HDR_6013	Delta
0	1	89.773	89.703	-0.070
0	2	85.602	85.510	-0.092
10	182	90.019	89.427	-0.592
10	202	90.473	89.473	-0.999
10	204	92.031	91.661	-0.369
11	418	90.317	88.813	-1.503
11	419	90.714	90.355	-0.359
11	443	90.082	87.813	-2.269
50	259	84.481	81.567	-2.914
50	346	88.582	85.196	-3.386
50	347	93.273	89.628	-3.645
51	462	93.549	85.211	-8.338
51	478	93.608	88.092	-5.517
51	503	90.565	86.330	-4.235
100	354	91.446	84.737	-6.709
100	363	90.426	84.790	-5.636
100	366	85.238	79.765	-5.473
100	383	91.268	83.193	-8.075
100	417	89.782	85.104	-4.678
101	513	90.160	82.596	-7.564
101	526	90.205	83.545	-6.660
101	532	89.427	82.292	-7.135
101	533	91.081	84.153	-6.928
101	534	84.860	78.982	-5.878
Max		93.608	91.661	-0.070
Average		89.873	85.747	-4.126
Min		84.481	78.982	-8.338
Std Dev		2.534	3.437	2.801

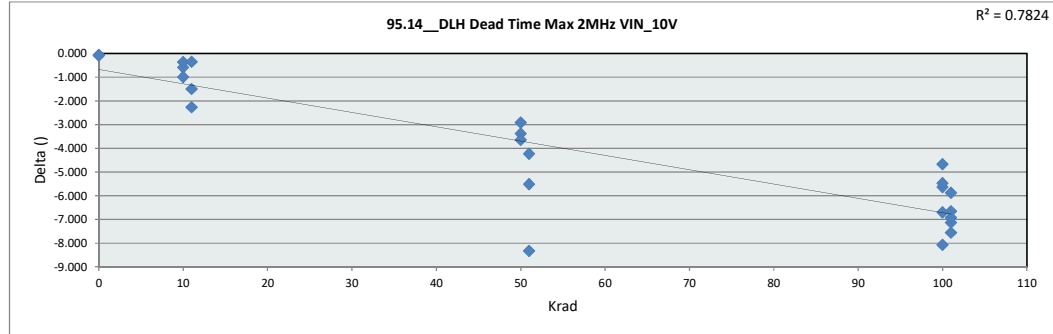

95.14_DLH Dead Time Max 2MHz	
Test Site	DAL
Tester	ETS364
Test Number	EB672303
Max Limit	113.5
Min Limit	74

Krad	0	10	11	50	51	100	101
LL	74.000	74.000	74.000	74.000	74.000	74.000	74.000
Min	85.510	89.427	87.814	81.567	85.211	79.765	78.982
Average	87.607	90.187	88.994	85.464	86.544	83.518	82.314
Max	89.703	91.662	90.355	89.628	88.092	85.104	84.153
UL	113.500	113.500	113.500	113.500	113.500	113.500	113.500

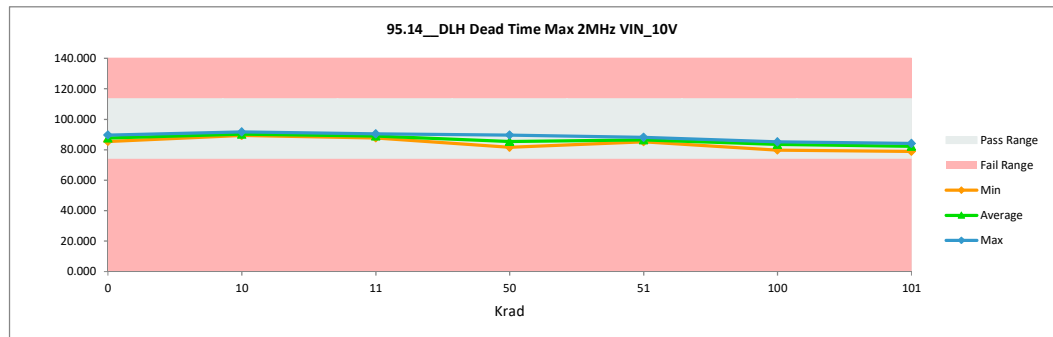

TID "HDR" Report
5962R2220102VXC

95.19 DHL Dead Time Min 500kHz		
Test Site	DAL	DAL
Tester	ETS364	ETS364
Test Number	EB672303	EB672303
Unit		
Max Limit	10	10
Min Limit	0	0

Krad	Serial #	Pre_HDR_6013	Post_HDR_6013	Delta
0	1	4.353	4.558	0.206
0	2	3.402	3.442	0.040
10	182	3.957	3.917	-0.041
10	202	4.390	4.430	0.040
10	204	3.877	4.859	0.983
11	418	3.450	4.544	1.095
11	419	3.767	4.469	0.701
11	443	3.590	4.073	0.483
50	259	4.680	4.704	0.024
50	346	5.115	5.642	0.527
50	347	4.382	4.498	0.116
51	462	3.978	4.386	0.408
51	478	3.313	4.322	1.009
51	503	4.216	4.212	-0.004
100	354	4.067	4.654	0.587
100	363	4.488	5.340	0.852
100	366	4.313	4.712	0.399
100	383	2.443	4.217	1.774
100	417	3.910	4.933	1.023
101	513	4.092	4.577	0.485
101	526	3.790	4.215	0.425
101	532	4.096	4.447	0.351
101	533	4.428	4.862	0.434
101	534	4.596	4.520	-0.076
Max		5.115	5.642	1.774
Average		4.029	4.522	0.493
Min		2.443	3.442	-0.076
Std Dev		0.548	0.443	0.453

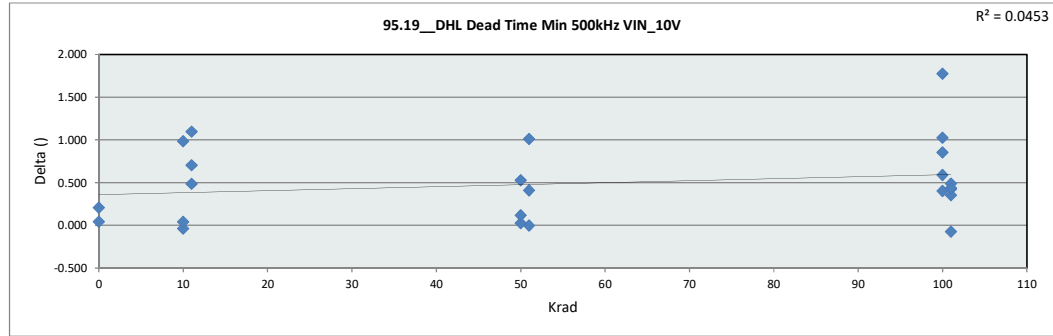

95.19 DHL Dead Time Min 50	
Test Site	DAL
Tester	ETS364
Test Number	EB672303
Max Limit	10
Min Limit	0

Krad	0	10	11	50	51	100	101
LL	0.000	0.000	0.000	0.000	0.000	0.000	0.000
Min	3.442	3.917	4.073	4.498	4.212	4.217	4.215
Average	4.000	4.402	4.362	4.948	4.306	4.771	4.524
Max	4.559	4.860	4.545	5.642	4.386	5.340	4.862
UL	10.000	10.000	10.000	10.000	10.000	10.000	10.000

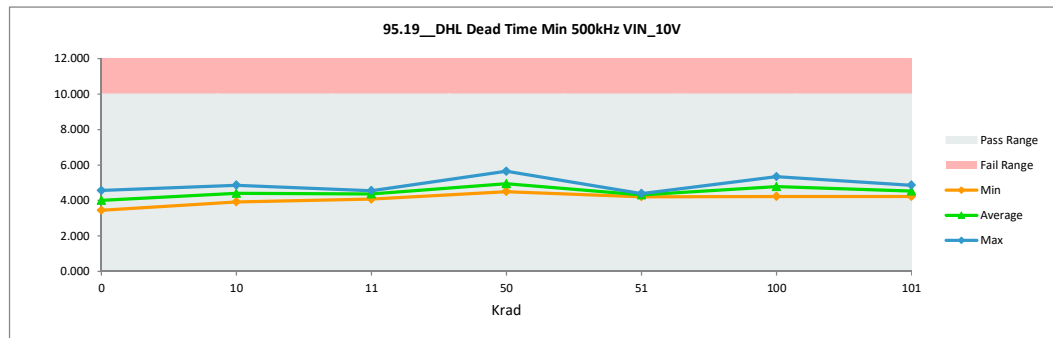

TID "HDR" Report
5962R2220102VXC

95.20 DHL Dead Time Small 50		
Test Site	DAL	DAL
Tester	ETS364	ETS364
Test Number	EB672303	EB672303
Unit		
Max Limit	15	15
Min Limit	6	6

Krad	Serial #	Pre_HDR_6013	Post_HDR_6013	Delta
0	1	10.018	10.052	0.034
0	2	9.255	9.381	0.126
10	182	9.451	9.446	-0.005
10	202	9.780	9.845	0.065
10	204	8.773	10.292	1.519
11	418	8.664	10.006	1.341
11	419	8.980	9.752	0.772
11	443	8.660	9.791	1.131
50	259	9.904	9.680	-0.224
50	346	10.391	10.667	0.276
50	347	9.957	9.908	-0.049
51	462	9.108	9.686	0.578
51	478	8.664	9.328	0.664
51	503	9.701	9.491	-0.210
100	354	9.567	9.486	-0.080
100	363	9.693	10.005	0.311
100	366	9.908	9.849	-0.058
100	383	7.680	9.488	1.808
100	417	9.176	9.629	0.453
101	513	9.509	9.719	0.210
101	526	9.457	9.352	-0.105
101	532	9.678	9.402	-0.276
101	533	9.955	9.810	-0.144
101	534	10.028	9.597	-0.432
Max		10.391	10.667	1.808
Average		9.415	9.736	0.321
Min		7.680	9.328	-0.432
Std Dev		0.613	0.319	0.604

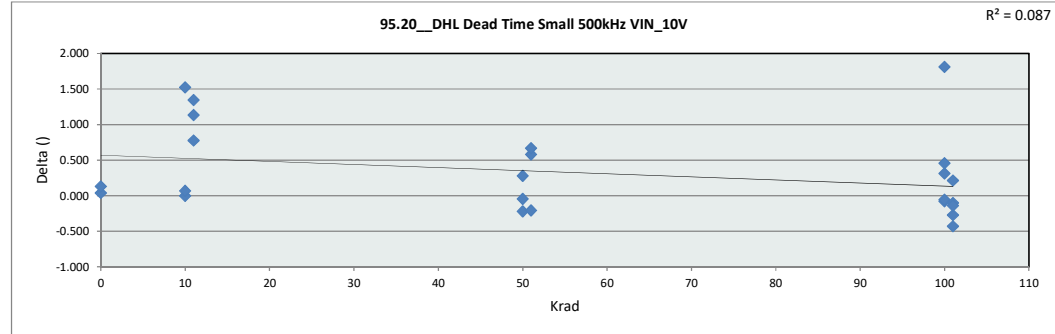

95.20 DHL Dead Time Small	
Test Site	DAL
Tester	ETS364
Test Number	EB672303
Max Limit	15
Min Limit	6

Krad	0	10	11	50	51	100	101
LL	6.000	6.000	6.000	6.000	6.000	6.000	6.000
Min	9.381	9.446	9.753	9.680	9.328	9.487	9.352
Average	9.716	9.861	9.850	10.085	9.502	9.692	9.576
Max	10.052	10.292	10.006	10.667	9.686	10.005	9.810
UL	15.000	15.000	15.000	15.000	15.000	15.000	15.000

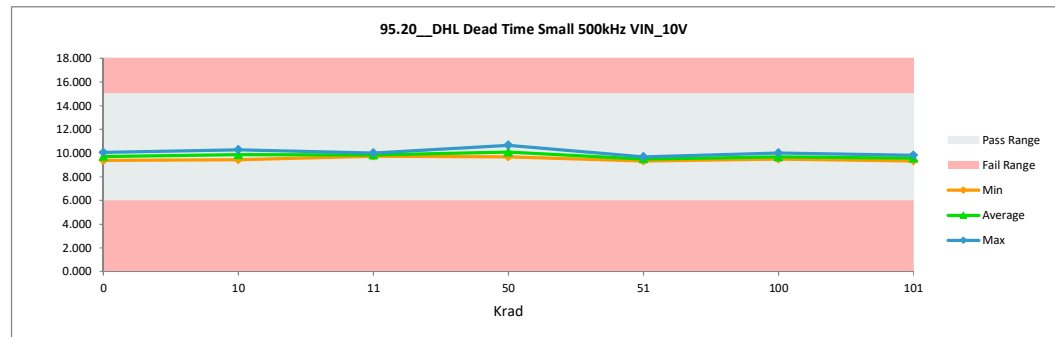

TID "HDR" Report
5962R2220102VXC

95.21 DHL Dead Time Mid 500k		
Test Site	DAL	DAL
Tester	ETS364	ETS364
Test Number	EB672303	EB672303
Unit		
Max Limit	24.5	24.5
Min Limit	16	16

Krad	Serial #	Pre_HDR_6013	Post_HDR_6013	Delta
0	1	19.999	20.078	0.079
0	2	19.507	19.737	0.229
10	182	19.548	19.530	-0.018
10	202	19.885	19.883	-0.002
10	204	18.490	20.219	1.729
11	418	17.942	19.781	1.838
11	419	18.549	19.468	0.919
11	443	18.273	20.036	1.763
50	259	19.453	18.904	-0.550
50	346	20.067	19.983	-0.084
50	347	20.176	19.520	-0.656
51	462	18.396	19.584	1.188
51	478	18.160	18.850	0.690
51	503	19.901	19.178	-0.723
100	354	19.645	19.102	-0.543
100	363	19.145	18.658	-0.487
100	366	20.178	19.471	-0.707
100	383	16.916	19.042	2.126
100	417	18.538	18.868	0.330
101	513	19.575	18.946	-0.629
101	526	19.681	18.877	-0.803
101	532	19.651	18.657	-0.994
101	533	20.118	19.404	-0.714
101	534	19.968	19.054	-0.913
Max		20.178	20.219	2.126
Average		19.240	19.368	0.128
Min		16.916	18.657	-0.994
Std Dev		0.871	0.476	0.982

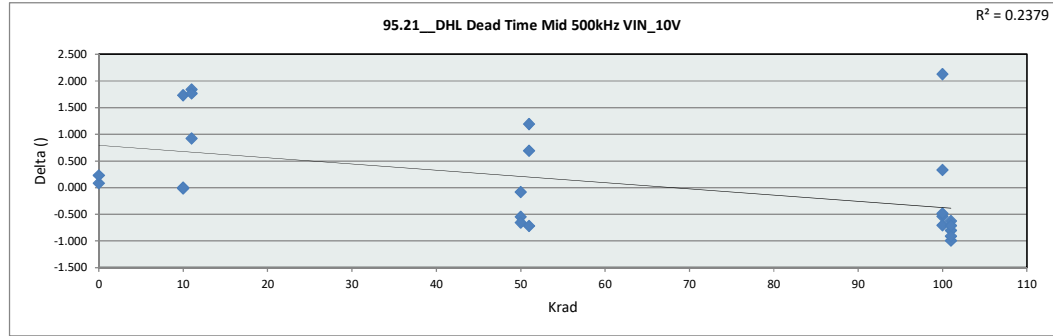

95.21 DHL Dead Time Mid 50	
Test Site	DAL
Tester	ETS364
Test Number	EB672303
Max Limit	24.5
Min Limit	16

Krad	0	10	11	50	51	100	101
LL	16.000	16.000	16.000	16.000	16.000	16.000	16.000
Min	19.737	19.530	19.468	18.904	18.850	18.658	18.658
Average	19.908	19.877	19.762	19.469	19.204	19.028	18.988
Max	20.078	20.219	20.036	19.984	19.585	19.471	19.404
UL	24.500	24.500	24.500	24.500	24.500	24.500	24.500

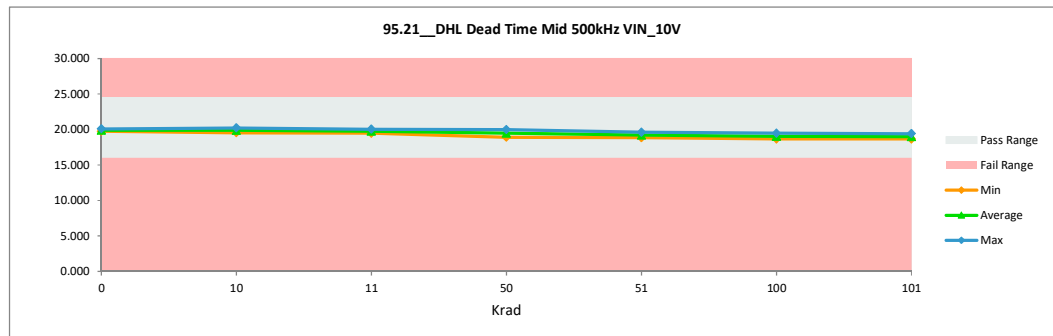

TID "HDR" Report
5962R2220102VXC

95.22 DHL Dead Time Large 50		
Test Site	DAL	DAL
Tester	ETS364	ETS364
Test Number	EB672303	EB672303
Unit		
Max Limit	61	61
Min Limit	44	44

Krad	Serial #	Pre_HDR_6013	Post_HDR_6013	Delta
0	1	50.429	50.505	0.075
0	2	51.447	51.676	0.229
10	182	50.162	50.247	0.085
10	202	50.654	50.326	-0.328
10	204	47.498	50.022	2.525
11	418	46.832	50.209	3.377
11	419	47.383	48.981	1.598
11	443	46.976	51.305	4.329
50	259	48.750	46.579	-2.172
50	346	49.842	48.275	-1.567
50	347	50.904	49.314	-1.590
51	462	46.963	49.693	2.729
51	478	47.063	47.462	0.400
51	503	51.244	49.391	-1.853
100	354	50.295	47.458	-2.836
100	363	48.381	44.890	-3.491
100	366	51.685	48.469	-3.216
100	383	45.364	48.135	2.770
100	417	47.306	46.394	-0.912
101	513	50.088	47.299	-2.788
101	526	50.998	47.894	-3.104
101	532	50.567	47.144	-3.424
101	533	50.837	48.251	-2.586
101	534	50.810	47.442	-3.368
Max		51.685	51.676	4.329
Average		49.270	48.640	-0.630
Min		45.364	44.890	-3.491
Std Dev		1.877	1.676	2.438

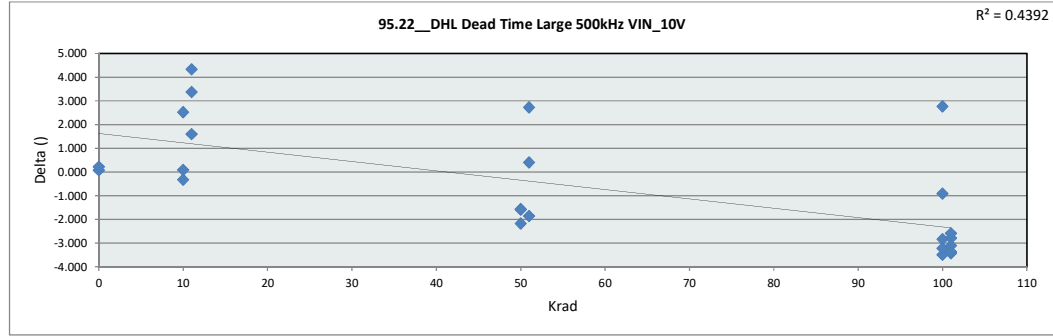

95.22 DHL Dead Time Large	
Test Site	DAL
Tester	ETS364
Test Number	EB672303
Max Limit	61
Min Limit	44

Krad	0	10	11	50	51	100	101
LL	44.000	44.000	44.000	44.000	44.000	44.000	44.000
Min	50.505	50.022	48.981	46.579	47.462	44.890	47.144
Average	51.090	50.199	50.165	48.056	48.849	47.069	47.606
Max	51.676	50.326	51.305	49.314	49.693	48.469	48.251
UL	61.000	61.000	61.000	61.000	61.000	61.000	61.000

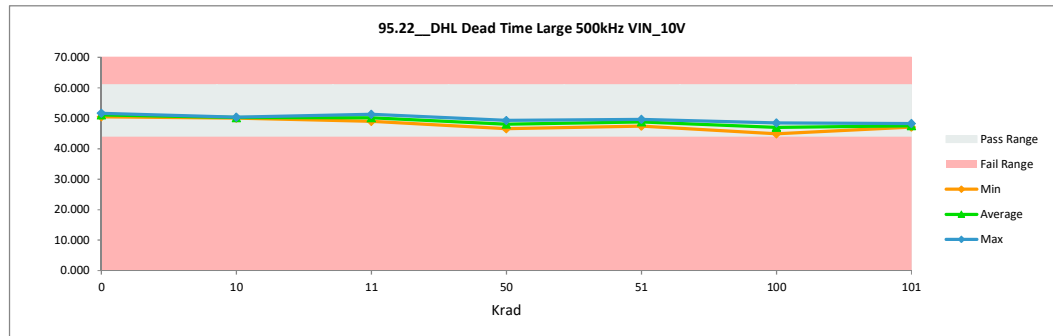

TID "HDR" Report
5962R2220102VXC

95.23 DHL Dead Time Max 500		
Test Site	DAL	DAL
Tester	ETS364	ETS364
Test Number	EB672303	EB672303
Unit		
Max Limit	125	125
Min Limit	86	86

Krad	Serial #	Pre_HDR_6013	Post_HDR_6013	Delta
0	1	98.473	98.727	0.254
0	2	102.414	102.389	-0.025
10	182	99.160	98.554	-0.606
10	202	99.140	98.212	-0.927
10	204	93.773	97.078	3.305
11	418	92.242	98.382	6.140
11	419	92.942	96.142	3.200
11	443	92.058	100.448	8.389
50	259	94.944	90.399	-4.545
50	346	96.812	93.130	-3.682
50	347	99.884	95.928	-3.956
51	462	91.558	97.306	5.749
51	478	92.692	92.866	0.174
51	503	100.755	97.009	-3.745
100	354	98.957	92.219	-6.739
100	363	94.235	86.112	-8.123
100	366	101.539	94.036	-7.504
100	383	89.805	93.384	3.578
100	417	92.598	90.485	-2.113
101	513	97.937	91.493	-6.445
101	526	100.788	93.557	-7.231
101	532	99.547	92.284	-7.263
101	533	99.874	93.642	-6.231
101	534	99.364	92.310	-7.053
Max		102.414	102.389	8.389
Average		96.729	94.837	-1.892
Min		89.805	86.112	-8.123
Std Dev		3.768	3.721	4.942

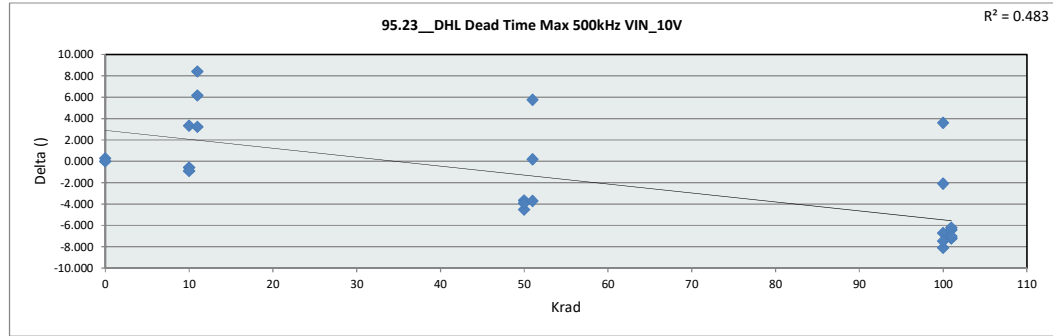

95.23 DHL Dead Time Max 500	
Test Site	DAL
Tester	ETS364
Test Number	EB672303
Max Limit	125
Min Limit	86

Krad	0	10	11	50	51	100	101
LL	86.000	86.000	86.000	86.000	86.000	86.000	86.000
Min	98.727	97.078	96.142	90.399	92.866	86.112	91.493
Average	100.558	97.948	98.324	93.152	95.727	91.247	92.657
Max	102.389	98.554	100.448	95.928	97.306	94.036	93.642
UL	125.000	125.000	125.000	125.000	125.000	125.000	125.000

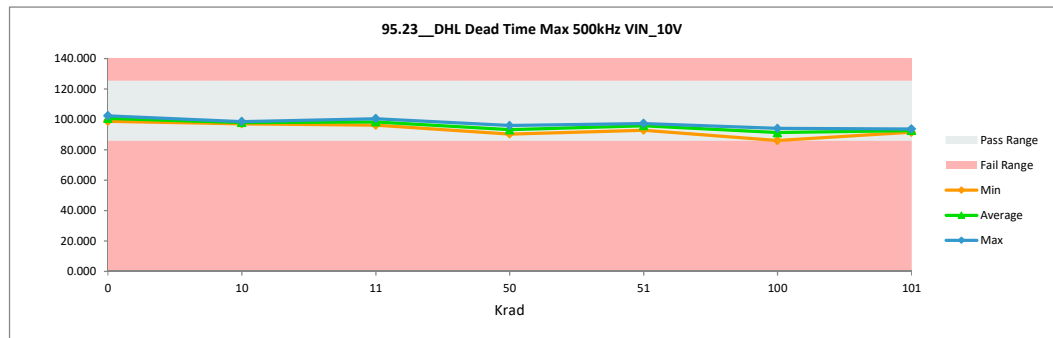

TID "HDR" Report
5962R2220102VXC

95.24 DHL Dead Time Min 1MH		
Test Site	DAL	DAL
Tester	ETS364	ETS364
Test Number	EB672303	EB672303
Unit		
Max Limit	10	10
Min Limit	0	0

Krad	Serial #	Pre_HDR_6013	Post_HDR_6013	Delta
0	1	4.580	4.619	0.039
0	2	3.703	3.775	0.072
10	182	4.066	4.249	0.183
10	202	4.467	4.673	0.206
10	204	3.955	5.089	1.133
11	418	3.811	4.750	0.940
11	419	4.078	4.737	0.659
11	443	3.876	4.371	0.495
50	259	4.831	4.846	0.015
50	346	5.422	5.773	0.350
50	347	4.780	4.788	0.008
51	462	4.386	4.555	0.169
51	478	3.599	4.359	0.760
51	503	4.472	4.286	-0.186
100	354	4.266	4.789	0.523
100	363	4.798	5.436	0.637
100	366	4.601	4.949	0.348
100	383	2.718	4.686	1.968
100	417	4.098	5.179	1.081
101	513	4.195	4.894	0.699
101	526	3.892	4.482	0.590
101	532	4.389	4.625	0.236
101	533	4.442	4.966	0.524
101	534	4.701	4.669	-0.032
Max		5.422	5.773	1.968
Average		4.255	4.731	0.476
Min		2.718	3.775	-0.186
Std Dev		0.536	0.406	0.479

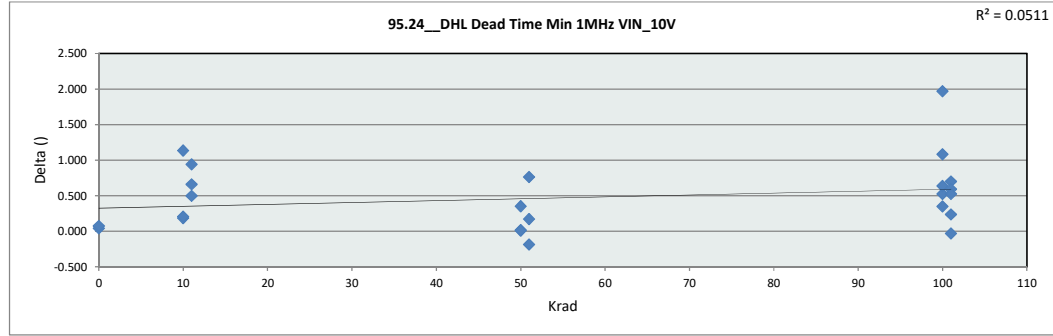

95.24 DHL Dead Time Min 1M	
Test Site	DAL
Tester	ETS364
Test Number	EB672303
Max Limit	10
Min Limit	0

Krad	0	10	11	50	51	100	101
LL	0.000	0.000	0.000	0.000	0.000	0.000	0.000
Min	3.775	4.249	4.371	4.788	4.286	4.686	4.482
Average	4.197	4.670	4.620	5.136	4.400	5.008	4.727
Max	4.619	5.089	4.750	5.773	4.555	5.436	4.966
UL	10.000	10.000	10.000	10.000	10.000	10.000	10.000

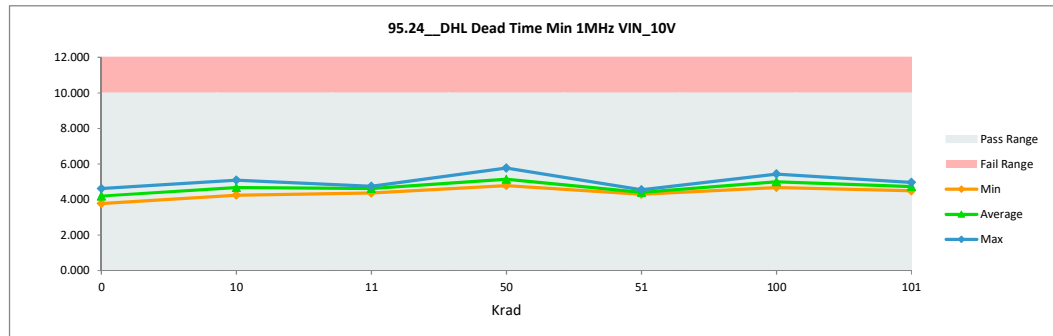

TID "HDR" Report
5962R2220102VXC

95.25 DHL Dead Time Small 1M		
Test Site	DAL	DAL
Tester	ETS364	ETS364
Test Number	EB672303	EB672303
Unit		
Max Limit	15	15
Min Limit	6	6

Krad	Serial #	Pre_HDR_6013	Post_HDR_6013	Delta
0	1	10.136	10.388	0.253
0	2	9.435	9.616	0.181
10	182	9.601	9.779	0.178
10	202	10.026	10.190	0.165
10	204	9.185	10.538	1.353
11	418	8.757	10.320	1.563
11	419	9.218	9.889	0.671
11	443	8.935	9.957	1.021
50	259	10.041	9.833	-0.207
50	346	10.666	10.794	0.128
50	347	10.167	10.006	-0.162
51	462	9.261	9.959	0.697
51	478	8.842	9.496	0.654
51	503	9.997	9.847	-0.150
100	354	9.874	9.863	-0.011
100	363	9.647	10.203	0.556
100	366	10.261	10.031	-0.230
100	383	7.881	9.766	1.884
100	417	9.325	9.904	0.579
101	513	9.878	9.870	-0.008
101	526	9.698	9.456	-0.242
101	532	9.894	9.604	-0.289
101	533	10.197	9.982	-0.215
101	534	10.233	9.786	-0.447
Max		10.666	10.794	1.884
Average		9.631	9.962	0.330
Min		7.881	9.456	-0.447
Std Dev		0.623	0.318	0.624

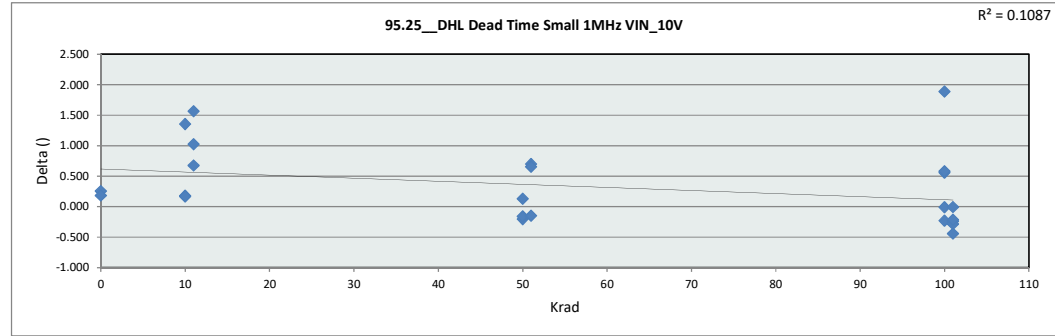

95.25 DHL Dead Time Small	
Test Site	DAL
Tester	ETS364
Test Number	EB672303
Max Limit	15
Min Limit	6

Krad	0	10	11	50	51	100	101
LL	6.000	6.000	6.000	6.000	6.000	6.000	6.000
Min	9.617	9.779	9.889	9.833	9.496	9.766	9.456
Average	10.002	10.169	10.055	10.211	9.767	9.953	9.740
Max	10.388	10.538	10.320	10.794	9.959	10.203	9.982
UL	15.000	15.000	15.000	15.000	15.000	15.000	15.000

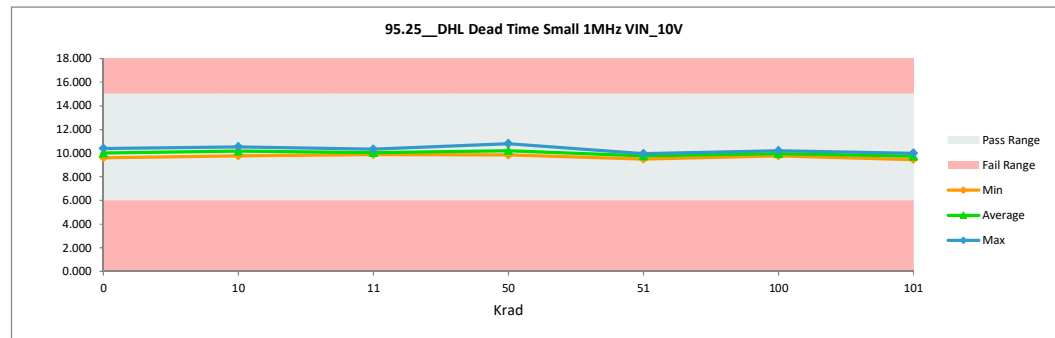

TID "HDR" Report
5962R2220102VXC

95.26 DHL Dead Time Mid 1MH		
Test Site	DAL	DAL
Tester	ETS364	ETS364
Test Number	EB672303	EB672303
Unit		
Max Limit	24.5	24.5
Min Limit	16	16

Krad	Serial #	Pre_HDR_6013	Post_HDR_6013	Delta
0	1	20.335	20.474	0.139
0	2	19.931	20.117	0.186
10	182	19.701	19.819	0.118
10	202	20.107	20.159	0.053
10	204	18.726	20.362	1.636
11	418	18.445	20.236	1.791
11	419	18.799	19.789	0.991
11	443	18.511	20.277	1.765
50	259	19.751	19.217	-0.534
50	346	20.450	20.222	-0.227
50	347	20.301	19.986	-0.315
51	462	18.842	19.743	0.902
51	478	18.370	19.042	0.672
51	503	20.226	19.674	-0.552
100	354	19.965	19.102	-0.863
100	363	19.547	18.968	-0.579
100	366	20.597	19.636	-0.961
100	383	17.405	19.315	1.911
100	417	18.933	19.140	0.208
101	513	19.836	19.316	-0.519
101	526	20.089	19.093	-0.995
101	532	20.092	19.011	-1.082
101	533	20.384	19.536	-0.848
101	534	20.304	19.066	-1.237
Max		20.597	20.474	1.911
Average		19.569	19.638	0.069
Min		17.405	18.968	-1.237
Std Dev		0.849	0.501	0.985

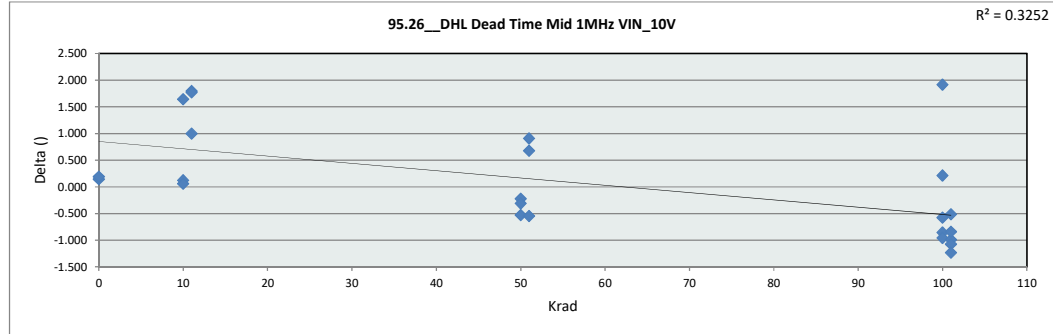

95.26 DHL Dead Time Mid 1M	
Test Site	DAL
Tester	ETS364
Test Number	EB672303
Max Limit	24.5
Min Limit	16

Krad	0	10	11	50	51	100	101
LL	16.000	16.000	16.000	16.000	16.000	16.000	16.000
Min	20.117	19.819	19.789	19.217	19.042	18.968	19.011
Average	20.295	20.113	20.101	19.809	19.486	19.232	19.205
Max	20.474	20.362	20.277	20.222	19.743	19.636	19.536
UL	24.500	24.500	24.500	24.500	24.500	24.500	24.500

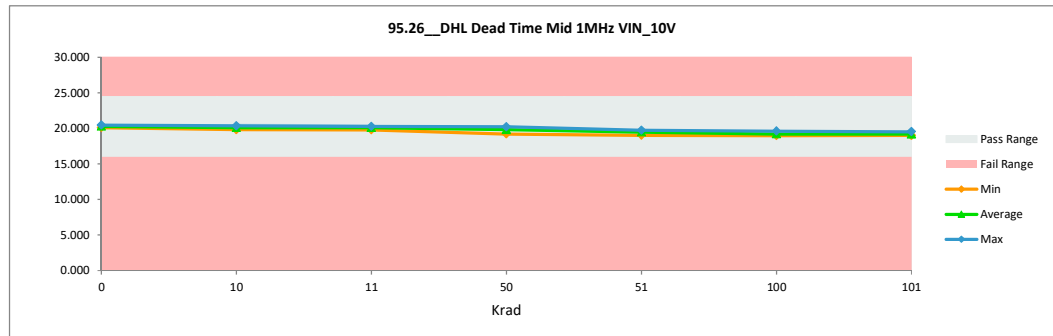

TID "HDR" Report
5962R2220102VXC

95.27 DHL Dead Time Large 1M		
Test Site	DAL	DAL
Tester	ETS364	ETS364
Test Number	EB672303	EB672303
Unit		
Max Limit	61	61
Min Limit	44	44

Krad	Serial #	Pre_HDR_6013	Post_HDR_6013	Delta
0	1	51.215	51.273	0.058
0	2	52.307	52.422	0.114
10	182	50.753	50.663	-0.090
10	202	50.988	50.715	-0.273
10	204	48.146	50.523	2.377
11	418	47.330	50.831	3.501
11	419	47.940	49.558	1.618
11	443	47.436	51.818	4.382
50	259	49.178	47.172	-2.006
50	346	50.236	48.842	-1.394
50	347	51.385	49.786	-1.599
51	462	47.424	50.166	2.742
51	478	47.723	47.853	0.130
51	503	51.720	49.728	-1.992
100	354	51.052	47.881	-3.171
100	363	48.829	45.227	-3.602
100	366	52.094	48.802	-3.292
100	383	45.890	48.548	2.658
100	417	47.938	46.931	-1.006
101	513	50.531	47.671	-2.860
101	526	51.690	48.443	-3.247
101	532	51.175	47.570	-3.605
101	533	51.520	48.565	-2.955
101	534	51.229	47.877	-3.352
Max		52.307	52.422	4.382
Average		49.822	49.119	-0.703
Min		45.890	45.227	-3.605
Std Dev		1.897	1.731	2.482

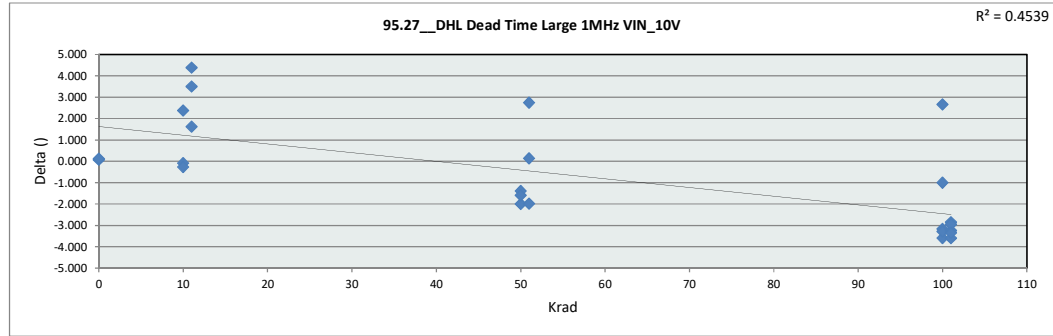

95.27 DHL Dead Time Large	
Test Site	DAL
Tester	ETS364
Test Number	EB672303
Max Limit	61
Min Limit	44

Krad	0	10	11	50	51	100	101
LL	44.000	44.000	44.000	44.000	44.000	44.000	44.000
Min	51.273	50.524	49.558	47.172	47.853	45.227	47.570
Average	51.847	50.634	50.735	48.600	49.249	47.478	48.025
Max	52.422	50.715	51.818	49.786	50.166	48.802	48.565
UL	61.000	61.000	61.000	61.000	61.000	61.000	61.000

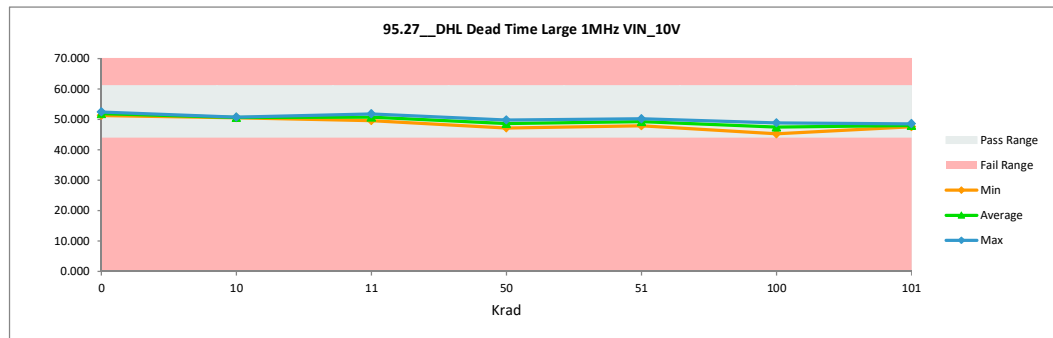

TID "HDR" Report
5962R2220102VXC

95.28 DHL Dead Time Max 1MHz		
Test Site	DAL	DAL
Tester	ETS364	ETS364
Test Number	EB672303	EB672303
Unit		
Max Limit	125	125
Min Limit	86	86

Krad	Serial #	Pre_HDR_6013	Post_HDR_6013	Delta
0	1	100.036	100.176	0.140
0	2	103.992	104.218	0.225
10	182	100.477	99.929	-0.548
10	202	100.301	99.582	-0.718
10	204	95.154	98.500	3.346
11	418	93.621	99.858	6.236
11	419	94.251	97.296	3.045
11	443	93.363	102.232	8.869
50	259	96.176	91.510	-4.666
50	346	98.202	94.284	-3.918
50	347	101.477	97.129	-4.349
51	462	92.983	98.438	5.455
51	478	94.114	93.978	-0.137
51	503	102.235	98.299	-3.935
100	354	100.411	93.038	-7.373
100	363	95.601	86.987	-8.614
100	366	102.912	95.039	-7.873
100	383	91.139	94.556	3.417
100	417	94.041	91.588	-2.453
101	513	99.157	92.496	-6.661
101	526	102.107	94.600	-7.507
101	532	100.933	93.406	-7.527
101	533	101.346	94.660	-6.686
101	534	100.794	93.224	-7.570
Max		103.992	104.218	8.869
Average		98.118	96.043	-2.075
Min		91.139	86.987	-8.614
Std Dev		3.799	3.943	5.127

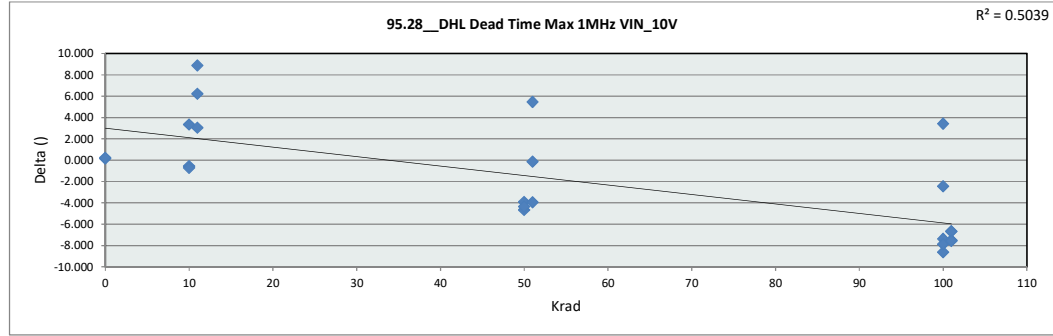

95.28 DHL Dead Time Max 1MHz	
Test Site	DAL
Tester	ETS364
Test Number	EB672303
Max Limit	125
Min Limit	86

Krad	0	10	11	50	51	100	101
LL	86.000	86.000	86.000	86.000	86.000	86.000	86.000
Min	100.176	98.500	97.296	91.511	93.978	86.987	92.496
Average	102.197	99.337	99.795	94.308	96.905	92.242	93.677
Max	104.218	99.929	102.232	97.129	98.438	95.039	94.660
UL	125.000	125.000	125.000	125.000	125.000	125.000	125.000

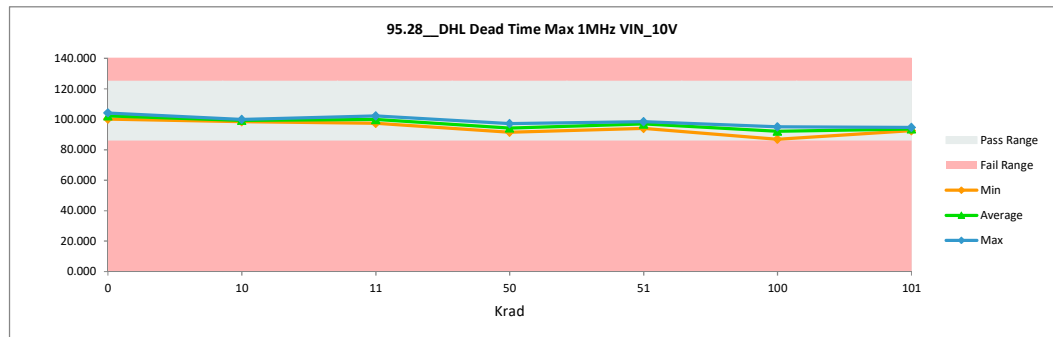

TID "HDR" Report
5962R2220102VXC

95.29 DHL Dead Time Min 2MH		
Test Site	DAL	DAL
Tester	ETS364	ETS364
Test Number	EB672303	EB672303
Unit		
Max Limit	10	10
Min Limit	0	0

Krad	Serial #	Pre_HDR_6013	Post_HDR_6013	Delta
0	1	4.799	4.989	0.190
0	2	4.079	4.052	-0.027
10	182	4.203	4.539	0.335
10	202	4.744	5.047	0.303
10	204	4.130	5.296	1.166
11	418	4.042	4.953	0.911
11	419	4.464	4.881	0.417
11	443	4.043	4.517	0.474
50	259	4.988	5.150	0.161
50	346	5.723	6.013	0.289
50	347	4.679	4.787	0.108
51	462	4.537	4.910	0.373
51	478	3.928	4.654	0.726
51	503	4.586	4.525	-0.061
100	354	4.436	4.926	0.490
100	363	5.054	5.644	0.590
100	366	4.668	5.028	0.359
100	383	3.172	4.803	1.631
100	417	4.608	5.114	0.506
101	513	4.723	5.251	0.528
101	526	4.043	4.470	0.427
101	532	4.439	4.779	0.339
101	533	4.615	5.138	0.524
101	534	5.161	4.775	-0.386
Max		5.723	6.013	1.631
Average		4.494	4.927	0.432
Min		3.172	4.052	-0.386
Std Dev		0.507	0.401	0.405

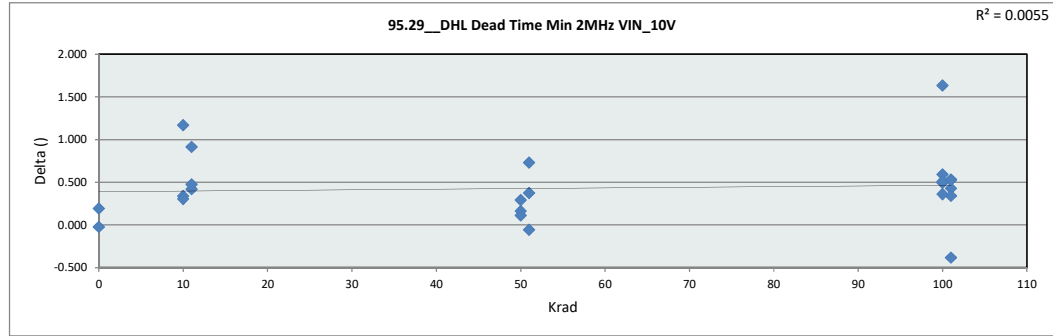

95.29 DHL Dead Time Min 2M	
Test Site	DAL
Tester	ETS364
Test Number	EB672303
Max Limit	10
Min Limit	0

Krad	0	10	11	50	51	100	101
LL	0.000	0.000	0.000	0.000	0.000	0.000	0.000
Min	4.052	4.539	4.517	4.787	4.525	4.803	4.470
Average	4.521	4.961	4.784	5.316	4.696	5.103	4.883
Max	4.989	5.296	4.954	6.013	4.910	5.644	5.251
UL	10.000	10.000	10.000	10.000	10.000	10.000	10.000

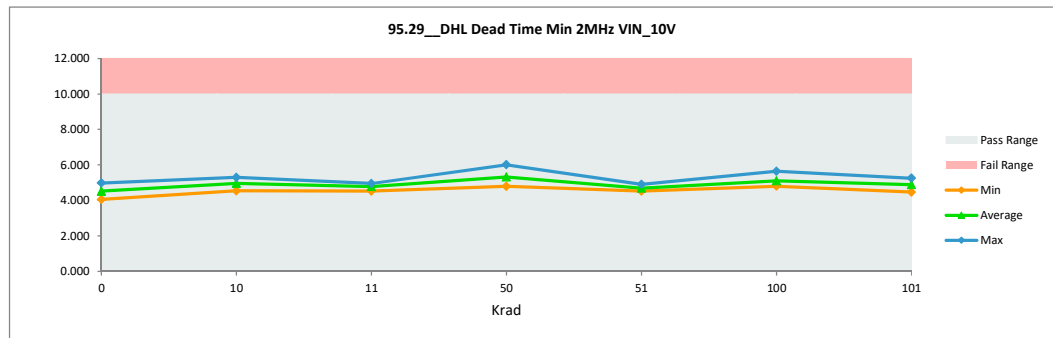

TID "HDR" Report
5962R2220102VXC

95.30 DHL Dead Time Small 2M		
Test Site	DAL	DAL
Tester	ETS364	ETS364
Test Number	EB672303	EB672303
Unit		
Max Limit	15	15
Min Limit	6	6

Krad	Serial #	Pre_HDR_6013	Post_HDR_6013	Delta
0	1	10.277	10.480	0.204
0	2	9.595	9.776	0.181
10	182	9.761	9.998	0.238
10	202	10.183	10.410	0.227
10	204	9.428	10.677	1.249
11	418	8.938	10.356	1.418
11	419	9.450	10.130	0.679
11	443	9.066	10.129	1.064
50	259	10.131	9.985	-0.146
50	346	10.738	11.079	0.341
50	347	10.299	10.296	-0.003
51	462	9.333	10.114	0.781
51	478	8.941	9.437	0.495
51	503	10.093	9.814	-0.280
100	354	10.030	9.999	-0.031
100	363	10.115	10.243	0.128
100	366	10.367	10.075	-0.292
100	383	8.179	9.884	1.706
100	417	9.484	10.088	0.604
101	513	10.075	9.915	-0.160
101	526	9.794	9.620	-0.173
101	532	10.053	9.791	-0.262
101	533	10.330	10.025	-0.305
101	534	10.375	9.880	-0.496
	Max	10.738	11.079	1.706
	Average	9.793	10.092	0.299
	Min	8.179	9.437	-0.496
	Std Dev	0.597	0.348	0.594

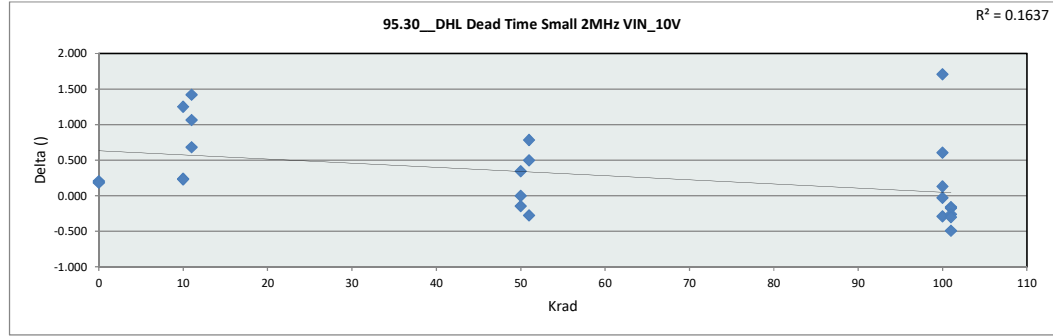

95.30 DHL Dead Time Small	
Test Site	DAL
Tester	ETS364
Test Number	EB672303
Max Limit	15
Min Limit	6

Krad	0	10	11	50	51	100	101
LL	6.000	6.000	6.000	6.000	6.000	6.000	6.000
Min	9.776	9.999	10.129	9.985	9.437	9.885	9.620
Average	10.128	10.362	10.205	10.454	9.788	10.058	9.846
Max	10.480	10.677	10.356	11.079	10.114	10.243	10.025
UL	15.000	15.000	15.000	15.000	15.000	15.000	15.000

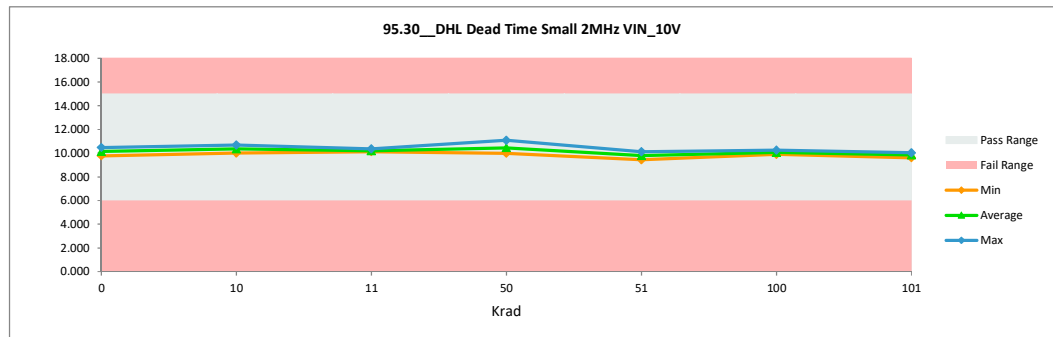

TID "HDR" Report
5962R2220102VXC

95.31 DHL Dead Time Mid 2MH		
Test Site	DAL	DAL
Tester	ETS364	ETS364
Test Number	EB672303	EB672303
Unit		
Max Limit	24.5	24.5
Min Limit	16	16

Krad	Serial #	Pre_HDR_6013	Post_HDR_6013	Delta
0	1	20.579	20.576	-0.003
0	2	20.093	20.052	-0.042
10	182	20.101	20.035	-0.066
10	202	20.366	20.231	-0.134
10	204	18.905	20.441	1.536
11	418	18.568	20.215	1.647
11	419	18.912	19.934	1.023
11	443	18.621	20.556	1.935
50	259	19.794	19.264	-0.530
50	346	20.392	20.321	-0.072
50	347	20.503	20.111	-0.392
51	462	18.987	20.007	1.020
51	478	18.581	19.218	0.637
51	503	20.510	19.676	-0.835
100	354	20.250	19.484	-0.765
100	363	19.701	18.992	-0.709
100	366	20.559	19.776	-0.783
100	383	17.504	19.597	2.093
100	417	18.966	19.243	0.276
101	513	20.002	19.308	-0.694
101	526	20.338	19.240	-1.098
101	532	20.375	19.131	-1.245
101	533	20.460	19.775	-0.684
101	534	20.413	19.392	-1.021
Max		20.579	20.576	2.093
Average		19.728	19.774	0.046
Min		17.504	18.992	-1.245
Std Dev		0.865	0.484	1.007

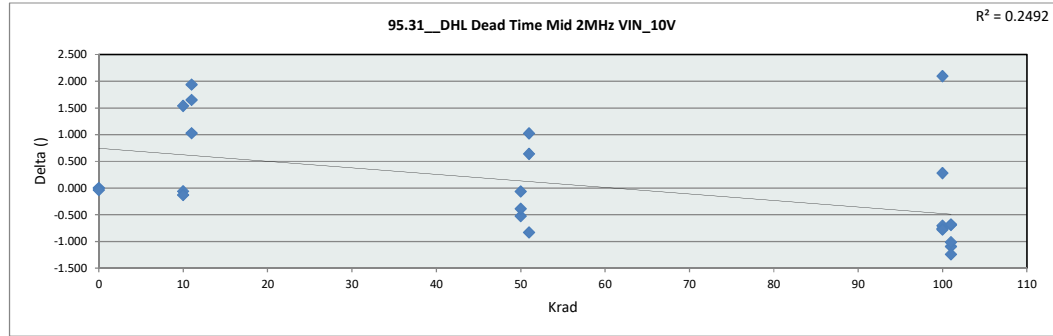

95.31 DHL Dead Time Mid 2M	
Test Site	DAL
Tester	ETS364
Test Number	EB672303
Max Limit	24.5
Min Limit	16

Krad	0	10	11	50	51	100	101
LL	16.000	16.000	16.000	16.000	16.000	16.000	16.000
Min	20.052	20.035	19.935	19.264	19.218	18.992	19.131
Average	20.314	20.236	20.235	19.899	19.633	19.418	19.369
Max	20.576	20.441	20.556	20.321	20.007	19.776	19.775
UL	24.500	24.500	24.500	24.500	24.500	24.500	24.500

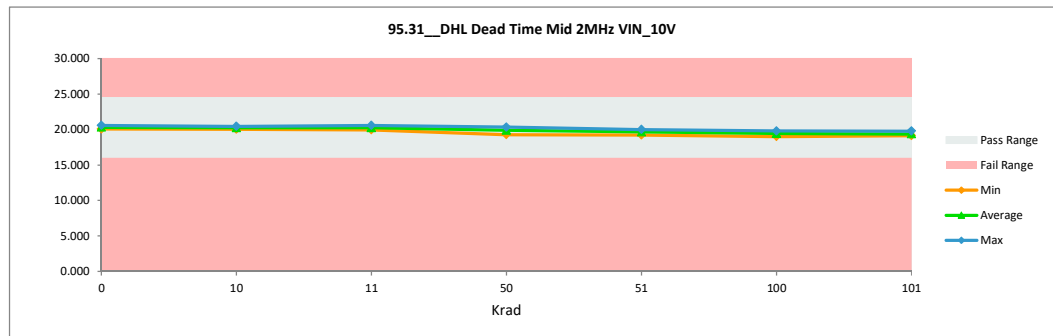

TID "HDR" Report
5962R2220102VXC

95.32 DHL Dead Time Large 2M		
Test Site	DAL	DAL
Tester	ETS364	ETS364
Test Number	EB672303	EB672303
Unit		
Max Limit	61	61
Min Limit	44	44

Krad	Serial #	Pre_HDR_6013	Post_HDR_6013	Delta
0	1	51.866	51.892	0.026
0	2	53.017	53.139	0.122
10	182	51.594	51.247	-0.346
10	202	51.722	51.286	-0.436
10	204	48.746	51.065	2.319
11	418	48.175	51.345	3.170
11	419	48.368	50.080	1.713
11	443	48.160	52.614	4.454
50	259	49.847	47.765	-2.082
50	346	50.881	49.277	-1.604
50	347	52.290	50.454	-1.836
51	462	48.044	50.759	2.715
51	478	48.305	48.619	0.314
51	503	52.502	50.593	-1.909
100	354	51.594	48.516	-3.077
100	363	49.475	45.801	-3.674
100	366	52.942	49.426	-3.515
100	383	46.526	49.290	2.764
100	417	48.396	47.481	-0.915
101	513	51.076	48.150	-2.926
101	526	52.410	48.964	-3.446
101	532	51.805	48.142	-3.663
101	533	52.066	49.241	-2.825
101	534	51.867	48.678	-3.189
	Max	53.017	53.139	4.454
	Average	50.486	49.743	-0.744
	Min	46.526	45.801	-3.674
	Std Dev	1.939	1.753	2.489

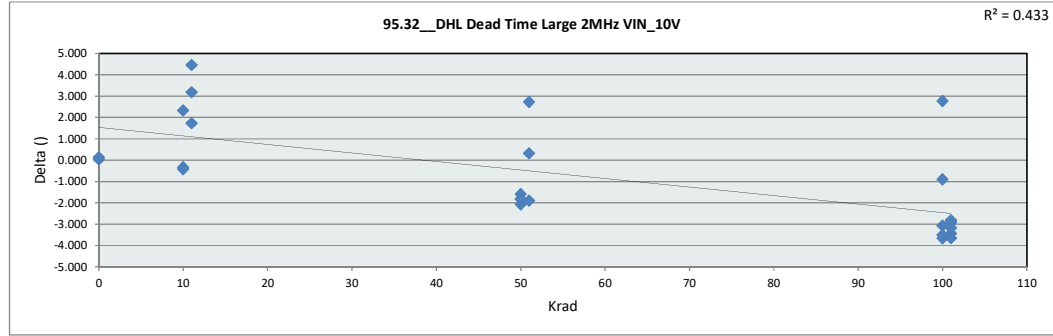

95.32 DHL Dead Time Large	
Test Site	DAL
Tester	ETS364
Test Number	EB672303
Max Limit	61
Min Limit	44

Krad	0	10	11	50	51	100	101
LL	44.000	44.000	44.000	44.000	44.000	44.000	44.000
Min	51.892	51.065	50.080	47.765	48.619	45.801	48.142
Average	52.515	51.200	51.346	49.165	49.990	48.103	48.635
Max	53.139	51.286	52.614	50.454	50.759	49.426	49.241
UL	61.000	61.000	61.000	61.000	61.000	61.000	61.000

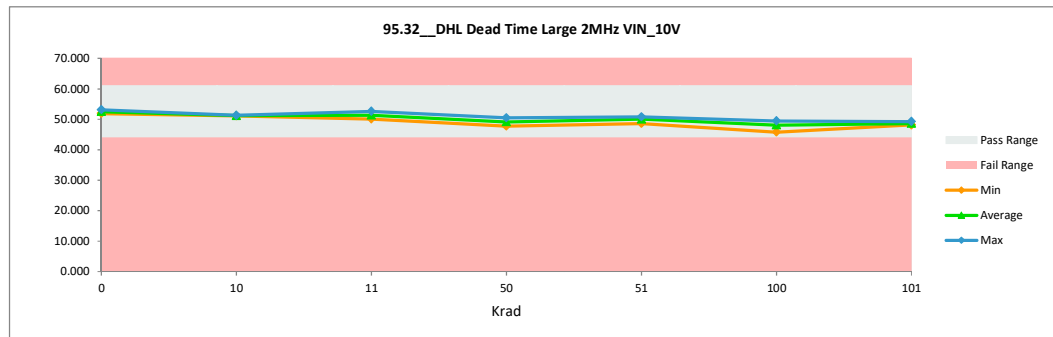

TID "HDR" Report
5962R2220102VXC

95.33 DHL Dead Time Max 2MHz		
Test Site	DAL	DAL
Tester	ETS364	ETS364
Test Number	EB672303	EB672303
Unit		
Max Limit	125	125
Min Limit	86	86

Krad	Serial #	Pre_HDR_6013	Post_HDR_6013	Delta
0	1	103.208	103.696	0.488
0	2	107.576	107.983	0.408
10	182	103.676	103.186	-0.490
10	202	103.512	102.739	-0.773
10	204	98.179	101.806	3.626
11	418	96.721	103.210	6.489
11	419	97.301	100.474	3.173
11	443	96.383	105.468	9.086
50	259	99.174	94.338	-4.836
50	346	101.207	97.034	-4.173
50	347	104.426	100.078	-4.348
51	462	95.814	101.606	5.792
51	478	97.367	96.848	-0.519
51	503	105.578	101.436	-4.143
100	354	103.588	96.091	-7.497
100	363	98.580	89.503	-9.077
100	366	106.097	98.162	-7.935
100	383	94.123	97.641	3.518
100	417	96.926	94.391	-2.535
101	513	102.424	95.491	-6.933
101	526	105.463	97.520	-7.943
101	532	104.178	96.499	-7.679
101	533	104.543	97.766	-6.777
101	534	104.138	96.512	-7.626
Max		107.576	107.983	9.086
Average		101.258	99.145	-2.113
Min		94.123	89.503	-9.077
Std Dev		3.925	4.162	5.305

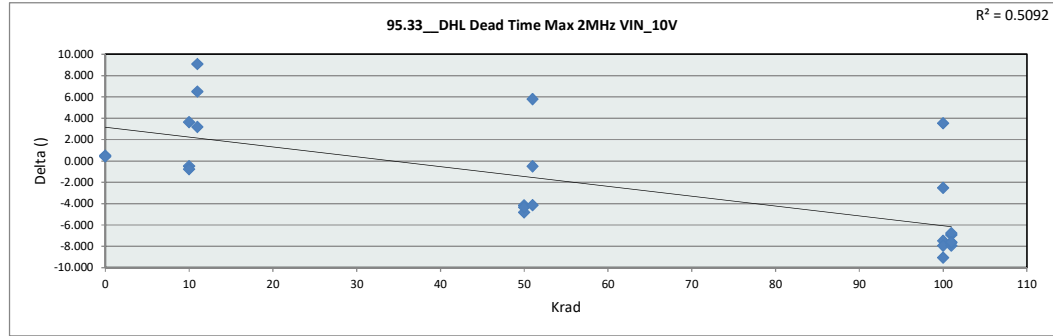

95.33 DHL Dead Time Max 2MHz	
Test Site	DAL
Tester	ETS364
Test Number	EB672303
Max Limit	125
Min Limit	86

Krad	0	10	11	50	51	100	101
LL	86.000	86.000	86.000	86.000	86.000	86.000	86.000
Min	103.696	101.806	100.474	94.338	96.848	89.503	95.491
Average	105.840	102.577	103.051	97.150	99.963	95.158	96.758
Max	107.983	103.186	105.468	100.078	101.606	98.162	97.766
UL	125.000	125.000	125.000	125.000	125.000	125.000	125.000

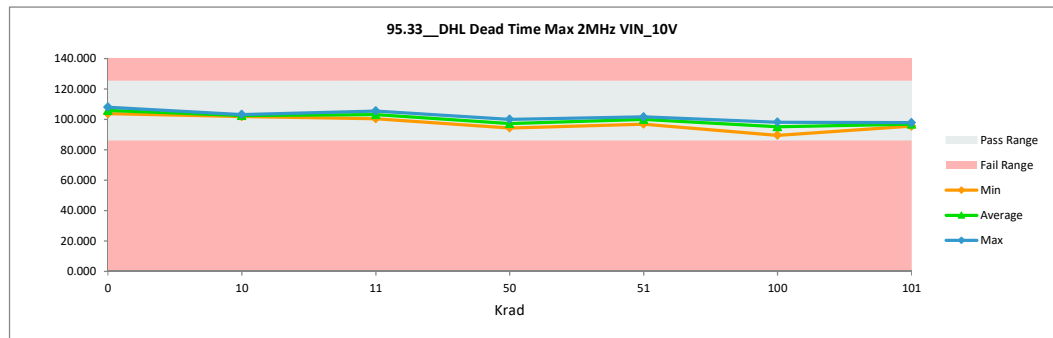

TID "HDR" Report
5962R2220102VXC

96.0 DLH Dead Time Min 500k		
Test Site	DAL	DAL
Tester	ETS364	ETS364
Test Number	EB672303	EB672303
Unit		
Max Limit	10	10
Min Limit	0	0

Krad	Serial #	Pre_HDR_6013	Post_HDR_6013	Delta
0	1	4.131	3.853	-0.279
0	2	4.266	4.165	-0.101
10	182	4.098	4.245	0.147
10	202	3.756	3.511	-0.244
10	204	3.959	3.900	-0.059
11	418	4.472	4.191	-0.281
11	419	3.709	3.947	0.238
11	443	3.614	4.523	0.909
50	259	4.538	4.696	0.158
50	346	3.688	3.852	0.164
50	347	3.257	3.351	0.094
51	462	3.905	3.911	0.006
51	478	3.944	3.670	-0.274
51	503	4.629	4.973	0.344
100	354	4.301	4.558	0.258
100	363	3.670	3.632	-0.038
100	366	4.734	4.739	0.005
100	383	4.781	4.560	-0.221
100	417	3.623	4.253	0.631
101	513	4.298	4.389	0.090
101	526	4.199	4.484	0.285
101	532	4.074	4.693	0.618
101	533	3.668	3.868	0.201
101	534	4.475	4.976	0.500
Max		4.781	4.976	0.909
Average		4.074	4.206	0.131
Min		3.257	3.351	-0.281
Std Dev		0.406	0.459	0.313

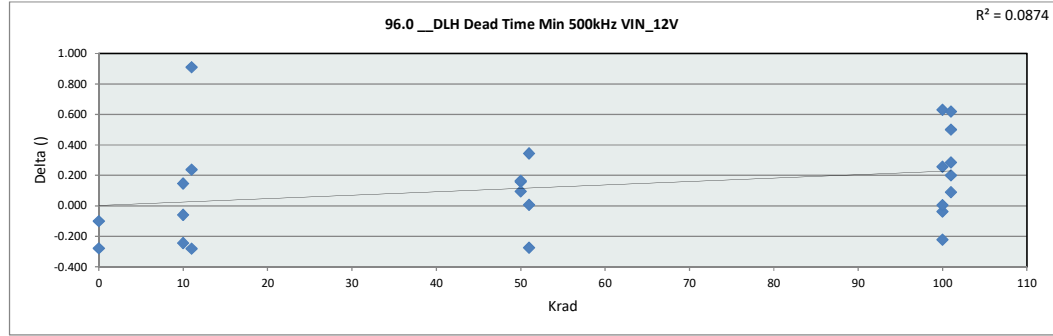

96.0 DLH Dead Time Min 500k	
Test Site	DAL
Tester	ETS364
Test Number	EB672303
Max Limit	10
Min Limit	0

Krad	0	10	11	50	51	100	101
LL	0.000	0.000	0.000	0.000	0.000	0.000	0.000
Min	3.853	3.511	3.947	3.351	3.670	3.632	3.868
Average	4.009	3.885	4.220	3.966	4.185	4.348	4.482
Max	4.165	4.245	4.523	4.696	4.973	4.739	4.976
UL	10.000	10.000	10.000	10.000	10.000	10.000	10.000

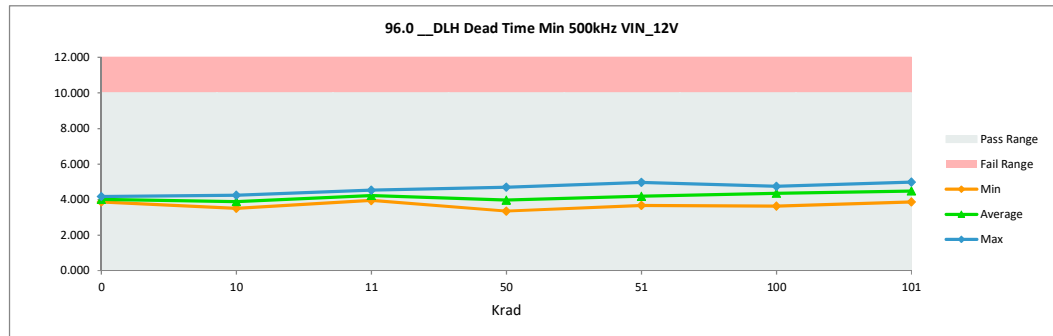

TID "HDR" Report
5962R2220102VXC

96.1 DLH Dead Time Small 500		
Test Site	DAL	DAL
Tester	ETS364	ETS364
Test Number	EB672303	EB672303
Unit		
Max Limit	15.5	15.5
Min Limit	8	8

Krad	Serial #	Pre_HDR_6013	Post_HDR_6013	Delta
0	1	11.348	11.425	0.077
0	2	10.961	11.026	0.065
10	182	11.404	11.391	-0.014
10	202	11.117	10.817	-0.300
10	204	11.505	11.491	-0.013
11	418	11.803	11.432	-0.372
11	419	11.384	11.397	0.013
11	443	10.945	11.610	0.665
50	259	11.342	11.087	-0.255
50	346	10.906	10.545	-0.360
50	347	10.926	10.522	-0.404
51	462	11.439	10.368	-1.071
51	478	11.756	10.843	-0.913
51	503	11.808	11.700	-0.108
100	354	11.900	11.023	-0.877
100	363	11.099	10.149	-0.950
100	366	11.482	10.920	-0.563
100	383	12.322	10.937	-1.385
100	417	10.934	10.559	-0.375
101	513	11.506	10.468	-1.038
101	526	11.759	10.847	-0.912
101	532	11.389	10.808	-0.581
101	533	10.832	10.216	-0.616
101	534	11.403	10.848	-0.554
Max		12.322	11.700	0.665
Average		11.386	10.935	-0.452
Min		10.832	10.149	-1.385
Std Dev		0.379	0.442	0.472

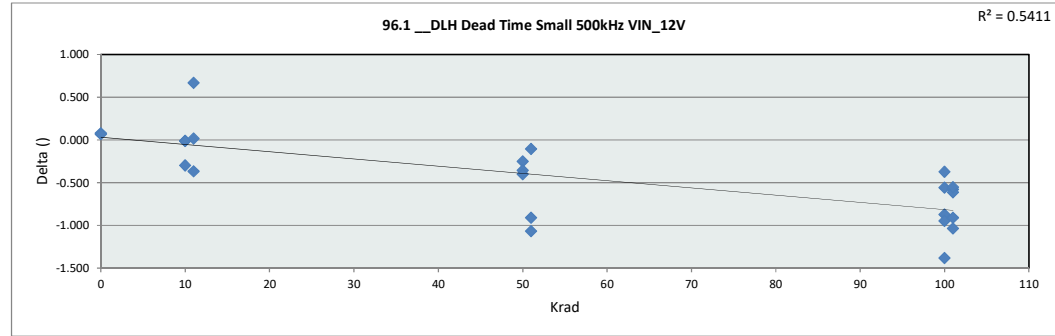

96.1 DLH Dead Time Small 5	
Test Site	DAL
Tester	ETS364
Test Number	EB672303
Max Limit	15.5
Min Limit	8

Krad	0	10	11	50	51	100	101
LL	8.000	8.000	8.000	8.000	8.000	8.000	8.000
Min	11.026	10.817	11.397	10.522	10.368	10.149	10.216
Average	11.226	11.233	11.480	10.718	10.970	10.718	10.637
Max	11.425	11.491	11.610	11.088	11.700	11.023	10.848
UL	15.500	15.500	15.500	15.500	15.500	15.500	15.500

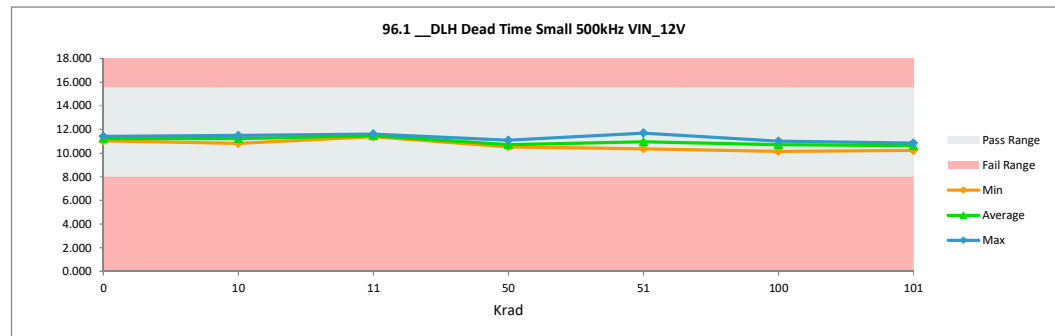

TID "HDR" Report
5962R2220102VXC

96.2 DLH Dead Time Mid 500k		
Test Site	DAL	DAL
Tester	ETS364	ETS364
Test Number	EB672303	EB672303
Unit		
Max Limit	24	24
Min Limit	15.5	15.5

Krad	Serial #	Pre_HDR_6013	Post_HDR_6013	Delta
0	1	19.853	19.989	0.136
0	2	19.243	19.125	-0.119
10	182	20.179	20.103	-0.076
10	202	19.863	19.493	-0.370
10	204	20.452	20.162	-0.290
11	418	20.306	19.890	-0.416
11	419	19.998	19.929	-0.068
11	443	19.680	20.191	0.511
50	259	19.336	18.826	-0.510
50	346	19.702	18.827	-0.875
50	347	20.006	19.121	-0.885
51	462	20.404	18.801	-1.603
51	478	20.486	19.323	-1.164
51	503	20.493	19.769	-0.723
100	354	20.377	19.269	-1.107
100	363	19.846	18.366	-1.480
100	366	19.525	18.352	-1.173
100	383	20.790	19.048	-1.742
100	417	19.521	18.555	-0.967
101	513	20.162	18.208	-1.954
101	526	20.285	18.831	-1.454
101	532	20.085	18.895	-1.190
101	533	19.633	18.292	-1.341
101	534	19.456	18.212	-1.244
Max		20.790	20.191	0.511
Average		19.987	19.149	-0.838
Min		19.243	18.208	-1.954
Std Dev		0.417	0.661	0.645

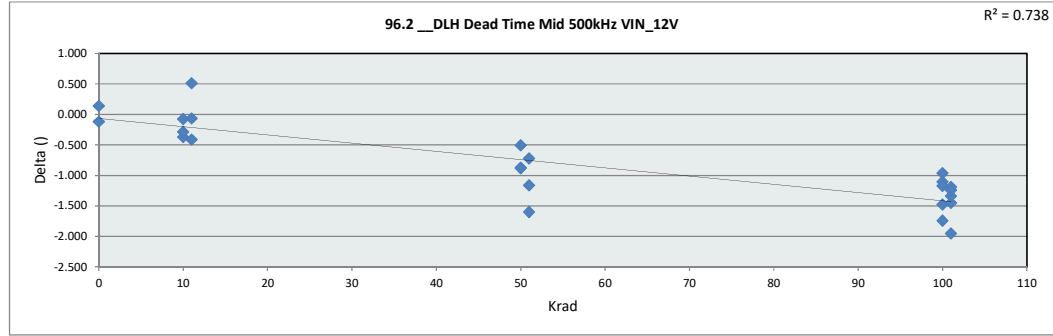

96.2 DLH Dead Time Mid 500k	
Test Site	DAL
Tester	ETS364
Test Number	EB672303
Max Limit	24
Min Limit	15.5

Krad	0	10	11	50	51	100	101
LL	15.500	15.500	15.500	15.500	15.500	15.500	15.500
Min	19.125	19.493	19.891	18.826	18.801	18.352	18.208
Average	19.557	19.919	20.004	18.925	19.298	18.718	18.488
Max	19.989	20.162	20.191	19.121	19.769	19.269	18.895
UL	24.000	24.000	24.000	24.000	24.000	24.000	24.000

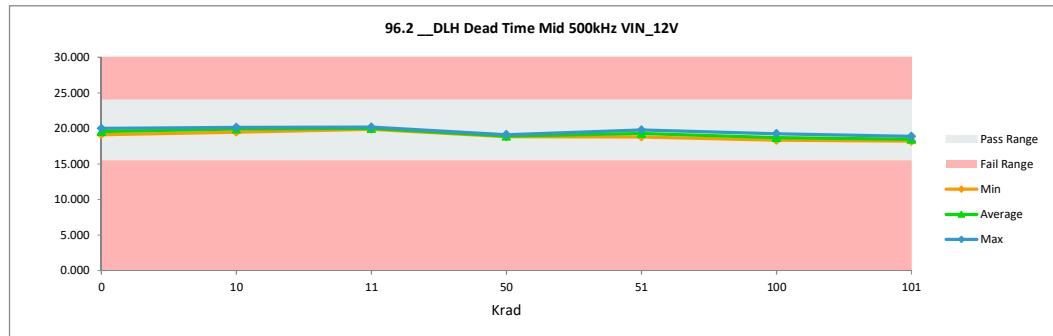

TID "HDR" Report
5962R2220102VXC

96.3 DLH Dead Time Large 500kHz VIN_12V

Test Site	DAL	DAL
Tester	ETS364	ETS364
Test Number	EB672303	EB672303
Unit		
Max Limit	59	59
Min Limit	36	36

Krad	Serial #	Pre_HDR_6013	Post_HDR_6013	Delta
0	1	48.316	48.386	0.069
0	2	46.113	46.271	0.158
10	182	48.409	47.872	-0.537
10	202	48.676	47.852	-0.824
10	204	49.336	49.118	-0.218
11	418	48.825	47.864	-0.961
11	419	48.456	48.282	-0.174
11	443	48.106	47.724	-0.382
50	259	46.059	44.556	-1.503
50	346	47.808	46.185	-1.623
50	347	49.494	47.529	-1.964
51	462	49.530	45.792	-3.737
51	478	49.840	47.288	-2.552
51	503	48.650	46.590	-2.059
100	354	49.057	45.903	-3.154
100	363	48.243	45.248	-2.994
100	366	46.355	43.204	-3.150
100	383	49.473	45.084	-4.389
100	417	48.098	45.555	-2.544
101	513	48.172	44.430	-3.742
101	526	48.944	45.202	-3.742
101	532	48.216	44.563	-3.654
101	533	48.321	45.104	-3.217
101	534	46.168	42.989	-3.178
Max		49.840	49.118	0.158
Average		48.278	46.191	-2.086
Min		46.059	42.989	-4.389
Std Dev		1.099	1.670	1.437

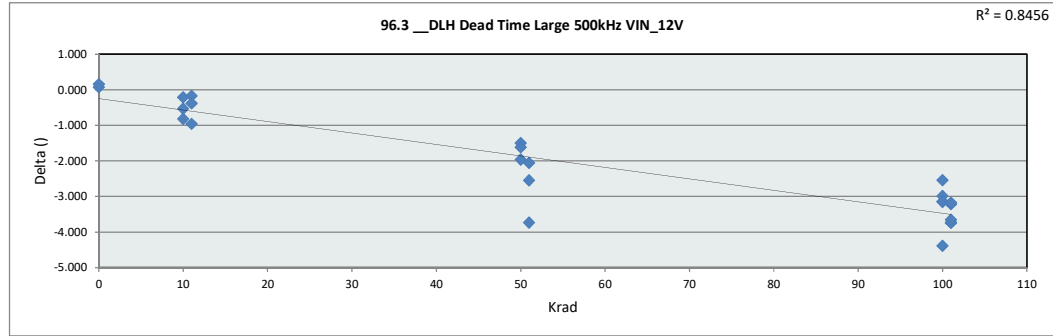

96.3 DLH Dead Time Large 500kHz VIN_12V

Test Site	DAL
Tester	ETS364
Test Number	EB672303
Max Limit	59
Min Limit	36

Krad	0	10	11	50	51	100	101
LL	36.000	36.000	36.000	36.000	36.000	36.000	36.000
Min	46.271	47.852	47.725	44.556	45.792	43.205	42.990
Average	47.328	48.281	47.957	46.090	46.557	44.999	44.458
Max	48.386	49.118	48.282	47.529	47.288	45.903	45.202
UL	59.000	59.000	59.000	59.000	59.000	59.000	59.000

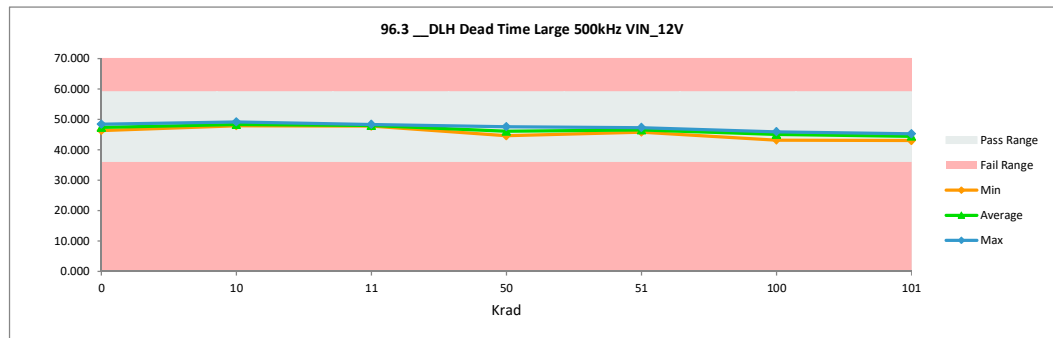

TID "HDR" Report
5962R2220102VXC

96.4 DLH Dead Time Max 500K		
Test Site	DAL	DAL
Tester	ETS364	ETS364
Test Number	EB672303	EB672303
Unit		
Max Limit	113.5	113.5
Min Limit	74	74

Krad	Serial #	Pre_HDR_6013	Post_HDR_6013	Delta
0	1	93.809	93.751	-0.058
0	2	89.221	89.230	0.009
10	182	93.434	92.740	-0.694
10	202	93.979	92.976	-1.004
10	204	95.574	95.366	-0.208
11	418	94.151	92.600	-1.551
11	419	94.334	93.764	-0.569
11	443	93.539	91.634	-1.905
50	259	88.060	84.652	-3.408
50	346	92.282	88.662	-3.620
50	347	96.661	93.157	-3.504
51	462	96.881	88.756	-8.126
51	478	97.076	91.399	-5.676
51	503	94.235	89.642	-4.593
100	354	95.135	88.049	-7.087
100	363	94.039	87.701	-6.339
100	366	88.936	82.789	-6.147
100	383	94.923	86.364	-8.559
100	417	93.498	88.370	-5.127
101	513	93.736	85.678	-8.058
101	526	93.978	86.591	-7.388
101	532	93.075	85.377	-7.698
101	533	94.816	87.356	-7.460
101	534	88.544	81.974	-6.570
	Max	97.076	95.366	0.009
	Average	93.496	89.107	-4.389
	Min	88.060	81.974	-8.559
	Std Dev	2.489	3.661	3.001

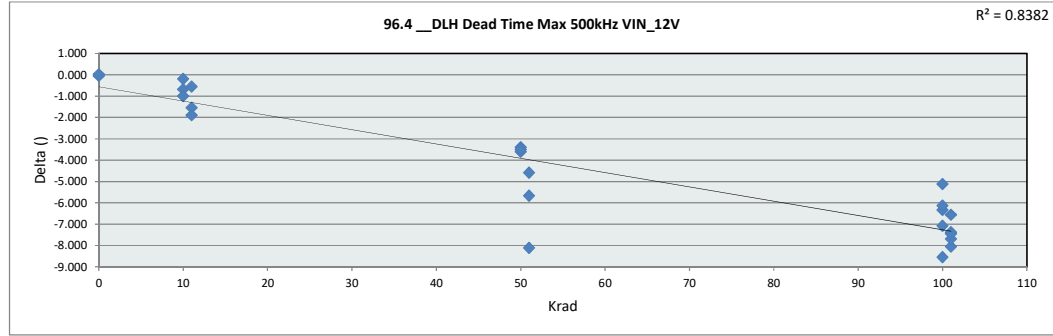

96.4 DLH Dead Time Max 50	
Test Site	DAL
Tester	ETS364
Test Number	EB672303
Max Limit	113.5
Min Limit	74

Krad	0	10	11	50	51	100	101
LL	74.000	74.000	74.000	74.000	74.000	74.000	74.000
Min	89.230	92.740	91.634	84.653	88.756	82.789	81.974
Average	91.491	93.694	92.666	88.824	89.932	86.654	85.395
Max	93.751	95.366	93.764	93.157	91.399	88.370	87.357
UL	113.500	113.500	113.500	113.500	113.500	113.500	113.500

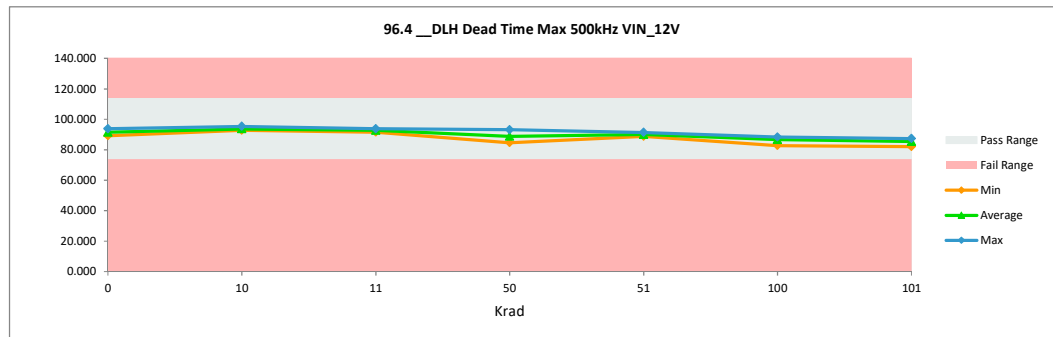

TID "HDR" Report
5962R2220102VXC

96.5 DLH Dead Time Min 1MHz		
Test Site	DAL	DAL
Tester	ETS364	ETS364
Test Number	EB672303	EB672303
Unit		
Max Limit	10	10
Min Limit	0	0

Krad	Serial #	Pre_HDR_6013	Post_HDR_6013	Delta
0	1	4.199	4.135	-0.064
0	2	4.211	4.390	0.179
10	182	4.279	4.385	0.106
10	202	3.904	3.655	-0.250
10	204	4.050	4.019	-0.032
11	418	4.553	4.413	-0.140
11	419	3.899	4.083	0.184
11	443	3.531	4.568	1.037
50	259	4.647	4.842	0.195
50	346	3.714	3.977	0.263
50	347	3.355	3.635	0.280
51	462	3.971	3.924	-0.046
51	478	3.998	3.914	-0.084
51	503	4.893	4.963	0.070
100	354	4.464	4.860	0.396
100	363	3.699	3.984	0.285
100	366	4.905	4.862	-0.043
100	383	4.830	4.637	-0.192
100	417	3.728	4.337	0.609
101	513	4.515	4.480	-0.035
101	526	4.390	4.655	0.265
101	532	4.333	4.759	0.426
101	533	3.628	4.244	0.616
101	534	4.665	5.020	0.355
Max		4.905	5.020	1.037
Average		4.182	4.364	0.183
Min		3.355	3.635	-0.250
Std Dev		0.449	0.410	0.298

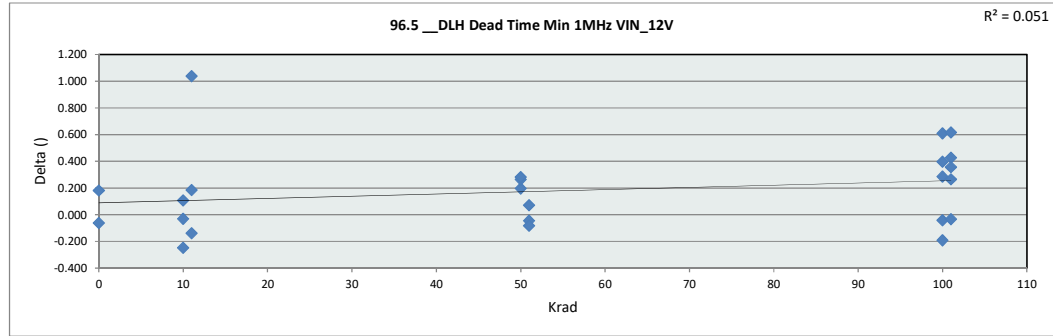

96.5 DLH Dead Time Min 1M	
Test Site	DAL
Tester	ETS364
Test Number	EB672303
Max Limit	10
Min Limit	0

	0	10	11	50	51	100	101
LL	0.000	0.000	0.000	0.000	0.000	0.000	0.000
Min	4.135	3.655	4.083	3.635	3.914	3.984	4.244
Average	4.263	4.020	4.355	4.151	4.267	4.536	4.632
Max	4.390	4.385	4.568	4.842	4.963	4.862	5.020
UL	10.000	10.000	10.000	10.000	10.000	10.000	10.000

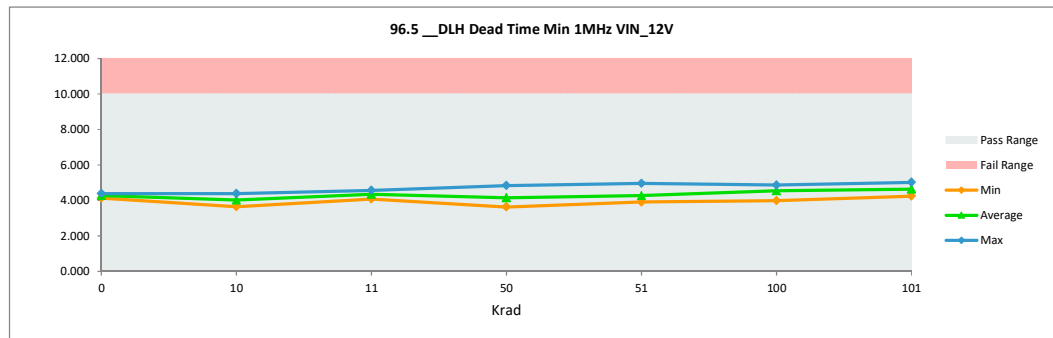

TID "HDR" Report
5962R2220102VXC

96.6 DLH Dead Time Small 1M		
Test Site	DAL	DAL
Tester	ETS364	ETS364
Test Number	EB672303	EB672303
Unit		
Max Limit	15.5	15.5
Min Limit	8	8

Krad	Serial #	Pre_HDR_6013	Post_HDR_6013	Delta
0	1	11.390	11.397	0.007
0	2	10.979	10.856	-0.124
10	182	11.390	11.301	-0.089
10	202	11.045	10.854	-0.191
10	204	11.531	11.318	-0.214
11	418	11.764	11.169	-0.595
11	419	11.155	11.259	0.103
11	443	10.825	11.573	0.748
50	259	11.259	10.972	-0.287
50	346	10.968	10.515	-0.454
50	347	10.698	10.346	-0.352
51	462	11.367	10.322	-1.044
51	478	11.408	10.570	-0.838
51	503	11.865	11.468	-0.397
100	354	11.663	11.099	-0.564
100	363	11.095	10.157	-0.938
100	366	11.394	10.645	-0.749
100	383	12.292	11.006	-1.286
100	417	10.813	10.502	-0.311
101	513	11.564	10.541	-1.022
101	526	11.552	10.685	-0.867
101	532	11.338	10.785	-0.553
101	533	10.837	10.286	-0.551
101	534	11.337	10.706	-0.631
Max		12.292	11.573	0.748
Average		11.314	10.847	-0.467
Min		10.698	10.157	-1.286
Std Dev		0.376	0.408	0.441

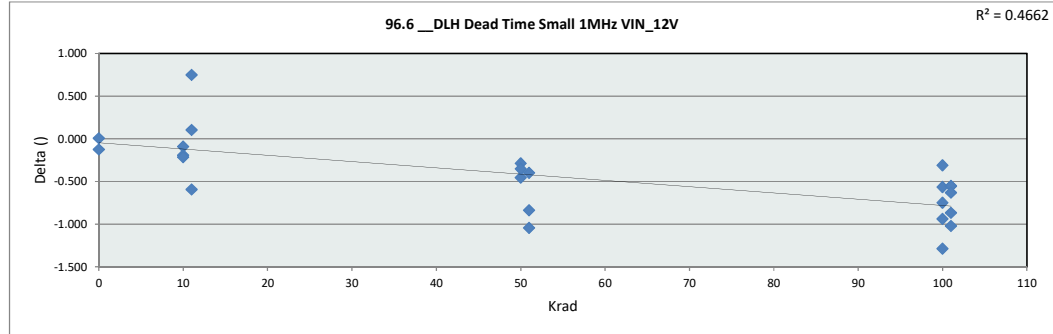

96.6 DLH Dead Time Small 1	
Test Site	DAL
Tester	ETS364
Test Number	EB672303
Max Limit	15.5
Min Limit	8

Krad	0	10	11	50	51	100	101
LL	8.000	8.000	8.000	8.000	8.000	8.000	8.000
Min	10.856	10.854	11.169	10.346	10.322	10.157	10.286
Average	11.127	11.157	11.334	10.611	10.787	10.682	10.601
Max	11.397	11.318	11.573	10.972	11.468	11.099	10.785
UL	15.500	15.500	15.500	15.500	15.500	15.500	15.500

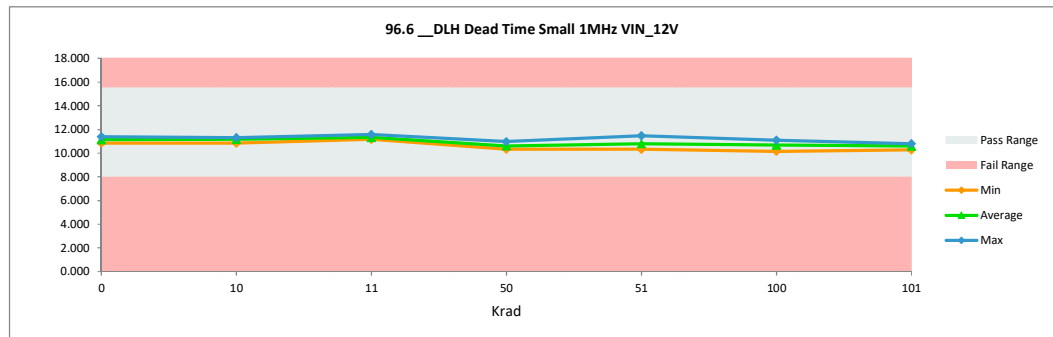

TID "HDR" Report
5962R2220102VXC

96.7 DLH Dead Time Mid 1MHz		
Test Site	DAL	DAL
Tester	ETS364	ETS364
Test Number	EB672303	EB672303
Unit		
Max Limit	24	24
Min Limit	15.5	15.5

Krad	Serial #	Pre_HDR_6013	Post_HDR_6013	Delta
0	1	19.726	19.679	-0.046
0	2	18.816	18.682	-0.134
10	182	19.775	19.565	-0.210
10	202	19.635	19.143	-0.492
10	204	20.010	19.792	-0.219
11	418	19.913	19.571	-0.341
11	419	19.589	19.509	-0.080
11	443	19.260	19.763	0.503
50	259	18.965	18.559	-0.405
50	346	19.188	18.626	-0.563
50	347	19.454	18.636	-0.818
51	462	19.943	18.222	-1.722
51	478	20.029	18.833	-1.196
51	503	19.965	19.474	-0.491
100	354	20.185	18.804	-1.381
100	363	19.276	17.944	-1.331
100	366	19.173	17.990	-1.183
100	383	20.376	18.597	-1.779
100	417	19.145	18.334	-0.810
101	513	19.643	17.793	-1.850
101	526	19.962	18.462	-1.500
101	532	19.478	18.363	-1.115
101	533	18.992	17.977	-1.015
101	534	18.942	18.014	-0.927
	Max	20.376	19.792	0.503
	Average	19.560	18.764	-0.796
	Min	18.816	17.793	-1.850
	Std Dev	0.439	0.647	0.626

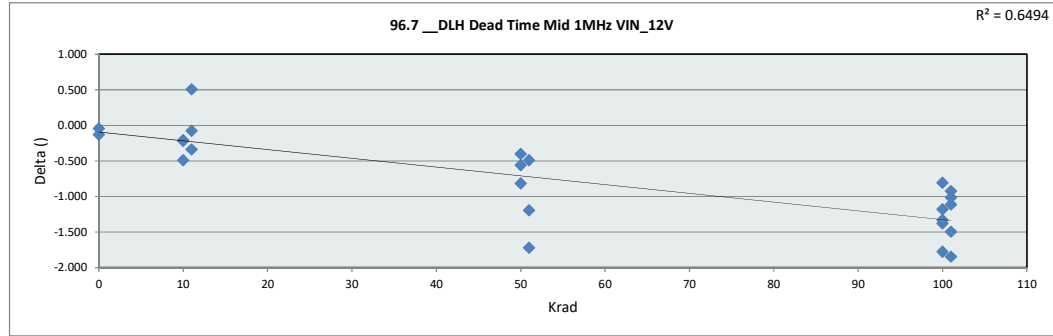

96.7 DLH Dead Time Mid 1M	
Test Site	DAL
Tester	ETS364
Test Number	EB672303
Max Limit	24
Min Limit	15.5

Krad	0	10	11	50	51	100	101
LL	15.500	15.500	15.500	15.500	15.500	15.500	15.500
Min	18.682	19.143	19.509	18.559	18.222	17.944	17.793
Average	19.181	19.500	19.614	18.607	18.843	18.334	18.122
Max	19.679	19.792	19.763	18.636	19.474	18.804	18.462
UL	24.000	24.000	24.000	24.000	24.000	24.000	24.000

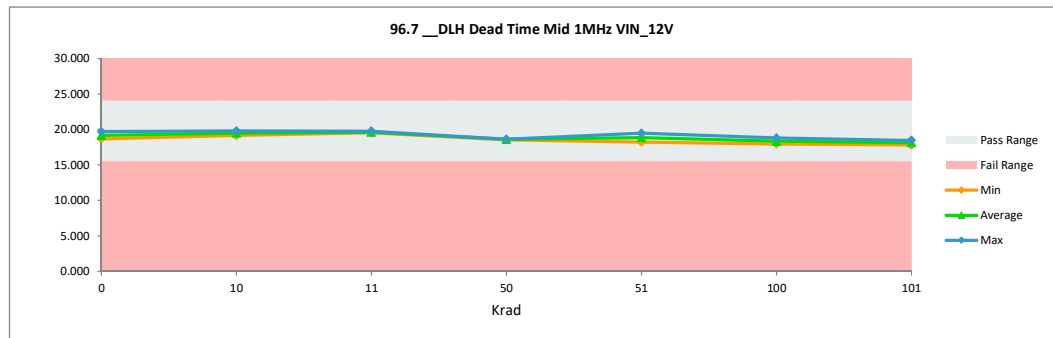

TID "HDR" Report
5962R2220102VXC

96.8 DLH Dead Time Large 1M		
Test Site	DAL	DAL
Tester	ETS364	ETS364
Test Number	EB672303	EB672303
Unit		
Max Limit	59	59
Min Limit	36	36

Krad	Serial #	Pre_HDR_6013	Post_HDR_6013	Delta
0	1	46.612	46.699	0.086
0	2	44.750	44.517	-0.233
10	182	46.619	46.207	-0.412
10	202	46.994	46.293	-0.701
10	204	47.606	47.239	-0.367
11	418	47.020	46.175	-0.845
11	419	46.933	46.421	-0.512
11	443	46.608	46.147	-0.461
50	259	44.366	43.000	-1.366
50	346	46.095	44.495	-1.600
50	347	47.736	45.788	-1.947
51	462	47.832	44.055	-3.777
51	478	48.064	45.419	-2.646
51	503	47.193	45.038	-2.155
100	354	47.370	44.160	-3.210
100	363	46.552	43.753	-2.798
100	366	44.555	42.051	-2.504
100	383	47.450	43.422	-4.027
100	417	46.336	43.869	-2.466
101	513	46.484	42.788	-3.696
101	526	46.974	43.661	-3.313
101	532	46.288	43.158	-3.130
101	533	46.599	43.282	-3.317
101	534	44.360	41.529	-2.831
	Max	48.064	47.239	0.086
	Average	46.558	44.549	-2.010
	Min	44.360	41.529	-4.027
	Std Dev	1.068	1.572	1.309

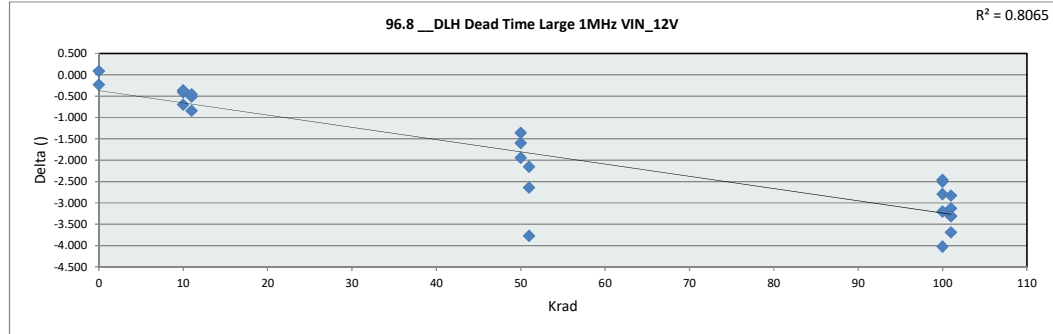

96.8 DLH Dead Time Large 1	
Test Site	DAL
Tester	ETS364
Test Number	EB672303
Max Limit	59
Min Limit	36

	0	10	11	50	51	100	101
LL	36.000	36.000	36.000	36.000	36.000	36.000	36.000
Min	44.517	46.207	46.147	43.000	44.055	42.051	41.529
Average	45.608	46.580	46.248	44.428	44.837	43.451	42.883
Max	46.699	47.239	46.421	45.788	45.419	44.160	43.661
UL	59.000	59.000	59.000	59.000	59.000	59.000	59.000

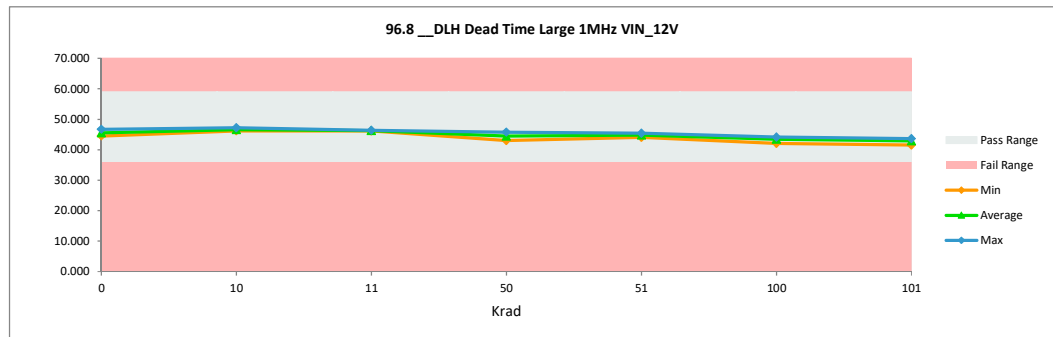

TID "HDR" Report
5962R2220102VXC

96.9 DLH Dead Time Max 1MHz		
Test Site	DAL	DAL
Tester	ETS364	ETS364
Test Number	EB672303	EB672303
Unit		
Max Limit	113.5	113.5
Min Limit	74	74

Krad	Serial #	Pre_HDR_6013	Post_HDR_6013	Delta
0	1	89.002	88.980	-0.022
0	2	84.981	85.068	0.087
10	182	88.902	88.449	-0.453
10	202	89.632	88.434	-1.199
10	204	91.091	90.863	-0.229
11	418	89.508	87.930	-1.579
11	419	89.926	89.220	-0.706
11	443	89.211	87.268	-1.943
50	259	83.871	80.922	-2.949
50	346	87.899	84.511	-3.388
50	347	92.318	88.911	-3.407
51	462	92.612	84.524	-8.088
51	478	92.526	87.276	-5.250
51	503	89.795	85.641	-4.155
100	354	90.806	84.201	-6.605
100	363	89.645	83.826	-5.819
100	366	84.709	79.263	-5.446
100	383	90.533	82.588	-7.944
100	417	89.052	84.184	-4.868
101	513	89.369	81.779	-7.589
101	526	89.507	82.873	-6.634
101	532	88.789	81.613	-7.176
101	533	90.462	83.476	-6.986
101	534	84.329	78.424	-5.905
	Max	92.612	90.863	0.087
	Average	89.103	85.009	-4.094
	Min	83.871	78.424	-8.088
	Std Dev	2.426	3.341	2.790

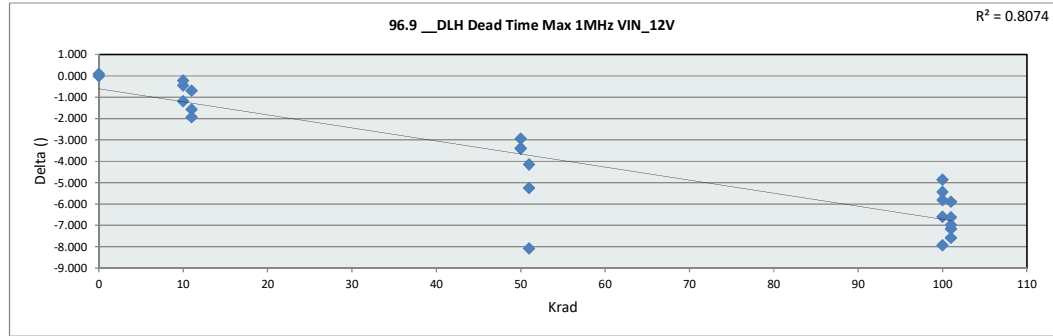

96.9 DLH Dead Time Max 1MHz		
Test Site	DAL	
Tester	ETS364	
Test Number	EB672303	
Max Limit	113.5	
Min Limit	74	

Krad	0	10	11	50	51	100	101
LL	74.000	74.000	74.000	74.000	74.000	74.000	74.000
Min	85.068	88.434	87.268	80.922	84.524	79.263	78.424
Average	87.024	89.249	88.139	84.781	85.814	82.812	81.633
Max	88.981	90.863	89.220	88.911	87.276	84.201	83.476
UL	113.500	113.500	113.500	113.500	113.500	113.500	113.500

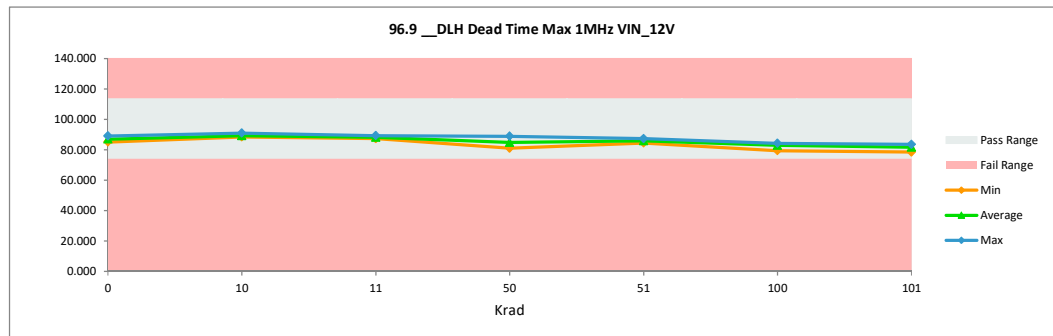

TID "HDR" Report
5962R2220102VXC

96.10_DLH Dead Time Min 2MH		
Test Site	DAL	DAL
Tester	ETS364	ETS364
Test Number	EB672303	EB672303
Unit		
Max Limit	10	10
Min Limit	0	0

Krad	Serial #	Pre_HDR_6013	Post_HDR_6013	Delta
0	1	4.277	4.326	0.050
0	2	4.432	4.345	-0.086
10	182	4.344	4.326	-0.018
10	202	4.182	3.684	-0.497
10	204	4.110	4.195	0.086
11	418	4.540	4.381	-0.159
11	419	4.082	4.239	0.157
11	443	3.777	4.646	0.869
50	259	4.879	4.923	0.044
50	346	3.893	4.149	0.256
50	347	3.451	3.728	0.277
51	462	4.010	3.910	-0.099
51	478	4.290	3.847	-0.443
51	503	4.802	5.058	0.256
100	354	4.558	4.852	0.294
100	363	3.994	3.899	-0.095
100	366	4.787	4.922	0.135
100	383	4.951	4.867	-0.083
100	417	3.620	4.473	0.854
101	513	4.479	4.692	0.213
101	526	4.624	4.624	0.001
101	532	4.484	4.985	0.502
101	533	3.733	4.350	0.618
101	534	4.480	5.048	0.567
	Max	4.951	5.058	0.869
	Average	4.282	4.436	0.154
	Min	3.451	3.684	-0.497
	Std Dev	0.407	0.429	0.347

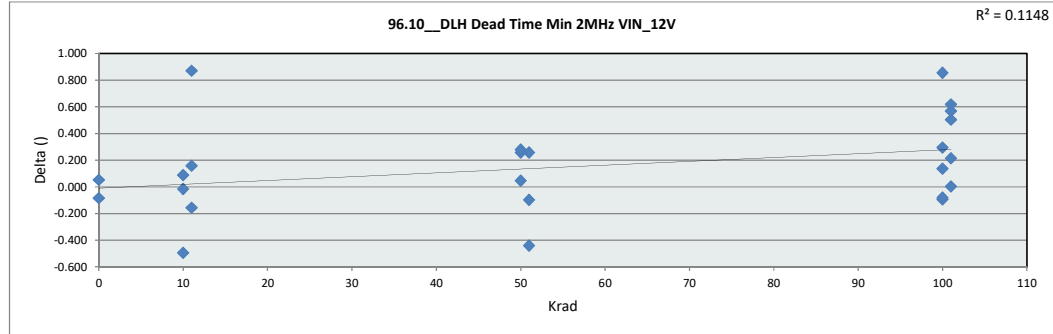

96.10_DLH Dead Time Min 2M	
Test Site	DAL
Tester	ETS364
Test Number	EB672303
Max Limit	10
Min Limit	0

Krad	0	10	11	50	51	100	101
LL	0.000	0.000	0.000	0.000	0.000	0.000	0.000
Min	4.326	3.685	4.239	3.728	3.847	3.899	4.350
Average	4.336	4.069	4.422	4.267	4.272	4.603	4.740
Max	4.345	4.326	4.646	4.923	5.058	4.922	5.048
UL	10.000	10.000	10.000	10.000	10.000	10.000	10.000

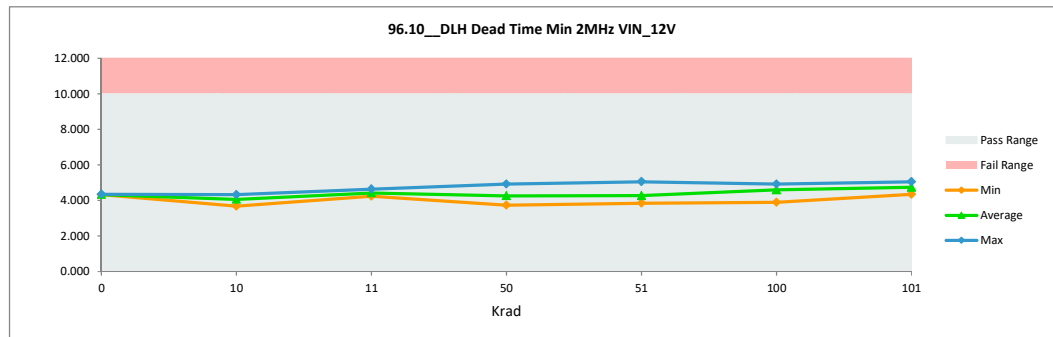

TID "HDR" Report
5962R2220102VXC

96.11_DLH Dead Time Small 2M		
Test Site	DAL	DAL
Tester	ETS364	ETS364
Test Number	EB672303	EB672303
Unit		
Max Limit	15.5	15.5
Min Limit	8	8

Krad	Serial #	Pre_HDR_6013	Post_HDR_6013	Delta
0	1	11.354	11.297	-0.057
0	2	10.929	10.758	-0.171
10	182	11.441	11.382	-0.060
10	202	11.195	10.780	-0.415
10	204	11.492	11.366	-0.126
11	418	11.497	11.120	-0.377
11	419	11.176	11.127	-0.049
11	443	10.802	11.573	0.771
50	259	11.254	11.193	-0.061
50	346	10.902	10.564	-0.338
50	347	10.638	10.332	-0.306
51	462	11.374	10.167	-1.207
51	478	11.542	10.722	-0.820
51	503	11.644	11.624	-0.020
100	354	11.597	11.097	-0.500
100	363	10.969	10.150	-0.819
100	366	11.358	10.633	-0.725
100	383	12.057	10.948	-1.109
100	417	10.782	10.468	-0.314
101	513	11.482	10.546	-0.936
101	526	11.446	10.576	-0.870
101	532	11.360	10.851	-0.509
101	533	10.901	10.364	-0.537
101	534	11.100	10.894	-0.206
	Max	12.057	11.624	0.771
	Average	11.262	10.855	-0.407
	Min	10.638	10.150	-1.207
	Std Dev	0.333	0.424	0.434

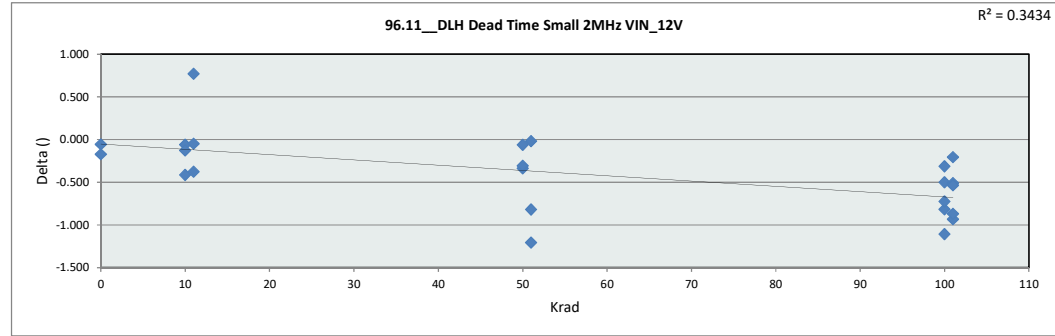

96.11_DLH Dead Time Small							
Test Site	DAL						
Tester	ETS364						
Test Number	EB672303						
Max Limit	15.5						
Min Limit	8						
Krad	0	10	11	50	51	100	101
LL	8.000	8.000	8.000	8.000	8.000	8.000	8.000
Min	10.758	10.780	11.120	10.332	10.167	10.150	10.364
Average	11.028	11.176	11.273	10.696	10.838	10.659	10.646
Max	11.297	11.382	11.573	11.193	11.624	11.097	10.894
UL	15.500	15.500	15.500	15.500	15.500	15.500	15.500

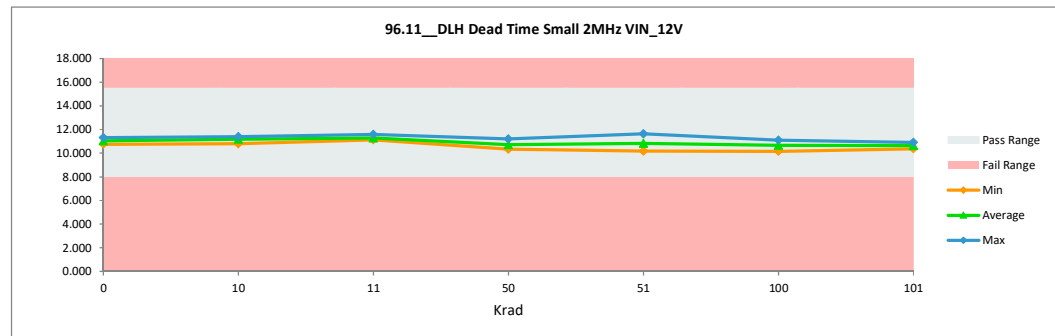

TID "HDR" Report
5962R2220102VXC

96.12_DLH Dead Time Mid 2MH		
Test Site	DAL	DAL
Tester	ETS364	ETS364
Test Number	EB672303	EB672303
Unit		
Max Limit	24	24
Min Limit	15.5	15.5

Krad	Serial #	Pre_HDR_6013	Post_HDR_6013	Delta
0	1	19.552	19.325	-0.228
0	2	18.817	18.503	-0.314
10	182	19.660	19.527	-0.133
10	202	19.409	19.011	-0.398
10	204	19.936	19.644	-0.292
11	418	19.637	19.384	-0.253
11	419	19.589	19.493	-0.095
11	443	19.050	19.622	0.572
50	259	18.763	18.410	-0.353
50	346	18.846	18.378	-0.468
50	347	19.365	18.440	-0.926
51	462	19.887	18.146	-1.741
51	478	19.869	18.836	-1.033
51	503	19.921	19.342	-0.579
100	354	20.045	18.371	-1.675
100	363	19.173	17.802	-1.371
100	366	19.001	17.906	-1.095
100	383	20.307	18.528	-1.778
100	417	19.089	18.090	-0.999
101	513	19.506	17.722	-1.784
101	526	19.652	18.227	-1.424
101	532	19.331	18.251	-1.080
101	533	19.180	17.770	-1.410
101	534	18.740	17.947	-0.793
	Max	20.307	19.644	0.572
	Average	19.430	18.612	-0.819
	Min	18.740	17.722	-1.784
	Std Dev	0.441	0.647	0.639

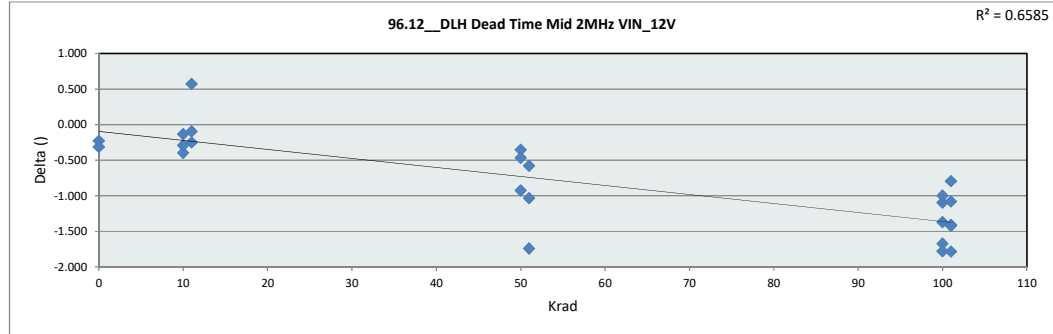

96.12_DLH Dead Time Mid 2M	
Test Site	DAL
Tester	ETS364
Test Number	EB672303
Max Limit	24
Min Limit	15.5

Krad	0	10	11	50	51	100	101
LL	15.500	15.500	15.500	15.500	15.500	15.500	15.500
Min	18.504	19.011	19.384	18.378	18.146	17.802	17.722
Average	18.914	19.394	19.500	18.409	18.775	18.139	17.983
Max	19.325	19.644	19.622	18.440	19.342	18.528	18.251
UL	24.000	24.000	24.000	24.000	24.000	24.000	24.000

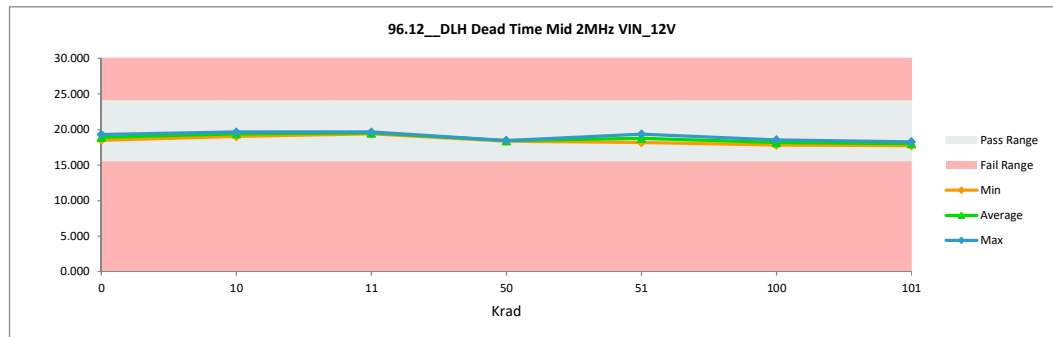

TID "HDR" Report
5962R2220102VXC

96.13_DLH Dead Time Large 2M		
Test Site	DAL	DAL
Tester	ETS364	ETS364
Test Number	EB672303	EB672303
Unit		
Max Limit	59	59
Min Limit	36	36

Krad	Serial #	Pre_HDR_6013	Post_HDR_6013	Delta
0	1	46.312	46.260	-0.052
0	2	44.459	44.403	-0.057
10	182	46.451	45.844	-0.607
10	202	46.629	45.749	-0.880
10	204	47.306	47.043	-0.263
11	418	46.786	45.952	-0.834
11	419	46.418	46.198	-0.220
11	443	46.041	45.812	-0.229
50	259	44.041	42.752	-1.289
50	346	45.716	44.195	-1.521
50	347	47.432	45.366	-2.065
51	462	47.293	43.842	-3.451
51	478	47.549	45.156	-2.394
51	503	46.854	44.624	-2.229
100	354	47.132	43.805	-3.328
100	363	46.504	43.360	-3.144
100	366	44.515	41.653	-2.862
100	383	47.365	43.331	-4.034
100	417	46.095	43.598	-2.497
101	513	46.241	42.683	-3.558
101	526	46.794	43.689	-3.105
101	532	46.029	42.958	-3.071
101	533	46.209	42.984	-3.226
101	534	44.296	41.418	-2.878
	Max	47.549	47.043	-0.052
	Average	46.270	44.278	-1.992
	Min	44.041	41.418	-4.034
	Std Dev	1.018	1.524	1.315

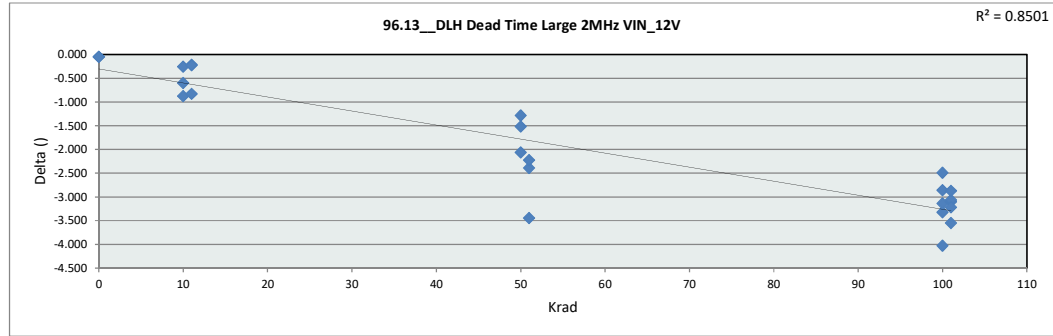

96.13_DLH Dead Time Large	
Test Site	DAL
Tester	ETS364
Test Number	EB672303
Max Limit	59
Min Limit	36

	0	10	11	50	51	100	101
LL	36.000	36.000	36.000	36.000	36.000	36.000	36.000
Min	44.403	45.749	45.812	42.752	43.842	41.653	41.418
Average	45.331	46.212	45.987	44.105	44.541	43.149	42.746
Max	46.260	47.043	46.198	45.366	45.156	43.805	43.689
UL	59.000	59.000	59.000	59.000	59.000	59.000	59.000

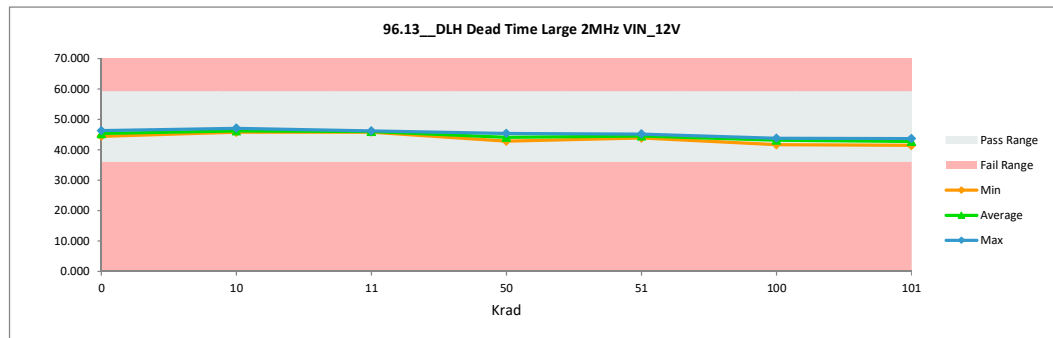

TID "HDR" Report
5962R2220102VXC

96.14_DLH Dead Time Max 2MHz		
Test Site	DAL	DAL
Tester	ETS364	ETS364
Test Number	EB672303	EB672303
Unit		
Max Limit	113.5	113.5
Min Limit	74	74

Krad	Serial #	Pre_HDR_6013	Post_HDR_6013	Delta
0	1	89.774	89.784	0.010
0	2	85.566	85.687	0.121
10	182	89.656	89.070	-0.586
10	202	90.371	89.173	-1.198
10	204	91.948	91.758	-0.189
11	418	90.518	88.798	-1.720
11	419	90.641	90.156	-0.485
11	443	89.881	87.779	-2.103
50	259	84.465	81.406	-3.059
50	346	88.574	85.260	-3.313
50	347	93.194	89.638	-3.556
51	462	93.316	85.149	-8.167
51	478	93.262	88.035	-5.227
51	503	90.466	86.203	-4.263
100	354	91.475	84.771	-6.704
100	363	90.622	84.568	-6.054
100	366	85.225	79.695	-5.530
100	383	91.375	83.149	-8.226
100	417	89.682	85.099	-4.583
101	513	90.036	82.602	-7.435
101	526	90.343	83.540	-6.803
101	532	89.408	82.454	-6.954
101	533	90.843	84.092	-6.751
101	534	84.986	78.904	-6.082
Max		93.316	91.758	0.121
Average		89.818	85.699	-4.119
Min		84.465	78.904	-8.226
Std Dev		2.485	3.422	2.803

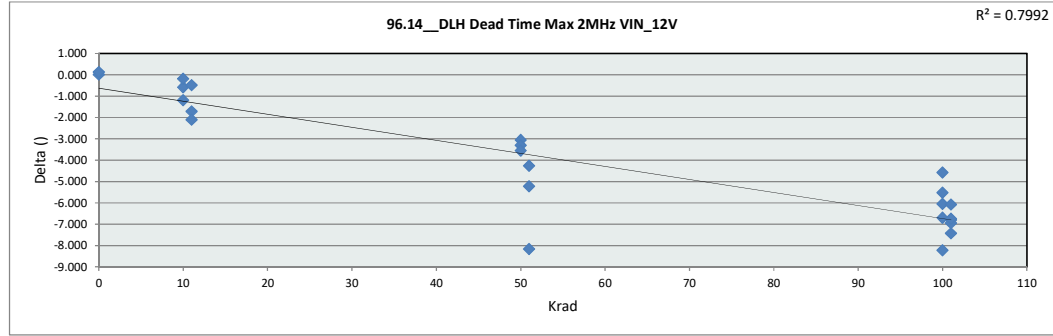

96.14_DLH Dead Time Max 2MHz	
Test Site	DAL
Tester	ETS364
Test Number	EB672303
Max Limit	113.5
Min Limit	74

Krad	0	10	11	50	51	100	101
LL	74.000	74.000	74.000	74.000	74.000	74.000	74.000
Min	85.687	89.070	87.779	81.406	85.149	79.695	78.904
Average	87.735	90.000	88.911	85.435	86.462	83.456	82.318
Max	89.784	91.758	90.156	89.638	88.035	85.099	84.092
UL	113.500	113.500	113.500	113.500	113.500	113.500	113.500

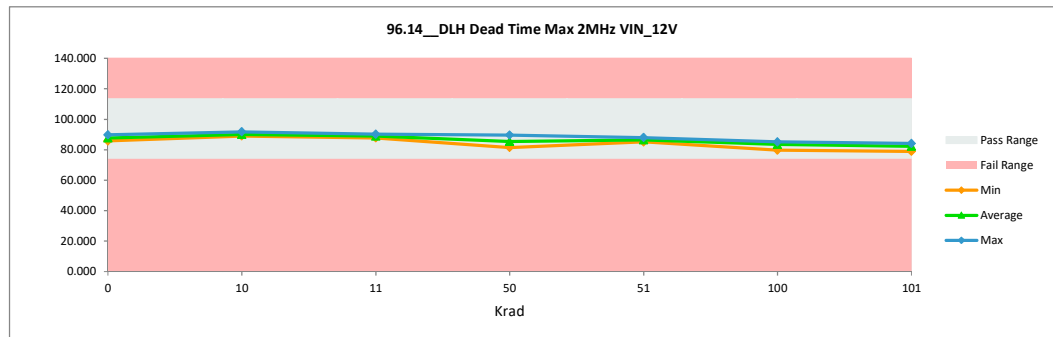

TID "HDR" Report
5962R2220102VXC

96.19 DHL Dead Time Min 500k		
Test Site	DAL	DAL
Tester	ETS364	ETS364
Test Number	EB672303	EB672303
Unit		
Max Limit	10	10
Min Limit	0	0

Krad	Serial #	Pre_HDR_6013	Post_HDR_6013	Delta
0	1	4.530	4.354	-0.176
0	2	3.381	3.422	0.041
10	182	3.764	3.855	0.091
10	202	4.275	4.367	0.093
10	204	3.822	4.855	1.033
11	418	3.567	4.518	0.950
11	419	3.888	4.384	0.496
11	443	3.658	4.089	0.431
50	259	4.443	4.570	0.127
50	346	5.045	5.436	0.391
50	347	4.309	4.465	0.156
51	462	3.973	4.244	0.271
51	478	3.314	4.363	1.049
51	503	4.198	4.109	-0.089
100	354	4.104	4.724	0.620
100	363	4.503	5.194	0.690
100	366	4.222	4.614	0.392
100	383	2.481	4.361	1.881
100	417	4.061	4.791	0.730
101	513	4.074	4.813	0.739
101	526	3.674	4.066	0.392
101	532	4.253	4.397	0.143
101	533	4.248	4.809	0.560
101	534	4.412	4.490	0.078
	Max	5.045	5.436	1.881
	Average	4.008	4.470	0.462
	Min	2.481	3.422	-0.176
	Std Dev	0.514	0.420	0.458

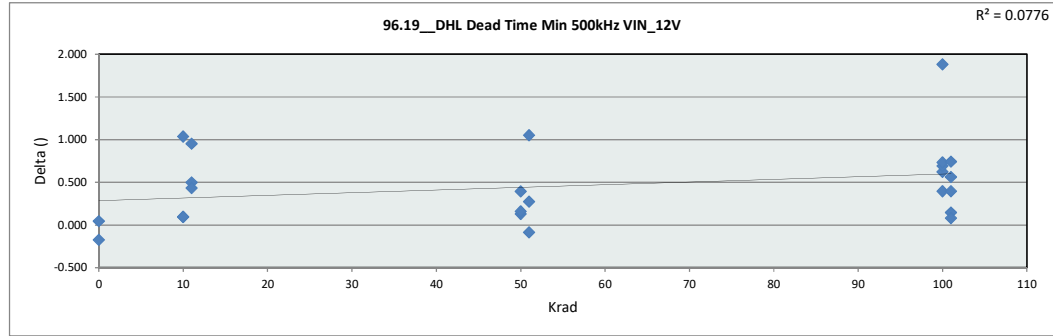

96.19 DHL Dead Time Min 50	
Test Site	DAL
Tester	ETS364
Test Number	EB672303
Max Limit	10
Min Limit	0

	0	10	11	50	51	100	101
LL	0.000	0.000	0.000	0.000	0.000	0.000	0.000
Min	3.422	3.855	4.089	4.465	4.109	4.362	4.066
Average	3.888	4.359	4.330	4.824	4.239	4.737	4.515
Max	4.354	4.855	4.518	5.436	4.363	5.194	4.813
UL	10.000	10.000	10.000	10.000	10.000	10.000	10.000

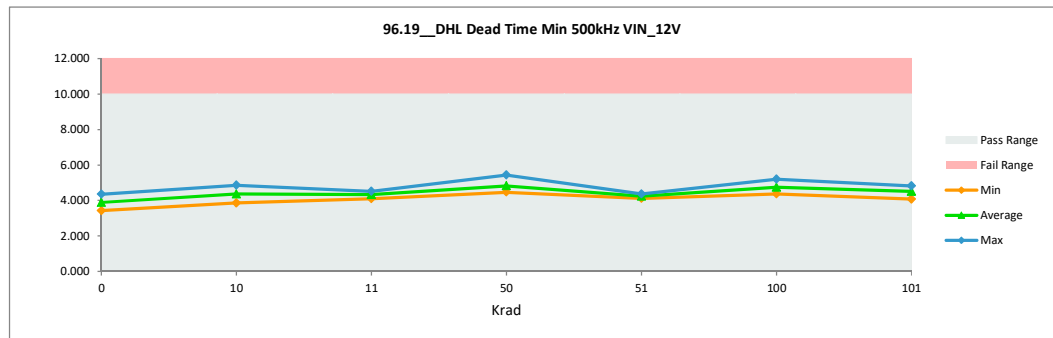

TID "HDR" Report
5962R2220102VXC

96.20 DHL Dead Time Small 50		
Test Site	DAL	DAL
Tester	ETS364	ETS364
Test Number	EB672303	EB672303
Unit		
Max Limit	15	15
Min Limit	6	6

Krad	Serial #	Pre_HDR_6013	Post_HDR_6013	Delta
0	1	9.909	10.014	0.104
0	2	9.084	9.146	0.062
10	182	9.430	9.565	0.135
10	202	9.926	9.880	-0.045
10	204	9.003	10.260	1.257
11	418	8.532	9.998	1.466
11	419	8.996	9.648	0.652
11	443	8.643	9.701	1.059
50	259	9.827	9.738	-0.089
50	346	10.418	10.537	0.118
50	347	9.915	9.926	0.011
51	462	9.163	9.696	0.533
51	478	8.559	9.317	0.759
51	503	9.717	9.551	-0.166
100	354	9.523	9.719	0.196
100	363	9.644	9.876	0.232
100	366	10.034	9.877	-0.157
100	383	7.617	9.594	1.977
100	417	8.964	9.775	0.812
101	513	9.497	9.802	0.305
101	526	9.366	9.290	-0.076
101	532	9.630	9.274	-0.356
101	533	9.948	9.841	-0.108
101	534	9.988	9.642	-0.346
Max		10.418	10.537	1.977
Average		9.389	9.736	0.347
Min		7.617	9.146	-0.356
Std Dev		0.632	0.310	0.603

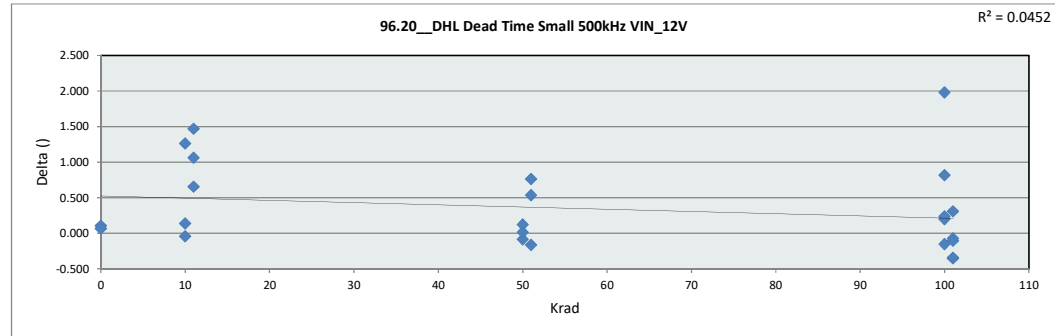

96.20 DHL Dead Time Small	
Test Site	DAL
Tester	ETS364
Test Number	EB672303
Max Limit	15
Min Limit	6

	0	10	11	50	51	100	101
LL	6.000	6.000	6.000	6.000	6.000	6.000	6.000
Min	9.146	9.565	9.648	9.738	9.317	9.594	9.274
Average	9.580	9.902	9.782	10.067	9.521	9.768	9.570
Max	10.014	10.260	9.998	10.537	9.696	9.878	9.841
UL	15.000	15.000	15.000	15.000	15.000	15.000	15.000

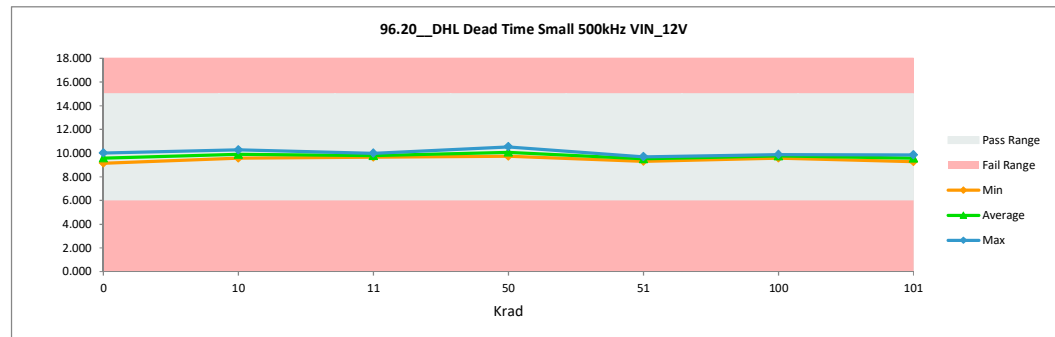

TID "HDR" Report
5962R2220102VXC

96.21 DHL Dead Time Mid 500k		
Test Site	DAL	DAL
Tester	ETS364	ETS364
Test Number	EB672303	EB672303
Unit		
Max Limit	24.5	24.5
Min Limit	16	16

Krad	Serial #	Pre_HDR_6013	Post_HDR_6013	Delta
0	1	19.855	20.013	0.158
0	2	19.532	19.860	0.327
10	182	19.597	19.646	0.049
10	202	20.014	19.834	-0.180
10	204	18.531	20.097	1.565
11	418	18.101	19.955	1.854
11	419	18.496	19.334	0.838
11	443	18.003	19.996	1.994
50	259	19.532	18.823	-0.710
50	346	20.069	19.741	-0.328
50	347	19.974	19.680	-0.294
51	462	18.557	19.467	0.910
51	478	18.064	18.777	0.713
51	503	19.892	19.333	-0.559
100	354	19.634	19.046	-0.588
100	363	19.190	18.729	-0.460
100	366	20.252	19.300	-0.952
100	383	16.963	19.135	2.172
100	417	18.602	18.854	0.252
101	513	19.525	19.076	-0.449
101	526	19.689	18.855	-0.834
101	532	19.543	18.641	-0.902
101	533	20.048	19.360	-0.687
101	534	19.937	18.903	-1.034
Max		20.252	20.097	2.172
Average		19.233	19.352	0.119
Min		16.963	18.641	-1.034
Std Dev		0.858	0.468	0.983

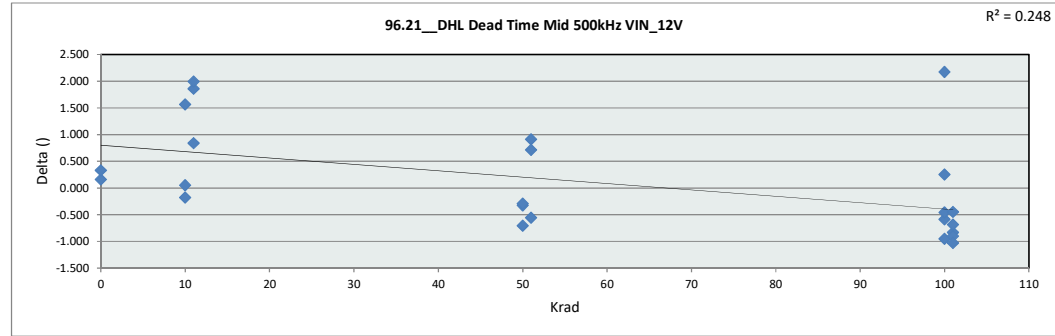

96.21 DHL Dead Time Mid 50	
Test Site	DAL
Tester	ETS364
Test Number	EB672303
Max Limit	24.5
Min Limit	16

Krad	0	10	11	50	51	100	101
LL	16.000	16.000	16.000	16.000	16.000	16.000	16.000
Min	19.860	19.646	19.334	18.823	18.777	18.729	18.641
Average	19.936	19.859	19.762	19.414	19.192	19.013	18.967
Max	20.013	20.097	19.996	19.741	19.467	19.300	19.360
UL	24.500	24.500	24.500	24.500	24.500	24.500	24.500

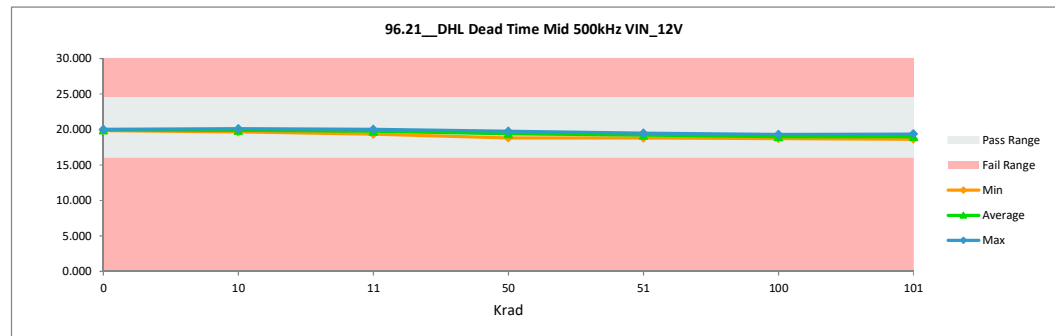

TID "HDR" Report
5962R2220102VXC

96.22 DHL Dead Time Large 50		
Test Site	DAL	DAL
Tester	ETS364	ETS364
Test Number	EB672303	EB672303
Unit		
Max Limit	61	61
Min Limit	44	44

Krad	Serial #	Pre_HDR_6013	Post_HDR_6013	Delta
0	1	50.551	50.526	-0.025
0	2	51.753	51.747	-0.007
10	182	50.237	50.111	-0.126
10	202	50.508	50.431	-0.077
10	204	47.554	49.942	2.388
11	418	46.773	50.345	3.572
11	419	47.328	49.024	1.696
11	443	46.880	51.213	4.333
50	259	48.668	46.667	-2.001
50	346	49.838	48.306	-1.532
50	347	50.923	49.180	-1.743
51	462	46.781	49.716	2.935
51	478	47.198	47.461	0.263
51	503	51.255	49.355	-1.900
100	354	50.381	47.371	-3.010
100	363	48.324	44.830	-3.494
100	366	51.628	48.414	-3.214
100	383	45.380	47.985	2.604
100	417	47.222	46.512	-0.710
101	513	50.157	47.225	-2.932
101	526	51.219	47.889	-3.331
101	532	50.562	47.157	-3.405
101	533	50.857	48.169	-2.688
101	534	50.756	47.460	-3.296
Max		51.753	51.747	4.333
Average		49.281	48.626	-0.654
Min		45.380	44.830	-3.494
Std Dev		1.920	1.679	2.465

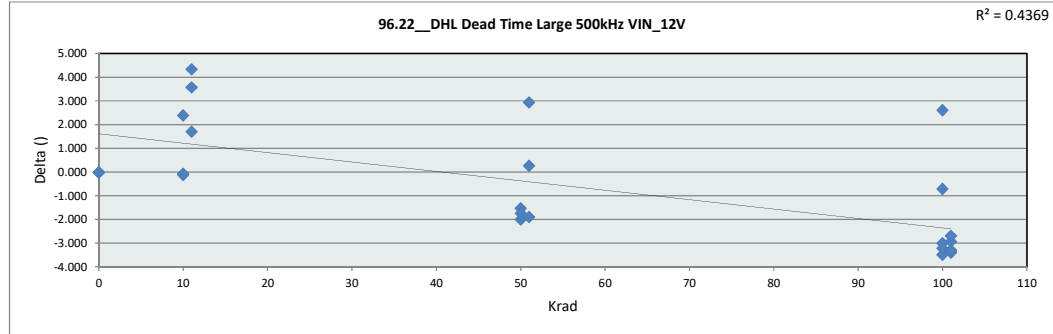

96.22 DHL Dead Time Large	
Test Site	DAL
Tester	ETS364
Test Number	EB672303
Max Limit	61
Min Limit	44

Krad	0	10	11	50	51	100	101
LL	44.000	44.000	44.000	44.000	44.000	44.000	44.000
Min	50.526	49.942	49.024	46.667	47.461	44.830	47.157
Average	51.136	50.161	50.194	48.051	48.844	47.022	47.580
Max	51.747	50.431	51.213	49.180	49.716	48.414	48.169
UL	61.000	61.000	61.000	61.000	61.000	61.000	61.000

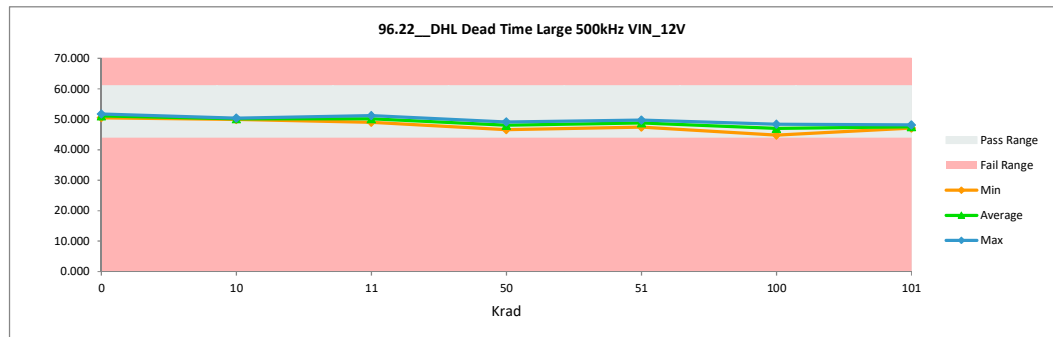

TID "HDR" Report
5962R2220102VXC

96.23 DHL Dead Time Max 500		
Test Site	DAL	DAL
Tester	ETS364	ETS364
Test Number	EB672303	EB672303
Unit		
Max Limit	125	125
Min Limit	86	86

Krad	Serial #	Pre_HDR_6013	Post_HDR_6013	Delta
0	1	98.587	98.701	0.114
0	2	102.411	102.390	-0.021
10	182	98.966	98.389	-0.577
10	202	98.822	98.248	-0.574
10	204	93.752	97.108	3.355
11	418	92.298	98.435	6.136
11	419	92.971	95.942	2.972
11	443	91.837	100.481	8.644
50	259	94.816	90.450	-4.365
50	346	96.901	92.991	-3.910
50	347	99.881	95.953	-3.928
51	462	91.613	97.281	5.668
51	478	92.835	92.911	0.076
51	503	100.774	97.085	-3.690
100	354	98.912	92.163	-6.749
100	363	94.332	86.116	-8.216
100	366	101.298	93.996	-7.301
100	383	89.965	93.409	3.444
100	417	92.536	90.526	-2.009
101	513	97.908	91.527	-6.381
101	526	100.739	93.463	-7.276
101	532	99.600	92.265	-7.335
101	533	99.869	93.590	-6.280
101	534	99.304	92.233	-7.071
Max		102.411	102.390	8.644
Average		96.705	94.819	-1.886
Min		89.965	86.116	-8.216
Std Dev		3.729	3.721	4.945

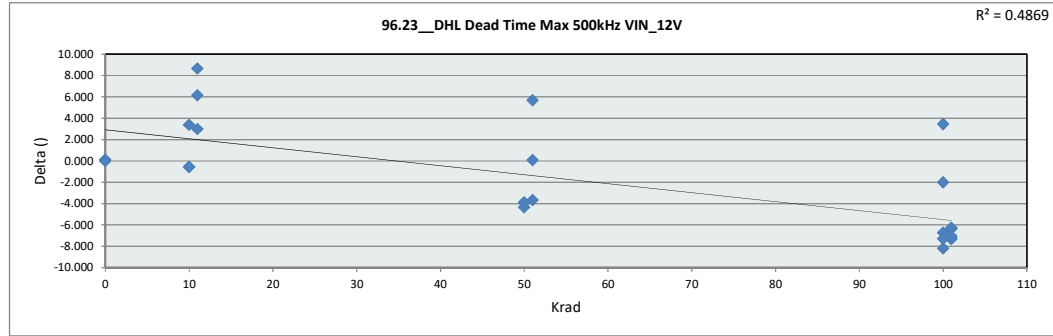

96.23 DHL Dead Time Max 500	
Test Site	DAL
Tester	ETS364
Test Number	EB672303
Max Limit	125
Min Limit	86

Krad	0	10	11	50	51	100	101
LL	86.000	86.000	86.000	86.000	86.000	86.000	86.000
Min	98.701	97.108	95.943	90.450	92.911	86.116	91.527
Average	100.546	97.915	98.286	93.131	95.759	91.242	92.616
Max	102.390	98.389	100.481	95.953	97.281	93.997	93.590
UL	125.000	125.000	125.000	125.000	125.000	125.000	125.000

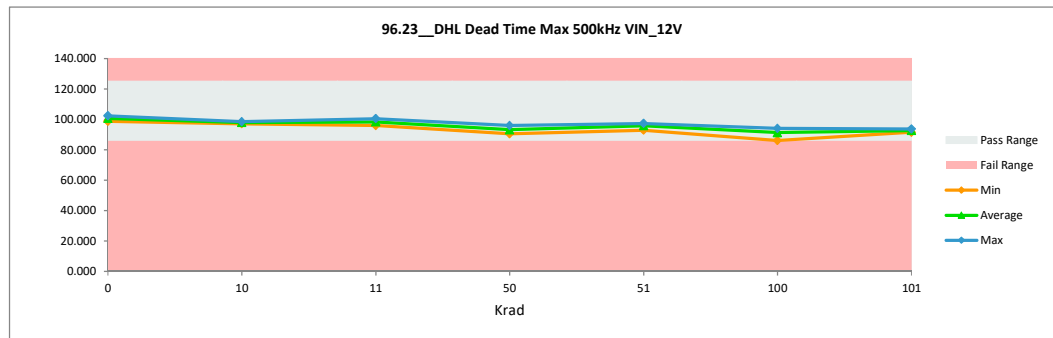

TID "HDR" Report
5962R2220102VXC

96.24 DHL Dead Time Min 1MH		
Test Site	DAL	DAL
Tester	ETS364	ETS364
Test Number	EB672303	EB672303
Unit		
Max Limit	10	10
Min Limit	0	0

Krad	Serial #	Pre_HDR_6013	Post_HDR_6013	Delta
0	1	4.724	4.831	0.107
0	2	3.681	3.872	0.191
10	182	3.995	4.106	0.111
10	202	4.673	4.570	-0.102
10	204	4.046	5.080	1.035
11	418	3.943	4.690	0.747
11	419	4.211	4.739	0.528
11	443	3.792	4.387	0.594
50	259	4.882	4.887	0.005
50	346	5.275	5.821	0.546
50	347	4.651	4.771	0.119
51	462	4.148	4.601	0.454
51	478	3.717	4.527	0.810
51	503	4.356	4.402	0.046
100	354	4.389	4.885	0.496
100	363	4.784	5.379	0.594
100	366	4.623	4.842	0.218
100	383	2.790	4.453	1.663
100	417	4.222	5.206	0.984
101	513	4.298	4.954	0.656
101	526	4.057	4.528	0.471
101	532	4.330	4.701	0.371
101	533	4.712	5.050	0.338
101	534	4.800	4.815	0.015
	Max	5.275	5.821	1.663
	Average	4.296	4.754	0.458
	Min	2.790	3.872	-0.102
	Std Dev	0.517	0.403	0.404

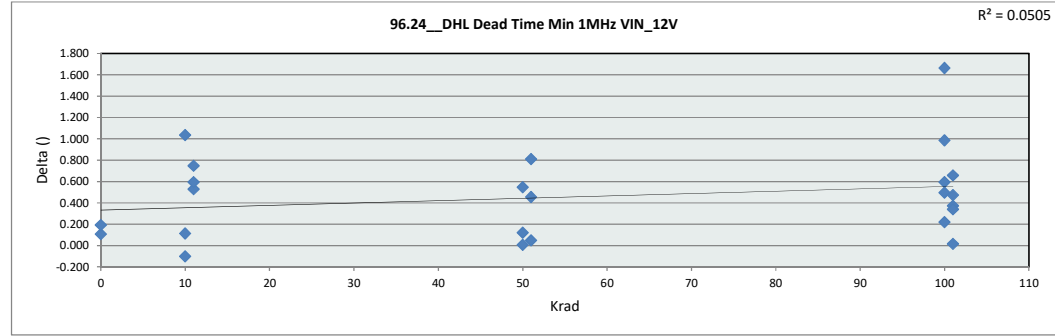

96.24 DHL Dead Time Min 1M	
Test Site	DAL
Tester	ETS364
Test Number	EB672303
Max Limit	10
Min Limit	0

	0	10	11	50	51	100	101
LL	0.000	0.000	0.000	0.000	0.000	0.000	0.000
Min	3.872	4.106	4.387	4.771	4.402	4.453	4.528
Average	4.352	4.585	4.605	5.160	4.510	4.953	4.810
Max	4.831	5.080	4.739	5.821	4.601	5.379	5.050
UL	10.000	10.000	10.000	10.000	10.000	10.000	10.000

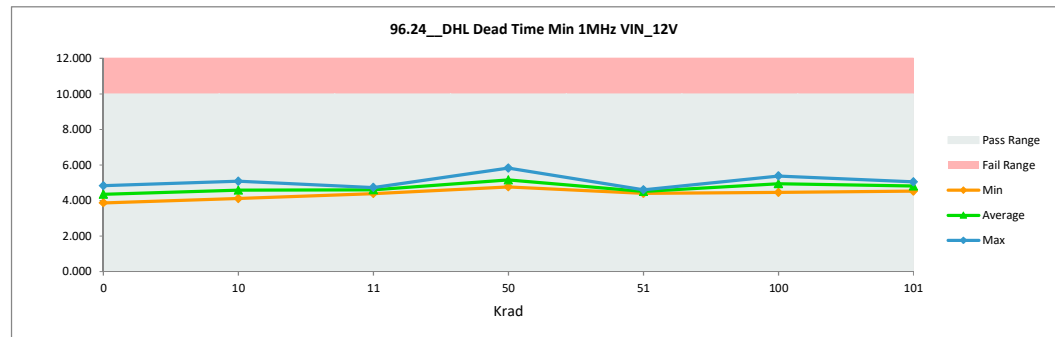

TID "HDR" Report
5962R2220102VXC

96.25 DHL Dead Time Small 1M		
Test Site	DAL	DAL
Tester	ETS364	ETS364
Test Number	EB672303	EB672303
Unit		
Max Limit	15	15
Min Limit	6	6

Krad	Serial #	Pre_HDR_6013	Post_HDR_6013	Delta
0	1	10.215	10.294	0.079
0	2	9.437	9.532	0.095
10	182	9.742	9.799	0.057
10	202	10.127	10.149	0.022
10	204	9.204	10.563	1.359
11	418	8.932	10.205	1.273
11	419	9.214	9.964	0.750
11	443	8.919	9.947	1.028
50	259	10.019	9.903	-0.116
50	346	10.608	10.704	0.096
50	347	10.094	10.019	-0.075
51	462	9.358	9.946	0.588
51	478	8.837	9.519	0.682
51	503	9.938	9.829	-0.109
100	354	9.933	9.846	-0.087
100	363	9.857	10.188	0.331
100	366	10.133	10.138	0.005
100	383	7.968	9.733	1.766
100	417	9.374	10.000	0.626
101	513	9.771	9.894	0.123
101	526	9.763	9.509	-0.254
101	532	9.981	9.679	-0.301
101	533	10.173	9.990	-0.183
101	534	10.218	9.819	-0.399
Max		10.608	10.704	1.766
Average		9.659	9.965	0.307
Min		7.968	9.509	-0.399
Std Dev		0.594	0.296	0.578

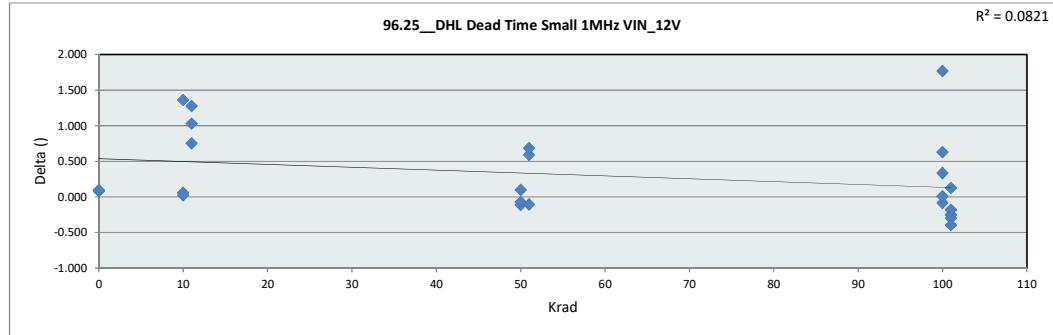

96.25 DHL Dead Time Small	
Test Site	DAL
Tester	ETS364
Test Number	EB672303
Max Limit	15
Min Limit	6

	0	10	11	50	51	100	101
LL	6.000	6.000	6.000	6.000	6.000	6.000	6.000
Min	9.532	9.799	9.947	9.903	9.519	9.733	9.509
Average	9.913	10.170	10.039	10.209	9.765	9.981	9.778
Max	10.294	10.563	10.205	10.704	9.946	10.188	9.990
UL	15.000	15.000	15.000	15.000	15.000	15.000	15.000

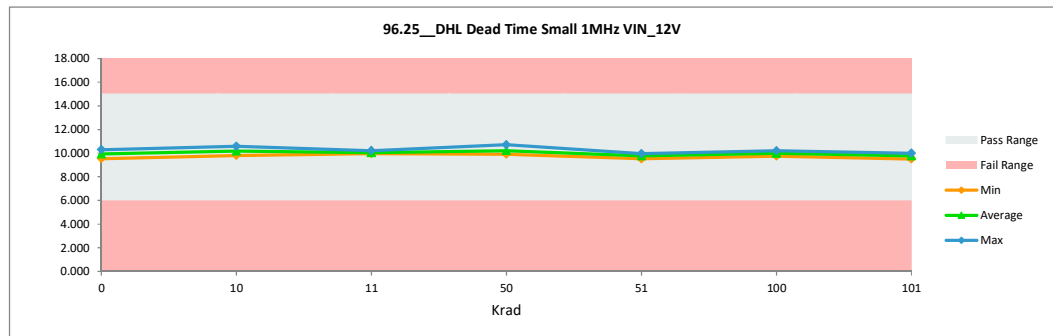

TID "HDR" Report
5962R2220102VXC

96.26 DHL Dead Time Mid 1MH		
Test Site	DAL	DAL
Tester	ETS364	ETS364
Test Number	EB672303	EB672303
Unit		
Max Limit	24.5	24.5
Min Limit	16	16

Krad	Serial #	Pre_HDR_6013	Post_HDR_6013	Delta
0	1	20.205	20.321	0.116
0	2	19.920	19.978	0.058
10	182	19.864	19.769	-0.095
10	202	20.201	20.088	-0.112
10	204	18.754	20.456	1.702
11	418	18.406	20.262	1.856
11	419	18.827	19.749	0.922
11	443	18.326	20.291	1.965
50	259	19.826	19.022	-0.804
50	346	20.349	20.149	-0.200
50	347	20.255	19.714	-0.541
51	462	18.856	19.901	1.046
51	478	18.498	19.049	0.551
51	503	20.372	19.711	-0.660
100	354	20.077	19.395	-0.683
100	363	19.416	18.929	-0.487
100	366	20.462	19.667	-0.795
100	383	17.361	19.314	1.952
100	417	18.872	19.141	0.269
101	513	19.926	19.219	-0.707
101	526	20.045	19.092	-0.953
101	532	20.093	19.021	-1.072
101	533	20.318	19.643	-0.675
101	534	20.304	19.201	-1.104
	Max	20.462	20.456	1.965
	Average	19.564	19.628	0.065
	Min	17.361	18.929	-1.104
	Std Dev	0.853	0.481	1.006

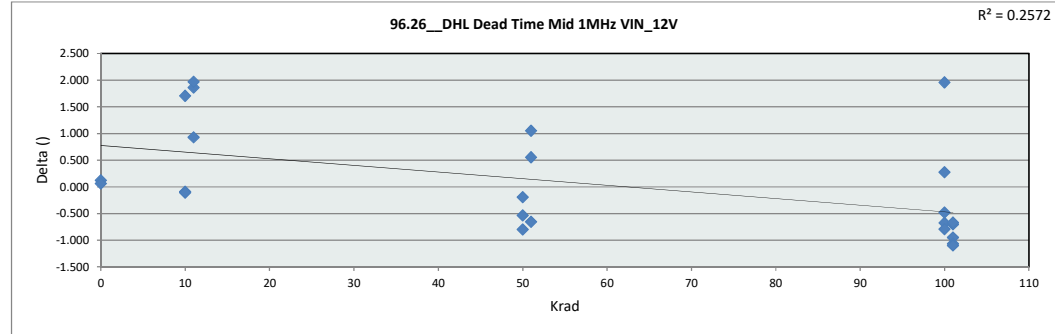

96.26 DHL Dead Time Mid 1M	
Test Site	DAL
Tester	ETS364
Test Number	EB672303
Max Limit	24.5
Min Limit	16

Krad	0	10	11	50	51	100	101
LL	16.000	16.000	16.000	16.000	16.000	16.000	16.000
Min	19.978	19.769	19.749	19.022	19.049	18.929	19.021
Average	20.149	20.105	20.101	19.629	19.554	19.289	19.235
Max	20.321	20.456	20.291	20.149	20.149	19.667	19.644
UL	24.500	24.500	24.500	24.500	24.500	24.500	24.500

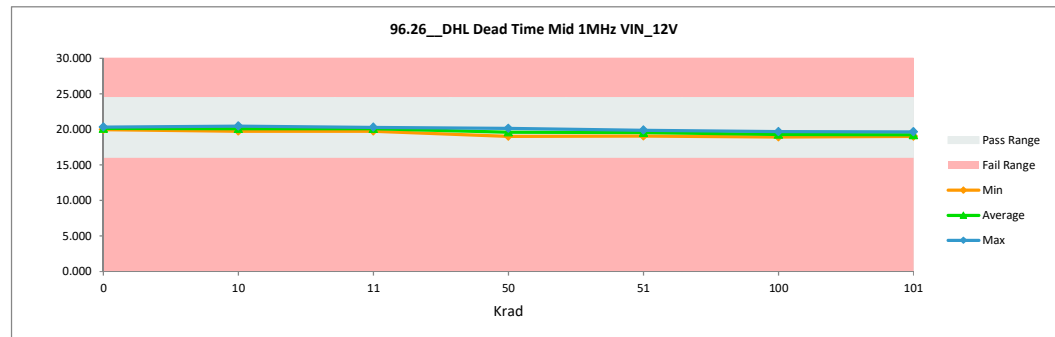

TID "HDR" Report
5962R2220102VXC

96.27 DHL Dead Time Large 1M		
Test Site	DAL	DAL
Tester	ETS364	ETS364
Test Number	EB672303	EB672303
Unit		
Max Limit	61	61
Min Limit	44	44

Krad	Serial #	Pre_HDR_6013	Post_HDR_6013	Delta
0	1	50.873	51.283	0.410
0	2	52.137	52.318	0.181
10	182	50.849	50.598	-0.250
10	202	50.899	50.813	-0.086
10	204	48.141	50.474	2.332
11	418	47.304	50.904	3.600
11	419	47.898	49.611	1.712
11	443	47.523	51.825	4.302
50	259	49.154	47.186	-1.968
50	346	50.390	48.821	-1.568
50	347	51.536	49.810	-1.726
51	462	47.533	50.295	2.762
51	478	47.712	47.950	0.238
51	503	51.780	49.727	-2.053
100	354	50.901	47.914	-2.987
100	363	48.798	45.190	-3.608
100	366	52.199	48.752	-3.446
100	383	45.911	48.551	2.640
100	417	47.799	46.859	-0.940
101	513	50.703	47.538	-3.166
101	526	51.641	48.224	-3.417
101	532	51.134	47.610	-3.524
101	533	51.324	48.640	-2.684
101	534	51.491	47.888	-3.604
Max		52.199	52.318	4.302
Average		49.818	49.116	-0.702
Min		45.911	45.190	-3.608
Std Dev		1.890	1.741	2.515

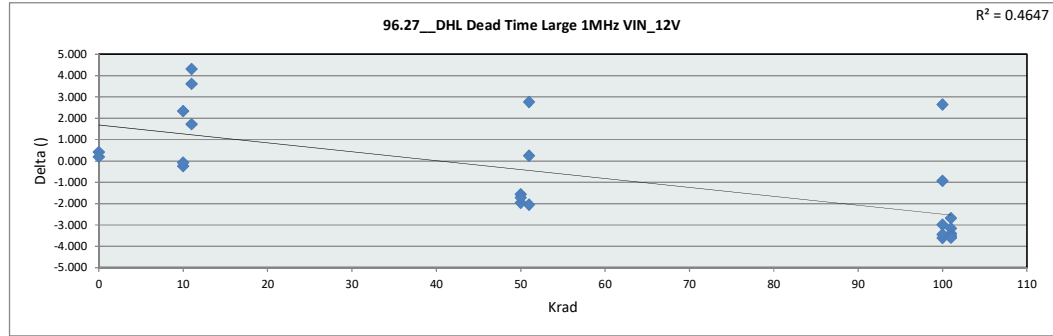

96.27 DHL Dead Time Large	
Test Site	DAL
Tester	ETS364
Test Number	EB672303
Max Limit	61
Min Limit	44

Krad	0	10	11	50	51	100	101
LL	44.000	44.000	44.000	44.000	44.000	44.000	44.000
Min	51.283	50.474	49.611	47.186	47.950	45.190	47.538
Average	51.800	50.628	50.780	48.606	49.324	47.453	47.980
Max	52.318	50.813	51.825	49.810	50.295	48.752	48.640
UL	61.000	61.000	61.000	61.000	61.000	61.000	61.000

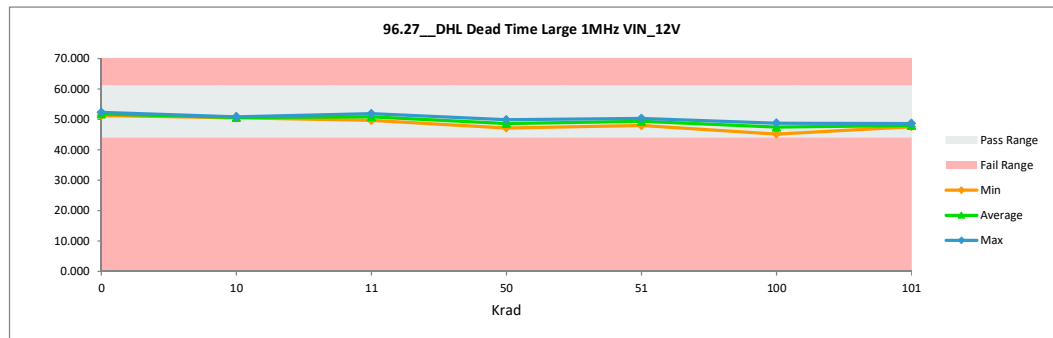

TID "HDR" Report
5962R2220102VXC

96.28 DHL Dead Time Max 1MHz		
Test Site	DAL	DAL
Tester	ETS364	ETS364
Test Number	EB672303	EB672303
Unit		
Max Limit	125	125
Min Limit	86	86

Krad	Serial #	Pre_HDR_6013	Post_HDR_6013	Delta
0	1	100.161	100.231	0.070
0	2	104.004	104.224	0.220
10	182	100.343	99.900	-0.443
10	202	100.449	99.480	-0.970
10	204	95.043	98.464	3.421
11	418	93.661	99.892	6.231
11	419	94.286	97.385	3.099
11	443	93.287	102.054	8.767
50	259	96.185	91.534	-4.651
50	346	98.238	94.127	-4.111
50	347	101.299	97.159	-4.140
51	462	92.892	98.517	5.626
51	478	94.228	94.043	-0.185
51	503	102.187	98.297	-3.890
100	354	100.361	93.110	-7.251
100	363	95.719	86.910	-8.810
100	366	102.812	94.936	-7.876
100	383	91.190	94.524	3.335
100	417	94.104	91.563	-2.541
101	513	99.240	92.521	-6.719
101	526	102.362	94.647	-7.715
101	532	100.952	93.448	-7.503
101	533	101.437	94.655	-6.783
101	534	100.857	93.368	-7.488
Max		104.004	104.224	8.767
Average		98.137	96.041	-2.096
Min		91.190	86.910	-8.810
Std Dev		3.800	3.934	5.142

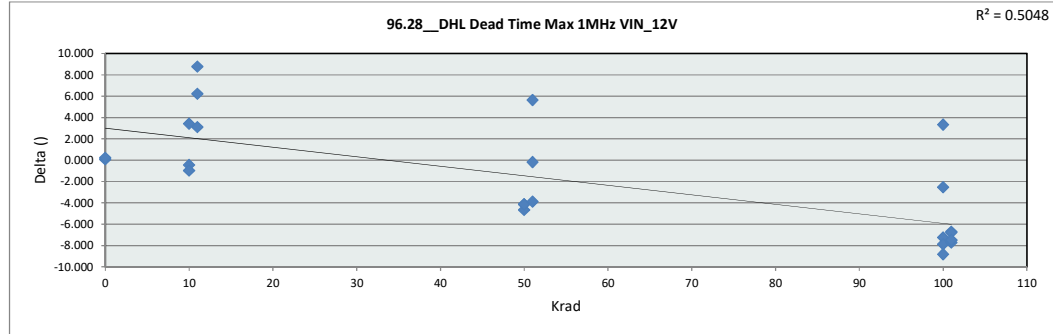

96.28 DHL Dead Time Max 1MHz	
Test Site	DAL
Tester	ETS364
Test Number	EB672303
Max Limit	125
Min Limit	86

Krad	0	10	11	50	51	100	101
LL	86.000	86.000	86.000	86.000	86.000	86.000	86.000
Min	100.231	98.464	97.385	91.534	94.043	86.910	92.521
Average	102.228	99.281	99.777	94.274	96.953	92.209	93.728
Max	104.224	99.900	102.054	97.159	98.517	94.936	94.655
UL	125.000	125.000	125.000	125.000	125.000	125.000	125.000

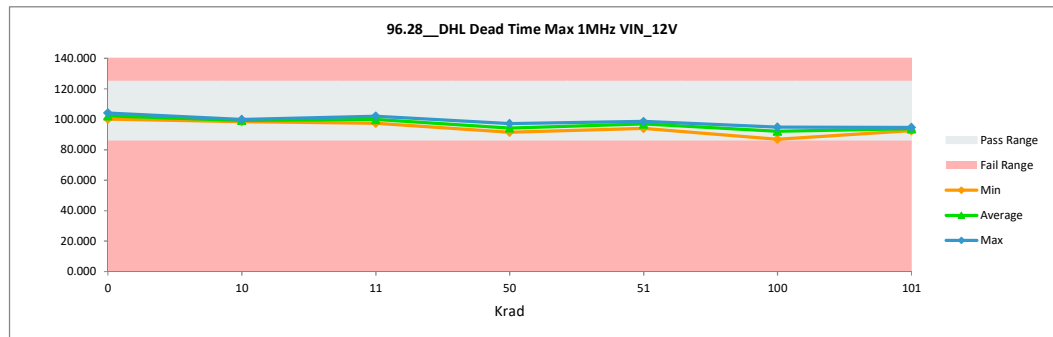

TID "HDR" Report
5962R2220102VXC

96.29 DHL Dead Time Min 2MH		
Test Site	DAL	DAL
Tester	ETS364	ETS364
Test Number	EB672303	EB672303
Unit		
Max Limit	10	10
Min Limit	0	0

Krad	Serial #	Pre_HDR_6013	Post_HDR_6013	Delta
0	1	4.931	4.923	-0.008
0	2	3.877	4.060	0.183
10	182	4.223	4.452	0.229
10	202	4.705	5.062	0.358
10	204	4.359	5.378	1.018
11	418	4.029	4.907	0.878
11	419	4.429	4.868	0.439
11	443	4.140	4.538	0.398
50	259	4.914	4.993	0.079
50	346	5.628	5.879	0.252
50	347	4.753	4.774	0.021
51	462	4.611	4.531	-0.080
51	478	3.974	4.751	0.777
51	503	4.629	4.373	-0.256
100	354	4.375	4.915	0.540
100	363	5.008	5.780	0.772
100	366	4.811	5.073	0.262
100	383	2.947	4.679	1.732
100	417	4.344	5.174	0.830
101	513	4.656	5.039	0.383
101	526	4.179	4.654	0.474
101	532	4.605	4.710	0.105
101	533	4.900	5.131	0.231
101	534	5.055	4.992	-0.063
Max		5.628	5.879	1.732
Average		4.503	4.901	0.398
Min		2.947	4.060	-0.256
Std Dev		0.523	0.407	0.437

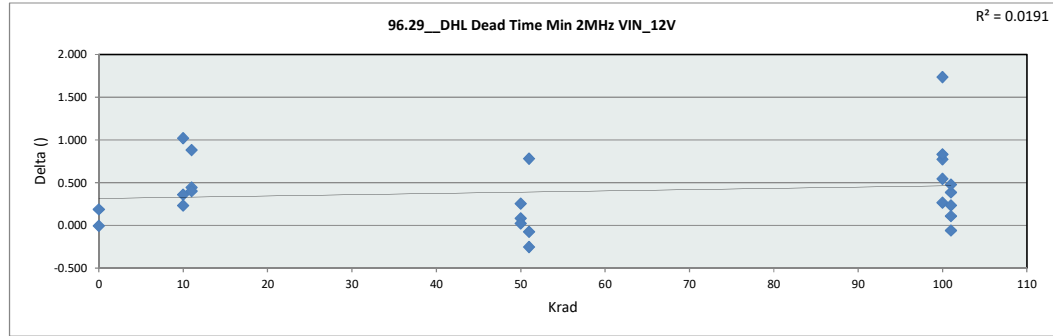

96.29 DHL Dead Time Min 2M	
Test Site	DAL
Tester	ETS364
Test Number	EB672303
Max Limit	10
Min Limit	0

Krad	0	10	11	50	51	100	101
LL	0.000	0.000	0.000	0.000	0.000	0.000	0.000
Min	4.060	4.452	4.538	4.774	4.373	4.679	4.654
Average	4.491	4.964	4.771	5.215	4.552	5.124	4.905
Max	4.923	5.378	4.907	5.879	4.751	5.780	5.131
UL	10.000	10.000	10.000	10.000	10.000	10.000	10.000

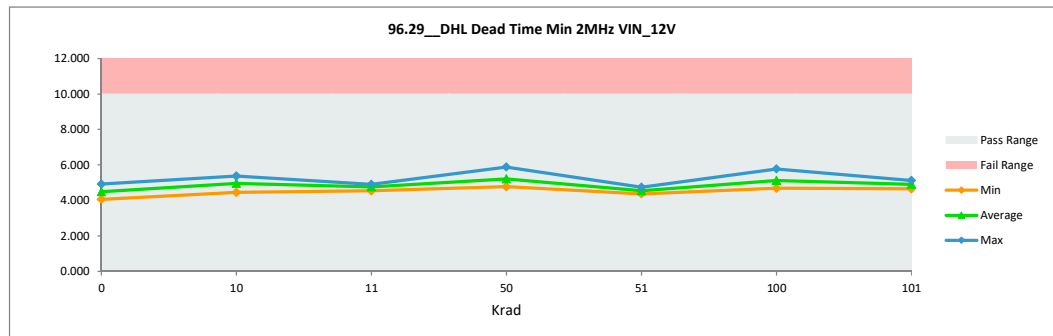

TID "HDR" Report
5962R2220102VXC

96.30 DHL Dead Time Small 2M		
Test Site	DAL	DAL
Tester	ETS364	ETS364
Test Number	EB672303	EB672303
Unit		
Max Limit	15	15
Min Limit	6	6

Krad	Serial #	Pre_HDR_6013	Post_HDR_6013	Delta
0	1	10.329	10.476	0.147
0	2	9.709	9.837	0.128
10	182	9.837	9.990	0.153
10	202	10.210	10.388	0.178
10	204	9.275	10.569	1.294
11	418	9.066	10.242	1.176
11	419	9.471	10.004	0.533
11	443	8.980	10.235	1.255
50	259	10.253	9.991	-0.263
50	346	10.773	10.712	-0.062
50	347	10.118	10.045	-0.073
51	462	9.355	10.104	0.749
51	478	9.007	9.598	0.592
51	503	10.170	9.891	-0.279
100	354	9.969	10.098	0.129
100	363	10.048	10.098	0.050
100	366	10.288	10.154	-0.134
100	383	8.184	9.866	1.682
100	417	9.329	10.050	0.722
101	513	9.971	9.944	-0.027
101	526	9.861	9.747	-0.114
101	532	10.120	9.732	-0.389
101	533	10.179	10.182	0.003
101	534	10.399	9.944	-0.454
Max		10.773	10.712	1.682
Average		9.788	10.079	0.291
Min		8.184	9.598	-0.454
Std Dev		0.592	0.266	0.582

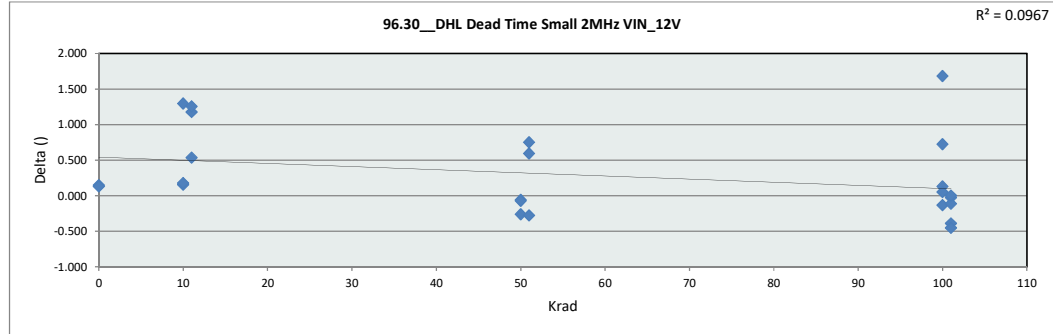

96.30 DHL Dead Time Small	
Test Site	DAL
Tester	ETS364
Test Number	EB672303
Max Limit	15
Min Limit	6

Krad	0	10	11	50	51	100	101
LL	6.000	6.000	6.000	6.000	6.000	6.000	6.000
Min	9.837	9.990	10.004	9.991	9.598	9.866	9.732
Average	10.156	10.316	10.160	10.249	9.864	10.053	9.910
Max	10.476	10.569	10.242	10.712	10.104	10.154	10.182
UL	15.000	15.000	15.000	15.000	15.000	15.000	15.000

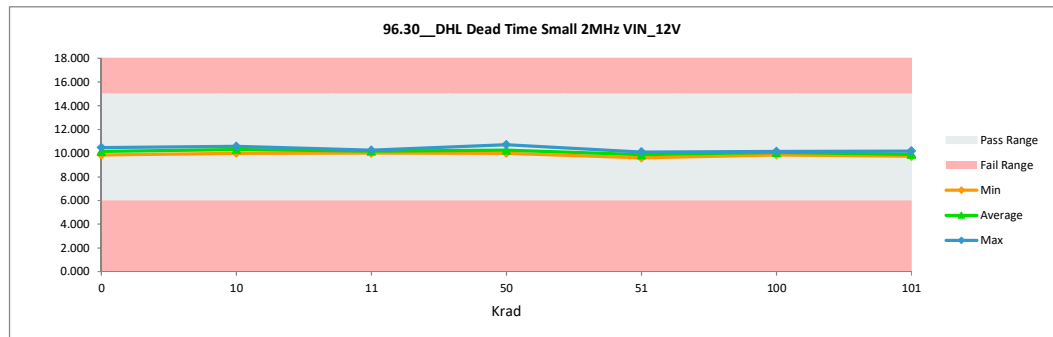

TID "HDR" Report
5962R2220102VXC

96.31 DHL Dead Time Mid 2MH		
Test Site	DAL	DAL
Tester	ETS364	ETS364
Test Number	EB672303	EB672303
Unit		
Max Limit	24.5	24.5
Min Limit	16	16

Krad	Serial #	Pre_HDR_6013	Post_HDR_6013	Delta
0	1	20.246	20.686	0.440
0	2	20.197	20.270	0.073
10	182	20.083	19.906	-0.177
10	202	20.436	20.293	-0.143
10	204	18.909	20.538	1.629
11	418	18.593	20.413	1.820
11	419	18.991	19.685	0.694
11	443	18.442	20.471	2.029
50	259	19.892	19.249	-0.643
50	346	20.524	20.205	-0.319
50	347	20.557	19.992	-0.565
51	462	18.994	20.198	1.204
51	478	18.522	19.023	0.501
51	503	20.476	19.927	-0.548
100	354	20.059	19.446	-0.613
100	363	19.669	18.859	-0.810
100	366	20.682	19.773	-0.909
100	383	17.494	19.413	1.919
100	417	18.934	19.258	0.324
101	513	20.028	19.450	-0.578
101	526	20.241	19.308	-0.933
101	532	20.067	19.026	-1.041
101	533	20.434	19.745	-0.689
101	534	20.548	19.348	-1.200
Max		20.682	20.686	2.029
Average		19.709	19.770	0.061
Min		17.494	18.859	-1.200
Std Dev		0.871	0.533	1.009

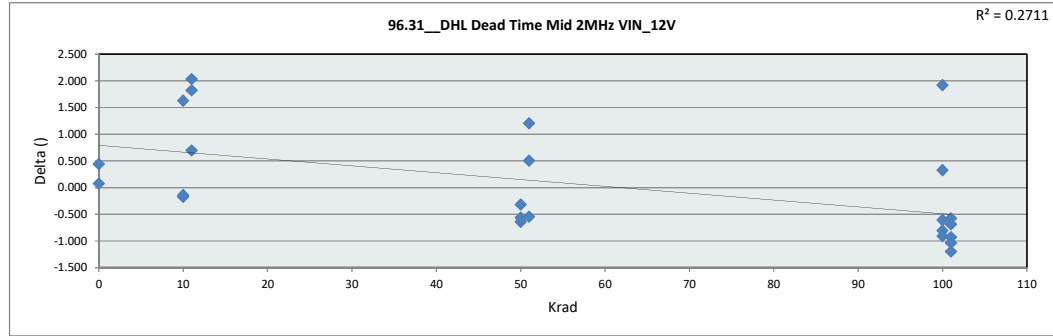

96.31 DHL Dead Time Mid 2M	
Test Site	DAL
Tester	ETS364
Test Number	EB672303
Max Limit	24.5
Min Limit	16

Krad	0	10	11	50	51	100	101
LL	16.000	16.000	16.000	16.000	16.000	16.000	16.000
Min	20.270	19.906	19.685	19.249	19.023	18.859	19.026
Average	20.478	20.246	20.190	19.815	19.716	19.350	19.375
Max	20.686	20.538	20.471	20.205	20.198	19.773	19.745
UL	24.500	24.500	24.500	24.500	24.500	24.500	24.500

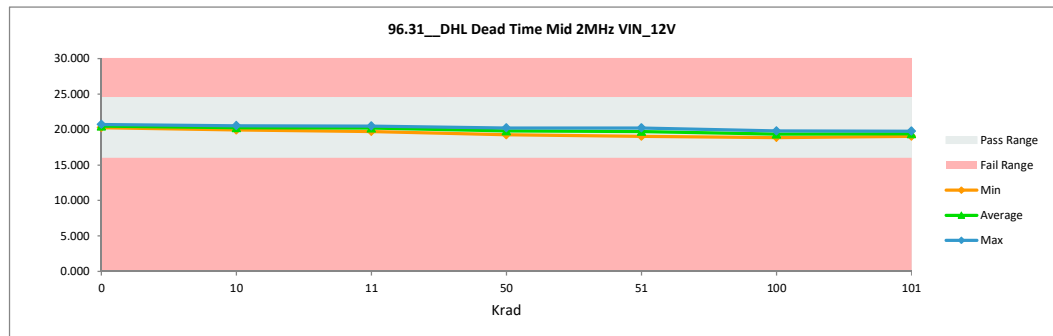

TID "HDR" Report
5962R2220102VXC

96.32 DHL Dead Time Large 2M		
Test Site	DAL	DAL
Tester	ETS364	ETS364
Test Number	EB672303	EB672303
Unit		
Max Limit	61	61
Min Limit	44	44

Krad	Serial #	Pre_HDR_6013	Post_HDR_6013	Delta
0	1	51.750	51.887	0.138
0	2	52.956	53.189	0.234
10	182	51.440	51.150	-0.290
10	202	51.694	51.233	-0.461
10	204	48.746	51.210	2.464
11	418	48.107	51.558	3.451
11	419	48.443	50.090	1.647
11	443	47.995	52.592	4.597
50	259	49.555	47.574	-1.981
50	346	50.880	49.285	-1.595
50	347	52.457	50.549	-1.908
51	462	48.263	50.798	2.535
51	478	48.174	48.462	0.288
51	503	52.432	50.543	-1.889
100	354	51.617	48.511	-3.106
100	363	49.444	45.812	-3.632
100	366	52.993	49.327	-3.666
100	383	46.460	49.169	2.708
100	417	48.488	47.530	-0.957
101	513	51.216	48.259	-2.957
101	526	52.333	48.916	-3.417
101	532	51.649	48.234	-3.415
101	533	52.059	49.330	-2.729
101	534	52.019	48.425	-3.593
Max		52.993	53.189	4.597
Average		50.465	49.735	-0.731
Min		46.460	45.812	-3.666
Std Dev		1.946	1.779	2.524

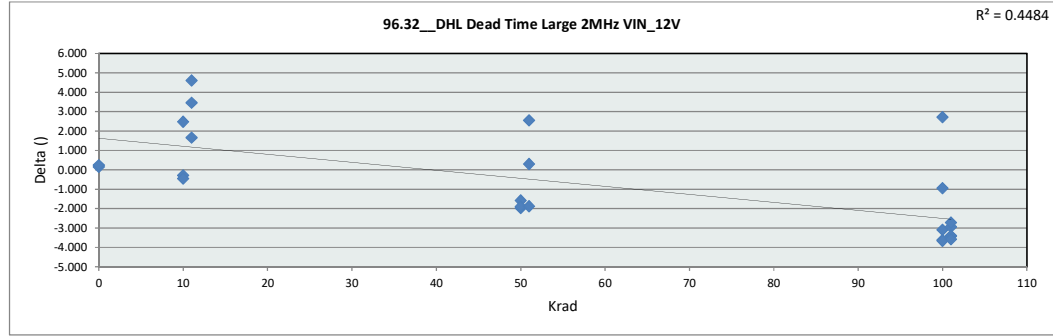

96.32 DHL Dead Time Large	
Test Site	DAL
Tester	ETS364
Test Number	EB672303
Max Limit	61
Min Limit	44

Krad	0	10	11	50	51	100	101
LL	44.000	44.000	44.000	44.000	44.000	44.000	44.000
Min	51.887	51.150	50.090	47.574	48.462	45.812	48.234
Average	52.538	51.198	51.413	49.136	49.934	48.070	48.633
Max	53.189	51.233	52.592	50.550	50.798	49.327	49.330
UL	61.000	61.000	61.000	61.000	61.000	61.000	61.000

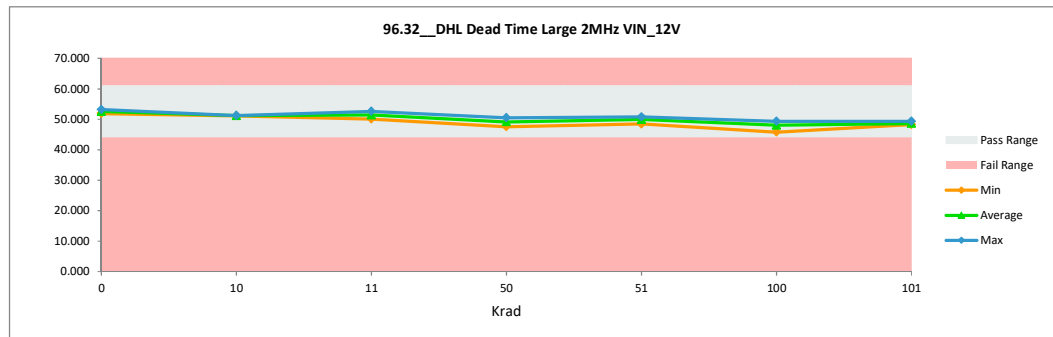

TID "HDR" Report
5962R2220102VXC

96.33 DHL Dead Time Max 2MHz		
Test Site	DAL	DAL
Tester	ETS364	ETS364
Test Number	EB672303	EB672303
Unit		
Max Limit	125	125
Min Limit	86	86

Krad	Serial #	Pre_HDR_6013	Post_HDR_6013	Delta
0	1	103.268	103.523	0.255
0	2	107.410	107.799	0.389
10	182	103.653	103.052	-0.601
10	202	103.467	102.747	-0.720
10	204	98.101	101.827	3.726
11	418	96.545	102.999	6.453
11	419	97.134	100.430	3.296
11	443	96.401	105.382	8.981
50	259	98.913	94.353	-4.561
50	346	101.158	96.980	-4.177
50	347	104.668	100.347	-4.320
51	462	95.953	101.534	5.581
51	478	97.189	96.887	-0.302
51	503	105.661	101.474	-4.187
100	354	103.518	96.085	-7.432
100	363	98.628	89.433	-9.196
100	366	106.183	98.030	-8.153
100	383	94.203	97.655	3.452
100	417	97.040	94.414	-2.626
101	513	102.213	95.451	-6.762
101	526	105.692	97.647	-8.045
101	532	104.408	96.271	-8.137
101	533	104.758	97.737	-7.021
101	534	103.987	96.318	-7.669
Max		107.410	107.799	8.981
Average		101.256	99.099	-2.157
Min		94.203	89.433	-9.196
Std Dev		3.959	4.138	5.324

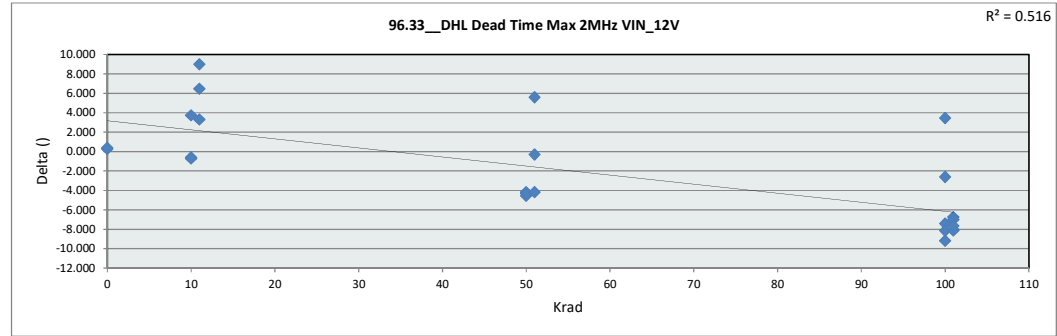

96.33 DHL Dead Time Max 2MHz	
Test Site	DAL
Tester	ETS364
Test Number	EB672303
Max Limit	125
Min Limit	86

Krad	0	10	11	50	51	100	101
LL	86.000	86.000	86.000	86.000	86.000	86.000	86.000
Min	103.523	101.828	100.430	94.353	96.887	89.433	95.451
Average	105.661	102.542	102.937	97.227	99.965	95.123	96.685
Max	107.799	103.052	105.382	100.347	101.534	98.030	97.737
UL	125.000	125.000	125.000	125.000	125.000	125.000	125.000

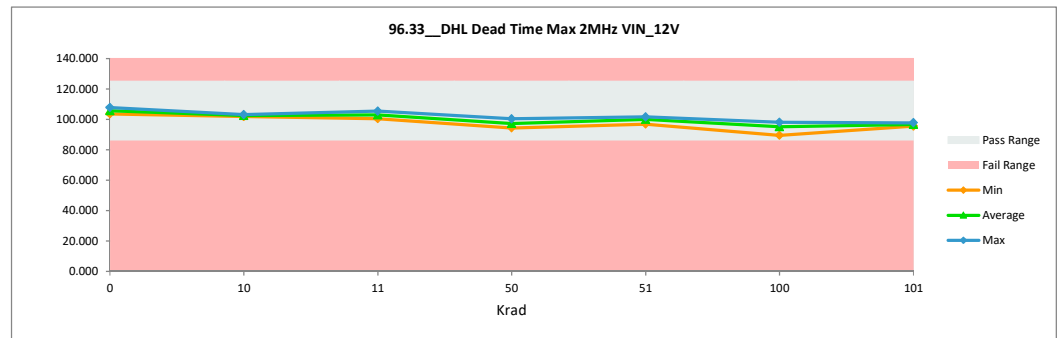

TID "HDR" Report
5962R2220102VXC

97.0 DLH Dead Time Min 500k		
Test Site	DAL	DAL
Tester	ETS364	ETS364
Test Number	EB672303	EB672303
Unit		
Max Limit	10	10
Min Limit	0	0

Krad	Serial #	Pre_HDR_6013	Post_HDR_6013	Delta
0	1	4.158	4.050	-0.108
0	2	4.211	4.051	-0.159
10	182	4.094	4.201	0.108
10	202	3.772	3.443	-0.329
10	204	4.017	3.786	-0.232
11	418	4.452	4.375	-0.077
11	419	3.996	4.098	0.102
11	443	3.588	4.622	1.034
50	259	4.527	4.765	0.238
50	346	3.658	3.648	-0.010
50	347	3.367	3.384	0.017
51	462	3.764	3.916	0.151
51	478	4.070	3.711	-0.359
51	503	4.681	4.998	0.317
100	354	4.406	4.573	0.166
100	363	3.679	3.634	-0.044
100	366	4.753	4.741	-0.011
100	383	4.766	4.620	-0.147
100	417	3.536	4.232	0.695
101	513	4.261	4.422	0.162
101	526	4.226	4.601	0.375
101	532	4.082	4.718	0.636
101	533	3.632	4.067	0.436
101	534	4.545	4.807	0.262
Max		4.766	4.998	1.034
Average		4.093	4.228	0.134
Min		3.367	3.384	-0.359
Std Dev		0.407	0.468	0.332

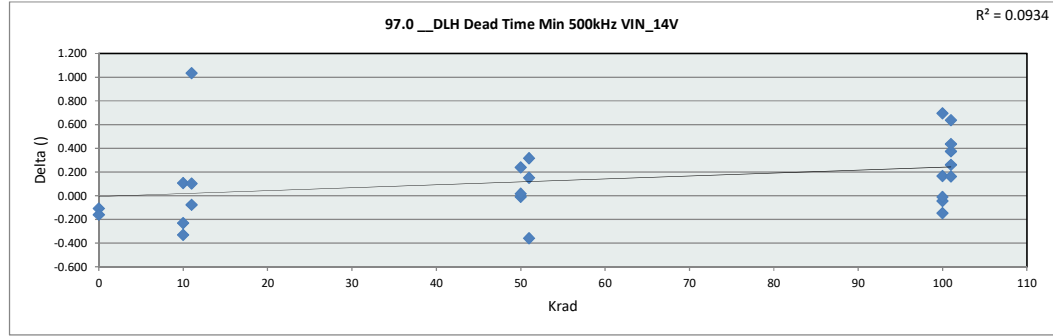

97.0 DLH Dead Time Min 500k	
Test Site	DAL
Tester	ETS364
Test Number	EB672303
Max Limit	10
Min Limit	0

Krad	0	10	11	50	51	100	101
LL	0.000	0.000	0.000	0.000	0.000	0.000	0.000
Min	4.050	3.443	4.098	3.384	3.711	3.634	4.067
Average	4.051	3.810	4.365	3.933	4.208	4.360	4.523
Max	4.051	4.202	4.622	4.765	4.998	4.741	4.807
UL	10.000	10.000	10.000	10.000	10.000	10.000	10.000

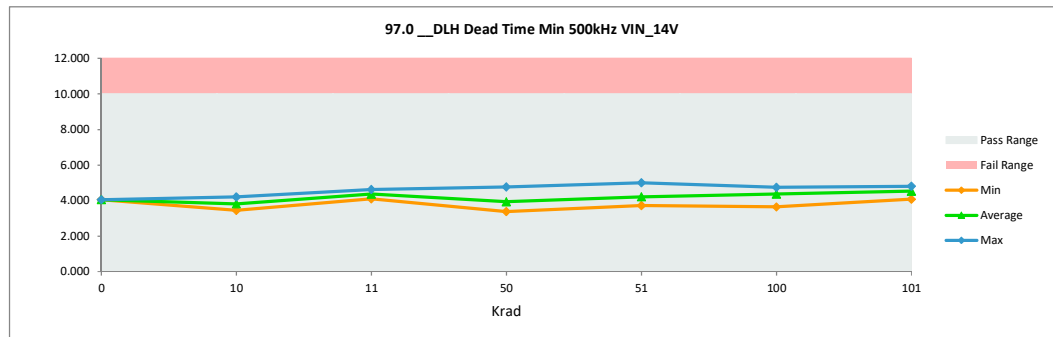

TID "HDR" Report
5962R2220102VXC

97.1 DLH Dead Time Small 500		
Test Site	DAL	DAL
Tester	ETS364	ETS364
Test Number	EB672303	EB672303
Unit		
Max Limit	15.5	15.5
Min Limit	8	8

Krad	Serial #	Pre_HDR_6013	Post_HDR_6013	Delta
0	1	11.396	11.300	-0.096
0	2	10.954	11.018	0.063
10	182	11.406	11.414	0.008
10	202	11.184	10.945	-0.239
10	204	11.548	11.350	-0.199
11	418	11.831	11.288	-0.543
11	419	11.356	11.382	0.027
11	443	11.083	11.784	0.701
50	259	11.284	11.233	-0.051
50	346	10.919	10.613	-0.307
50	347	10.839	10.528	-0.311
51	462	11.394	10.353	-1.041
51	478	11.590	10.640	-0.950
51	503	11.892	11.675	-0.217
100	354	11.845	11.048	-0.797
100	363	11.194	10.298	-0.896
100	366	11.563	10.731	-0.832
100	383	12.347	10.989	-1.358
100	417	10.867	10.554	-0.312
101	513	11.436	10.607	-0.829
101	526	11.542	10.750	-0.792
101	532	11.488	10.862	-0.626
101	533	10.760	10.381	-0.380
101	534	11.327	10.603	-0.724
Max		12.347	11.784	0.701
Average		11.377	10.931	-0.446
Min		10.760	10.298	-1.358
Std Dev		0.377	0.422	0.457

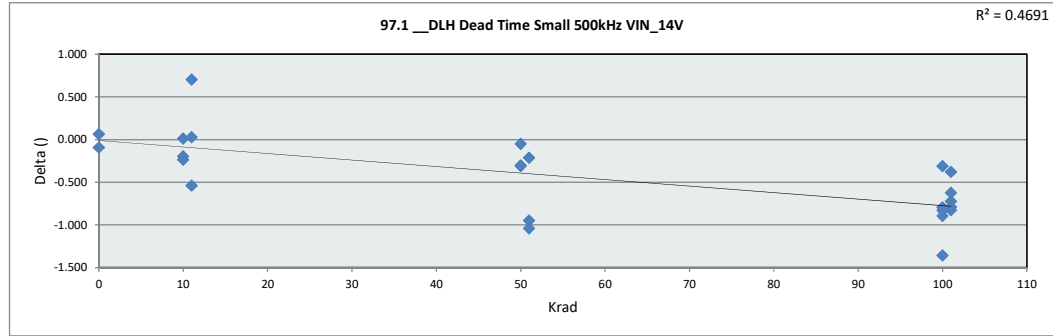

97.1 DLH Dead Time Small 5	
Test Site	DAL
Tester	ETS364
Test Number	EB672303
Max Limit	15.5
Min Limit	8

Krad	0	10	11	50	51	100	101
LL	8.000	8.000	8.000	8.000	8.000	8.000	8.000
Min	11.018	10.945	11.288	10.528	10.353	10.298	10.381
Average	11.159	11.236	11.485	10.791	10.889	10.724	10.640
Max	11.300	11.414	11.784	11.233	11.675	11.048	10.862
UL	15.500	15.500	15.500	15.500	15.500	15.500	15.500

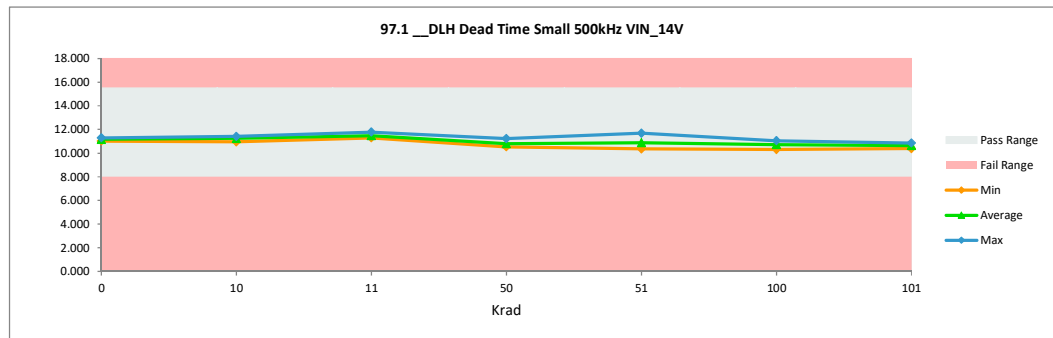

TID "HDR" Report
5962R2220102VXC

97.2 DLH Dead Time Mid 500k		
Test Site	DAL	DAL
Tester	ETS364	ETS364
Test Number	EB672303	EB672303
Unit		
Max Limit	24	24
Min Limit	15.5	15.5

Krad	Serial #	Pre_HDR_6013	Post_HDR_6013	Delta
0	1	20.011	20.106	0.095
0	2	19.230	19.152	-0.079
10	182	20.130	20.012	-0.119
10	202	19.936	19.526	-0.410
10	204	20.377	20.287	-0.090
11	418	20.264	19.855	-0.409
11	419	19.993	19.851	-0.142
11	443	19.729	20.057	0.329
50	259	19.420	19.014	-0.406
50	346	19.566	18.886	-0.680
50	347	20.037	19.157	-0.880
51	462	20.274	18.699	-1.575
51	478	20.456	19.181	-1.275
51	503	20.313	19.754	-0.559
100	354	20.344	19.161	-1.183
100	363	19.935	18.317	-1.618
100	366	19.500	18.089	-1.411
100	383	20.815	18.817	-1.998
100	417	19.629	18.506	-1.123
101	513	19.965	18.366	-1.599
101	526	20.445	18.752	-1.693
101	532	19.951	18.666	-1.285
101	533	19.466	18.332	-1.134
101	534	19.278	18.230	-1.047
Max		20.815	20.287	0.329
Average		19.961	19.116	-0.845
Min		19.230	18.089	-1.998
Std Dev		0.415	0.672	0.656

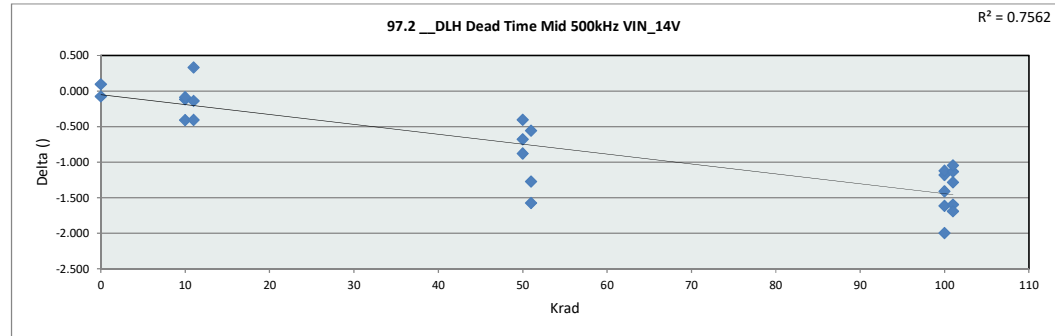

97.2 DLH Dead Time Mid 500k	
Test Site	DAL
Tester	ETS364
Test Number	EB672303
Max Limit	24
Min Limit	15.5

Krad	0	10	11	50	51	100	101
LL	15.500	15.500	15.500	15.500	15.500	15.500	15.500
Min	19.152	19.526	19.851	18.886	18.699	18.089	18.231
Average	19.629	19.942	19.921	19.019	19.211	18.578	18.470
Max	20.106	20.287	20.057	19.157	19.754	19.161	18.752
UL	24.000	24.000	24.000	24.000	24.000	24.000	24.000

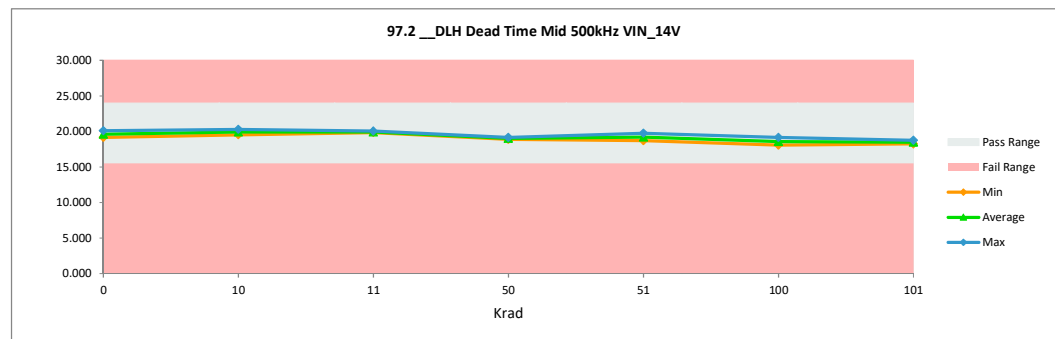

TID "HDR" Report
5962R2220102VXC

97.3 DLH Dead Time Large 500kHz VIN_14V		
Test Site	DAL	DAL
Tester	ETS364	ETS364
Test Number	EB672303	EB672303
Unit		
Max Limit	59	59
Min Limit	36	36

Krad	Serial #	Pre_HDR_6013	Post_HDR_6013	Delta
0	1	48.221	48.326	0.105
0	2	46.120	46.213	0.093
10	182	48.398	47.824	-0.574
10	202	48.459	47.903	-0.556
10	204	49.224	49.139	-0.084
11	418	48.767	47.756	-1.011
11	419	48.701	48.253	-0.448
11	443	48.319	47.836	-0.483
50	259	45.875	44.406	-1.469
50	346	47.756	46.257	-1.499
50	347	49.384	47.686	-1.698
51	462	49.520	45.690	-3.830
51	478	49.792	47.040	-2.752
51	503	48.800	46.604	-2.196
100	354	49.124	45.946	-3.178
100	363	48.511	45.257	-3.254
100	366	46.231	43.245	-2.986
100	383	49.466	45.005	-4.462
100	417	47.948	45.488	-2.460
101	513	48.334	44.359	-3.975
101	526	48.760	45.189	-3.570
101	532	48.044	44.518	-3.527
101	533	48.484	45.020	-3.464
101	534	46.252	43.032	-3.220
	Max	49.792	49.139	0.105
	Average	48.270	46.166	-2.104
	Min	45.875	43.032	-4.462
	Std Dev	1.110	1.679	1.462

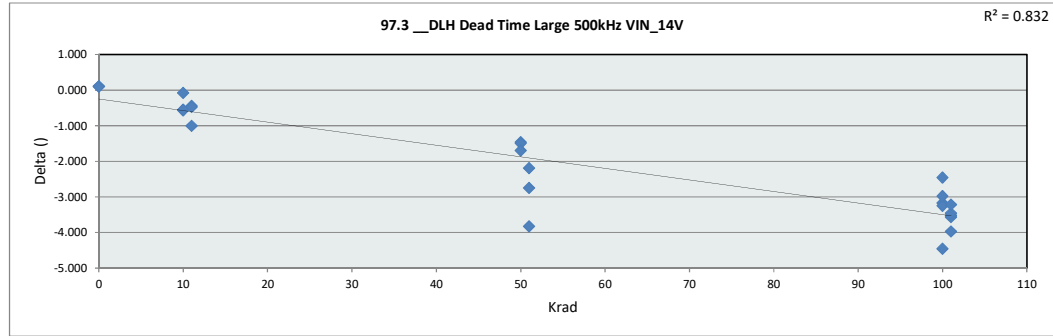

97.3 DLH Dead Time Large 500kHz VIN_14V	
Test Site	DAL
Tester	ETS364
Test Number	EB672303
Max Limit	59
Min Limit	36

	0	10	11	50	51	100	101
LL	36.000	36.000	36.000	36.000	36.000	36.000	36.000
Min	46.213	47.824	47.756	44.406	45.690	43.245	43.032
Average	47.269	48.289	47.949	46.117	46.445	44.988	44.424
Max	48.326	49.139	48.253	47.686	47.040	45.946	45.189
UL	59.000	59.000	59.000	59.000	59.000	59.000	59.000

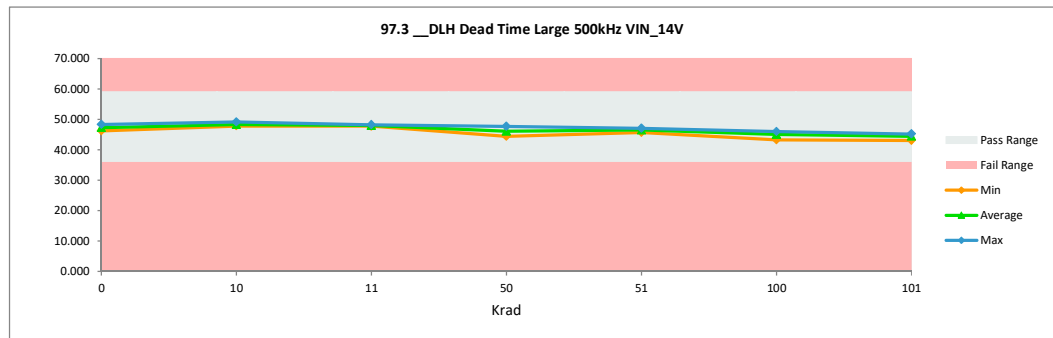

TID "HDR" Report
5962R2220102VXC

97.4 DLH Dead Time Max 500kHz		
Test Site	DAL	DAL
Tester	ETS364	ETS364
Test Number	EB672303	EB672303
Unit		
Max Limit	113.5	113.5
Min Limit	74	74

Krad	Serial #	Pre_HDR_6013	Post_HDR_6013	Delta
0	1	93.498	93.631	0.132
0	2	89.210	89.174	-0.037
10	182	93.306	92.756	-0.549
10	202	93.835	92.866	-0.969
10	204	95.642	95.218	-0.424
11	418	94.106	92.601	-1.506
11	419	94.423	93.877	-0.546
11	443	93.562	91.604	-1.958
50	259	87.926	84.631	-3.295
50	346	92.377	88.452	-3.925
50	347	96.773	93.201	-3.572
51	462	97.021	88.727	-8.295
51	478	97.096	91.435	-5.661
51	503	94.430	89.685	-4.745
100	354	95.319	87.954	-7.365
100	363	94.080	87.963	-6.118
100	366	88.696	82.785	-5.911
100	383	94.963	86.433	-8.530
100	417	93.439	88.330	-5.109
101	513	93.923	85.588	-8.336
101	526	93.792	86.683	-7.109
101	532	93.118	85.641	-7.477
101	533	95.028	87.428	-7.600
101	534	88.605	81.914	-6.691
	Max	97.096	95.218	0.132
	Average	93.507	89.107	-4.400
	Min	87.926	81.914	-8.530
	Std Dev	2.547	3.640	3.019

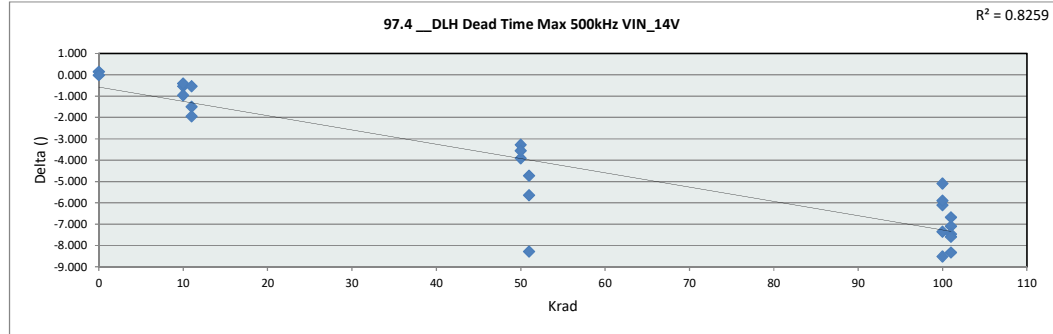

97.4 DLH Dead Time Max 50	
Test Site	DAL
Tester	ETS364
Test Number	EB672303
Max Limit	113.5
Min Limit	74

Krad	0	10	11	50	51	100	101
LL	74.000	74.000	74.000	74.000	74.000	74.000	74.000
Min	89.174	92.756	91.604	84.631	88.727	82.785	81.914
Average	91.402	93.613	92.694	88.761	89.949	86.693	85.451
Max	93.631	95.219	93.877	93.201	91.435	88.330	87.428
UL	113.500	113.500	113.500	113.500	113.500	113.500	113.500

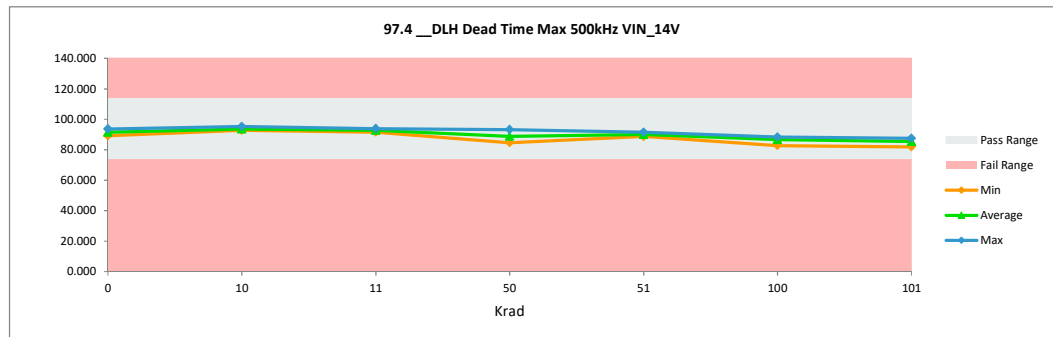

TID "HDR" Report
5962R2220102VXC

97.5 DLH Dead Time Min 1MHz		
Test Site	DAL	DAL
Tester	ETS364	ETS364
Test Number	EB672303	EB672303
Unit		
Max Limit	10	10
Min Limit	0	0

Krad	Serial #	Pre_HDR_6013	Post_HDR_6013	Delta
0	1	4.262	4.272	0.010
0	2	4.269	4.299	0.030
10	182	4.319	4.271	-0.048
10	202	4.028	3.663	-0.364
10	204	4.034	3.810	-0.224
11	418	4.400	4.463	0.064
11	419	3.963	4.212	0.248
11	443	3.630	4.737	1.108
50	259	4.694	4.865	0.171
50	346	3.829	3.974	0.145
50	347	3.454	3.661	0.207
51	462	4.067	3.923	-0.144
51	478	4.095	3.762	-0.333
51	503	4.622	5.118	0.496
100	354	4.455	4.655	0.200
100	363	3.912	3.937	0.025
100	366	4.939	4.943	0.004
100	383	4.866	4.706	-0.161
100	417	3.562	4.415	0.853
101	513	4.341	4.529	0.188
101	526	4.299	4.603	0.304
101	532	4.228	4.838	0.610
101	533	3.749	4.033	0.284
101	534	4.605	5.061	0.456
Max		4.939	5.118	1.108
Average		4.193	4.365	0.172
Min		3.454	3.661	-0.364
Std Dev		0.395	0.449	0.350

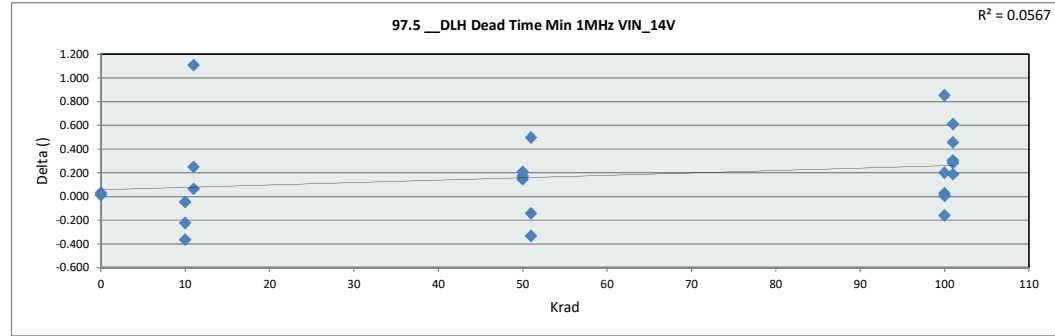

97.5 DLH Dead Time Min 1M	
Test Site	DAL
Tester	ETS364
Test Number	EB672303
Max Limit	10
Min Limit	0

Krad	0	10	11	50	51	100	101
LL	0.000	0.000	0.000	0.000	0.000	0.000	0.000
Min	4.272	3.663	4.212	3.661	3.762	3.937	4.033
Average	4.286	3.915	4.471	4.167	4.268	4.531	4.613
Max	4.299	4.271	4.737	4.865	5.118	4.943	5.061
UL	10.000	10.000	10.000	10.000	10.000	10.000	10.000

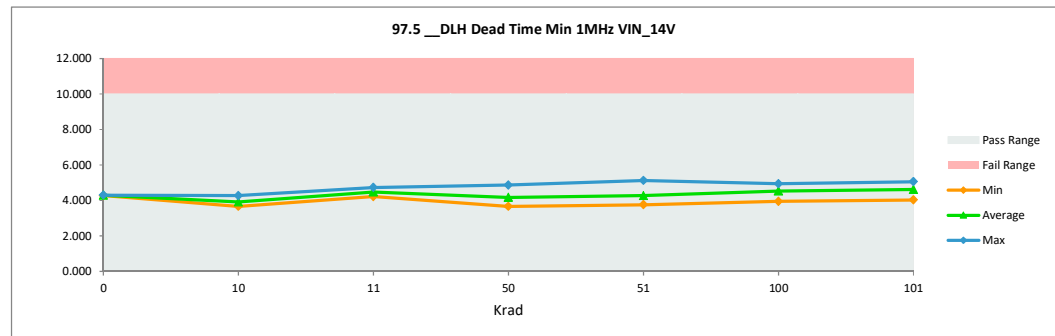

TID "HDR" Report
5962R2220102VXC

97.6 DLH Dead Time Small 1M		
Test Site	DAL	DAL
Tester	ETS364	ETS364
Test Number	EB672303	EB672303
Unit		
Max Limit	15.5	15.5
Min Limit	8	8

Krad	Serial #	Pre_HDR_6013	Post_HDR_6013	Delta
0	1	11.351	11.285	-0.066
0	2	10.901	10.849	-0.052
10	182	11.476	11.315	-0.161
10	202	11.088	10.813	-0.276
10	204	11.481	11.276	-0.205
11	418	11.697	11.199	-0.498
11	419	11.321	11.137	-0.184
11	443	10.900	11.578	0.678
50	259	11.217	11.248	0.031
50	346	10.826	10.515	-0.311
50	347	10.866	10.363	-0.502
51	462	11.383	10.343	-1.040
51	478	11.572	10.659	-0.913
51	503	11.794	11.590	-0.204
100	354	11.672	10.971	-0.701
100	363	10.997	10.195	-0.801
100	366	11.469	10.848	-0.620
100	383	12.263	10.959	-1.304
100	417	10.729	10.525	-0.204
101	513	11.377	10.441	-0.936
101	526	11.538	10.642	-0.896
101	532	11.282	10.753	-0.528
101	533	10.808	10.262	-0.546
101	534	11.321	10.702	-0.619
	Max	12.263	11.590	0.678
	Average	11.305	10.853	-0.452
	Min	10.729	10.195	-1.304
	Std Dev	0.370	0.408	0.427

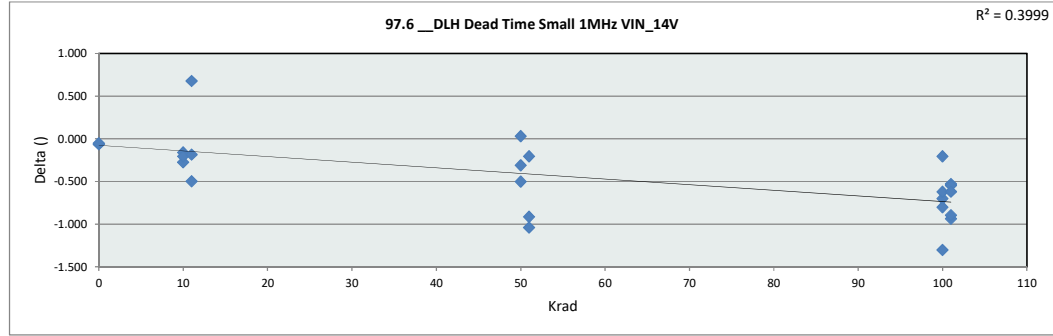

97.6 DLH Dead Time Small 1	
Test Site	DAL
Tester	ETS364
Test Number	EB672303
Max Limit	15.5
Min Limit	8

Krad	0	10	11	50	51	100	101
LL	8.000	8.000	8.000	8.000	8.000	8.000	8.000
Min	10.849	10.813	11.138	10.363	10.343	10.195	10.262
Average	11.067	11.135	11.305	10.709	10.864	10.700	10.560
Max	11.285	11.315	11.578	11.249	11.590	10.971	10.753
UL	15.500	15.500	15.500	15.500	15.500	15.500	15.500

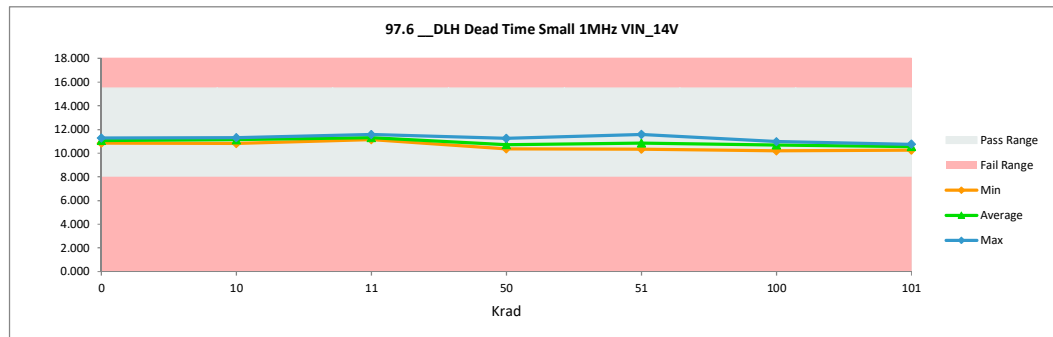

TID "HDR" Report
5962R2220102VXC

97.7 DLH Dead Time Mid 1MHz		
Test Site	DAL	DAL
Tester	ETS364	ETS364
Test Number	EB672303	EB672303
Unit		
Max Limit	24	24
Min Limit	15.5	15.5

Krad	Serial #	Pre_HDR_6013	Post_HDR_6013	Delta
0	1	19.556	19.555	-0.001
0	2	18.748	18.689	-0.059
10	182	19.795	19.563	-0.233
10	202	19.487	19.172	-0.315
10	204	19.960	19.775	-0.185
11	418	20.018	19.625	-0.392
11	419	19.688	19.646	-0.042
11	443	19.254	19.756	0.502
50	259	18.874	18.678	-0.196
50	346	19.115	18.577	-0.538
50	347	19.454	18.638	-0.817
51	462	20.035	18.289	-1.745
51	478	20.090	18.763	-1.327
51	503	20.035	19.304	-0.731
100	354	20.002	18.742	-1.260
100	363	19.427	18.041	-1.386
100	366	19.133	17.994	-1.139
100	383	20.340	18.625	-1.714
100	417	19.140	18.174	-0.966
101	513	19.727	17.881	-1.846
101	526	19.983	18.400	-1.584
101	532	19.588	18.302	-1.285
101	533	19.094	17.807	-1.287
101	534	18.925	17.796	-1.129
	Max	20.340	19.775	0.502
	Average	19.561	18.741	-0.820
	Min	18.748	17.796	-1.846
	Std Dev	0.448	0.659	0.659

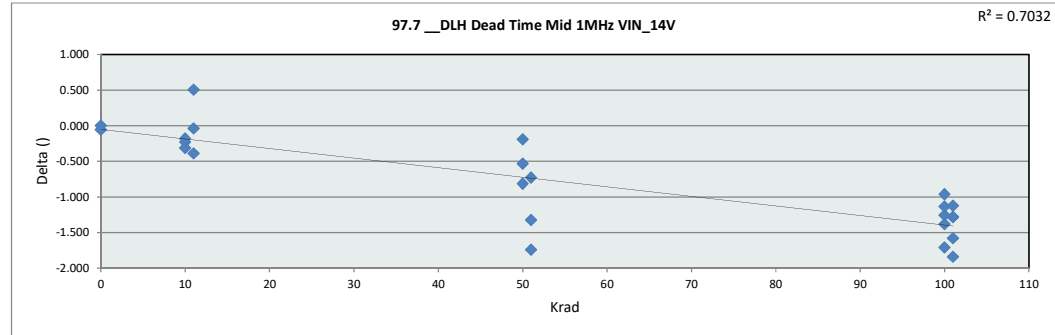

97.7 DLH Dead Time Mid 1M	
Test Site	DAL
Tester	ETS364
Test Number	EB672303
Max Limit	24
Min Limit	15.5

Krad	0	10	11	50	51	100	101
LL	15.500	15.500	15.500	15.500	15.500	15.500	15.500
Min	18.689	19.172	19.625	18.577	18.289	17.994	17.796
Average	19.122	19.503	19.676	18.631	18.785	18.315	18.037
Max	19.555	19.775	19.756	18.678	19.304	18.742	18.400
UL	24.000	24.000	24.000	24.000	24.000	24.000	24.000

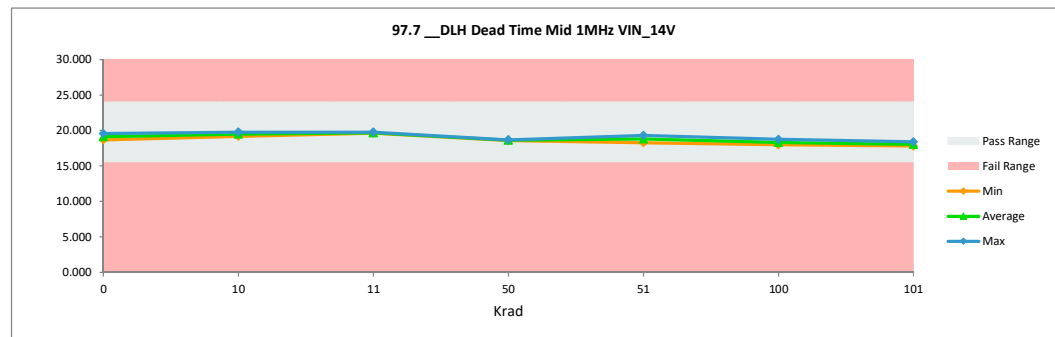

TID "HDR" Report
5962R2220102VXC

97.8 DLH Dead Time Large 1M		
Test Site	DAL	DAL
Tester	ETS364	ETS364
Test Number	EB672303	EB672303
Unit		
Max Limit	59	59
Min Limit	36	36

Krad	Serial #	Pre_HDR_6013	Post_HDR_6013	Delta
0	1	46.634	46.475	-0.158
0	2	44.730	44.568	-0.162
10	182	46.604	46.348	-0.256
10	202	46.895	46.233	-0.662
10	204	47.464	47.440	-0.024
11	418	47.128	46.201	-0.927
11	419	46.819	46.570	-0.250
11	443	46.593	45.970	-0.624
50	259	44.437	43.013	-1.424
50	346	46.135	44.483	-1.653
50	347	47.638	45.905	-1.732
51	462	47.722	44.147	-3.575
51	478	48.094	45.375	-2.719
51	503	47.010	44.944	-2.067
100	354	47.362	44.262	-3.100
100	363	46.545	43.601	-2.944
100	366	44.570	42.081	-2.489
100	383	47.498	43.630	-3.868
100	417	46.404	43.894	-2.510
101	513	46.623	43.009	-3.614
101	526	47.141	43.799	-3.341
101	532	46.254	43.120	-3.134
101	533	46.628	43.345	-3.283
101	534	44.335	41.721	-2.614
	Max	48.094	47.440	-0.024
	Average	46.553	44.589	-1.964
	Min	44.335	41.721	-3.868
	Std Dev	1.049	1.545	1.301

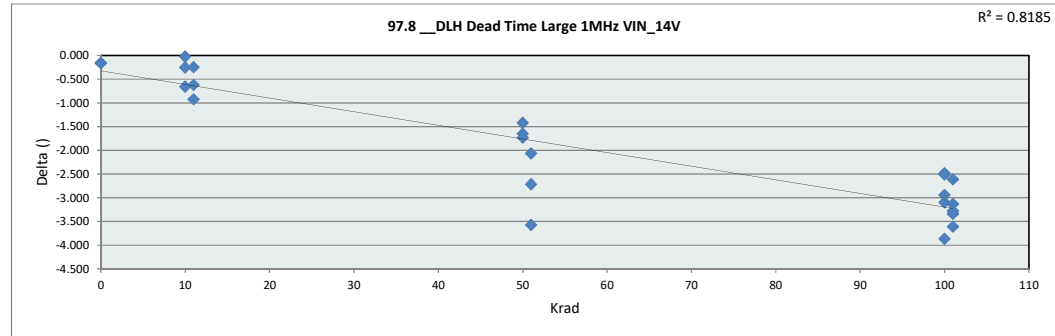

97.8 DLH Dead Time Large 1	
Test Site	DAL
Tester	ETS364
Test Number	EB672303
Max Limit	59
Min Limit	36

Krad	0	10	11	50	51	100	101
LL	36.000	36.000	36.000	36.000	36.000	36.000	36.000
Min	44.568	46.233	45.970	43.013	44.147	42.081	41.721
Average	45.522	46.674	46.247	44.467	44.822	43.493	42.999
Max	46.476	47.440	46.570	45.905	45.375	44.262	43.800
UL	59.000	59.000	59.000	59.000	59.000	59.000	59.000

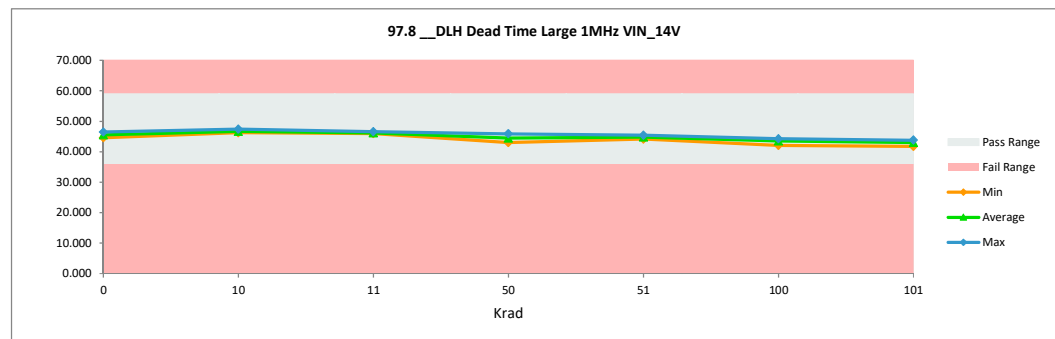

TID "HDR" Report
5962R2220102VXC

97.9 DLH Dead Time Max 1MHz		
Test Site	DAL	DAL
Tester	ETS364	ETS364
Test Number	EB672303	EB672303
Unit		
Max Limit	113.5	113.5
Min Limit	74	74

Krad	Serial #	Pre_HDR_6013	Post_HDR_6013	Delta
0	1	89.183	89.214	0.031
0	2	85.005	85.041	0.035
10	182	88.965	88.383	-0.582
10	202	89.749	88.417	-1.332
10	204	91.143	90.835	-0.308
11	418	89.530	88.003	-1.527
11	419	89.737	89.345	-0.392
11	443	89.039	87.230	-1.809
50	259	83.907	80.965	-2.941
50	346	88.035	84.719	-3.316
50	347	92.442	88.802	-3.640
51	462	92.492	84.541	-7.951
51	478	92.449	87.131	-5.317
51	503	89.615	85.567	-4.048
100	354	90.880	83.985	-6.894
100	363	89.626	83.858	-5.768
100	366	84.589	79.229	-5.359
100	383	90.421	82.453	-7.968
100	417	89.121	84.263	-4.858
101	513	89.433	81.738	-7.695
101	526	89.260	82.881	-6.380
101	532	88.689	81.653	-7.036
101	533	90.376	83.471	-6.905
101	534	84.320	78.490	-5.830
	Max	92.492	90.835	0.035
	Average	89.084	85.009	-4.075
	Min	83.907	78.490	-7.968
	Std Dev	2.419	3.345	2.782

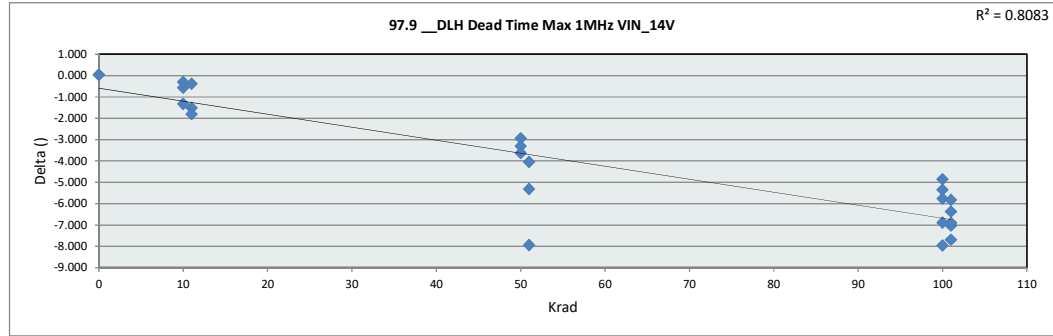

97.9 DLH Dead Time Max 1MHz	
Test Site	DAL
Tester	ETS364
Test Number	EB672303
Max Limit	113.5
Min Limit	74

Krad	0	10	11	50	51	100	101
LL	74.000	74.000	74.000	74.000	74.000	74.000	74.000
Min	85.041	88.383	87.230	80.965	84.541	79.229	78.490
Average	87.127	89.212	88.193	84.829	85.746	82.758	81.647
Max	89.214	90.835	89.345	88.802	87.131	84.263	83.472
UL	113.500	113.500	113.500	113.500	113.500	113.500	113.500

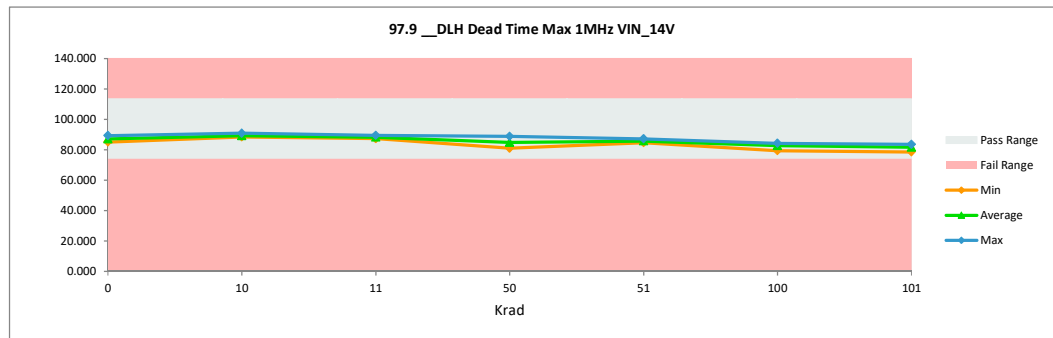

TID "HDR" Report
5962R2220102VXC

97.10_DLH Dead Time Min 2MH		
Test Site	DAL	DAL
Tester	ETS364	ETS364
Test Number	EB672303	EB672303
Unit		
Max Limit	10	10
Min Limit	0	0

Krad	Serial #	Pre_HDR_6013	Post_HDR_6013	Delta
0	1	4.202	4.140	-0.062
0	2	4.517	4.517	0.000
10	182	4.497	4.284	-0.212
10	202	4.021	3.957	-0.064
10	204	4.169	3.954	-0.215
11	418	4.535	4.427	-0.107
11	419	3.955	4.245	0.290
11	443	3.737	4.704	0.966
50	259	4.602	4.879	0.278
50	346	3.971	4.039	0.068
50	347	3.655	3.695	0.039
51	462	3.977	4.024	0.048
51	478	4.122	3.871	-0.250
51	503	4.833	5.297	0.464
100	354	4.616	4.907	0.290
100	363	3.821	3.957	0.136
100	366	4.837	4.913	0.076
100	383	5.012	4.996	-0.016
100	417	3.764	4.503	0.740
101	513	4.394	4.671	0.277
101	526	4.530	4.643	0.113
101	532	4.414	4.970	0.556
101	533	3.632	4.138	0.506
101	534	4.657	5.045	0.388
	Max	5.012	5.297	0.966
	Average	4.270	4.449	0.179
	Min	3.632	3.695	-0.250
	Std Dev	0.404	0.450	0.308

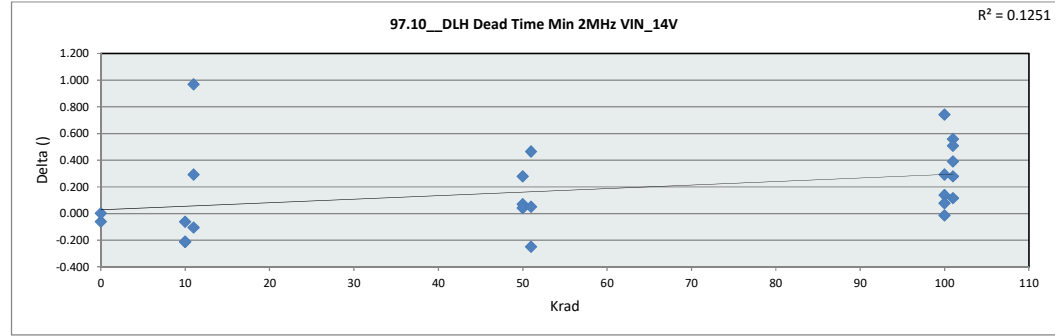

97.10_DLH Dead Time Min 2M	
Test Site	DAL
Tester	ETS364
Test Number	EB672303
Max Limit	10
Min Limit	0

Krad	0	10	11	50	51	100	101
LL	0.000	0.000	0.000	0.000	0.000	0.000	0.000
Min	4.140	3.954	4.245	3.695	3.871	3.957	4.138
Average	4.328	4.065	4.459	4.204	4.398	4.655	4.694
Max	4.517	4.284	4.704	4.879	5.297	4.996	5.045
UL	10.000	10.000	10.000	10.000	10.000	10.000	10.000

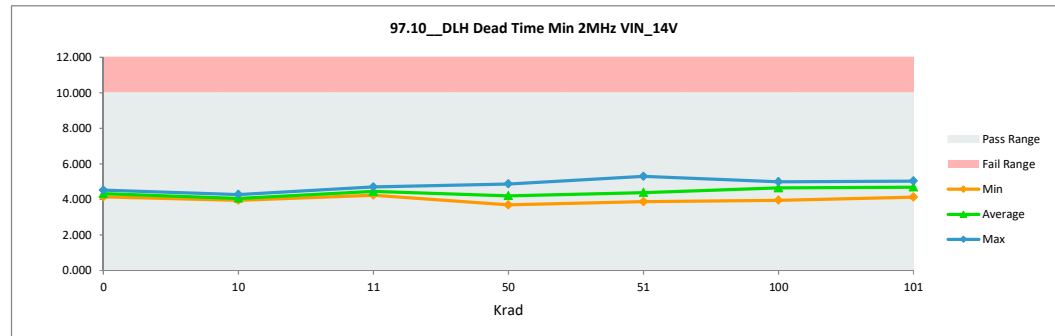

TID "HDR" Report
5962R2220102VXC

97.11_DLH Dead Time Small 2M		
Test Site	DAL	DAL
Tester	ETS364	ETS364
Test Number	EB672303	EB672303
Unit		
Max Limit	15.5	15.5
Min Limit	8	8

Krad	Serial #	Pre_HDR_6013	Post_HDR_6013	Delta
0	1	11.220	11.169	-0.051
0	2	10.967	10.839	-0.128
10	182	11.405	11.268	-0.137
10	202	11.221	10.762	-0.459
10	204	11.554	11.389	-0.165
11	418	11.579	11.166	-0.413
11	419	11.163	11.045	-0.118
11	443	10.808	11.695	0.887
50	259	11.252	10.985	-0.267
50	346	10.871	10.660	-0.211
50	347	10.892	10.207	-0.686
51	462	11.359	10.342	-1.017
51	478	11.363	10.583	-0.780
51	503	11.861	11.495	-0.366
100	354	11.679	11.136	-0.542
100	363	10.911	10.167	-0.744
100	366	11.378	10.502	-0.876
100	383	12.085	10.967	-1.117
100	417	10.792	10.457	-0.335
101	513	11.333	10.536	-0.797
101	526	11.328	10.584	-0.745
101	532	11.245	10.762	-0.483
101	533	10.587	10.328	-0.259
101	534	11.126	10.804	-0.322
	Max	12.085	11.695	0.887
	Average	11.249	10.827	-0.422
	Min	10.587	10.167	-1.117
	Std Dev	0.353	0.413	0.412

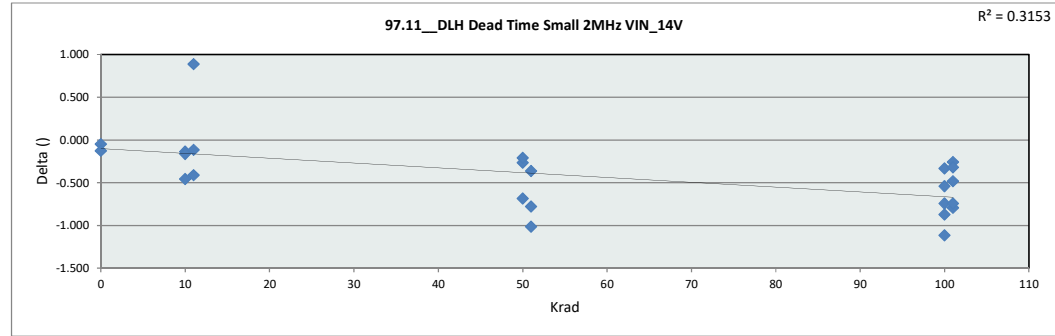

97.11_DLH Dead Time Small	
Test Site	DAL
Tester	ETS364
Test Number	EB672303
Max Limit	15.5
Min Limit	8

Krad	0	10	11	50	51	100	101
LL	8.000	8.000	8.000	8.000	8.000	8.000	8.000
Min	10.839	10.762	11.045	10.207	10.342	10.167	10.329
Average	11.004	11.140	11.302	10.617	10.807	10.646	10.603
Max	11.169	11.389	11.695	10.985	11.495	11.136	10.805
UL	15.500	15.500	15.500	15.500	15.500	15.500	15.500

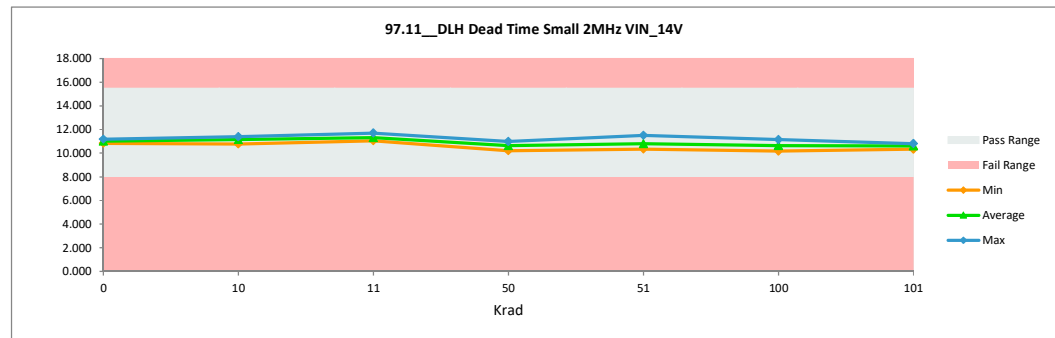

TID "HDR" Report
5962R2220102VXC

97.12_DLH Dead Time Mid 2MH		
Test Site	DAL	DAL
Tester	ETS364	ETS364
Test Number	EB672303	EB672303
Unit		
Max Limit	24	24
Min Limit	15.5	15.5

Krad	Serial #	Pre_HDR_6013	Post_HDR_6013	Delta
0	1	19.413	19.459	0.046
0	2	18.655	18.535	-0.120
10	182	19.451	19.457	0.006
10	202	19.368	18.879	-0.488
10	204	19.623	19.617	-0.006
11	418	19.938	19.388	-0.550
11	419	19.581	19.233	-0.348
11	443	19.032	19.598	0.566
50	259	18.894	18.356	-0.538
50	346	19.009	18.154	-0.855
50	347	19.280	18.433	-0.847
51	462	19.891	18.186	-1.705
51	478	19.946	18.947	-0.999
51	503	20.031	19.101	-0.931
100	354	19.960	18.673	-1.287
100	363	19.206	17.843	-1.363
100	366	19.188	17.809	-1.379
100	383	20.162	18.475	-1.686
100	417	19.072	17.991	-1.082
101	513	19.597	17.633	-1.964
101	526	19.676	18.247	-1.429
101	532	19.343	18.156	-1.187
101	533	18.996	17.821	-1.175
101	534	18.714	17.732	-0.982
	Max	20.162	19.617	0.566
	Average	19.418	18.572	-0.846
	Min	18.655	17.633	-1.964
	Std Dev	0.430	0.647	0.640

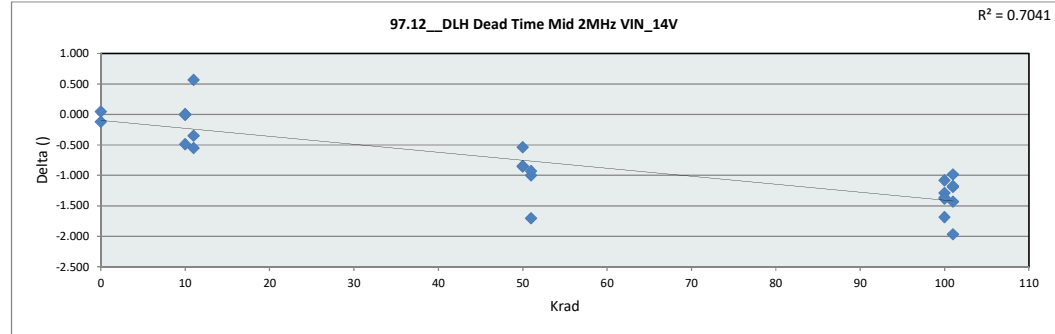

97.12_DLH Dead Time Mid 2M	
Test Site	DAL
Tester	ETS364
Test Number	EB672303
Max Limit	24
Min Limit	15.5

Krad	0	10	11	50	51	100	101
LL	15.500	15.500	15.500	15.500	15.500	15.500	15.500
Min	18.535	18.879	19.233	18.154	18.186	17.809	17.633
Average	18.997	19.318	19.406	18.315	18.744	18.158	17.918
Max	19.459	19.617	19.598	18.433	19.101	18.673	18.248
UL	24.000	24.000	24.000	24.000	24.000	24.000	24.000

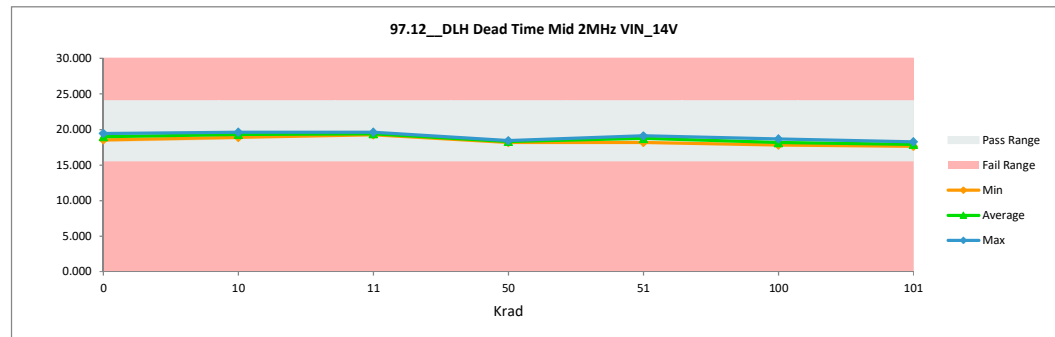

TID "HDR" Report
5962R2220102VXC

97.13_DLH Dead Time Large 2M		
Test Site	DAL	DAL
Tester	ETS364	ETS364
Test Number	EB672303	EB672303
Unit		
Max Limit	59	59
Min Limit	36	36

Krad	Serial #	Pre_HDR_6013	Post_HDR_6013	Delta
0	1	46.365	46.283	-0.083
0	2	44.382	44.299	-0.083
10	182	46.538	46.007	-0.531
10	202	46.580	45.916	-0.664
10	204	47.072	46.993	-0.079
11	418	46.795	45.939	-0.855
11	419	46.388	46.254	-0.133
11	443	46.070	45.632	-0.438
50	259	44.082	42.954	-1.128
50	346	45.744	44.134	-1.611
50	347	47.347	45.514	-1.833
51	462	47.532	43.802	-3.730
51	478	47.747	44.965	-2.782
51	503	46.900	44.672	-2.228
100	354	46.919	43.760	-3.159
100	363	46.439	43.277	-3.163
100	366	44.453	41.932	-2.521
100	383	47.359	43.522	-3.837
100	417	45.908	43.746	-2.161
101	513	46.321	42.599	-3.721
101	526	46.838	43.678	-3.160
101	532	46.133	42.934	-3.199
101	533	46.432	42.893	-3.540
101	534	44.151	41.436	-2.715
	Max	47.747	46.993	-0.079
	Average	46.271	44.298	-1.973
	Min	44.082	41.436	-3.837
	Std Dev	1.043	1.508	1.348

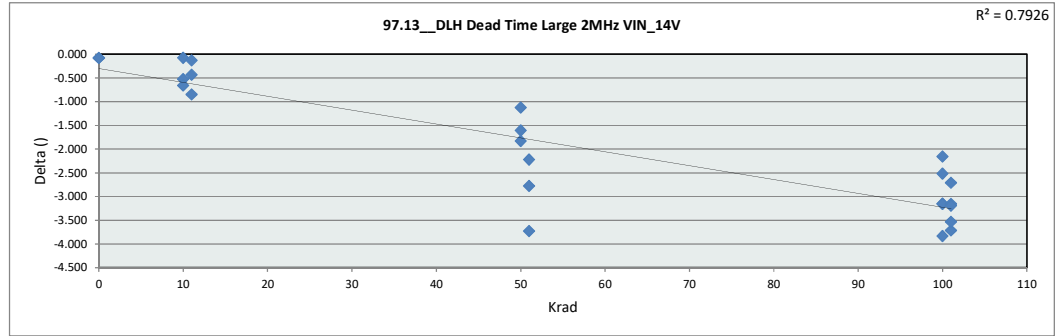

97.13_DLH Dead Time Large	
Test Site	DAL
Tester	ETS364
Test Number	EB672303
Max Limit	59
Min Limit	36

Krad	0	10	11	50	51	100	101
LL	36.000	36.000	36.000	36.000	36.000	36.000	36.000
Min	44.299	45.916	45.632	42.954	43.802	41.933	41.436
Average	45.291	46.305	45.942	44.201	44.480	43.247	42.708
Max	46.283	46.993	46.254	45.514	44.965	43.760	43.678
UL	59.000	59.000	59.000	59.000	59.000	59.000	59.000

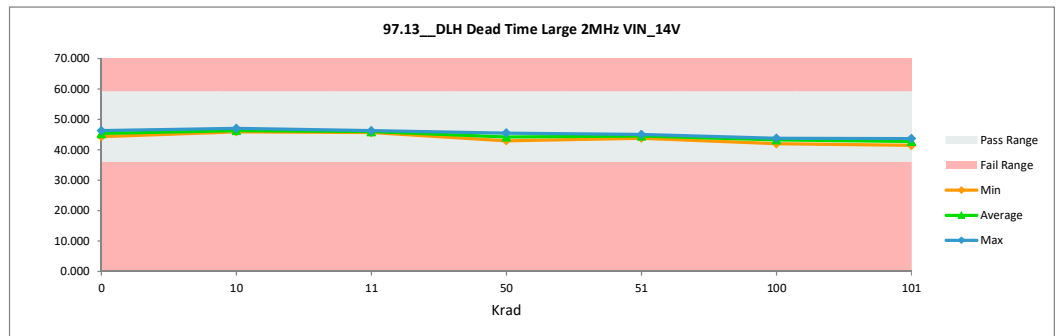

TID "HDR" Report
5962R2220102VXC

97.14_DLH Dead Time Max 2MHz		
Test Site	DAL	DAL
Tester	ETS364	ETS364
Test Number	EB672303	EB672303
Unit		
Max Limit	113.5	113.5
Min Limit	74	74

Krad	Serial #	Pre_HDR_6013	Post_HDR_6013	Delta
0	1	89.716	89.671	-0.046
0	2	85.665	85.670	0.004
10	182	89.929	89.064	-0.866
10	202	90.455	89.526	-0.929
10	204	91.915	91.608	-0.308
11	418	90.247	88.724	-1.523
11	419	90.507	90.284	-0.224
11	443	89.889	87.761	-2.128
50	259	84.407	81.410	-2.997
50	346	88.609	85.259	-3.349
50	347	93.282	89.707	-3.575
51	462	93.378	85.151	-8.227
51	478	93.418	87.993	-5.424
51	503	90.493	86.255	-4.238
100	354	91.346	84.724	-6.622
100	363	90.696	84.644	-6.051
100	366	85.267	79.633	-5.634
100	383	91.458	83.272	-8.186
100	417	89.748	85.044	-4.705
101	513	90.014	82.585	-7.429
101	526	90.241	83.486	-6.755
101	532	89.466	82.338	-7.128
101	533	91.054	84.079	-6.975
101	534	84.896	78.859	-6.037
	Max	93.418	91.608	0.004
	Average	89.837	85.698	-4.140
	Min	84.407	78.859	-8.227
	Std Dev	2.504	3.440	2.824

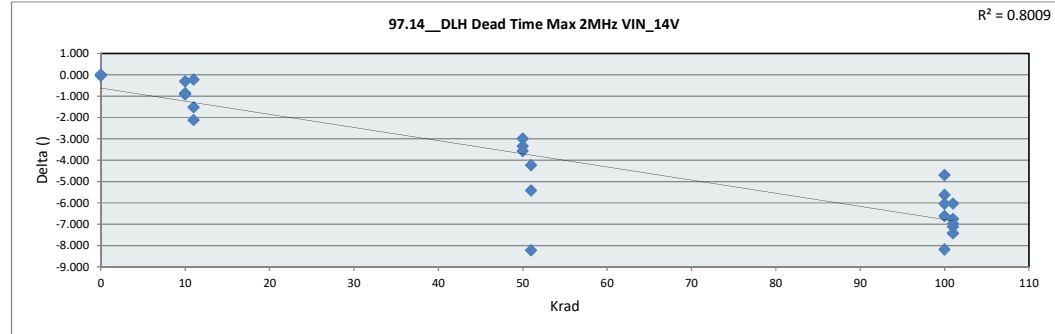

97.14_DLH Dead Time Max 2MHz	
Test Site	DAL
Tester	ETS364
Test Number	EB672303
Max Limit	113.5
Min Limit	74

Krad	0	10	11	50	51	100	101
LL	74.000	74.000	74.000	74.000	74.000	74.000	74.000
Min	85.670	89.064	87.761	81.410	85.151	79.633	78.859
Average	87.670	90.066	88.923	85.459	86.466	83.463	82.269
Max	89.671	91.608	90.284	89.708	87.993	85.044	84.079
UL	113.500	113.500	113.500	113.500	113.500	113.500	113.500

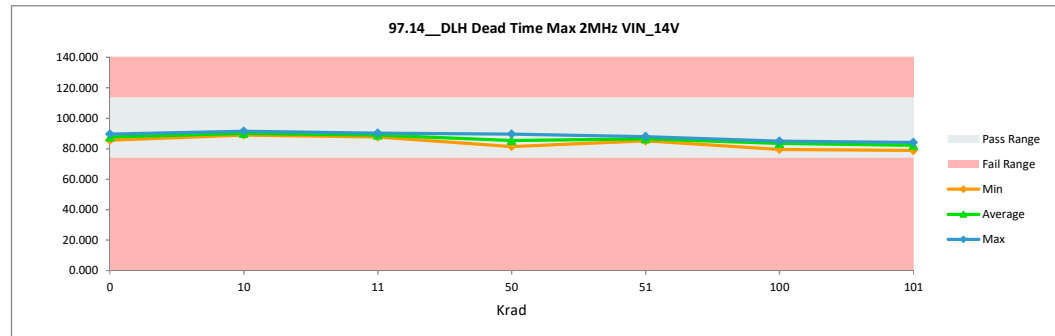

TID "HDR" Report
5962R2220102VXC

97.19 DHL Dead Time Min 500kHz		
Test Site	DAL	DAL
Tester	ETS364	ETS364
Test Number	EB672303	EB672303
Unit		
Max Limit	10	10
Min Limit	0	0

Krad	Serial #	Pre_HDR_6013	Post_HDR_6013	Delta
0	1	4.443	4.456	0.013
0	2	3.335	3.464	0.129
10	182	3.772	3.884	0.112
10	202	4.237	4.411	0.175
10	204	3.733	4.918	1.185
11	418	3.423	4.397	0.974
11	419	3.800	4.453	0.654
11	443	3.563	3.959	0.396
50	259	4.712	4.644	-0.069
50	346	5.016	5.470	0.454
50	347	4.470	4.485	0.015
51	462	4.227	4.314	0.087
51	478	3.636	4.170	0.534
51	503	4.056	4.135	0.079
100	354	4.035	4.716	0.681
100	363	4.649	5.358	0.709
100	366	4.277	4.663	0.387
100	383	2.464	4.339	1.875
100	417	4.074	4.982	0.908
101	513	4.135	4.744	0.609
101	526	3.562	4.071	0.509
101	532	4.131	4.323	0.192
101	533	4.423	4.795	0.373
101	534	4.441	4.324	-0.117
Max		5.016	5.470	1.875
Average		4.026	4.478	0.453
Min		2.464	3.464	-0.117
Std Dev		0.543	0.449	0.460

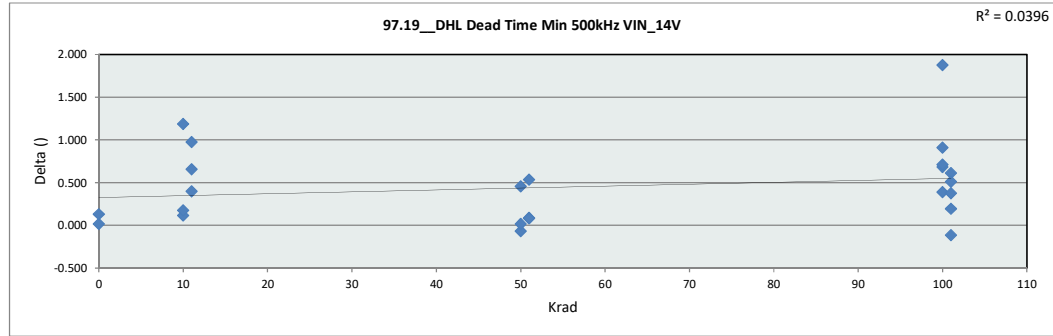

97.19 DHL Dead Time Min 50	
Test Site	DAL
Tester	ETS364
Test Number	EB672303
Max Limit	10
Min Limit	0

	0	10	11	50	51	100	101
LL	0.000	0.000	0.000	0.000	0.000	0.000	0.000
Min	3.464	3.884	3.959	4.485	4.135	4.339	4.071
Average	3.960	4.404	4.270	4.866	4.207	4.812	4.452
Max	4.456	4.918	4.453	5.470	4.314	5.358	4.795
UL	10.000	10.000	10.000	10.000	10.000	10.000	10.000

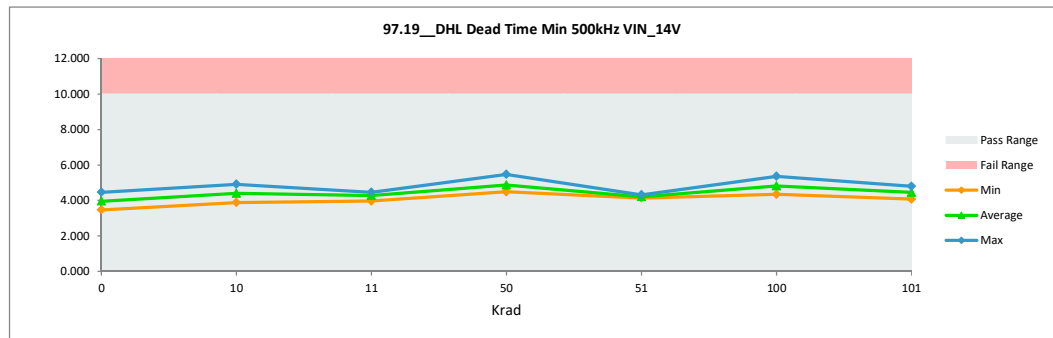

TID "HDR" Report
5962R2220102VXC

97.20 DHL Dead Time Small 50		
Test Site	DAL	DAL
Tester	ETS364	ETS364
Test Number	EB672303	EB672303
Unit		
Max Limit	15	15
Min Limit	6	6

Krad	Serial #	Pre_HDR_6013	Post_HDR_6013	Delta
0	1	9.914	9.898	-0.016
0	2	9.009	9.191	0.182
10	182	9.420	9.483	0.063
10	202	9.838	9.925	0.087
10	204	8.853	10.361	1.508
11	418	8.730	9.997	1.267
11	419	8.950	9.639	0.690
11	443	8.730	9.764	1.035
50	259	9.827	9.572	-0.256
50	346	10.390	10.531	0.141
50	347	9.987	9.845	-0.142
51	462	9.129	9.621	0.492
51	478	8.641	9.337	0.696
51	503	9.690	9.446	-0.244
100	354	9.546	9.658	0.112
100	363	9.665	9.946	0.281
100	366	9.927	9.910	-0.018
100	383	7.639	9.269	1.630
100	417	9.025	9.769	0.744
101	513	9.553	9.627	0.074
101	526	9.433	9.313	-0.120
101	532	9.712	9.393	-0.319
101	533	9.866	9.796	-0.070
101	534	10.020	9.555	-0.465
Max		10.390	10.531	1.630
Average		9.396	9.702	0.306
Min		7.639	9.191	-0.465
Std Dev		0.611	0.325	0.581

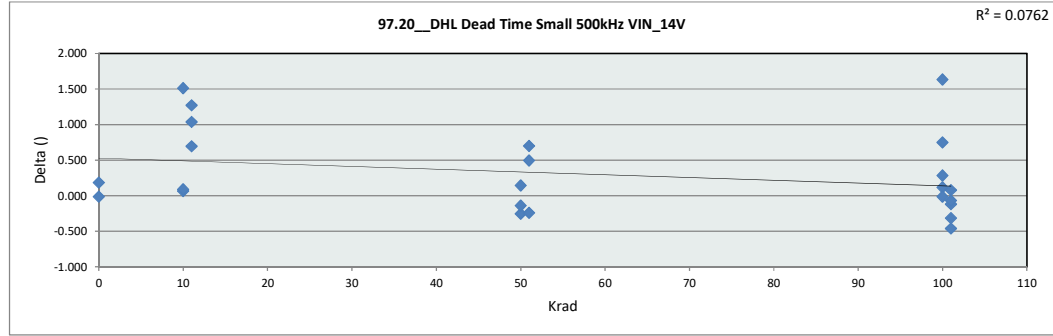

97.20 DHL Dead Time Small	
Test Site	DAL
Tester	ETS364
Test Number	EB672303
Max Limit	15
Min Limit	6

	0	10	11	50	51	100	101
LL	6.000	6.000	6.000	6.000	6.000	6.000	6.000
Min	9.191	9.483	9.639	9.572	9.337	9.270	9.313
Average	9.544	9.923	9.800	9.983	9.468	9.710	9.537
Max	9.898	10.362	9.997	10.531	9.621	9.946	9.796
UL	15.000	15.000	15.000	15.000	15.000	15.000	15.000

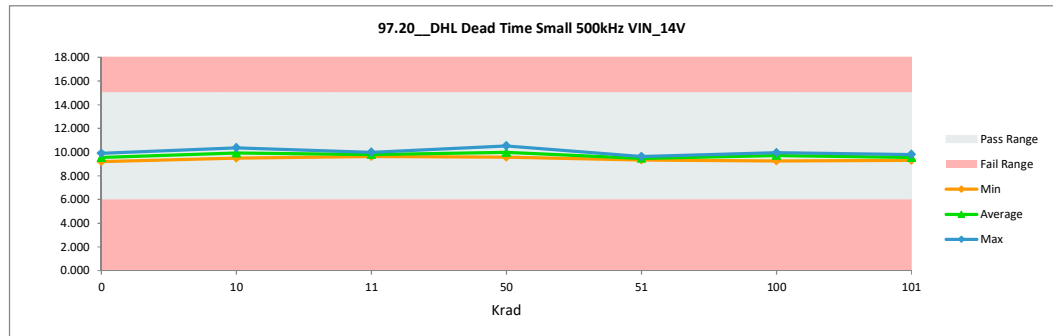

TID "HDR" Report
5962R2220102VXC

97.21 DHL Dead Time Mid 500k		
Test Site	DAL	DAL
Tester	ETS364	ETS364
Test Number	EB672303	EB672303
Unit		
Max Limit	24.5	24.5
Min Limit	16	16

Krad	Serial #	Pre_HDR_6013	Post_HDR_6013	Delta
0	1	19.940	20.136	0.197
0	2	19.657	19.672	0.015
10	182	19.391	19.493	0.102
10	202	19.908	19.902	-0.005
10	204	18.396	20.172	1.776
11	418	18.124	19.902	1.777
11	419	18.375	19.533	1.157
11	443	18.105	19.917	1.812
50	259	19.449	18.752	-0.697
50	346	20.290	19.917	-0.373
50	347	20.028	19.561	-0.467
51	462	18.519	19.573	1.054
51	478	18.117	18.566	0.449
51	503	19.933	19.299	-0.634
100	354	19.634	19.042	-0.593
100	363	19.202	18.479	-0.723
100	366	20.179	19.465	-0.714
100	383	16.800	19.099	2.299
100	417	18.609	18.861	0.253
101	513	19.425	19.027	-0.398
101	526	19.746	18.806	-0.940
101	532	19.817	18.674	-1.143
101	533	20.102	19.329	-0.774
101	534	20.045	19.049	-0.996
Max		20.290	20.172	2.299
Average		19.241	19.343	0.101
Min		16.800	18.479	-1.143
Std Dev		0.898	0.506	1.021

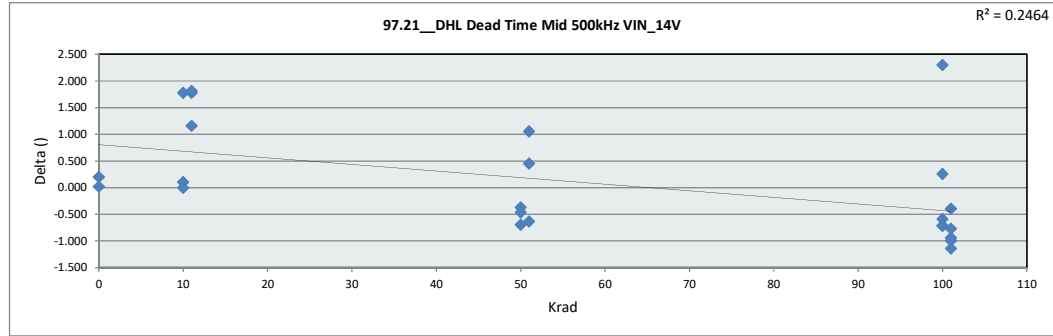

97.21 DHL Dead Time Mid 50	
Test Site	DAL
Tester	ETS364
Test Number	EB672303
Max Limit	24.5
Min Limit	16

Krad	0	10	11	50	51	100	101
LL	16.000	16.000	16.000	16.000	16.000	16.000	16.000
Min	19.672	19.494	19.533	18.752	18.566	18.479	18.674
Average	19.904	19.856	19.784	19.410	19.146	18.989	18.977
Max	20.136	20.172	19.917	19.917	19.573	19.465	19.329
UL	24.500	24.500	24.500	24.500	24.500	24.500	24.500

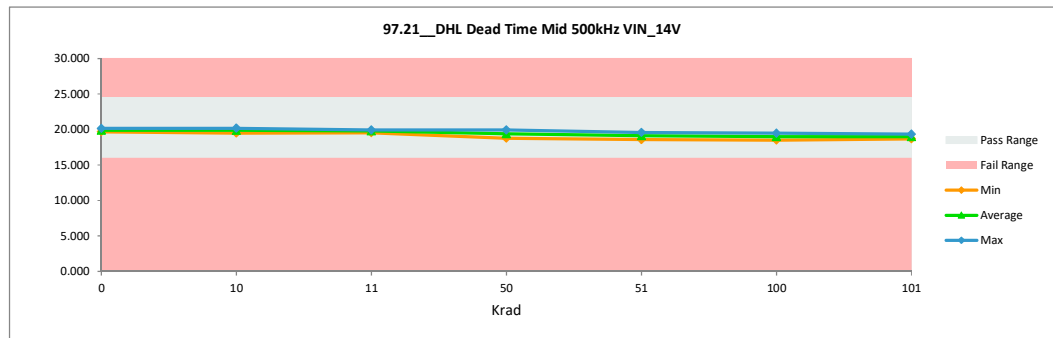

TID "HDR" Report
5962R2220102VXC

97.22 DHL Dead Time Large 50		
Test Site	DAL	DAL
Tester	ETS364	ETS364
Test Number	EB672303	EB672303
Unit		
Max Limit	61	61
Min Limit	44	44

Krad	Serial #	Pre_HDR_6013	Post_HDR_6013	Delta
0	1	50.453	50.637	0.184
0	2	51.501	51.875	0.374
10	182	50.250	50.044	-0.205
10	202	50.579	50.375	-0.205
10	204	47.510	49.940	2.430
11	418	46.780	50.148	3.368
11	419	47.316	49.006	1.690
11	443	46.908	51.205	4.297
50	259	48.546	46.664	-1.882
50	346	49.936	48.229	-1.706
50	347	50.854	49.360	-1.494
51	462	46.864	49.781	2.917
51	478	46.992	47.393	0.401
51	503	51.333	49.428	-1.905
100	354	50.432	47.418	-3.014
100	363	48.344	44.885	-3.459
100	366	51.485	48.443	-3.042
100	383	45.298	48.098	2.799
100	417	47.331	46.447	-0.883
101	513	49.903	47.264	-2.639
101	526	51.100	47.797	-3.302
101	532	50.570	47.214	-3.357
101	533	50.872	48.164	-2.708
101	534	50.713	47.501	-3.212
Max		51.501	51.875	4.297
Average		49.245	48.638	-0.606
Min		45.298	44.885	-3.459
Std Dev		1.902	1.682	2.438

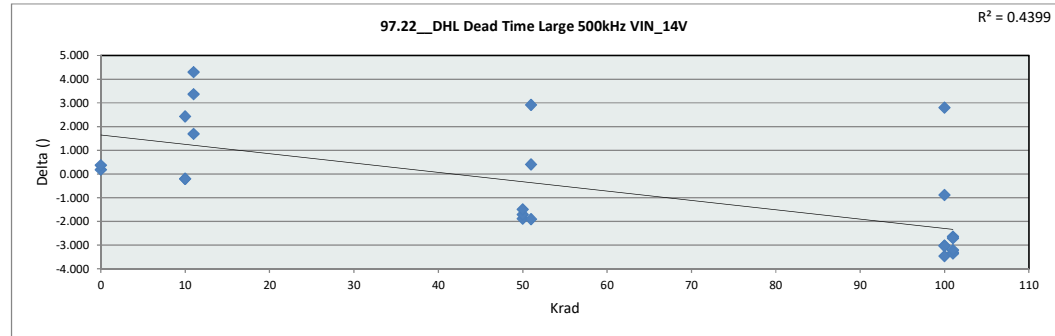

97.22 DHL Dead Time Large	
Test Site	DAL
Tester	ETS364
Test Number	EB672303
Max Limit	61
Min Limit	44

Krad	0	10	11	50	51	100	101
LL	44.000	44.000	44.000	44.000	44.000	44.000	44.000
Min	50.637	49.940	49.006	46.664	47.393	44.885	47.214
Average	51.256	50.120	50.120	48.084	48.867	47.058	47.588
Max	51.875	50.375	51.205	49.360	49.781	48.443	48.164
UL	61.000	61.000	61.000	61.000	61.000	61.000	61.000

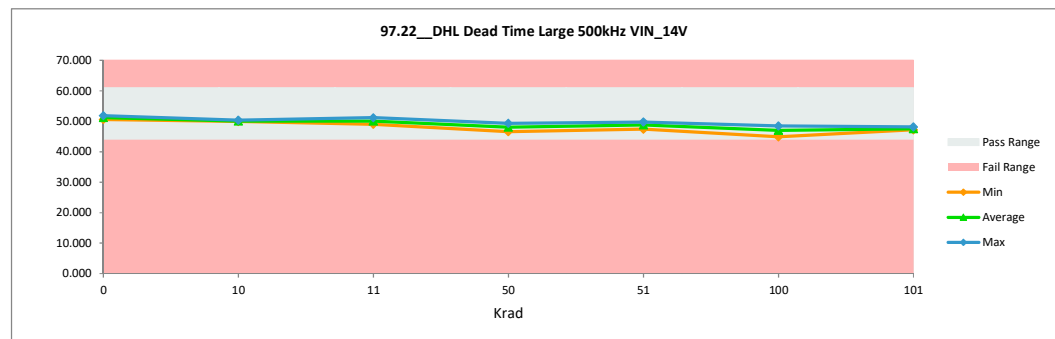

TID "HDR" Report
5962R2220102VXC

97.23 DHL Dead Time Max 500		
Test Site	DAL	DAL
Tester	ETS364	ETS364
Test Number	EB672303	EB672303
Unit		
Max Limit	125	125
Min Limit	86	86

Krad	Serial #	Pre_HDR_6013	Post_HDR_6013	Delta
0	1	98.547	98.531	-0.016
0	2	102.179	102.496	0.317
10	182	98.995	98.410	-0.585
10	202	98.858	98.164	-0.694
10	204	93.727	97.006	3.279
11	418	92.134	98.512	6.379
11	419	92.895	95.973	3.078
11	443	91.910	100.445	8.535
50	259	94.859	90.385	-4.474
50	346	96.742	93.033	-3.709
50	347	99.989	95.976	-4.012
51	462	91.680	97.171	5.491
51	478	92.847	92.707	-0.140
51	503	100.759	97.035	-3.724
100	354	99.066	92.145	-6.921
100	363	94.280	86.120	-8.160
100	366	101.485	94.007	-7.478
100	383	89.989	93.430	3.441
100	417	92.598	90.586	-2.013
101	513	97.767	91.563	-6.204
101	526	100.465	93.317	-7.147
101	532	99.437	92.324	-7.114
101	533	99.909	93.629	-6.281
101	534	99.249	92.189	-7.059
Max		102.179	102.496	8.535
Average		96.682	94.798	-1.884
Min		89.989	86.120	-8.160
Std Dev		3.712	3.719	4.931

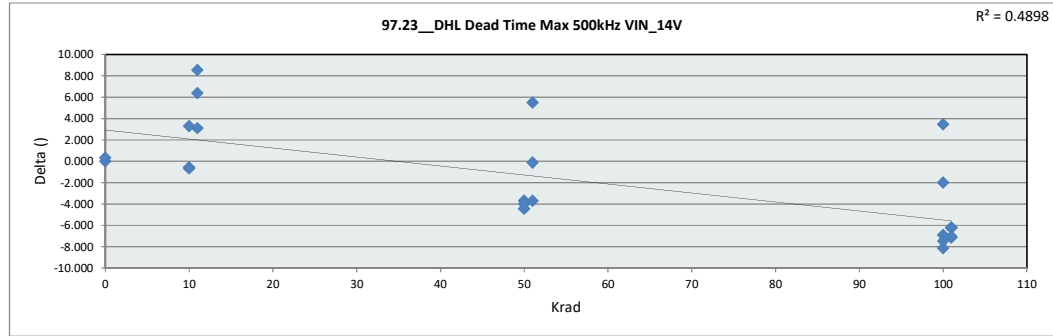

97.23 DHL Dead Time Max 500	
Test Site	DAL
Tester	ETS364
Test Number	EB672303
Max Limit	125
Min Limit	86

Krad	0	10	11	50	51	100	101
LL	86.000	86.000	86.000	86.000	86.000	86.000	86.000
Min	98.531	97.006	95.973	90.385	92.707	86.120	91.563
Average	100.514	97.860	98.310	93.131	95.638	91.257	92.605
Max	102.497	98.411	100.445	95.976	97.171	94.007	93.629
UL	125.000	125.000	125.000	125.000	125.000	125.000	125.000

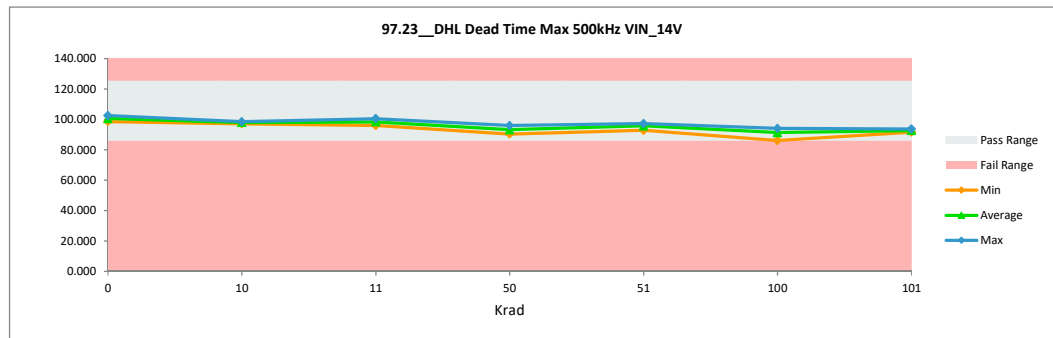

TID "HDR" Report
5962R2220102VXC

97.24 DHL Dead Time Min 1MH		
Test Site	DAL	DAL
Tester	ETS364	ETS364
Test Number	EB672303	EB672303
Unit		
Max Limit	10	10
Min Limit	0	0

Krad	Serial #	Pre_HDR_6013	Post_HDR_6013	Delta
0	1	4.616	4.738	0.122
0	2	3.649	3.755	0.106
10	182	4.101	4.427	0.327
10	202	4.522	4.696	0.173
10	204	3.856	5.000	1.143
11	418	3.687	4.745	1.058
11	419	4.146	4.618	0.472
11	443	3.752	4.469	0.717
50	259	4.784	4.918	0.134
50	346	5.240	5.701	0.460
50	347	4.413	4.688	0.275
51	462	4.460	4.379	-0.082
51	478	3.967	4.446	0.479
51	503	4.252	4.262	0.011
100	354	4.288	4.810	0.522
100	363	4.654	5.403	0.749
100	366	4.536	4.878	0.342
100	383	2.702	4.549	1.847
100	417	4.207	5.143	0.936
101	513	4.352	4.993	0.641
101	526	3.891	4.279	0.388
101	532	4.432	4.658	0.226
101	533	4.428	4.885	0.457
101	534	4.925	4.694	-0.231
Max		5.240	5.701	1.847
Average		4.244	4.714	0.470
Min		2.702	3.755	-0.231
Std Dev		0.513	0.395	0.451

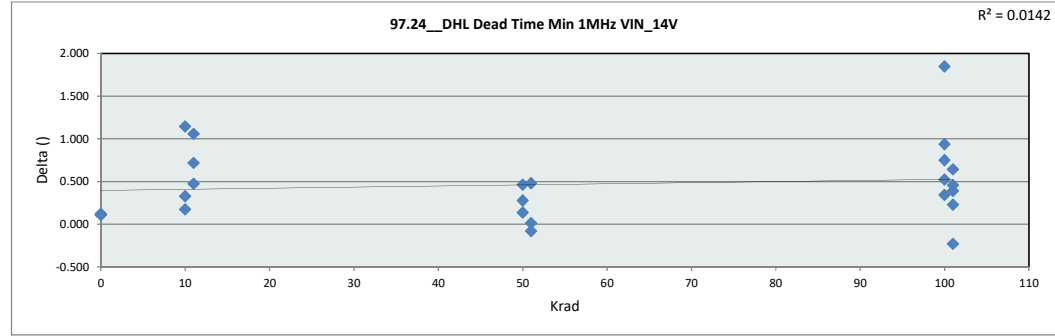

97.24 DHL Dead Time Min 1M	
Test Site	DAL
Tester	ETS364
Test Number	EB672303
Max Limit	10
Min Limit	0

Krad	0	10	11	50	51	100	101
LL	0.000	0.000	0.000	0.000	0.000	0.000	0.000
Min	3.755	4.427	4.469	4.688	4.263	4.549	4.279
Average	4.247	4.708	4.611	5.102	4.362	4.956	4.702
Max	4.738	5.000	4.745	5.701	4.446	5.403	4.993
UL	10.000	10.000	10.000	10.000	10.000	10.000	10.000

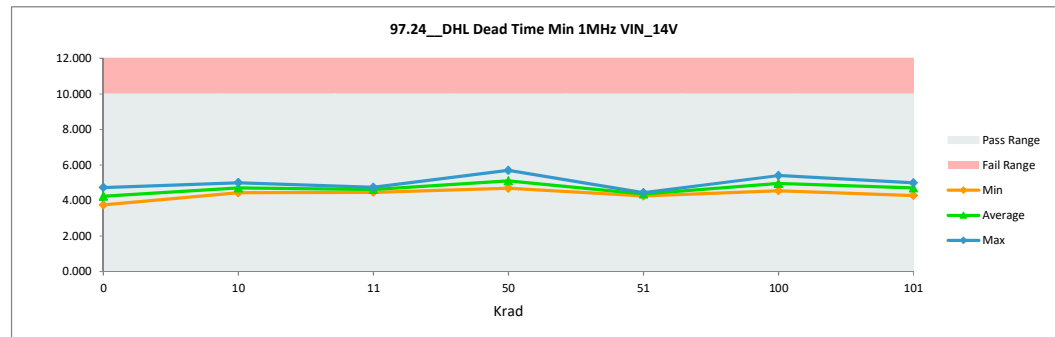

TID "HDR" Report
5962R2220102VXC

97.25 DHL Dead Time Small 1M		
Test Site	DAL	DAL
Tester	ETS364	ETS364
Test Number	EB672303	EB672303
Unit		
Max Limit	15	15
Min Limit	6	6

Krad	Serial #	Pre_HDR_6013	Post_HDR_6013	Delta
0	1	10.144	10.284	0.139
0	2	9.418	9.548	0.130
10	182	9.695	9.779	0.084
10	202	10.003	10.191	0.189
10	204	9.128	10.473	1.345
11	418	8.845	10.163	1.317
11	419	9.196	9.933	0.737
11	443	9.017	10.015	0.999
50	259	10.138	9.857	-0.281
50	346	10.574	10.701	0.127
50	347	10.130	10.038	-0.092
51	462	9.422	9.915	0.494
51	478	8.965	9.533	0.568
51	503	10.043	9.790	-0.253
100	354	9.847	9.817	-0.030
100	363	9.854	10.078	0.223
100	366	10.143	9.997	-0.146
100	383	7.974	9.525	1.551
100	417	9.251	10.042	0.791
101	513	9.800	9.895	0.095
101	526	9.720	9.550	-0.171
101	532	9.896	9.599	-0.297
101	533	10.190	10.061	-0.128
101	534	10.303	9.791	-0.512
	Max	10.574	10.701	1.551
	Average	9.654	9.941	0.287
	Min	7.974	9.525	-0.512
	Std Dev	0.591	0.296	0.568

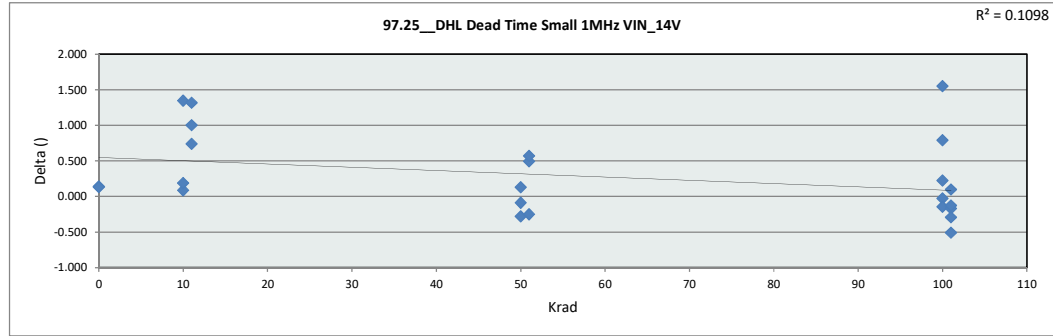

97.25 DHL Dead Time Small	
Test Site	DAL
Tester	ETS364
Test Number	EB672303
Max Limit	15
Min Limit	6

	0	10	11	50	51	100	101
LL	6.000	6.000	6.000	6.000	6.000	6.000	6.000
Min	9.548	9.779	9.933	9.857	9.533	9.525	9.550
Average	9.916	10.148	10.037	10.199	9.746	9.892	9.779
Max	10.284	10.473	10.163	10.701	9.915	10.078	10.061
UL	15.000	15.000	15.000	15.000	15.000	15.000	15.000

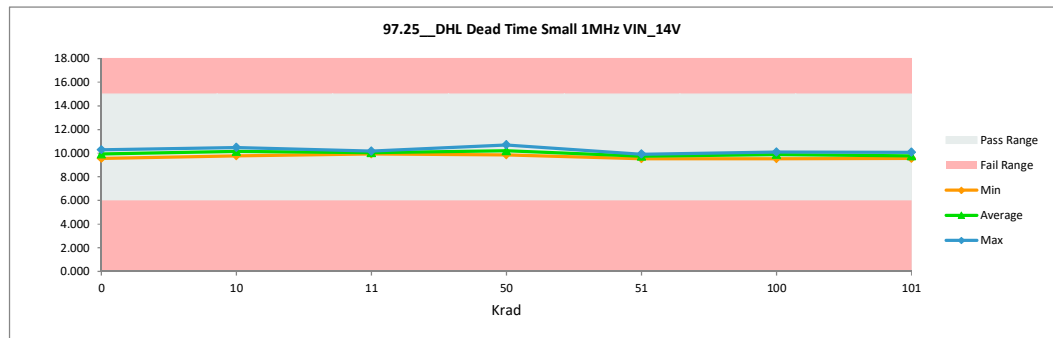

TID "HDR" Report
5962R2220102VXC

97.26 DHL Dead Time Mid 1MH		
Test Site	DAL	DAL
Tester	ETS364	ETS364
Test Number	EB672303	EB672303
Unit		
Max Limit	24.5	24.5
Min Limit	16	16

Krad	Serial #	Pre_HDR_6013	Post_HDR_6013	Delta
0	1	20.417	20.388	-0.029
0	2	19.996	19.887	-0.108
10	182	19.877	19.831	-0.046
10	202	20.101	20.077	-0.024
10	204	18.768	20.432	1.664
11	418	18.436	20.281	1.845
11	419	18.823	19.593	0.771
11	443	18.547	20.318	1.771
50	259	19.733	19.136	-0.597
50	346	20.495	20.144	-0.351
50	347	20.354	19.974	-0.381
51	462	18.899	20.011	1.112
51	478	18.482	19.061	0.580
51	503	20.214	19.662	-0.552
100	354	19.919	19.259	-0.660
100	363	19.528	18.917	-0.610
100	366	20.456	19.568	-0.888
100	383	17.199	19.339	2.140
100	417	18.817	19.191	0.374
101	513	19.917	19.222	-0.695
101	526	20.042	19.205	-0.837
101	532	20.053	18.924	-1.129
101	533	20.376	19.520	-0.857
101	534	20.347	19.093	-1.254
	Max	20.495	20.432	2.140
	Average	19.575	19.626	0.052
	Min	17.199	18.917	-1.254
	Std Dev	0.867	0.493	1.009

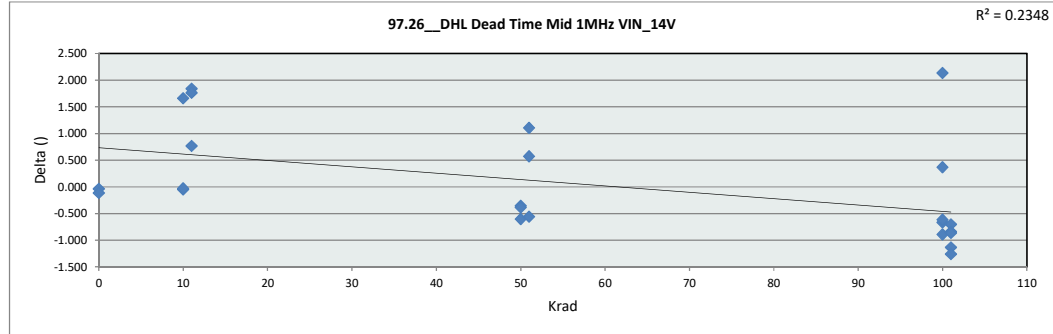

97.26 DHL Dead Time Mid 1M	
Test Site	DAL
Tester	ETS364
Test Number	EB672303
Max Limit	24.5
Min Limit	16

Krad	0	10	11	50	51	100	101
LL	16.000	16.000	16.000	16.000	16.000	16.000	16.000
Min	19.887	19.832	19.593	19.136	19.061	18.917	18.924
Average	20.138	20.114	20.064	19.751	19.578	19.255	19.193
Max	20.388	20.432	20.318	20.144	20.011	19.568	19.520
UL	24.500	24.500	24.500	24.500	24.500	24.500	24.500

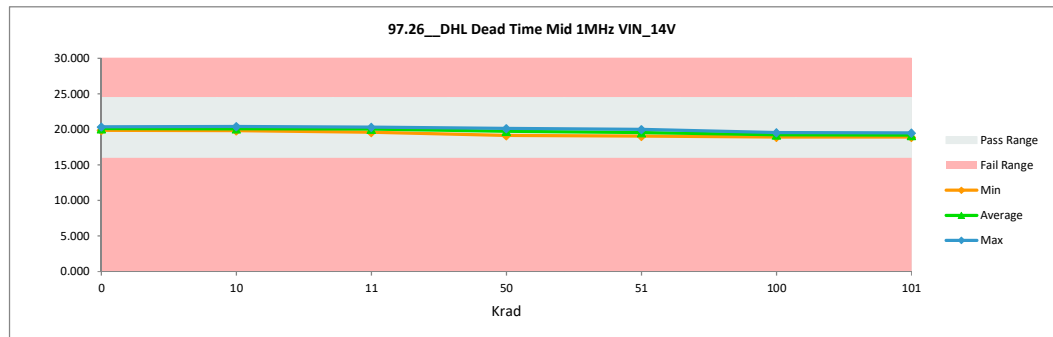

TID "HDR" Report 5962R2220102VXC

97.27 DHL Dead Time Large 1M		
Test Site	DAL	DAL
Tester	ETS364	ETS364
Test Number	EB672303	EB672303
Unit		
Max Limit	61	61
Min Limit	44	44

Krad	Serial #	Pre_HDR_6013	Post_HDR_6013	Delta
0	1	51.028	51.185	0.157
0	2	52.118	52.304	0.187
10	182	50.728	50.543	-0.185
10	202	51.179	50.610	-0.569
10	204	48.160	50.543	2.383
11	418	47.495	50.975	3.480
11	419	47.960	49.559	1.598
11	443	47.421	51.746	4.325
50	259	49.121	47.121	-2.000
50	346	50.384	48.681	-1.702
50	347	51.690	49.856	-1.834
51	462	47.439	50.275	2.836
51	478	47.579	47.956	0.376
51	503	51.611	49.946	-1.665
100	354	50.847	47.886	-2.961
100	363	48.975	45.254	-3.721
100	366	52.189	48.820	-3.369
100	383	45.959	48.409	2.450
100	417	47.820	46.711	-1.110
101	513	50.584	47.649	-2.935
101	526	51.689	48.237	-3.452
101	532	51.090	47.658	-3.432
101	533	51.414	48.503	-2.911
101	534	51.139	47.821	-3.318
Max		52.189	52.304	4.325
Average		49.818	49.094	-0.724
Min		45.959	45.254	-3.721
Std Dev		1.879	1.736	2.477

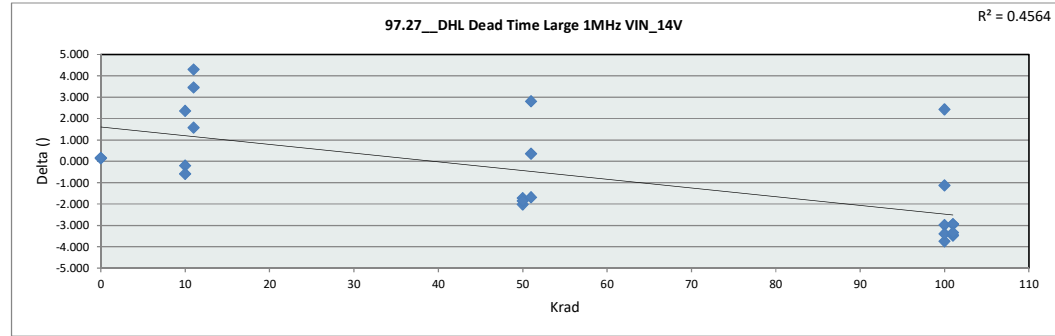

97.27 DHL Dead Time Large	
Test Site	DAL
Tester	ETS364
Test Number	EB672303
Max Limit	61
Min Limit	44

	0	10	11	50	51	100	101
LL	44.000	44.000	44.000	44.000	44.000	44.000	44.000
Min	51.185	50.543	49.559	47.121	47.956	45.254	47.649
Average	51.745	50.565	50.760	48.553	49.392	47.416	47.973
Max	52.304	50.610	51.746	49.856	50.275	48.820	48.503
UL	61.000	61.000	61.000	61.000	61.000	61.000	61.000

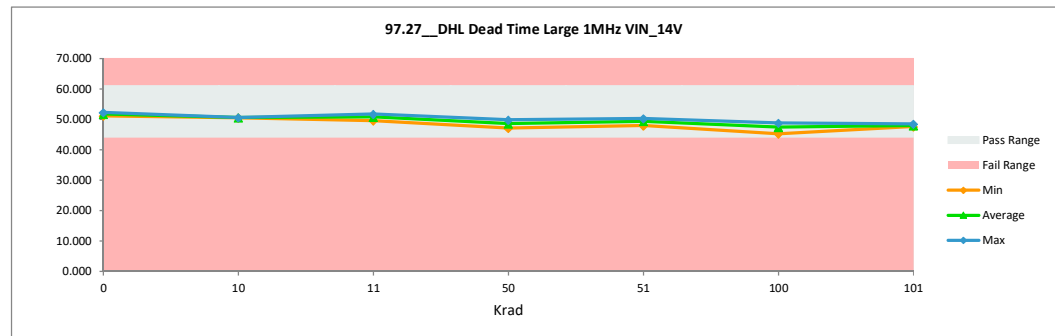

TID "HDR" Report
5962R2220102VXC

97.28 DHL Dead Time Max 1MHz		
Test Site	DAL	DAL
Tester	ETS364	ETS364
Test Number	EB672303	EB672303
Unit		
Max Limit	125	125
Min Limit	86	86

Krad	Serial #	Pre_HDR_6013	Post_HDR_6013	Delta
0	1	99.840	100.252	0.413
0	2	104.065	104.136	0.071
10	182	100.364	99.995	-0.369
10	202	100.409	99.480	-0.929
10	204	95.143	98.527	3.384
11	418	93.739	99.933	6.194
11	419	94.291	97.331	3.040
11	443	93.185	102.054	8.869
50	259	96.133	91.463	-4.670
50	346	98.150	94.146	-4.004
50	347	101.222	97.131	-4.092
51	462	92.914	98.382	5.468
51	478	94.155	93.939	-0.216
51	503	102.137	98.330	-3.807
100	354	100.517	93.185	-7.332
100	363	95.659	86.981	-8.679
100	366	102.910	95.067	-7.844
100	383	91.155	94.481	3.326
100	417	93.881	91.512	-2.370
101	513	99.255	92.481	-6.774
101	526	102.078	94.511	-7.567
101	532	101.077	93.422	-7.656
101	533	101.456	94.404	-7.052
101	534	100.851	93.307	-7.545
Max		104.065	104.136	8.869
Average		98.108	96.019	-2.089
Min		91.155	86.981	-8.679
Std Dev		3.809	3.939	5.145

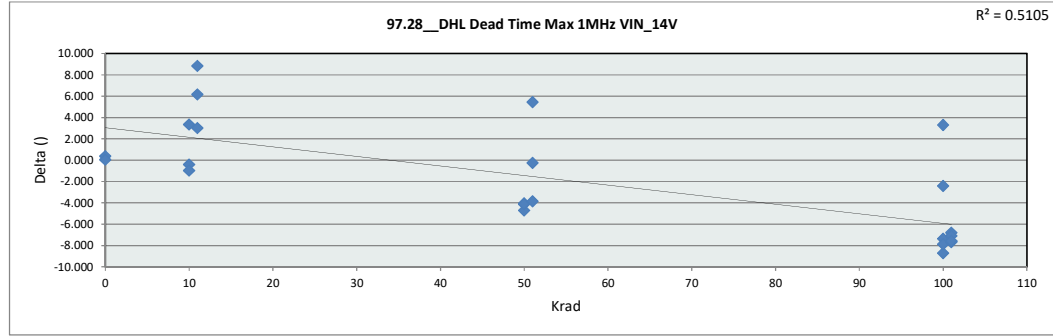

97.28 DHL Dead Time Max 1MHz	
Test Site	DAL
Tester	ETS364
Test Number	EB672303
Max Limit	125
Min Limit	86

Krad	0	10	11	50	51	100	101
LL	86.000	86.000	86.000	86.000	86.000	86.000	86.000
Min	100.252	98.527	97.331	91.463	93.939	86.981	92.481
Average	102.194	99.334	99.773	94.247	96.884	92.245	93.625
Max	104.136	99.995	102.054	97.131	98.382	95.067	94.511
UL	125.000	125.000	125.000	125.000	125.000	125.000	125.000

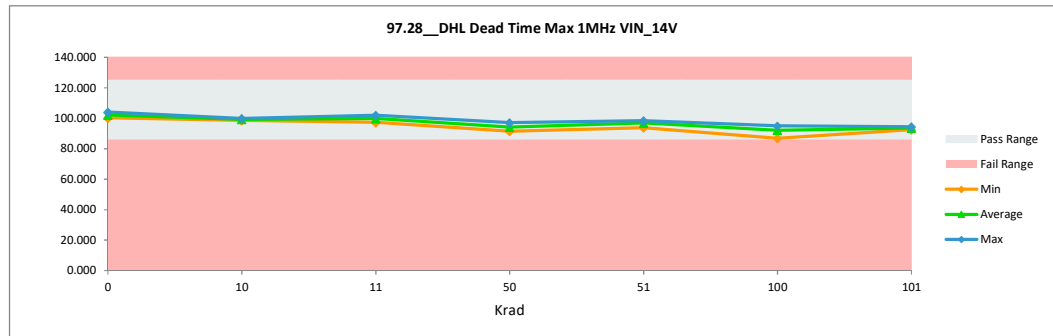

TID "HDR" Report
5962R2220102VXC

97.29 DHL Dead Time Min 2MH		
Test Site	DAL	DAL
Tester	ETS364	ETS364
Test Number	EB672303	EB672303
Unit		
Max Limit	10	10
Min Limit	0	0

Krad	Serial #	Pre_HDR_6013	Post_HDR_6013	Delta
0	1	4.662	4.866	0.204
0	2	3.849	3.868	0.018
10	182	4.175	4.449	0.273
10	202	4.691	4.939	0.248
10	204	4.016	5.388	1.372
11	418	3.811	4.972	1.161
11	419	4.200	4.730	0.531
11	443	4.136	4.651	0.515
50	259	5.076	5.162	0.086
50	346	5.638	5.900	0.261
50	347	4.649	4.903	0.254
51	462	4.589	4.716	0.127
51	478	3.958	4.562	0.604
51	503	4.761	4.492	-0.268
100	354	4.416	4.910	0.494
100	363	4.867	5.632	0.765
100	366	4.577	5.045	0.468
100	383	2.866	4.729	1.863
100	417	4.307	5.332	1.025
101	513	4.353	5.236	0.883
101	526	4.079	4.550	0.471
101	532	4.698	4.741	0.043
101	533	4.817	4.905	0.088
101	534	5.057	4.813	-0.245
	Max	5.638	5.900	1.863
	Average	4.427	4.895	0.468
	Min	2.866	3.868	-0.268
	Std Dev	0.549	0.419	0.508

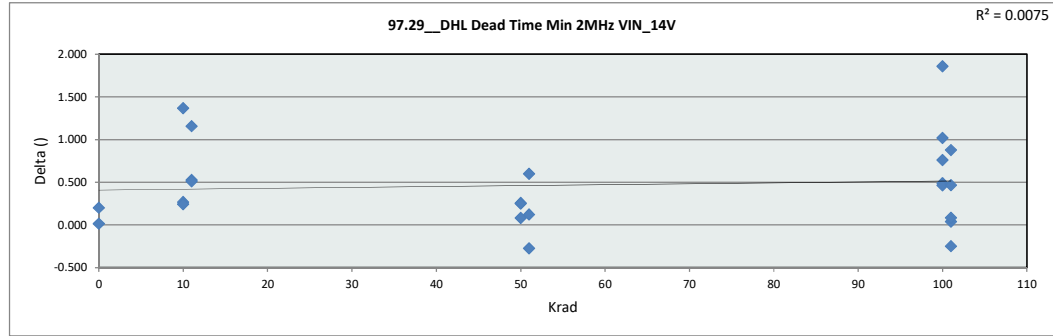

97.29 DHL Dead Time Min 2M	
Test Site	DAL
Tester	ETS364
Test Number	EB672303
Max Limit	10
Min Limit	0

	0	10	11	50	51	100	101
LL	0.000	0.000	0.000	0.000	0.000	0.000	0.000
Min	3.868	4.449	4.651	4.903	4.492	4.729	4.550
Average	4.367	4.925	4.785	5.322	4.590	5.130	4.849
Max	4.866	5.388	4.972	5.900	4.716	5.632	5.236
UL	10.000	10.000	10.000	10.000	10.000	10.000	10.000

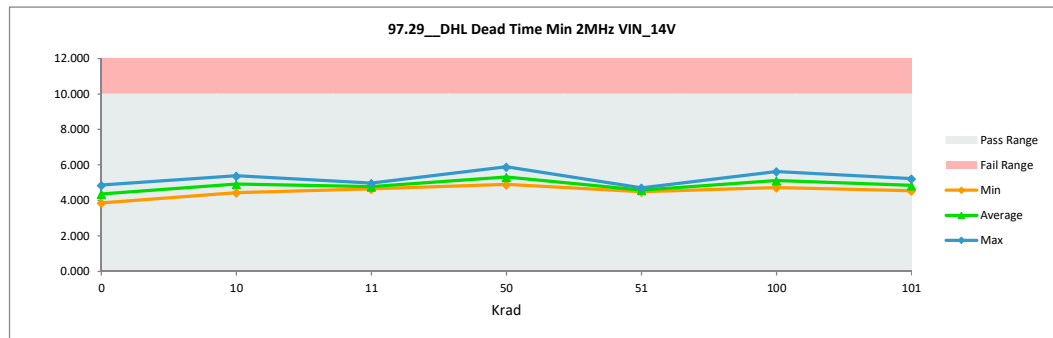

TID "HDR" Report
5962R2220102VXC

97.30 DHL Dead Time Small 2M		
Test Site	DAL	DAL
Tester	ETS364	ETS364
Test Number	EB672303	EB672303
Unit		
Max Limit	15	15
Min Limit	6	6

Krad	Serial #	Pre_HDR_6013	Post_HDR_6013	Delta
0	1	10.345	10.407	0.062
0	2	9.741	9.840	0.099
10	182	9.840	9.965	0.125
10	202	10.109	10.399	0.290
10	204	9.319	10.633	1.314
11	418	9.012	10.260	1.247
11	419	9.408	10.242	0.834
11	443	9.111	10.072	0.961
50	259	10.261	9.933	-0.328
50	346	10.766	10.800	0.033
50	347	10.201	10.275	0.074
51	462	9.517	9.977	0.459
51	478	8.985	9.582	0.597
51	503	10.136	9.884	-0.252
100	354	9.936	10.017	0.080
100	363	10.175	10.414	0.239
100	366	10.362	10.128	-0.234
100	383	8.133	9.598	1.465
100	417	9.503	10.115	0.611
101	513	10.085	10.026	-0.059
101	526	9.709	9.676	-0.033
101	532	10.039	9.657	-0.382
101	533	10.156	10.132	-0.023
101	534	10.379	10.035	-0.343
Max		10.766	10.800	1.465
Average		9.801	10.086	0.285
Min		8.133	9.582	-0.382
Std Dev		0.589	0.311	0.541

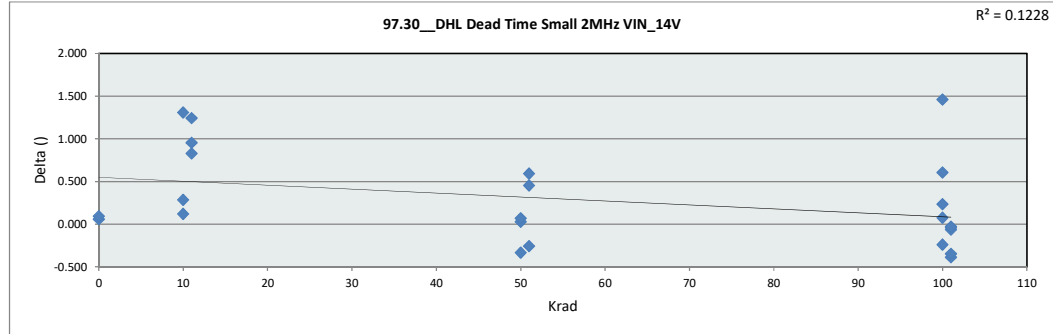

97.30 DHL Dead Time Small	
Test Site	DAL
Tester	ETS364
Test Number	EB672303
Max Limit	15
Min Limit	6

Krad	0	10	11	50	51	100	101
LL	6.000	6.000	6.000	6.000	6.000	6.000	6.000
Min	9.840	9.966	10.072	9.933	9.582	9.598	9.657
Average	10.124	10.333	10.191	10.336	9.814	10.054	9.905
Max	10.407	10.633	10.260	10.800	9.977	10.414	10.132
UL	15.000	15.000	15.000	15.000	15.000	15.000	15.000

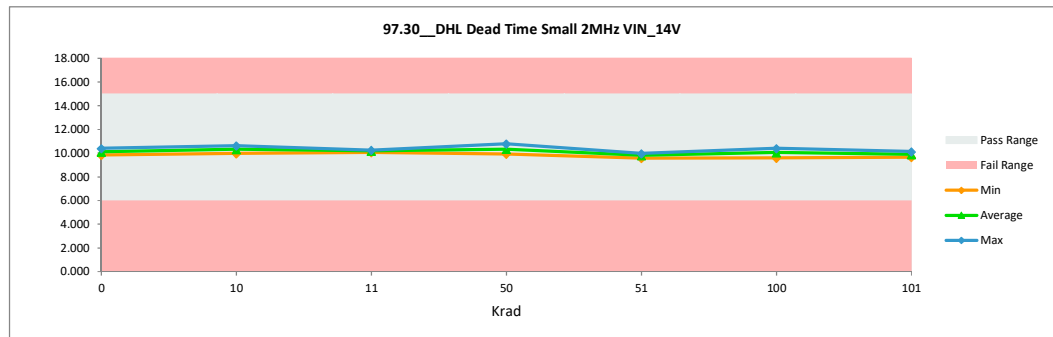

TID "HDR" Report
5962R2220102VXC

97.31 DHL Dead Time Mid 2MH		
Test Site	DAL	DAL
Tester	ETS364	ETS364
Test Number	EB672303	EB672303
Unit		
Max Limit	24.5	24.5
Min Limit	16	16

Krad	Serial #	Pre_HDR_6013	Post_HDR_6013	Delta
0	1	20.434	20.612	0.178
0	2	20.193	20.311	0.118
10	182	20.000	19.930	-0.070
10	202	20.350	20.289	-0.061
10	204	18.872	20.594	1.722
11	418	18.436	20.407	1.970
11	419	18.829	19.848	1.019
11	443	18.639	20.413	1.775
50	259	19.832	19.133	-0.700
50	346	20.470	20.341	-0.129
50	347	20.508	19.997	-0.511
51	462	18.922	20.034	1.112
51	478	18.361	19.273	0.912
51	503	20.307	19.649	-0.659
100	354	20.118	19.320	-0.799
100	363	19.673	19.023	-0.650
100	366	20.630	19.584	-1.045
100	383	17.566	19.529	1.963
100	417	18.991	19.130	0.139
101	513	20.017	19.409	-0.608
101	526	20.223	19.218	-1.005
101	532	20.216	19.156	-1.059
101	533	20.487	19.813	-0.674
101	534	20.537	19.322	-1.215
	Max	20.630	20.612	1.970
	Average	19.692	19.764	0.072
	Min	17.566	19.023	-1.215
	Std Dev	0.873	0.519	1.036

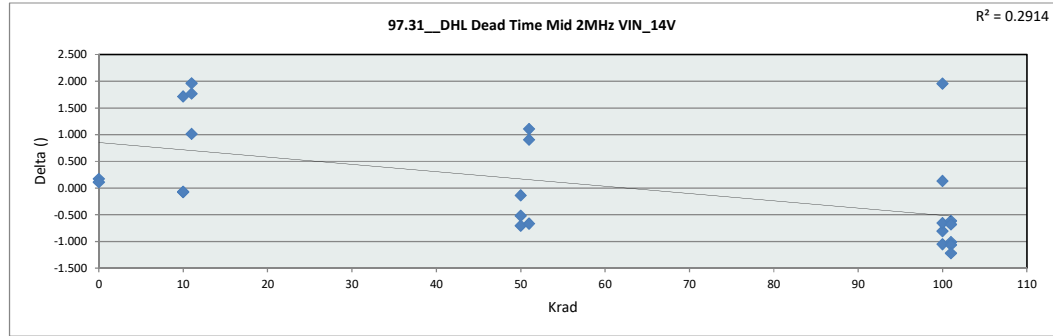

97.31 DHL Dead Time Mid 2M	
Test Site	DAL
Tester	ETS364
Test Number	EB672303
Max Limit	24.5
Min Limit	16

Krad	0	10	11	50	51	100	101
LL	16.000	16.000	16.000	16.000	16.000	16.000	16.000
Min	20.311	19.930	19.848	19.133	19.273	19.023	19.157
Average	20.461	20.271	20.223	19.824	19.652	19.317	19.384
Max	20.612	20.594	20.413	20.341	20.034	19.584	19.813
UL	24.500	24.500	24.500	24.500	24.500	24.500	24.500

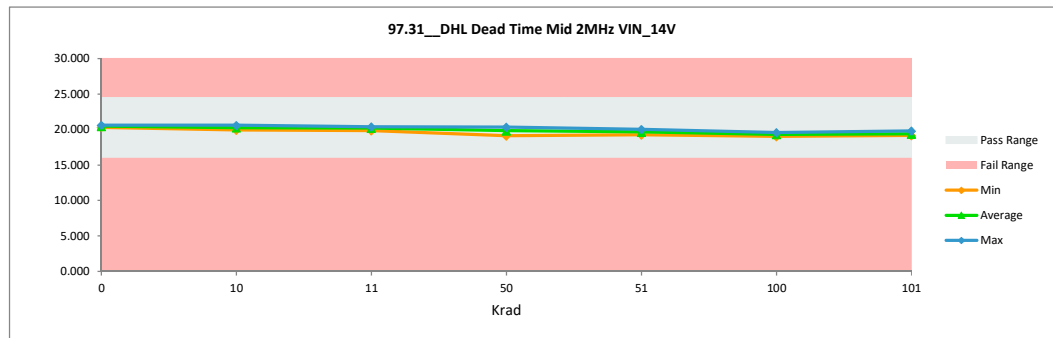

TID "HDR" Report
5962R2220102VXC

97.32 DHL Dead Time Large 2M		
Test Site	DAL	DAL
Tester	ETS364	ETS364
Test Number	EB672303	EB672303
Unit		
Max Limit	61	61
Min Limit	44	44

Krad	Serial #	Pre_HDR_6013	Post_HDR_6013	Delta
0	1	51.711	51.848	0.137
0	2	52.884	53.170	0.286
10	182	51.549	51.246	-0.302
10	202	51.838	51.329	-0.509
10	204	48.822	51.240	2.418
11	418	48.058	51.488	3.431
11	419	48.492	50.026	1.534
11	443	48.105	52.570	4.465
50	259	49.667	47.550	-2.116
50	346	50.773	49.356	-1.417
50	347	52.206	50.372	-1.834
51	462	47.941	50.858	2.916
51	478	48.290	48.565	0.275
51	503	52.353	50.522	-1.831
100	354	51.625	48.360	-3.266
100	363	49.486	45.670	-3.816
100	366	52.870	49.230	-3.639
100	383	46.545	49.210	2.665
100	417	48.494	47.361	-1.132
101	513	51.089	48.246	-2.843
101	526	52.658	48.853	-3.806
101	532	51.728	48.212	-3.516
101	533	52.365	49.307	-3.057
101	534	52.105	48.302	-3.802
Max		52.884	53.170	4.465
Average		50.485	49.704	-0.782
Min		46.545	45.670	-3.816
Std Dev		1.948	1.809	2.580

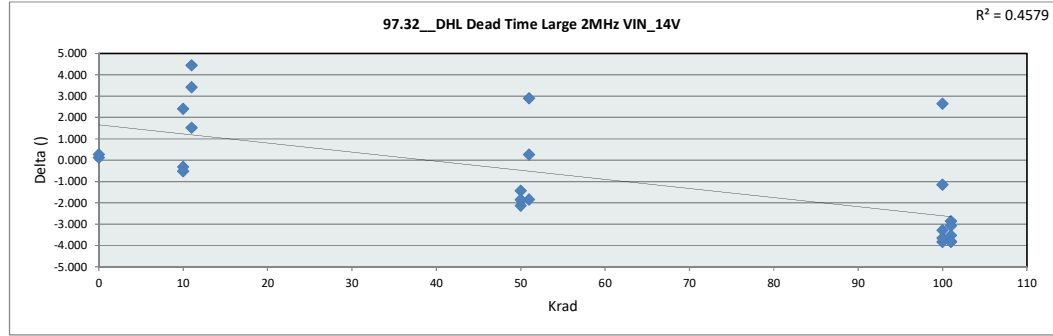

97.32 DHL Dead Time Large	
Test Site	DAL
Tester	ETS364
Test Number	EB672303
Max Limit	61
Min Limit	44

Krad	0	10	11	50	51	100	101
LL	44.000	44.000	44.000	44.000	44.000	44.000	44.000
Min	51.848	51.240	50.026	47.550	48.565	45.670	48.212
Average	52.509	51.272	51.361	49.093	49.981	47.966	48.584
Max	53.170	51.330	52.570	50.372	50.858	49.231	49.307
UL	61.000	61.000	61.000	61.000	61.000	61.000	61.000

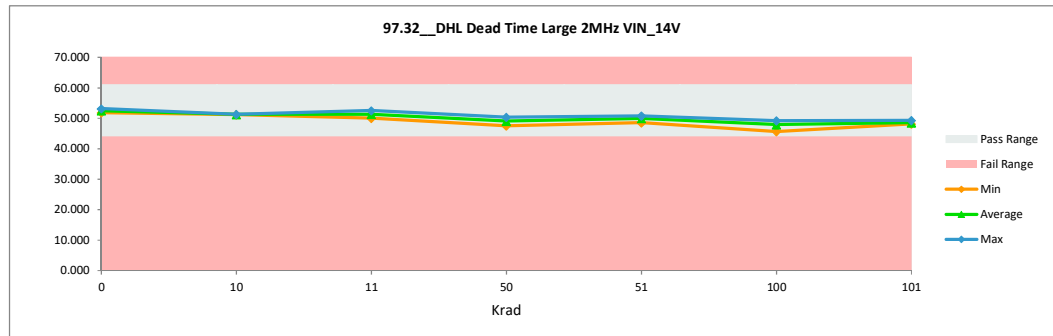

TID "HDR" Report
5962R2220102VXC

97.33 DHL Dead Time Max 2MHz		
Test Site	DAL	DAL
Tester	ETS364	ETS364
Test Number	EB672303	EB672303
Unit		
Max Limit	125	125
Min Limit	86	86

Krad	Serial #	Pre_HDR_6013	Post_HDR_6013	Delta
0	1	103.124	103.504	0.380
0	2	107.512	107.668	0.156
10	182	103.600	103.038	-0.561
10	202	103.472	102.557	-0.915
10	204	98.145	101.697	3.552
11	418	96.625	102.873	6.248
11	419	97.163	100.378	3.215
11	443	96.180	105.574	9.394
50	259	99.021	94.342	-4.679
50	346	101.255	97.049	-4.206
50	347	104.390	100.148	-4.242
51	462	95.870	101.462	5.592
51	478	97.223	96.896	-0.327
51	503	105.695	101.338	-4.356
100	354	103.586	96.131	-7.454
100	363	98.582	89.527	-9.055
100	366	106.004	98.013	-7.991
100	383	94.087	97.568	3.481
100	417	96.945	94.414	-2.531
101	513	102.131	95.398	-6.733
101	526	105.660	97.582	-8.078
101	532	104.341	96.515	-7.826
101	533	104.621	97.740	-6.882
101	534	103.980	96.257	-7.723
Max		107.512	107.668	9.394
Average		101.217	99.070	-2.147
Min		94.087	89.527	-9.055
Std Dev		3.956	4.100	5.306

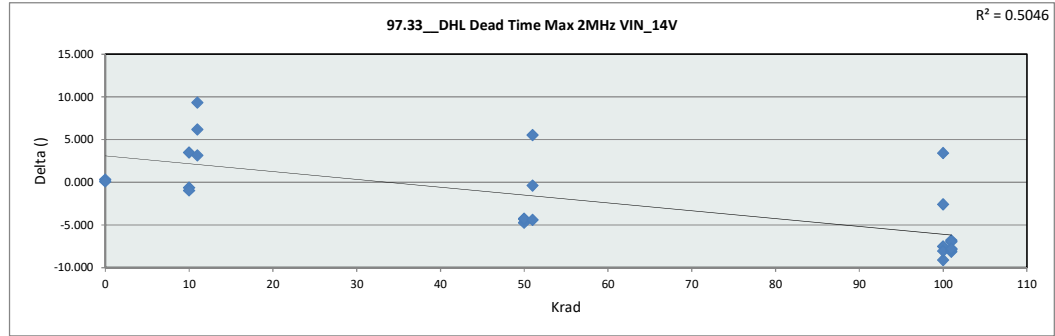

97.33 DHL Dead Time Max 2MHz	
Test Site	DAL
Tester	ETS364
Test Number	EB672303
Max Limit	125
Min Limit	86

Krad	0	10	11	50	51	100	101
LL	86.000	86.000	86.000	86.000	86.000	86.000	86.000
Min	103.504	101.697	100.378	94.343	96.897	89.527	95.398
Average	105.586	102.431	102.942	97.180	99.899	95.131	96.698
Max	107.668	103.038	105.574	100.148	101.462	98.013	97.740
UL	125.000	125.000	125.000	125.000	125.000	125.000	125.000

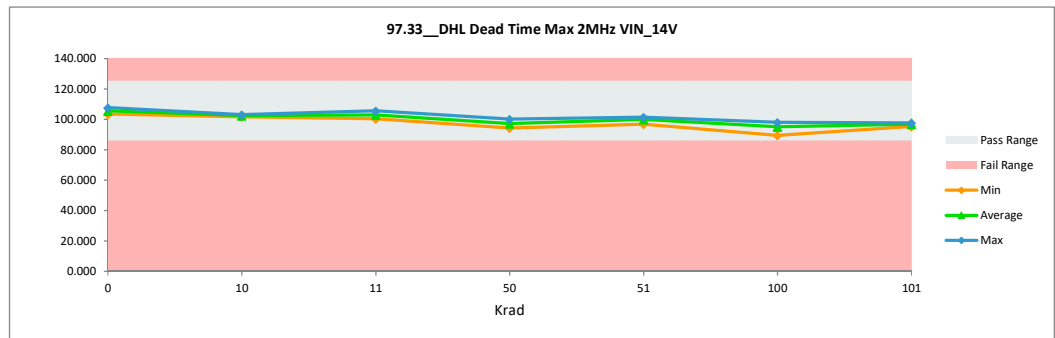

TID "HDR" Report
5962R2220102VXC

100.1 Bootstrap Diode Switch		
Test Site	DAL	DAL
Tester	ETS364	ETS364
Test Number	EB672303	EB672303
Unit	KOHMS	KOHMS
Max Limit	1.2	1.2
Min Limit	0.8	0.8

Krad	Serial #	Pre_HDR_6013	Post_HDR_6013	Delta
0	1	0.968	0.969	0.001
0	2	0.980	0.981	0.001
10	182	1.000	1.001	0.001
10	202	0.986	0.986	0.000
10	204	0.976	0.986	0.010
11	418	0.984	0.973	-0.011
11	419	0.980	0.984	0.003
11	443	1.001	0.984	-0.017
50	259	0.976	0.977	0.000
50	346	0.976	0.977	0.001
50	347	0.982	0.982	0.000
51	462	0.980	0.979	-0.002
51	478	0.984	0.997	0.014
51	503	0.982	0.982	0.000
100	354	0.981	0.982	0.001
100	363	0.992	0.984	-0.009
100	366	0.971	0.972	0.001
100	383	0.987	0.992	0.005
100	417	0.988	0.977	-0.011
101	513	0.973	0.973	0.000
101	526	0.984	0.984	0.000
101	532	0.984	0.984	0.000
101	533	0.983	0.983	0.000
101	534	0.983	0.984	0.000
	Max	1.001	1.001	0.014
	Average	0.983	0.982	-0.001
	Min	0.968	0.969	-0.017
	Std Dev	0.008	0.007	0.006

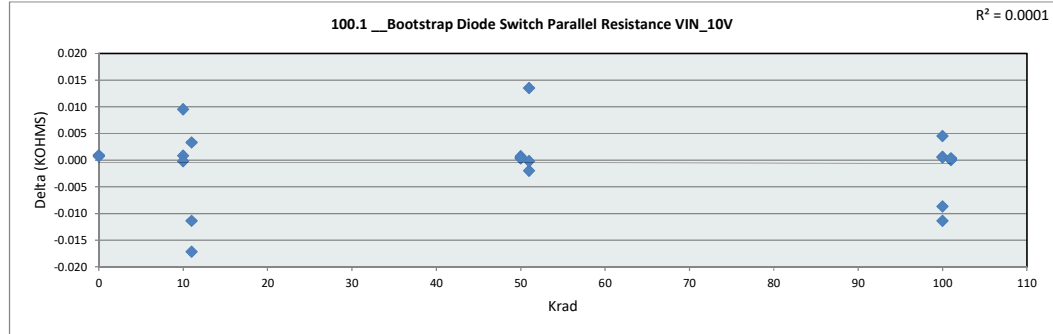

100.1 Bootstrap Diode Switch		
Test Site	DAL	
Tester	ETS364	
Test Number	EB672303	
Max Limit	1.2	KOHMS
Min Limit	0.8	KOHMS

Krad	0	10	11	50	51	100	101
LL	0.800	0.800	0.800	0.800	0.800	0.800	0.800
Min	0.969	0.986	0.973	0.977	0.979	0.972	0.973
Average	0.975	0.991	0.980	0.979	0.986	0.981	0.981
Max	0.981	1.001	0.984	0.982	0.997	0.992	0.984
UL	1.200	1.200	1.200	1.200	1.200	1.200	1.200

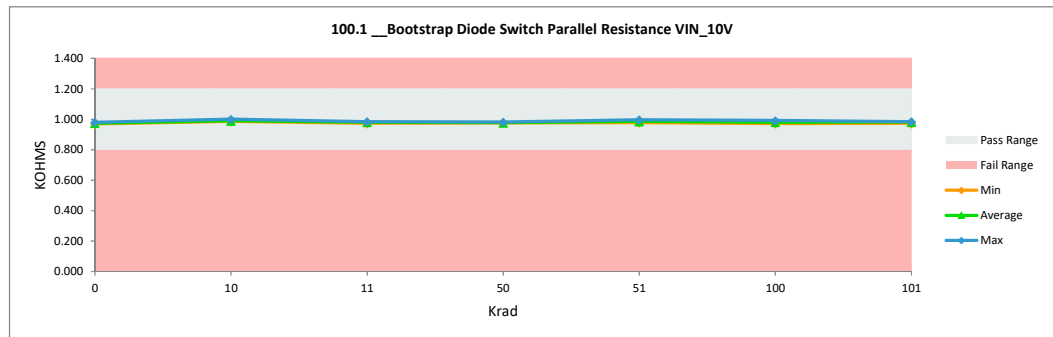

TID "HDR" Report
5962R2220102VXC

101.1 Bootstrap Diode Switch		
Test Site	DAL	DAL
Tester	ETS364	ETS364
Test Number	EB672303	EB672303
Unit	KOHMS	KOHMS
Max Limit	1.2	1.2
Min Limit	0.8	0.8

Krad	Serial #	Pre_HDR_6013	Post_HDR_6013	Delta
0	1	0.968	0.969	0.001
0	2	0.980	0.981	0.001
10	182	1.000	1.001	0.001
10	202	0.986	0.986	0.000
10	204	0.976	0.986	0.010
11	418	0.984	0.973	-0.011
11	419	0.980	0.984	0.003
11	443	1.002	0.984	-0.017
50	259	0.976	0.977	0.001
50	346	0.976	0.977	0.001
50	347	0.982	0.982	0.000
51	462	0.980	0.979	-0.002
51	478	0.984	0.998	0.013
51	503	0.982	0.982	0.000
100	354	0.981	0.982	0.001
100	363	0.992	0.984	-0.009
100	366	0.971	0.972	0.001
100	383	0.987	0.992	0.005
100	417	0.988	0.977	-0.011
101	513	0.973	0.973	0.000
101	526	0.984	0.984	0.000
101	532	0.984	0.984	0.000
101	533	0.983	0.983	0.000
101	534	0.983	0.984	0.000
Max		1.002	1.001	0.013
Average		0.983	0.982	-0.001
Min		0.968	0.969	-0.017
Std Dev		0.008	0.007	0.006

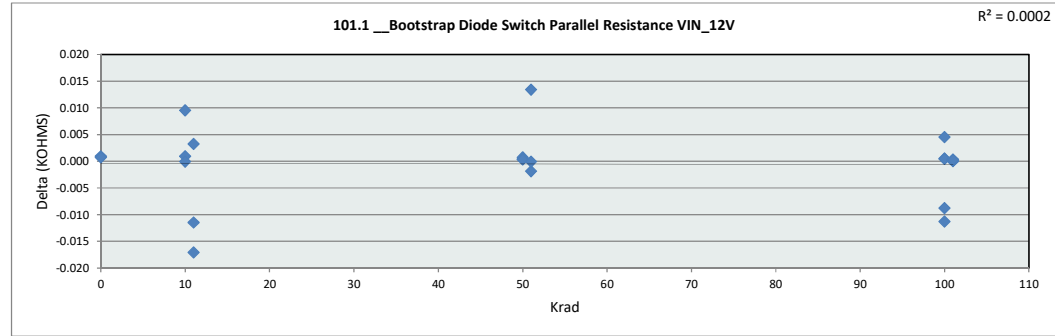

101.1 Bootstrap Diode Switch		
Test Site	DAL	
Tester	ETS364	
Test Number	EB672303	
Max Limit	1.2	KOHMS
Min Limit	0.8	KOHMS

Krad	0	10	11	50	51	100	101
LL	0.800	0.800	0.800	0.800	0.800	0.800	0.800
Min	0.969	0.986	0.973	0.977	0.979	0.972	0.973
Average	0.975	0.991	0.980	0.979	0.986	0.981	0.982
Max	0.981	1.001	0.985	0.982	0.998	0.992	0.984
UL	1.200	1.200	1.200	1.200	1.200	1.200	1.200

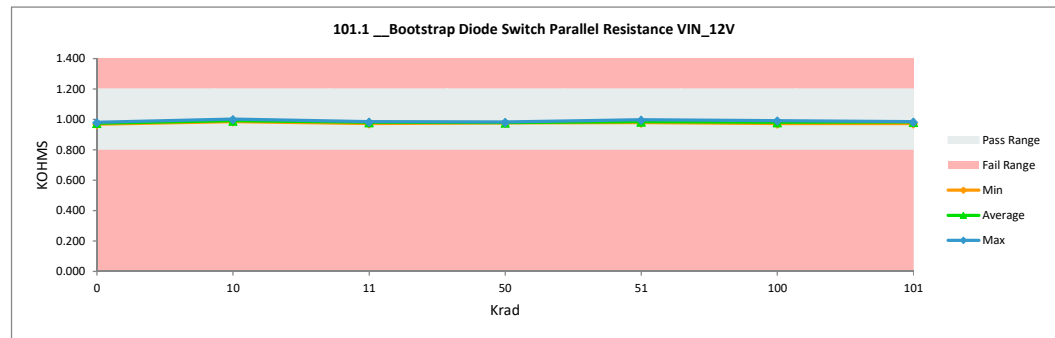

TID "HDR" Report
5962R2220102VXC

102.1 Bootstrap Diode Switch		
Test Site	DAL	DAL
Tester	ETS364	ETS364
Test Number	EB672303	EB672303
Unit	KOHMS	KOHMS
Max Limit	1.2	1.2
Min Limit	0.8	0.8

Krad	Serial #	Pre_HDR_6013	Post_HDR_6013	Delta
0	1	0.968	0.969	0.001
0	2	0.980	0.981	0.001
10	182	1.000	1.001	0.001
10	202	0.986	0.986	0.000
10	204	0.976	0.986	0.010
11	418	0.984	0.973	-0.011
11	419	0.980	0.984	0.003
11	443	1.002	0.985	-0.017
50	259	0.976	0.977	0.001
50	346	0.976	0.977	0.001
50	347	0.982	0.982	0.000
51	462	0.981	0.979	-0.002
51	478	0.984	0.998	0.014
51	503	0.983	0.983	0.000
100	354	0.981	0.982	0.001
100	363	0.992	0.984	-0.009
100	366	0.971	0.972	0.000
100	383	0.987	0.992	0.005
100	417	0.988	0.977	-0.011
101	513	0.973	0.973	0.000
101	526	0.984	0.984	0.000
101	532	0.984	0.984	0.000
101	533	0.983	0.983	0.000
101	534	0.983	0.984	0.000
Max		1.002	1.001	0.014
Average		0.983	0.982	0.000
Min		0.968	0.969	-0.017
Std Dev		0.008	0.007	0.006

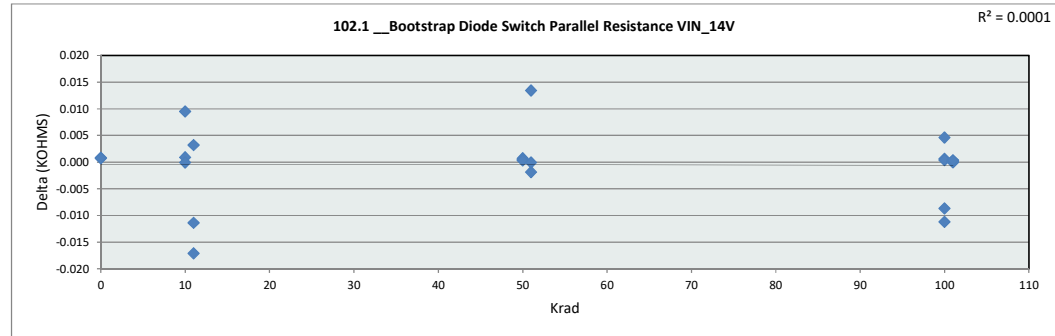

102.1 Bootstrap Diode Switch		
Test Site	DAL	
Tester	ETS364	
Test Number	EB672303	
Max Limit	1.2	KOHMS
Min Limit	0.8	KOHMS

Krad	0	10	11	50	51	100	101
LL	0.800	0.800	0.800	0.800	0.800	0.800	0.800
Min	0.969	0.986	0.973	0.977	0.979	0.972	0.973
Average	0.975	0.991	0.981	0.979	0.986	0.981	0.982
Max	0.981	1.001	0.985	0.982	0.998	0.992	0.985
UL	1.200	1.200	1.200	1.200	1.200	1.200	1.200

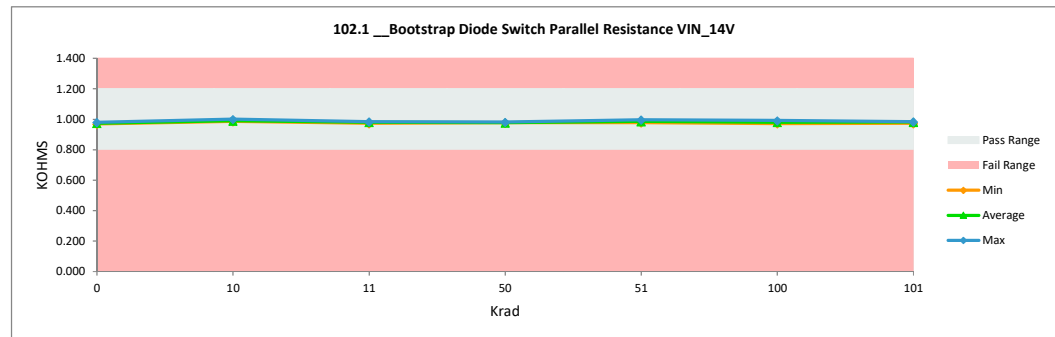

TID "HDR" Report
5962R2220102VXC

105.0_PGOOD Logic Low Outupt		
Test Site	DAL	DAL
Tester	ETS364	ETS364
Test Number	EB672303	EB672303
Unit	V	V
Max Limit	0.4	0.4
Min Limit	0	0

Krad	Serial #	Pre_HDR_6013	Post_HDR_6013	Delta
0	1	0.201	0.197	-0.004
0	2	0.195	0.192	-0.003
10	182	0.199	0.194	-0.005
10	202	0.203	0.202	-0.001
10	204	0.200	0.192	-0.008
11	418	0.197	0.201	0.004
11	419	0.198	0.193	-0.005
11	443	0.197	0.201	0.004
50	259	0.201	0.196	-0.005
50	346	0.201	0.195	-0.006
50	347	0.200	0.195	-0.005
51	462	0.200	0.194	-0.005
51	478	0.200	0.197	-0.003
51	503	0.199	0.196	-0.003
100	354	0.199	0.193	-0.006
100	363	0.197	0.197	-0.001
100	366	0.203	0.197	-0.005
100	383	0.199	0.193	-0.005
100	417	0.200	0.195	-0.005
101	513	0.199	0.195	-0.004
101	526	0.192	0.188	-0.004
101	532	0.200	0.195	-0.006
101	533	0.201	0.195	-0.006
101	534	0.202	0.197	-0.005
Max		0.203	0.202	0.004
Average		0.199	0.195	-0.004
Min		0.192	0.188	-0.008
Std Dev		0.002	0.003	0.003

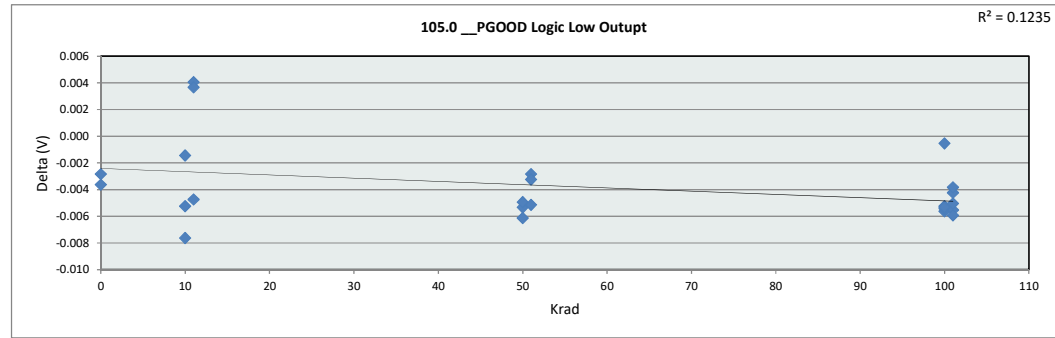

105.0_PGOOD Logic Low Out		
Test Site	DAL	
Tester	ETS364	
Test Number	EB672303	
Max Limit	0.4	V
Min Limit	0	V

Krad	0	10	11	50	51	100	101
LL	0.000	0.000	0.000	0.000	0.000	0.000	0.000
Min	0.192	0.192	0.193	0.195	0.195	0.193	0.188
Average	0.195	0.196	0.198	0.195	0.196	0.195	0.194
Max	0.197	0.202	0.201	0.196	0.197	0.197	0.197
UL	0.400	0.400	0.400	0.400	0.400	0.400	0.400

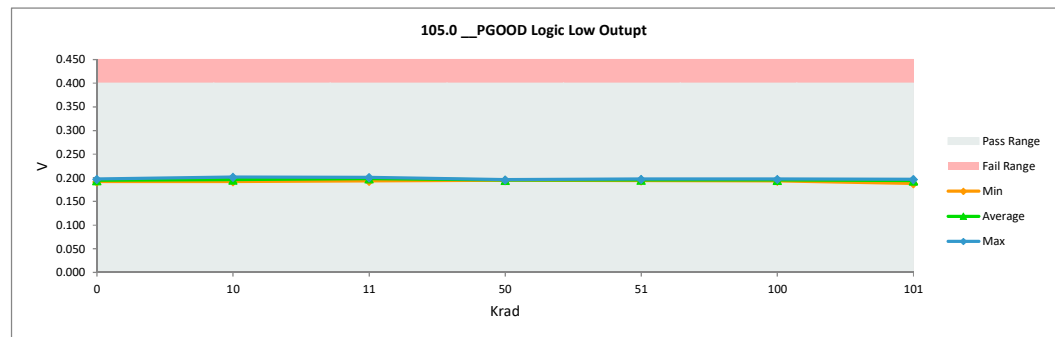

TID "HDR" Report
5962R2220102VXC

105.1 Min BP5L for Valid PGOOD		
Test Site	DAL	DAL
Tester	ETS364	ETS364
Test Number	EB672303	EB672303
Unit	V	V
Max Limit	2.45	2.45
Min Limit	0.1	0.1

Krad	Serial #	Pre_HDR_6013	Post_HDR_6013	Delta
0	1	2.103	2.105	0.002
0	2	1.976	1.977	0.001
10	182	1.934	1.921	-0.013
10	202	1.976	1.958	-0.018
10	204	1.907	2.002	0.095
11	418	1.907	2.090	0.183
11	419	1.911	2.019	0.107
11	443	1.941	2.051	0.110
50	259	1.980	1.888	-0.092
50	346	1.987	1.896	-0.091
50	347	2.086	1.999	-0.088
51	462	1.822	1.950	0.128
51	478	1.973	1.851	-0.122
51	503	1.999	1.916	-0.083
100	354	1.996	1.828	-0.168
100	363	2.017	1.809	-0.208
100	366	2.083	1.936	-0.147
100	383	1.909	1.894	-0.015
100	417	1.923	1.861	-0.062
101	513	1.946	1.769	-0.176
101	526	2.048	1.873	-0.175
101	532	1.937	1.767	-0.170
101	533	1.913	1.753	-0.160
101	534	1.952	1.795	-0.156
Max		2.103	2.105	0.183
Average		1.968	1.913	-0.055
Min		1.822	1.753	-0.208
Std Dev		0.066	0.100	0.113

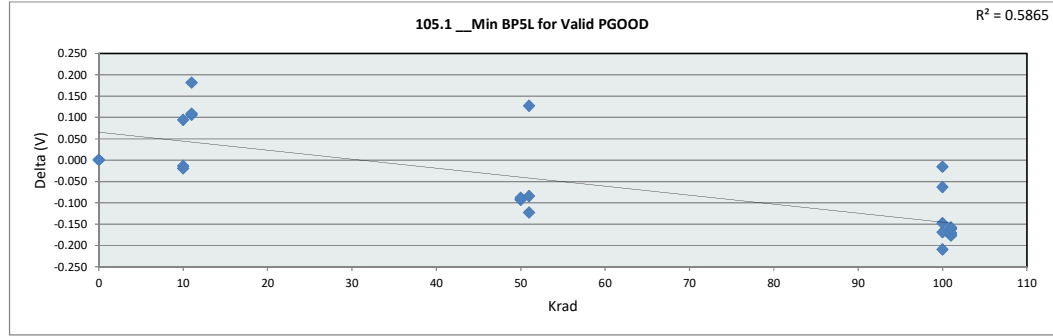

105.1 Min BP5L for Valid PG		
Test Site	DAL	
Tester	ETS364	
Test Number	EB672303	
Max Limit	2.45	V
Min Limit	0.1	V

Krad	0	10	11	50	51	100	101
LL	0.100	0.100	0.100	0.100	0.100	0.100	0.100
Min	1.977	1.921	2.019	1.888	1.851	1.809	1.753
Average	2.041	1.960	2.053	1.927	1.906	1.866	1.792
Max	2.105	2.002	2.090	1.999	1.950	1.937	1.873
UL	2.450	2.450	2.450	2.450	2.450	2.450	2.450

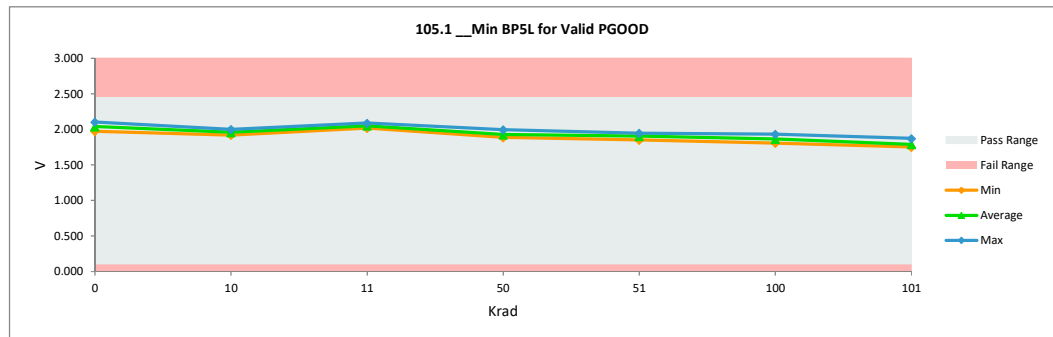

TID "HDR" Report
5962R2220102VXC

105.2_PGOOD Internal Resistance

Test Site	DAL	DAL
Tester	ETS364	ETS364
Test Number	EB672303	EB672303
Unit	MOHMS	MOHMS
Max Limit	1.9	1.9
Min Limit	0.7	0.7

Krad	Serial #	Pre_HDR_6013	Post_HDR_6013	Delta
0	1	1.067	1.076	0.009
0	2	1.051	1.062	0.010
10	182	1.089	1.104	0.015
10	202	1.067	1.069	0.002
10	204	1.033	1.084	0.051
11	418	1.046	1.019	-0.027
11	419	1.038	1.054	0.015
11	443	1.083	1.054	-0.030
50	259	1.050	1.057	0.007
50	346	1.032	1.041	0.009
50	347	1.044	1.052	0.008
51	462	1.043	1.034	-0.009
51	478	1.050	1.073	0.023
51	503	1.030	1.031	0.000
100	354	1.043	1.049	0.006
100	363	1.066	1.055	-0.011
100	366	1.053	1.058	0.005
100	383	1.049	1.084	0.035
100	417	1.052	1.052	0.000
101	513	1.049	1.047	-0.003
101	526	1.065	1.060	-0.005
101	532	1.040	1.042	0.003
101	533	1.055	1.052	-0.003
101	534	1.051	1.049	-0.002
Max		1.089	1.104	0.051
Average		1.052	1.057	0.005
Min		1.030	1.019	-0.030
Std Dev		0.015	0.018	0.017

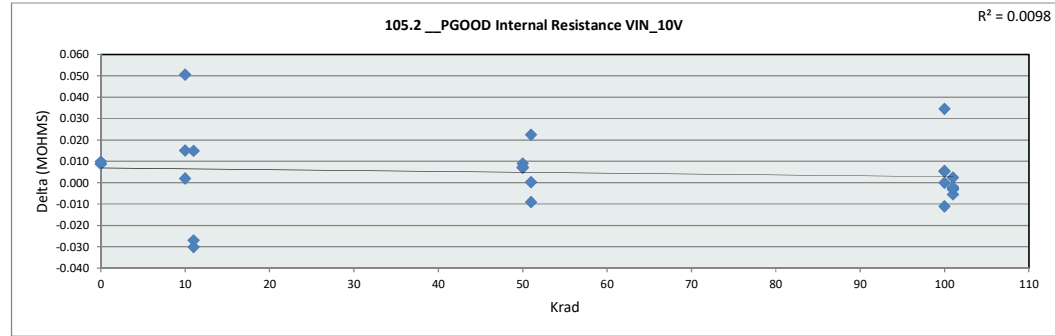

105.2_PGOOD Internal Resistance

Test Site	DAL
Tester	ETS364
Test Number	EB672303
Max Limit	1.9 MOHMS
Min Limit	0.7 MOHMS

Krad	0	10	11	50	51	100	101
LL	0.700	0.700	0.700	0.700	0.700	0.700	0.700
Min	1.062	1.069	1.019	1.041	1.031	1.049	1.042
Average	1.069	1.086	1.042	1.050	1.046	1.060	1.050
Max	1.076	1.104	1.054	1.057	1.073	1.084	1.060
UL	1.900	1.900	1.900	1.900	1.900	1.900	1.900

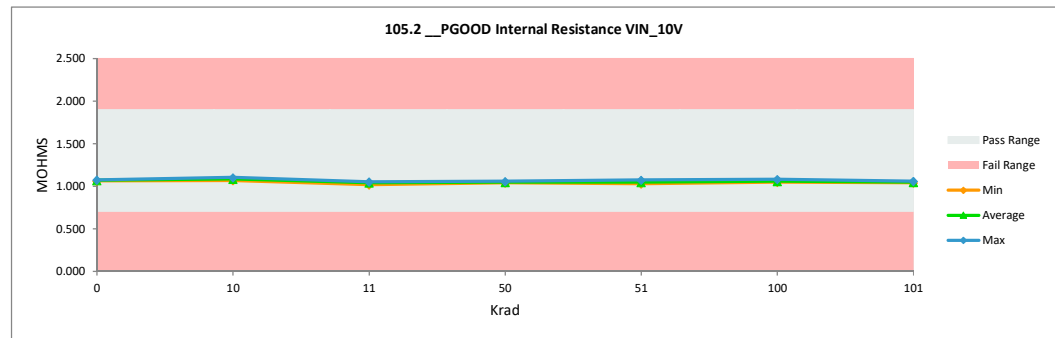

TID "HDR" Report
5962R2220102VXC

106.0 __PGOOD Logic Low Outupt		
Test Site	DAL	DAL
Tester	ETS364	ETS364
Test Number	EB672303	EB672303
Unit	V	V
Max Limit	0.4	0.4
Min Limit	0	0

Krad	Serial #	Pre_HDR_6013	Post_HDR_6013	Delta
0	1	0.201	0.197	-0.003
0	2	0.194	0.191	-0.003
10	182	0.199	0.194	-0.005
10	202	0.203	0.201	-0.001
10	204	0.200	0.192	-0.008
11	418	0.196	0.200	0.004
11	419	0.198	0.193	-0.005
11	443	0.197	0.201	0.004
50	259	0.201	0.196	-0.005
50	346	0.201	0.195	-0.006
50	347	0.199	0.194	-0.005
51	462	0.199	0.194	-0.005
51	478	0.200	0.197	-0.003
51	503	0.199	0.195	-0.003
100	354	0.199	0.193	-0.006
100	363	0.197	0.197	-0.001
100	366	0.203	0.197	-0.006
100	383	0.199	0.193	-0.005
100	417	0.200	0.195	-0.005
101	513	0.199	0.195	-0.004
101	526	0.192	0.188	-0.004
101	532	0.200	0.194	-0.005
101	533	0.200	0.195	-0.006
101	534	0.202	0.197	-0.005
Max		0.203	0.201	0.004
Average		0.199	0.195	-0.004
Min		0.192	0.188	-0.008
Std Dev		0.002	0.003	0.003

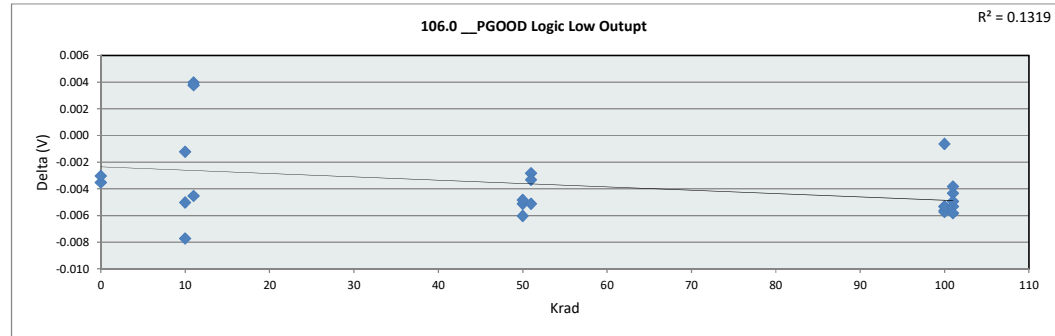

106.0 __PGOOD Logic Low Outupt		
Test Site	DAL	
Tester	ETS364	
Test Number	EB672303	
Max Limit	0.4	V
Min Limit	0	V

Krad	0	10	11	50	51	100	101
LL	0.000	0.000	0.000	0.000	0.000	0.000	0.000
Min	0.192	0.192	0.193	0.195	0.194	0.193	0.188
Average	0.194	0.196	0.198	0.195	0.196	0.195	0.194
Max	0.197	0.202	0.201	0.196	0.197	0.197	0.197
UL	0.400	0.400	0.400	0.400	0.400	0.400	0.400

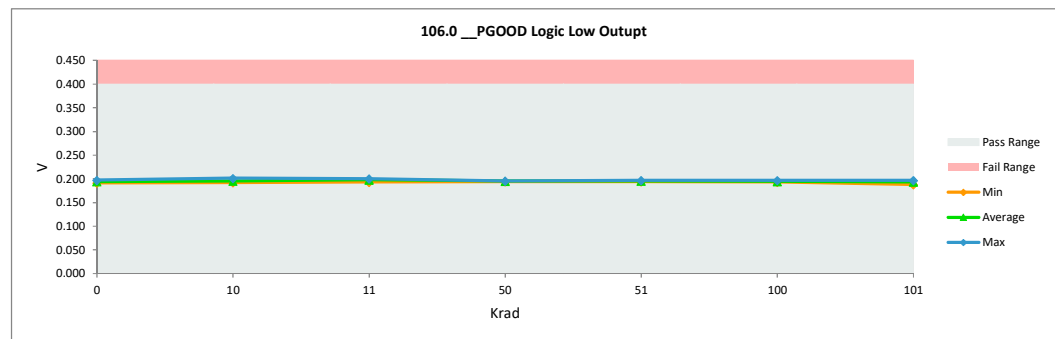

TID "HDR" Report
5962R2220102VXC

106.1 Min BP5L for Valid PGOOD		
Test Site	DAL	DAL
Tester	ETS364	ETS364
Test Number	EB672303	EB672303
Unit	V	V
Max Limit	2.45	2.45
Min Limit	0.1	0.1

Krad	Serial #	Pre_HDR_6013	Post_HDR_6013	Delta
0	1	2.103	2.105	0.002
0	2	1.976	1.977	0.001
10	182	1.929	1.916	-0.013
10	202	1.976	1.958	-0.018
10	204	1.906	2.002	0.096
11	418	1.907	2.089	0.182
11	419	1.911	2.019	0.107
11	443	1.941	2.051	0.110
50	259	1.980	1.888	-0.092
50	346	1.987	1.896	-0.091
50	347	2.086	1.999	-0.088
51	462	1.823	1.950	0.128
51	478	1.973	1.851	-0.122
51	503	2.000	1.916	-0.083
100	354	1.996	1.828	-0.168
100	363	2.017	1.809	-0.208
100	366	2.083	1.937	-0.147
100	383	1.909	1.890	-0.019
100	417	1.923	1.861	-0.062
101	513	1.946	1.770	-0.176
101	526	2.048	1.874	-0.175
101	532	1.937	1.767	-0.170
101	533	1.913	1.753	-0.160
101	534	1.952	1.795	-0.156
Max		2.103	2.105	0.182
Average		1.968	1.913	-0.055
Min		1.823	1.753	-0.208
Std Dev		0.066	0.100	0.113

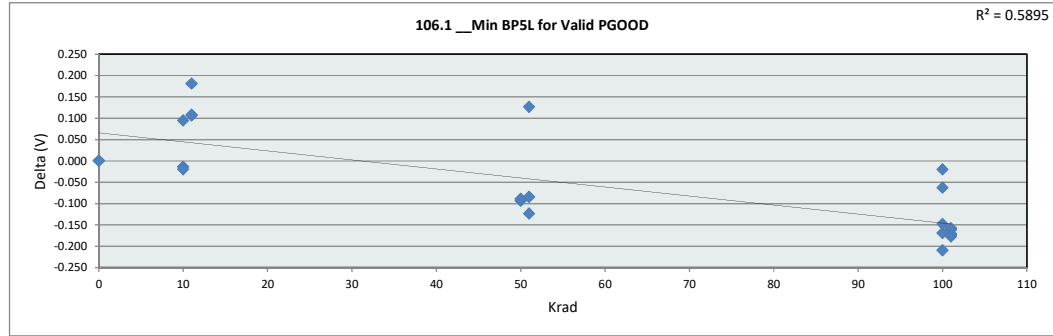

106.1 Min BP5L for Valid PG		
Test Site	DAL	
Tester	ETS364	
Test Number	EB672303	
Max Limit	2.45	
Min Limit	0.1	

Krad	0	10	11	50	51	100	101
LL	0.100	0.100	0.100	0.100	0.100	0.100	0.100
Min	1.977	1.916	2.019	1.888	1.851	1.809	1.753
Average	2.041	1.959	2.053	1.927	1.906	1.865	1.792
Max	2.105	2.002	2.089	1.999	1.950	1.937	1.874
UL	2.450	2.450	2.450	2.450	2.450	2.450	2.450

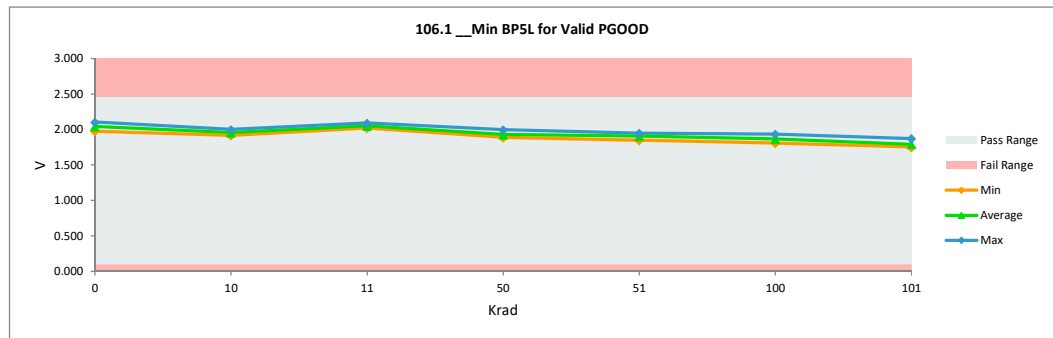

TID "HDR" Report
5962R2220102VXC

106.2_PGOOD Internal Resistance		
Test Site	DAL	DAL
Tester	ETS364	ETS364
Test Number	EB672303	EB672303
Unit	MOHMS	MOHMS
Max Limit	1.9	1.9
Min Limit	0.7	0.7

Krad	Serial #	Pre_HDR_6013	Post_HDR_6013	Delta
0	1	1.065	1.079	0.014
0	2	1.051	1.063	0.012
10	182	1.091	1.103	0.012
10	202	1.066	1.066	0.000
10	204	1.039	1.083	0.045
11	418	1.047	1.021	-0.026
11	419	1.042	1.051	0.008
11	443	1.086	1.059	-0.027
50	259	1.048	1.057	0.009
50	346	1.036	1.045	0.008
50	347	1.051	1.055	0.004
51	462	1.045	1.032	-0.013
51	478	1.050	1.075	0.025
51	503	1.034	1.034	0.000
100	354	1.045	1.048	0.003
100	363	1.068	1.055	-0.013
100	366	1.057	1.061	0.003
100	383	1.051	1.088	0.037
100	417	1.057	1.051	-0.006
101	513	1.052	1.049	-0.003
101	526	1.066	1.062	-0.003
101	532	1.045	1.044	-0.002
101	533	1.053	1.058	0.005
101	534	1.050	1.051	0.000
Max		1.091	1.103	0.045
Average		1.054	1.058	0.004
Min		1.034	1.021	-0.027
Std Dev		0.014	0.018	0.016

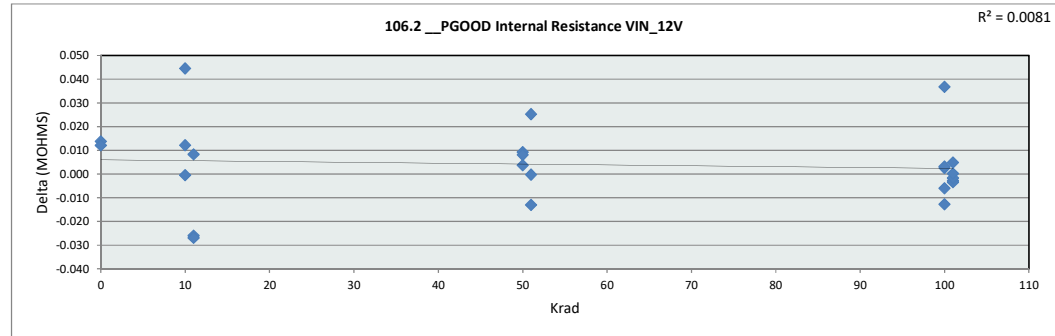

106.2_PGOOD Internal Resistance		
Test Site	DAL	
Tester	ETS364	
Test Number	EB672303	
Max Limit	1.9	MOHMS
Min Limit	0.7	MOHMS

	0	10	11	50	51	100	101
LL	0.700	0.700	0.700	0.700	0.700	0.700	0.700
Min	1.063	1.066	1.021	1.045	1.032	1.048	1.044
Average	1.071	1.084	1.044	1.052	1.047	1.061	1.053
Max	1.079	1.103	1.059	1.057	1.075	1.088	1.062
UL	1.900	1.900	1.900	1.900	1.900	1.900	1.900

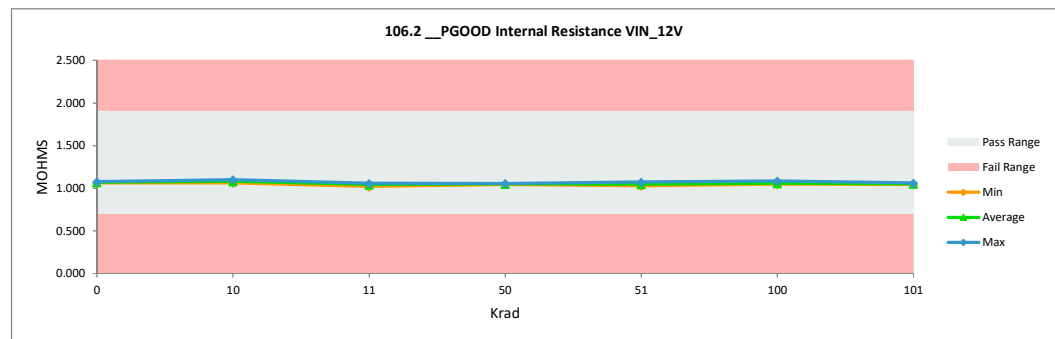

TID "HDR" Report
5962R2220102VXC

107.0_PGOOD Logic Low Outupt		
Test Site	DAL	DAL
Tester	ETS364	ETS364
Test Number	EB672303	EB672303
Unit	V	V
Max Limit	0.4	0.4
Min Limit	0	0

Krad	Serial #	Pre_HDR_6013	Post_HDR_6013	Delta
0	1	0.201	0.197	-0.004
0	2	0.194	0.192	-0.003
10	182	0.199	0.194	-0.005
10	202	0.203	0.201	-0.001
10	204	0.200	0.192	-0.008
11	418	0.196	0.200	0.004
11	419	0.198	0.193	-0.005
11	443	0.197	0.200	0.004
50	259	0.201	0.196	-0.005
50	346	0.201	0.195	-0.006
50	347	0.199	0.194	-0.005
51	462	0.199	0.194	-0.005
51	478	0.200	0.197	-0.003
51	503	0.199	0.195	-0.003
100	354	0.199	0.193	-0.006
100	363	0.197	0.197	-0.001
100	366	0.202	0.197	-0.006
100	383	0.199	0.193	-0.005
100	417	0.200	0.194	-0.006
101	513	0.199	0.195	-0.004
101	526	0.192	0.188	-0.004
101	532	0.200	0.194	-0.005
101	533	0.200	0.194	-0.006
101	534	0.202	0.197	-0.005
Max		0.203	0.201	0.004
Average		0.199	0.195	-0.004
Min		0.192	0.188	-0.008
Std Dev		0.002	0.003	0.003

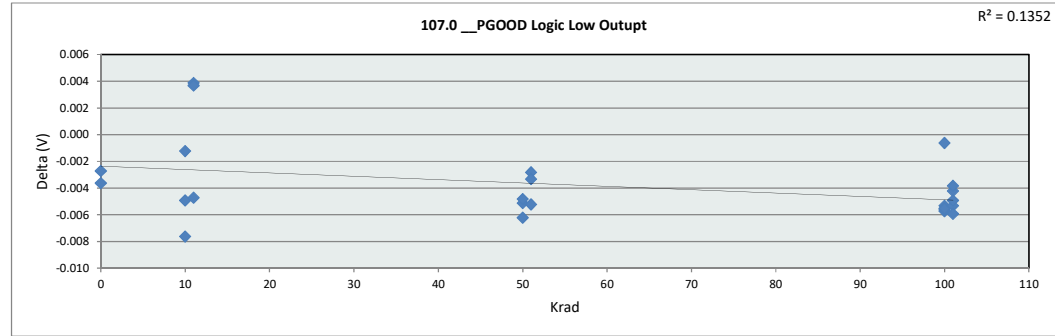

107.0_PGOOD Logic Low Out		
Test Site	DAL	
Tester	ETS364	
Test Number	EB672303	
Max Limit	0.4	V
Min Limit	0	V

Krad	0	10	11	50	51	100	101
LL	0.000	0.000	0.000	0.000	0.000	0.000	0.000
Min	0.192	0.192	0.193	0.195	0.194	0.193	0.188
Average	0.194	0.196	0.198	0.195	0.195	0.195	0.194
Max	0.197	0.202	0.201	0.196	0.197	0.197	0.197
UL	0.400	0.400	0.400	0.400	0.400	0.400	0.400

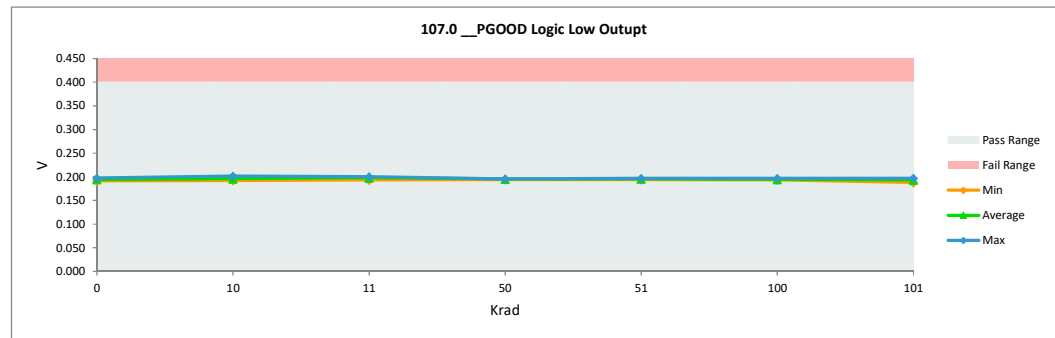

TID "HDR" Report
5962R2220102VXC

107.1 __Min BP5L for Valid PGOOD		
Test Site	DAL	DAL
Tester	ETS364	ETS364
Test Number	EB672303	EB672303
Unit	V	V
Max Limit	2.45	2.45
Min Limit	0.1	0.1

Krad	Serial #	Pre_HDR_6013	Post_HDR_6013	Delta
0	1	2.103	2.105	0.002
0	2	1.976	1.978	0.001
10	182	1.929	1.916	-0.012
10	202	1.976	1.958	-0.018
10	204	1.907	2.002	0.095
11	418	1.907	2.089	0.182
11	419	1.911	2.019	0.108
11	443	1.941	2.051	0.110
50	259	1.980	1.888	-0.092
50	346	1.987	1.896	-0.091
50	347	2.086	1.999	-0.088
51	462	1.823	1.951	0.128
51	478	1.973	1.851	-0.122
51	503	2.000	1.916	-0.084
100	354	1.996	1.829	-0.167
100	363	2.017	1.809	-0.208
100	366	2.083	1.936	-0.147
100	383	1.909	1.894	-0.015
100	417	1.923	1.861	-0.062
101	513	1.946	1.770	-0.176
101	526	2.048	1.873	-0.175
101	532	1.937	1.767	-0.170
101	533	1.913	1.753	-0.160
101	534	1.952	1.796	-0.156
Max		2.103	2.105	0.182
Average		1.968	1.913	-0.055
Min		1.823	1.753	-0.208
Std Dev		0.066	0.100	0.113

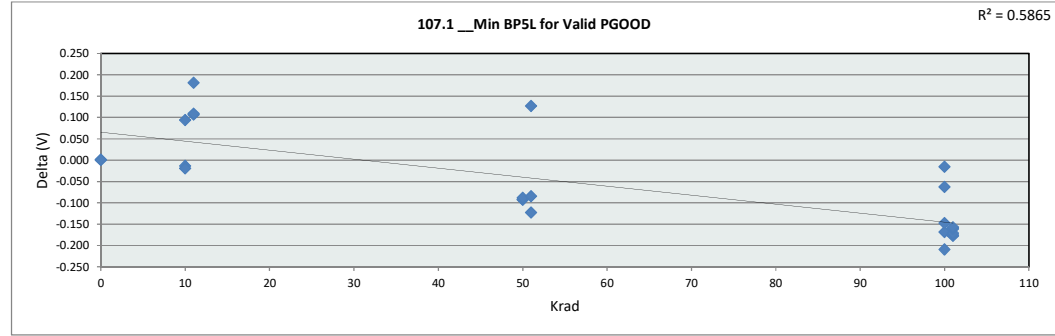

107.1 __Min BP5L for Valid PG		
Test Site	DAL	
Tester	ETS364	
Test Number	EB672303	
Max Limit	2.45	
Min Limit	0.1	V

Krad	0	10	11	50	51	100	101
LL	0.100	0.100	0.100	0.100	0.100	0.100	0.100
Min	1.978	1.916	2.019	1.888	1.851	1.809	1.753
Average	2.042	1.959	2.053	1.928	1.906	1.866	1.792
Max	2.105	2.002	2.089	1.999	1.951	1.937	1.873
UL	2.450	2.450	2.450	2.450	2.450	2.450	2.450

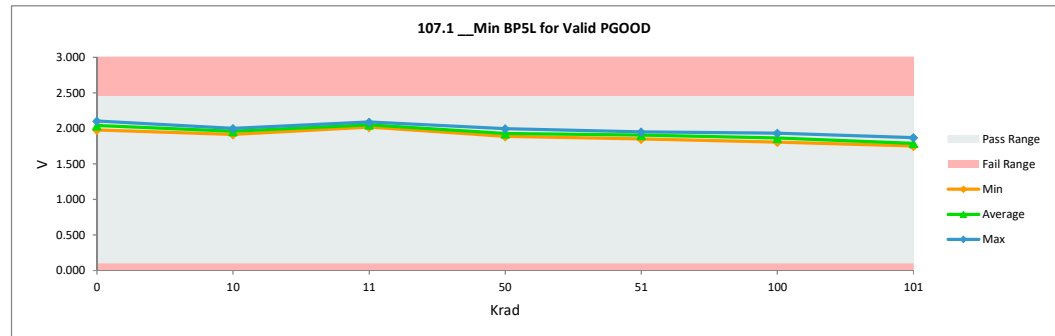

TID "HDR" Report
5962R2220102VXC

107.2_PGOOD Internal Resista

Test Site	DAL	DAL
Tester	ETS364	ETS364
Test Number	EB672303	EB672303
Unit	MOHMS	MOHMS
Max Limit	1.9	1.9
Min Limit	0.7	0.7

Krad	Serial #	Pre_HDR_6013	Post_HDR_6013	Delta
0	1	1.064	1.079	0.015
0	2	1.054	1.061	0.007
10	182	1.091	1.105	0.014
10	202	1.066	1.067	0.001
10	204	1.038	1.086	0.049
11	418	1.046	1.024	-0.022
11	419	1.040	1.054	0.014
11	443	1.087	1.057	-0.030
50	259	1.053	1.055	0.003
50	346	1.032	1.044	0.012
50	347	1.045	1.054	0.009
51	462	1.042	1.035	-0.007
51	478	1.053	1.072	0.020
51	503	1.034	1.034	0.000
100	354	1.045	1.049	0.004
100	363	1.070	1.057	-0.013
100	366	1.053	1.061	0.008
100	383	1.049	1.085	0.035
100	417	1.056	1.052	-0.004
101	513	1.052	1.050	-0.002
101	526	1.065	1.059	-0.006
101	532	1.041	1.044	0.003
101	533	1.056	1.055	-0.001
101	534	1.052	1.055	0.003
Max		1.091	1.105	0.049
Average		1.053	1.058	0.005
Min		1.032	1.024	-0.030
Std Dev		0.015	0.018	0.016

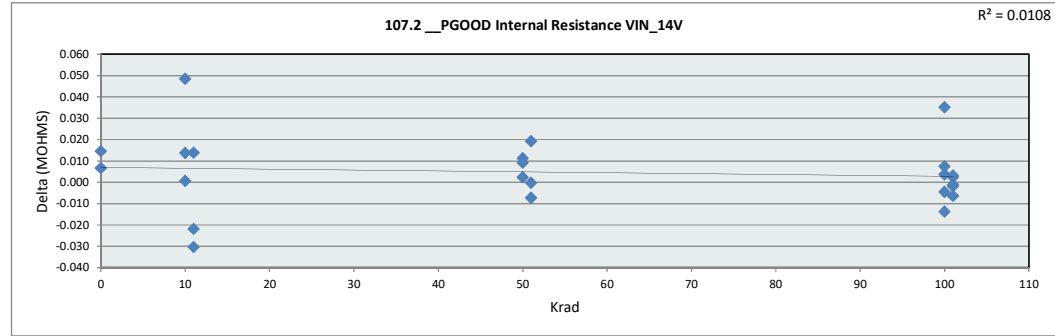

107.2_PGOOD Internal Resis

Test Site	DAL
Tester	ETS364
Test Number	EB672303
Max Limit	1.9 MOHMS
Min Limit	0.7 MOHMS

Krad	0	10	11	50	51	100	101
LL	0.700	0.700	0.700	0.700	0.700	0.700	0.700
Min	1.061	1.067	1.024	1.044	1.034	1.049	1.044
Average	1.070	1.086	1.045	1.051	1.047	1.060	1.052
Max	1.079	1.105	1.057	1.055	1.073	1.085	1.059
UL	1.900	1.900	1.900	1.900	1.900	1.900	1.900

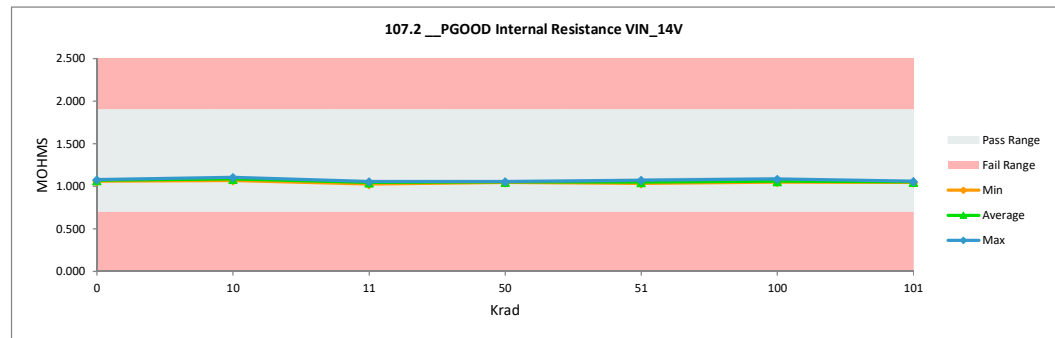

TID "HDR" Report
5962R2220102VXC

110.0 Prop Delay LO Off PWM		
Test Site	DAL	DAL
Tester	ETS364	ETS364
Test Number	EB672303	EB672303
Unit		
Max Limit	48	48
Min Limit	1	1

Krad	Serial #	Pre_HDR_6013	Post_HDR_6013	Delta
0	1	30.356	30.280	-0.076
0	2	30.576	30.522	-0.054
10	182	30.307	30.044	-0.263
10	202	30.278	30.165	-0.113
10	204	29.826	30.118	0.291
11	418	30.275	30.472	0.197
11	419	30.061	30.318	0.257
11	443	30.290	30.184	-0.106
50	259	29.777	29.448	-0.329
50	346	29.939	29.498	-0.441
50	347	30.749	30.412	-0.337
51	462	29.969	30.337	0.368
51	478	30.256	30.109	-0.147
51	503	30.497	30.107	-0.390
100	354	30.233	29.595	-0.638
100	363	29.992	29.554	-0.438
100	366	30.174	29.587	-0.588
100	383	30.129	29.493	-0.636
100	417	30.359	29.834	-0.526
101	513	30.122	29.646	-0.476
101	526	30.883	29.990	-0.892
101	532	30.401	29.700	-0.701
101	533	30.330	29.516	-0.814
101	534	29.888	29.163	-0.725
Max		30.883	30.522	0.368
Average		30.236	29.920	-0.316
Min		29.777	29.163	-0.892
Std Dev		0.274	0.386	0.358

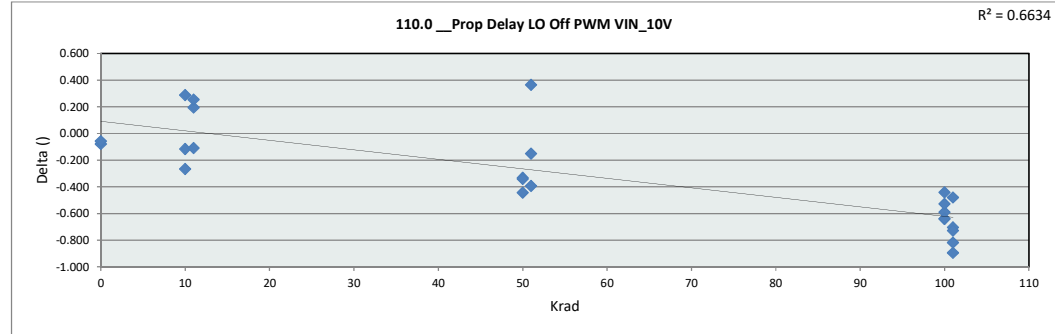

110.0 Prop Delay LO Off PW	
Test Site	DAL
Tester	ETS364
Test Number	EB672303
Max Limit	48
Min Limit	1

Krad	0	10	11	50	51	100	101
LL	1.000	1.000	1.000	1.000	1.000	1.000	1.000
Min	30.280	30.044	30.184	29.448	30.107	29.493	29.163
Average	30.401	30.109	30.325	29.786	30.184	29.613	29.603
Max	30.522	30.165	30.472	30.412	30.337	29.834	29.990
UL	48.000	48.000	48.000	48.000	48.000	48.000	48.000

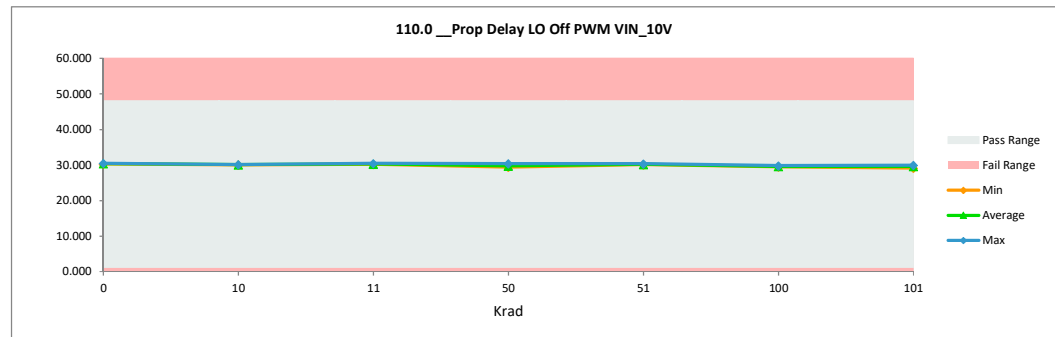

TID "HDR" Report
5962R2220102VXC

110.1 Prop Delay HO Off PWM		
Test Site	DAL	DAL
Tester	ETS364	ETS364
Test Number	EB672303	EB672303
Unit		
Max Limit	50	50
Min Limit	1	1

Krad	Serial #	Pre_HDR_6013	Post_HDR_6013	Delta
0	1	33.121	32.982	-0.139
0	2	33.977	33.886	-0.091
10	182	33.442	33.221	-0.221
10	202	33.112	33.146	0.034
10	204	32.872	32.832	-0.040
11	418	33.186	33.357	0.171
11	419	32.995	33.126	0.132
11	443	33.119	33.465	0.346
50	259	32.665	32.272	-0.393
50	346	32.446	32.087	-0.359
50	347	33.313	32.916	-0.397
51	462	32.953	33.414	0.460
51	478	33.290	32.925	-0.365
51	503	33.705	33.403	-0.302
100	354	33.352	32.533	-0.819
100	363	32.694	32.154	-0.540
100	366	33.159	32.527	-0.632
100	383	33.813	32.765	-1.048
100	417	33.220	32.482	-0.739
101	513	33.147	32.711	-0.436
101	526	33.959	33.267	-0.692
101	532	33.428	32.938	-0.490
101	533	33.081	32.442	-0.639
101	534	32.988	32.753	-0.235
Max		33.977	33.886	0.460
Average		33.210	32.900	-0.310
Min		32.446	32.087	-1.048
Std Dev		0.383	0.453	0.373

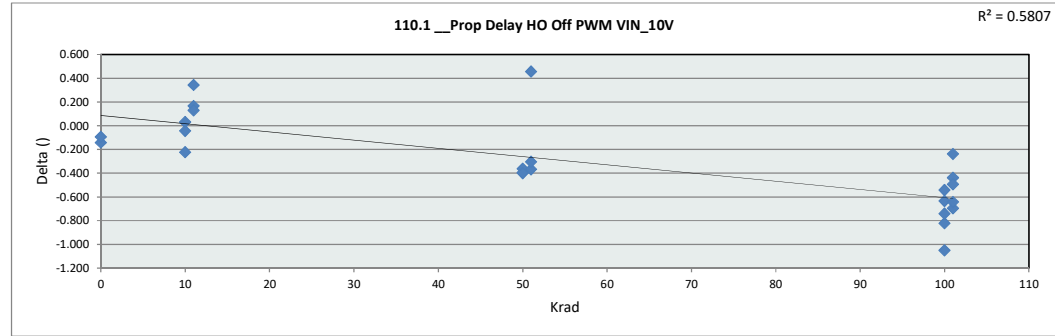

110.1 Prop Delay HO Off PW	
Test Site	DAL
Tester	ETS364
Test Number	EB672303
Max Limit	50
Min Limit	1

Krad	0	10	11	50	51	100	101
LL	1.000	1.000	1.000	1.000	1.000	1.000	1.000
Min	32.982	32.832	33.127	32.087	32.925	32.155	32.442
Average	33.434	33.066	33.316	32.425	33.247	32.492	32.822
Max	33.886	33.221	33.465	32.916	33.414	32.765	33.267
UL	50.000	50.000	50.000	50.000	50.000	50.000	50.000

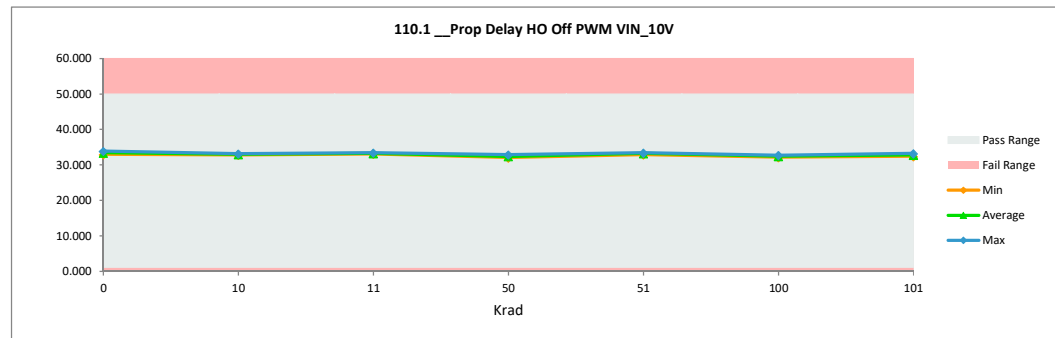

TID "HDR" Report
5962R2220102VXC

110.2 __Prop Delay LO On IIM Interlock VIN_10V		
Test Site	DAL	DAL
Tester	ETS364	ETS364
Test Number	EB672303	EB672303
Unit		
Max Limit	38	38
Min Limit	1	1

Krad	Serial #	Pre_HDR_6013	Post_HDR_6013	Delta
0	1	23.193	23.020	-0.174
0	2	23.324	23.191	-0.133
10	182	23.183	23.023	-0.160
10	202	23.140	23.134	-0.006
10	204	22.896	23.139	0.243
11	418	23.153	23.366	0.213
11	419	23.102	23.318	0.216
11	443	23.068	23.177	0.109
50	259	23.101	22.798	-0.304
50	346	23.065	22.841	-0.223
50	347	23.243	23.038	-0.205
51	462	23.099	23.145	0.045
51	478	23.103	23.104	0.001
51	503	23.485	23.174	-0.311
100	354	23.238	22.838	-0.400
100	363	23.030	22.921	-0.109
100	366	23.137	22.793	-0.344
100	383	23.145	22.697	-0.448
100	417	23.224	23.008	-0.216
101	513	23.134	22.937	-0.196
101	526	23.382	23.070	-0.312
101	532	23.270	22.994	-0.276
101	533	23.085	22.731	-0.354
101	534	23.116	22.673	-0.443
Max		23.485	23.366	0.243
Average		23.163	23.005	-0.158
Min		22.896	22.673	-0.448
Std Dev		0.122	0.189	0.208

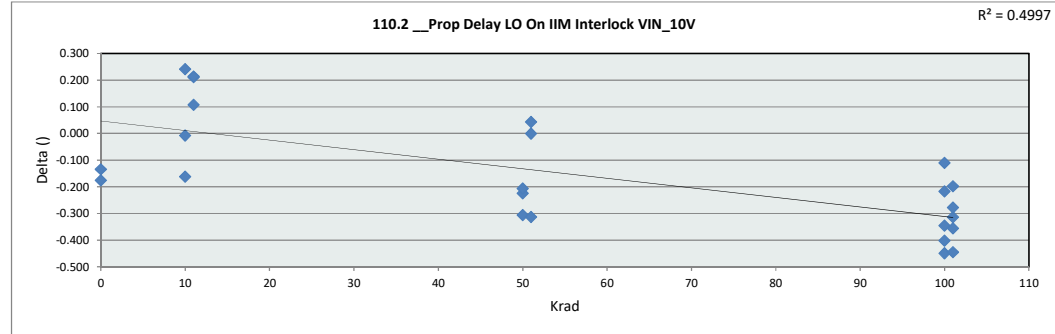

110.2 __Prop Delay LO On IIM	
Test Site	DAL
Tester	ETS364
Test Number	EB672303
Max Limit	38
Min Limit	1

Krad	0	10	11	50	51	100	101
LL	1.000	1.000	1.000	1.000	1.000	1.000	1.000
Min	23.020	23.023	23.177	22.798	23.104	22.697	22.673
Average	23.105	23.099	23.287	22.893	23.141	22.852	22.881
Max	23.191	23.139	23.366	23.038	23.174	23.009	23.070
UL	38.000	38.000	38.000	38.000	38.000	38.000	38.000

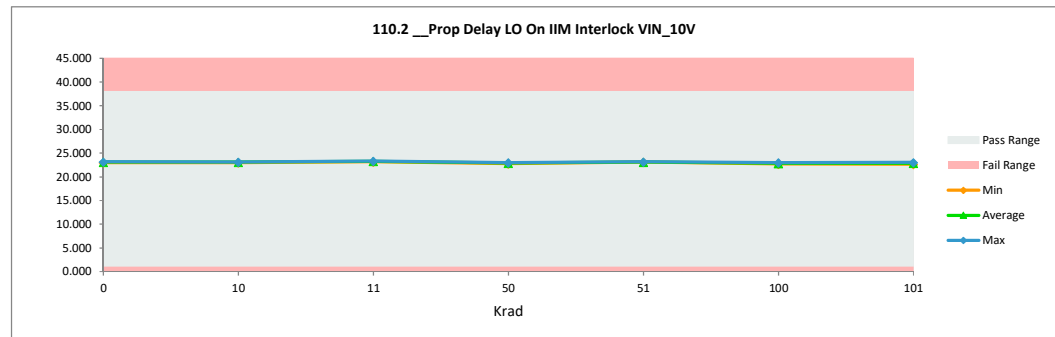

TID "HDR" Report
5962R2220102VXC

110.3 Prop Delay LO Off IIM I		
Test Site	DAL	DAL
Tester	ETS364	ETS364
Test Number	EB672303	EB672303
Unit		
Max Limit	38	38
Min Limit	1	1

Krad	Serial #	Pre_HDR_6013	Post_HDR_6013	Delta
0	1	27.563	27.388	-0.175
0	2	27.684	27.521	-0.163
10	182	27.378	27.206	-0.172
10	202	27.416	27.416	0.000
10	204	26.899	27.358	0.459
11	418	27.363	27.561	0.198
11	419	27.073	27.561	0.488
11	443	27.189	27.338	0.149
50	259	27.199	26.991	-0.208
50	346	27.221	27.060	-0.161
50	347	27.753	27.426	-0.327
51	462	27.149	27.298	0.149
51	478	27.254	27.204	-0.050
51	503	27.721	27.463	-0.257
100	354	27.313	26.904	-0.409
100	363	27.184	27.115	-0.070
100	366	27.236	26.988	-0.248
100	383	27.405	27.024	-0.380
100	417	27.419	27.356	-0.063
101	513	27.417	27.120	-0.297
101	526	27.898	27.545	-0.353
101	532	27.588	27.362	-0.226
101	533	27.145	26.849	-0.296
101	534	27.218	27.053	-0.166
	Max	27.898	27.561	0.488
	Average	27.362	27.254	-0.107
	Min	26.899	26.849	-0.409
	Std Dev	0.240	0.219	0.242

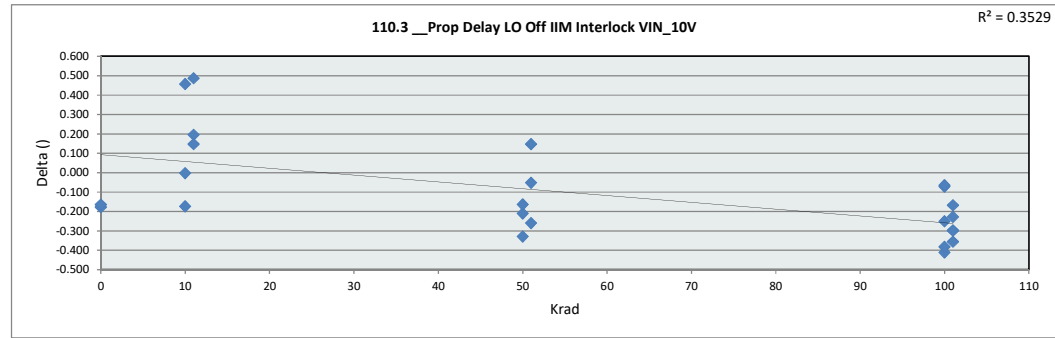

110.3 Prop Delay LO Off IIM	
Test Site	DAL
Tester	ETS364
Test Number	EB672303
Max Limit	38
Min Limit	1

Krad	0	10	11	50	51	100	101
LL	1.000	1.000	1.000	1.000	1.000	1.000	1.000
Min	27.388	27.206	27.338	26.991	27.204	26.904	26.849
Average	27.454	27.327	27.487	27.159	27.322	27.077	27.186
Max	27.521	27.416	27.561	27.426	27.463	27.356	27.545
UL	38.000	38.000	38.000	38.000	38.000	38.000	38.000

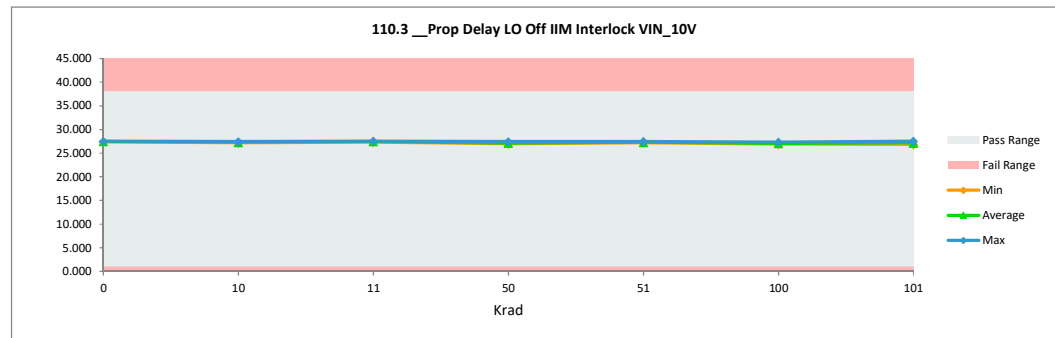

TID "HDR" Report
5962R2220102VXC

110.4 Prop Delay HO On IIM I		
Test Site	DAL	DAL
Tester	ETS364	ETS364
Test Number	EB672303	EB672303
Unit		
Max Limit	40	40
Min Limit	1	1

Krad	Serial #	Pre_HDR_6013	Post_HDR_6013	Delta
0	1	26.052	26.010	-0.042
0	2	26.398	26.439	0.041
10	182	26.084	25.926	-0.158
10	202	25.638	25.719	0.081
10	204	25.622	25.666	0.045
11	418	26.244	26.225	-0.019
11	419	25.824	26.020	0.196
11	443	25.960	26.079	0.119
50	259	25.967	25.724	-0.244
50	346	25.537	25.196	-0.340
50	347	25.903	25.741	-0.162
51	462	25.752	25.883	0.131
51	478	26.045	25.562	-0.483
51	503	26.420	26.215	-0.204
100	354	26.071	25.478	-0.593
100	363	25.628	25.129	-0.499
100	366	26.248	25.772	-0.476
100	383	26.338	25.539	-0.799
100	417	25.884	25.613	-0.271
101	513	26.048	25.556	-0.491
101	526	26.574	25.855	-0.719
101	532	26.166	25.745	-0.421
101	533	25.727	25.158	-0.569
101	534	25.974	25.651	-0.323
Max		26.574	26.439	0.196
Average		26.004	25.746	-0.258
Min		25.537	25.129	-0.799
Std Dev		0.277	0.329	0.286

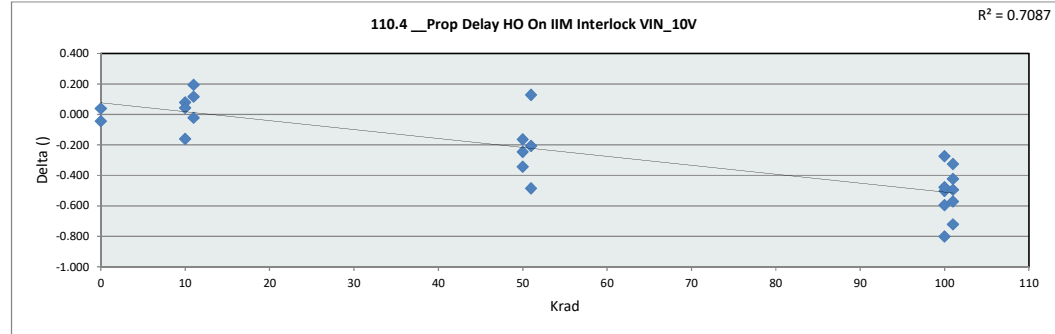

110.4 Prop Delay HO On IIM		
Test Site	DAL	
Tester	ETS364	
Test Number	EB672303	
Max Limit	40	
Min Limit	1	

Krad	0	10	11	50	51	100	101
LL	1.000	1.000	1.000	1.000	1.000	1.000	1.000
Min	26.010	25.666	26.020	25.196	25.562	25.129	25.158
Average	26.225	25.770	26.108	25.554	25.887	25.506	25.593
Max	26.439	25.926	26.225	25.741	26.215	25.772	25.855
UL	40.000	40.000	40.000	40.000	40.000	40.000	40.000

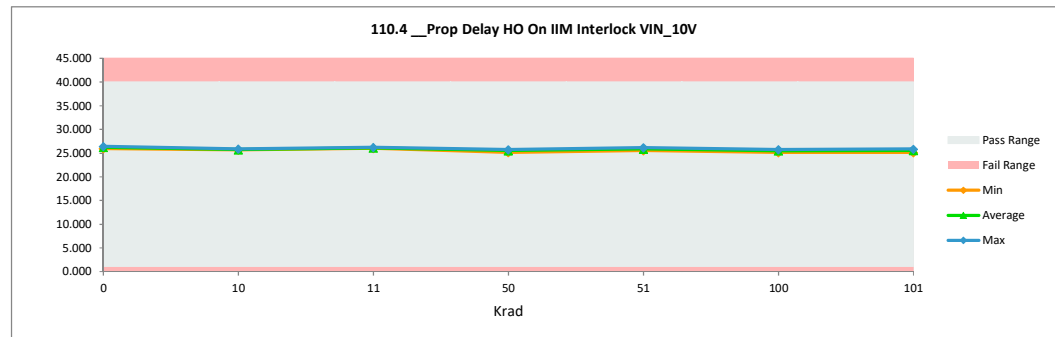

TID "HDR" Report
5962R2220102VXC

110.5 Prop Delay HO Off IIM I		
Test Site	DAL	DAL
Tester	ETS364	ETS364
Test Number	EB672303	EB672303
Unit		
Max Limit	40	40
Min Limit	1	1

Krad	Serial #	Pre_HDR_6013	Post_HDR_6013	Delta
0	1	28.230	28.111	-0.119
0	2	28.819	28.700	-0.119
10	182	28.282	28.181	-0.101
10	202	27.993	28.022	0.029
10	204	27.906	27.860	-0.046
11	418	28.280	28.298	0.018
11	419	27.913	28.064	0.151
11	443	27.985	28.300	0.315
50	259	27.839	27.624	-0.215
50	346	27.470	27.132	-0.338
50	347	27.978	27.777	-0.201
51	462	27.947	28.073	0.126
51	478	28.360	27.743	-0.616
51	503	28.493	28.353	-0.140
100	354	28.125	27.730	-0.395
100	363	27.789	27.360	-0.429
100	366	28.170	27.831	-0.339
100	383	28.903	28.023	-0.880
100	417	28.045	27.718	-0.327
101	513	28.087	27.866	-0.221
101	526	28.636	28.189	-0.448
101	532	28.296	27.976	-0.320
101	533	27.773	27.443	-0.330
101	534	28.123	27.845	-0.278
Max		28.903	28.700	0.315
Average		28.143	27.926	-0.218
Min		27.470	27.132	-0.880
Std Dev		0.334	0.344	0.257

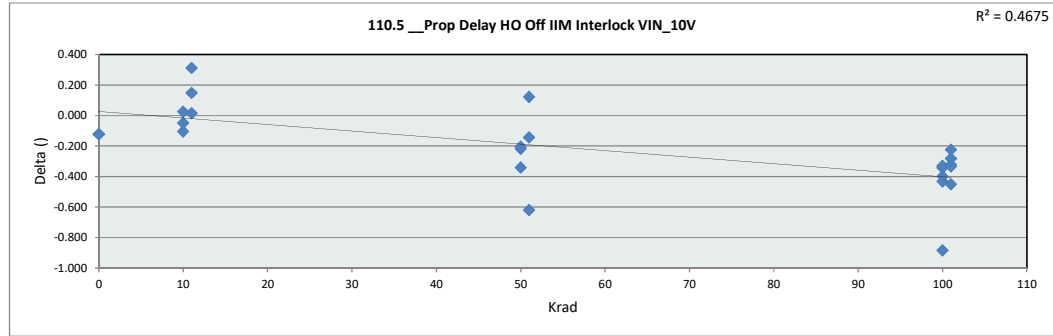

110.5 Prop Delay HO Off IIM	
Test Site	DAL
Tester	ETS364
Test Number	EB672303
Max Limit	40
Min Limit	1

Krad	0	10	11	50	51	100	101
LL	1.000	1.000	1.000	1.000	1.000	1.000	1.000
Min	28.111	27.860	28.064	27.132	27.743	27.360	27.443
Average	28.405	28.021	28.221	27.511	28.056	27.732	27.864
Max	28.700	28.181	28.300	27.777	28.353	28.023	28.189
UL	40.000	40.000	40.000	40.000	40.000	40.000	40.000

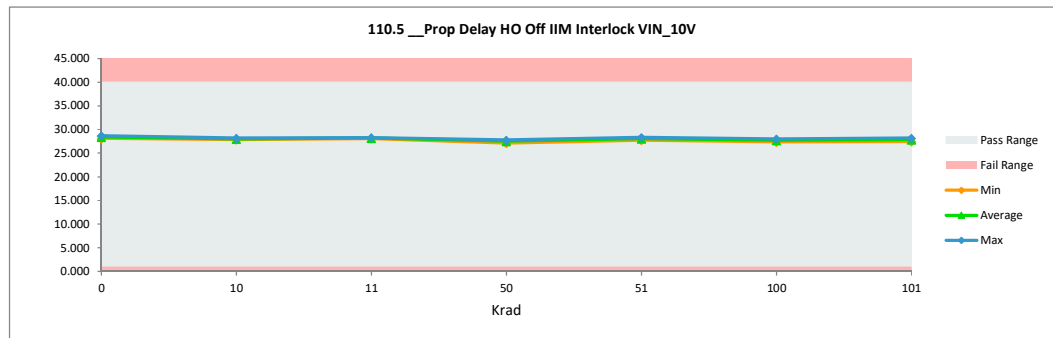

TID "HDR" Report
5962R2220102VXC

110.6 Prop Delay LO On IIM Interlock Disable VIN_10V		
Test Site	DAL	DAL
Tester	ETS364	ETS364
Test Number	EB672303	EB672303
Unit		
Max Limit	38	38
Min Limit	1	1

Krad	Serial #	Pre_HDR_6013	Post_HDR_6013	Delta
0	1	23.170	23.038	-0.132
0	2	23.279	23.180	-0.099
10	182	23.147	23.011	-0.136
10	202	23.101	23.136	0.035
10	204	22.852	23.049	0.197
11	418	23.065	23.324	0.260
11	419	23.041	23.209	0.168
11	443	23.053	23.070	0.017
50	259	23.070	22.781	-0.289
50	346	23.033	22.836	-0.197
50	347	23.235	23.006	-0.229
51	462	23.121	23.136	0.015
51	478	23.041	23.128	0.087
51	503	23.367	23.156	-0.210
100	354	23.183	22.862	-0.320
100	363	22.995	22.842	-0.152
100	366	23.113	22.795	-0.318
100	383	23.170	22.773	-0.397
100	417	23.198	23.078	-0.120
101	513	23.159	22.928	-0.231
101	526	23.411	23.028	-0.383
101	532	23.232	22.953	-0.279
101	533	23.002	22.593	-0.410
101	534	23.098	22.749	-0.349
Max		23.411	23.324	0.260
Average		23.131	22.986	-0.145
Min		22.852	22.593	-0.410
Std Dev		0.122	0.177	0.195

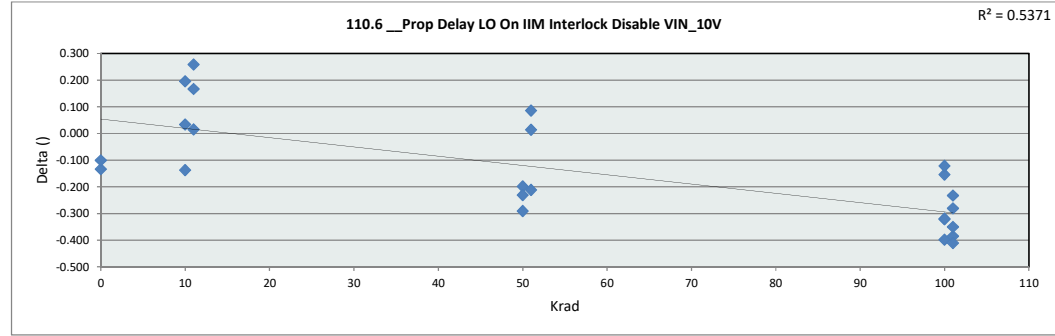

110.6 Prop Delay LO On IIM	
Test Site	DAL
Tester	ETS364
Test Number	EB672303
Max Limit	38
Min Limit	1

Krad	0	10	11	50	51	100	101
LL	1.000	1.000	1.000	1.000	1.000	1.000	1.000
Min	23.038	23.011	23.070	22.781	23.129	22.773	22.593
Average	23.109	23.065	23.201	22.874	23.140	22.870	22.850
Max	23.180	23.136	23.325	23.006	23.156	23.078	23.028
UL	38.000	38.000	38.000	38.000	38.000	38.000	38.000

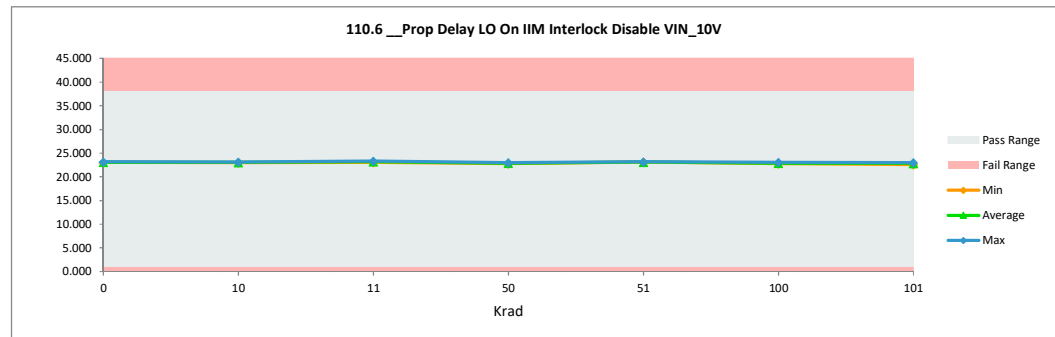

TID "HDR" Report
5962R2220102VXC

110.7 Prop Delay LO Off IIM I		
Test Site	DAL	DAL
Tester	ETS364	ETS364
Test Number	EB672303	EB672303
Unit		
Max Limit	38	38
Min Limit	1	1

Krad	Serial #	Pre_HDR_6013	Post_HDR_6013	Delta
0	1	27.448	27.250	-0.198
0	2	27.514	27.396	-0.118
10	182	27.232	27.088	-0.144
10	202	27.320	27.423	0.104
10	204	26.912	27.227	0.316
11	418	27.300	27.438	0.138
11	419	26.968	27.458	0.490
11	443	27.054	27.253	0.199
50	259	27.159	26.840	-0.319
50	346	27.034	26.947	-0.087
50	347	27.583	27.281	-0.303
51	462	26.931	27.226	0.295
51	478	27.170	27.138	-0.033
51	503	27.531	27.357	-0.174
100	354	27.116	26.843	-0.273
100	363	27.034	27.027	-0.007
100	366	27.165	26.899	-0.266
100	383	27.343	26.858	-0.485
100	417	27.285	27.263	-0.022
101	513	27.297	27.074	-0.223
101	526	27.685	27.320	-0.365
101	532	27.433	27.148	-0.285
101	533	27.091	26.815	-0.277
101	534	27.171	26.888	-0.283
	Max	27.685	27.458	0.490
	Average	27.241	27.144	-0.097
	Min	26.912	26.815	-0.485
	Std Dev	0.213	0.212	0.245

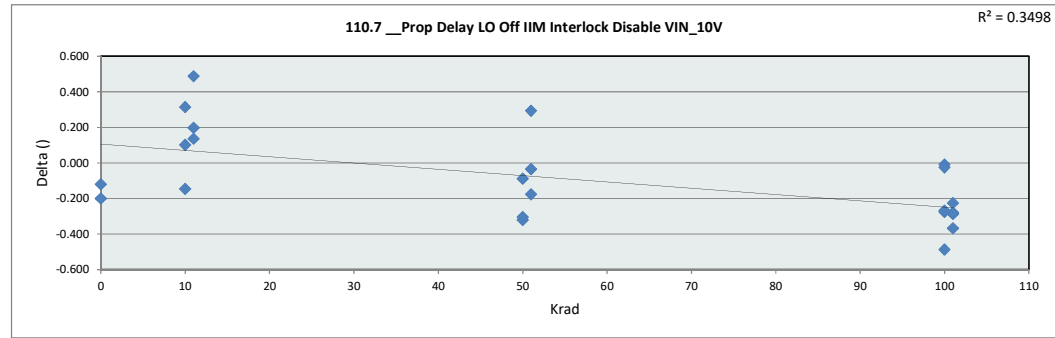

110.7 Prop Delay LO Off IIM	
Test Site	DAL
Tester	ETS364
Test Number	EB672303
Max Limit	38
Min Limit	1

Krad	0	10	11	50	51	100	101
LL	1.000	1.000	1.000	1.000	1.000	1.000	1.000
Min	27.250	27.088	27.253	26.840	27.138	26.843	26.815
Average	27.323	27.246	27.383	27.022	27.240	26.978	27.049
Max	27.396	27.423	27.458	27.281	27.357	27.263	27.320
UL	38.000	38.000	38.000	38.000	38.000	38.000	38.000

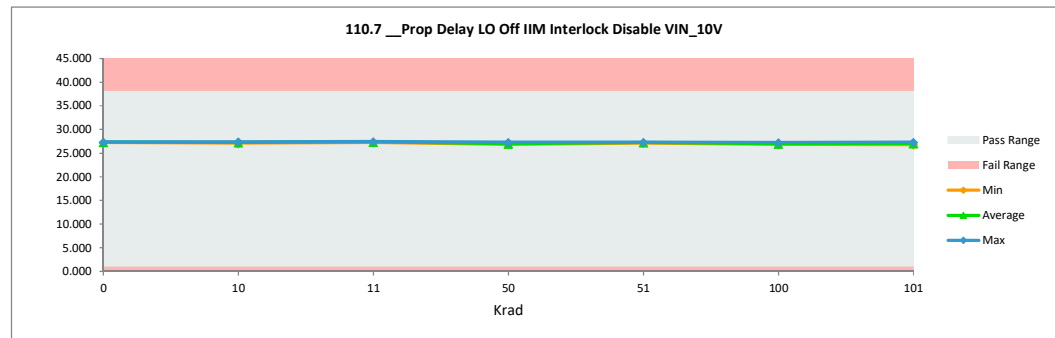

TID "HDR" Report
5962R2220102VXC

110.8 Prop Delay HO On IIM I		
Test Site	DAL	DAL
Tester	ETS364	ETS364
Test Number	EB672303	EB672303
Unit		
Max Limit	40	40
Min Limit	1	1

Krad	Serial #	Pre_HDR_6013	Post_HDR_6013	Delta
0	1	26.041	25.933	-0.107
0	2	26.336	26.271	-0.065
10	182	26.015	25.801	-0.214
10	202	25.520	25.586	0.065
10	204	25.570	25.574	0.005
11	418	26.041	26.075	0.034
11	419	25.688	25.848	0.160
11	443	25.841	25.888	0.047
50	259	25.849	25.633	-0.216
50	346	25.449	25.175	-0.275
50	347	25.758	25.584	-0.174
51	462	25.623	25.681	0.058
51	478	25.913	25.443	-0.470
51	503	26.281	25.999	-0.282
100	354	25.944	25.378	-0.566
100	363	25.583	25.038	-0.545
100	366	26.155	25.621	-0.535
100	383	26.186	25.435	-0.751
100	417	25.841	25.515	-0.326
101	513	25.923	25.428	-0.495
101	526	26.444	25.772	-0.671
101	532	25.989	25.582	-0.407
101	533	25.596	25.128	-0.467
101	534	25.825	25.573	-0.252
Max		26.444	26.271	0.160
Average		25.892	25.623	-0.269
Min		25.449	25.038	-0.751
Std Dev		0.268	0.296	0.258

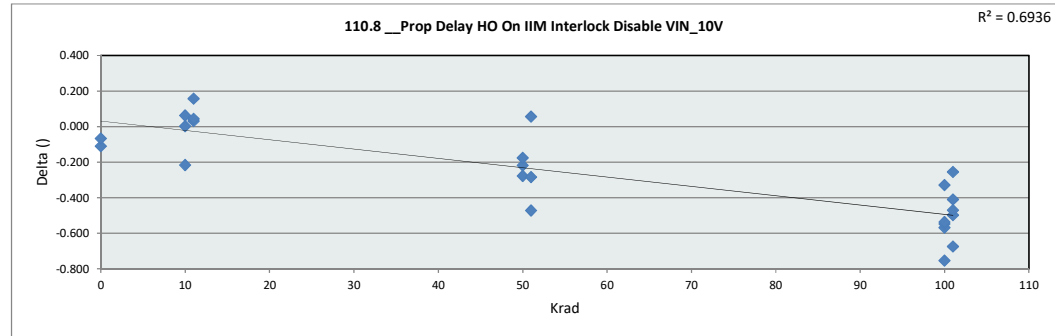

110.8 Prop Delay HO On IIM I	
Test Site	DAL
Tester	ETS364
Test Number	EB672303
Max Limit	40
Min Limit	1

Krad	0	10	11	50	51	100	101
LL	1.000	1.000	1.000	1.000	1.000	1.000	1.000
Min	25.933	25.575	25.848	25.175	25.443	25.038	25.128
Average	26.102	25.654	25.937	25.464	25.708	25.397	25.497
Max	26.271	25.801	26.075	25.633	25.999	25.621	25.772
UL	40.000	40.000	40.000	40.000	40.000	40.000	40.000

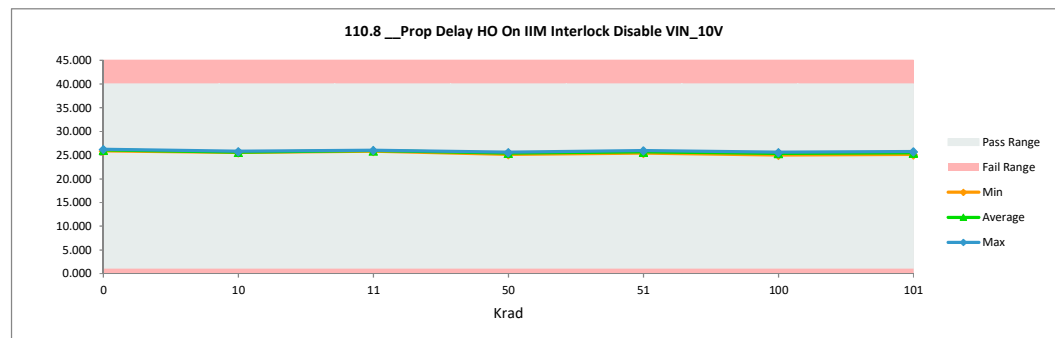

TID "HDR" Report
5962R2220102VXC

110.9 Prop Delay HO Off IIM I		
Test Site	DAL	DAL
Tester	ETS364	ETS364
Test Number	EB672303	EB672303
Unit		
Max Limit	40	40
Min Limit	1	1

Krad	Serial #	Pre_HDR_6013	Post_HDR_6013	Delta
0	1	28.611	28.563	-0.048
0	2	29.408	29.275	-0.133
10	182	28.771	28.692	-0.079
10	202	28.565	28.521	-0.043
10	204	28.364	28.293	-0.071
11	418	28.787	28.808	0.021
11	419	28.473	28.608	0.135
11	443	28.423	28.861	0.438
50	259	28.251	28.095	-0.156
50	346	28.014	27.683	-0.332
50	347	28.496	28.269	-0.227
51	462	28.520	28.645	0.125
51	478	28.725	28.326	-0.398
51	503	28.986	28.851	-0.134
100	354	28.585	28.191	-0.394
100	363	28.190	27.852	-0.338
100	366	28.685	28.334	-0.352
100	383	29.455	28.517	-0.938
100	417	28.581	28.155	-0.426
101	513	28.568	28.319	-0.249
101	526	29.120	28.796	-0.325
101	532	28.821	28.551	-0.270
101	533	28.357	27.913	-0.444
101	534	28.621	28.400	-0.221
	Max	29.455	29.275	0.438
	Average	28.641	28.438	-0.202
	Min	28.014	27.683	-0.938
	Std Dev	0.344	0.363	0.262

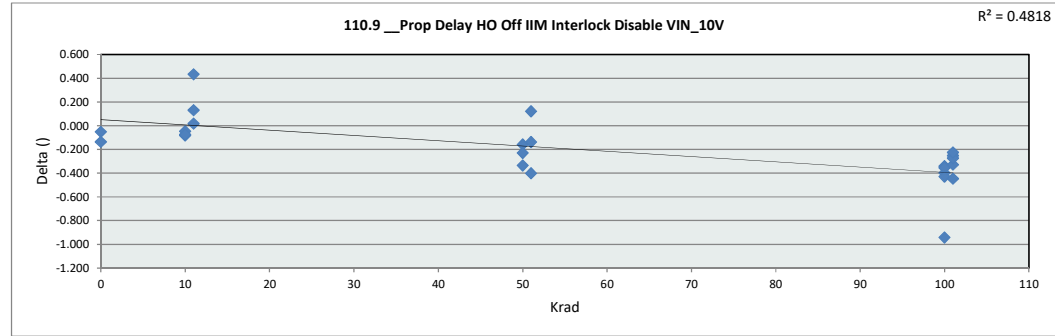

110.9 Prop Delay HO Off IIM	
Test Site	DAL
Tester	ETS364
Test Number	EB672303
Max Limit	40
Min Limit	1

Krad	0	10	11	50	51	100	101
LL	1.000	1.000	1.000	1.000	1.000	1.000	1.000
Min	28.563	28.293	28.608	27.683	28.327	27.852	27.914
Average	28.919	28.502	28.759	28.015	28.608	28.210	28.396
Max	29.275	28.692	28.861	28.269	28.852	28.517	28.796
UL	40.000	40.000	40.000	40.000	40.000	40.000	40.000

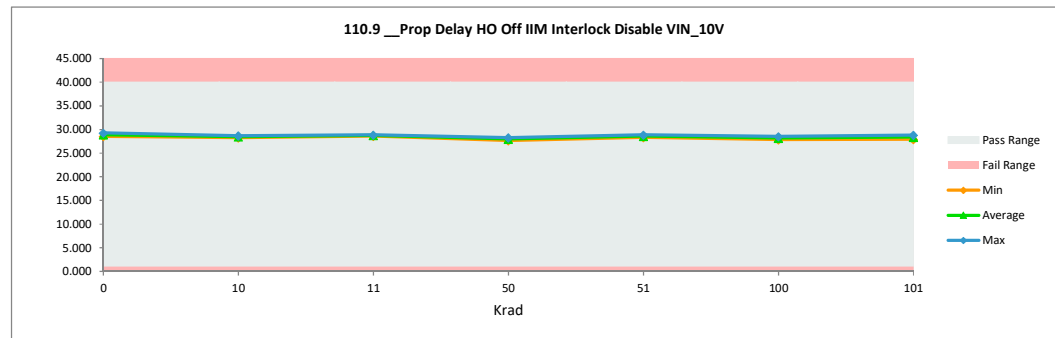

TID "HDR" Report
5962R2220102VXC

110.10 Delay Match LO On HO		
Test Site	DAL	DAL
Tester	ETS364	ETS364
Test Number	EB672303	EB672303
Unit		
Max Limit	12	12
Min Limit		

Krad	Serial #	Pre_HDR_6013	Post_HDR_6013	Delta
0	1	5.036	5.091	0.055
0	2	5.496	5.509	0.013
10	182	5.100	5.159	0.059
10	202	4.853	4.888	0.035
10	204	5.010	4.721	-0.288
11	418	5.127	4.932	-0.195
11	419	4.811	4.747	-0.064
11	443	4.917	5.123	0.206
50	259	4.738	4.827	0.089
50	346	4.405	4.290	-0.115
50	347	4.735	4.739	0.004
51	462	4.848	4.928	0.081
51	478	5.257	4.640	-0.618
51	503	5.008	5.179	0.171
100	354	4.887	4.892	0.005
100	363	4.759	4.438	-0.320
100	366	5.032	5.037	0.005
100	383	5.758	5.326	-0.432
100	417	4.821	4.710	-0.111
101	513	4.954	4.929	-0.025
101	526	5.254	5.119	-0.135
101	532	5.026	4.983	-0.043
101	533	4.688	4.712	0.024
101	534	5.007	5.172	0.165
Max		5.758	5.509	0.206
Average		4.980	4.920	-0.060
Min		4.405	4.290	-0.618
Std Dev		0.276	0.275	0.195

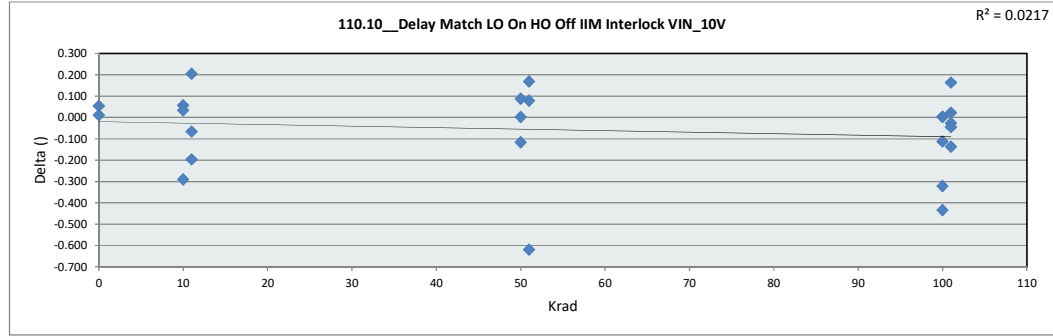

110.10 Delay Match LO On H	
Test Site	DAL
Tester	ETS364
Test Number	EB672303
Max Limit	12
Min Limit	

Krad	0	10	11	50	51	100	101
LL							
Min	5.092	4.721	4.747	4.290	4.640	4.439	4.712
Average	5.300	4.923	4.934	4.619	4.916	4.881	4.983
Max	5.509	5.159	5.123	4.827	5.179	5.326	5.172
UL	12.000	12.000	12.000	12.000	12.000	12.000	12.000

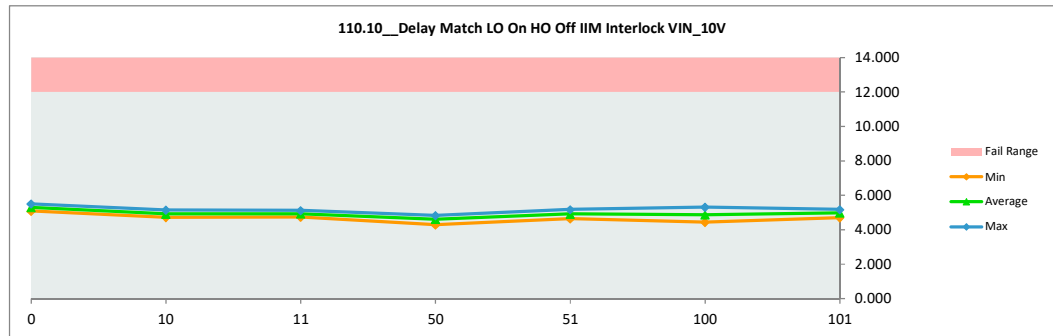

TID "HDR" Report
5962R2220102VXC

110.11 Delay Match LO Off HO		
Test Site	DAL	DAL
Tester	ETS364	ETS364
Test Number	EB672303	EB672303
Unit		
Max Limit	4	4
Min Limit		

Krad	Serial #	Pre_HDR_6013	Post_HDR_6013	Delta
0	1	1.511	1.378	-0.133
0	2	1.285	1.081	-0.204
10	182	1.293	1.280	-0.014
10	202	1.778	1.697	-0.081
10	204	1.277	1.692	0.415
11	418	1.119	1.336	0.217
11	419	1.249	1.541	0.293
11	443	1.229	1.259	0.030
50	259	1.232	1.267	0.035
50	346	1.684	1.864	0.179
50	347	1.850	1.685	-0.165
51	462	1.398	1.416	0.018
51	478	1.208	1.642	0.434
51	503	1.301	1.248	-0.053
100	354	1.242	1.426	0.184
100	363	1.556	1.985	0.429
100	366	0.988	1.216	0.227
100	383	1.067	1.485	0.418
100	417	1.535	1.743	0.209
101	513	1.369	1.564	0.195
101	526	1.324	1.689	0.365
101	532	1.422	1.617	0.195
101	533	1.418	1.691	0.273
101	534	1.244	1.402	0.157
Max		1.850	1.985	0.434
Average		1.358	1.509	0.151
Min		0.988	1.081	-0.204
Std Dev		0.211	0.228	0.195

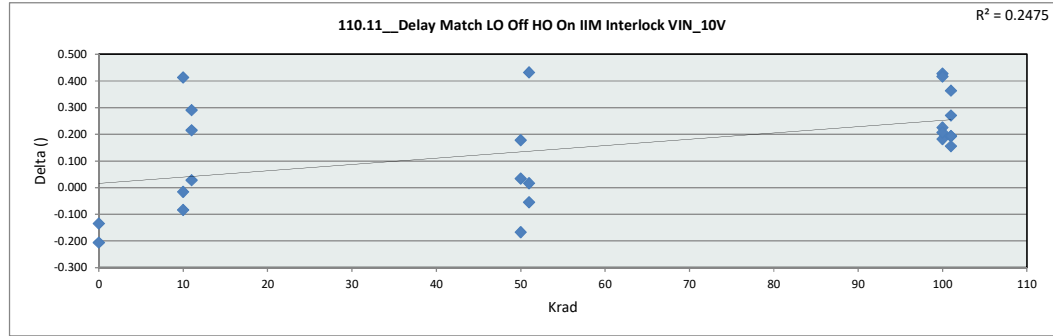

110.11 Delay Match LO Off H		
Test Site	DAL	
Tester	ETS364	
Test Number	EB672303	
Max Limit	4	
Min Limit		

	0	10	11	50	51	100	101
LL							
Min	1.081	1.280	1.259	1.267	1.248	1.216	1.402
Average	1.230	1.556	1.379	1.605	1.435	1.571	1.593
Max	1.378	1.697	1.542	1.864	1.642	1.986	1.691
UL	4.000	4.000	4.000	4.000	4.000	4.000	4.000

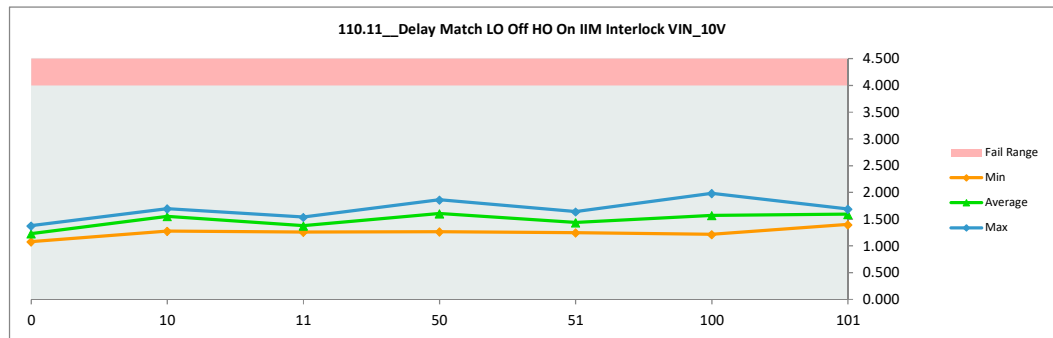

TID "HDR" Report
5962R2220102VXC

110.12 Delay Match LO On HO		
Test Site	DAL	DAL
Tester	ETS364	ETS364
Test Number	EB672303	EB672303
Unit		
Max Limit	12	12
Min Limit		

Krad	Serial #	Pre_HDR_6013	Post_HDR_6013	Delta
0	1	5.441	5.526	0.085
0	2	6.129	6.095	-0.034
10	182	5.624	5.681	0.056
10	202	5.464	5.385	-0.078
10	204	5.512	5.244	-0.268
11	418	5.722	5.483	-0.239
11	419	5.432	5.399	-0.034
11	443	5.370	5.791	0.421
50	259	5.181	5.314	0.133
50	346	4.981	4.846	-0.135
50	347	5.261	5.263	0.002
51	462	5.398	5.509	0.110
51	478	5.683	5.198	-0.486
51	503	5.619	5.695	0.076
100	354	5.402	5.328	-0.073
100	363	5.195	5.009	-0.186
100	366	5.572	5.539	-0.033
100	383	6.286	5.744	-0.541
100	417	5.383	5.077	-0.306
101	513	5.409	5.391	-0.018
101	526	5.709	5.768	0.059
101	532	5.589	5.598	0.009
101	533	5.355	5.321	-0.034
101	534	5.523	5.652	0.129
Max		6.286	6.095	0.421
Average		5.510	5.452	-0.058
Min		4.981	4.846	-0.541
Std Dev		0.279	0.281	0.207

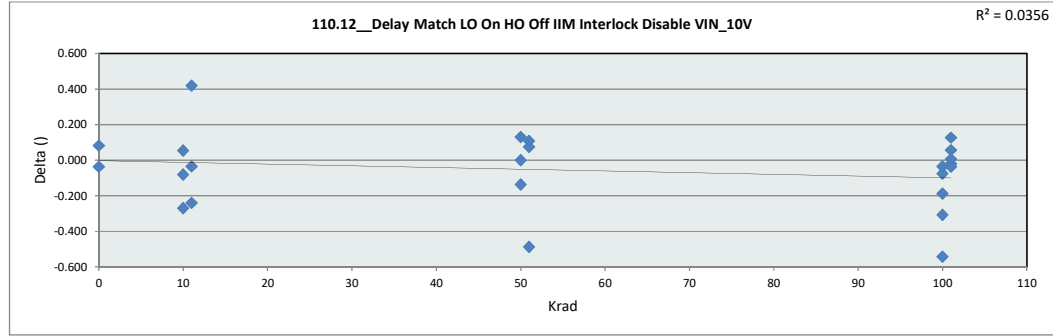

110.12 Delay Match LO On H	
Test Site	DAL
Tester	ETS364
Test Number	EB672303
Max Limit	12
Min Limit	

	0	10	11	50	51	100	101
LL							
Min	5.526	5.244	5.399	4.847	5.198	5.009	5.321
Average	5.810	5.437	5.558	5.141	5.467	5.340	5.546
Max	6.095	5.681	5.791	5.314	5.695	5.744	5.768
UL	12.000	12.000	12.000	12.000	12.000	12.000	12.000

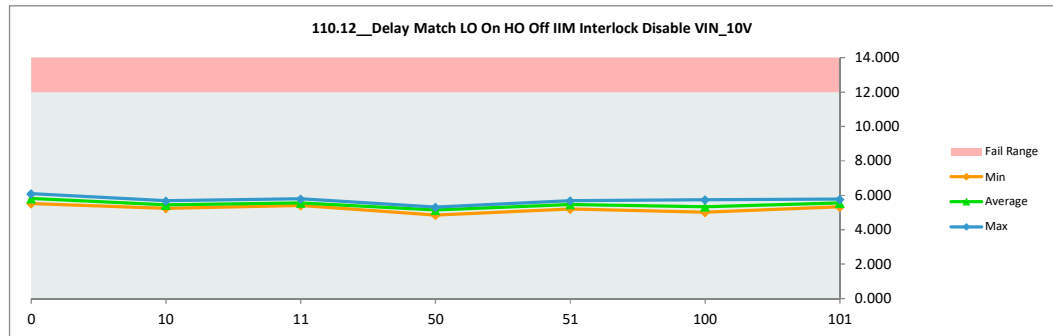

TID "HDR" Report
5962R2220102VXC

110.13 Delay Match LO Off HO		
Test Site	DAL	DAL
Tester	ETS364	ETS364
Test Number	EB672303	EB672303
Unit		
Max Limit	4	4
Min Limit		

Krad	Serial #	Pre_HDR_6013	Post_HDR_6013	Delta
0	1	1.408	1.317	-0.090
0	2	1.177	1.125	-0.053
10	182	1.216	1.287	0.070
10	202	1.799	1.838	0.038
10	204	1.342	1.653	0.311
11	418	1.259	1.363	0.104
11	419	1.280	1.610	0.330
11	443	1.214	1.366	0.152
50	259	1.310	1.207	-0.103
50	346	1.584	1.772	0.188
50	347	1.826	1.696	-0.129
51	462	1.308	1.545	0.237
51	478	1.257	1.694	0.437
51	503	1.251	1.359	0.108
100	354	1.173	1.465	0.293
100	363	1.452	1.989	0.538
100	366	1.010	1.279	0.269
100	383	1.157	1.423	0.266
100	417	1.444	1.747	0.304
101	513	1.374	1.646	0.272
101	526	1.241	1.548	0.307
101	532	1.444	1.566	0.122
101	533	1.496	1.686	0.191
101	534	1.346	1.315	-0.031
Max		1.826	1.989	0.538
Average		1.349	1.521	0.172
Min		1.010	1.125	-0.129
Std Dev		0.190	0.219	0.174

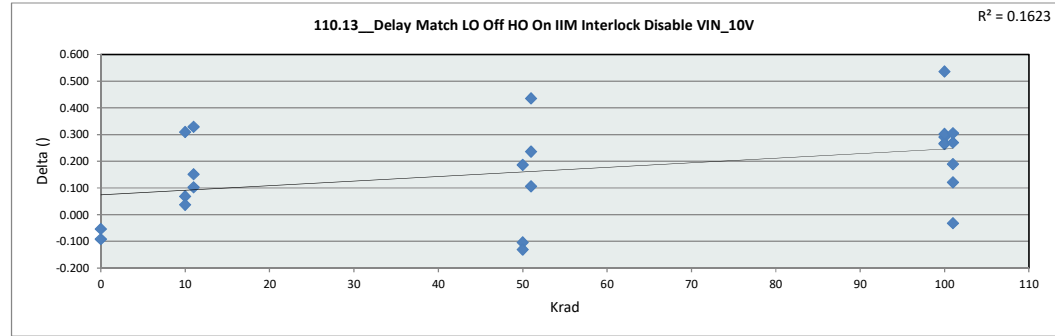

110.13 Delay Match LO Off H	
Test Site	DAL
Tester	ETS364
Test Number	EB672303
Max Limit	4
Min Limit	

	0	10	11	50	51	100	101
LL							
Min	1.125	1.287	1.363	1.207	1.359	1.279	1.315
Average	1.221	1.592	1.446	1.559	1.533	1.581	1.552
Max	1.317	1.838	1.610	1.772	1.694	1.989	1.686
UL	4.000	4.000	4.000	4.000	4.000	4.000	4.000

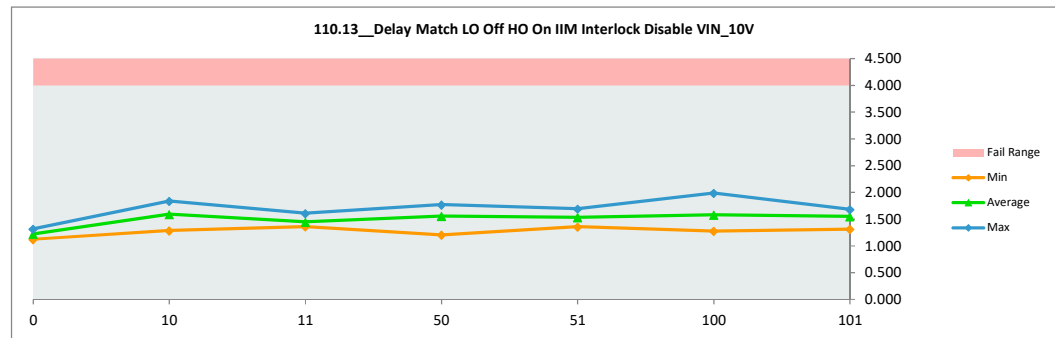

TID "HDR" Report
5962R2220102VXC

111.0 Prop Delay LO Off PWM		
Test Site	DAL	DAL
Tester	ETS364	ETS364
Test Number	EB672303	EB672303
Unit		
Max Limit	48	48
Min Limit	1	1

Krad	Serial #	Pre_HDR_6013	Post_HDR_6013	Delta
0	1	30.390	30.229	-0.161
0	2	30.564	30.438	-0.126
10	182	30.268	30.101	-0.167
10	202	30.288	30.145	-0.143
10	204	29.829	30.145	0.315
11	418	30.207	30.473	0.266
11	419	30.042	30.290	0.249
11	443	30.309	30.117	-0.192
50	259	29.844	29.422	-0.423
50	346	30.037	29.632	-0.405
50	347	30.755	30.395	-0.360
51	462	30.020	30.381	0.361
51	478	30.246	30.053	-0.193
51	503	30.541	30.082	-0.459
100	354	30.275	29.606	-0.669
100	363	30.050	29.442	-0.609
100	366	30.036	29.511	-0.524
100	383	30.142	29.518	-0.624
100	417	30.427	29.835	-0.592
101	513	30.194	29.600	-0.594
101	526	30.773	29.989	-0.784
101	532	30.469	29.706	-0.764
101	533	30.308	29.519	-0.790
101	534	29.848	29.252	-0.596
Max		30.773	30.473	0.361
Average		30.244	29.912	-0.333
Min		29.829	29.252	-0.790
Std Dev		0.261	0.374	0.356

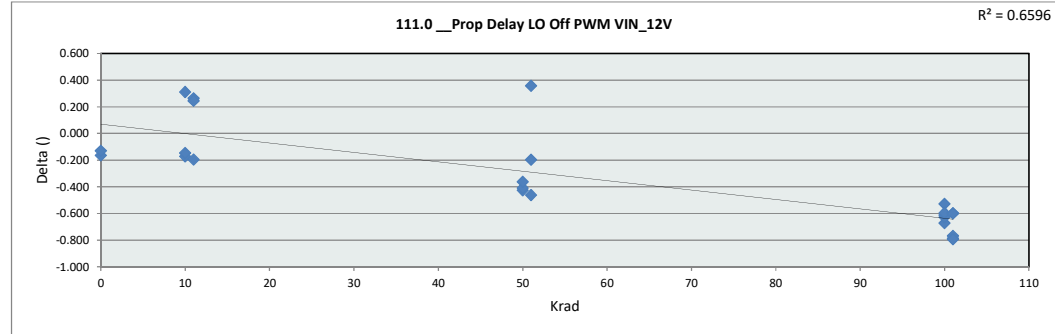

111.0 Prop Delay LO Off PW	
Test Site	DAL
Tester	ETS364
Test Number	EB672303
Max Limit	48
Min Limit	1

Krad	0	10	11	50	51	100	101
LL	1.000	1.000	1.000	1.000	1.000	1.000	1.000
Min	30.230	30.101	30.117	29.422	30.053	29.442	29.252
Average	30.334	30.130	30.293	29.816	30.172	29.582	29.613
Max	30.438	30.145	30.473	30.395	30.381	29.835	29.989
UL	48.000	48.000	48.000	48.000	48.000	48.000	48.000

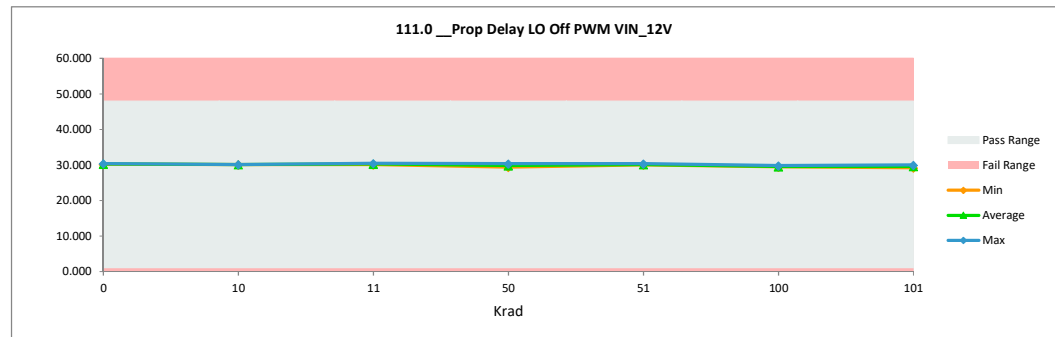

TID "HDR" Report
5962R2220102VXC

111.1 Prop Delay HO Off PWM		
Test Site	DAL	DAL
Tester	ETS364	ETS364
Test Number	EB672303	EB672303
Unit		
Max Limit	50	50
Min Limit	1	1

Krad	Serial #	Pre_HDR_6013	Post_HDR_6013	Delta
0	1	33.128	32.968	-0.160
0	2	33.978	33.865	-0.113
10	182	33.414	33.219	-0.195
10	202	33.141	33.194	0.053
10	204	32.778	32.817	0.040
11	418	33.213	33.304	0.091
11	419	32.998	33.109	0.111
11	443	33.071	33.464	0.393
50	259	32.668	32.300	-0.368
50	346	32.503	32.048	-0.455
50	347	33.284	32.964	-0.320
51	462	32.918	33.373	0.455
51	478	33.356	32.889	-0.467
51	503	33.722	33.410	-0.312
100	354	33.255	32.528	-0.727
100	363	32.614	32.129	-0.486
100	366	33.158	32.533	-0.625
100	383	33.849	32.800	-1.050
100	417	33.218	32.528	-0.690
101	513	33.138	32.645	-0.493
101	526	33.996	33.202	-0.794
101	532	33.436	32.871	-0.566
101	533	33.001	32.522	-0.479
101	534	32.955	32.734	-0.221
Max		33.996	33.865	0.455
Average		33.200	32.892	-0.307
Min		32.503	32.048	-1.050
Std Dev		0.396	0.446	0.371

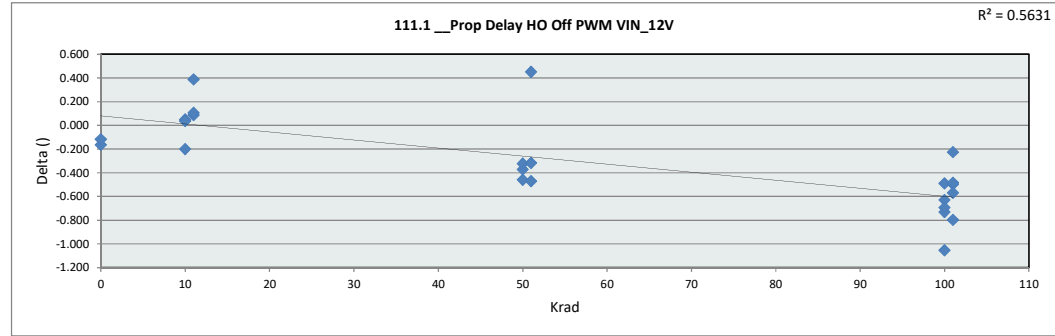

111.1 Prop Delay HO Off PW	
Test Site	DAL
Tester	ETS364
Test Number	EB672303
Max Limit	50
Min Limit	1

Krad	0	10	11	50	51	100	101
LL	1.000	1.000	1.000	1.000	1.000	1.000	1.000
Min	32.968	32.817	33.109	32.048	32.889	32.129	32.522
Average	33.416	33.077	33.292	32.437	33.224	32.504	32.795
Max	33.865	33.219	33.464	32.964	33.410	32.800	33.202
UL	50.000	50.000	50.000	50.000	50.000	50.000	50.000

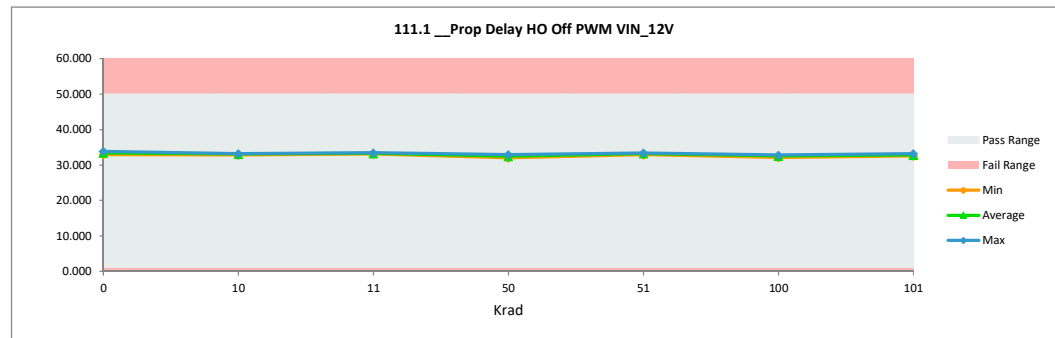

TID "HDR" Report
5962R2220102VXC

111.2 __Prop Delay LO On IIM Interlock VIN_12V		
Test Site	DAL	DAL
Tester	ETS364	ETS364
Test Number	EB672303	EB672303
Unit		
Max Limit	38	38
Min Limit	1	1

Krad	Serial #	Pre_HDR_6013	Post_HDR_6013	Delta
0	1	23.170	23.006	-0.165
0	2	23.285	23.188	-0.096
10	182	23.123	23.029	-0.094
10	202	23.215	23.154	-0.061
10	204	22.899	23.068	0.169
11	418	23.095	23.381	0.286
11	419	23.116	23.230	0.115
11	443	23.105	23.040	-0.066
50	259	23.055	22.773	-0.282
50	346	23.084	22.827	-0.257
50	347	23.204	23.047	-0.157
51	462	23.209	23.154	-0.056
51	478	23.153	23.096	-0.057
51	503	23.419	23.186	-0.233
100	354	23.266	22.794	-0.472
100	363	23.038	22.932	-0.106
100	366	23.075	22.740	-0.336
100	383	23.110	22.759	-0.351
100	417	23.251	22.952	-0.299
101	513	23.069	22.968	-0.101
101	526	23.403	23.135	-0.268
101	532	23.295	22.977	-0.318
101	533	22.971	22.713	-0.258
101	534	22.991	22.706	-0.285
	Max	23.419	23.381	0.286
	Average	23.150	22.994	-0.156
	Min	22.899	22.706	-0.472
	Std Dev	0.128	0.184	0.176

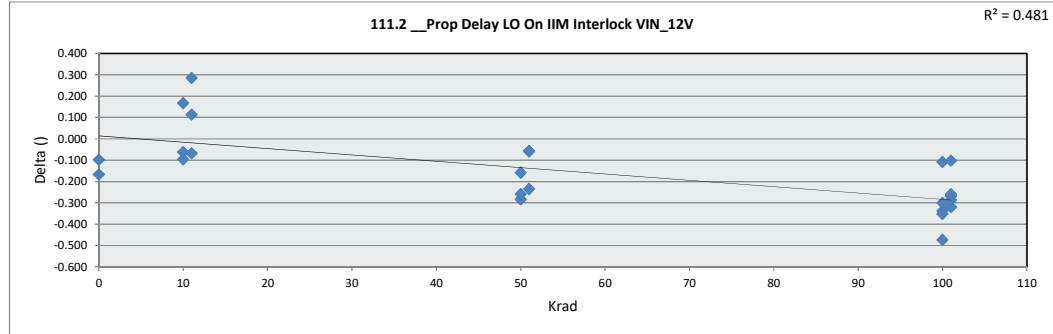

111.2 __Prop Delay LO On IIM	
Test Site	DAL
Tester	ETS364
Test Number	EB672303
Max Limit	38
Min Limit	1

Krad	0	10	11	50	51	100	101
LL	1.000	1.000	1.000	1.000	1.000	1.000	1.000
Min	23.006	23.029	23.040	22.773	23.096	22.740	22.706
Average	23.097	23.084	23.217	22.882	23.145	22.835	22.900
Max	23.189	23.155	23.381	23.047	23.186	22.952	23.135
UL	38.000	38.000	38.000	38.000	38.000	38.000	38.000

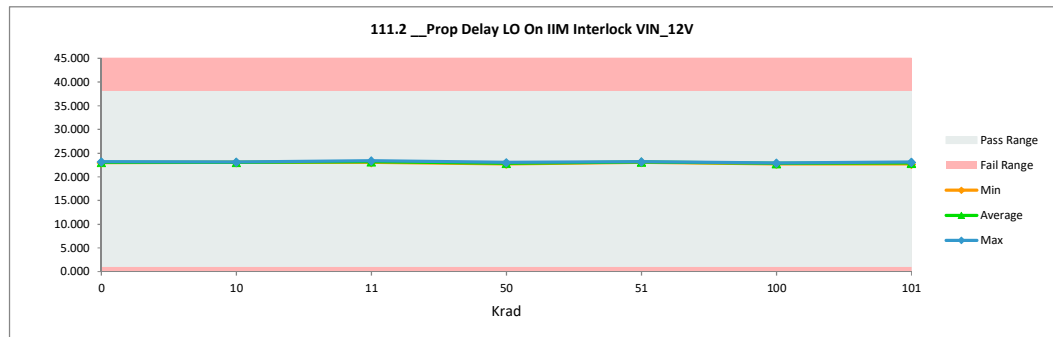

TID "HDR" Report
5962R2220102VXC

111.3 Prop Delay LO Off IIM I		
Test Site	DAL	DAL
Tester	ETS364	ETS364
Test Number	EB672303	EB672303
Unit		
Max Limit	38	38
Min Limit	1	1

Krad	Serial #	Pre_HDR_6013	Post_HDR_6013	Delta
0	1	27.546	27.389	-0.158
0	2	27.715	27.576	-0.139
10	182	27.327	27.217	-0.110
10	202	27.322	27.453	0.131
10	204	27.069	27.467	0.398
11	418	27.375	27.504	0.129
11	419	27.125	27.582	0.457
11	443	27.191	27.287	0.096
50	259	27.226	26.952	-0.273
50	346	27.180	26.926	-0.254
50	347	27.643	27.526	-0.117
51	462	27.136	27.317	0.181
51	478	27.298	27.295	-0.003
51	503	27.640	27.421	-0.219
100	354	27.295	26.901	-0.394
100	363	27.168	27.121	-0.048
100	366	27.253	27.003	-0.250
100	383	27.360	26.996	-0.364
100	417	27.435	27.373	-0.062
101	513	27.387	27.144	-0.242
101	526	27.859	27.424	-0.435
101	532	27.541	27.320	-0.220
101	533	27.166	26.931	-0.234
101	534	27.286	27.039	-0.247
	Max	27.859	27.582	0.457
	Average	27.356	27.257	-0.099
	Min	27.069	26.901	-0.435
	Std Dev	0.206	0.225	0.232

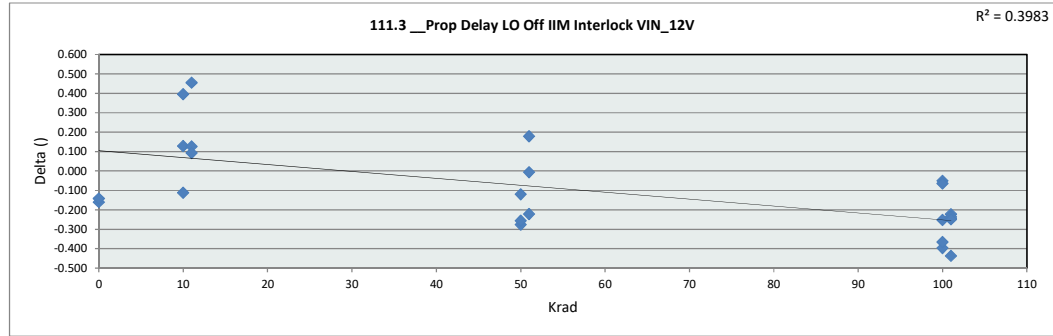

111.3 Prop Delay LO Off IIM	
Test Site	DAL
Tester	ETS364
Test Number	EB672303
Max Limit	38
Min Limit	1

Krad	0	10	11	50	51	100	101
LL	1.000	1.000	1.000	1.000	1.000	1.000	1.000
Min	27.389	27.217	27.287	26.926	27.295	26.901	26.931
Average	27.482	27.379	27.457	27.135	27.344	27.079	27.172
Max	27.576	27.467	27.582	27.526	27.421	27.373	27.424
UL	38.000	38.000	38.000	38.000	38.000	38.000	38.000

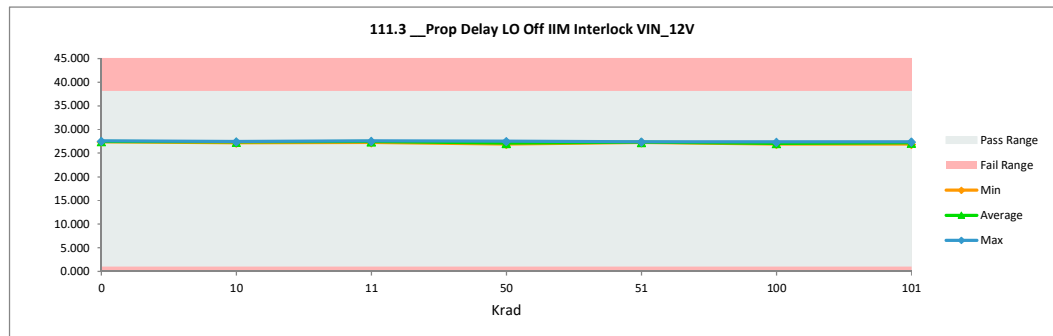

TID "HDR" Report
5962R2220102VXC

111.4 Prop Delay HO On IIM I		
Test Site	DAL	DAL
Tester	ETS364	ETS364
Test Number	EB672303	EB672303
Unit		
Max Limit	40	40
Min Limit	1	1

Krad	Serial #	Pre_HDR_6013	Post_HDR_6013	Delta
0	1	26.018	25.978	-0.040
0	2	26.438	26.430	-0.008
10	182	26.127	25.962	-0.165
10	202	25.744	25.653	-0.091
10	204	25.687	25.699	0.013
11	418	26.196	26.210	0.014
11	419	25.817	25.990	0.174
11	443	25.930	26.148	0.218
50	259	25.970	25.792	-0.178
50	346	25.514	25.218	-0.296
50	347	25.949	25.697	-0.252
51	462	25.810	25.905	0.095
51	478	26.022	25.576	-0.445
51	503	26.377	26.154	-0.223
100	354	26.103	25.506	-0.596
100	363	25.699	25.098	-0.600
100	366	26.363	25.787	-0.576
100	383	26.364	25.596	-0.769
100	417	25.930	25.640	-0.290
101	513	26.028	25.595	-0.433
101	526	26.565	25.881	-0.684
101	532	26.163	25.693	-0.470
101	533	25.765	25.168	-0.597
101	534	26.001	25.637	-0.364
	Max	26.565	26.430	0.218
	Average	26.024	25.751	-0.274
	Min	25.514	25.098	-0.769
	Std Dev	0.266	0.324	0.283

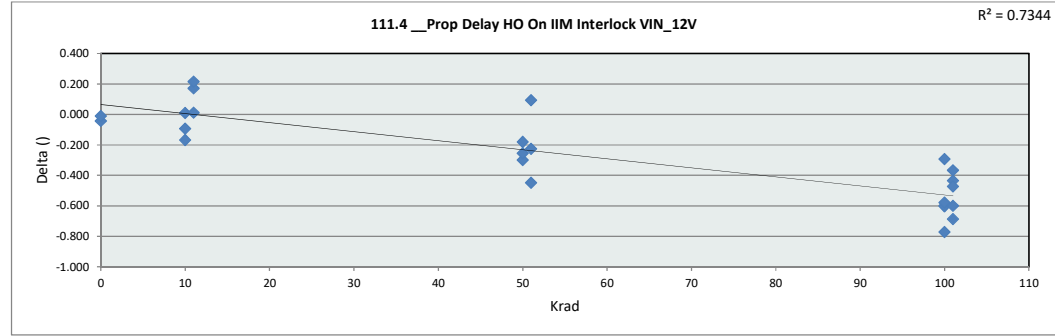

111.4 Prop Delay HO On IIM	
Test Site	DAL
Tester	ETS364
Test Number	EB672303
Max Limit	40
Min Limit	1

Krad	0	10	11	50	51	100	101
LL	1.000	1.000	1.000	1.000	1.000	1.000	1.000
Min	25.978	25.653	25.990	25.218	25.576	25.099	25.168
Average	26.204	25.771	26.116	25.569	25.879	25.525	25.595
Max	26.430	25.962	26.210	25.792	26.154	25.787	25.881
UL	40.000	40.000	40.000	40.000	40.000	40.000	40.000

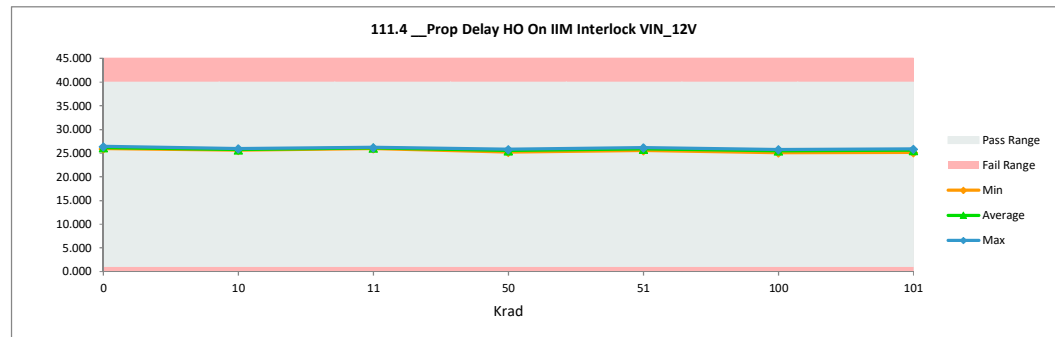

TID "HDR" Report
5962R2220102VXC

111.5 Prop Delay HO Off IIM I		
Test Site	DAL	DAL
Tester	ETS364	ETS364
Test Number	EB672303	EB672303
Unit		
Max Limit	40	40
Min Limit	1	1

Krad	Serial #	Pre_HDR_6013	Post_HDR_6013	Delta
0	1	28.169	28.064	-0.105
0	2	28.779	28.693	-0.086
10	182	28.324	28.168	-0.156
10	202	28.113	28.025	-0.088
10	204	27.894	27.796	-0.098
11	418	28.253	28.331	0.077
11	419	27.932	28.086	0.154
11	443	27.940	28.303	0.363
50	259	27.755	27.608	-0.147
50	346	27.429	27.139	-0.290
50	347	28.059	27.821	-0.239
51	462	28.016	28.143	0.127
51	478	28.218	27.794	-0.424
51	503	28.528	28.389	-0.138
100	354	28.195	27.676	-0.518
100	363	27.694	27.367	-0.328
100	366	28.218	27.806	-0.412
100	383	28.865	27.958	-0.908
100	417	28.002	27.716	-0.286
101	513	28.161	27.786	-0.375
101	526	28.557	28.188	-0.369
101	532	28.263	27.976	-0.287
101	533	27.759	27.384	-0.375
101	534	28.083	28.021	-0.061
	Max	28.865	28.693	0.363
	Average	28.134	27.927	-0.207
	Min	27.429	27.139	-0.908
	Std Dev	0.331	0.353	0.258

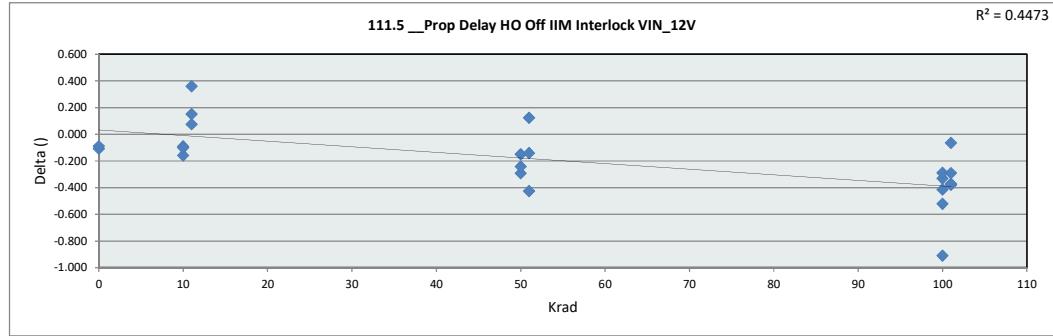

111.5 Prop Delay HO Off IIM	
Test Site	DAL
Tester	ETS364
Test Number	EB672303
Max Limit	40
Min Limit	1

Krad	0	10	11	50	51	100	101
LL	1.000	1.000	1.000	1.000	1.000	1.000	1.000
Min	28.064	27.796	28.086	27.139	27.794	27.367	27.384
Average	28.378	27.996	28.240	27.522	28.109	27.704	27.871
Max	28.693	28.168	28.331	27.821	28.389	27.958	28.188
UL	40.000	40.000	40.000	40.000	40.000	40.000	40.000

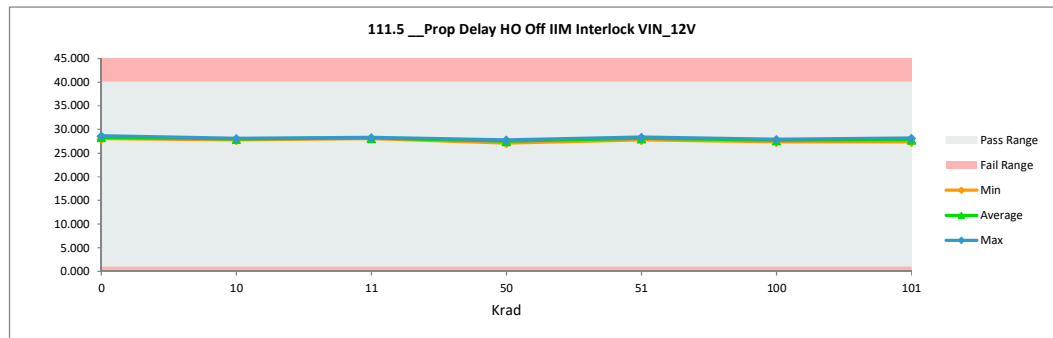

TID "HDR" Report
5962R2220102VXC

111.6 Prop Delay LO On IIM Interlock Disable VIN_12V		
Test Site	DAL	DAL
Tester	ETS364	ETS364
Test Number	EB672303	EB672303
Unit		
Max Limit	38	38
Min Limit	1	1

Krad	Serial #	Pre_HDR_6013	Post_HDR_6013	Delta
0	1	23.198	23.021	-0.177
0	2	23.272	23.183	-0.088
10	182	23.175	23.005	-0.170
10	202	23.129	23.124	-0.005
10	204	22.857	22.986	0.129
11	418	23.083	23.394	0.311
11	419	23.014	23.212	0.198
11	443	23.033	23.094	0.061
50	259	23.031	22.785	-0.246
50	346	23.102	22.857	-0.245
50	347	23.252	23.046	-0.206
51	462	23.195	23.194	-0.001
51	478	23.106	23.135	0.028
51	503	23.364	23.124	-0.240
100	354	23.216	22.850	-0.366
100	363	23.016	22.865	-0.151
100	366	23.066	22.768	-0.298
100	383	23.121	22.684	-0.437
100	417	23.227	23.001	-0.226
101	513	23.118	22.862	-0.256
101	526	23.397	23.053	-0.344
101	532	23.295	22.951	-0.344
101	533	22.921	22.602	-0.318
101	534	22.990	22.723	-0.267
	Max	23.397	23.394	0.311
	Average	23.132	22.980	-0.152
	Min	22.857	22.602	-0.437
	Std Dev	0.133	0.191	0.192

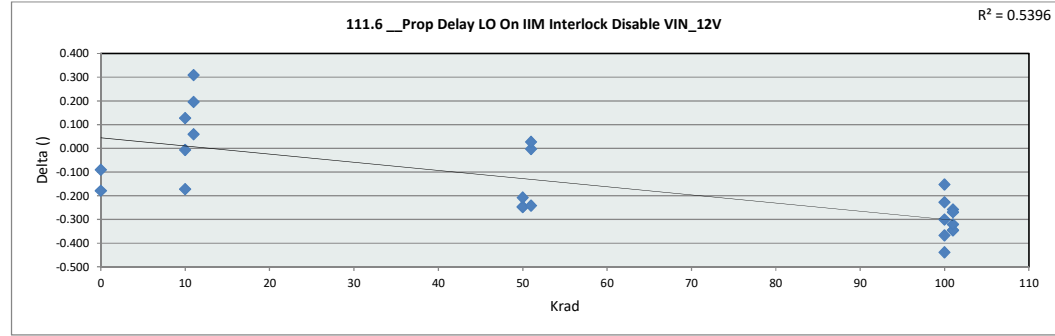

111.6 Prop Delay LO On IIM	
Test Site	DAL
Tester	ETS364
Test Number	EB672303
Max Limit	38
Min Limit	1

Krad	0	10	11	50	51	100	101
LL	1.000	1.000	1.000	1.000	1.000	1.000	1.000
Min	23.021	22.986	23.094	22.785	23.124	22.684	22.602
Average	23.102	23.038	23.233	22.896	23.151	22.834	22.838
Max	23.183	23.124	23.394	23.046	23.194	23.001	23.053
UL	38.000	38.000	38.000	38.000	38.000	38.000	38.000

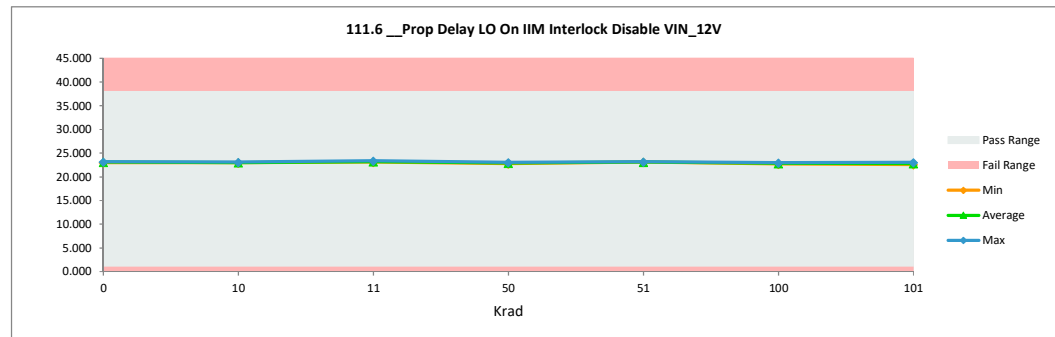

TID "HDR" Report
5962R2220102VXC

111.7 Prop Delay LO Off IIM I		
Test Site	DAL	DAL
Tester	ETS364	ETS364
Test Number	EB672303	EB672303
Unit		
Max Limit	38	38
Min Limit	1	1

Krad	Serial #	Pre_HDR_6013	Post_HDR_6013	Delta
0	1	27.365	27.248	-0.117
0	2	27.546	27.342	-0.204
10	182	27.249	27.081	-0.168
10	202	27.246	27.336	0.090
10	204	26.896	27.246	0.350
11	418	27.239	27.427	0.188
11	419	26.984	27.430	0.446
11	443	27.046	27.174	0.128
50	259	27.129	26.825	-0.304
50	346	27.033	26.818	-0.215
50	347	27.522	27.347	-0.176
51	462	26.994	27.303	0.309
51	478	27.078	27.135	0.057
51	503	27.471	27.264	-0.207
100	354	27.107	26.732	-0.375
100	363	27.103	27.092	-0.011
100	366	27.147	26.885	-0.263
100	383	27.349	26.810	-0.538
100	417	27.239	27.087	-0.152
101	513	27.241	27.127	-0.114
101	526	27.749	27.342	-0.406
101	532	27.480	27.145	-0.336
101	533	27.070	26.831	-0.239
101	534	27.105	27.011	-0.094
	Max	27.749	27.430	0.446
	Average	27.224	27.127	-0.098
	Min	26.896	26.732	-0.538
	Std Dev	0.211	0.214	0.249

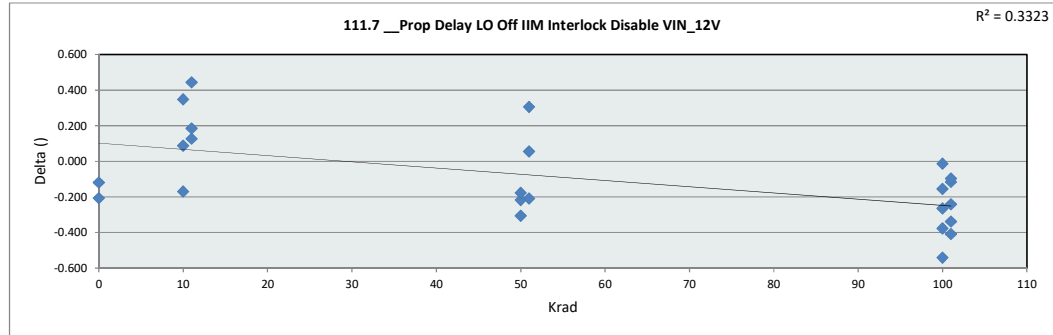

111.7 Prop Delay LO Off IIM I	
Test Site	DAL
Tester	ETS364
Test Number	EB672303
Max Limit	38
Min Limit	1

Krad	0	10	11	50	51	100	101
LL	1.000	1.000	1.000	1.000	1.000	1.000	1.000
Min	27.248	27.081	27.174	26.818	27.135	26.732	26.831
Average	27.295	27.221	27.344	26.997	27.234	26.921	27.091
Max	27.342	27.336	27.430	27.347	27.303	27.092	27.342
UL	38.000	38.000	38.000	38.000	38.000	38.000	38.000

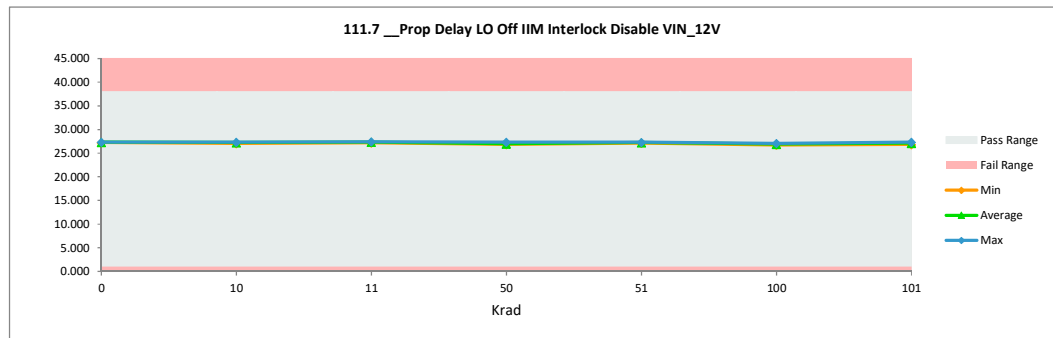

TID "HDR" Report
5962R2220102VXC

111.8 Prop Delay HO On IIM I		
Test Site	DAL	DAL
Tester	ETS364	ETS364
Test Number	EB672303	EB672303
Unit		
Max Limit	40	40
Min Limit	1	1

Krad	Serial #	Pre_HDR_6013	Post_HDR_6013	Delta
0	1	26.042	25.946	-0.096
0	2	26.388	26.275	-0.112
10	182	26.013	25.826	-0.188
10	202	25.576	25.508	-0.068
10	204	25.608	25.536	-0.071
11	418	26.032	26.129	0.097
11	419	25.740	25.852	0.112
11	443	25.863	25.928	0.065
50	259	25.924	25.594	-0.330
50	346	25.446	25.078	-0.367
50	347	25.812	25.553	-0.259
51	462	25.651	25.739	0.089
51	478	25.920	25.468	-0.452
51	503	26.282	26.079	-0.203
100	354	25.988	25.459	-0.529
100	363	25.472	25.026	-0.446
100	366	26.203	25.643	-0.560
100	383	26.217	25.451	-0.766
100	417	25.784	25.550	-0.234
101	513	25.933	25.418	-0.515
101	526	26.379	25.736	-0.643
101	532	25.970	25.538	-0.432
101	533	25.629	25.054	-0.575
101	534	25.839	25.532	-0.307
	Max	26.388	26.275	0.112
	Average	25.904	25.622	-0.283
	Min	25.446	25.026	-0.766
	Std Dev	0.267	0.320	0.252

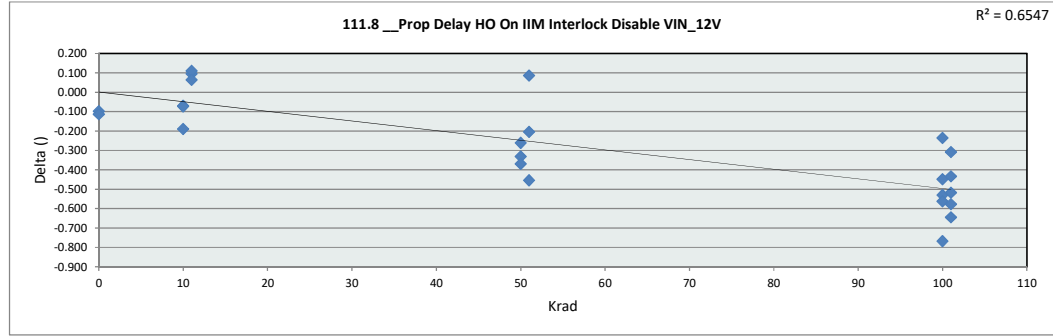

111.8 Prop Delay HO On IIM	
Test Site	DAL
Tester	ETS364
Test Number	EB672303
Max Limit	40
Min Limit	1

Krad	0	10	11	50	51	100	101
LL	1.000	1.000	1.000	1.000	1.000	1.000	1.000
Min	25.946	25.508	25.852	25.078	25.468	25.026	25.054
Average	26.111	25.623	25.970	25.409	25.762	25.426	25.456
Max	26.276	25.826	26.129	25.594	26.079	25.643	25.736
UL	40.000	40.000	40.000	40.000	40.000	40.000	40.000

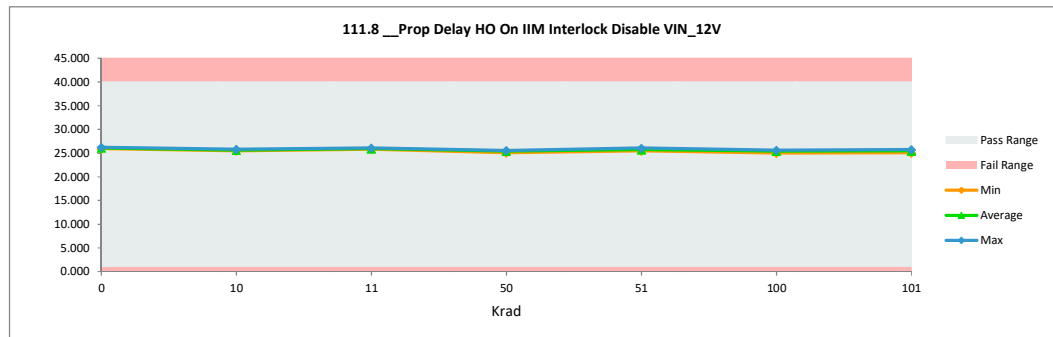

TID "HDR" Report
5962R2220102VXC

111.9 Prop Delay HO Off IIM I		
Test Site	DAL	DAL
Tester	ETS364	ETS364
Test Number	EB672303	EB672303
Unit		
Max Limit	40	40
Min Limit	1	1

Krad	Serial #	Pre_HDR_6013	Post_HDR_6013	Delta
0	1	28.677	28.554	-0.123
0	2	29.334	29.284	-0.049
10	182	28.836	28.736	-0.100
10	202	28.558	28.571	0.013
10	204	28.378	28.310	-0.067
11	418	28.827	28.772	-0.055
11	419	28.457	28.598	0.141
11	443	28.427	28.781	0.353
50	259	28.288	28.089	-0.198
50	346	28.001	27.658	-0.343
50	347	28.484	28.199	-0.284
51	462	28.480	28.681	0.201
51	478	28.749	28.359	-0.390
51	503	28.991	28.814	-0.177
100	354	28.686	28.240	-0.446
100	363	28.279	27.799	-0.480
100	366	28.747	28.362	-0.385
100	383	29.398	28.555	-0.843
100	417	28.586	28.254	-0.332
101	513	28.700	28.265	-0.435
101	526	29.149	28.695	-0.454
101	532	28.797	28.563	-0.234
101	533	28.347	27.922	-0.426
101	534	28.616	28.437	-0.179
Max		29.398	29.284	0.353
Average		28.658	28.437	-0.221
Min		28.001	27.658	-0.843
Std Dev		0.331	0.360	0.258

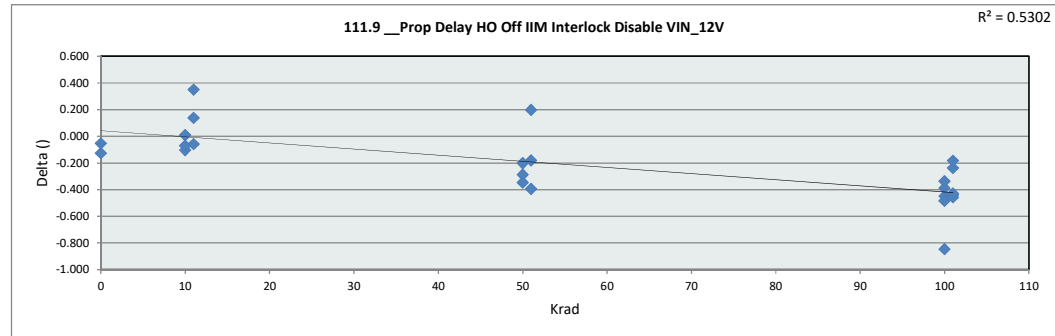

111.9 Prop Delay HO Off IIM I	
Test Site	DAL
Tester	ETS364
Test Number	EB672303
Max Limit	40
Min Limit	1

Krad	0	10	11	50	51	100	101
LL	1.000	1.000	1.000	1.000	1.000	1.000	1.000
Min	28.554	28.310	28.599	27.658	28.359	27.799	27.922
Average	28.919	28.539	28.717	27.982	28.618	28.242	28.376
Max	29.284	28.736	28.781	28.200	28.814	28.555	28.695
UL	40.000	40.000	40.000	40.000	40.000	40.000	40.000

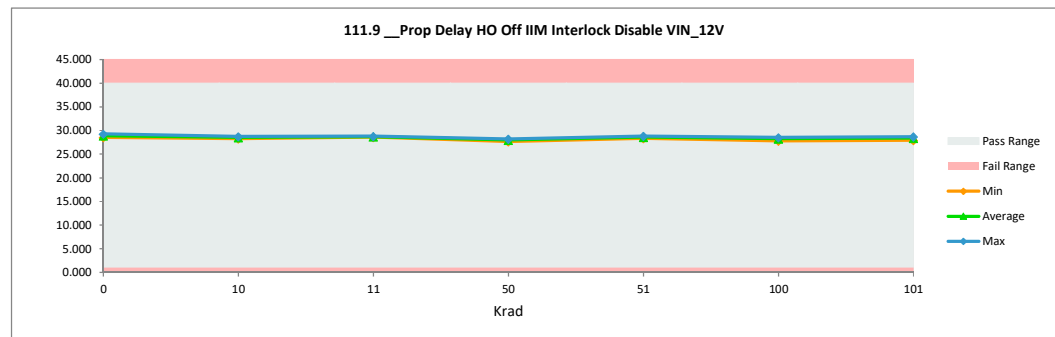

TID "HDR" Report
5962R2220102VXC

111.10 Delay Match LO On HO		
Test Site	DAL	DAL
Tester	ETS364	ETS364
Test Number	EB672303	EB672303
Unit		
Max Limit	12	12
Min Limit		

Krad	Serial #	Pre_HDR_6013	Post_HDR_6013	Delta
0	1	4.999	5.059	0.060
0	2	5.494	5.504	0.010
10	182	5.201	5.139	-0.062
10	202	4.898	4.870	-0.028
10	204	4.995	4.728	-0.267
11	418	5.159	4.950	-0.209
11	419	4.816	4.856	0.040
11	443	4.835	5.263	0.429
50	259	4.701	4.835	0.135
50	346	4.345	4.312	-0.033
50	347	4.855	4.774	-0.082
51	462	4.807	4.990	0.183
51	478	5.065	4.698	-0.366
51	503	5.108	5.203	0.095
100	354	4.929	4.882	-0.047
100	363	4.656	4.435	-0.222
100	366	5.142	5.066	-0.076
100	383	5.755	5.199	-0.557
100	417	4.751	4.764	0.013
101	513	5.092	4.817	-0.274
101	526	5.154	5.053	-0.101
101	532	4.968	4.999	0.030
101	533	4.787	4.671	-0.117
101	534	5.092	5.316	0.224
Max		5.755	5.504	0.429
Average		4.984	4.933	-0.051
Min		4.345	4.312	-0.557
Std Dev		0.282	0.273	0.205

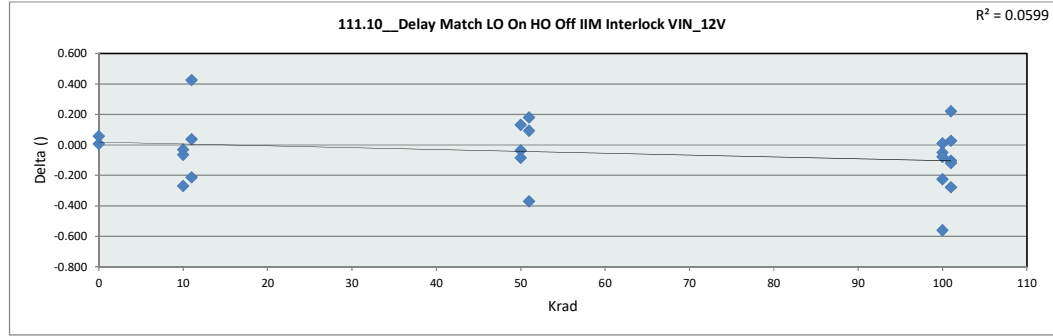

111.10 Delay Match LO On H	
Test Site	DAL
Tester	ETS364
Test Number	EB672303
Max Limit	12
Min Limit	

	0	10	11	50	51	100	101
LL							
Min	5.059	4.728	4.856	4.312	4.698	4.435	4.671
Average	5.282	4.913	5.023	4.640	4.964	4.869	4.971
Max	5.504	5.139	5.263	4.835	5.204	5.199	5.316
UL	12.000	12.000	12.000	12.000	12.000	12.000	12.000

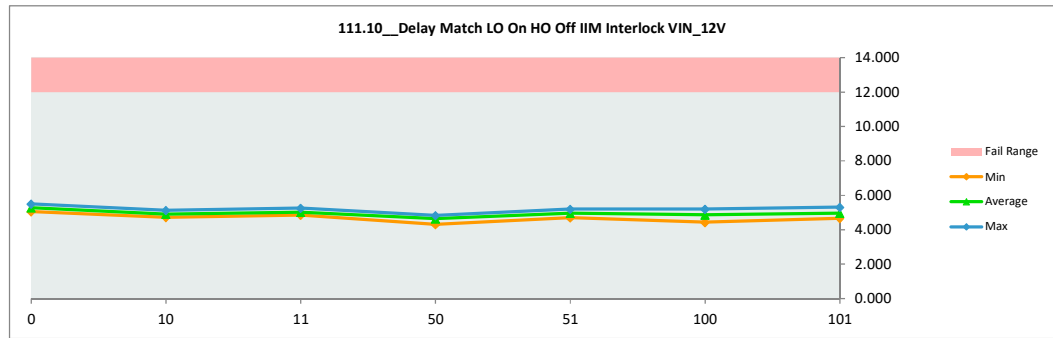

TID "HDR" Report
5962R2220102VXC

111.11 Delay Match LO Off HO		
Test Site	DAL	DAL
Tester	ETS364	ETS364
Test Number	EB672303	EB672303
Unit		
Max Limit	4	4
Min Limit		

Krad	Serial #	Pre_HDR_6013	Post_HDR_6013	Delta
0	1	1.528	1.411	-0.118
0	2	1.277	1.146	-0.132
10	182	1.200	1.255	0.055
10	202	1.577	1.800	0.222
10	204	1.383	1.768	0.386
11	418	1.178	1.293	0.115
11	419	1.308	1.591	0.284
11	443	1.261	1.139	-0.122
50	259	1.255	1.160	-0.095
50	346	1.666	1.708	0.041
50	347	1.694	1.830	0.135
51	462	1.325	1.411	0.086
51	478	1.276	1.718	0.442
51	503	1.263	1.268	0.004
100	354	1.192	1.394	0.202
100	363	1.470	2.022	0.552
100	366	0.890	1.216	0.327
100	383	0.996	1.401	0.405
100	417	1.505	1.733	0.228
101	513	1.359	1.549	0.190
101	526	1.294	1.543	0.249
101	532	1.378	1.628	0.250
101	533	1.401	1.763	0.363
101	534	1.285	1.402	0.117
Max		1.694	2.022	0.552
Average		1.332	1.506	0.174
Min		0.890	1.139	-0.132
Std Dev		0.186	0.250	0.189

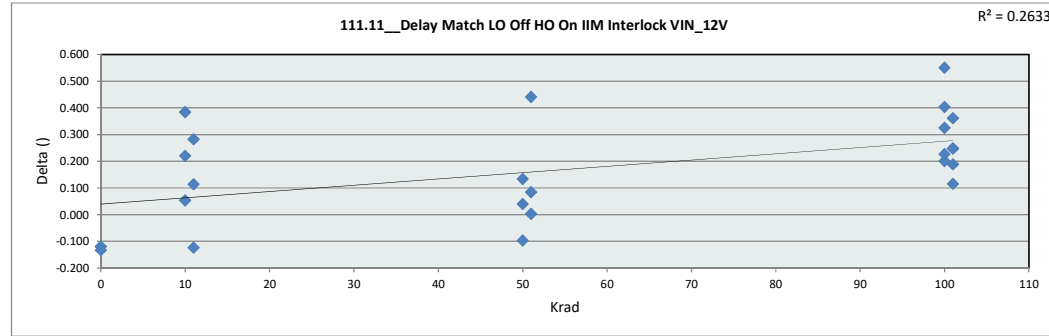

111.11 Delay Match LO Off H	
Test Site	DAL
Tester	ETS364
Test Number	EB672303
Max Limit	4
Min Limit	

Krad	0	10	11	50	51	100	101
LL							
Min	1.146	1.255	1.139	1.160	1.268	1.216	1.402
Average	1.278	1.608	1.341	1.566	1.466	1.553	1.577
Max	1.411	1.800	1.591	1.830	1.718	2.022	1.764
UL	4.000	4.000	4.000	4.000	4.000	4.000	4.000

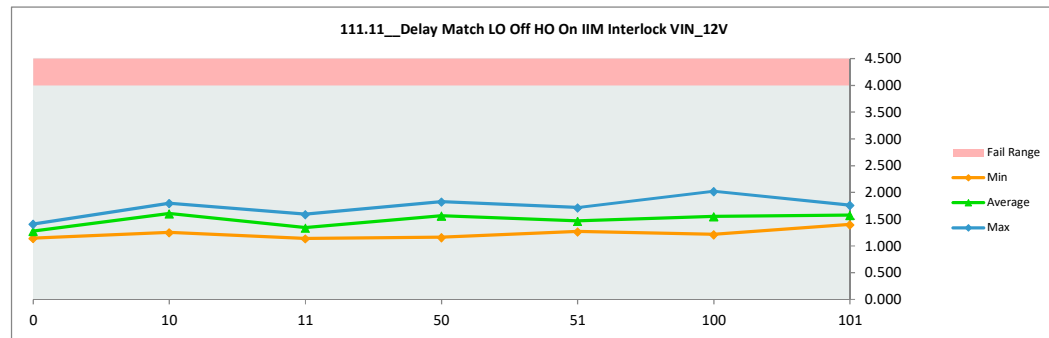

TID "HDR" Report
5962R2220102VXC

111.12 Delay Match LO On HO		
Test Site	DAL	DAL
Tester	ETS364	ETS364
Test Number	EB672303	EB672303
Unit		
Max Limit	12	12
Min Limit		

Krad	Serial #	Pre_HDR_6013	Post_HDR_6013	Delta
0	1	5.479	5.533	0.054
0	2	6.062	6.101	0.039
10	182	5.660	5.731	0.070
10	202	5.429	5.447	0.018
10	204	5.520	5.324	-0.196
11	418	5.744	5.378	-0.366
11	419	5.443	5.387	-0.056
11	443	5.394	5.686	0.292
50	259	5.257	5.305	0.048
50	346	4.899	4.801	-0.098
50	347	5.232	5.154	-0.079
51	462	5.285	5.487	0.202
51	478	5.643	5.225	-0.419
51	503	5.627	5.690	0.063
100	354	5.470	5.390	-0.080
100	363	5.263	4.934	-0.329
100	366	5.681	5.594	-0.087
100	383	6.277	5.871	-0.406
100	417	5.359	5.253	-0.107
101	513	5.582	5.403	-0.179
101	526	5.752	5.641	-0.110
101	532	5.503	5.612	0.110
101	533	5.427	5.320	-0.107
101	534	5.626	5.714	0.088
Max		6.277	6.101	0.292
Average		5.526	5.457	-0.068
Min		4.899	4.801	-0.419
Std Dev		0.279	0.286	0.183

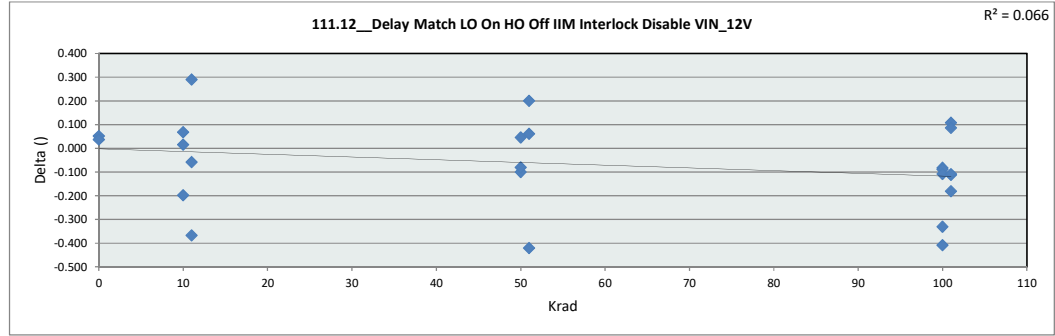

111.12 Delay Match LO On H	
Test Site	DAL
Tester	ETS364
Test Number	EB672303
Max Limit	12
Min Limit	

Krad	0	10	11	50	51	100	101
LL							
Min	5.533	5.324	5.378	4.801	5.225	4.934	5.320
Average	5.817	5.501	5.484	5.086	5.467	5.408	5.538
Max	6.101	5.731	5.686	5.305	5.690	5.871	5.714
UL	12.000	12.000	12.000	12.000	12.000	12.000	12.000

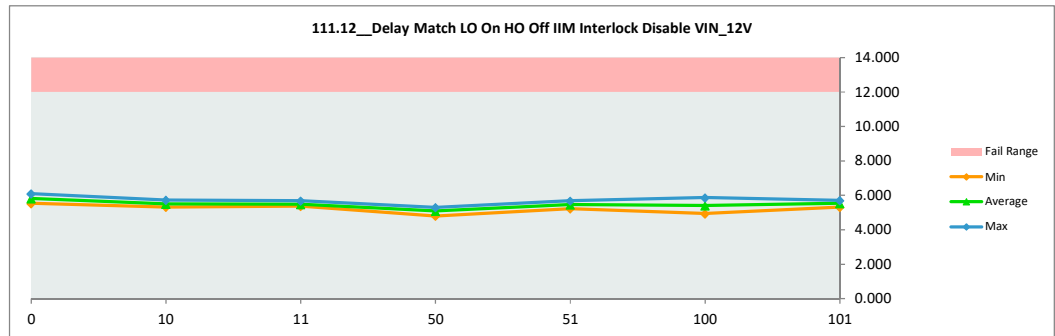

TID "HDR" Report
5962R2220102VXC

111.13 Delay Match LO Off HO		
Test Site	DAL	DAL
Tester	ETS364	ETS364
Test Number	EB672303	EB672303
Unit		
Max Limit	4	4
Min Limit		

Krad	Serial #	Pre_HDR_6013	Post_HDR_6013	Delta
0	1	1.324	1.303	-0.021
0	2	1.159	1.066	-0.092
10	182	1.236	1.256	0.020
10	202	1.670	1.828	0.158
10	204	1.289	1.710	0.421
11	418	1.207	1.298	0.091
11	419	1.244	1.578	0.334
11	443	1.183	1.246	0.063
50	259	1.205	1.231	0.026
50	346	1.587	1.740	0.153
50	347	1.710	1.794	0.084
51	462	1.344	1.564	0.220
51	478	1.158	1.667	0.509
51	503	1.188	1.185	-0.003
100	354	1.119	1.273	0.154
100	363	1.631	2.066	0.435
100	366	0.944	1.242	0.298
100	383	1.132	1.360	0.228
100	417	1.455	1.537	0.081
101	513	1.308	1.709	0.401
101	526	1.369	1.606	0.237
101	532	1.511	1.607	0.096
101	533	1.441	1.776	0.336
101	534	1.266	1.479	0.212
Max		1.710	2.066	0.509
Average		1.320	1.505	0.185
Min		0.944	1.066	-0.092
Std Dev		0.194	0.255	0.161

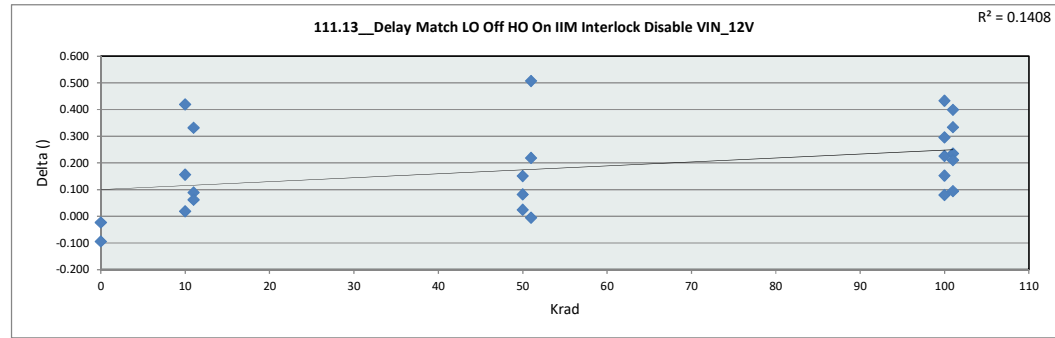

111.13 Delay Match LO Off H	
Test Site	DAL
Tester	ETS364
Test Number	EB672303
Max Limit	4
Min Limit	

	0	10	11	50	51	100	101
LL							
Min	1.066	1.256	1.246	1.231	1.185	1.242	1.479
Average	1.184	1.598	1.374	1.588	1.472	1.495	1.636
Max	1.303	1.828	1.578	1.794	1.667	2.066	1.777
UL	4.000	4.000	4.000	4.000	4.000	4.000	4.000

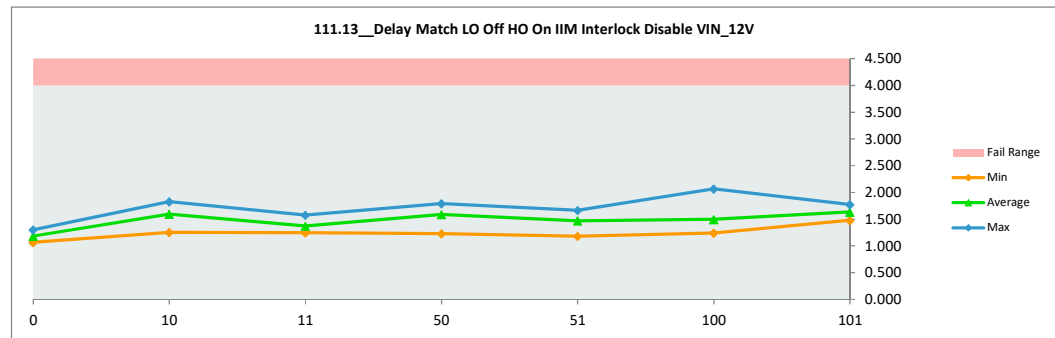

TID "HDR" Report
5962R2220102VXC

112.0 Prop Delay LO Off PWM		
Test Site	DAL	DAL
Tester	ETS364	ETS364
Test Number	EB672303	EB672303
Unit		
Max Limit	48	48
Min Limit	1	1

Krad	Serial #	Pre_HDR_6013	Post_HDR_6013	Delta
0	1	30.318	30.254	-0.064
0	2	30.614	30.437	-0.177
10	182	30.326	30.093	-0.233
10	202	30.266	30.131	-0.135
10	204	29.819	30.110	0.291
11	418	30.256	30.438	0.182
11	419	30.076	30.323	0.247
11	443	30.320	30.122	-0.198
50	259	29.836	29.408	-0.428
50	346	29.980	29.614	-0.367
50	347	30.661	30.393	-0.268
51	462	30.021	30.295	0.274
51	478	30.281	30.096	-0.185
51	503	30.521	30.094	-0.428
100	354	30.236	29.504	-0.732
100	363	30.022	29.452	-0.570
100	366	30.133	29.548	-0.585
100	383	30.164	29.622	-0.542
100	417	30.504	29.831	-0.673
101	513	30.136	29.662	-0.475
101	526	30.799	29.976	-0.823
101	532	30.419	29.746	-0.673
101	533	30.292	29.421	-0.871
101	534	29.949	29.084	-0.865
Max		30.799	30.438	0.291
Average		30.248	29.902	-0.346
Min		29.819	29.084	-0.871
Std Dev		0.253	0.385	0.358

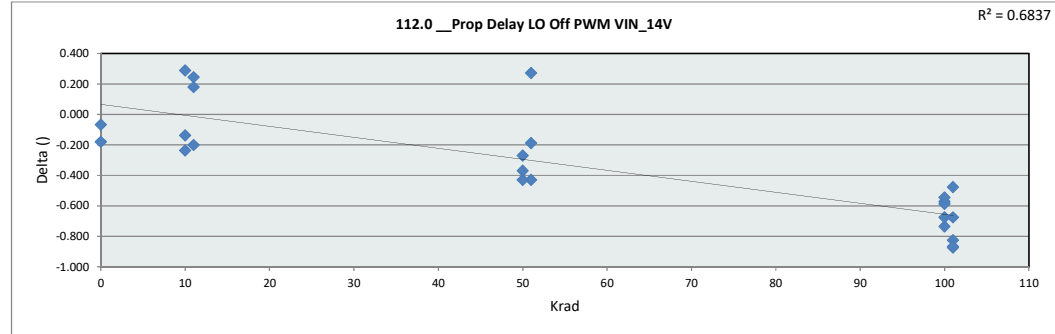

112.0 Prop Delay LO Off PW	
Test Site	DAL
Tester	ETS364
Test Number	EB672303
Max Limit	48
Min Limit	1

Krad	0	10	11	50	51	100	101
LL	1.000	1.000	1.000	1.000	1.000	1.000	1.000
Min	30.254	30.093	30.123	29.408	30.094	29.452	29.084
Average	30.345	30.111	30.295	29.805	30.162	29.591	29.578
Max	30.437	30.131	30.438	30.393	30.295	29.831	29.977
UL	48.000	48.000	48.000	48.000	48.000	48.000	48.000

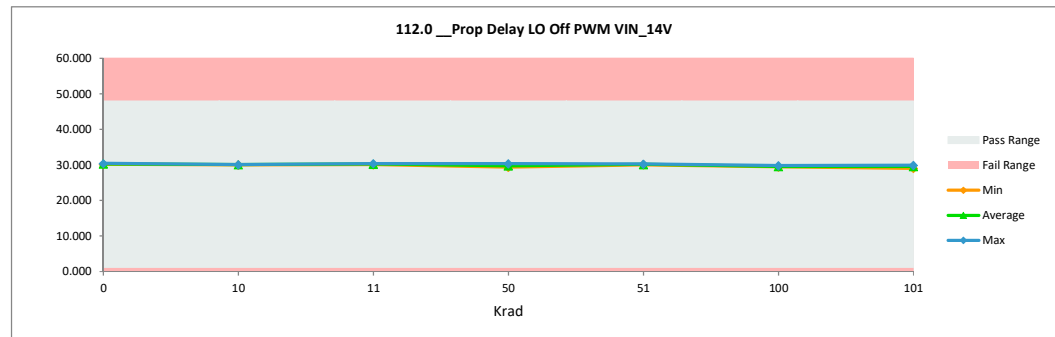

TID "HDR" Report
5962R2220102VXC

112.1 Prop Delay HO Off PWM		
Test Site	DAL	DAL
Tester	ETS364	ETS364
Test Number	EB672303	EB672303
Unit		
Max Limit	50	50
Min Limit	1	1

Krad	Serial #	Pre_HDR_6013	Post_HDR_6013	Delta
0	1	33.103	33.041	-0.062
0	2	33.979	33.851	-0.128
10	182	33.419	33.274	-0.145
10	202	33.073	33.142	0.069
10	204	32.802	32.839	0.037
11	418	33.229	33.350	0.122
11	419	32.974	33.111	0.137
11	443	33.132	33.492	0.360
50	259	32.651	32.356	-0.295
50	346	32.502	32.075	-0.427
50	347	33.351	32.954	-0.396
51	462	33.003	33.332	0.329
51	478	33.386	32.924	-0.462
51	503	33.702	33.415	-0.287
100	354	33.271	32.493	-0.779
100	363	32.615	32.096	-0.519
100	366	33.221	32.586	-0.635
100	383	33.777	32.743	-1.035
100	417	33.218	32.471	-0.747
101	513	33.159	32.620	-0.539
101	526	33.914	33.279	-0.635
101	532	33.395	32.896	-0.499
101	533	33.070	32.405	-0.665
101	534	32.955	32.753	-0.202
Max		33.979	33.851	0.360
Average		33.204	32.896	-0.309
Min		32.502	32.075	-1.035
Std Dev		0.381	0.455	0.367

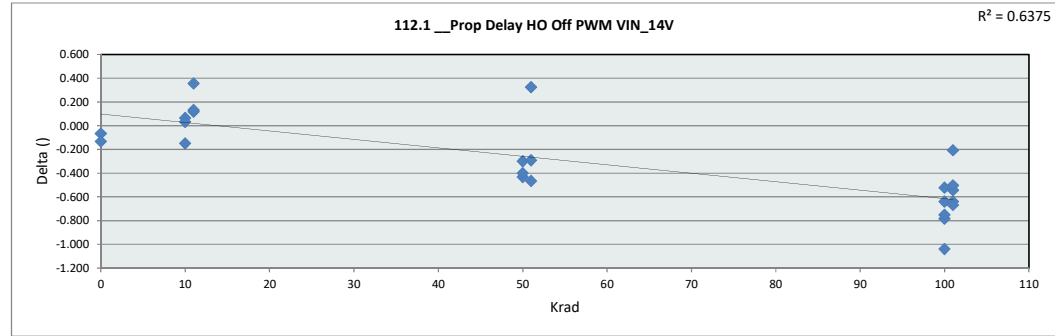

112.1 Prop Delay HO Off PW	
Test Site	DAL
Tester	ETS364
Test Number	EB672303
Max Limit	50
Min Limit	1

Krad	0	10	11	50	51	100	101
LL	1.000	1.000	1.000	1.000	1.000	1.000	1.000
Min	33.041	32.839	33.112	32.075	32.924	32.096	32.406
Average	33.446	33.085	33.318	32.462	33.224	32.478	32.791
Max	33.851	33.274	33.492	32.955	33.415	32.743	33.279
UL	50.000	50.000	50.000	50.000	50.000	50.000	50.000

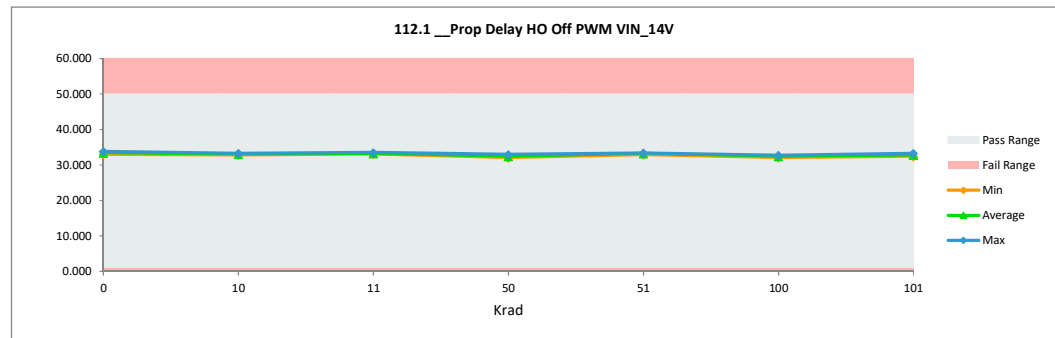

TID "HDR" Report
5962R2220102VXC

112.2 __Prop Delay LO On IIM Interlock VIN_14V		
Test Site	DAL	DAL
Tester	ETS364	ETS364
Test Number	EB672303	EB672303
Unit		
Max Limit	38	38
Min Limit	1	1

Krad	Serial #	Pre_HDR_6013	Post_HDR_6013	Delta
0	1	23.240	23.038	-0.202
0	2	23.335	23.197	-0.138
10	182	23.157	22.947	-0.210
10	202	23.147	23.140	-0.008
10	204	22.904	23.119	0.215
11	418	23.141	23.380	0.239
11	419	23.068	23.263	0.195
11	443	23.033	23.136	0.103
50	259	23.087	22.839	-0.248
50	346	23.163	22.941	-0.222
50	347	23.271	23.029	-0.241
51	462	23.142	23.202	0.060
51	478	23.143	23.042	-0.102
51	503	23.464	23.129	-0.335
100	354	23.207	22.868	-0.339
100	363	23.042	22.867	-0.174
100	366	23.093	22.806	-0.287
100	383	23.208	22.655	-0.553
100	417	23.240	23.008	-0.232
101	513	23.120	22.879	-0.241
101	526	23.485	23.076	-0.409
101	532	23.401	22.998	-0.403
101	533	22.989	22.766	-0.223
101	534	23.098	22.770	-0.328
Max		23.485	23.380	0.239
Average		23.174	23.004	-0.170
Min		22.904	22.655	-0.553
Std Dev		0.142	0.177	0.207

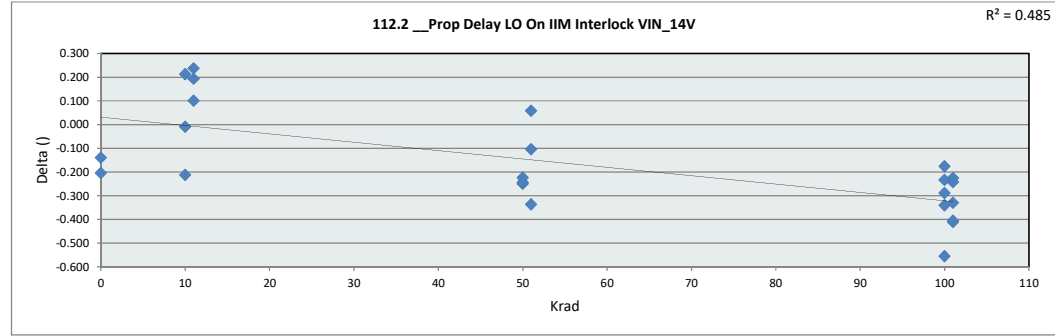

112.2 __Prop Delay LO On IIM	
Test Site	DAL
Tester	ETS364
Test Number	EB672303
Max Limit	38
Min Limit	1

Krad	0	10	11	50	51	100	101
LL	1.000	1.000	1.000	1.000	1.000	1.000	1.000
Min	23.038	22.947	23.136	22.839	23.042	22.655	22.766
Average	23.117	23.068	23.260	22.936	23.124	22.841	22.898
Max	23.197	23.140	23.380	23.030	23.202	23.009	23.076
UL	38.000	38.000	38.000	38.000	38.000	38.000	38.000

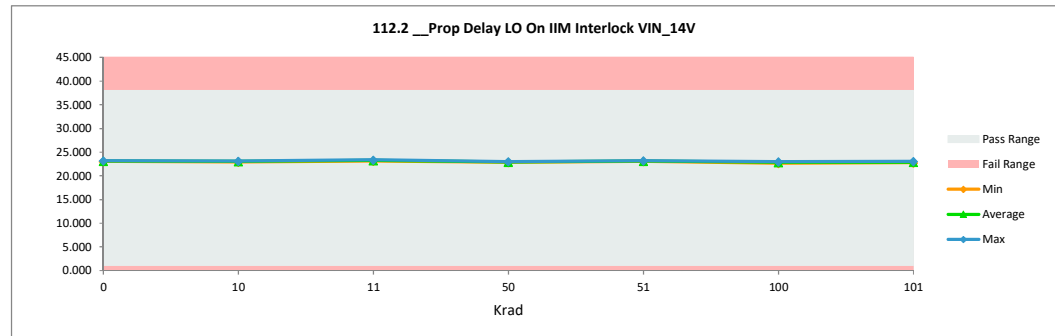

TID "HDR" Report
5962R2220102VXC

112.3 Prop Delay LO Off IIM I		
Test Site	DAL	DAL
Tester	ETS364	ETS364
Test Number	EB672303	EB672303
Unit		
Max Limit	38	38
Min Limit	1	1

Krad	Serial #	Pre_HDR_6013	Post_HDR_6013	Delta
0	1	27.561	27.433	-0.128
0	2	27.614	27.496	-0.119
10	182	27.355	27.152	-0.203
10	202	27.470	27.489	0.019
10	204	26.976	27.434	0.458
11	418	27.294	27.631	0.337
11	419	27.142	27.545	0.403
11	443	27.076	27.243	0.167
50	259	27.209	26.906	-0.303
50	346	27.207	26.966	-0.241
50	347	27.653	27.443	-0.210
51	462	27.097	27.318	0.221
51	478	27.207	27.271	0.064
51	503	27.717	27.529	-0.188
100	354	27.238	26.902	-0.336
100	363	27.249	27.152	-0.097
100	366	27.386	27.003	-0.383
100	383	27.442	27.068	-0.374
100	417	27.460	27.383	-0.076
101	513	27.328	27.225	-0.103
101	526	27.906	27.415	-0.491
101	532	27.638	27.324	-0.314
101	533	27.263	26.977	-0.285
101	534	27.255	27.059	-0.196
Max		27.906	27.631	0.458
Average		27.364	27.265	-0.099
Min		26.976	26.902	-0.491
Std Dev		0.228	0.221	0.257

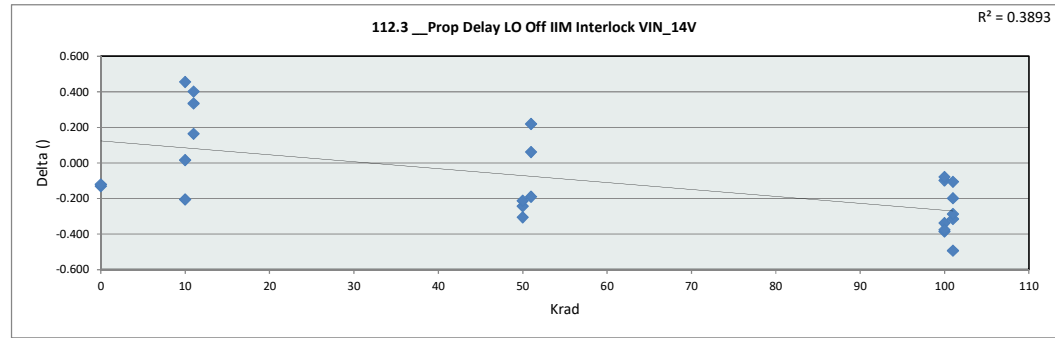

112.3 Prop Delay LO Off IIM	
Test Site	DAL
Tester	ETS364
Test Number	EB672303
Max Limit	38
Min Limit	1

Krad	0	10	11	50	51	100	101
LL	1.000	1.000	1.000	1.000	1.000	1.000	1.000
Min	27.433	27.152	27.243	26.906	27.271	26.902	26.977
Average	27.464	27.358	27.473	27.105	27.373	27.102	27.200
Max	27.496	27.489	27.631	27.443	27.529	27.383	27.415
UL	38.000	38.000	38.000	38.000	38.000	38.000	38.000

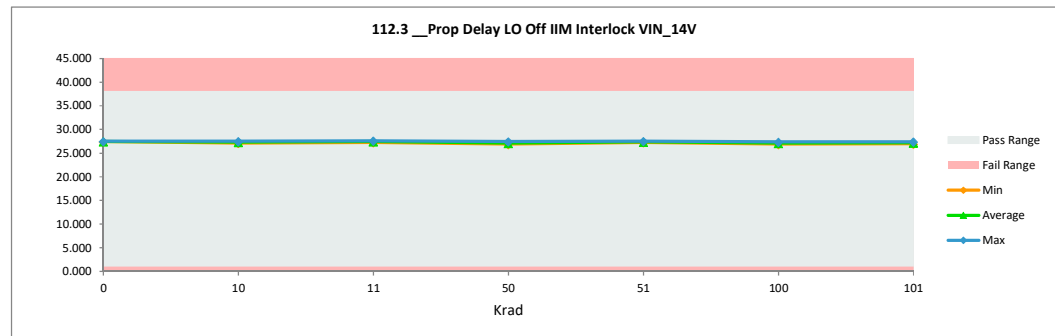

TID "HDR" Report
5962R2220102VXC

112.4 Prop Delay HO On IIM I		
Test Site	DAL	DAL
Tester	ETS364	ETS364
Test Number	EB672303	EB672303
Unit		
Max Limit	40	40
Min Limit	1	1

Krad	Serial #	Pre_HDR_6013	Post_HDR_6013	Delta
0	1	26.119	25.984	-0.134
0	2	26.453	26.367	-0.086
10	182	26.086	25.905	-0.181
10	202	25.697	25.673	-0.024
10	204	25.702	25.698	-0.004
11	418	26.199	26.200	0.001
11	419	25.845	26.025	0.181
11	443	25.893	26.135	0.242
50	259	25.892	25.758	-0.133
50	346	25.542	25.185	-0.358
50	347	25.987	25.672	-0.314
51	462	25.774	25.929	0.155
51	478	26.032	25.612	-0.420
51	503	26.382	26.169	-0.212
100	354	26.124	25.582	-0.542
100	363	25.697	25.168	-0.530
100	366	26.262	25.794	-0.468
100	383	26.379	25.611	-0.768
100	417	25.959	25.654	-0.305
101	513	25.987	25.552	-0.435
101	526	26.577	25.875	-0.702
101	532	26.148	25.704	-0.444
101	533	25.698	25.136	-0.562
101	534	25.924	25.656	-0.268
Max		26.577	26.367	0.242
Average		26.015	25.752	-0.263
Min		25.542	25.136	-0.768
Std Dev		0.269	0.315	0.274

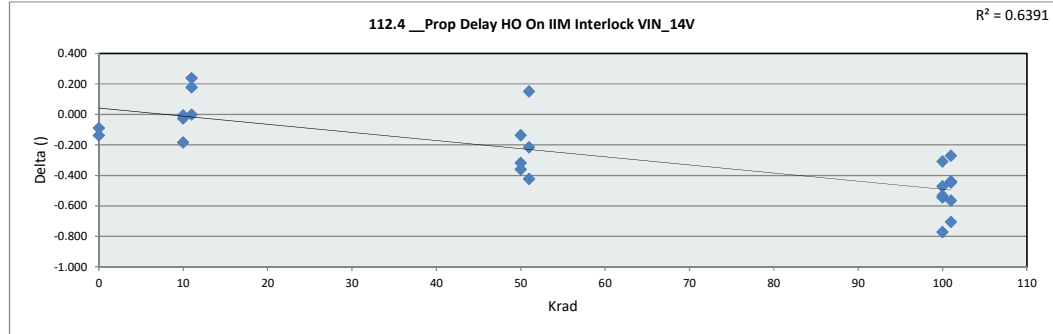

112.4 Prop Delay HO On IIM	
Test Site	DAL
Tester	ETS364
Test Number	EB672303
Max Limit	40
Min Limit	1

Krad	0	10	11	50	51	100	101
LL	1.000	1.000	1.000	1.000	1.000	1.000	1.000
Min	25.984	25.673	26.025	25.185	25.612	25.168	25.137
Average	26.176	25.759	26.120	25.538	25.903	25.562	25.585
Max	26.367	25.905	26.200	25.758	26.169	25.794	25.875
UL	40.000	40.000	40.000	40.000	40.000	40.000	40.000

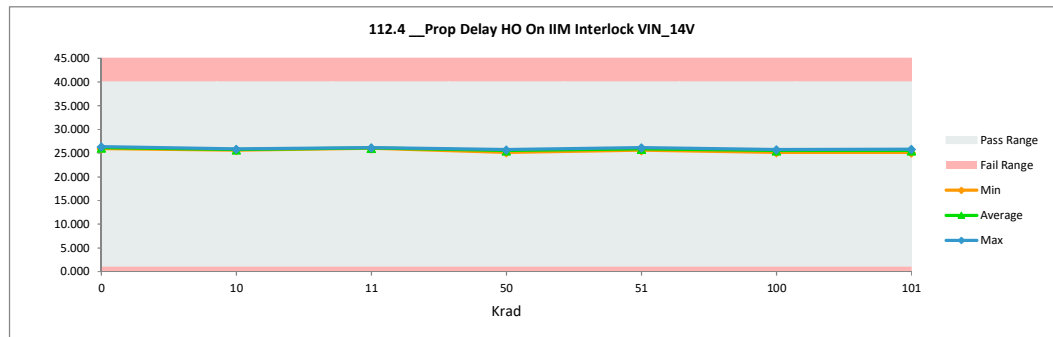

TID "HDR" Report
5962R2220102VXC

112.5 Prop Delay HO Off IIM I		
Test Site	DAL	DAL
Tester	ETS364	ETS364
Test Number	EB672303	EB672303
Unit		
Max Limit	40	40
Min Limit	1	1

Krad	Serial #	Pre_HDR_6013	Post_HDR_6013	Delta
0	1	28.224	28.074	-0.150
0	2	28.838	28.653	-0.185
10	182	28.285	28.150	-0.134
10	202	28.040	27.986	-0.053
10	204	27.862	27.740	-0.122
11	418	28.217	28.274	0.057
11	419	27.914	28.036	0.122
11	443	27.927	28.255	0.327
50	259	27.749	27.618	-0.130
50	346	27.486	27.155	-0.331
50	347	27.982	27.773	-0.208
51	462	27.964	28.049	0.085
51	478	28.250	27.874	-0.376
51	503	28.584	28.375	-0.209
100	354	28.169	27.708	-0.461
100	363	27.758	27.413	-0.345
100	366	28.218	27.769	-0.449
100	383	28.926	27.964	-0.962
100	417	28.020	27.746	-0.274
101	513	28.075	27.812	-0.263
101	526	28.593	28.261	-0.333
101	532	28.261	27.972	-0.289
101	533	27.785	27.327	-0.458
101	534	28.101	27.946	-0.155
Max		28.926	28.653	0.327
Average		28.135	27.914	-0.221
Min		27.486	27.155	-0.962
Std Dev		0.342	0.340	0.250

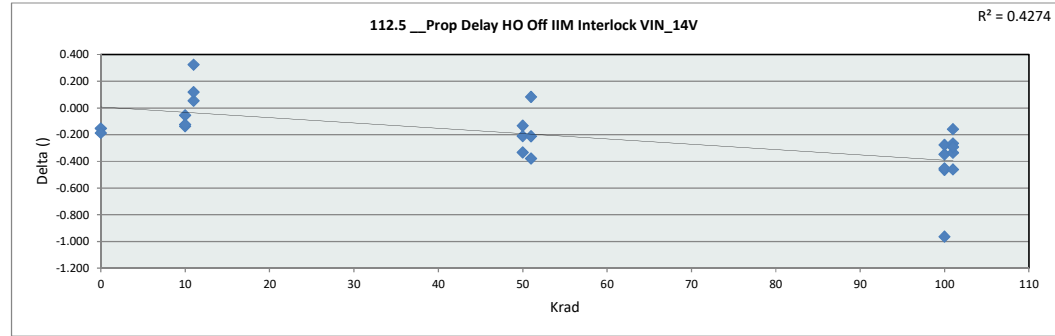

112.5 Prop Delay HO Off IIM	
Test Site	DAL
Tester	ETS364
Test Number	EB672303
Max Limit	40
Min Limit	1

Krad	0	10	11	50	51	100	101
LL	1.000	1.000	1.000	1.000	1.000	1.000	1.000
Min	28.074	27.740	28.036	27.155	27.874	27.413	27.327
Average	28.364	27.959	28.188	27.516	28.099	27.720	27.864
Max	28.654	28.150	28.274	27.773	28.375	27.964	28.261
UL	40.000	40.000	40.000	40.000	40.000	40.000	40.000

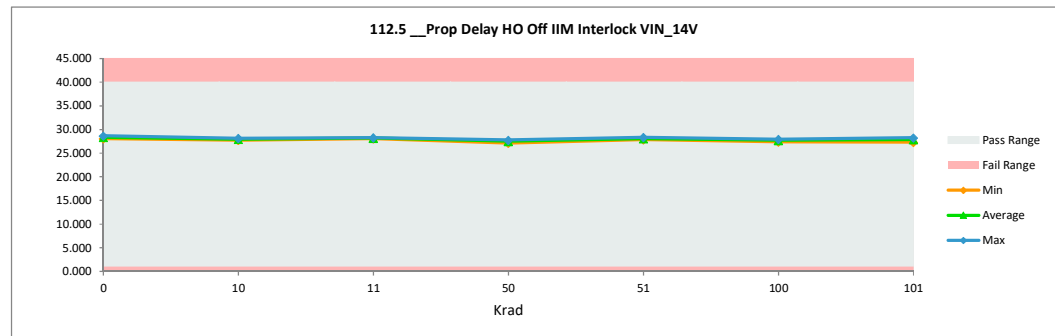

TID "HDR" Report
5962R2220102VXC

112.6 Prop Delay LO On IIM Interlock Disable VIN_14V		
Test Site	DAL	DAL
Tester	ETS364	ETS364
Test Number	EB672303	EB672303
Unit		
Max Limit	38	38
Min Limit	1	1

Krad	Serial #	Pre_HDR_6013	Post_HDR_6013	Delta
0	1	23.178	23.041	-0.137
0	2	23.307	23.191	-0.117
10	182	23.126	23.062	-0.064
10	202	23.095	23.091	-0.004
10	204	22.850	23.096	0.247
11	418	23.066	23.365	0.299
11	419	23.085	23.234	0.149
11	443	23.040	23.089	0.049
50	259	23.067	22.801	-0.267
50	346	23.013	22.841	-0.172
50	347	23.278	23.030	-0.248
51	462	23.124	23.180	0.056
51	478	23.095	23.112	0.016
51	503	23.413	23.178	-0.234
100	354	23.197	22.875	-0.321
100	363	23.018	22.951	-0.067
100	366	23.000	22.798	-0.202
100	383	23.157	22.711	-0.446
100	417	23.271	22.975	-0.296
101	513	23.123	22.928	-0.195
101	526	23.436	23.084	-0.352
101	532	23.279	22.976	-0.302
101	533	22.987	22.685	-0.302
101	534	22.996	22.656	-0.340
Max		23.436	23.365	0.299
Average		23.133	22.998	-0.136
Min		22.850	22.656	-0.446
Std Dev		0.141	0.183	0.196

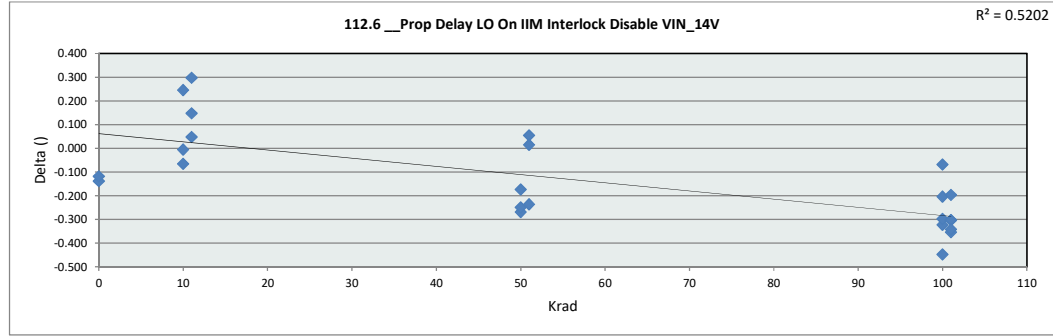

112.6 Prop Delay LO On IIM	
Test Site	DAL
Tester	ETS364
Test Number	EB672303
Max Limit	38
Min Limit	1

Krad	0	10	11	50	51	100	101
LL	1.000	1.000	1.000	1.000	1.000	1.000	1.000
Min	23.041	23.062	23.089	22.801	23.112	22.711	22.656
Average	23.116	23.083	23.230	22.890	23.157	22.862	22.866
Max	23.191	23.096	23.365	23.030	23.180	22.975	23.084
UL	38.000	38.000	38.000	38.000	38.000	38.000	38.000

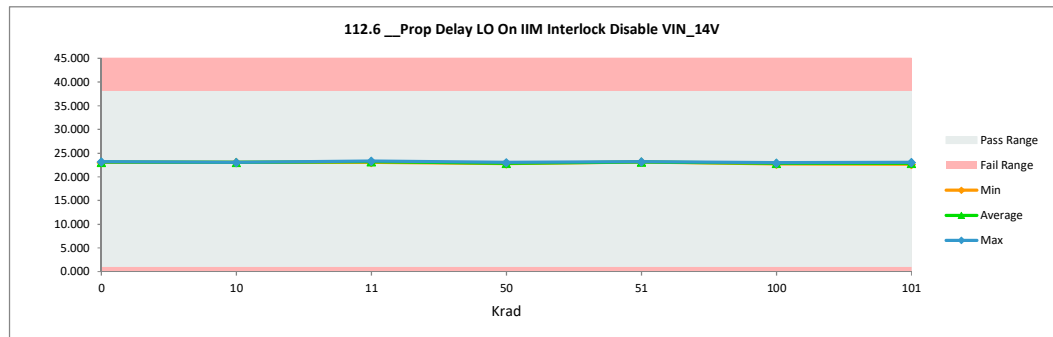

TID "HDR" Report
5962R2220102VXC

112.7 Prop Delay LO Off IIM I		
Test Site	DAL	DAL
Tester	ETS364	ETS364
Test Number	EB672303	EB672303
Unit		
Max Limit	38	38
Min Limit	1	1

Krad	Serial #	Pre_HDR_6013	Post_HDR_6013	Delta
0	1	27.431	27.332	-0.099
0	2	27.533	27.427	-0.106
10	182	27.290	27.065	-0.226
10	202	27.304	27.265	-0.039
10	204	26.871	27.232	0.361
11	418	27.192	27.378	0.186
11	419	26.947	27.378	0.431
11	443	27.029	27.137	0.108
50	259	27.088	26.946	-0.142
50	346	26.990	26.914	-0.076
50	347	27.593	27.403	-0.190
51	462	26.930	27.177	0.247
51	478	27.128	27.146	0.017
51	503	27.523	27.312	-0.211
100	354	27.084	26.870	-0.214
100	363	27.063	27.027	-0.037
100	366	27.189	26.971	-0.218
100	383	27.271	26.925	-0.347
100	417	27.262	27.124	-0.139
101	513	27.267	27.103	-0.164
101	526	27.792	27.436	-0.356
101	532	27.427	27.174	-0.252
101	533	27.041	26.868	-0.172
101	534	27.104	26.909	-0.195
Max		27.792	27.436	0.431
Average		27.223	27.147	-0.076
Min		26.871	26.868	-0.356
Std Dev		0.233	0.190	0.207

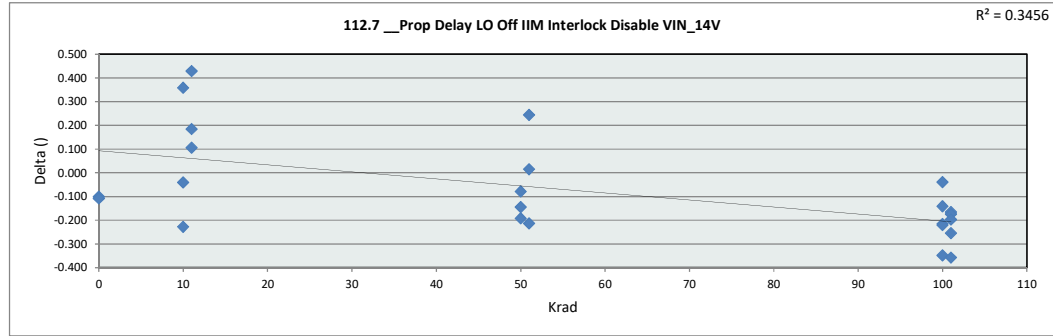

112.7 Prop Delay LO Off IIM	
Test Site	DAL
Tester	ETS364
Test Number	EB672303
Max Limit	38
Min Limit	1

Krad	0	10	11	50	51	100	101
LL	1.000	1.000	1.000	1.000	1.000	1.000	1.000
Min	27.332	27.065	27.137	26.914	27.146	26.870	26.869
Average	27.380	27.187	27.298	27.087	27.211	26.983	27.098
Max	27.427	27.265	27.378	27.403	27.312	27.124	27.436
UL	38.000	38.000	38.000	38.000	38.000	38.000	38.000

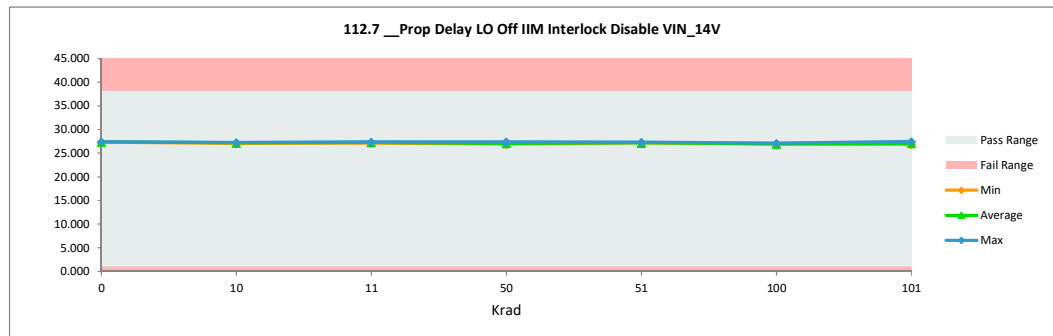

TID "HDR" Report
5962R2220102VXC

112.8 Prop Delay HO On IIM I		
Test Site	DAL	DAL
Tester	ETS364	ETS364
Test Number	EB672303	EB672303
Unit		
Max Limit	40	40
Min Limit	1	1

Krad	Serial #	Pre_HDR_6013	Post_HDR_6013	Delta
0	1	25.955	25.911	-0.044
0	2	26.268	26.287	0.018
10	182	26.017	25.838	-0.179
10	202	25.609	25.617	0.008
10	204	25.591	25.643	0.052
11	418	26.063	26.025	-0.038
11	419	25.666	25.828	0.162
11	443	25.919	26.015	0.097
50	259	25.895	25.604	-0.291
50	346	25.350	25.139	-0.210
50	347	25.821	25.586	-0.235
51	462	25.580	25.824	0.244
51	478	25.916	25.488	-0.428
51	503	26.260	26.081	-0.179
100	354	25.934	25.469	-0.465
100	363	25.539	25.049	-0.490
100	366	26.167	25.671	-0.496
100	383	26.261	25.427	-0.833
100	417	25.821	25.585	-0.236
101	513	25.905	25.412	-0.493
101	526	26.367	25.781	-0.586
101	532	26.076	25.637	-0.439
101	533	25.632	25.053	-0.579
101	534	25.864	25.594	-0.271
Max		26.367	26.287	0.244
Average		25.895	25.649	-0.246
Min		25.350	25.049	-0.833
Std Dev		0.265	0.310	0.273

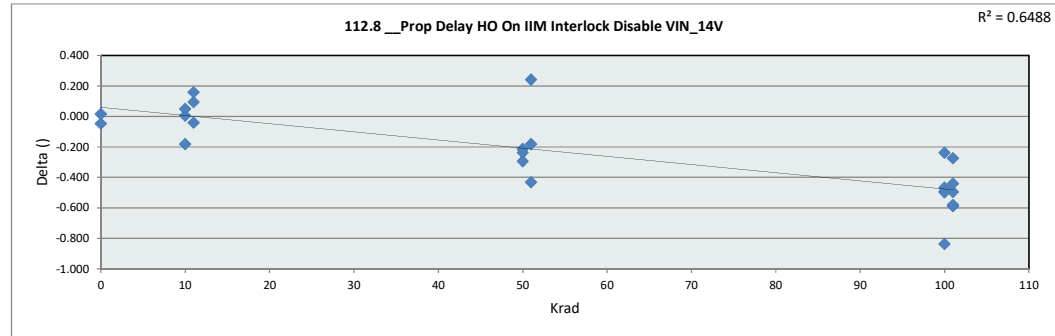

112.8 Prop Delay HO On IIM I	
Test Site	DAL
Tester	ETS364
Test Number	EB672303
Max Limit	40
Min Limit	1

Krad	0	10	11	50	51	100	101
LL	1.000	1.000	1.000	1.000	1.000	1.000	1.000
Min	25.911	25.617	25.828	25.139	25.488	25.049	25.053
Average	26.099	25.699	25.956	25.443	25.798	25.440	25.495
Max	26.287	25.838	26.025	25.604	26.081	25.671	25.781
UL	40.000	40.000	40.000	40.000	40.000	40.000	40.000

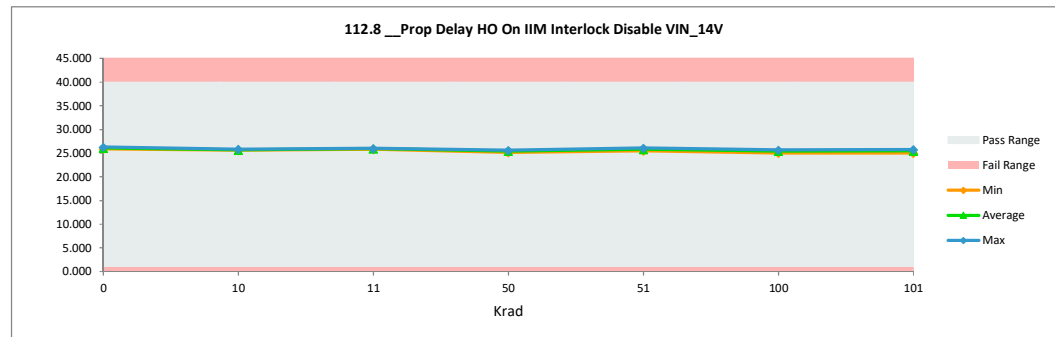

TID "HDR" Report
5962R2220102VXC

112.9 Prop Delay HO Off IIM I		
Test Site	DAL	DAL
Tester	ETS364	ETS364
Test Number	EB672303	EB672303
Unit		
Max Limit	40	40
Min Limit	1	1

Krad	Serial #	Pre_HDR_6013	Post_HDR_6013	Delta
0	1	28.718	28.577	-0.141
0	2	29.437	29.285	-0.153
10	182	28.822	28.675	-0.147
10	202	28.614	28.531	-0.083
10	204	28.403	28.365	-0.038
11	418	28.721	28.831	0.111
11	419	28.488	28.573	0.085
11	443	28.443	28.813	0.370
50	259	28.323	28.128	-0.195
50	346	28.010	27.717	-0.293
50	347	28.448	28.296	-0.152
51	462	28.505	28.564	0.059
51	478	28.807	28.360	-0.448
51	503	28.958	28.843	-0.115
100	354	28.676	28.163	-0.514
100	363	28.255	27.811	-0.443
100	366	28.672	28.320	-0.352
100	383	29.416	28.515	-0.900
100	417	28.529	28.219	-0.310
101	513	28.634	28.273	-0.360
101	526	29.150	28.751	-0.399
101	532	28.787	28.499	-0.287
101	533	28.320	27.821	-0.498
101	534	28.638	28.425	-0.213
	Max	29.437	29.285	0.370
	Average	28.657	28.432	-0.226
	Min	28.010	27.717	-0.900
	Std Dev	0.338	0.360	0.258

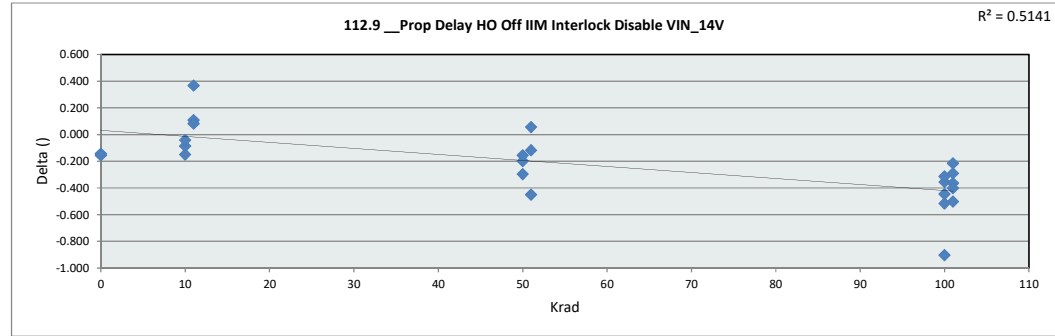

112.9 Prop Delay HO Off IIM I	
Test Site	DAL
Tester	ETS364
Test Number	EB672303
Max Limit	40
Min Limit	1

Krad	0	10	11	50	51	100	101
LL	1.000	1.000	1.000	1.000	1.000	1.000	1.000
Min	28.577	28.365	28.574	27.717	28.360	27.811	27.821
Average	28.931	28.524	28.739	28.047	28.589	28.206	28.354
Max	29.285	28.675	28.831	28.296	28.843	28.516	28.751
UL	40.000	40.000	40.000	40.000	40.000	40.000	40.000

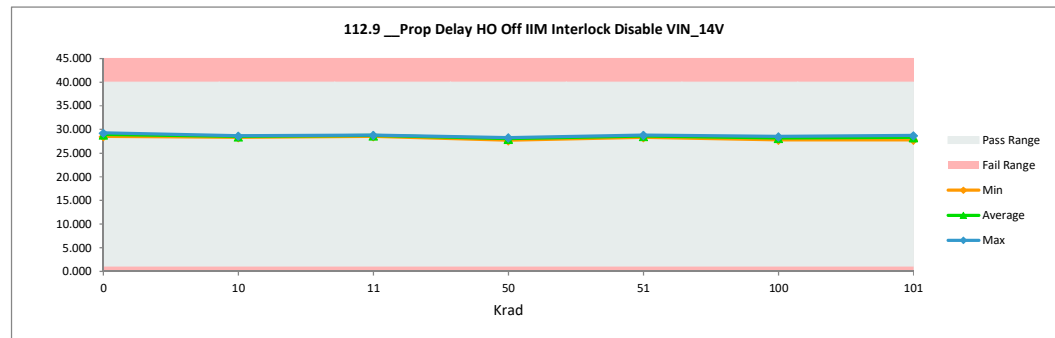

TID "HDR" Report
5962R2220102VXC

112.10 Delay Match LO On HO		
Test Site	DAL	DAL
Tester	ETS364	ETS364
Test Number	EB672303	EB672303
Unit		
Max Limit	12	12
Min Limit		

Krad	Serial #	Pre_HDR_6013	Post_HDR_6013	Delta
0	1	4.984	5.037	0.053
0	2	5.504	5.457	-0.047
10	182	5.128	5.204	0.076
10	202	4.892	4.847	-0.046
10	204	4.958	4.621	-0.336
11	418	5.076	4.894	-0.182
11	419	4.847	4.773	-0.073
11	443	4.894	5.119	0.224
50	259	4.662	4.779	0.118
50	346	4.323	4.215	-0.109
50	347	4.711	4.744	0.033
51	462	4.822	4.847	0.026
51	478	5.107	4.832	-0.274
51	503	5.120	5.246	0.126
100	354	4.963	4.840	-0.122
100	363	4.716	4.546	-0.170
100	366	5.124	4.962	-0.162
100	383	5.718	5.309	-0.409
100	417	4.780	4.737	-0.043
101	513	4.955	4.933	-0.022
101	526	5.108	5.184	0.076
101	532	4.860	4.974	0.114
101	533	4.796	4.562	-0.235
101	534	5.003	5.176	0.172
Max		5.718	5.457	0.224
Average		4.960	4.910	-0.051
Min		4.323	4.215	-0.409
Std Dev		0.275	0.280	0.164

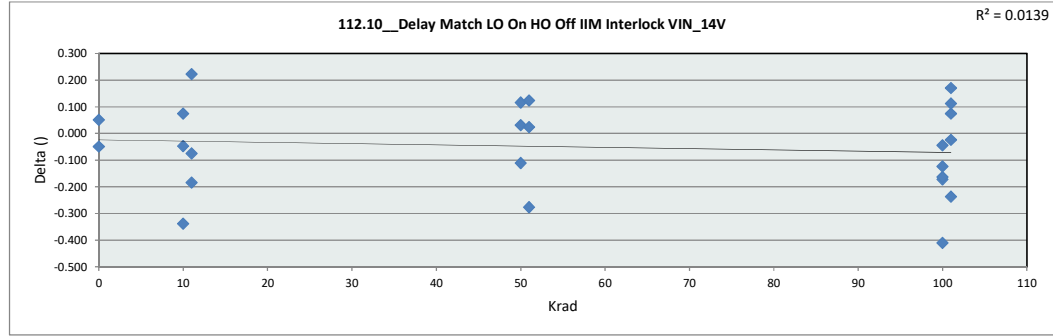

112.10 Delay Match LO On H	
Test Site	DAL
Tester	ETS364
Test Number	EB672303
Max Limit	12
Min Limit	

	0	10	11	50	51	100	101
LL							
Min	5.037	4.621	4.774	4.215	4.832	4.546	4.562
Average	5.247	4.891	4.929	4.579	4.975	4.879	4.966
Max	5.457	5.204	5.119	4.779	5.246	5.309	5.184
UL	12.000	12.000	12.000	12.000	12.000	12.000	12.000

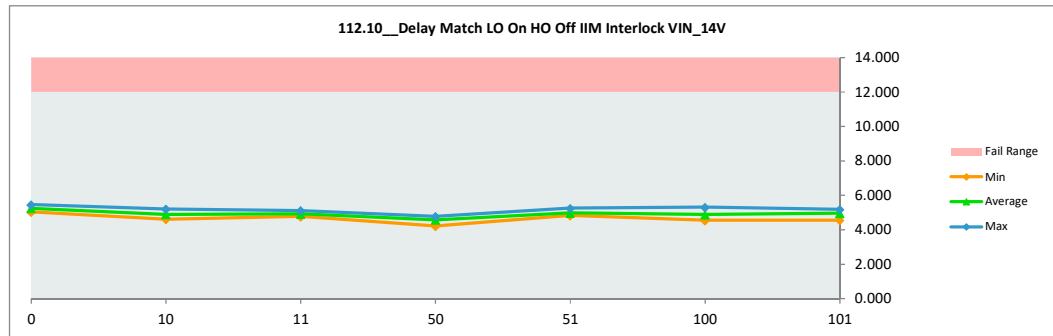

TID "HDR" Report
5962R2220102VXC

112.11 Delay Match LO Off HO		
Test Site	DAL	DAL
Tester	ETS364	ETS364
Test Number	EB672303	EB672303
Unit		
Max Limit	4	4
Min Limit		

Krad	Serial #	Pre_HDR_6013	Post_HDR_6013	Delta
0	1	1.443	1.448	0.006
0	2	1.162	1.129	-0.033
10	182	1.269	1.247	-0.022
10	202	1.773	1.815	0.042
10	204	1.274	1.735	0.461
11	418	1.095	1.430	0.335
11	419	1.297	1.520	0.223
11	443	1.183	1.108	-0.075
50	259	1.318	1.148	-0.170
50	346	1.665	1.781	0.117
50	347	1.667	1.771	0.104
51	462	1.322	1.389	0.067
51	478	1.174	1.658	0.484
51	503	1.335	1.360	0.025
100	354	1.114	1.320	0.206
100	363	1.552	1.985	0.433
100	366	1.124	1.209	0.085
100	383	1.063	1.457	0.394
100	417	1.501	1.730	0.229
101	513	1.341	1.673	0.332
101	526	1.329	1.540	0.211
101	532	1.490	1.620	0.130
101	533	1.564	1.841	0.276
101	534	1.331	1.403	0.072
Max		1.773	1.985	0.484
Average		1.349	1.513	0.164
Min		1.063	1.108	-0.170
Std Dev		0.196	0.249	0.178

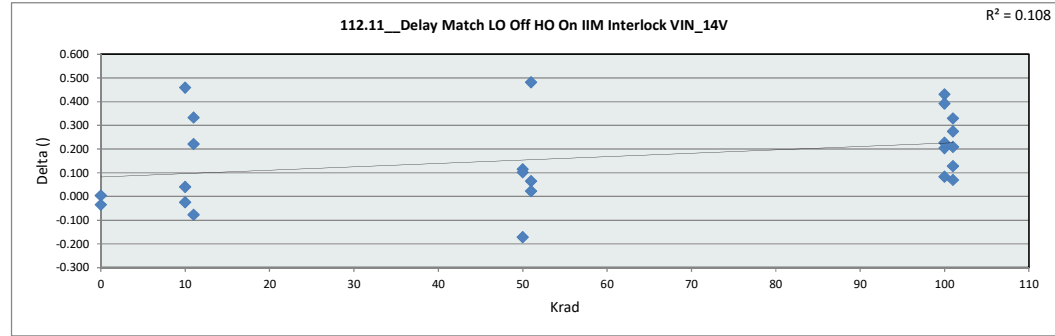

112.11 Delay Match LO Off H	
Test Site	DAL
Tester	ETS364
Test Number	EB672303
Max Limit	4
Min Limit	

Krad	0	10	11	50	51	100	101
LL							
Min	1.129	1.247	1.108	1.148	1.360	1.209	1.403
Average	1.289	1.599	1.353	1.567	1.469	1.540	1.615
Max	1.448	1.815	1.520	1.781	1.659	1.985	1.841
UL	4.000	4.000	4.000	4.000	4.000	4.000	4.000

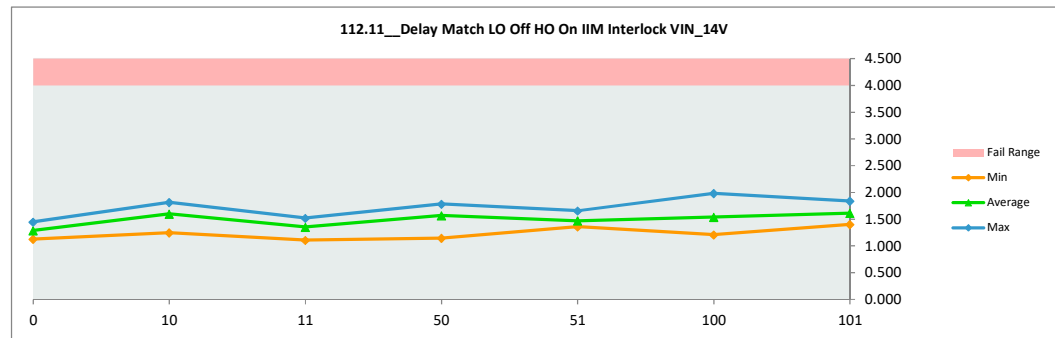

TID "HDR" Report
5962R2220102VXC

112.12 Delay Match LO On HO		
Test Site	DAL	DAL
Tester	ETS364	ETS364
Test Number	EB672303	EB672303
Unit		
Max Limit	12	12
Min Limit		

Krad	Serial #	Pre_HDR_6013	Post_HDR_6013	Delta
0	1	5.540	5.536	-0.004
0	2	6.130	6.094	-0.036
10	182	5.696	5.614	-0.082
10	202	5.519	5.439	-0.079
10	204	5.553	5.268	-0.285
11	418	5.654	5.466	-0.188
11	419	5.403	5.340	-0.063
11	443	5.403	5.724	0.321
50	259	5.256	5.328	0.072
50	346	4.997	4.876	-0.121
50	347	5.170	5.266	0.096
51	462	5.380	5.384	0.004
51	478	5.712	5.248	-0.464
51	503	5.545	5.665	0.120
100	354	5.480	5.287	-0.193
100	363	5.237	4.861	-0.376
100	366	5.672	5.522	-0.150
100	383	6.258	5.805	-0.454
100	417	5.258	5.244	-0.014
101	513	5.511	5.345	-0.165
101	526	5.714	5.668	-0.047
101	532	5.508	5.523	0.015
101	533	5.333	5.136	-0.197
101	534	5.642	5.769	0.127
Max		6.258	6.094	0.321
Average		5.524	5.434	-0.090
Min		4.997	4.861	-0.464
Std Dev		0.278	0.283	0.186

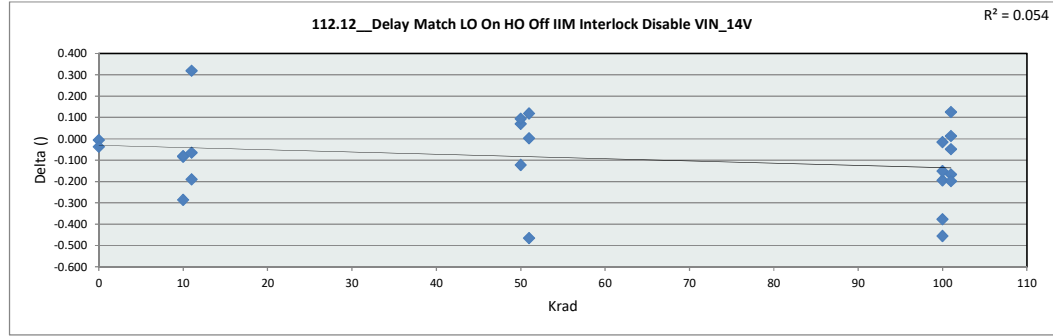

112.12 Delay Match LO On H	
Test Site	DAL
Tester	ETS364
Test Number	EB672303
Max Limit	12
Min Limit	

	0	10	11	50	51	100	101
LL							
Min	5.536	5.268	5.340	4.876	5.248	4.861	5.136
Average	5.815	5.441	5.510	5.157	5.432	5.344	5.488
Max	6.094	5.614	5.724	5.328	5.665	5.805	5.769
UL	12.000	12.000	12.000	12.000	12.000	12.000	12.000

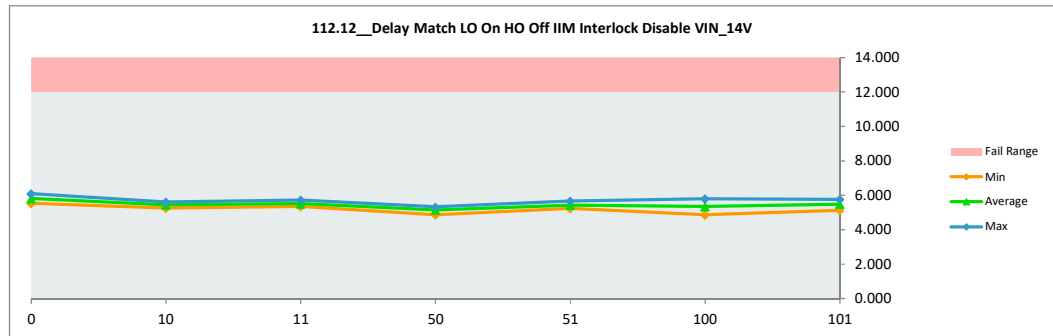

TID "HDR" Report
5962R2220102VXC

112.13 Delay Match LO Off HO		
Test Site	DAL	DAL
Tester	ETS364	ETS364
Test Number	EB672303	EB672303
Unit		
Max Limit	4	4
Min Limit		

Krad	Serial #	Pre_HDR_6013	Post_HDR_6013	Delta
0	1	1.476	1.422	-0.054
0	2	1.265	1.140	-0.125
10	182	1.273	1.227	-0.046
10	202	1.694	1.648	-0.047
10	204	1.280	1.589	0.309
11	418	1.129	1.354	0.224
11	419	1.281	1.550	0.270
11	443	1.110	1.121	0.011
50	259	1.193	1.342	0.149
50	346	1.640	1.774	0.134
50	347	1.772	1.816	0.045
51	462	1.350	1.353	0.002
51	478	1.212	1.658	0.445
51	503	1.262	1.230	-0.032
100	354	1.150	1.401	0.251
100	363	1.524	1.978	0.454
100	366	1.022	1.299	0.277
100	383	1.010	1.497	0.487
100	417	1.441	1.538	0.097
101	513	1.362	1.691	0.329
101	526	1.425	1.655	0.230
101	532	1.350	1.537	0.186
101	533	1.409	1.816	0.406
101	534	1.240	1.316	0.076
Max		1.772	1.978	0.487
Average		1.328	1.498	0.170
Min		1.010	1.121	-0.125
Std Dev		0.197	0.229	0.180

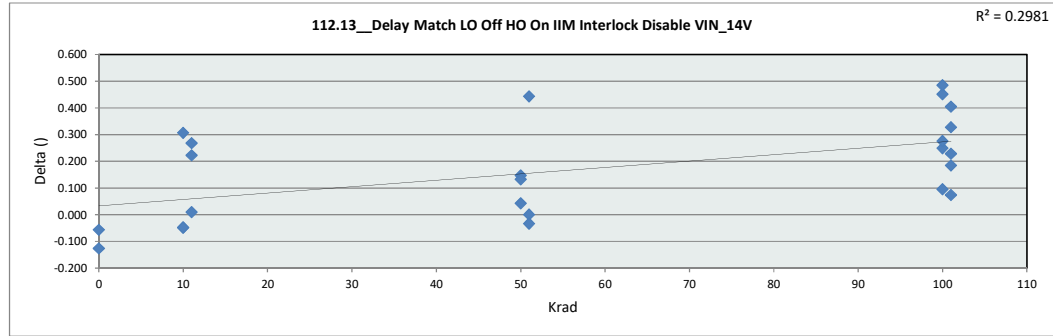

112.13 Delay Match LO Off H	
Test Site	DAL
Tester	ETS364
Test Number	EB672303
Max Limit	4
Min Limit	

Krad	0	10	11	50	51	100	101
LL							
Min	1.140	1.227	1.121	1.342	1.230	1.299	1.316
Average	1.281	1.488	1.342	1.644	1.414	1.543	1.603
Max	1.422	1.648	1.550	1.817	1.658	1.978	1.816
UL	4.000	4.000	4.000	4.000	4.000	4.000	4.000

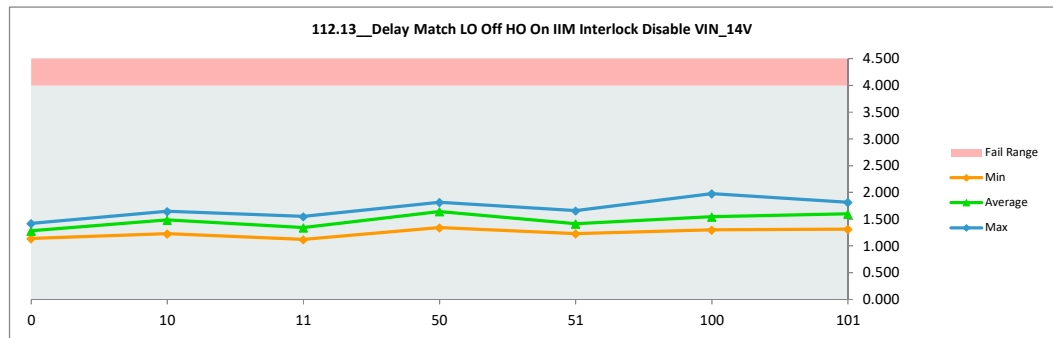

TID "HDR" Report 5962R2220102VXC

115.0 Rise Time HO VIN_10V		
Test Site	DAL	DAL
Tester	ETS364	ETS364
Test Number	EB672303	EB672303
Unit		
Max Limit	7.5	7.5
Min Limit	1	1

Krad	Serial #	Pre_HDR_6013	Post_HDR_6013	Delta
0	1	3.598	3.623	0.025
0	2	3.595	3.623	0.028
10	182	3.617	3.617	0.000
10	202	3.606	3.612	0.006
10	204	3.632	3.600	-0.032
11	418	3.640	3.625	-0.015
11	419	3.627	3.620	-0.007
11	443	3.617	3.635	0.018
50	259	3.623	3.621	-0.003
50	346	3.602	3.625	0.023
50	347	3.601	3.608	0.007
51	462	3.625	3.626	0.001
51	478	3.635	3.628	-0.007
51	503	3.598	3.617	0.019
100	354	3.608	3.624	0.017
100	363	3.628	3.619	-0.008
100	366	3.622	3.629	0.007
100	383	3.641	3.625	-0.015
100	417	3.639	3.626	-0.013
101	513	3.593	3.627	0.034
101	526	3.597	3.611	0.014
101	532	3.592	3.622	0.030
101	533	3.608	3.622	0.014
101	534	3.624	3.631	0.007
Max		3.641	3.635	0.034
Average		3.615	3.622	0.006
Min		3.592	3.600	-0.032
Std Dev		0.016	0.008	0.017

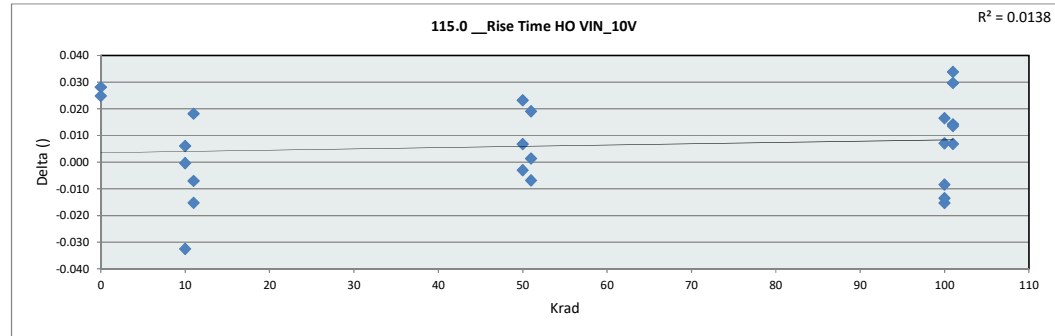

115.0 Rise Time HO VIN_10	
Test Site	DAL
Tester	ETS364
Test Number	EB672303
Max Limit	7.5
Min Limit	1

Krad	0	10	11	50	51	100	101
LL	1.000	1.000	1.000	1.000	1.000	1.000	1.000
Min	3.623	3.600	3.620	3.608	3.617	3.620	3.611
Average	3.623	3.610	3.627	3.618	3.624	3.625	3.623
Max	3.623	3.617	3.635	3.626	3.629	3.630	3.631
UL	7.500	7.500	7.500	7.500	7.500	7.500	7.500

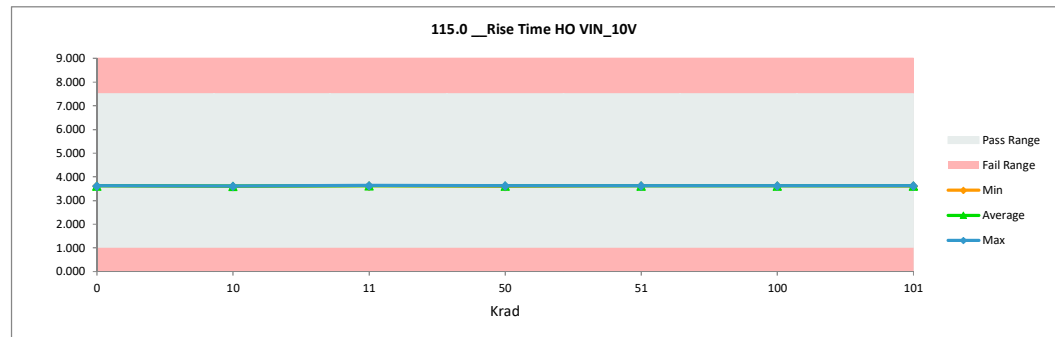

TID "HDR" Report
5962R2220102VXC

115.1 Fall Time HO VIN_10V		
Test Site	DAL	DAL
Tester	ETS364	ETS364
Test Number	EB672303	EB672303
Unit		
Max Limit	5.5	5.5
Min Limit	1	1

Krad	Serial #	Pre_HDR_6013	Post_HDR_6013	Delta
0	1	3.754	3.731	-0.023
0	2	3.762	3.725	-0.037
10	182	3.754	3.734	-0.020
10	202	3.763	3.711	-0.051
10	204	3.730	3.732	0.002
11	418	3.753	3.728	-0.025
11	419	3.746	3.732	-0.014
11	443	3.745	3.744	-0.001
50	259	3.772	3.731	-0.041
50	346	3.748	3.738	-0.010
50	347	3.749	3.713	-0.036
51	462	3.733	3.741	0.008
51	478	3.747	3.738	-0.009
51	503	3.746	3.728	-0.017
100	354	3.750	3.729	-0.022
100	363	3.743	3.745	0.002
100	366	3.755	3.741	-0.014
100	383	3.750	3.730	-0.020
100	417	3.740	3.725	-0.015
101	513	3.748	3.753	0.005
101	526	3.757	3.749	-0.008
101	532	3.751	3.747	-0.004
101	533	3.775	3.743	-0.032
101	534	3.760	3.746	-0.014
	Max	3.775	3.753	0.008
	Average	3.751	3.735	-0.016
	Min	3.730	3.711	-0.051
	Std Dev	0.010	0.011	0.015

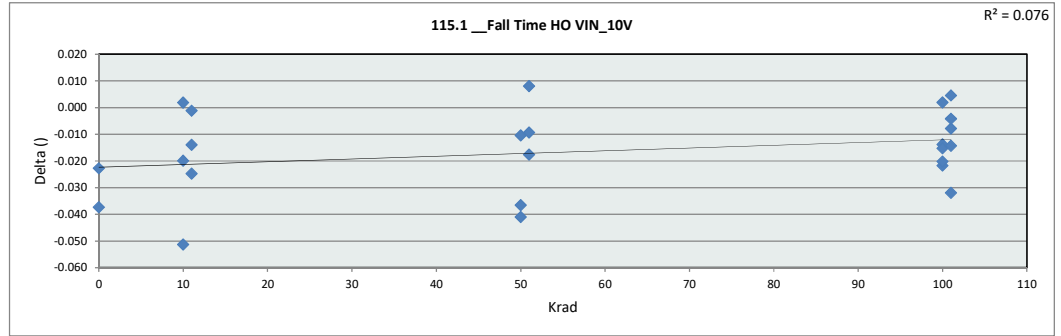

115.1 Fall Time HO VIN_10V	
Test Site	DAL
Tester	ETS364
Test Number	EB672303
Max Limit	5.5
Min Limit	1

Krad	0	10	11	50	51	100	101
LL	1.000	1.000	1.000	1.000	1.000	1.000	1.000
Min	3.725	3.711	3.728	3.713	3.728	3.725	3.743
Average	3.728	3.726	3.735	3.727	3.736	3.734	3.748
Max	3.731	3.734	3.744	3.738	3.741	3.745	3.753
UL	5.500	5.500	5.500	5.500	5.500	5.500	5.500

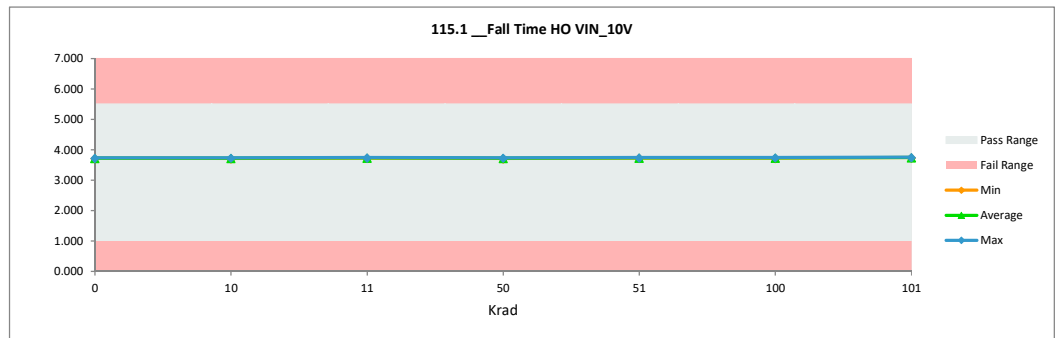

TID "HDR" Report
5962R2220102VXC

115.2 Rise Time LO VIN_10V		
Test Site	DAL	DAL
Tester	ETS364	ETS364
Test Number	EB672303	EB672303
Unit		
Max Limit	7.5	7.5
Min Limit	1	1

Krad	Serial #	Pre_HDR_6013	Post_HDR_6013	Delta
0	1	2.983	3.000	0.016
0	2	2.967	3.008	0.041
10	182	3.002	2.996	-0.006
10	202	2.997	2.990	-0.007
10	204	3.007	2.997	-0.010
11	418	3.015	3.017	0.001
11	419	3.011	3.014	0.003
11	443	3.014	3.040	0.027
50	259	3.012	2.988	-0.025
50	346	2.997	2.994	-0.004
50	347	2.991	2.994	0.004
51	462	3.026	3.005	-0.021
51	478	3.025	3.013	-0.011
51	503	2.997	2.993	-0.005
100	354	2.972	2.995	0.023
100	363	3.023	2.996	-0.027
100	366	3.017	2.990	-0.027
100	383	3.029	2.989	-0.040
100	417	3.022	3.006	-0.016
101	513	2.986	3.019	0.034
101	526	2.980	3.013	0.033
101	532	2.982	3.003	0.021
101	533	2.993	2.991	-0.001
101	534	3.012	3.014	0.002
	Max	3.029	3.040	0.041
	Average	3.002	3.003	0.000
	Min	2.967	2.988	-0.040
	Std Dev	0.018	0.013	0.021

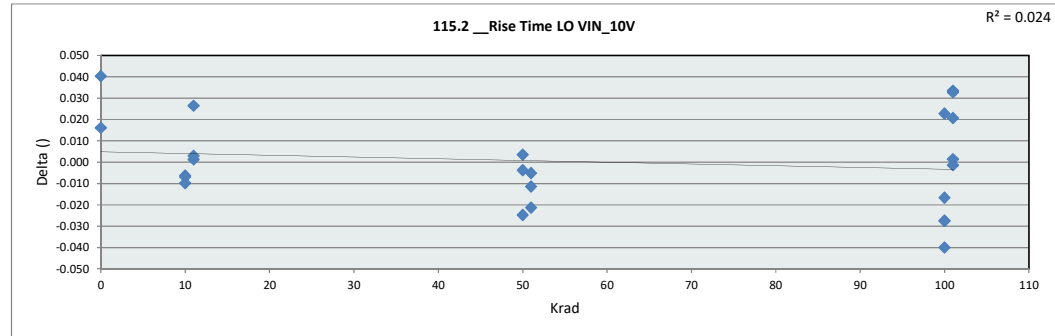

115.2 Rise Time LO VIN_10V	
Test Site	DAL
Tester	ETS364
Test Number	EB672303
Max Limit	7.5
Min Limit	1

Krad	0	10	11	50	51	100	101
LL	1.000	1.000	1.000	1.000	1.000	1.000	1.000
Min	3.000	2.990	3.014	2.988	2.993	2.989	2.991
Average	3.004	2.994	3.024	2.992	3.004	2.995	3.008
Max	3.008	2.997	3.040	2.995	3.013	3.006	3.019
UL	7.500	7.500	7.500	7.500	7.500	7.500	7.500

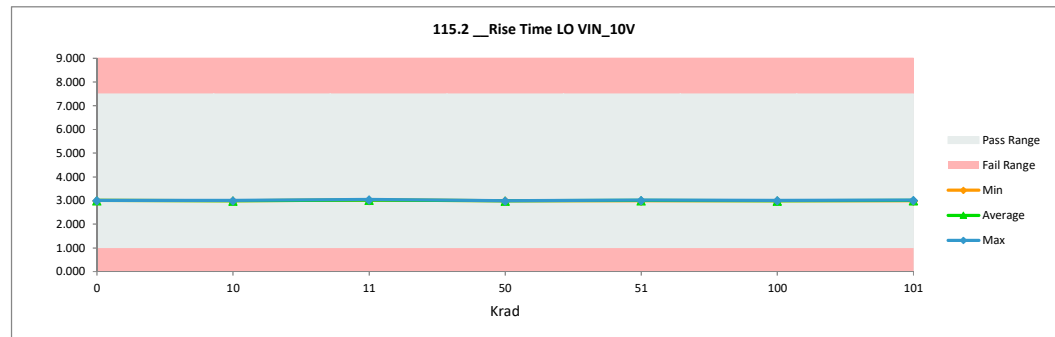

TID "HDR" Report
5962R2220102VXC

115.3 Fall Time LO VIN 10V		
Test Site	DAL	DAL
Tester	ETS364	ETS364
Test Number	EB672303	EB672303
Unit		
Max Limit	5.5	5.5
Min Limit	1	1

Krad	Serial #	Pre_HDR_6013	Post_HDR_6013	Delta
0	1	3.245	3.181	-0.063
0	2	3.253	3.188	-0.065
10	182	3.197	3.177	-0.020
10	202	3.232	3.169	-0.063
10	204	3.199	3.168	-0.031
11	418	3.194	3.197	0.002
11	419	3.193	3.193	0.000
11	443	3.191	3.225	0.035
50	259	3.259	3.173	-0.086
50	346	3.200	3.180	-0.020
50	347	3.202	3.162	-0.040
51	462	3.198	3.178	-0.020
51	478	3.192	3.201	0.009
51	503	3.209	3.175	-0.034
100	354	3.193	3.180	-0.013
100	363	3.189	3.174	-0.014
100	366	3.216	3.238	0.022
100	383	3.199	3.190	-0.009
100	417	3.205	3.193	-0.012
101	513	3.199	3.211	0.012
101	526	3.215	3.218	0.003
101	532	3.188	3.188	0.001
101	533	3.193	3.186	-0.007
101	534	3.221	3.188	-0.033
Max		3.259	3.238	0.035
Average		3.208	3.189	-0.019
Min		3.188	3.162	-0.086
Std Dev		0.020	0.019	0.029

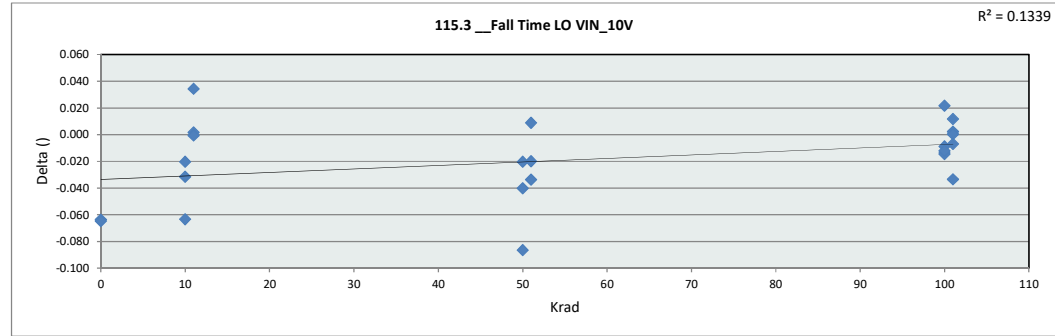

115.3 Fall Time LO VIN 10V	
Test Site	DAL
Tester	ETS364
Test Number	EB672303
Max Limit	5.5
Min Limit	1

Krad	0	10	11	50	51	100	101
LL	1.000	1.000	1.000	1.000	1.000	1.000	1.000
Min	3.181	3.168	3.193	3.162	3.175	3.175	3.186
Average	3.185	3.171	3.205	3.172	3.185	3.195	3.198
Max	3.188	3.177	3.225	3.180	3.201	3.238	3.218
UL	5.500	5.500	5.500	5.500	5.500	5.500	5.500

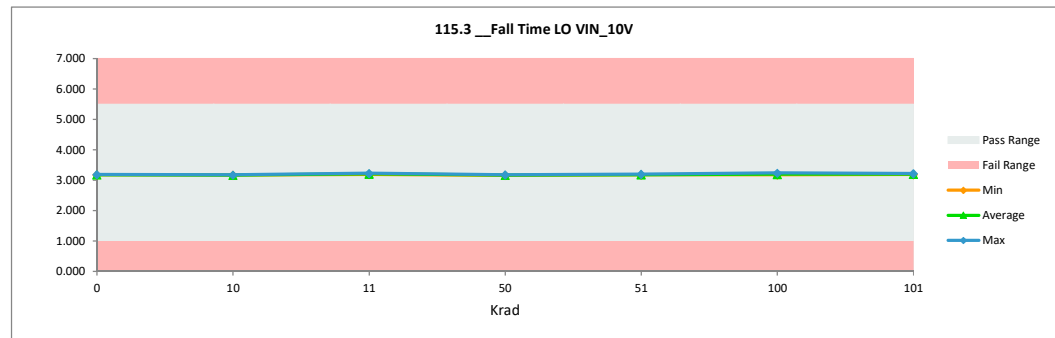

TID "HDR" Report 5962R2220102VXC

116.0 Rise Time HO VIN_12V		
Test Site	DAL	DAL
Tester	ETS364	ETS364
Test Number	EB672303	EB672303
Unit		
Max Limit	7.5	7.5
Min Limit	1	1

Krad	Serial #	Pre_HDR_6013	Post_HDR_6013	Delta
0	1	3.608	3.624	0.016
0	2	3.602	3.625	0.023
10	182	3.610	3.604	-0.007
10	202	3.613	3.614	0.001
10	204	3.640	3.612	-0.028
11	418	3.647	3.613	-0.034
11	419	3.635	3.631	-0.004
11	443	3.631	3.641	0.010
50	259	3.629	3.625	-0.003
50	346	3.610	3.626	0.017
50	347	3.603	3.594	-0.009
51	462	3.633	3.630	-0.003
51	478	3.627	3.621	-0.006
51	503	3.604	3.614	0.010
100	354	3.596	3.624	0.028
100	363	3.636	3.619	-0.017
100	366	3.631	3.634	0.003
100	383	3.631	3.629	-0.003
100	417	3.638	3.630	-0.008
101	513	3.602	3.617	0.015
101	526	3.601	3.625	0.024
101	532	3.606	3.623	0.016
101	533	3.620	3.616	-0.004
101	534	3.631	3.627	-0.004
	Max	3.647	3.641	0.028
	Average	3.620	3.622	0.001
	Min	3.596	3.594	-0.034
	Std Dev	0.015	0.010	0.016

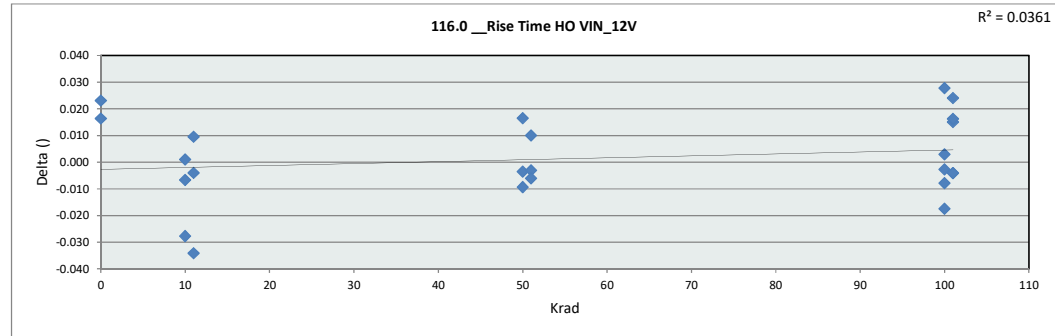

116.0 Rise Time HO VIN_12	
Test Site	DAL
Tester	ETS364
Test Number	EB672303
Max Limit	7.5
Min Limit	1

Krad	0	10	11	50	51	100	101
LL	1.000	1.000	1.000	1.000	1.000	1.000	1.000
Min	3.624	3.604	3.613	3.594	3.614	3.619	3.616
Average	3.625	3.610	3.628	3.615	3.622	3.627	3.622
Max	3.625	3.614	3.641	3.627	3.630	3.634	3.627
UL	7.500	7.500	7.500	7.500	7.500	7.500	7.500

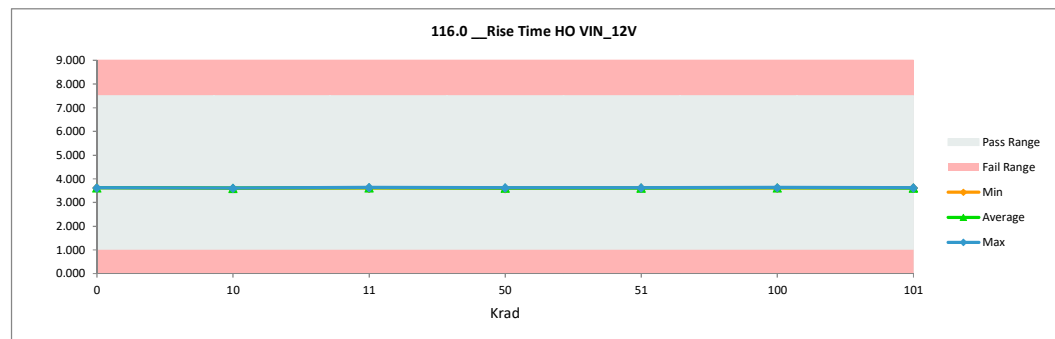

TID "HDR" Report
5962R2220102VXC

116.1 Fall Time HO VIN_12V		
Test Site	DAL	DAL
Tester	ETS364	ETS364
Test Number	EB672303	EB672303
Unit		
Max Limit	5.5	5.5
Min Limit	1	1

Krad	Serial #	Pre_HDR_6013	Post_HDR_6013	Delta
0	1	3.749	3.732	-0.016
0	2	3.765	3.725	-0.039
10	182	3.755	3.738	-0.017
10	202	3.754	3.718	-0.036
10	204	3.728	3.722	-0.006
11	418	3.747	3.724	-0.023
11	419	3.729	3.721	-0.008
11	443	3.726	3.750	0.024
50	259	3.766	3.721	-0.045
50	346	3.747	3.725	-0.022
50	347	3.744	3.716	-0.028
51	462	3.724	3.725	0.000
51	478	3.747	3.741	-0.005
51	503	3.742	3.730	-0.011
100	354	3.749	3.729	-0.019
100	363	3.733	3.730	-0.003
100	366	3.756	3.726	-0.030
100	383	3.748	3.738	-0.010
100	417	3.752	3.729	-0.022
101	513	3.744	3.742	-0.002
101	526	3.757	3.739	-0.018
101	532	3.730	3.749	0.019
101	533	3.746	3.740	-0.006
101	534	3.760	3.753	-0.007
Max		3.766	3.753	0.024
Average		3.746	3.732	-0.014
Min		3.724	3.716	-0.045
Std Dev		0.012	0.010	0.016

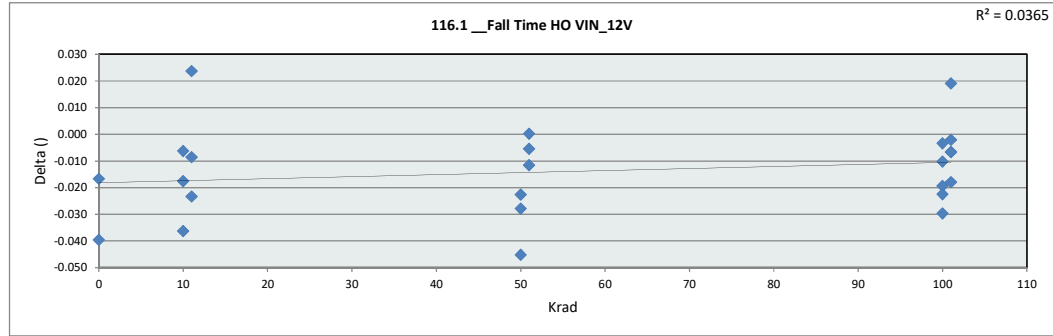

116.1 Fall Time HO VIN_12V	
Test Site	DAL
Tester	ETS364
Test Number	EB672303
Max Limit	5.5
Min Limit	1

Krad	0	10	11	50	51	100	101
LL	1.000	1.000	1.000	1.000	1.000	1.000	1.000
Min	3.725	3.718	3.721	3.716	3.725	3.726	3.739
Average	3.729	3.726	3.731	3.721	3.732	3.731	3.745
Max	3.732	3.738	3.750	3.725	3.741	3.738	3.753
UL	5.500	5.500	5.500	5.500	5.500	5.500	5.500

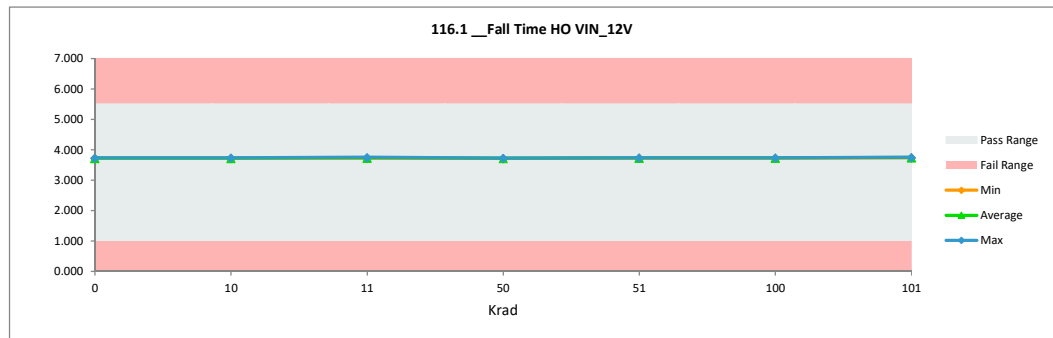

TID "HDR" Report
5962R2220102VXC

116.2 Rise Time LO VIN_12V		
Test Site	DAL	DAL
Tester	ETS364	ETS364
Test Number	EB672303	EB672303
Unit		
Max Limit	7.5	7.5
Min Limit	1	1

Krad	Serial #	Pre_HDR_6013	Post_HDR_6013	Delta
0	1	2.971	2.988	0.017
0	2	2.973	2.996	0.023
10	182	3.009	2.996	-0.013
10	202	2.990	2.999	0.009
10	204	3.021	2.985	-0.036
11	418	3.024	3.018	-0.005
11	419	3.019	3.004	-0.014
11	443	3.010	3.043	0.032
50	259	2.996	2.991	-0.005
50	346	2.993	3.000	0.007
50	347	2.990	2.996	0.007
51	462	3.016	2.993	-0.023
51	478	3.027	3.014	-0.013
51	503	2.994	2.998	0.004
100	354	2.973	2.998	0.025
100	363	3.009	2.991	-0.017
100	366	3.014	2.991	-0.022
100	383	3.020	2.995	-0.024
100	417	3.029	3.005	-0.024
101	513	2.971	3.020	0.050
101	526	2.983	3.008	0.026
101	532	2.979	2.995	0.016
101	533	2.994	2.990	-0.004
101	534	3.016	3.012	-0.004
Max		3.029	3.043	0.050
Average		3.001	3.001	0.000
Min		2.971	2.985	-0.036
Std Dev		0.019	0.013	0.021

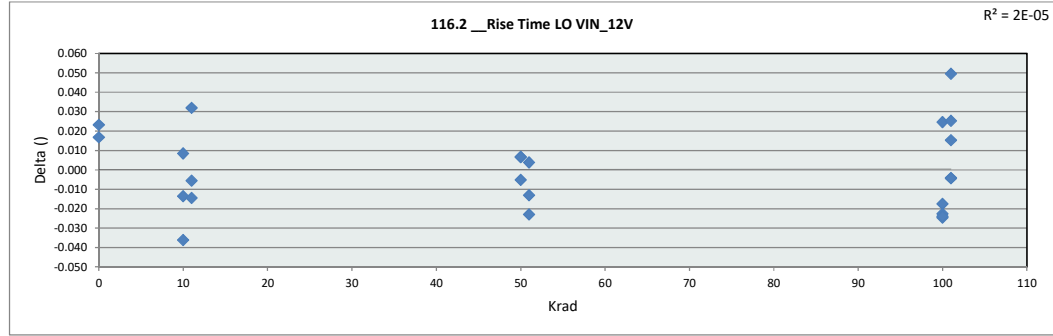

116.2 Rise Time LO VIN_12V	
Test Site	DAL
Tester	ETS364
Test Number	EB672303
Max Limit	7.5
Min Limit	1

Krad	0	10	11	50	51	100	101
LL	1.000	1.000	1.000	1.000	1.000	1.000	1.000
Min	2.988	2.985	3.004	2.991	2.994	2.991	2.990
Average	2.992	2.993	3.022	2.996	3.002	2.996	3.005
Max	2.996	2.999	3.043	3.000	3.014	3.005	3.021
UL	7.500	7.500	7.500	7.500	7.500	7.500	7.500

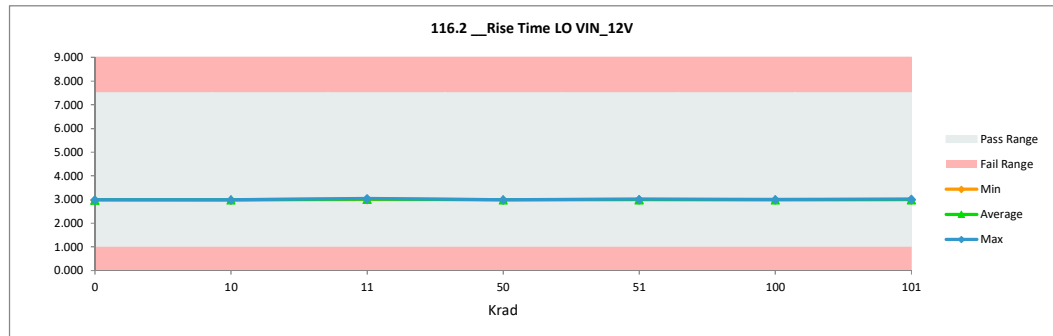

TID "HDR" Report
5962R2220102VXC

116.3 Fall Time LO VIN 12V		
Test Site	DAL	DAL
Tester	ETS364	ETS364
Test Number	EB672303	EB672303
Unit		
Max Limit	5.5	5.5
Min Limit	1	1

Krad	Serial #	Pre_HDR_6013	Post_HDR_6013	Delta
0	1	3.244	3.184	-0.060
0	2	3.254	3.190	-0.065
10	182	3.204	3.179	-0.025
10	202	3.234	3.155	-0.079
10	204	3.186	3.167	-0.019
11	418	3.200	3.191	-0.009
11	419	3.192	3.195	0.003
11	443	3.191	3.233	0.042
50	259	3.261	3.173	-0.088
50	346	3.206	3.183	-0.023
50	347	3.207	3.164	-0.042
51	462	3.197	3.183	-0.014
51	478	3.191	3.204	0.013
51	503	3.211	3.167	-0.044
100	354	3.196	3.174	-0.022
100	363	3.192	3.172	-0.020
100	366	3.224	3.238	0.014
100	383	3.204	3.193	-0.012
100	417	3.196	3.192	-0.005
101	513	3.205	3.193	-0.012
101	526	3.218	3.223	0.005
101	532	3.187	3.189	0.002
101	533	3.195	3.178	-0.017
101	534	3.221	3.181	-0.040
Max		3.261	3.238	0.042
Average		3.209	3.188	-0.022
Min		3.186	3.155	-0.088
Std Dev		0.021	0.020	0.031

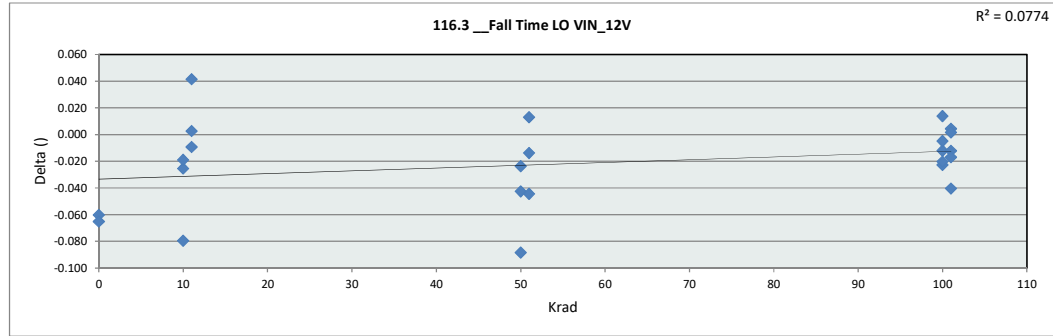

116.3 Fall Time LO VIN 12V	
Test Site	DAL
Tester	ETS364
Test Number	EB672303
Max Limit	5.5
Min Limit	1

Krad	0	10	11	50	51	100	101
LL	1.000	1.000	1.000	1.000	1.000	1.000	1.000
Min	3.184	3.155	3.191	3.164	3.167	3.172	3.178
Average	3.187	3.167	3.206	3.173	3.185	3.194	3.193
Max	3.190	3.179	3.233	3.183	3.204	3.238	3.223
UL	5.500	5.500	5.500	5.500	5.500	5.500	5.500

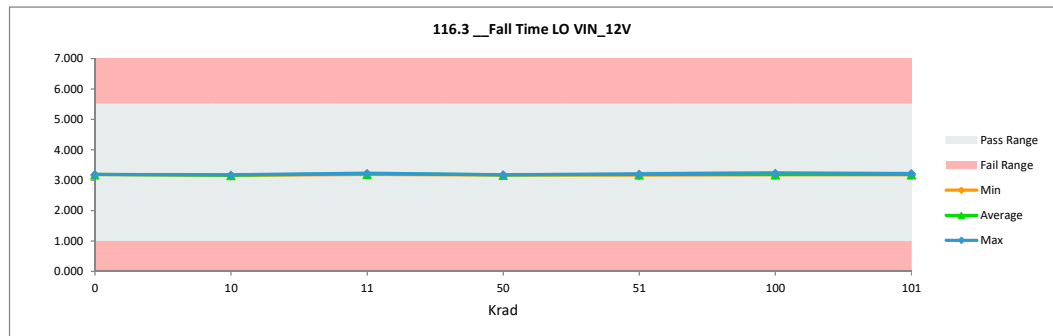

TID "HDR" Report
5962R2220102VXC

117.0 Rise Time HO VIN_14V		
Test Site	DAL	DAL
Tester	ETS364	ETS364
Test Number	EB672303	EB672303
Unit		
Max Limit	7.5	7.5
Min Limit	1	1

Krad	Serial #	Pre_HDR_6013	Post_HDR_6013	Delta
0	1	3.608	3.622	0.014
0	2	3.608	3.619	0.011
10	182	3.619	3.618	-0.001
10	202	3.610	3.603	-0.007
10	204	3.618	3.620	0.002
11	418	3.627	3.626	-0.001
11	419	3.634	3.632	-0.003
11	443	3.634	3.647	0.013
50	259	3.624	3.607	-0.017
50	346	3.613	3.623	0.010
50	347	3.609	3.604	-0.004
51	462	3.630	3.616	-0.014
51	478	3.638	3.633	-0.005
51	503	3.607	3.615	0.008
100	354	3.612	3.618	0.006
100	363	3.635	3.621	-0.014
100	366	3.634	3.631	-0.003
100	383	3.641	3.617	-0.024
100	417	3.639	3.621	-0.019
101	513	3.605	3.625	0.019
101	526	3.605	3.627	0.022
101	532	3.614	3.626	0.012
101	533	3.617	3.621	0.004
101	534	3.631	3.640	0.009
	Max	3.641	3.647	0.022
	Average	3.621	3.622	0.001
	Min	3.605	3.603	-0.024
	Std Dev	0.012	0.010	0.012

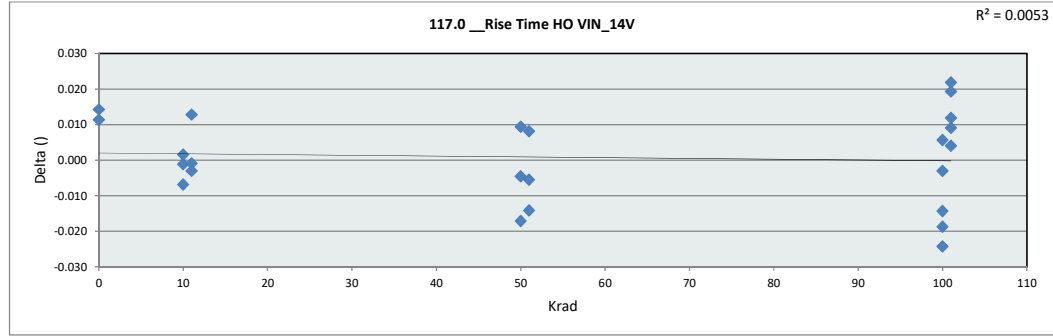

117.0 Rise Time HO VIN_14	
Test Site	DAL
Tester	ETS364
Test Number	EB672303
Max Limit	7.5
Min Limit	1

Krad	0	10	11	50	51	100	101
LL	1.000	1.000	1.000	1.000	1.000	1.000	1.000
Min	3.619	3.603	3.626	3.604	3.616	3.617	3.621
Average	3.621	3.614	3.635	3.611	3.622	3.621	3.628
Max	3.622	3.620	3.647	3.623	3.633	3.631	3.640
UL	7.500	7.500	7.500	7.500	7.500	7.500	7.500

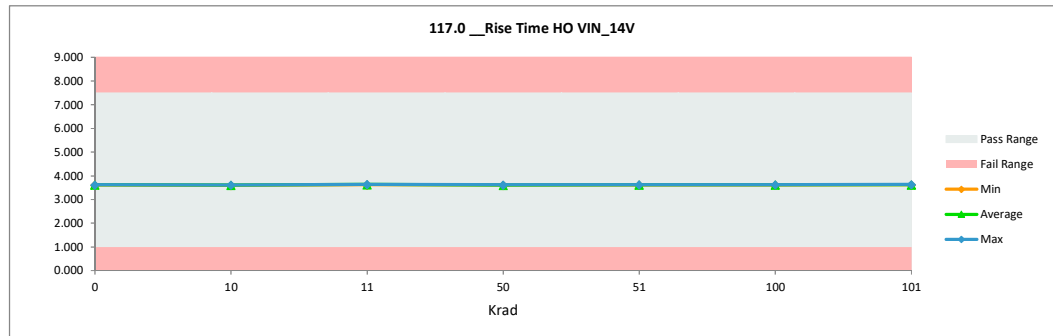

TID "HDR" Report
5962R2220102VXC

117.1 Fall Time HO VIN_14V		
Test Site	DAL	DAL
Tester	ETS364	ETS364
Test Number	EB672303	EB672303
Unit		
Max Limit	5.5	5.5
Min Limit	1	1

Krad	Serial #	Pre_HDR_6013	Post_HDR_6013	Delta
0	1	3.764	3.723	-0.041
0	2	3.752	3.731	-0.021
10	182	3.755	3.719	-0.035
10	202	3.751	3.724	-0.027
10	204	3.733	3.724	-0.010
11	418	3.743	3.713	-0.030
11	419	3.734	3.734	0.000
11	443	3.736	3.742	0.006
50	259	3.759	3.732	-0.027
50	346	3.738	3.734	-0.003
50	347	3.752	3.714	-0.038
51	462	3.735	3.729	-0.007
51	478	3.743	3.723	-0.021
51	503	3.751	3.739	-0.013
100	354	3.736	3.734	-0.002
100	363	3.739	3.733	-0.007
100	366	3.756	3.740	-0.015
100	383	3.733	3.747	0.013
100	417	3.738	3.735	-0.003
101	513	3.741	3.738	-0.002
101	526	3.747	3.744	-0.002
101	532	3.741	3.729	-0.012
101	533	3.748	3.753	0.005
101	534	3.746	3.755	0.009
Max		3.764	3.755	0.013
Average		3.745	3.733	-0.012
Min		3.733	3.713	-0.041
Std Dev		0.009	0.011	0.015

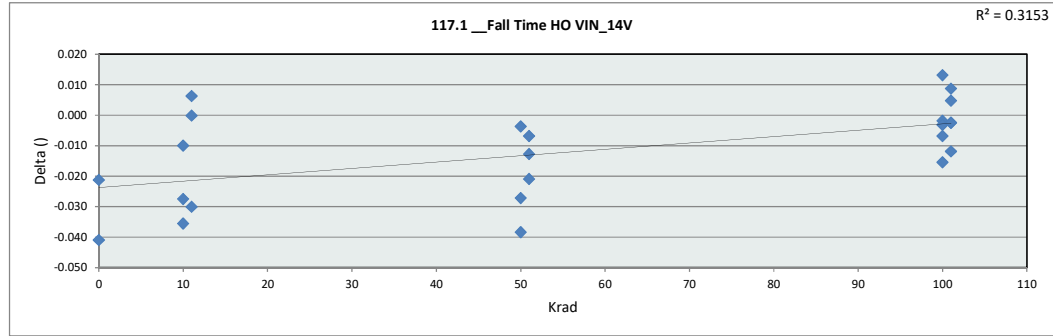

117.1 Fall Time HO VIN_14V	
Test Site	DAL
Tester	ETS364
Test Number	EB672303
Max Limit	5.5
Min Limit	1

Krad	0	10	11	50	51	100	101
LL	1.000	1.000	1.000	1.000	1.000	1.000	1.000
Min	3.723	3.719	3.713	3.714	3.723	3.733	3.729
Average	3.727	3.722	3.730	3.726	3.730	3.738	3.744
Max	3.731	3.724	3.742	3.734	3.739	3.747	3.755
UL	5.500	5.500	5.500	5.500	5.500	5.500	5.500

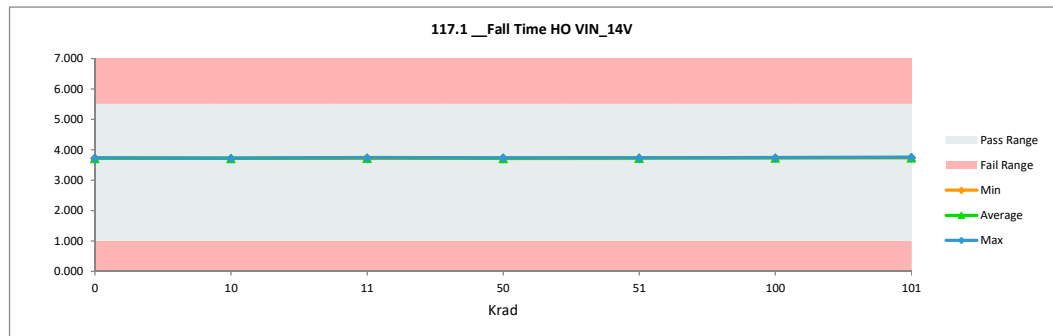

TID "HDR" Report
5962R2220102VXC

117.2 Rise Time LO VIN_14V		
Test Site	DAL	DAL
Tester	ETS364	ETS364
Test Number	EB672303	EB672303
Unit		
Max Limit	7.5	7.5
Min Limit	1	1

Krad	Serial #	Pre_HDR_6013	Post_HDR_6013	Delta
0	1	2.975	2.996	0.021
0	2	2.979	3.001	0.022
10	182	2.994	2.994	0.000
10	202	2.999	3.000	0.001
10	204	3.021	2.992	-0.029
11	418	3.021	3.014	-0.008
11	419	3.018	3.009	-0.009
11	443	3.011	3.039	0.028
50	259	3.004	2.991	-0.013
50	346	2.982	2.999	0.017
50	347	2.977	2.990	0.013
51	462	3.024	3.001	-0.024
51	478	3.016	3.001	-0.015
51	503	2.986	3.004	0.018
100	354	2.960	3.000	0.040
100	363	3.017	2.987	-0.030
100	366	3.015	2.996	-0.019
100	383	3.026	3.000	-0.026
100	417	3.025	3.002	-0.023
101	513	2.979	3.004	0.025
101	526	2.975	3.015	0.040
101	532	2.971	2.995	0.023
101	533	2.983	2.978	-0.005
101	534	3.017	3.016	-0.001
	Max	3.026	3.039	0.040
	Average	2.999	3.001	0.002
	Min	2.960	2.978	-0.030
	Std Dev	0.021	0.012	0.022

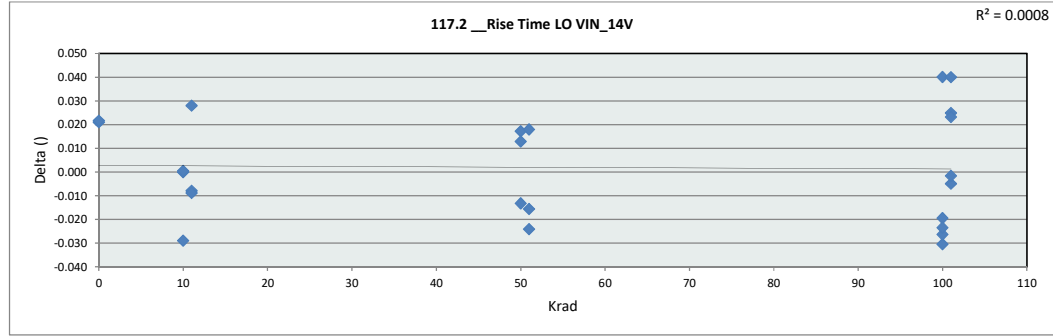

117.2 Rise Time LO VIN_14V	
Test Site	DAL
Tester	ETS364
Test Number	EB672303
Max Limit	7.5
Min Limit	1

Krad	0	10	11	50	51	100	101
LL	1.000	1.000	1.000	1.000	1.000	1.000	1.000
Min	2.996	2.992	3.009	2.990	3.001	2.987	2.978
Average	2.999	2.995	3.021	2.994	3.002	2.997	3.002
Max	3.001	3.000	3.039	2.999	3.004	3.002	3.016
UL	7.500	7.500	7.500	7.500	7.500	7.500	7.500

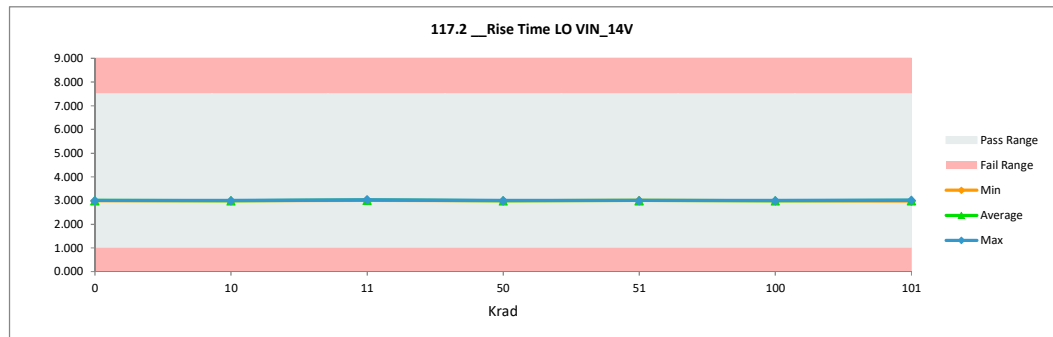

TID "HDR" Report
5962R2220102VXC

117.3 Fall Time LO VIN_14V		
Test Site	DAL	DAL
Tester	ETS364	ETS364
Test Number	EB672303	EB672303
Unit		
Max Limit	5.5	5.5
Min Limit	1	1

Krad	Serial #	Pre_HDR_6013	Post_HDR_6013	Delta
0	1	3.244	3.171	-0.073
0	2	3.260	3.180	-0.080
10	182	3.210	3.180	-0.030
10	202	3.222	3.160	-0.063
10	204	3.190	3.169	-0.021
11	418	3.180	3.195	0.015
11	419	3.180	3.200	0.020
11	443	3.180	3.236	0.055
50	259	3.260	3.169	-0.091
50	346	3.208	3.176	-0.033
50	347	3.210	3.169	-0.041
51	462	3.197	3.169	-0.027
51	478	3.192	3.203	0.011
51	503	3.205	3.170	-0.035
100	354	3.201	3.171	-0.030
100	363	3.181	3.173	-0.008
100	366	3.227	3.242	0.015
100	383	3.208	3.180	-0.028
100	417	3.204	3.189	-0.016
101	513	3.194	3.204	0.010
101	526	3.222	3.225	0.003
101	532	3.189	3.190	0.001
101	533	3.196	3.190	-0.006
101	534	3.226	3.186	-0.039
Max		3.260	3.242	0.055
Average		3.208	3.187	-0.020
Min		3.180	3.160	-0.091
Std Dev		0.023	0.022	0.035

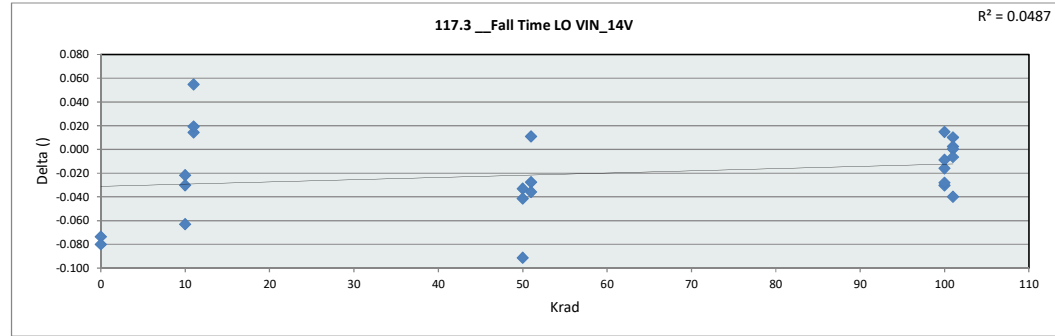

117.3 Fall Time LO VIN_14V	
Test Site	DAL
Tester	ETS364
Test Number	EB672303
Max Limit	5.5
Min Limit	1

Krad	0	10	11	50	51	100	101
LL	1.000	1.000	1.000	1.000	1.000	1.000	1.000
Min	3.171	3.160	3.195	3.169	3.169	3.171	3.186
Average	3.175	3.169	3.210	3.171	3.181	3.191	3.199
Max	3.180	3.180	3.236	3.176	3.203	3.242	3.225
UL	5.500	5.500	5.500	5.500	5.500	5.500	5.500

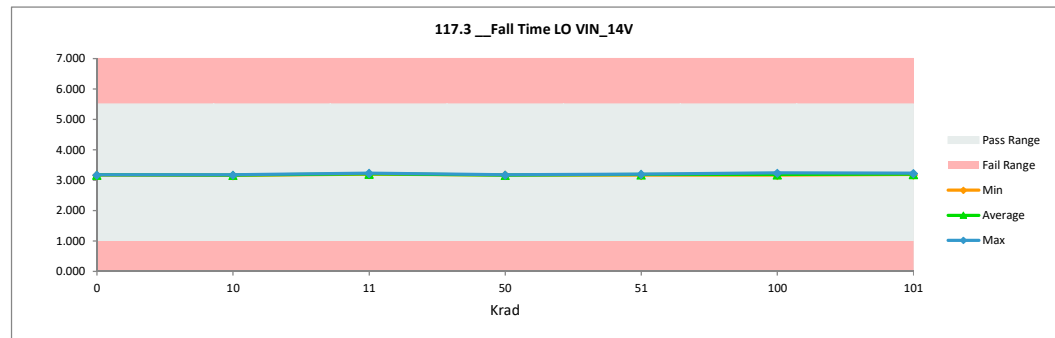

TID "HDR" Report 5962R2220102VXC

120.0 Min Input PW Static HS		
Test Site	DAL	DAL
Tester	ETS364	ETS364
Test Number	EB672303	EB672303
Unit		
Max Limit	8	8
Min Limit	0	0

Krad	Serial #	Pre_HDR_6013	Post_HDR_6013	Delta
0	1	5.000	5.000	0.000
0	2	5.000	5.000	0.000
10	182	4.000	4.000	0.000
10	202	4.000	4.000	0.000
10	204	4.000	4.000	0.000
11	418	4.000	4.000	0.000
11	419	4.000	4.000	0.000
11	443	4.000	4.000	0.000
50	259	4.000	4.000	0.000
50	346	4.000	4.000	0.000
50	347	4.000	4.000	0.000
51	462	4.000	4.000	0.000
51	478	4.000	4.000	0.000
51	503	4.000	4.000	0.000
100	354	4.000	4.000	0.000
100	363	4.000	4.000	0.000
100	366	5.000	4.000	-1.000
100	383	4.000	4.000	0.000
100	417	4.000	4.000	0.000
101	513	4.000	4.000	0.000
101	526	5.000	4.000	-1.000
101	532	4.000	4.000	0.000
101	533	4.000	4.000	0.000
101	534	4.000	4.000	0.000
Max		5.000	5.000	0.000
Average		4.167	4.083	-0.083
Min		4.000	4.000	-1.000
Std Dev		0.381	0.282	0.282

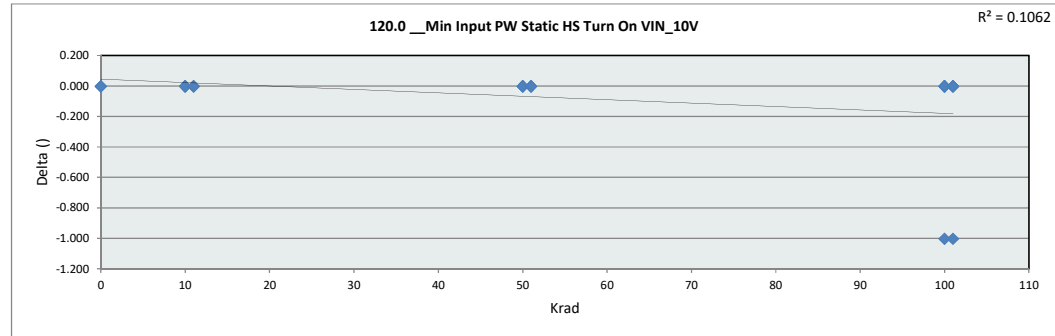

120.0 Min Input PW Static H	
Test Site	DAL
Tester	ETS364
Test Number	EB672303
Max Limit	8
Min Limit	0

	0	10	11	50	51	100	101
LL	0.000	0.000	0.000	0.000	0.000	0.000	0.000
Min	5.000	4.000	4.000	4.000	4.000	4.000	4.000
Average	5.000	4.000	4.000	4.000	4.000	4.000	4.000
Max	5.000	4.000	4.000	4.000	4.000	4.000	4.000
UL	8.000	8.000	8.000	8.000	8.000	8.000	8.000

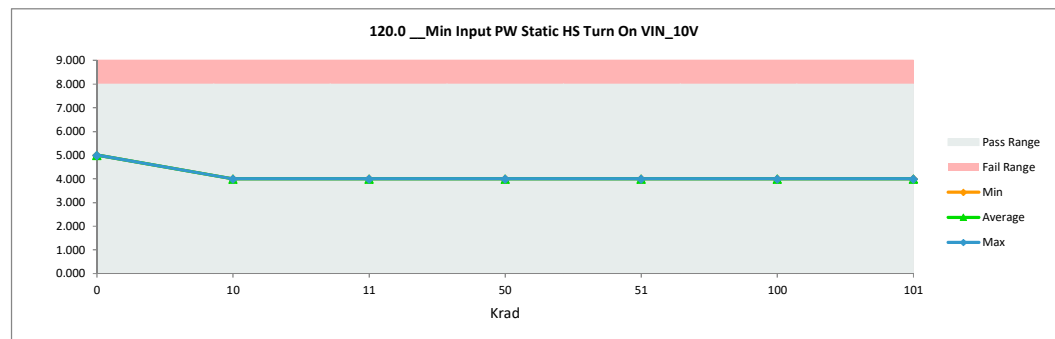

TID "HDR" Report
5962R2220102VXC

120.1 Min Input PW Static HS		
Test Site	DAL	DAL
Tester	ETS364	ETS364
Test Number	EB672303	EB672303
Unit		
Max Limit	12	12
Min Limit	0	0

Krad	Serial #	Pre_HDR_6013	Post_HDR_6013	Delta
0	1	6.000	6.000	0.000
0	2	7.000	7.000	0.000
10	182	7.000	7.000	0.000
10	202	6.000	6.000	0.000
10	204	6.000	6.000	0.000
11	418	7.000	7.000	0.000
11	419	6.000	6.000	0.000
11	443	7.000	7.000	0.000
50	259	6.000	6.000	0.000
50	346	6.000	6.000	0.000
50	347	6.000	6.000	0.000
51	462	6.000	6.000	0.000
51	478	7.000	6.000	-1.000
51	503	7.000	6.000	-1.000
100	354	6.000	6.000	0.000
100	363	6.000	6.000	0.000
100	366	7.000	7.000	0.000
100	383	7.000	7.000	0.000
100	417	6.000	6.000	0.000
101	513	7.000	7.000	0.000
101	526	7.000	7.000	0.000
101	532	6.000	6.000	0.000
101	533	6.000	6.000	0.000
101	534	7.000	7.000	0.000
Max		7.000	7.000	0.000
Average		6.458	6.375	-0.083
Min		6.000	6.000	-1.000
Std Dev		0.509	0.495	0.282

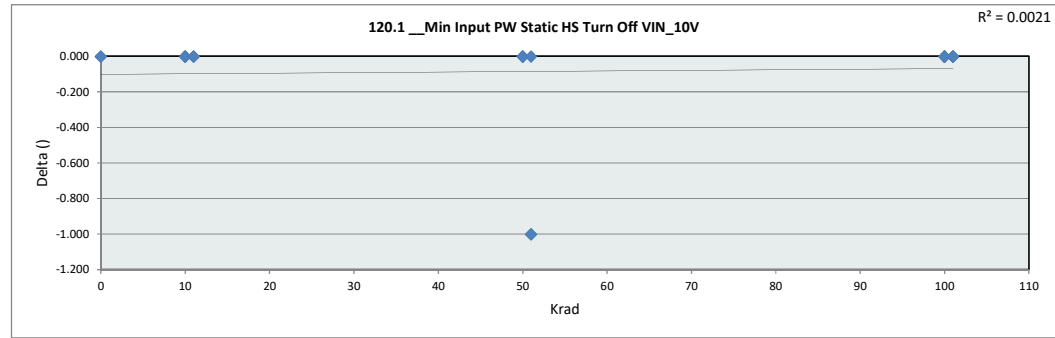

120.1 Min Input PW Static H	
Test Site	DAL
Tester	ETS364
Test Number	EB672303
Max Limit	12
Min Limit	0

Krad	0	10	11	50	51	100	101
LL	0.000	0.000	0.000	0.000	0.000	0.000	0.000
Min	6.000	6.000	6.000	6.000	6.000	6.000	6.000
Average	6.500	6.333	6.667	6.000	6.000	6.400	6.600
Max	7.000	7.000	7.000	6.000	6.000	7.000	7.000
UL	12.000	12.000	12.000	12.000	12.000	12.000	12.000

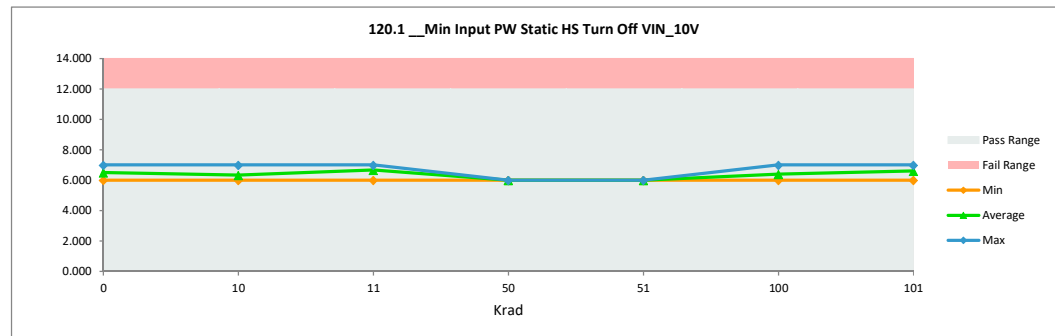

TID "HDR" Report
5962R2220102VXC

120.2 Min Input PW Static LS		
Test Site	DAL	DAL
Tester	ETS364	ETS364
Test Number	EB672303	EB672303
Unit		
Max Limit	8	8
Min Limit	0	0

Krad	Serial #	Pre_HDR_6013	Post_HDR_6013	Delta
0	1	4.000	4.000	0.000
0	2	4.000	4.000	0.000
10	182	4.000	4.000	0.000
10	202	4.000	4.000	0.000
10	204	4.000	4.000	0.000
11	418	4.000	4.000	0.000
11	419	4.000	4.000	0.000
11	443	4.000	4.000	0.000
50	259	4.000	4.000	0.000
50	346	4.000	4.000	0.000
50	347	4.000	4.000	0.000
51	462	4.000	4.000	0.000
51	478	4.000	4.000	0.000
51	503	4.000	4.000	0.000
100	354	4.000	4.000	0.000
100	363	4.000	4.000	0.000
100	366	4.000	4.000	0.000
100	383	4.000	4.000	0.000
100	417	4.000	4.000	0.000
101	513	4.000	4.000	0.000
101	526	4.000	4.000	0.000
101	532	4.000	4.000	0.000
101	533	4.000	4.000	0.000
101	534	4.000	4.000	0.000
Max		4.000	4.000	0.000
Average		4.000	4.000	0.000
Min		4.000	4.000	0.000
Std Dev		0.000	0.000	0.000

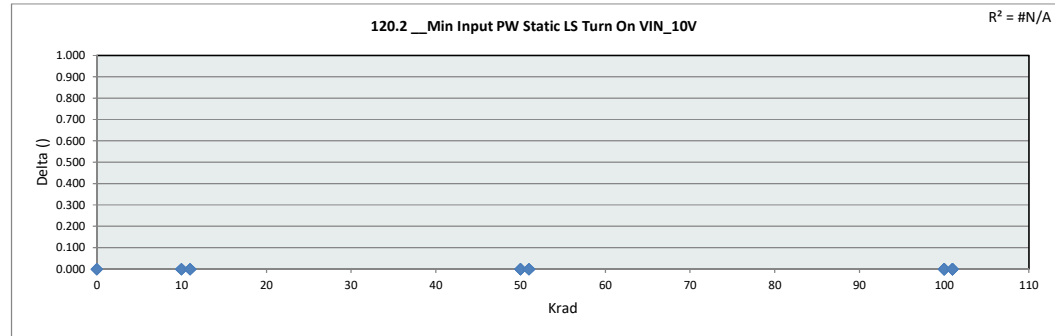

120.2 Min Input PW Static L	
Test Site	DAL
Tester	ETS364
Test Number	EB672303
Max Limit	8
Min Limit	0

	0	10	11	50	51	100	101
LL	0.000	0.000	0.000	0.000	0.000	0.000	0.000
Min	4.000	4.000	4.000	4.000	4.000	4.000	4.000
Average	4.000	4.000	4.000	4.000	4.000	4.000	4.000
Max	4.000	4.000	4.000	4.000	4.000	4.000	4.000
UL	8.000	8.000	8.000	8.000	8.000	8.000	8.000

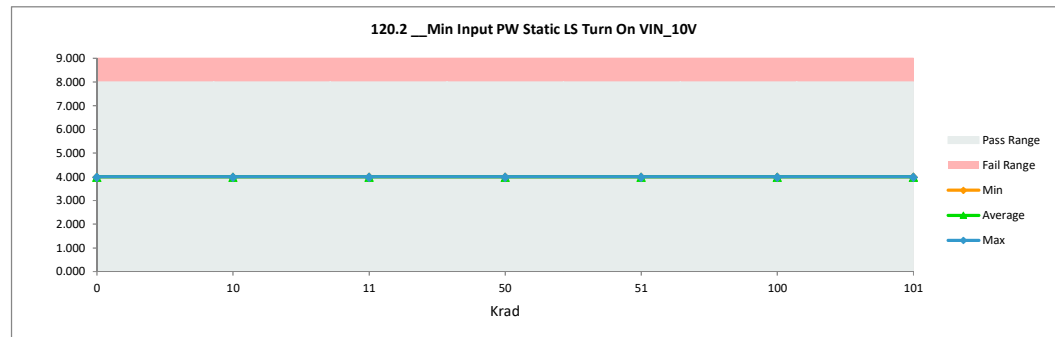

TID "HDR" Report
5962R2220102VXC

120.3 Min Input PW Static LS		
Test Site	DAL	DAL
Tester	ETS364	ETS364
Test Number	EB672303	EB672303
Unit		
Max Limit	12	12
Min Limit	0	0

Krad	Serial #	Pre_HDR_6013	Post_HDR_6013	Delta
0	1	6.000	6.000	0.000
0	2	6.000	6.000	0.000
10	182	6.000	6.000	0.000
10	202	6.000	6.000	0.000
10	204	5.000	6.000	1.000
11	418	6.000	6.000	0.000
11	419	5.000	6.000	1.000
11	443	5.000	6.000	1.000
50	259	6.000	6.000	0.000
50	346	6.000	6.000	0.000
50	347	6.000	6.000	0.000
51	462	6.000	6.000	0.000
51	478	5.000	6.000	1.000
51	503	6.000	6.000	0.000
100	354	6.000	6.000	0.000
100	363	6.000	6.000	0.000
100	366	6.000	6.000	0.000
100	383	6.000	5.000	-1.000
100	417	6.000	6.000	0.000
101	513	6.000	6.000	0.000
101	526	6.000	6.000	0.000
101	532	6.000	6.000	0.000
101	533	6.000	6.000	0.000
101	534	6.000	6.000	0.000
Max		6.000	6.000	1.000
Average		5.833	5.958	0.125
Min		5.000	5.000	-1.000
Std Dev		0.381	0.204	0.448

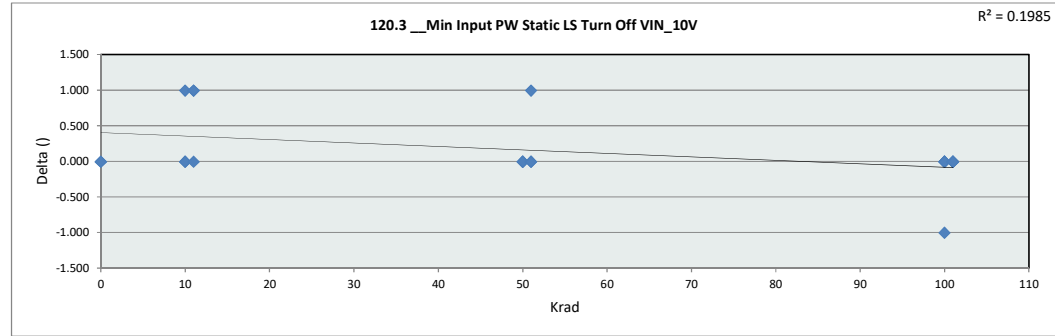

120.3 Min Input PW Static L	
Test Site	DAL
Tester	ETS364
Test Number	EB672303
Max Limit	12
Min Limit	0

	0	10	11	50	51	100	101
LL	0.000	0.000	0.000	0.000	0.000	0.000	0.000
Min	6.000	6.000	6.000	6.000	6.000	5.000	6.000
Average	6.000	6.000	6.000	6.000	6.000	5.800	6.000
Max	6.000	6.000	6.000	6.000	6.000	6.000	6.000
UL	12.000	12.000	12.000	12.000	12.000	12.000	12.000

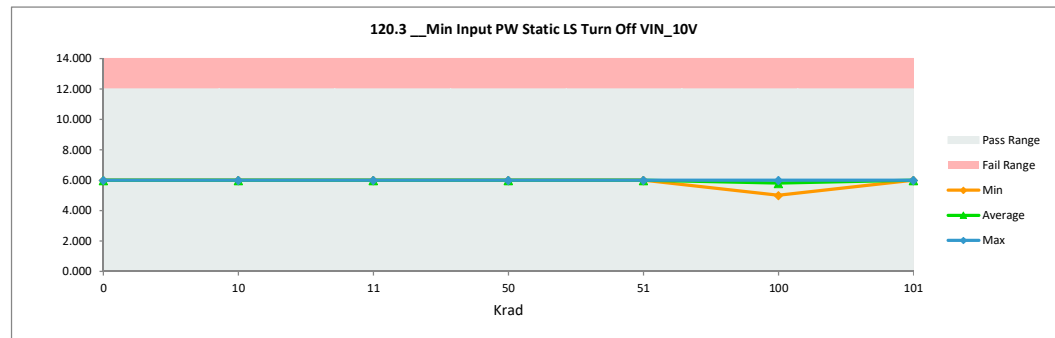

TID "HDR" Report
5962R2220102VXC

120.4 Min Input PW Static HS		
Test Site	DAL	DAL
Tester	ETS364	ETS364
Test Number	EB672303	EB672303
Unit		
Max Limit	8	8
Min Limit	0	0

Krad	Serial #	Pre_HDR_6013	Post_HDR_6013	Delta
0	1	5.000	5.000	0.000
0	2	5.000	5.000	0.000
10	182	4.000	4.000	0.000
10	202	4.000	4.000	0.000
10	204	4.000	4.000	0.000
11	418	4.000	4.000	0.000
11	419	4.000	4.000	0.000
11	443	4.000	4.000	0.000
50	259	4.000	4.000	0.000
50	346	4.000	4.000	0.000
50	347	4.000	4.000	0.000
51	462	4.000	4.000	0.000
51	478	4.000	4.000	0.000
51	503	4.000	4.000	0.000
100	354	4.000	4.000	0.000
100	363	4.000	4.000	0.000
100	366	5.000	4.000	-1.000
100	383	4.000	4.000	0.000
100	417	4.000	4.000	0.000
101	513	4.000	4.000	0.000
101	526	5.000	4.000	-1.000
101	532	4.000	4.000	0.000
101	533	4.000	4.000	0.000
101	534	4.000	4.000	0.000
Max		5.000	5.000	0.000
Average		4.167	4.083	-0.083
Min		4.000	4.000	-1.000
Std Dev		0.381	0.282	0.282

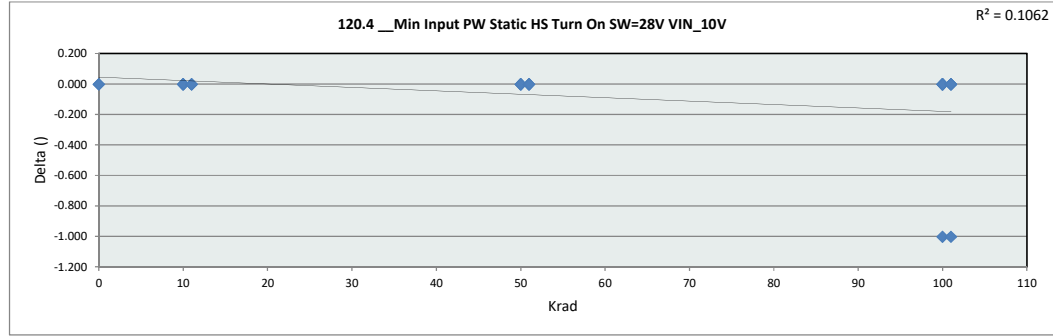

120.4 Min Input PW Static H	
Test Site	DAL
Tester	ETS364
Test Number	EB672303
Max Limit	8
Min Limit	0

	0	10	11	50	51	100	101
LL	0.000	0.000	0.000	0.000	0.000	0.000	0.000
Min	5.000	4.000	4.000	4.000	4.000	4.000	4.000
Average	5.000	4.000	4.000	4.000	4.000	4.000	4.000
Max	5.000	4.000	4.000	4.000	4.000	4.000	4.000
UL	8.000	8.000	8.000	8.000	8.000	8.000	8.000

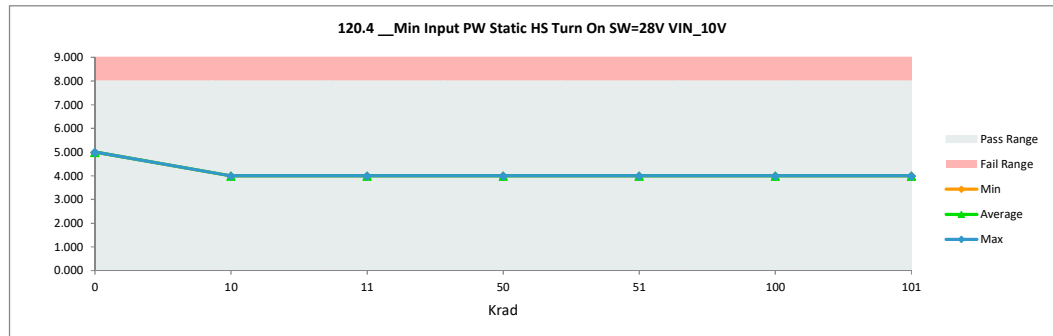

TID "HDR" Report
5962R2220102VXC

120.5 Min Input PW Static HS		
Test Site	DAL	DAL
Tester	ETS364	ETS364
Test Number	EB672303	EB672303
Unit		
Max Limit	12	12
Min Limit	0	0

Krad	Serial #	Pre_HDR_6013	Post_HDR_6013	Delta
0	1	6.000	6.000	0.000
0	2	7.000	7.000	0.000
10	182	7.000	7.000	0.000
10	202	6.000	6.000	0.000
10	204	6.000	6.000	0.000
11	418	7.000	7.000	0.000
11	419	6.000	6.000	0.000
11	443	7.000	7.000	0.000
50	259	6.000	6.000	0.000
50	346	6.000	6.000	0.000
50	347	6.000	6.000	0.000
51	462	6.000	7.000	1.000
51	478	7.000	7.000	0.000
51	503	7.000	6.000	-1.000
100	354	6.000	6.000	0.000
100	363	6.000	6.000	0.000
100	366	7.000	7.000	0.000
100	383	7.000	6.000	-1.000
100	417	6.000	6.000	0.000
101	513	7.000	7.000	0.000
101	526	7.000	7.000	0.000
101	532	7.000	6.000	-1.000
101	533	6.000	6.000	0.000
101	534	7.000	7.000	0.000
Max		7.000	7.000	1.000
Average		6.500	6.417	-0.083
Min		6.000	6.000	-1.000
Std Dev		0.511	0.504	0.408

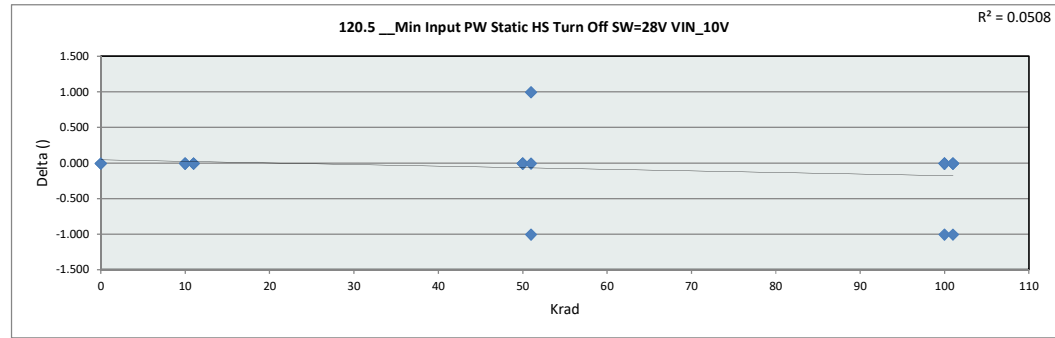

120.5 Min Input PW Static H	
Test Site	DAL
Tester	ETS364
Test Number	EB672303
Max Limit	12
Min Limit	0

Krad	0	10	11	50	51	100	101
LL	0.000	0.000	0.000	0.000	0.000	0.000	0.000
Min	6.000	6.000	6.000	6.000	6.000	6.000	6.000
Average	6.500	6.333	6.667	6.000	6.667	6.200	6.600
Max	7.000	7.000	7.000	6.000	7.000	7.000	7.000
UL	12.000	12.000	12.000	12.000	12.000	12.000	12.000

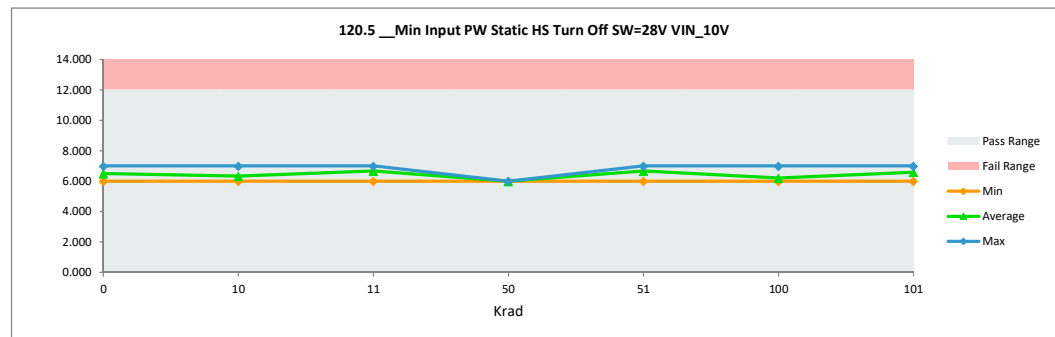

TID "HDR" Report
5962R2220102VXC

121.0 Min Input PW Static HS		
Test Site	DAL	DAL
Tester	ETS364	ETS364
Test Number	EB672303	EB672303
Unit		
Max Limit	8	8
Min Limit	0	0

Krad	Serial #	Pre_HDR_6013	Post_HDR_6013	Delta
0	1	5.000	5.000	0.000
0	2	5.000	5.000	0.000
10	182	4.000	4.000	0.000
10	202	4.000	4.000	0.000
10	204	4.000	4.000	0.000
11	418	4.000	4.000	0.000
11	419	4.000	4.000	0.000
11	443	4.000	4.000	0.000
50	259	4.000	4.000	0.000
50	346	4.000	4.000	0.000
50	347	4.000	4.000	0.000
51	462	4.000	4.000	0.000
51	478	4.000	4.000	0.000
51	503	4.000	4.000	0.000
100	354	4.000	4.000	0.000
100	363	4.000	4.000	0.000
100	366	5.000	4.000	-1.000
100	383	4.000	4.000	0.000
100	417	4.000	4.000	0.000
101	513	4.000	4.000	0.000
101	526	5.000	4.000	-1.000
101	532	4.000	4.000	0.000
101	533	4.000	4.000	0.000
101	534	4.000	4.000	0.000
Max		5.000	5.000	0.000
Average		4.167	4.083	-0.083
Min		4.000	4.000	-1.000
Std Dev		0.381	0.282	0.282

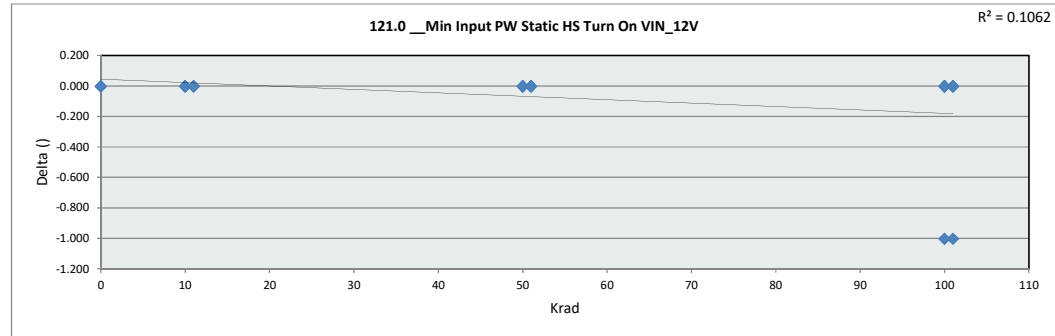

121.0 Min Input PW Static H	
Test Site	DAL
Tester	ETS364
Test Number	EB672303
Max Limit	8
Min Limit	0

	0	10	11	50	51	100	101
LL	0.000	0.000	0.000	0.000	0.000	0.000	0.000
Min	5.000	4.000	4.000	4.000	4.000	4.000	4.000
Average	5.000	4.000	4.000	4.000	4.000	4.000	4.000
Max	5.000	4.000	4.000	4.000	4.000	4.000	4.000
UL	8.000	8.000	8.000	8.000	8.000	8.000	8.000

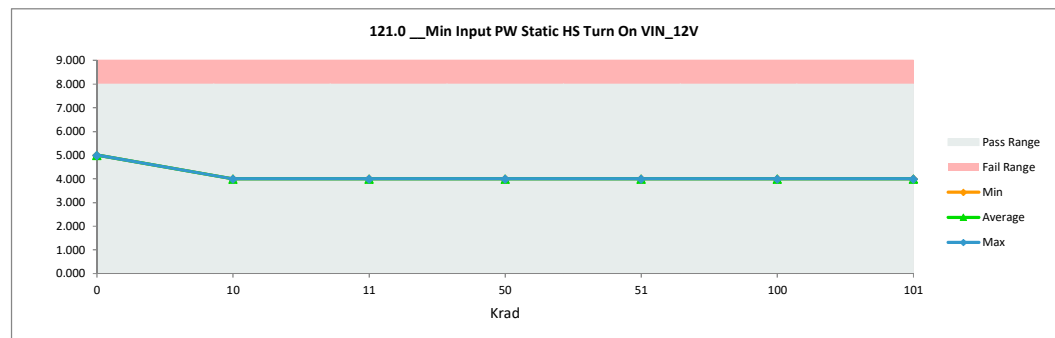

TID "HDR" Report
5962R2220102VXC

121.1 Min Input PW Static HS		
Test Site	DAL	DAL
Tester	ETS364	ETS364
Test Number	EB672303	EB672303
Unit		
Max Limit	12	12
Min Limit	0	0

Krad	Serial #	Pre_HDR_6013	Post_HDR_6013	Delta
0	1	6.000	6.000	0.000
0	2	7.000	7.000	0.000
10	182	7.000	7.000	0.000
10	202	6.000	6.000	0.000
10	204	6.000	6.000	0.000
11	418	7.000	7.000	0.000
11	419	6.000	6.000	0.000
11	443	7.000	7.000	0.000
50	259	6.000	6.000	0.000
50	346	6.000	6.000	0.000
50	347	6.000	6.000	0.000
51	462	6.000	7.000	1.000
51	478	7.000	7.000	0.000
51	503	7.000	7.000	0.000
100	354	6.000	6.000	0.000
100	363	6.000	6.000	0.000
100	366	7.000	7.000	0.000
100	383	7.000	6.000	-1.000
100	417	6.000	6.000	0.000
101	513	7.000	7.000	0.000
101	526	7.000	7.000	0.000
101	532	7.000	6.000	-1.000
101	533	6.000	6.000	0.000
101	534	7.000	7.000	0.000
Max		7.000	7.000	1.000
Average		6.500	6.458	-0.042
Min		6.000	6.000	-1.000
Std Dev		0.511	0.509	0.359

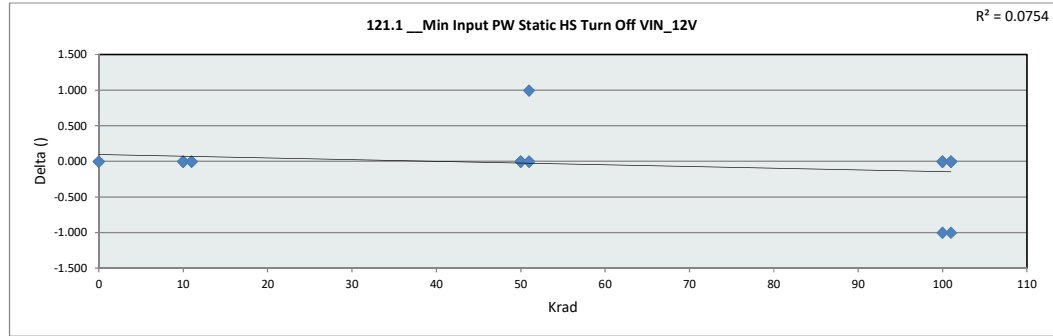

121.1 Min Input PW Static H	
Test Site	DAL
Tester	ETS364
Test Number	EB672303
Max Limit	12
Min Limit	0

	0	10	11	50	51	100	101
LL	0.000	0.000	0.000	0.000	0.000	0.000	0.000
Min	6.000	6.000	6.000	6.000	7.000	6.000	6.000
Average	6.500	6.333	6.667	6.000	7.000	6.200	6.600
Max	7.000	7.000	7.000	6.000	7.000	7.000	7.000
UL	12.000	12.000	12.000	12.000	12.000	12.000	12.000

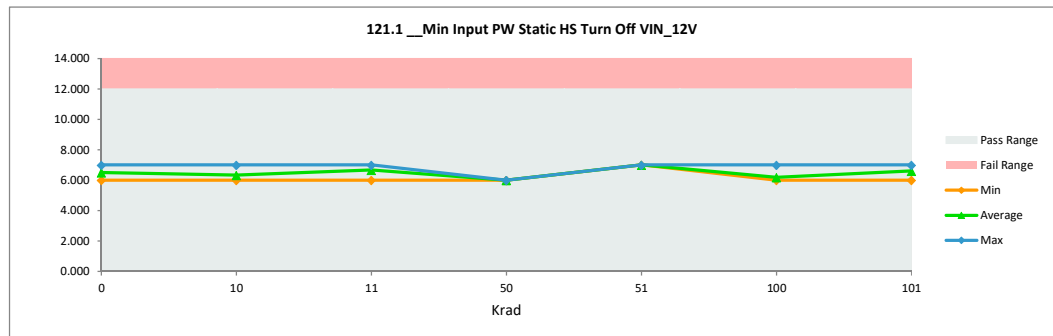

TID "HDR" Report
5962R2220102VXC

121.2 Min Input PW Static LS		
Test Site	DAL	DAL
Tester	ETS364	ETS364
Test Number	EB672303	EB672303
Unit		
Max Limit	8	8
Min Limit	0	0

Krad	Serial #	Pre_HDR_6013	Post_HDR_6013	Delta
0	1	4.000	4.000	0.000
0	2	4.000	4.000	0.000
10	182	4.000	4.000	0.000
10	202	4.000	4.000	0.000
10	204	4.000	4.000	0.000
11	418	4.000	4.000	0.000
11	419	4.000	4.000	0.000
11	443	4.000	4.000	0.000
50	259	4.000	4.000	0.000
50	346	4.000	4.000	0.000
50	347	4.000	4.000	0.000
51	462	4.000	4.000	0.000
51	478	4.000	4.000	0.000
51	503	4.000	4.000	0.000
100	354	4.000	4.000	0.000
100	363	4.000	4.000	0.000
100	366	4.000	4.000	0.000
100	383	4.000	4.000	0.000
100	417	4.000	4.000	0.000
101	513	4.000	4.000	0.000
101	526	4.000	4.000	0.000
101	532	4.000	4.000	0.000
101	533	4.000	4.000	0.000
101	534	4.000	4.000	0.000
Max		4.000	4.000	0.000
Average		4.000	4.000	0.000
Min		4.000	4.000	0.000
Std Dev		0.000	0.000	0.000

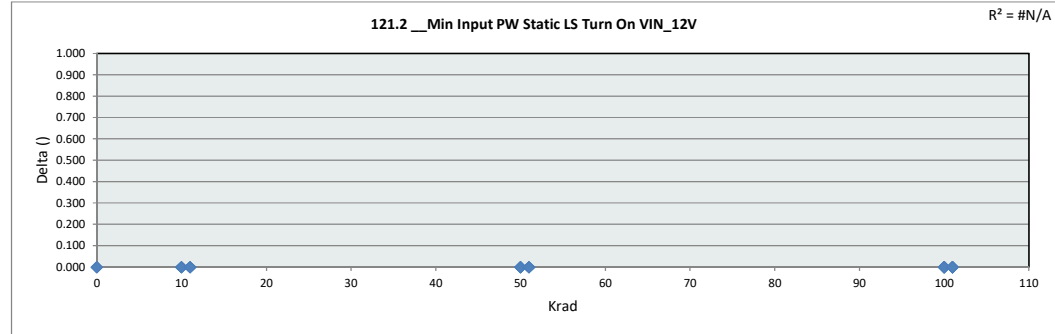

121.2 Min Input PW Static L	
Test Site	DAL
Tester	ETS364
Test Number	EB672303
Max Limit	8
Min Limit	0

	0	10	11	50	51	100	101
LL	0.000	0.000	0.000	0.000	0.000	0.000	0.000
Min	4.000	4.000	4.000	4.000	4.000	4.000	4.000
Average	4.000	4.000	4.000	4.000	4.000	4.000	4.000
Max	4.000	4.000	4.000	4.000	4.000	4.000	4.000
UL	8.000	8.000	8.000	8.000	8.000	8.000	8.000

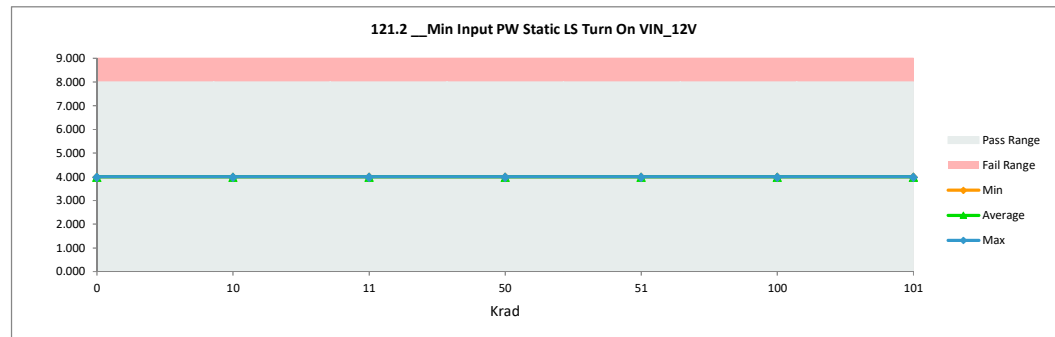

TID "HDR" Report
5962R2220102VXC

121.3 Min Input PW Static LS		
Test Site	DAL	DAL
Tester	ETS364	ETS364
Test Number	EB672303	EB672303
Unit		
Max Limit	12	12
Min Limit	0	0

Krad	Serial #	Pre_HDR_6013	Post_HDR_6013	Delta
0	1	6.000	6.000	0.000
0	2	6.000	6.000	0.000
10	182	6.000	6.000	0.000
10	202	6.000	6.000	0.000
10	204	5.000	6.000	1.000
11	418	6.000	6.000	0.000
11	419	5.000	6.000	1.000
11	443	5.000	6.000	1.000
50	259	6.000	6.000	0.000
50	346	6.000	6.000	0.000
50	347	6.000	6.000	0.000
51	462	6.000	6.000	0.000
51	478	5.000	6.000	1.000
51	503	6.000	6.000	0.000
100	354	6.000	5.000	-1.000
100	363	6.000	6.000	0.000
100	366	6.000	6.000	0.000
100	383	6.000	5.000	-1.000
100	417	6.000	6.000	0.000
101	513	6.000	6.000	0.000
101	526	6.000	6.000	0.000
101	532	6.000	6.000	0.000
101	533	6.000	6.000	0.000
101	534	6.000	6.000	0.000
Max		6.000	6.000	1.000
Average		5.833	5.917	0.083
Min		5.000	5.000	-1.000
Std Dev		0.381	0.282	0.504

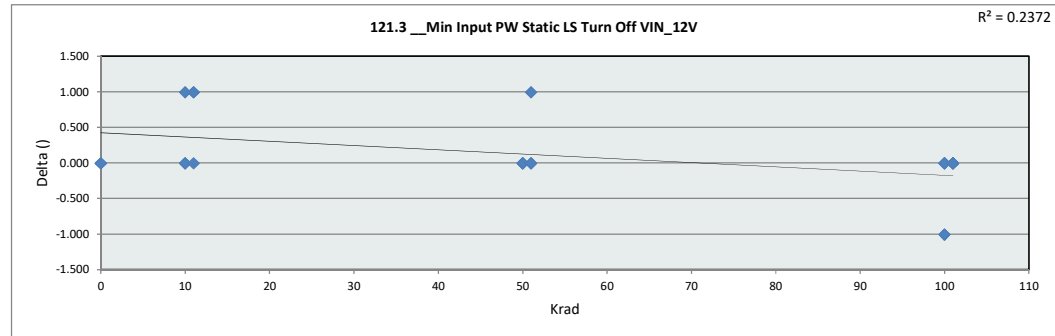

121.3 Min Input PW Static L	
Test Site	DAL
Tester	ETS364
Test Number	EB672303
Max Limit	12
Min Limit	0

Krad	0	10	11	50	51	100	101
LL	0.000	0.000	0.000	0.000	0.000	0.000	0.000
Min	6.000	6.000	6.000	6.000	6.000	5.000	6.000
Average	6.000	6.000	6.000	6.000	6.000	5.600	6.000
Max	6.000	6.000	6.000	6.000	6.000	6.000	6.000
UL	12.000	12.000	12.000	12.000	12.000	12.000	12.000

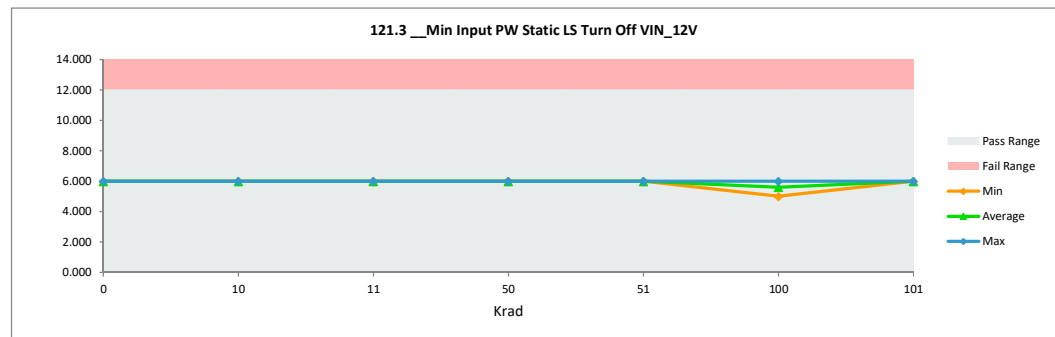

TID "HDR" Report
5962R2220102VXC

121.4 Min Input PW Static HS		
Test Site	DAL	DAL
Tester	ETS364	ETS364
Test Number	EB672303	EB672303
Unit		
Max Limit	8	8
Min Limit	0	0

Krad	Serial #	Pre_HDR_6013	Post_HDR_6013	Delta
0	1	5.000	5.000	0.000
0	2	5.000	5.000	0.000
10	182	4.000	4.000	0.000
10	202	4.000	4.000	0.000
10	204	4.000	4.000	0.000
11	418	4.000	4.000	0.000
11	419	4.000	4.000	0.000
11	443	4.000	4.000	0.000
50	259	4.000	4.000	0.000
50	346	4.000	4.000	0.000
50	347	4.000	4.000	0.000
51	462	4.000	4.000	0.000
51	478	4.000	4.000	0.000
51	503	4.000	4.000	0.000
100	354	4.000	4.000	0.000
100	363	4.000	4.000	0.000
100	366	5.000	4.000	-1.000
100	383	4.000	4.000	0.000
100	417	4.000	4.000	0.000
101	513	4.000	4.000	0.000
101	526	5.000	4.000	-1.000
101	532	4.000	4.000	0.000
101	533	4.000	4.000	0.000
101	534	4.000	4.000	0.000
Max		5.000	5.000	0.000
Average		4.167	4.083	-0.083
Min		4.000	4.000	-1.000
Std Dev		0.381	0.282	0.282

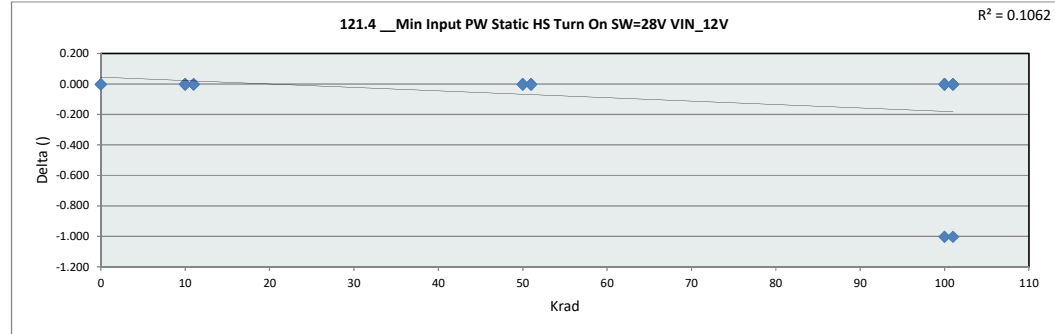

121.4 Min Input PW Static H	
Test Site	DAL
Tester	ETS364
Test Number	EB672303
Max Limit	8
Min Limit	0

Krad	0	10	11	50	51	100	101
LL	0.000	0.000	0.000	0.000	0.000	0.000	0.000
Min	5.000	4.000	4.000	4.000	4.000	4.000	4.000
Average	5.000	4.000	4.000	4.000	4.000	4.000	4.000
Max	5.000	4.000	4.000	4.000	4.000	4.000	4.000
UL	8.000	8.000	8.000	8.000	8.000	8.000	8.000

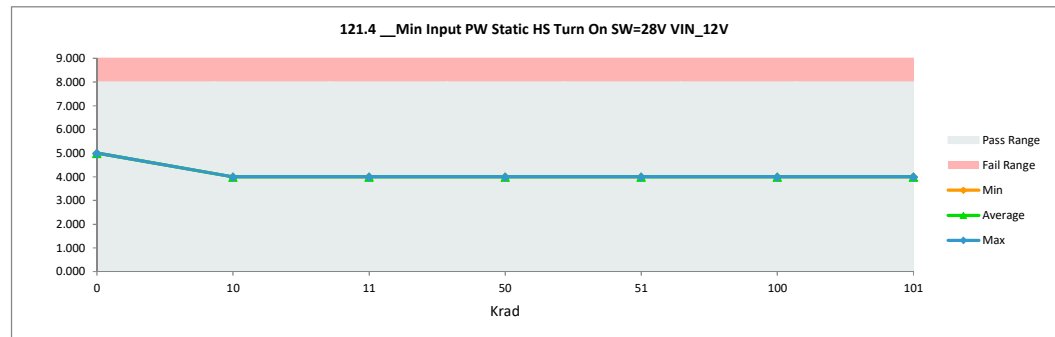

TID "HDR" Report
5962R2220102VXC

121.5 Min Input PW Static HS		
Test Site	DAL	DAL
Tester	ETS364	ETS364
Test Number	EB672303	EB672303
Unit		
Max Limit	12	12
Min Limit	0	0

Krad	Serial #	Pre_HDR_6013	Post_HDR_6013	Delta
0	1	6.000	6.000	0.000
0	2	7.000	7.000	0.000
10	182	7.000	7.000	0.000
10	202	6.000	6.000	0.000
10	204	6.000	6.000	0.000
11	418	7.000	7.000	0.000
11	419	6.000	6.000	0.000
11	443	7.000	7.000	0.000
50	259	6.000	6.000	0.000
50	346	6.000	6.000	0.000
50	347	6.000	6.000	0.000
51	462	6.000	6.000	0.000
51	478	7.000	7.000	0.000
51	503	7.000	7.000	0.000
100	354	6.000	6.000	0.000
100	363	6.000	6.000	0.000
100	366	7.000	7.000	0.000
100	383	7.000	7.000	0.000
100	417	6.000	6.000	0.000
101	513	7.000	7.000	0.000
101	526	7.000	7.000	0.000
101	532	7.000	6.000	-1.000
101	533	6.000	6.000	0.000
101	534	7.000	7.000	0.000
Max		7.000	7.000	0.000
Average		6.500	6.458	-0.042
Min		6.000	6.000	-1.000
Std Dev		0.511	0.509	0.204

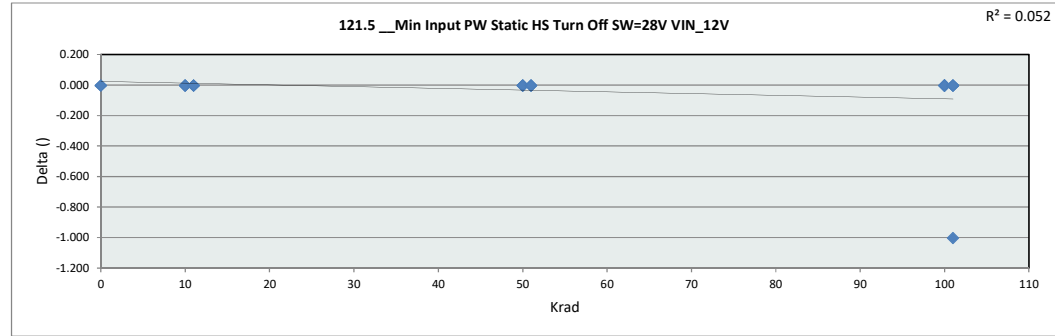

121.5 Min Input PW Static H	
Test Site	DAL
Tester	ETS364
Test Number	EB672303
Max Limit	12
Min Limit	0

	0	10	11	50	51	100	101
LL	0.000	0.000	0.000	0.000	0.000	0.000	0.000
Min	6.000	6.000	6.000	6.000	6.000	6.000	6.000
Average	6.500	6.333	6.667	6.000	6.667	6.400	6.600
Max	7.000	7.000	7.000	6.000	7.000	7.000	7.000
UL	12.000	12.000	12.000	12.000	12.000	12.000	12.000

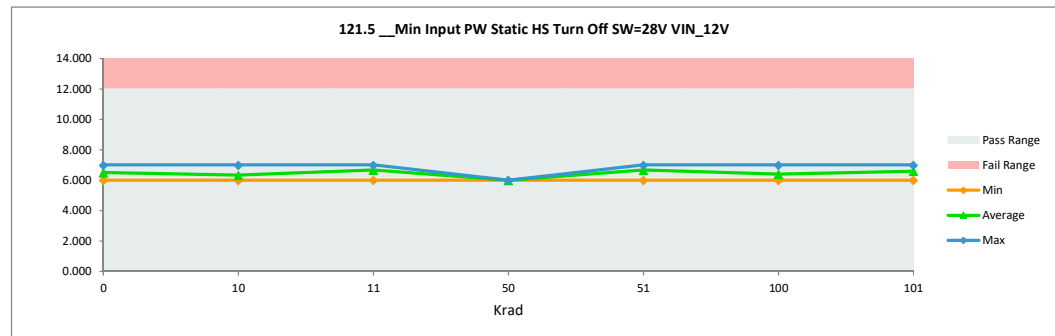

TID "HDR" Report
5962R2220102VXC

122.0 Min Input PW Static HS		
Test Site	DAL	DAL
Tester	ETS364	ETS364
Test Number	EB672303	EB672303
Unit		
Max Limit	8	8
Min Limit	0	0

Krad	Serial #	Pre_HDR_6013	Post_HDR_6013	Delta
0	1	5.000	5.000	0.000
0	2	5.000	5.000	0.000
10	182	4.000	4.000	0.000
10	202	4.000	4.000	0.000
10	204	4.000	4.000	0.000
11	418	4.000	4.000	0.000
11	419	4.000	4.000	0.000
11	443	4.000	4.000	0.000
50	259	4.000	4.000	0.000
50	346	4.000	4.000	0.000
50	347	4.000	4.000	0.000
51	462	4.000	4.000	0.000
51	478	4.000	4.000	0.000
51	503	4.000	4.000	0.000
100	354	4.000	4.000	0.000
100	363	4.000	4.000	0.000
100	366	5.000	4.000	-1.000
100	383	4.000	4.000	0.000
100	417	4.000	4.000	0.000
101	513	4.000	4.000	0.000
101	526	5.000	4.000	-1.000
101	532	4.000	4.000	0.000
101	533	4.000	4.000	0.000
101	534	4.000	4.000	0.000
Max		5.000	5.000	0.000
Average		4.167	4.083	-0.083
Min		4.000	4.000	-1.000
Std Dev		0.381	0.282	0.282

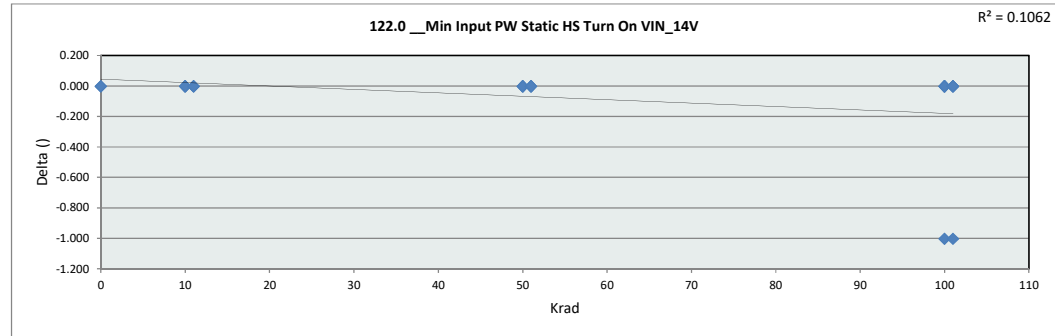

122.0 Min Input PW Static H	
Test Site	DAL
Tester	ETS364
Test Number	EB672303
Max Limit	8
Min Limit	0

	0	10	11	50	51	100	101
LL	0.000	0.000	0.000	0.000	0.000	0.000	0.000
Min	5.000	4.000	4.000	4.000	4.000	4.000	4.000
Average	5.000	4.000	4.000	4.000	4.000	4.000	4.000
Max	5.000	4.000	4.000	4.000	4.000	4.000	4.000
UL	8.000	8.000	8.000	8.000	8.000	8.000	8.000

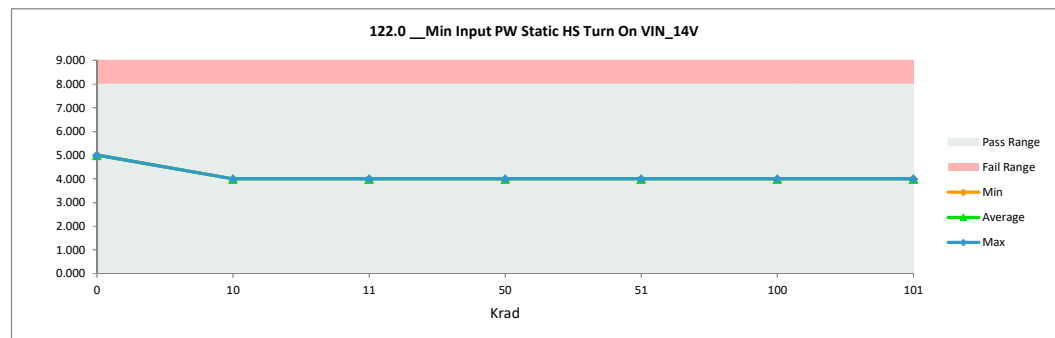

TID "HDR" Report
5962R2220102VXC

122.1 Min Input PW Static HS		
Test Site	DAL	DAL
Tester	ETS364	ETS364
Test Number	EB672303	EB672303
Unit		
Max Limit	12	12
Min Limit	0	0

Krad	Serial #	Pre_HDR_6013	Post_HDR_6013	Delta
0	1	6.000	6.000	0.000
0	2	7.000	7.000	0.000
10	182	7.000	7.000	0.000
10	202	6.000	6.000	0.000
10	204	6.000	6.000	0.000
11	418	7.000	7.000	0.000
11	419	6.000	6.000	0.000
11	443	7.000	7.000	0.000
50	259	6.000	6.000	0.000
50	346	6.000	6.000	0.000
50	347	6.000	6.000	0.000
51	462	6.000	7.000	1.000
51	478	7.000	7.000	0.000
51	503	7.000	6.000	-1.000
100	354	6.000	6.000	0.000
100	363	6.000	6.000	0.000
100	366	7.000	7.000	0.000
100	383	7.000	6.000	-1.000
100	417	6.000	6.000	0.000
101	513	7.000	7.000	0.000
101	526	7.000	7.000	0.000
101	532	7.000	6.000	-1.000
101	533	6.000	6.000	0.000
101	534	7.000	7.000	0.000
Max		7.000	7.000	1.000
Average		6.500	6.417	-0.083
Min		6.000	6.000	-1.000
Std Dev		0.511	0.504	0.408

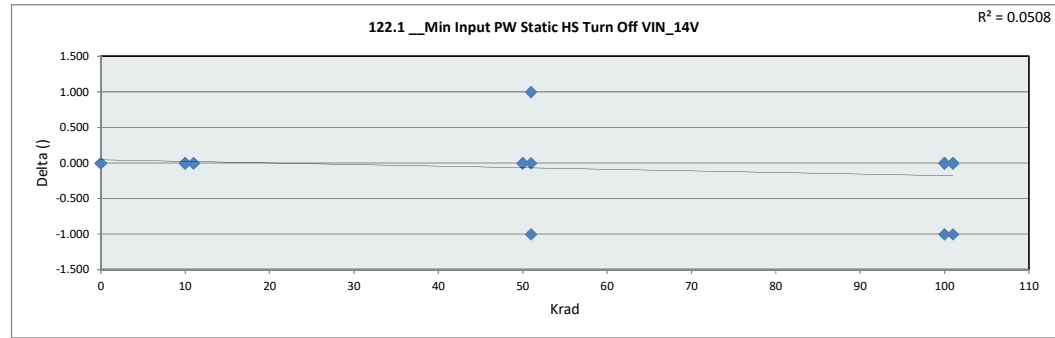

122.1 Min Input PW Static H	
Test Site	DAL
Tester	ETS364
Test Number	EB672303
Max Limit	12
Min Limit	0

Krad	0	10	11	50	51	100	101
LL	0.000	0.000	0.000	0.000	0.000	0.000	0.000
Min	6.000	6.000	6.000	6.000	6.000	6.000	6.000
Average	6.500	6.333	6.667	6.000	6.667	6.200	6.600
Max	7.000	7.000	7.000	6.000	7.000	7.000	7.000
UL	12.000	12.000	12.000	12.000	12.000	12.000	12.000

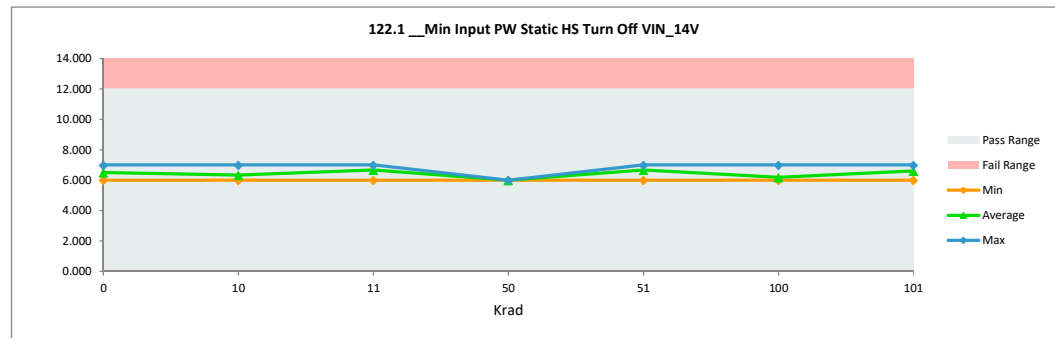

TID "HDR" Report
5962R2220102VXC

122.2 Min Input PW Static LS		
Test Site	DAL	DAL
Tester	ETS364	ETS364
Test Number	EB672303	EB672303
Unit		
Max Limit	8	8
Min Limit	0	0

Krad	Serial #	Pre_HDR_6013	Post_HDR_6013	Delta
0	1	4.000	4.000	0.000
0	2	4.000	4.000	0.000
10	182	4.000	4.000	0.000
10	202	4.000	4.000	0.000
10	204	4.000	4.000	0.000
11	418	4.000	4.000	0.000
11	419	4.000	4.000	0.000
11	443	4.000	4.000	0.000
50	259	4.000	4.000	0.000
50	346	4.000	4.000	0.000
50	347	4.000	4.000	0.000
51	462	4.000	4.000	0.000
51	478	4.000	4.000	0.000
51	503	4.000	4.000	0.000
100	354	4.000	4.000	0.000
100	363	4.000	4.000	0.000
100	366	4.000	4.000	0.000
100	383	4.000	4.000	0.000
100	417	4.000	4.000	0.000
101	513	4.000	4.000	0.000
101	526	4.000	4.000	0.000
101	532	4.000	4.000	0.000
101	533	4.000	4.000	0.000
101	534	4.000	4.000	0.000
Max		4.000	4.000	0.000
Average		4.000	4.000	0.000
Min		4.000	4.000	0.000
Std Dev		0.000	0.000	0.000

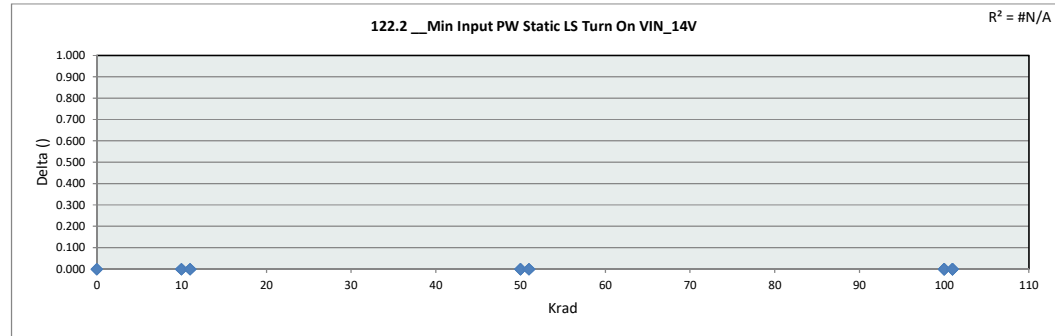

122.2 Min Input PW Static L	
Test Site	DAL
Tester	ETS364
Test Number	EB672303
Max Limit	8
Min Limit	0

	0	10	11	50	51	100	101
LL	0.000	0.000	0.000	0.000	0.000	0.000	0.000
Min	4.000	4.000	4.000	4.000	4.000	4.000	4.000
Average	4.000	4.000	4.000	4.000	4.000	4.000	4.000
Max	4.000	4.000	4.000	4.000	4.000	4.000	4.000
UL	8.000	8.000	8.000	8.000	8.000	8.000	8.000

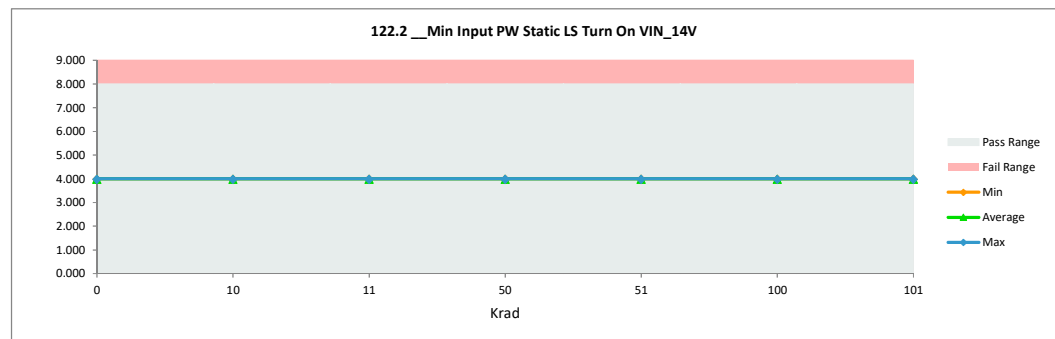

TID "HDR" Report 5962R2220102VXC

122.3 Min Input PW Static LS		
Test Site	DAL	DAL
Tester	ETS364	ETS364
Test Number	EB672303	EB672303
Unit		
Max Limit	12	12
Min Limit	0	0

Krad	Serial #	Pre_HDR_6013	Post_HDR_6013	Delta
0	1	6.000	6.000	0.000
0	2	6.000	6.000	0.000
10	182	6.000	6.000	0.000
10	202	6.000	6.000	0.000
10	204	5.000	6.000	1.000
11	418	6.000	6.000	0.000
11	419	5.000	6.000	1.000
11	443	5.000	6.000	1.000
50	259	6.000	6.000	0.000
50	346	6.000	6.000	0.000
50	347	6.000	6.000	0.000
51	462	6.000	6.000	0.000
51	478	5.000	6.000	1.000
51	503	6.000	6.000	0.000
100	354	6.000	5.000	-1.000
100	363	6.000	6.000	0.000
100	366	6.000	6.000	0.000
100	383	6.000	5.000	-1.000
100	417	6.000	6.000	0.000
101	513	6.000	6.000	0.000
101	526	6.000	6.000	0.000
101	532	6.000	6.000	0.000
101	533	6.000	6.000	0.000
101	534	6.000	6.000	0.000
Max		6.000	6.000	1.000
Average		5.833	5.917	0.083
Min		5.000	5.000	-1.000
Std Dev		0.381	0.282	0.504

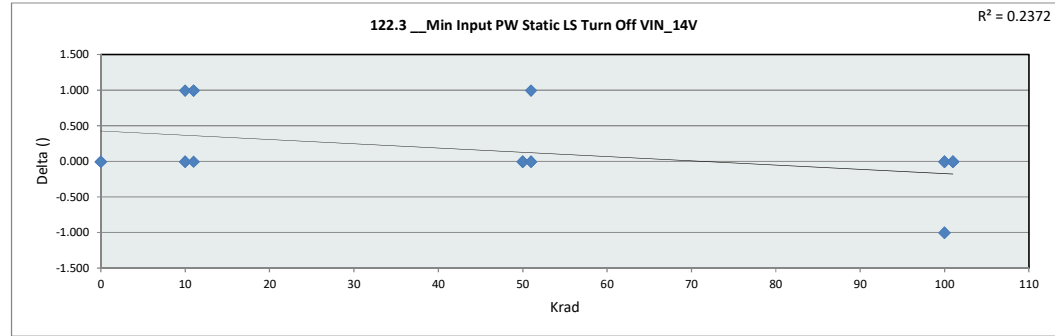

122.3 Min Input PW Static L	
Test Site	DAL
Tester	ETS364
Test Number	EB672303
Max Limit	12
Min Limit	0

	0	10	11	50	51	100	101
LL	0.000	0.000	0.000	0.000	0.000	0.000	0.000
Min	6.000	6.000	6.000	6.000	6.000	5.000	6.000
Average	6.000	6.000	6.000	6.000	6.000	5.600	6.000
Max	6.000	6.000	6.000	6.000	6.000	6.000	6.000
UL	12.000	12.000	12.000	12.000	12.000	12.000	12.000

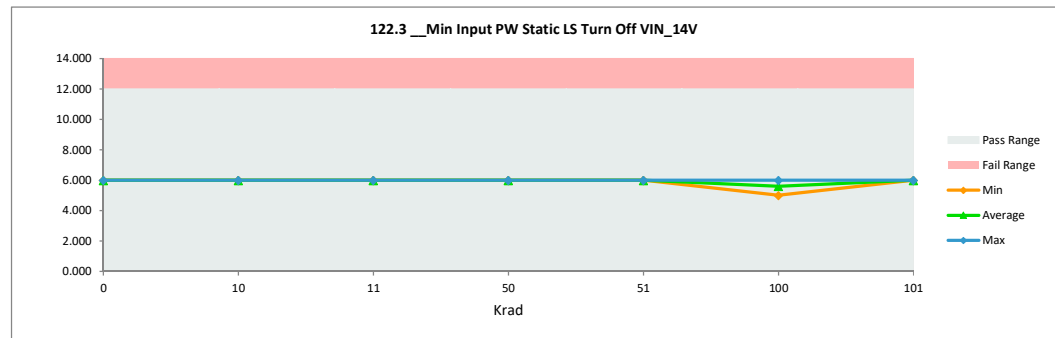

TID "HDR" Report
5962R2220102VXC

122.4 Min Input PW Static HS		
Test Site	DAL	DAL
Tester	ETS364	ETS364
Test Number	EB672303	EB672303
Unit		
Max Limit	8	8
Min Limit	0	0

Krad	Serial #	Pre_HDR_6013	Post_HDR_6013	Delta
0	1	5.000	5.000	0.000
0	2	5.000	5.000	0.000
10	182	4.000	4.000	0.000
10	202	4.000	4.000	0.000
10	204	4.000	4.000	0.000
11	418	4.000	4.000	0.000
11	419	4.000	4.000	0.000
11	443	4.000	4.000	0.000
50	259	4.000	4.000	0.000
50	346	4.000	4.000	0.000
50	347	4.000	4.000	0.000
51	462	4.000	4.000	0.000
51	478	4.000	4.000	0.000
51	503	4.000	4.000	0.000
100	354	4.000	4.000	0.000
100	363	4.000	4.000	0.000
100	366	5.000	4.000	-1.000
100	383	4.000	4.000	0.000
100	417	4.000	4.000	0.000
101	513	4.000	4.000	0.000
101	526	5.000	4.000	-1.000
101	532	4.000	4.000	0.000
101	533	4.000	4.000	0.000
101	534	4.000	4.000	0.000
Max		5.000	5.000	0.000
Average		4.167	4.083	-0.083
Min		4.000	4.000	-1.000
Std Dev		0.381	0.282	0.282

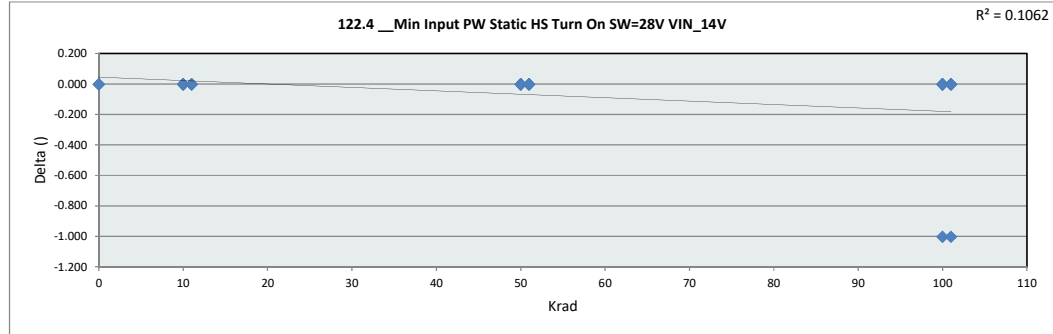

122.4 Min Input PW Static H	
Test Site	DAL
Tester	ETS364
Test Number	EB672303
Max Limit	8
Min Limit	0

	0	10	11	50	51	100	101
LL	0.000	0.000	0.000	0.000	0.000	0.000	0.000
Min	5.000	4.000	4.000	4.000	4.000	4.000	4.000
Average	5.000	4.000	4.000	4.000	4.000	4.000	4.000
Max	5.000	4.000	4.000	4.000	4.000	4.000	4.000
UL	8.000	8.000	8.000	8.000	8.000	8.000	8.000

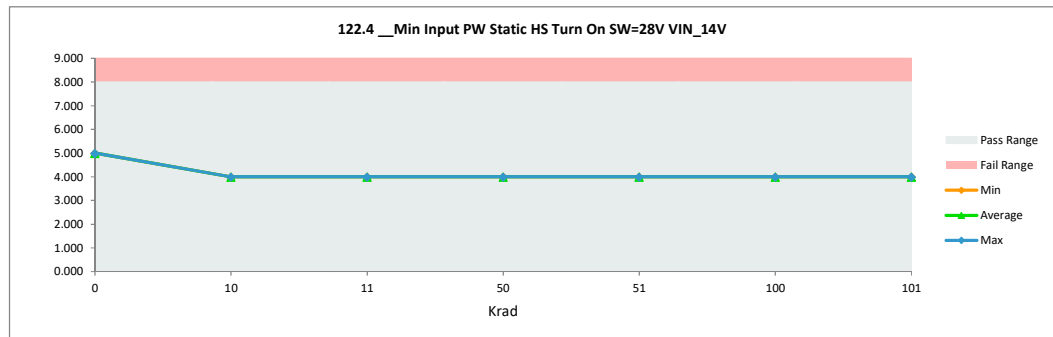

TID "HDR" Report
5962R2220102VXC

122.5 Min Input PW Static HS		
Test Site	DAL	DAL
Tester	ETS364	ETS364
Test Number	EB672303	EB672303
Unit		
Max Limit	12	12
Min Limit	0	0

Krad	Serial #	Pre_HDR_6013	Post_HDR_6013	Delta
0	1	6.000	6.000	0.000
0	2	7.000	7.000	0.000
10	182	7.000	7.000	0.000
10	202	6.000	6.000	0.000
10	204	6.000	6.000	0.000
11	418	7.000	7.000	0.000
11	419	6.000	6.000	0.000
11	443	7.000	7.000	0.000
50	259	6.000	6.000	0.000
50	346	6.000	6.000	0.000
50	347	6.000	6.000	0.000
51	462	6.000	7.000	1.000
51	478	7.000	7.000	0.000
51	503	7.000	7.000	0.000
100	354	6.000	6.000	0.000
100	363	6.000	6.000	0.000
100	366	7.000	7.000	0.000
100	383	7.000	6.000	-1.000
100	417	6.000	6.000	0.000
101	513	7.000	7.000	0.000
101	526	7.000	7.000	0.000
101	532	6.000	6.000	0.000
101	533	6.000	6.000	0.000
101	534	7.000	7.000	0.000
Max		7.000	7.000	1.000
Average		6.458	6.458	0.000
Min		6.000	6.000	-1.000
Std Dev		0.509	0.509	0.295

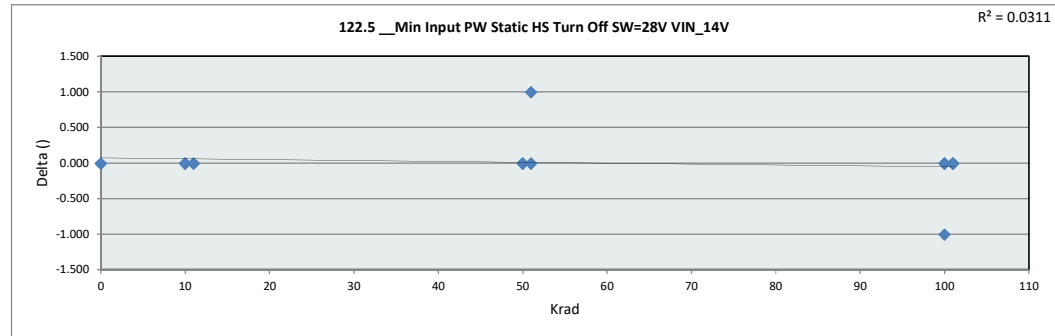

122.5 Min Input PW Static H	
Test Site	DAL
Tester	ETS364
Test Number	EB672303
Max Limit	12
Min Limit	0

Krad	0	10	11	50	51	100	101
LL	0.000	0.000	0.000	0.000	0.000	0.000	0.000
Min	6.000	6.000	6.000	6.000	7.000	6.000	6.000
Average	6.500	6.333	6.667	6.000	7.000	6.200	6.600
Max	7.000	7.000	7.000	6.000	7.000	7.000	7.000
UL	12.000	12.000	12.000	12.000	12.000	12.000	12.000

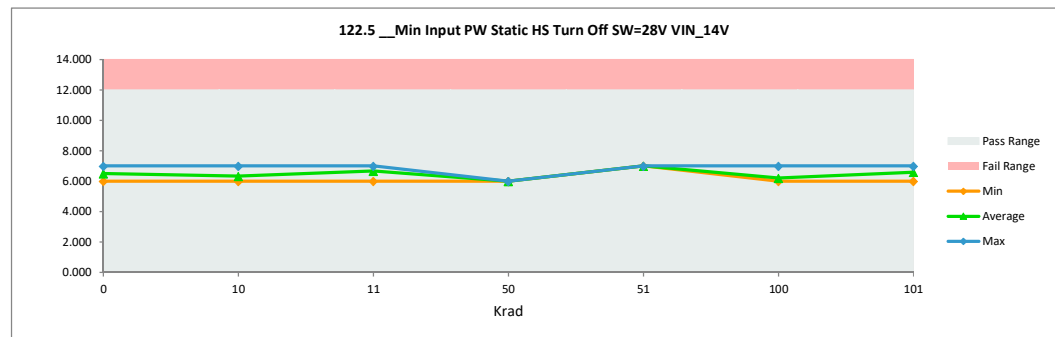

IMPORTANT NOTICE AND DISCLAIMER

TI PROVIDES TECHNICAL AND RELIABILITY DATA (INCLUDING DATA SHEETS), DESIGN RESOURCES (INCLUDING REFERENCE DESIGNS), APPLICATION OR OTHER DESIGN ADVICE, WEB TOOLS, SAFETY INFORMATION, AND OTHER RESOURCES "AS IS" AND WITH ALL FAULTS, AND DISCLAIMS ALL WARRANTIES, EXPRESS AND IMPLIED, INCLUDING WITHOUT LIMITATION ANY IMPLIED WARRANTIES OF MERCHANTABILITY, FITNESS FOR A PARTICULAR PURPOSE OR NON-INFRINGEMENT OF THIRD PARTY INTELLECTUAL PROPERTY RIGHTS.

These resources are intended for skilled developers designing with TI products. You are solely responsible for (1) selecting the appropriate TI products for your application, (2) designing, validating and testing your application, and (3) ensuring your application meets applicable standards, and any other safety, security, regulatory or other requirements.

These resources are subject to change without notice. TI grants you permission to use these resources only for development of an application that uses the TI products described in the resource. Other reproduction and display of these resources is prohibited. No license is granted to any other TI intellectual property right or to any third party intellectual property right. TI disclaims responsibility for, and you will fully indemnify TI and its representatives against, any claims, damages, costs, losses, and liabilities arising out of your use of these resources.

TI's products are provided subject to [TI's Terms of Sale](#) or other applicable terms available either on [ti.com](https://www.ti.com) or provided in conjunction with such TI products. TI's provision of these resources does not expand or otherwise alter TI's applicable warranties or warranty disclaimers for TI products.

TI objects to and rejects any additional or different terms you may have proposed.

Mailing Address: Texas Instruments, Post Office Box 655303, Dallas, Texas 75265
Copyright © 2024, Texas Instruments Incorporated