

EVM User's Guide: TMP118EVM

TMP118 Evaluation Module



Description

The TMP118EVM is designed to provide a quick setup to evaluate the TMP118 device and gain familiarity with the device down to the bit-by-bit register level. The EVM allows users to evaluate the performance of the TMP118 digital temperature sensor. The TMP118EVM is split into two parts, an FR4-based motherboard containing the Microcontroller, USB and breakable section with Flexible Printed Circuit (FPC) connector for the sensor board. The second portion features an FPC board containing the TMP118 sensor to showcase the sensor's competitive thermal response time.

Get Started

1. Order the TMP118EVM on ti.com
2. Attach TMP118 Sensor Board to MCU Board via FPC Connector
3. Detach breakable FPC connector section and solder connections (optional)
4. Connect the EVM to computer or user system
5. Go to the TMP118EVM gallery page on dev.ti.com to either download the GUI or run online
6. Refer to the [TMP118](#) data sheet for IC details
7. Visit our [E2E forums](#) for support or questions

Features

- Straightforward application to check temperature functionality of TMP118
- Easy to use cloud-based [GUI](#) is available on the web or can be downloaded for offline use
- FPC Based Design with breakable section for FPC connector and TMP118 sensor board.
- Access to data logging, adjusting the I2C frequency, and modifying data in registers
- Software powered by GUI Composer runs in a browser on Windows®, Mac®, and Linux® operating systems

Applications

- [Wearable fitness and activity monitors](#)
 - [Watches](#)
 - [Sport bands](#)
 - [TWS ear buds](#)
 - [Smart glasses](#)
- [Medical equipment](#)
- [Gas meters and heat meters](#)
- [Probe assemblies](#)
- [Temperature transmitters](#)

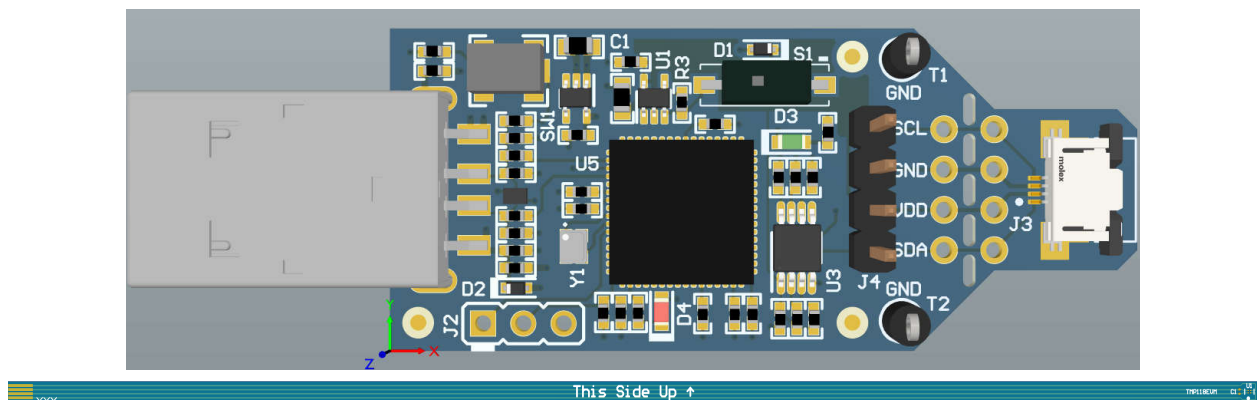

TMP118EVM

1 Evaluation Module Overview

1.1 Introduction

The EVM comes in a USB stick form factor, with an onboard MSP430F5528 microcontroller that interfaces with both the host computer and the TMP118 device. The TMP118 device is attached to a FPC board, which connects to the host board via FPC Connector. The perforations between the FPC Connector and host controller allows the user flexibility during evaluation:

- The user can connect the TMP118 to the user's system or host.
- The user can connect the EVM host and software to the user's system with TMP118 devices.
- Longer, flexible boards allow the user to place sensors in the user's system without compromising response time.
- Hole spacing is compatible with common 0.1 inch prototyping breadboards.

This user's guide describes the characteristics, operation, and use of the TMP118 evaluation module (EVM). A complete schematic diagram, printed-circuit board layouts, and bill of materials are included in this document. This user's guide details through the steps to operate the TMP118 evaluation module.

1.2 Kit Contents

[Table 1-1](#) details the contents of the EVM kit. Contact the nearest Texas Instruments Product Information Center for missing components. TI highly recommends checking the TI [website](#) for the latest revision.

Table 1-1. Kit Contents

Item	Quantity
TMP118EVM	1

1.3 Specification

[Table 1-2](#) defines the absolute maximum thermal conditions of each section of the EVM. This EVM is broken up into two sections: an MCU board and the FPC sensor board. The following limits must be considered when evaluating the performance of the device at extreme temperatures. In this case, if the setup conditions exceed the controller absolute maximum thermal specifications, then the breakable connector section must be detached so that only the sensor (and not the MCU) is evaluated at these temperatures.

Table 1-2. TMP118 Temperature Limits

BOARD SECTION	CONDITIONS	TEMPERATURE RANGE
Controller board	Recommended operating free-air temperature, T_A	-40°C to 85°C
	Absolute maximum junction temperature, $T_J(MAX)$	95°C
TMP118 FPC Board	Recommended operating free-air temperature, T_A	-55°C to 150°C

1.4 Device Information

The TMP118 is a digital output temperature sensor that is calibrated in production to achieve high accuracy in a small PICOSTAR package. This device communicates in a two-wire environment compatible with SMBus and I2C interfaces. The device can be set to make continuous or one-shot conversions and can be ordered with additional address options. The compact package of this EVM allows to better showcase a fast thermal response time. For more information of the IC, refer to the device data sheet ([SNIS237](#)). [Table 1-3](#) includes some of the parameters of interest of the TMP118 to consider when using this EVM.

Table 1-3. Device Specifications

Device Specification	Value
Operating temperature range	-50°C to 125°C
Temperature accuracy (0°C to 65°C)	0.1
Temperature accuracy (-20°C to 85°C)	0.2
Temperature accuracy (-40°C to 125°C)	0.5
Operating supply range	1.4V to 5.5V

2 Hardware

2.1 Overview

The EVM is divided into three sections: the controller section, the breakable FPC Connector section and the FPC Board containing the TMP118 sensor. The breakable sensor portion can be detached to use the sensor in the following scenarios:

- Using the sensor in a high temperature environment by soldering wires to the connector section and connecting to the MCU board via soldered wires or the available 0.1" header pins to retain GUI functionality.
- Using the sensor section with the user's system by interfacing through I2C with the TMP118.
- Using the controller section with TMP118 sensors in the user's system.
- Using the TMP118 Sensor board and breakable FPC connector section to directly implement into user system.

The figure below highlights the EVM sections as well as some components that must be identified by the user to understand the purpose and use. The components are further explained in detail in the sections below.

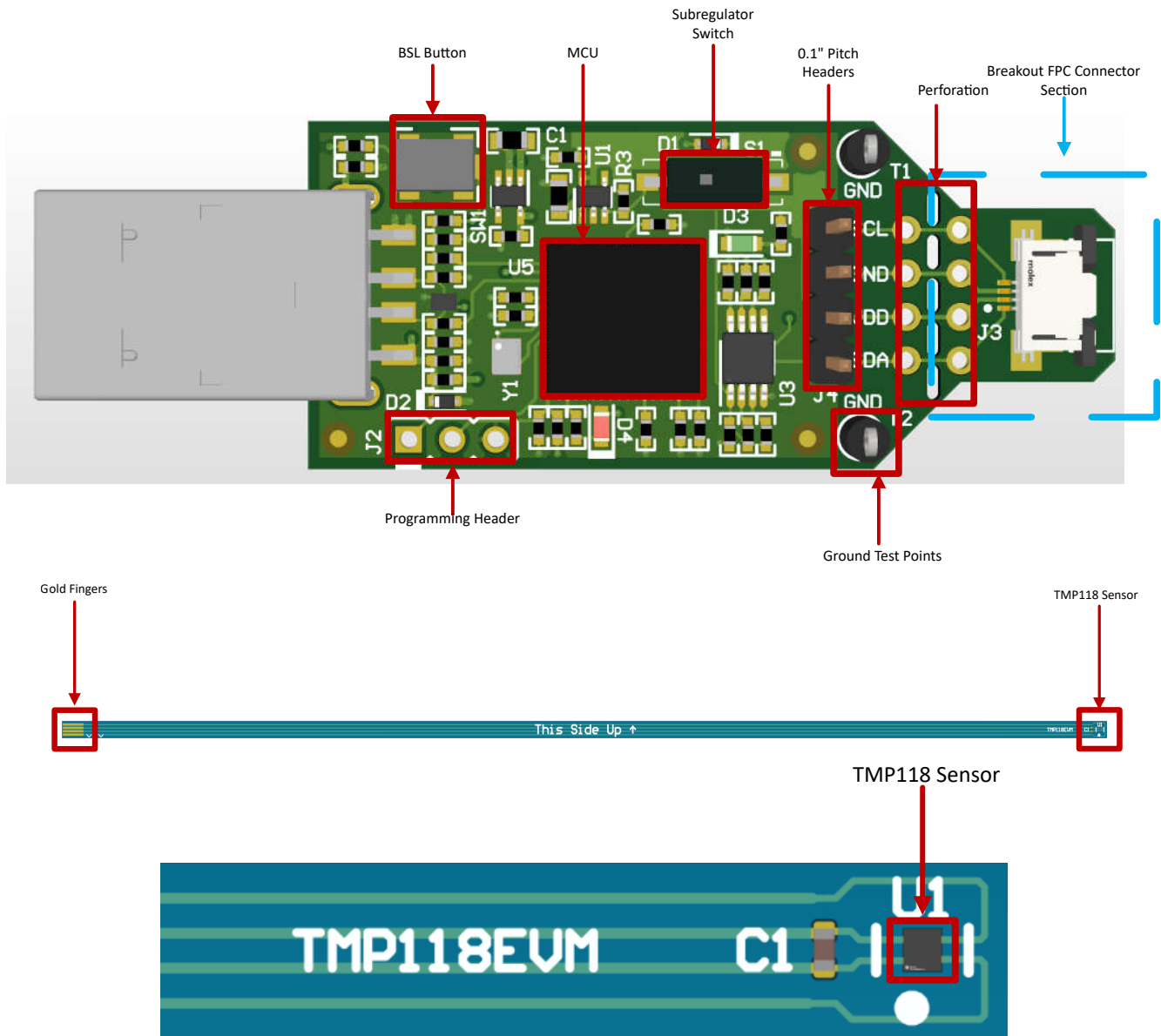

Figure 2-1. TMP118EVM Board Sections

2.1.1 Connecting FPC Sensor Board to Controller Board

The following is a quick guide to connecting the TMP118EVM FPC Sensor Board to the Controller board.

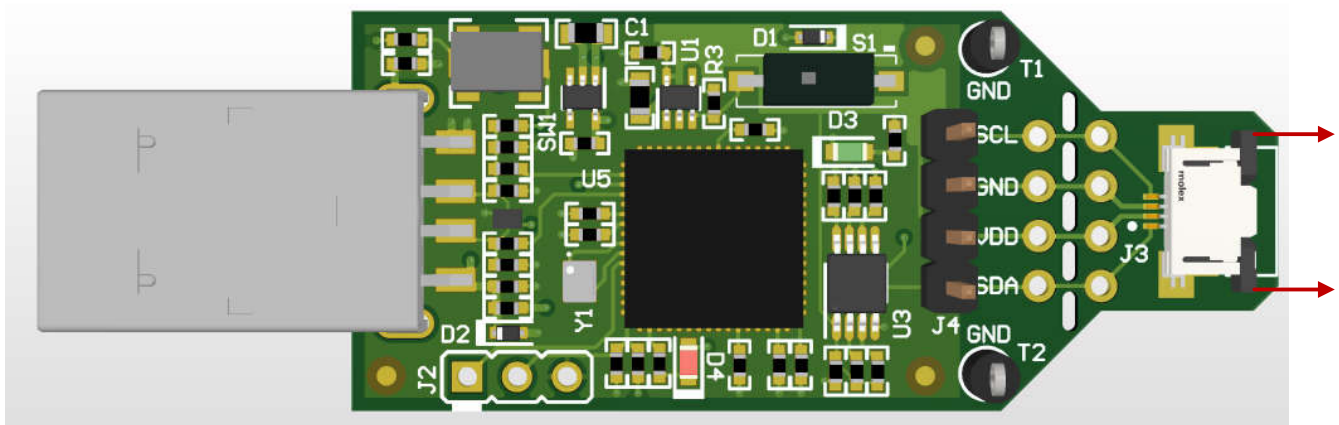
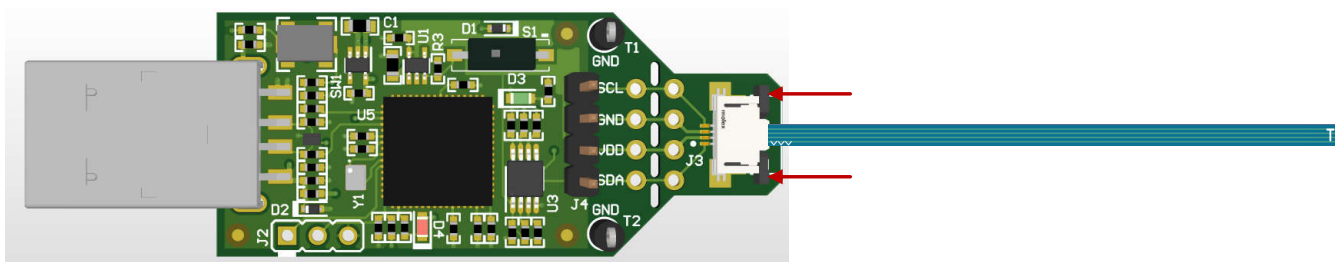

Figure 2-2. Unlocking FPC Connector



Figure 2-3. Inserting FPC Board and Locking Connector



2.2 Perforations and Connectivity

The perforation between the USB controller and TMP118 FPC connector section is labeled on both sides for pin connections. Once the sensor section is detached from the controller section, the user can interface with the sensor section in two different ways:

- Soldering wires or 0.1" header connectors: With this approach, the user has access to all pins of the device.

Note

Pullup resistors and protection diodes are on the controller section. Thus, when interfacing with other controller boards, TI recommends to verify that pullup resistors and protection circuitry are present on any controller board for safe and proper functionality.

2.3 Status LEDs and Subregulator

The switch S1 enables and disables the onboard 1.8V regulator, U5. When the subregulator is enabled, the green LED D3 illuminates. The subregulator must be enabled for normal operation of TMP118EVM as the subregulator supplies power to the device and pullup voltage of the communication lines.

The red LED D4 is the MSP430F5528 status LED. [Table 2-1](#) shows how the different modes of operation are displayed by the LED status.

Table 2-1. Status LED Mode of Operation

D4 LED Status	MSP430F5528 Mode of Operation
Off	EVM is connected to EVM GUI
Blinking in burst of 4 blinks	EVM is plugged into PC, not connected to EVM GUI
Steady blinking	Connected to USB power

2.4 Programming Header

The TMP118EVM comes pre-loaded with firmware that is necessary for the correct operation of the USB interface and PC GUI software. The unpopulated header, J2, is provided for Spy-Bi-Wire access to the MSP430F5528. TI does not recommend that users access this header or reprogram the device.

2.5 BSL Button

The TMP118EVM features push-button SW1 for entering USB BSL mode. This can be used for firmware updates. To enter USB BSL mode, connect the EVM to a PC USB port while holding down SW1.

3 Software

3.1 Software Installation

The PC GUI Software for TMP118EVM runs on TI's GUI Composer framework. The software is available as a live version, which runs in a browser, and is available as a download for offline use. The software is compatible with Windows, Mac, or Linux operating systems.

3.1.1 Live Software on dev.ti.com

The live software currently works on Chrome™, Firefox®, and Safari® browsers. Internet Explorer® is not supported. Users can access the live version through one of the following actions:

- Go to the TMP118EVM Product page on ti.com and click on the View button
- Go to dev.ti.com/gallery, log in with myTI account credentials, and search for TMP118EVM.
- Go to dev.ti.com/gallery/info/THSApps/TMP118EVM/.

Click the application icon within the gallery to launch the software. Agree to the prompts to install or update the TI Cloud Agent browser plug-in. The plug-in is necessary for connection to the USB hardware.

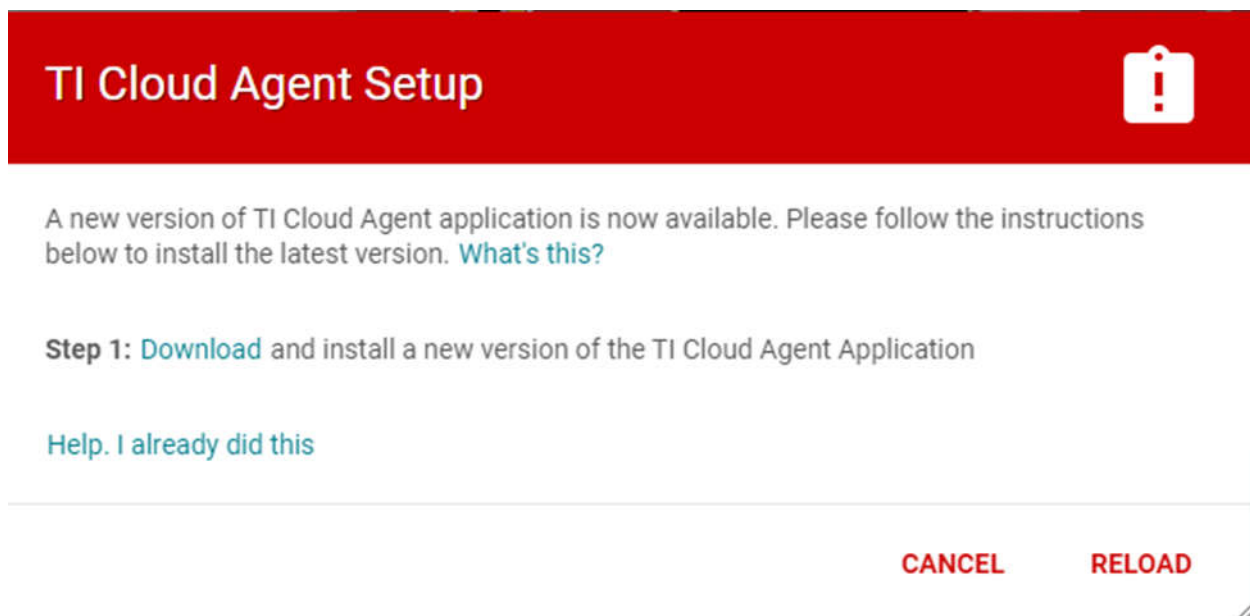



Figure 3-1. Plug-in Setup

3.1.2 Download From dev.ti.com

Users can access the latest version of the offline software by navigating to the live version as noted above. Look for the download icon  and download both the application and run time for the operating system as shown in [Figure 3-2](#) and [Figure 3-3](#).

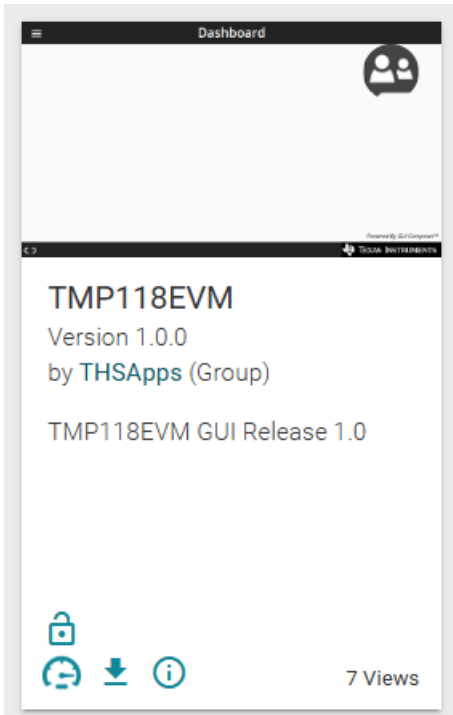

Figure 3-2. Download Pop-Up

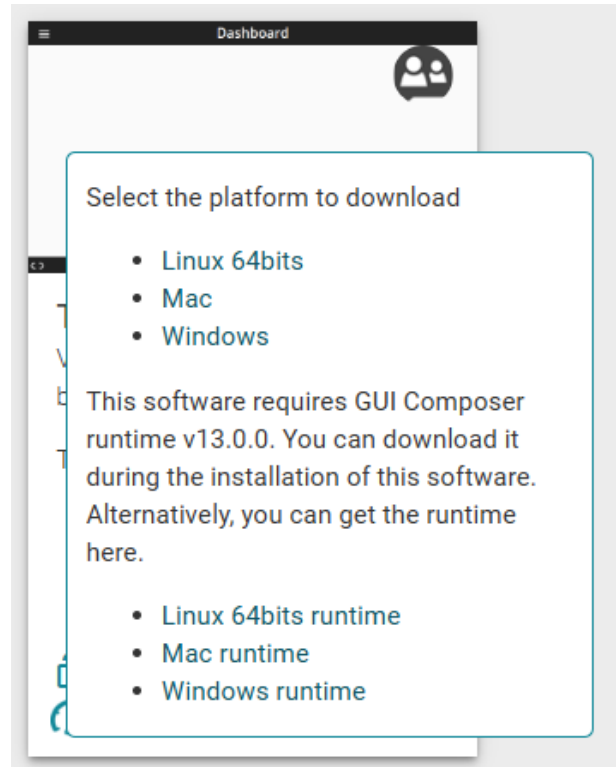

Figure 3-3. Download Pop-Up

3.2 Home Tab

The *Home* tab is shown at software launch. The icons on the bottom of this tab are shortcuts to the other functional tabs of the GUI, and correspond to the icons on the left side of the GUI.

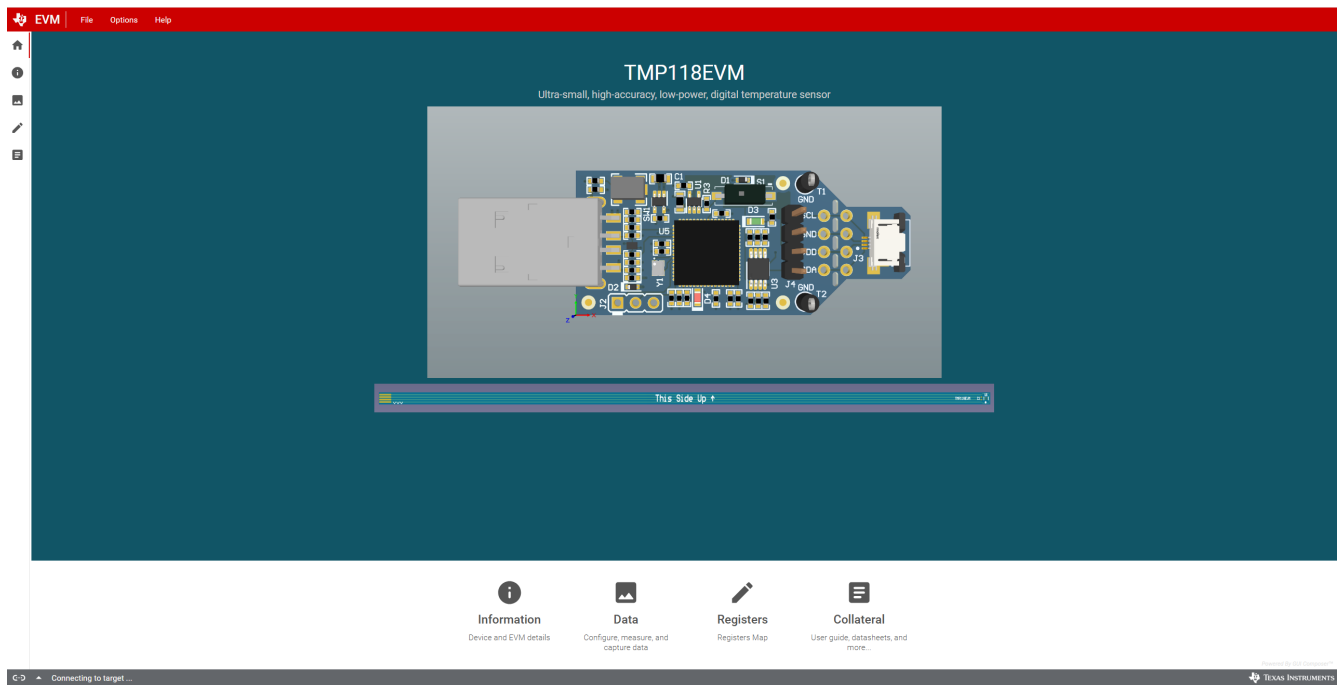

Figure 3-4. Home

3.3 Data Capture Tab

The *Data Capture* tab reports the temperature from the TMP118 device included on the TMP118EVM. Temperature data is polled and displayed by default. By default, the MCU polls the registers with a 100ms delay. The CONVERT TEMP command (0x44) is sent automatically while polling. The polling rate setting on the *Data Capture* tab is synchronized with the polling rate setting on the *Registers* tab. The following features of the Data Capture Tab include:

- Reading the current temperature measurement from the TMP118 displayed in the upper right corner.
- Polling Rate drop-down menu is used to disable polling or change the polling rate.
- The *Save Logging* and *Stop Logging* buttons can be used to capture Temperature data and save the data to a CSV format.

When capturing data, please remember the following:

- For the online version of the GUI, a download begins in the browser. This download is lost if the GUI is closed.
- For the offline version of the GUI, the file is appended as data is received. In this case, appended data is not lost if the GUI is closed.

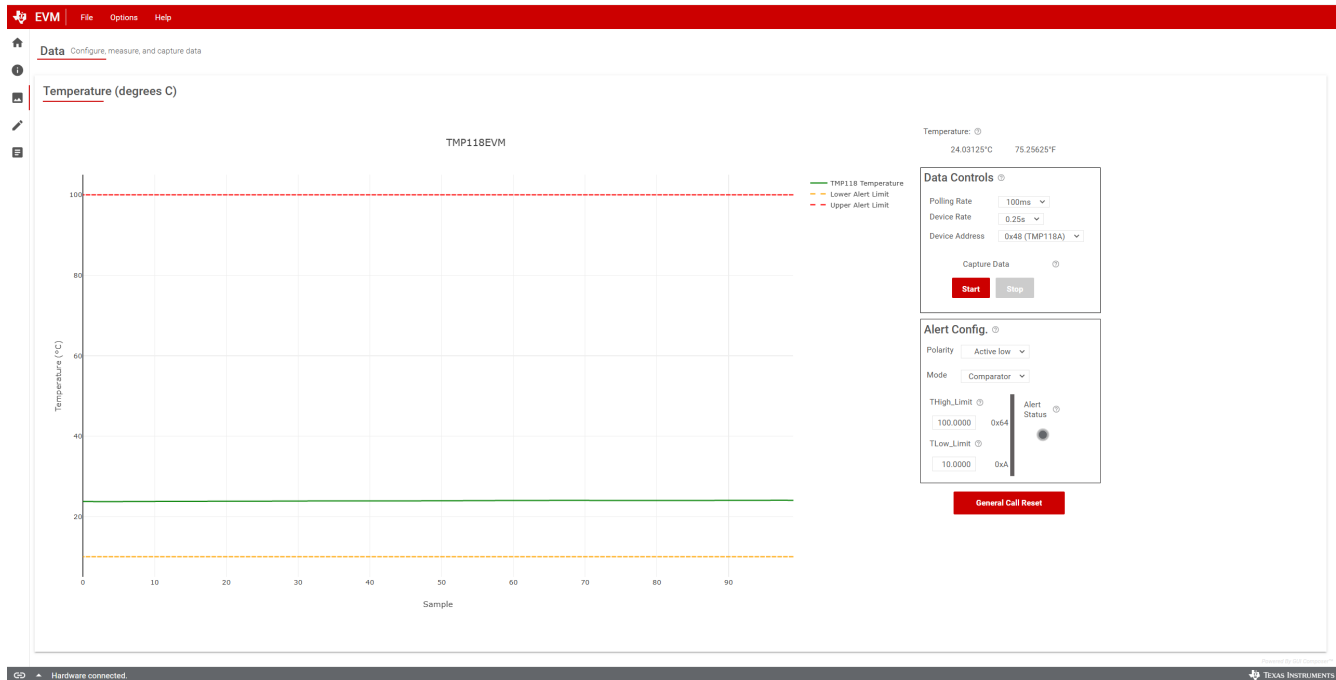

Figure 3-5. Data Capture

3.4 Registers Tab

The *Registers* tab interacts with the registers and the bits within the TMP118 device. For more information on each register/bit, hover over the register name and click on the question mark to see what each bit defines.

By default, the MCU polls the registers with a 100ms delay and the table shows the current status of the registers and updates the changes in the table every poll. By clicking on the bits in the table, the user has the availability to change the bit to a 1 or 0. The Write Register buttons are grayed and disabled when the button is set to Immediate. Immediate mode triggers a Write operation each time a register is modified. When Deferred mode is selected and the Write Register button is enabled, write operations are not performed unless the Write Register button is clicked.

When Deferred mode is selected, the user can take advantage of the following:

- Write button writes the bit changes in the selected register.
- Write All button is used to write all bit changes in all registers.

When auto read is turned off, the table no longer updates and the user can take advantage of the following:

- Read button reads the current status of the selected register.
- Read All button is used to fetch the current contents of all registers at once.

These settings give the user total control over bus activity, and enable individual transactions to be easily observed with an oscilloscope, logic analyzer, or bus-sniffing device.

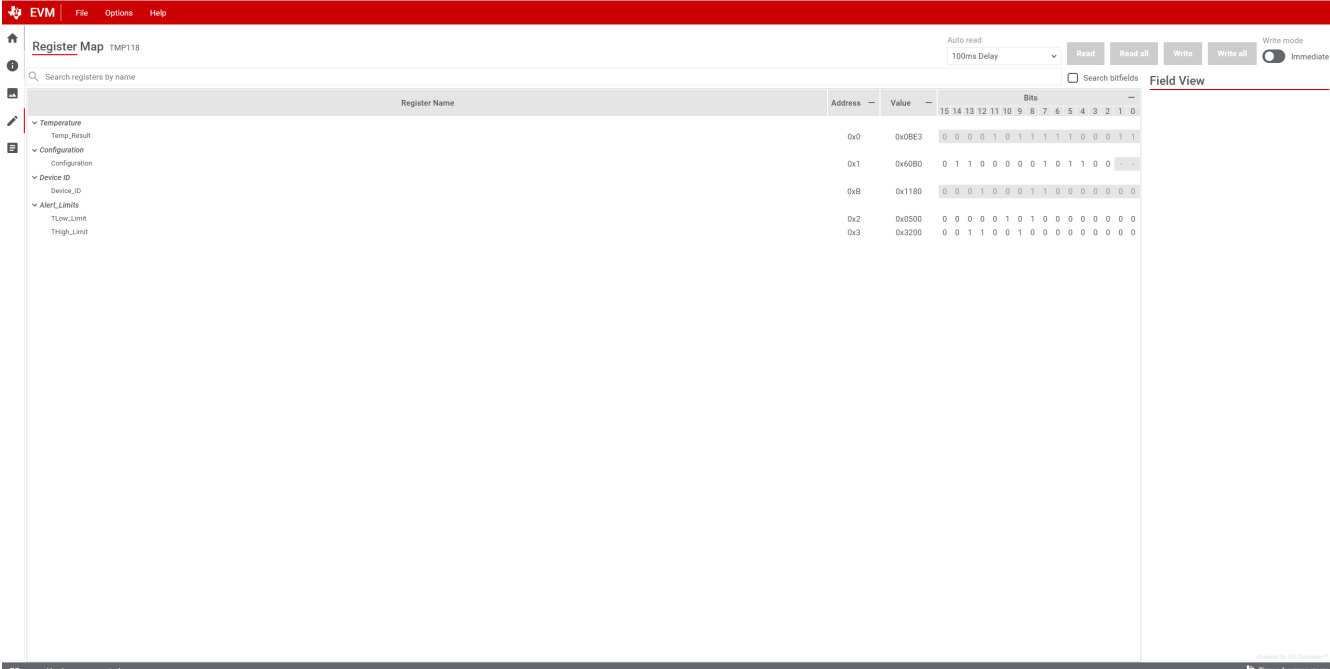

Register Name	Address	Value	Bits
Temp_Result	0x0	0x0BE3	15 14 13 12 11 10 9 8 7 6 5 4 3 2 1 0 0 0 0 0 1 0 1 1 1 1 1 0 0 0 1 1
Configuration	0x1	0x6080	0 1 1 0 0 0 0 0 0 1 0 1 1 0 0
Device ID	0x8	0x1180	0 0 0 1 0 0 0 0 1 1 0 0 0 0 0 0
Alert_Limits	0x2	0x0500	0 0 0 0 0 1 0 1 0 0 0 0 0 0 0 0
High_Limit	0x3	0x3200	0 0 1 1 0 0 1 0 0 0 0 0 0 0 0 0

Figure 3-6. Registers

4 Hardware Design Files

4.1 Schematic

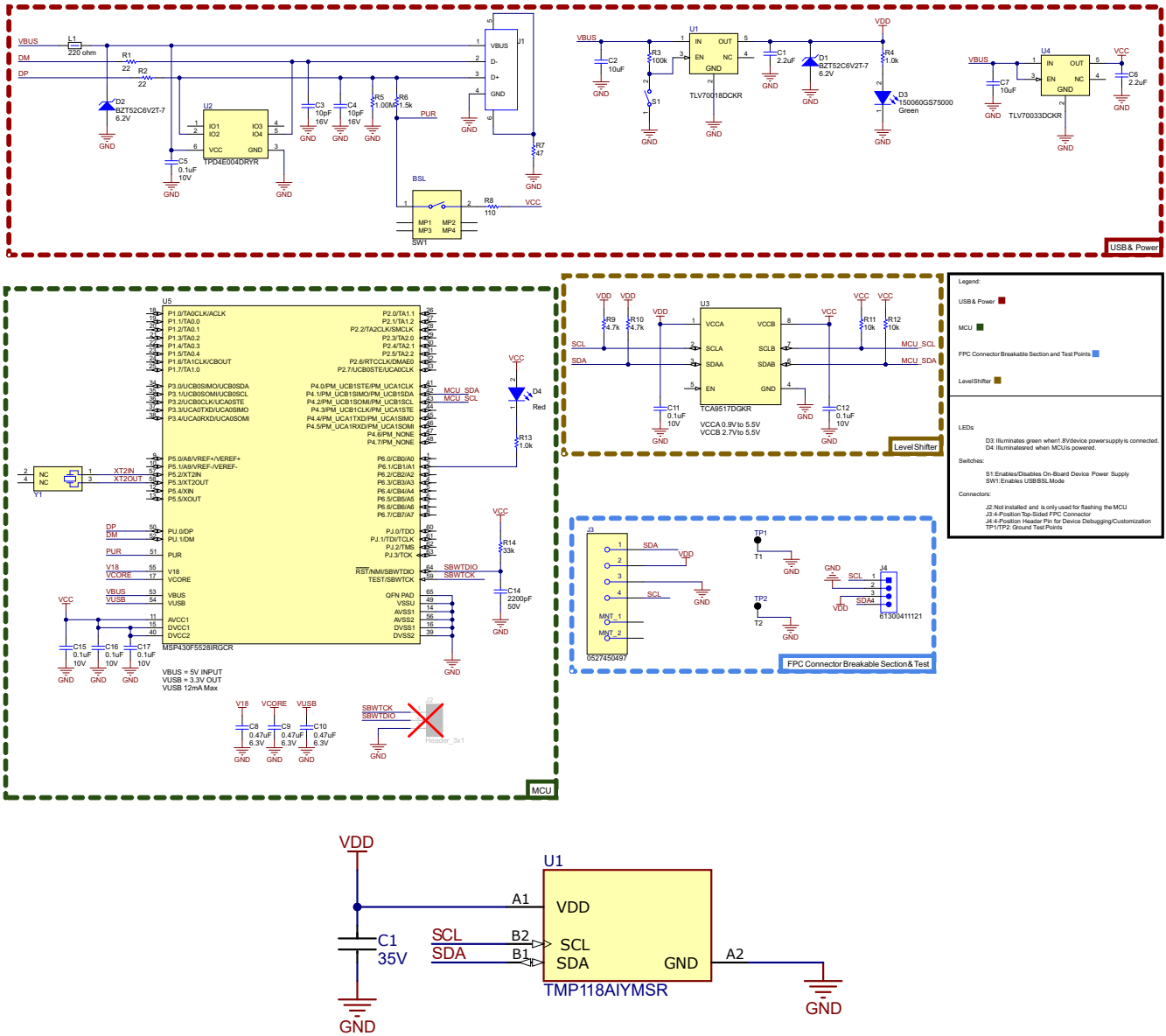
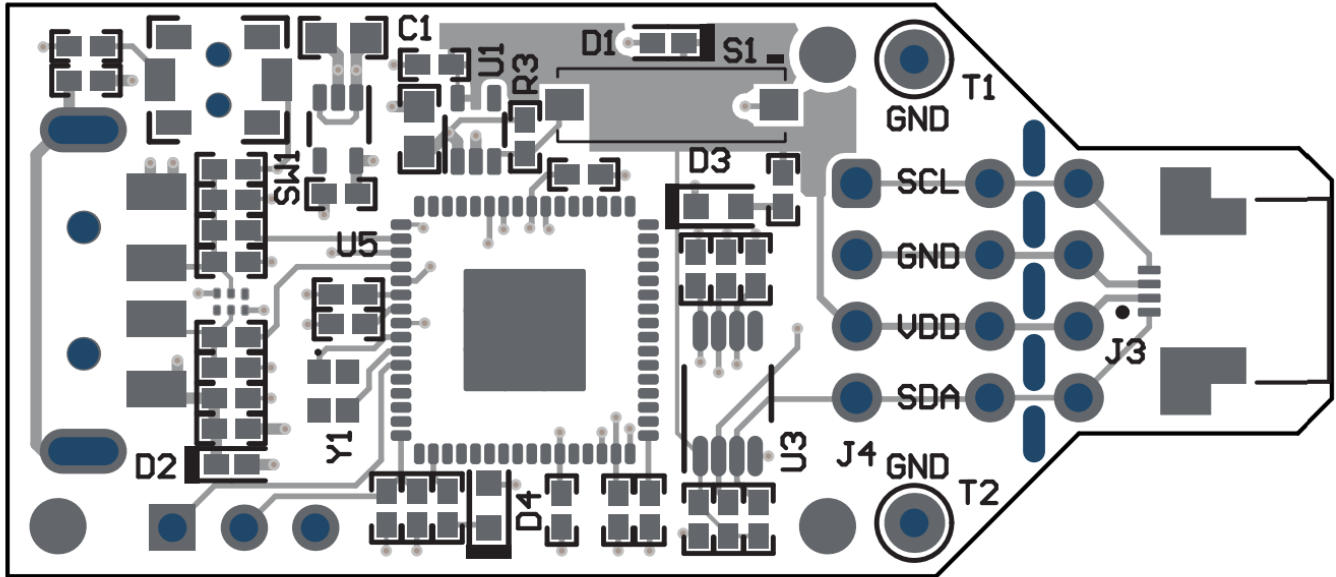

Figure 4-1. Schematic

4.2 PCB Layout



This Side Up ↑

Figure 4-2. PCB Top

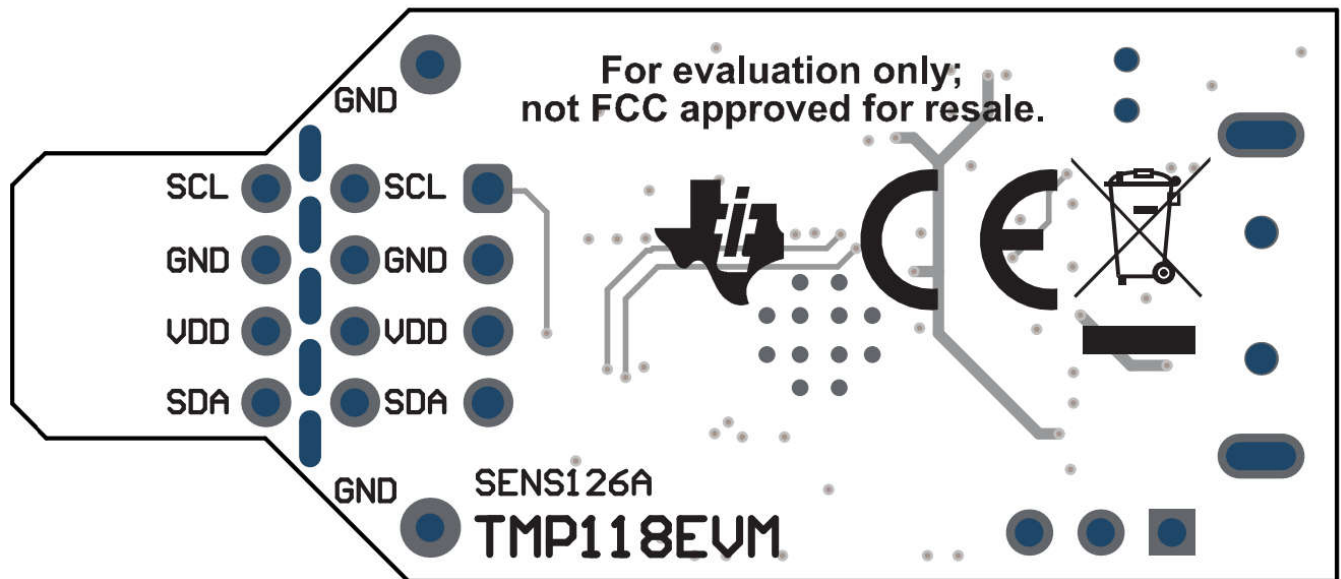

TMP118EVM

Figure 4-3. PCB Bottom

4.3 Bill of Materials

Table 4-1 lists the bill of materials for TMP118EVM.

Table 4-1. MCU Board BOM

DESIGNATOR	QUANTITY	VALUE	DESCRIPTION	PACKAGE REFERENCE	PART NUMBER	MANUFACTURER
C1, C6	2	2.2uF	CAP, CERM, 2.2uF, 16V, +/- 10%, X5R, 0402	0402	GRM155R61C225KE11D	MuRata
C2, C7	2	10uF	CAP, CERM, 10uF, 10V, +/- 20%, X5R, 0603	0603	C1608X5R1A106M080AC	TDK
C3, C4	2	10pF	CAP, CERM, 10pF, 16V,+/- 10%, C0G, 0402	0402	C0402C100K4GACTU	Kemet
C5, C11, C12, C15, C16, C17	6	0.1uF	CAP, CERM, 0.1uF, 10V,+/- 10%, X5R, 0402	0402	LMK105BJ104KV-F	Taiyo Yuden
C8, C9, C10	3	0.47uF	CAP, CERM, 0.47uF, 6.3V, +/- 10%, X7R, 0402	0402	JMK105B7474KVHF	Taiyo Yuden
C14	1	2200pF	CAP, CERM, 2200pF, 50V, +/- 5%, X7R, 0402	0402	CL05B222JB5NNNC	Samsung Electro-Mechanics
D1, D2	2	6.2V	Diode, Zener, 6.2V, 300 mW, SOD-523	SOD-523	BZT52C6V2T-7	Diodes Inc.
D3	1	Green	LED, Green, SMD	LED_0603	150060GS75000	Würth Elektronik
D4	1	Red	LED, Red, SMD	LED_0603	150060RS75000	Würth Elektronik
J1	1		Connector, Plug, USB Type A, R/A, Top Mount SMT	USB Type A right angle	48037-1000	Molex
J3	1		4 Position Connector Contacts, Top 0.020	CONN_TOP4	527450497	Molex
J4	1		Header, 2.54mm, 4x1, Gold, TH	Header, 2.54mm, 4x1, TH	61300411121	Würth Elektronik
L1	1	220 ohm	Ferrite Bead, 220 ohm at 100MHz, 0.45A, 0402	0402	BLM15AG221SN1D	MuRata
R1, R2	2	22	RES, 22, 5%, 0.1 W, AEC-Q200 Grade 0, 0402	0402	ERJ-2GEJ220X	Panasonic
R3	1	100k	RES, 100 k, 5%, 0.1 W, AEC-Q200 Grade 0, 0402	0402	ERJ-2GEJ104X	Panasonic
R4, R13	2	1.0k	RES, 1.0 k, 5%, 0.1 W, AEC-Q200 Grade 0, 0402	0402	ERJ-2GEJ102X	Panasonic
R5	1	1.00Meg	RES, 1.00M, 1%, 0.063 W, AEC-Q200 Grade 0, 0402	0402	RMCF0402FT1M00	Stackpole Electronics Inc
R6	1	1.5k	RES, 1.5 k, 5%, 0.063 W, AEC-Q200 Grade 0, 0402	0402	CRCW04021K50JNED	Vishay-Dale
R7	1	47	RES, 47, 5%, 0.1 W, AEC-Q200 Grade 0, 0402	0402	ERJ-2GEJ470X	Panasonic
R8	1	110	RES, 110, 5%, 0.063 W, AEC-Q200 Grade 0, 0402	0402	CRCW0402110RJNED	Vishay-Dale
R9, R10	2	4.7k	RES, 4.7 k, 5%, 0.063 W, AEC-Q200 Grade 0, 0402	0402	CRCW04024K70JNED	Vishay-Dale
R11, R12	2	10k	RES, 10 k, 5%, 0.1 W, AEC-Q200 Grade 0, 0402	0402	ERJ-2GEJ103X	Panasonic
R14	1	33k	RES, 33 k, 5%, 0.063 W, AEC-Q200 Grade 0, 0402	0402	CRCW040233K0JNED	Vishay-Dale

Table 4-1. MCU Board BOM (continued)

DESIGNATOR	QUANTITY	VALUE	DESCRIPTION	PACKAGE REFERENCE	PART NUMBER	MANUFACTURER
S1	1		Switch, Slide, SPST, Top Slide, SMT	Switch, Single Top Slide, 2.5x2.5mm	CHS-01TB	Copal Electronics
SW1	1		Switch, SPST-NO, Off-Mom, 0.05A, 12VDC, SMD	3.9x2.9mm	PTS820 J20M SMTR LFS	C&K Components
TP1, TP2	2		Test Point, Miniature, Black, TH	Black Miniature Test point	5001	Keystone Electronics
U1	1		Single Output LDO, 200mA, Fixed 1.8V Output, 2V to 5.5V Input, with Low IQ, 5-pin SC70 (DCK), -40°C to 125°C, Green (RoHS & no Sb/Br)	DCK0005A	TLV70018DCKR	Texas Instruments
U2	1		4-Channel ESD Protection Array for High-Speed Data Interfaces, DRY0006A (USON-6)	DRY0006A	TPD4E004DRYR	Texas Instruments
U3	1		Level-Shifting I2C Bus Repeater, DGK0008A (VSSOP-8)	DGK0008A	TCA9517DGKR	Texas Instruments
U4	1		Single Output LDO, 200mA, Fixed 3.3V Output, 2V to 5.5V Input, with Low IQ, 5-pin SC70 (DCK), -40 to 125 degC, Green (RoHS & no Sb/Br)	DCK0005A	TLV70033DCKR	Texas Instruments
U5	1		16-Bit Ultra-Low-Power Microcontroller, 128KB Flash, 8KB RAM, USB, 12Bit ADC, 2 USCIs, 32Bit HW MPY, RGC0064B (VQFN-64)	RGC0064B	MSP430F5528IRGCR	Texas Instruments
Y1	1		Crystal, 24MHz, SMD	2x1.6mm	XRCGB24M000F2P00R0	MuRata

Table 4-2. FPC Sensor Board BOM

DESIGNATOR	QUANTITY	VALUE	DESCRIPTION	PACKAGE REFERENCE	PART NUMBER	MANUFACTURER
C1	1		Cap Ceramic 0.1uF 35V X5R 10% Pad SMD 0201 85C T/R	0201 (0603 Metric)	GRM033R6YA104KE14D	Murata Electronics North America
U1	1		Ultra-small, high-accuracy, low-power, digital temperature sensor with SMBus - and I2C-compatible interface	PicoStar4	TMP118AIYMSR	Texas Instruments

5 Additional Information

5.1 Trademarks

Chrome™ is a trademark of Google LLC.

Windows® and Internet Explorer® are registered trademarks of Microsoft Corporation.

Mac® is a registered trademark of Apple Inc..

Linux® is a registered trademark of Linus Torvalds.

Firefox® is a registered trademark of Mozilla Foundation.

Safari® is a registered trademark of Apple Inc.

All trademarks are the property of their respective owners.

6 Revision History

NOTE: Page numbers for previous revisions may differ from page numbers in the current version.

Changes from Revision * (May 2024) to Revision A (December 2024)	Page
• Updated the number formatting for tables, figures, and cross-references throughout the document.....	1

STANDARD TERMS FOR EVALUATION MODULES

1. *Delivery:* TI delivers TI evaluation boards, kits, or modules, including any accompanying demonstration software, components, and/or documentation which may be provided together or separately (collectively, an "EVM" or "EVMs") to the User ("User") in accordance with the terms set forth herein. User's acceptance of the EVM is expressly subject to the following terms.
 - 1.1 EVMs are intended solely for product or software developers for use in a research and development setting to facilitate feasibility evaluation, experimentation, or scientific analysis of TI semiconductors products. EVMs have no direct function and are not finished products. EVMs shall not be directly or indirectly assembled as a part or subassembly in any finished product. For clarification, any software or software tools provided with the EVM ("Software") shall not be subject to the terms and conditions set forth herein but rather shall be subject to the applicable terms that accompany such Software
 - 1.2 EVMs are not intended for consumer or household use. EVMs may not be sold, sublicensed, leased, rented, loaned, assigned, or otherwise distributed for commercial purposes by Users, in whole or in part, or used in any finished product or production system.
2. *Limited Warranty and Related Remedies/Disclaimers:*
 - 2.1 These terms do not apply to Software. The warranty, if any, for Software is covered in the applicable Software License Agreement.
 - 2.2 TI warrants that the TI EVM will conform to TI's published specifications for ninety (90) days after the date TI delivers such EVM to User. Notwithstanding the foregoing, TI shall not be liable for a nonconforming EVM if (a) the nonconformity was caused by neglect, misuse or mistreatment by an entity other than TI, including improper installation or testing, or for any EVMs that have been altered or modified in any way by an entity other than TI, (b) the nonconformity resulted from User's design, specifications or instructions for such EVMs or improper system design, or (c) User has not paid on time. Testing and other quality control techniques are used to the extent TI deems necessary. TI does not test all parameters of each EVM. User's claims against TI under this Section 2 are void if User fails to notify TI of any apparent defects in the EVMs within ten (10) business days after delivery, or of any hidden defects with ten (10) business days after the defect has been detected.
 - 2.3 TI's sole liability shall be at its option to repair or replace EVMs that fail to conform to the warranty set forth above, or credit User's account for such EVM. TI's liability under this warranty shall be limited to EVMs that are returned during the warranty period to the address designated by TI and that are determined by TI not to conform to such warranty. If TI elects to repair or replace such EVM, TI shall have a reasonable time to repair such EVM or provide replacements. Repaired EVMs shall be warranted for the remainder of the original warranty period. Replaced EVMs shall be warranted for a new full ninety (90) day warranty period.

WARNING

Evaluation Kits are intended solely for use by technically qualified, professional electronics experts who are familiar with the dangers and application risks associated with handling electrical mechanical components, systems, and subsystems.

User shall operate the Evaluation Kit within TI's recommended guidelines and any applicable legal or environmental requirements as well as reasonable and customary safeguards. Failure to set up and/or operate the Evaluation Kit within TI's recommended guidelines may result in personal injury or death or property damage. Proper set up entails following TI's instructions for electrical ratings of interface circuits such as input, output and electrical loads.

NOTE:

EXPOSURE TO ELECTROSTATIC DISCHARGE (ESD) MAY CAUSE DEGRADATION OR FAILURE OF THE EVALUATION KIT; TI RECOMMENDS STORAGE OF THE EVALUATION KIT IN A PROTECTIVE ESD BAG.

3 Regulatory Notices:

3.1 United States

3.1.1 Notice applicable to EVMs not FCC-Approved:

FCC NOTICE: This kit is designed to allow product developers to evaluate electronic components, circuitry, or software associated with the kit to determine whether to incorporate such items in a finished product and software developers to write software applications for use with the end product. This kit is not a finished product and when assembled may not be resold or otherwise marketed unless all required FCC equipment authorizations are first obtained. Operation is subject to the condition that this product not cause harmful interference to licensed radio stations and that this product accept harmful interference. Unless the assembled kit is designed to operate under part 15, part 18 or part 95 of this chapter, the operator of the kit must operate under the authority of an FCC license holder or must secure an experimental authorization under part 5 of this chapter.

3.1.2 For EVMs annotated as FCC – FEDERAL COMMUNICATIONS COMMISSION Part 15 Compliant:

CAUTION

This device complies with part 15 of the FCC Rules. Operation is subject to the following two conditions: (1) This device may not cause harmful interference, and (2) this device must accept any interference received, including interference that may cause undesired operation.

Changes or modifications not expressly approved by the party responsible for compliance could void the user's authority to operate the equipment.

FCC Interference Statement for Class A EVM devices

NOTE: This equipment has been tested and found to comply with the limits for a Class A digital device, pursuant to part 15 of the FCC Rules. These limits are designed to provide reasonable protection against harmful interference when the equipment is operated in a commercial environment. This equipment generates, uses, and can radiate radio frequency energy and, if not installed and used in accordance with the instruction manual, may cause harmful interference to radio communications. Operation of this equipment in a residential area is likely to cause harmful interference in which case the user will be required to correct the interference at his own expense.

FCC Interference Statement for Class B EVM devices

NOTE: This equipment has been tested and found to comply with the limits for a Class B digital device, pursuant to part 15 of the FCC Rules. These limits are designed to provide reasonable protection against harmful interference in a residential installation. This equipment generates, uses and can radiate radio frequency energy and, if not installed and used in accordance with the instructions, may cause harmful interference to radio communications. However, there is no guarantee that interference will not occur in a particular installation. If this equipment does cause harmful interference to radio or television reception, which can be determined by turning the equipment off and on, the user is encouraged to try to correct the interference by one or more of the following measures:

- Reorient or relocate the receiving antenna.
- Increase the separation between the equipment and receiver.
- Connect the equipment into an outlet on a circuit different from that to which the receiver is connected.
- Consult the dealer or an experienced radio/TV technician for help.

3.2 Canada

3.2.1 For EVMs issued with an Industry Canada Certificate of Conformance to RSS-210 or RSS-247

Concerning EVMs Including Radio Transmitters:

This device complies with Industry Canada license-exempt RSSs. Operation is subject to the following two conditions:

(1) this device may not cause interference, and (2) this device must accept any interference, including interference that may cause undesired operation of the device.

Concernant les EVMs avec appareils radio:

Le présent appareil est conforme aux CNR d'Industrie Canada applicables aux appareils radio exempts de licence. L'exploitation est autorisée aux deux conditions suivantes: (1) l'appareil ne doit pas produire de brouillage, et (2) l'utilisateur de l'appareil doit accepter tout brouillage radioélectrique subi, même si le brouillage est susceptible d'en compromettre le fonctionnement.

Concerning EVMs Including Detachable Antennas:

Under Industry Canada regulations, this radio transmitter may only operate using an antenna of a type and maximum (or lesser) gain approved for the transmitter by Industry Canada. To reduce potential radio interference to other users, the antenna type and its gain should be so chosen that the equivalent isotropically radiated power (e.i.r.p.) is not more than that necessary for successful communication. This radio transmitter has been approved by Industry Canada to operate with the antenna types listed in the user guide with the maximum permissible gain and required antenna impedance for each antenna type indicated. Antenna types not included in this list, having a gain greater than the maximum gain indicated for that type, are strictly prohibited for use with this device.

Concernant les EVMs avec antennes détachables

Conformément à la réglementation d'Industrie Canada, le présent émetteur radio peut fonctionner avec une antenne d'un type et d'un gain maximal (ou inférieur) approuvé pour l'émetteur par Industrie Canada. Dans le but de réduire les risques de brouillage radioélectrique à l'intention des autres utilisateurs, il faut choisir le type d'antenne et son gain de sorte que la puissance isotrope rayonnée équivalente (p.i.r.e.) ne dépasse pas l'intensité nécessaire à l'établissement d'une communication satisfaisante. Le présent émetteur radio a été approuvé par Industrie Canada pour fonctionner avec les types d'antenne énumérés dans le manuel d'usage et ayant un gain admissible maximal et l'impédance requise pour chaque type d'antenne. Les types d'antenne non inclus dans cette liste, ou dont le gain est supérieur au gain maximal indiqué, sont strictement interdits pour l'exploitation de l'émetteur.

3.3 Japan

3.3.1 *Notice for EVMs delivered in Japan:* Please see http://www.tij.co.jp/lstds/ti_ja/general/eStore/notice_01.page 日本国内に輸入される評価用キット、ボードについては、次のところをご覧ください。

<https://www.ti.com/ja-jp/legal/notice-for-evaluation-kits-delivered-in-japan.html>

3.3.2 *Notice for Users of EVMs Considered "Radio Frequency Products" in Japan:* EVMs entering Japan may not be certified by TI as conforming to Technical Regulations of Radio Law of Japan.

If User uses EVMs in Japan, not certified to Technical Regulations of Radio Law of Japan, User is required to follow the instructions set forth by Radio Law of Japan, which includes, but is not limited to, the instructions below with respect to EVMs (which for the avoidance of doubt are stated strictly for convenience and should be verified by User):

1. Use EVMs in a shielded room or any other test facility as defined in the notification #173 issued by Ministry of Internal Affairs and Communications on March 28, 2006, based on Sub-section 1.1 of Article 6 of the Ministry's Rule for Enforcement of Radio Law of Japan,
2. Use EVMs only after User obtains the license of Test Radio Station as provided in Radio Law of Japan with respect to EVMs, or
3. Use of EVMs only after User obtains the Technical Regulations Conformity Certification as provided in Radio Law of Japan with respect to EVMs. Also, do not transfer EVMs, unless User gives the same notice above to the transferee. Please note that if User does not follow the instructions above, User will be subject to penalties of Radio Law of Japan.

【無線電波を送信する製品の開発キットをお使いになる際の注意事項】 開発キットの中には技術基準適合証明を受けていないものがあります。技術適合証明を受けていないものご使用に際しては、電波法遵守のため、以下のいずれかの措置を取っていただく必要がありますのでご注意ください。

1. 電波法施行規則第6条第1項第1号に基づく平成18年3月28日総務省告示第173号で定められた電波暗室等の試験設備でご使用いただく。
2. 実験局の免許を取得後ご使用いただく。
3. 技術基準適合証明を取得後ご使用いただく。

なお、本製品は、上記の「ご使用にあたっての注意」を譲渡先、移転先に通知しない限り、譲渡、移転できないものとします。

上記を遵守頂けない場合は、電波法の罰則が適用される可能性があることをご留意ください。日本テキサス・イ

ンスツルメンツ株式会社

東京都新宿区西新宿 6 丁目 2 4 番 1 号

西新宿三井ビル

3.3.3 *Notice for EVMs for Power Line Communication:* Please see http://www.tij.co.jp/lstds/ti_ja/general/eStore/notice_02.page

電力線搬送波通信についての開発キットをお使いになる際の注意事項については、次のところをご覧ください。 <https://www.ti.com/ja-jp/legal/notice-for-evaluation-kits-for-power-line-communication.html>

3.4 European Union

3.4.1 *For EVMs subject to EU Directive 2014/30/EU (Electromagnetic Compatibility Directive):*

This is a class A product intended for use in environments other than domestic environments that are connected to a low-voltage power-supply network that supplies buildings used for domestic purposes. In a domestic environment this product may cause radio interference in which case the user may be required to take adequate measures.

-
4. *EVM Use Restrictions and Warnings:*
 - 4.1 EVMS ARE NOT FOR USE IN FUNCTIONAL SAFETY AND/OR SAFETY CRITICAL EVALUATIONS, INCLUDING BUT NOT LIMITED TO EVALUATIONS OF LIFE SUPPORT APPLICATIONS.
 - 4.2 User must read and apply the user guide and other available documentation provided by TI regarding the EVM prior to handling or using the EVM, including without limitation any warning or restriction notices. The notices contain important safety information related to, for example, temperatures and voltages.
 - 4.3 *Safety-Related Warnings and Restrictions:*
 - 4.3.1 User shall operate the EVM within TI's recommended specifications and environmental considerations stated in the user guide, other available documentation provided by TI, and any other applicable requirements and employ reasonable and customary safeguards. Exceeding the specified performance ratings and specifications (including but not limited to input and output voltage, current, power, and environmental ranges) for the EVM may cause personal injury or death, or property damage. If there are questions concerning performance ratings and specifications, User should contact a TI field representative prior to connecting interface electronics including input power and intended loads. Any loads applied outside of the specified output range may also result in unintended and/or inaccurate operation and/or possible permanent damage to the EVM and/or interface electronics. Please consult the EVM user guide prior to connecting any load to the EVM output. If there is uncertainty as to the load specification, please contact a TI field representative. During normal operation, even with the inputs and outputs kept within the specified allowable ranges, some circuit components may have elevated case temperatures. These components include but are not limited to linear regulators, switching transistors, pass transistors, current sense resistors, and heat sinks, which can be identified using the information in the associated documentation. When working with the EVM, please be aware that the EVM may become very warm.
 - 4.3.2 EVMs are intended solely for use by technically qualified, professional electronics experts who are familiar with the dangers and application risks associated with handling electrical mechanical components, systems, and subsystems. User assumes all responsibility and liability for proper and safe handling and use of the EVM by User or its employees, affiliates, contractors or designees. User assumes all responsibility and liability to ensure that any interfaces (electronic and/or mechanical) between the EVM and any human body are designed with suitable isolation and means to safely limit accessible leakage currents to minimize the risk of electrical shock hazard. User assumes all responsibility and liability for any improper or unsafe handling or use of the EVM by User or its employees, affiliates, contractors or designees.
 - 4.4 User assumes all responsibility and liability to determine whether the EVM is subject to any applicable international, federal, state, or local laws and regulations related to User's handling and use of the EVM and, if applicable, User assumes all responsibility and liability for compliance in all respects with such laws and regulations. User assumes all responsibility and liability for proper disposal and recycling of the EVM consistent with all applicable international, federal, state, and local requirements.
 5. *Accuracy of Information:* To the extent TI provides information on the availability and function of EVMs, TI attempts to be as accurate as possible. However, TI does not warrant the accuracy of EVM descriptions, EVM availability or other information on its websites as accurate, complete, reliable, current, or error-free.
 6. *Disclaimers:*
 - 6.1 EXCEPT AS SET FORTH ABOVE, EVMS AND ANY MATERIALS PROVIDED WITH THE EVM (INCLUDING, BUT NOT LIMITED TO, REFERENCE DESIGNS AND THE DESIGN OF THE EVM ITSELF) ARE PROVIDED "AS IS" AND "WITH ALL FAULTS." TI DISCLAIMS ALL OTHER WARRANTIES, EXPRESS OR IMPLIED, REGARDING SUCH ITEMS, INCLUDING BUT NOT LIMITED TO ANY EPIDEMIC FAILURE WARRANTY OR IMPLIED WARRANTIES OF MERCHANTABILITY OR FITNESS FOR A PARTICULAR PURPOSE OR NON-INFRINGEMENT OF ANY THIRD PARTY PATENTS, COPYRIGHTS, TRADE SECRETS OR OTHER INTELLECTUAL PROPERTY RIGHTS.
 - 6.2 EXCEPT FOR THE LIMITED RIGHT TO USE THE EVM SET FORTH HEREIN, NOTHING IN THESE TERMS SHALL BE CONSTRUED AS GRANTING OR CONFERRING ANY RIGHTS BY LICENSE, PATENT, OR ANY OTHER INDUSTRIAL OR INTELLECTUAL PROPERTY RIGHT OF TI, ITS SUPPLIERS/LICENSORS OR ANY OTHER THIRD PARTY, TO USE THE EVM IN ANY FINISHED END-USER OR READY-TO-USE FINAL PRODUCT, OR FOR ANY INVENTION, DISCOVERY OR IMPROVEMENT, REGARDLESS OF WHEN MADE, CONCEIVED OR ACQUIRED.
 7. *USER'S INDEMNITY OBLIGATIONS AND REPRESENTATIONS.* USER WILL DEFEND, INDEMNIFY AND HOLD TI, ITS LICENSORS AND THEIR REPRESENTATIVES HARMLESS FROM AND AGAINST ANY AND ALL CLAIMS, DAMAGES, LOSSES, EXPENSES, COSTS AND LIABILITIES (COLLECTIVELY, "CLAIMS") ARISING OUT OF OR IN CONNECTION WITH ANY HANDLING OR USE OF THE EVM THAT IS NOT IN ACCORDANCE WITH THESE TERMS. THIS OBLIGATION SHALL APPLY WHETHER CLAIMS ARISE UNDER STATUTE, REGULATION, OR THE LAW OF TORT, CONTRACT OR ANY OTHER LEGAL THEORY, AND EVEN IF THE EVM FAILS TO PERFORM AS DESCRIBED OR EXPECTED.
-

8. *Limitations on Damages and Liability:*

8.1 *General Limitations.* IN NO EVENT SHALL TI BE LIABLE FOR ANY SPECIAL, COLLATERAL, INDIRECT, PUNITIVE, INCIDENTAL, CONSEQUENTIAL, OR EXEMPLARY DAMAGES IN CONNECTION WITH OR ARISING OUT OF THESE TERMS OR THE USE OF THE EVMS , REGARDLESS OF WHETHER TI HAS BEEN ADVISED OF THE POSSIBILITY OF SUCH DAMAGES. EXCLUDED DAMAGES INCLUDE, BUT ARE NOT LIMITED TO, COST OF REMOVAL OR REINSTALLATION, ANCILLARY COSTS TO THE PROCUREMENT OF SUBSTITUTE GOODS OR SERVICES, RETESTING, OUTSIDE COMPUTER TIME, LABOR COSTS, LOSS OF GOODWILL, LOSS OF PROFITS, LOSS OF SAVINGS, LOSS OF USE, LOSS OF DATA, OR BUSINESS INTERRUPTION. NO CLAIM, SUIT OR ACTION SHALL BE BROUGHT AGAINST TI MORE THAN TWELVE (12) MONTHS AFTER THE EVENT THAT GAVE RISE TO THE CAUSE OF ACTION HAS OCCURRED.

8.2 *Specific Limitations.* IN NO EVENT SHALL TI'S AGGREGATE LIABILITY FROM ANY USE OF AN EVM PROVIDED HEREUNDER, INCLUDING FROM ANY WARRANTY, INDEMNITY OR OTHER OBLIGATION ARISING OUT OF OR IN CONNECTION WITH THESE TERMS, , EXCEED THE TOTAL AMOUNT PAID TO TI BY USER FOR THE PARTICULAR EVM(S) AT ISSUE DURING THE PRIOR TWELVE (12) MONTHS WITH RESPECT TO WHICH LOSSES OR DAMAGES ARE CLAIMED. THE EXISTENCE OF MORE THAN ONE CLAIM SHALL NOT ENLARGE OR EXTEND THIS LIMIT.

9. *Return Policy.* Except as otherwise provided, TI does not offer any refunds, returns, or exchanges. Furthermore, no return of EVM(s) will be accepted if the package has been opened and no return of the EVM(s) will be accepted if they are damaged or otherwise not in a resalable condition. If User feels it has been incorrectly charged for the EVM(s) it ordered or that delivery violates the applicable order, User should contact TI. All refunds will be made in full within thirty (30) working days from the return of the components(s), excluding any postage or packaging costs.

10. *Governing Law:* These terms and conditions shall be governed by and interpreted in accordance with the laws of the State of Texas, without reference to conflict-of-laws principles. User agrees that non-exclusive jurisdiction for any dispute arising out of or relating to these terms and conditions lies within courts located in the State of Texas and consents to venue in Dallas County, Texas. Notwithstanding the foregoing, any judgment may be enforced in any United States or foreign court, and TI may seek injunctive relief in any United States or foreign court.

Mailing Address: Texas Instruments, Post Office Box 655303, Dallas, Texas 75265
Copyright © 2023, Texas Instruments Incorporated

IMPORTANT NOTICE AND DISCLAIMER

TI PROVIDES TECHNICAL AND RELIABILITY DATA (INCLUDING DATA SHEETS), DESIGN RESOURCES (INCLUDING REFERENCE DESIGNS), APPLICATION OR OTHER DESIGN ADVICE, WEB TOOLS, SAFETY INFORMATION, AND OTHER RESOURCES "AS IS" AND WITH ALL FAULTS, AND DISCLAIMS ALL WARRANTIES, EXPRESS AND IMPLIED, INCLUDING WITHOUT LIMITATION ANY IMPLIED WARRANTIES OF MERCHANTABILITY, FITNESS FOR A PARTICULAR PURPOSE OR NON-INFRINGEMENT OF THIRD PARTY INTELLECTUAL PROPERTY RIGHTS.

These resources are intended for skilled developers designing with TI products. You are solely responsible for (1) selecting the appropriate TI products for your application, (2) designing, validating and testing your application, and (3) ensuring your application meets applicable standards, and any other safety, security, regulatory or other requirements.

These resources are subject to change without notice. TI grants you permission to use these resources only for development of an application that uses the TI products described in the resource. Other reproduction and display of these resources is prohibited. No license is granted to any other TI intellectual property right or to any third party intellectual property right. TI disclaims responsibility for, and you will fully indemnify TI and its representatives against, any claims, damages, costs, losses, and liabilities arising out of your use of these resources.

TI's products are provided subject to [TI's Terms of Sale](#) or other applicable terms available either on [ti.com](https://www.ti.com) or provided in conjunction with such TI products. TI's provision of these resources does not expand or otherwise alter TI's applicable warranties or warranty disclaimers for TI products.

TI objects to and rejects any additional or different terms you may have proposed.

Mailing Address: Texas Instruments, Post Office Box 655303, Dallas, Texas 75265
Copyright © 2024, Texas Instruments Incorporated