

Understanding Mode Transitions for LMR33620/30 and LMR36006/15

Sam Jaffe and Katelyn Wiggernhorn

ABSTRACT

Modern DC/DC converters utilize various modes of operation in order to optimize the efficiency across a wide input voltage range and output load current range. For instance, to improve light load efficiency modern DC/DC converters implement pulse frequency modulation (PFM), and as the output load current increases the mode of operation transitions to forced frequency pulse modulation (FPWM). This application note discusses the mode transitions and expected switching waveforms of [LMR33620/30](#) and [LMR36006/15](#). These state-of-the-art converters use some of TI's most advanced features to determine the optimal times to change modes. The content in this applications note explains not only the expected operation of the converters but also the logic behind their operation. This knowledge helps power designers fully utilize these features to optimize their designs. For an abridged video version of this content check out the second video in the training series: [DC/DC Buck Converters: What do all of these features mean?](#) For a hands-on tool that calculates mode of operation and expected frequency from your specifications, check out the [calculator](#) on the product folder.

Contents

1	Introduction	2
2	Typical Buck Converter Operation.....	2
3	COMP Curve	5
4	PFM and Light Load Operation	7
5	Automatic Frequency Foldback	8
6	Clock Control.....	10
7	Heavy Load Foldback, Current Limit, and Hiccup	11
8	Summary	13
9	References	13

List of Figures

1	Simplified Buck Converter Schematic.....	2
2	Buck Converter Switching Waveforms.....	3
3	DCM vs CCM: Inductor Current Waveform	3
4	Constant Frequency vs Pulse Frequency Modulation: Inductor Current Waveform	4
5	LMR33630 Block Diagram.....	5
6	COMP Curve	6
7	COMP Curve: PFM Operation	7
8	PFM Operation: Inductor Current.....	8
9	COMP Curve: Auto Foldback Operation.....	9
10	Auto Foldback Operation: Inductor Current Waveform	9
11	COMP Curve: Clock Control Operation	10
12	Clock Control Operation: Inductor Current Waveform.....	11
13	COMP Curve: Current Limit Operation	11
14	Current Limit Operation: Inductor Current Waveform	12
15	Hiccup Operation	13

Trademarks

SIMPLE SWITCHER is a trademark of Texas Instruments.
All other trademarks are the property of their respective owners.

1 Introduction

Buck converters play an essential role in the power electronics market. Every application from personal electronics to industrial to automotive requires power in order to operate. A buck converter offers a high-efficiency, small-size, low-cost solution for a wide variety of power-conversion applications. Buck-converter technology has advanced to increase power density, increase efficiency, and reduce noise along with other improvements to optimize the overall performance of these systems. The latest buck technology is the result of improvements in materials – lower R_{DS-ON} FETs, thermally optimized packages as well as improved control techniques such as light-load operating modes and overcurrent detection. This application report delves into the latter. The [LMR33620/30](#) and [LMR36006/15](#) use TI's most advanced control technologies to improve efficiency, protection, and overall performance. This application note explains how these features improve the system as well as the IC-level operational logic, thus allowing the power designer to fully utilize TI technology to create an optimized state-of-the-art system.

2 Typical Buck Converter Operation

A buck converter (or controller) takes an input voltage and efficiently converts it to a lower output voltage. It does this with switches that connect V_{SW} to V_{IN} , then V_{SW} to GND, then V_{SW} to V_{IN} at a high frequency (hundreds of kHz to a few MHz) and at a duty cycle proportional to the ratio of V_{SW} and V_{IN} . An LC low-pass filter converts this switching waveform into a stable DC output. See [Figure 1](#) for a simplified schematic of a typical buck converter.

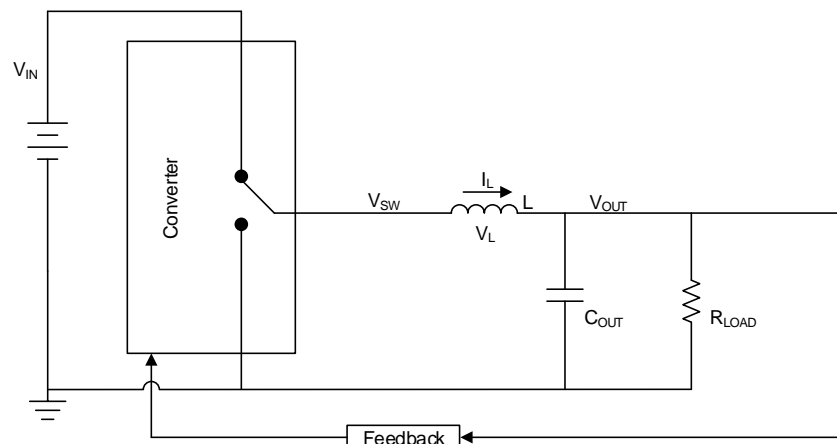

Figure 1. Simplified Buck Converter Schematic

V_{SW} connects to V_{IN} (V_{SW} switches high). At this time the inductor current ramps up linearly at a rate proportional to $V_{IN} - V_{OUT}$ and the inductance L , as shown in [Figure 2](#).

V_{SW} connects to GND (V_{SW} switches low). At this time the inductor current ramps down linearly at a rate proportional to $V_{IN} - V_{OUT}$ and the inductance L , as shown in [Figure 2](#).

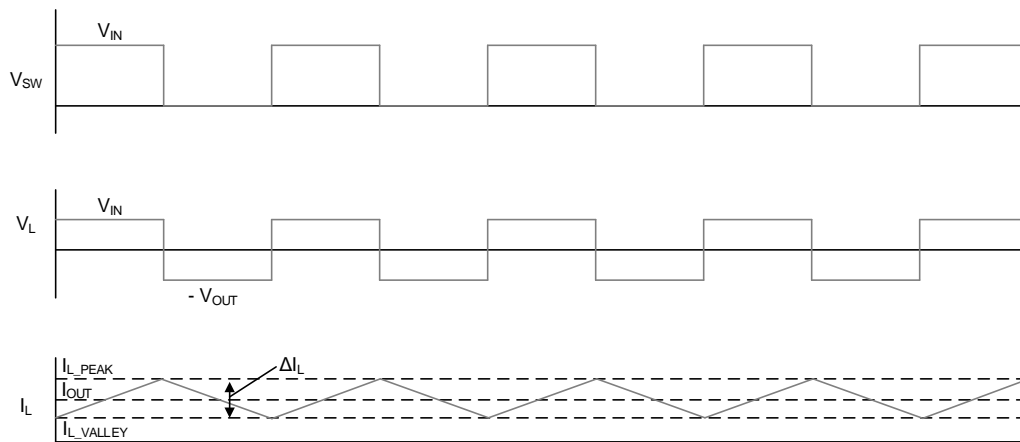

Figure 2. Buck Converter Switching Waveforms

2.1 CCM: Continuous Conduction Mode

The converter operates in CCM when the inductor current is continuous - meaning the current is always either ramping up or down. This is the normal state of operation when the converter has a mid-to-heavy load. The average inductor current (I_{L_AVG}) is equal to the output current (I_{OUT}). Instantaneous inductor current (I_L) never reaches zero if the inductor current ripple amplitude $\Delta I_L / 2$ is smaller than I_{OUT} .

However, if the output load lightens in synchronous converters I_L can approach or even drop below 0 A at the valley of the inductor ripple. This is still CCM because the inductor current is always ramping, but this operating mode is wasteful. Any negative inductor current must be countered with positive current later in the switch cycle, and the inductor must have DC resistance so any unnecessary current dissipates unnecessary power through the inductor DC resistance. This wasted power problem drove the development of discontinuous conduction mode.

2.2 DCM: Discontinuous Conduction Mode

DCM simply shuts off both FETs (the switch in Figure 1) when the inductor current reaches zero. V_{SW} is not connected to V_{IN} or GND — it is floating. This means the converter can wait until the next switching cycle to turn V_{SW} back on. Figure 3 shows the waveform comparison between CCM (top waveform) and DCM (bottom waveform) for the same load.

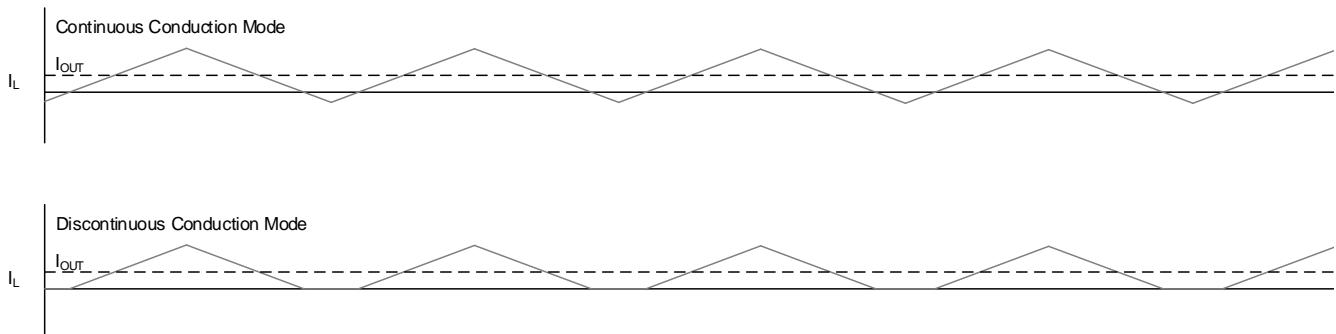

Figure 3. DCM vs CCM: Inductor Current Waveform

2.3 PFM: Pulse Frequency Modulation

PFM was developed to further improve light load efficiency by reducing the switching frequency in very light load conditions. This improves light-load efficiency because every switching cycle requires energy in the form of switching losses and less switching, resulting in less switching loss. PFM also prevents the output voltage from rising above the desired regulation point. Bucks have a minimum on-time, which means every switch cycle delivers some finite amount of energy to the output. A constant frequency at no load can cause that voltage to rise higher than desired. The reduced frequency eliminates the chance of this happening. [Figure 4](#) shows the waveform comparison between DCM at a fixed frequency (top waveform) and PFM at a folded-back frequency (bottom waveform) for different loads.

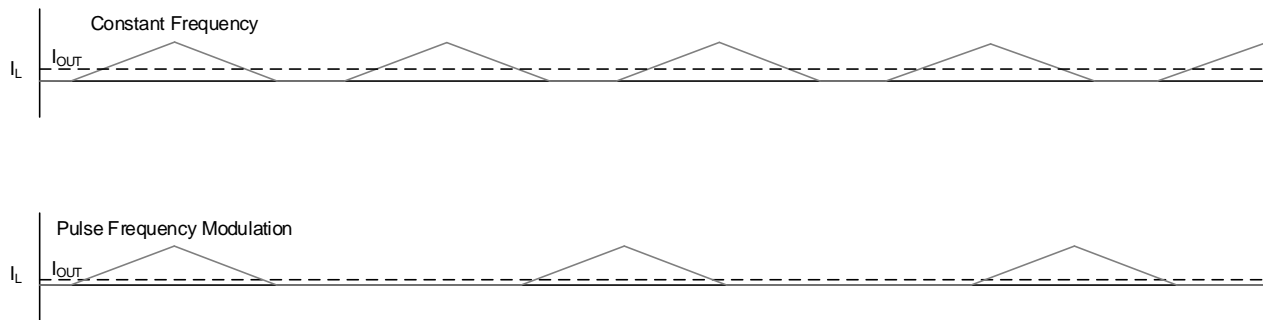

Figure 4. Constant Frequency vs Pulse Frequency Modulation: Inductor Current Waveform

2.4 Current Limit

Bucks also often implement a feature called current limit. Overload conditions and/or short-circuit conditions can pull excess current from V_{OUT} . This overload condition can cause the IC to overheat and damage the IC if not detected and protected against. Some ICs simply shut down, and others limit the current for a sufficiently heavy load.

The [LMR33620/30](#) and [LMR36006/15](#) use these features with further optimization. The next sections of this applications report explain the improvements made on each of these modes. To understand the foundation of this operation one must first understand the compensation curve as explained in [Section 3](#).

[Figure 6](#) shows the COMP curve for reference in [Figure 6](#). [Table 1](#) shows the different points of interest for each part number.

3 COMP Curve

The COMP signal is an internal control logic signal that represents the peak and valley inductor current commands. The COMP signal is the output of the error amplifier as shown in Figure 5.

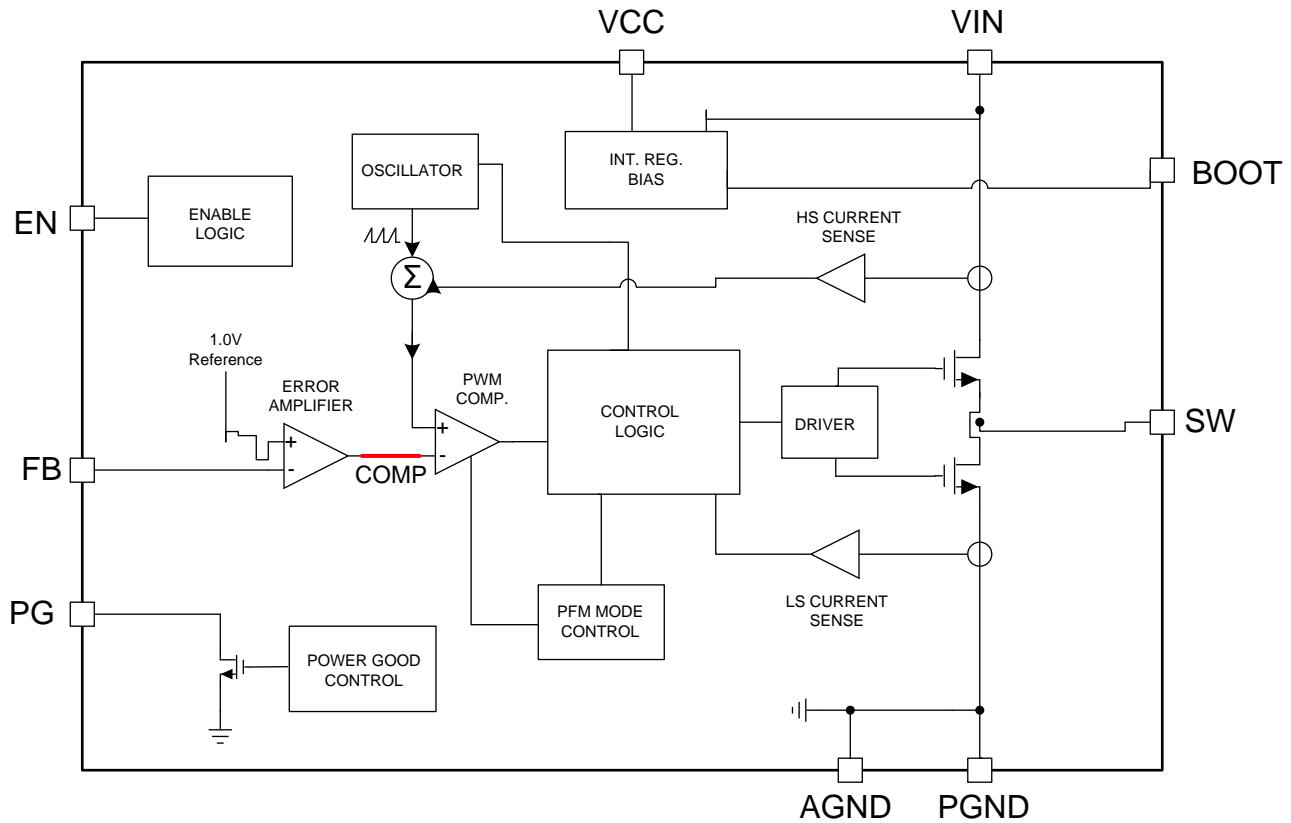

Copyright © 2017, Texas Instruments Incorporated

Figure 5. LMR33630 Block Diagram

Ultimately the COMP signal can be used to understand the modes of operation and the corresponding switching frequency. This section explains how the IC uses the COMP curve (Figure 6) to determine the mode of operation. For a more hands-on learning approach check out the frequency predictor tool (LMR33620/30/Q, LMR36006/15/Q). This tool takes operating conditions as inputs (V_{IN} , V_{OUT} , I_{OUT} , L, part number, selected frequency) and calculates the expected mode of operation and switching frequency for those conditions. The user can modify each parameter to see the effects.

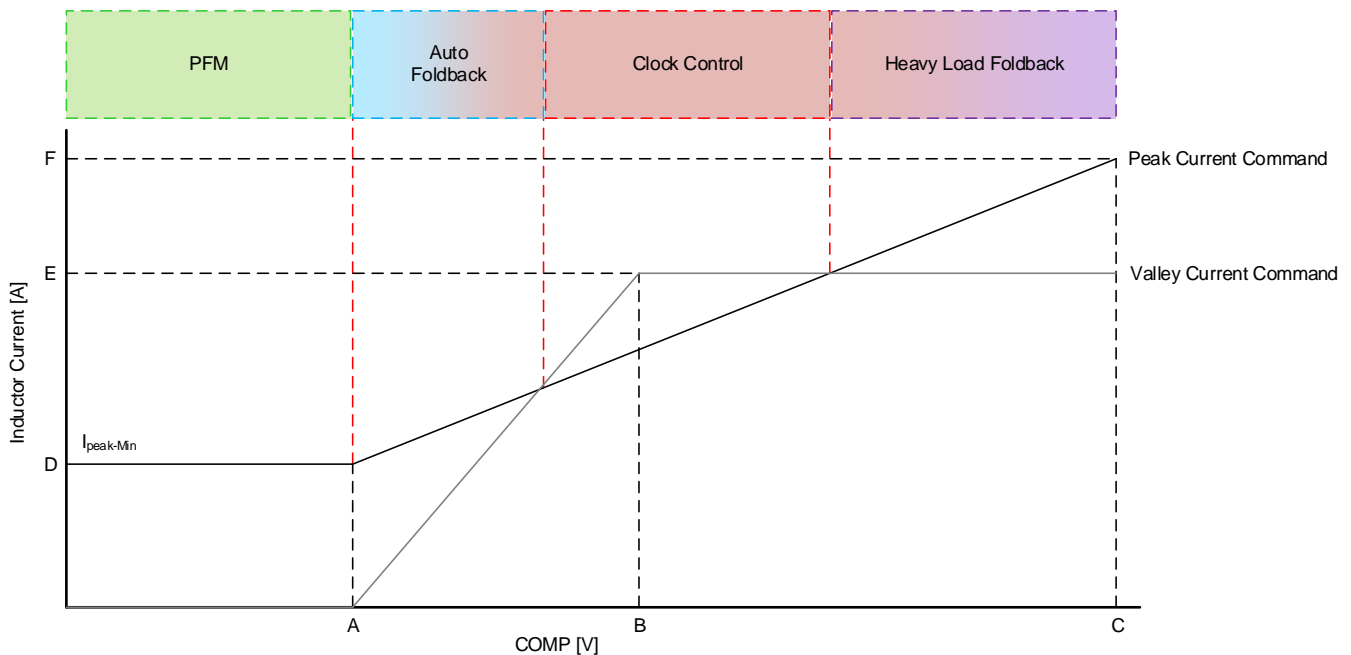
Figure 6. COMP Curve
Table 1. Values of Interest for LMR36006/15 and LMR33630/20

PART	A	B	C	D	E	F
LMR36006	0.21	0.55	1	0.21	0.8	1
LMR36006-Q1	0.21	0.55	1	0.21	0.8	1
LMR36015	0.2	0.55	1	0.48	1.8	2.4
LMR36015-Q1	0.2	0.55	1	0.48	1.8	2.4
LMR33620	0.19	0.55	1	0.65	2.45	3.5
LMR33620-Q1	0.19	0.55	1	0.65	2.45	3.5
LMR33630	0.18	0.55	1	0.8	3.5	4.5
LMR33630-Q1	0.18	0.55	1	0.8	3.5	4.5

The comp curve illustrates the logic behind when the converter will switch high and low in normal operating conditions.

The Y-axis shows the inductor current. Imagine the converter being at one point on this graph. That point moves up and down as the inductor current ramps up and down with load.

The X-axis shows the COMP voltage which is proportional to output current. The operating point on the graph moves right and left as the load gets heavier and lighter respectively.

The two lines on the comp curve are the peak current command and the valley current command.

Peak Current Command: The inductor current never ramps up above the peak current command (in normal operation). V_{SW} goes low when the inductor current reaches the peak current command. This causes I_L to ramp back down.

Valley Current Command: The inductor current always ramps down to, or past, the valley current command. V_{SW} never goes high before I_L reaches or passes the valley current command. V_{SW} goes high when the inductor current reaches the valley current command AND the clock is ready for a new switch cycle.

The converter operates at a particular frequency selected by the user, for example 400 kHz, 2.1 MHz, depending on the device number selected. This selected frequency is the maximum frequency switched by the converter. The COMP curve current command lines and operational logic dictate whether the converter operates at this frequency or whether it folds back (reduces) the switching frequency. Folding back reduces power dissipation, thus improving efficiency. The COMP curve has been designed to fold back the frequency at desired states of operating conditions which can be easily predicted and utilized to improve the efficiency of the system.

4 PFM and Light Load Operation

PFM in LMR33620/30 and LMR36006/15 is a light load condition that includes DCM (though not DCM at the set desired frequency) and the typical PFM frequency foldback. These features allow the converter to switch at very low switching frequencies which drastically reduces the operating input current.

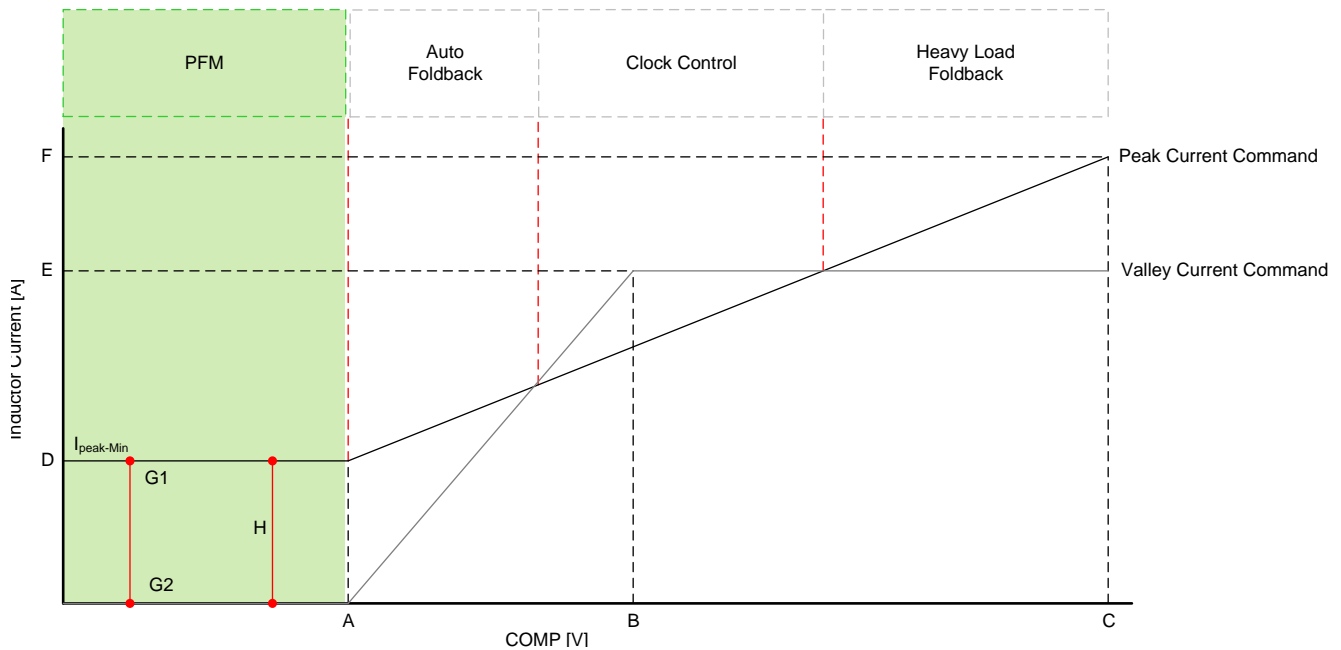

Figure 7. COMP Curve: PFM Operation

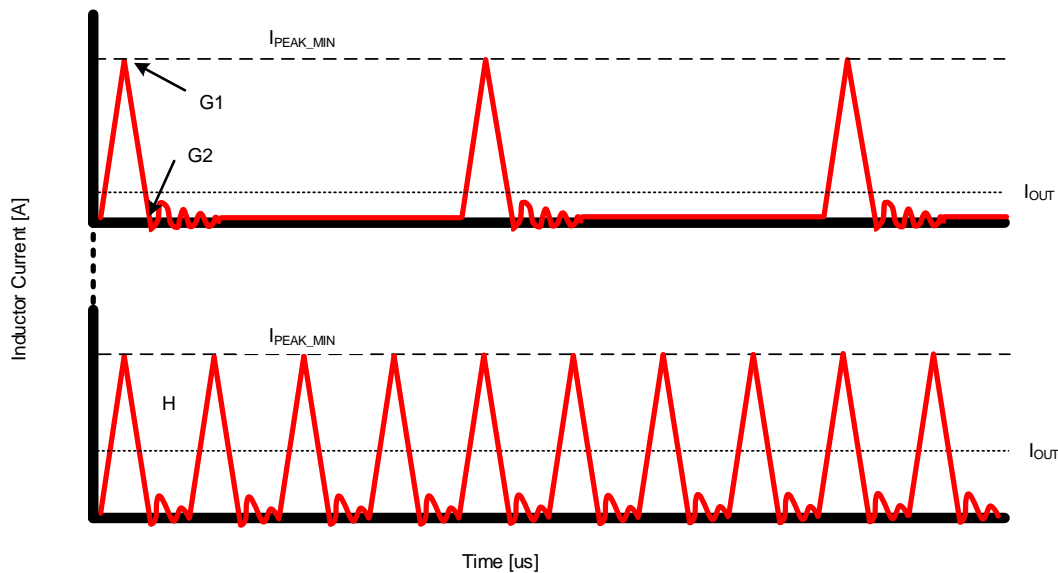

Figure 8. PFM Operation: Inductor Current

Figure 7 highlights the PFM region of the comp curve. Figure 8 shows the time-domain inductor current waveform for the same operating points as Figure 7. Markers G1 and G2 on Figure 7 and Figure 8 show a very light load operating condition. The inductor current ramps up to G1, hits the peak current command (I_{PEAK_MIN}) then ramps back down to G2 (zero amps). The inductor current reaches zero, then the converter shuts off both FETs, leaving V_{SW} floating. At this point there is a voltage across the inductor because the parasitic capacitance of the FETs has just been discharged by the low-side FET (V_{SW} is at 0 V) and V_{OUT} is at a non-zero V_{OUT} . This voltage pushes a bit of reverse current into the inductor causing it to ring with a frequency at the resonance of the inductor L and the parasitic capacitance of the FETs (see just after G2). This ringing is typically harmless unless it is at a frequency of interest in EMI measurements. The converter monitors the feedback voltage until the voltage drops sufficiently low, then it turns V_{SW} back on. This is what controls the frequency of the PFM.

Increased I_{OUT} means the converter operates farther to the right on the X axis. The pulse frequency increases as the load current increases as seen at marking H on Figure 7 and Figure 8. V_{OUT} drops faster between pulses as I_{OUT} increases, which results in a higher switching frequency. Sufficiently high I_{OUT} causes the end of the inductor current ramp down to align with the beginning of the inductor current ramp up. This is the start of CCM that brings the converter to the next operating region – automatic frequency foldback.

Note that PFM and auto frequency foldback are not always preferable, for example in systems that require a fixed switching frequency at all times. The LMR36006/15 has an version which enables forced pulse width modulation (FPWM) for these occasions. The device operates at the chosen frequency at all times and does not use PFM or auto mode. FPWM operation reduces efficiency at light to mid-light loads but it may be worth the sacrifice in some systems.

5 Automatic Frequency Foldback

Automatic frequency foldback is a feature unique to LMR33620/30 and LMR36006/15. This region acts as a smooth transition from PFM to fixed-frequency CCM. The converter folds back the frequency in mid-light load conditions to improve efficiency as we can see in Figure 9 and Figure 10.

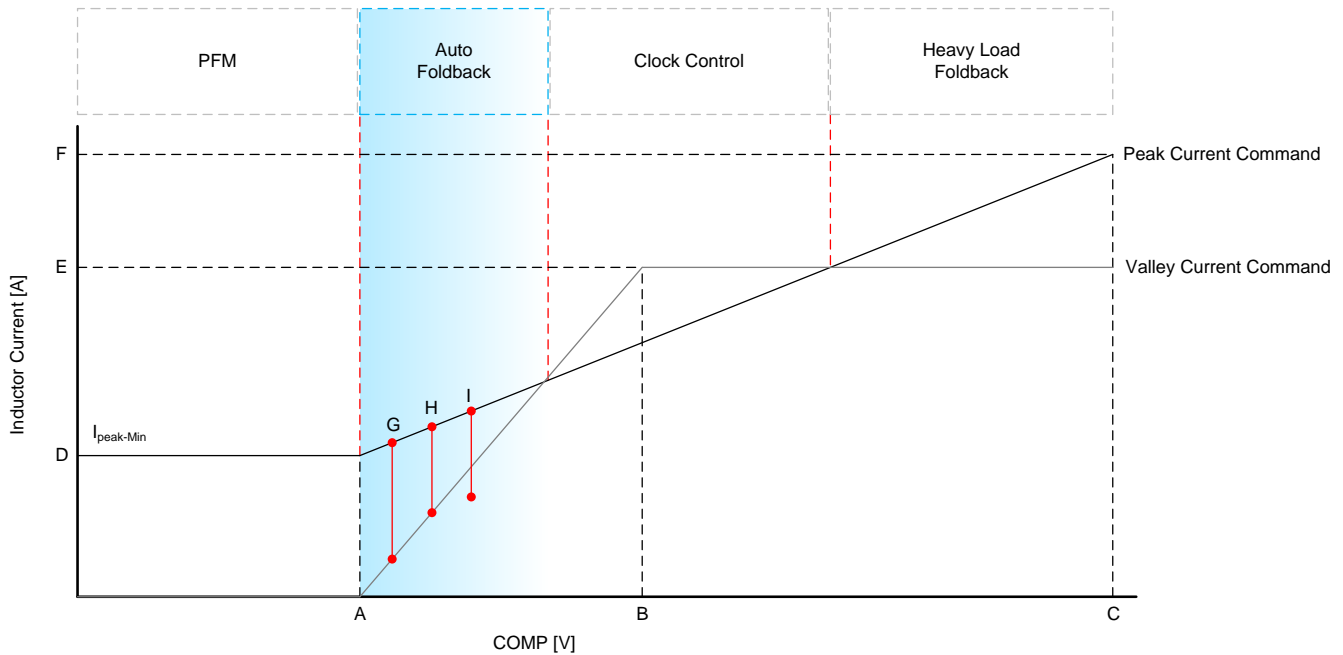

Figure 9. COMP Curve: Auto Foldback Operation

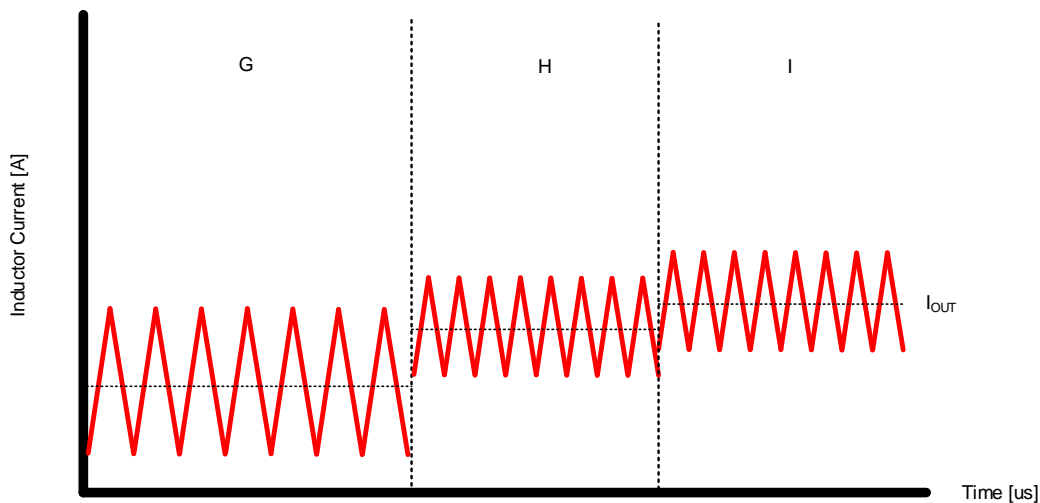

Figure 10. Auto Foldback Operation: Inductor Current Waveform

Region G shows a mid-light load condition. The converter has just exited PFM, and it still requires the inductor current to ramp all the way down to the valley current command before turning the switch back on. This reduced switching frequency results in higher efficiency than at a higher frequency. Often efficiency curves have a drop in efficiency at the transition between PFM/DCM and PWM/CCM but this auto foldback maintains good efficiency at this region.

Region H shows the point where the converter starts operating at the fixed frequency selected by the user. The valley current command line approaches the peak current command line as the output current increases, which means the frequency increases as the output current increases. Eventually the switching frequency reaches the frequency selected by the user at which point the inductor current naturally ramps below the valley current command before the clock triggers SW to turn back on. Prior regions would detect the clock signal but would not be able to switch V_{SW} high because I_L had not reached the valley current

command. Now the inductor current has reached/passed the valley current command so the timing of V_{SW} turning back on is dictated by the clock. Different designs have different operating conditions (V_{IN} , V_{OUT} , L , switching frequency) meaning the point where this auto foldback reaches fixed frequency is different for each unique condition. This applications report helps designers understand the conditions of these operating mode transition points.

Region I shows the continuation of this fixed frequency region in the auto mode. The inductor current waveform does not change shape or frequency; it simply shifts up with increasing load. This is essentially an early entrance into clock control hence the faded blue region in Figure 10.

6 Clock Control

Clock control is the standard fixed-frequency CCM operation in mid and heavy loads. Figure 11 and Figure 12 show the expected operation. As I_{OUT} increases the inductor current waveform shifts upward. This is typical among essentially all buck converters.

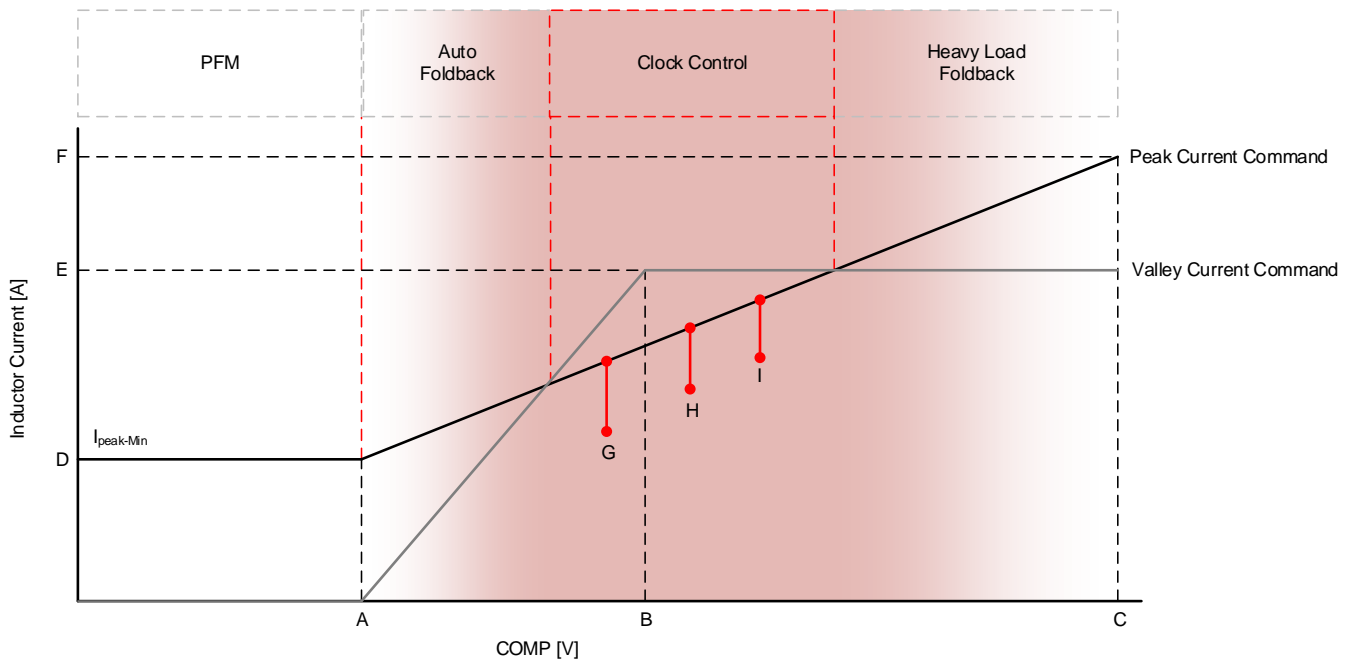

Figure 11. COMP Curve: Clock Control Operation

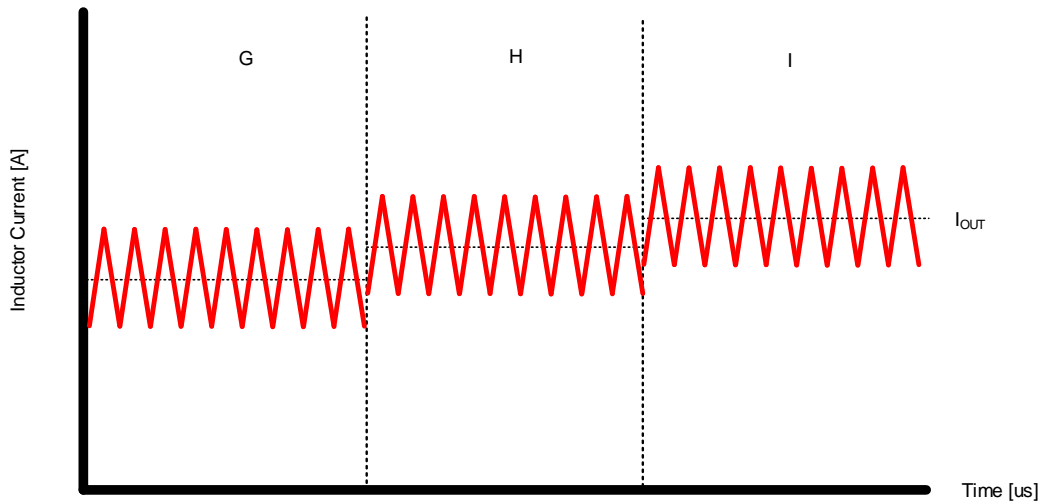

Figure 12. Clock Control Operation: Inductor Current Waveform

7 Heavy Load Foldback, Current Limit, and Hiccup

Most modern converters implement current limit protection. The [LMR33620/30](#) and [LMR36006/15](#) use an advanced control scheme to determine how to switch to prevent current runaway and damage to themselves and other components, and decide how to handle overload and short circuit conditions.

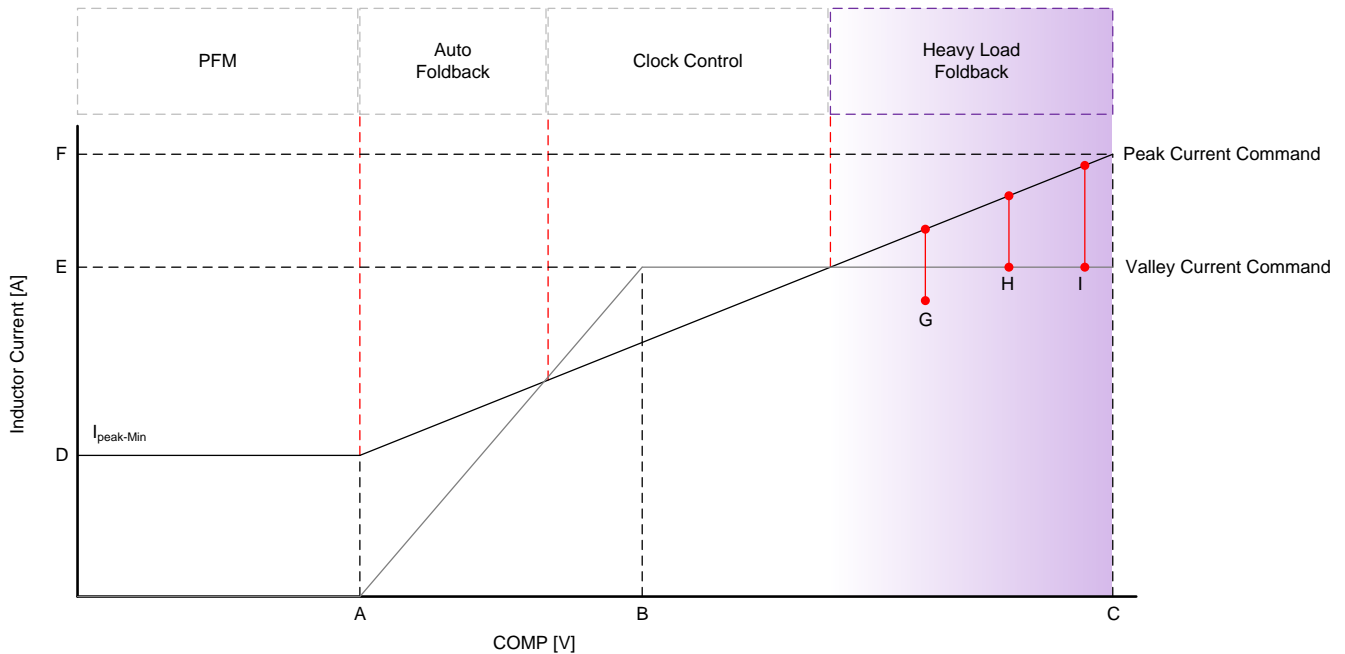

Figure 13. COMP Curve: Current Limit Operation

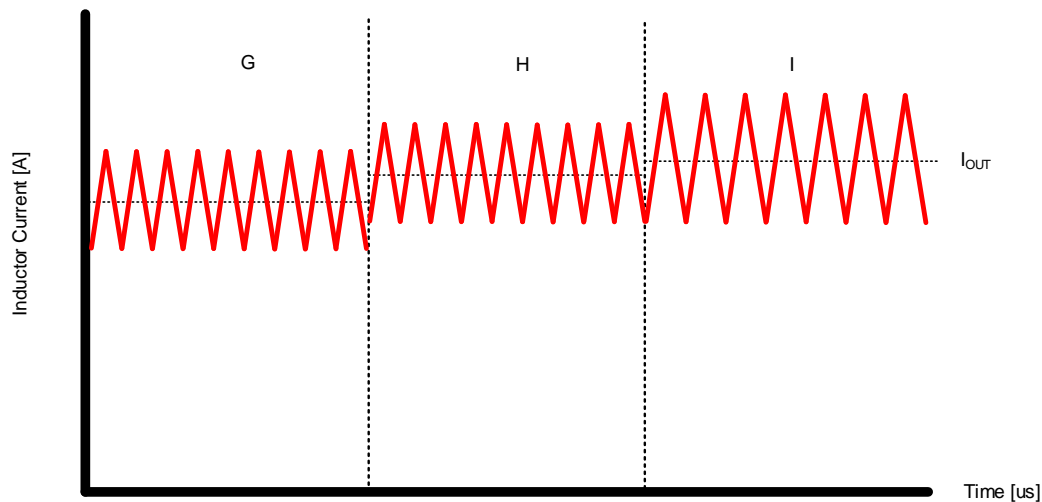

Figure 14. Current Limit Operation: Inductor Current Waveform

The comp curve shows the first line of defense against overcurrent conditions, as shown in [Figure 13](#) and [Figure 14](#). The valley current command comes back into play at sufficiently high output currents. Region G shows normal operation entering the heavy load foldback region. Region H shows the point at which the converter transitions from normal operation to actively folding back the frequency. Region I shows how the converter requires the inductor current to drop down to the valley current limit. This reduces the switching frequency and ensures the current does not rise too high. By lowering the average output current this peak current command prevents the inductor current from ramping out of control or current run away and causing inductor saturation. The valley current command ensures the current never exceeds a certain value.

The second line of defense is peak current limit. The COMP voltage clamps at 1 V. This means the output current stops rising even if the load demands it. For example [LMR33630-Q1](#) has a peak current command value of 4.5 A and a valley current command value of 3.5 A at $V_{COMP} = 1$ V. The inductor current at maximum load ramps between these two command lines meaning the output current clamps at 4 A (the average of 3.5 A and 4.5 A). The output voltage starts to droop when the load demands more current than available from the converter. Too much output voltage droop and the converter enters hiccup mode.

The third line of defense against overload and short circuit conditions is hiccup mode. Hiccup mode shuts off the converter for some 10's of milliseconds (see [LMR33630-Q1 data sheet](#)), then turns back on and checks if the fault has been removed as seen in [Figure 15](#). If the fault is still present, the converter hits hiccup again, waits another 10's of milliseconds and keeps trying until the fault is removed. Once the fault is removed, the converter operates normally again. Hiccup triggers when the output voltage droops to 40% of the design value or below (see [LMR33630-Q1 data sheet](#) for specifics). Hiccup occurs in short-circuit conditions or very heavy load conditions. Hiccup allows the converter to use significantly less energy than a converter that continues to switch in such conditions. Hiccup protection keeps the converter at a low temperature in short-circuit conditions and does not waste energy trying to regulate.

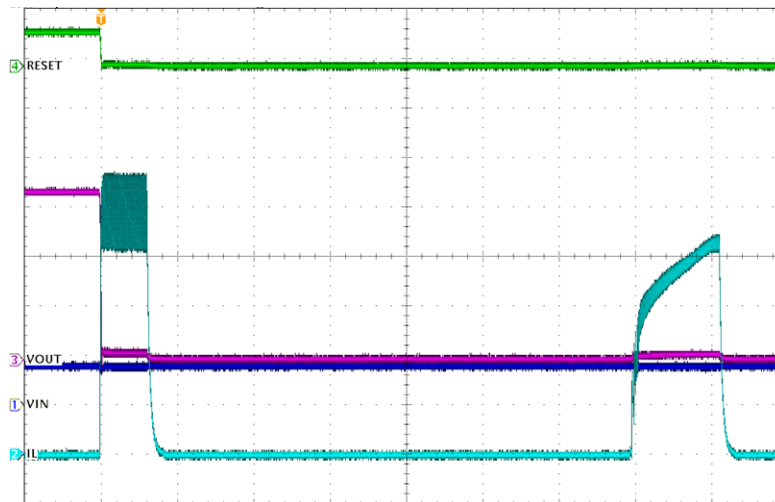

Figure 15. Hiccup Operation

8 Summary

The [LMR33620/30](#) and [LMR36006/15](#) represent the culmination of decades of research in buck control architectures. These devices not only contain typical features such as enable, internal UVLO, power good, they also use advanced PFM, state-of-the-art auto foldback, and a high-utility combination of current-limit features. These devices can be used to design a cutting-edge power solution. For product data sheets and example power reference designs with the LMR36006, LMR36015, LMR33620, and LMR33630 see the references in [Section 9](#).

9 References

- [LMR33630 SIMPLE SWITCHER™ 3.8-V to 36-V, 3-A Synchronous Step-Down Voltage Converter](#)
- [LMR33630-Q1 SIMPLE SWITCHER™ 3.8-V to 36-V, 3-A Synchronous Step-Down Voltage Converter](#)
- [LMR33620 SIMPLE SWITCHER™ 3.8-V to 36-V, 2-A Synchronous Step-Down Voltage Converter](#)
- [LMR33620-Q1 SIMPLE SWITCHER™ 3.8-V to 36-V, 2-A Synchronous Step-Down Voltage Converter](#)
- [LMR36015 4.2-V to 60-V, 1.5-A Ultra-Small Synchronous Step-Down Converter](#)
- [LMR36015-Q1 4.2-V to 60-V, 1.5-A Ultra-Small Synchronous Step-Down Converter](#)
- [LMR36006 4.2-V to 60-V, 0.6-A Ultra-Small Synchronous Step-Down Converter](#)
- [LMR36006-Q1 4.2-V to 60-V, 0.6-A Ultra-Small Synchronous Step-Down Converter](#)
- [Two-Stage Power Supply Reference Design for Field Transmitters](#)
- [Wide Vin Power Supply Reference Design for Space-Constrained Industrial Sensors](#)
- [Automotive ADAS camera power supply reference design optimized for solution size and low noise](#)
- [Compact, efficient, 24-V input auxiliary power supply reference design for servo drives](#)
- [Introduction to Buck Converter Features: UVLO, Enable, Soft Start, Power Good](#)
- [Introduction to Buck Converters: Understanding Mode Transitions](#)
- [Introduction to Buck Converters: Minimum On-time and Minimum Off-time Operation](#)
- [Introduction to Buck Converters: Understanding Quiescent Current Specifications](#)

IMPORTANT NOTICE AND DISCLAIMER

TI PROVIDES TECHNICAL AND RELIABILITY DATA (INCLUDING DATASHEETS), DESIGN RESOURCES (INCLUDING REFERENCE DESIGNS), APPLICATION OR OTHER DESIGN ADVICE, WEB TOOLS, SAFETY INFORMATION, AND OTHER RESOURCES "AS IS" AND WITH ALL FAULTS, AND DISCLAIMS ALL WARRANTIES, EXPRESS AND IMPLIED, INCLUDING WITHOUT LIMITATION ANY IMPLIED WARRANTIES OF MERCHANTABILITY, FITNESS FOR A PARTICULAR PURPOSE OR NON-INFRINGEMENT OF THIRD PARTY INTELLECTUAL PROPERTY RIGHTS.

These resources are intended for skilled developers designing with TI products. You are solely responsible for (1) selecting the appropriate TI products for your application, (2) designing, validating and testing your application, and (3) ensuring your application meets applicable standards, and any other safety, security, or other requirements. These resources are subject to change without notice. TI grants you permission to use these resources only for development of an application that uses the TI products described in the resource. Other reproduction and display of these resources is prohibited. No license is granted to any other TI intellectual property right or to any third party intellectual property right. TI disclaims responsibility for, and you will fully indemnify TI and its representatives against, any claims, damages, costs, losses, and liabilities arising out of your use of these resources.

TI's products are provided subject to TI's Terms of Sale (www.ti.com/legal/termsofsale.html) or other applicable terms available either on ti.com or provided in conjunction with such TI products. TI's provision of these resources does not expand or otherwise alter TI's applicable warranties or warranty disclaimers for TI products.

Mailing Address: Texas Instruments, Post Office Box 655303, Dallas, Texas 75265
Copyright © 2019, Texas Instruments Incorporated