

LMZ36002

Simple Switcher® Power Module Evaluation Module

The LMZ36002EVM evaluation module is designed as an easy-to-use platform that facilitates an extensive evaluation of the features and performance of the Simple Switcher® power module. This guide provides information on the correct usage of the EVM and an explanation of the numerous test points on the board.

1 Description

This EVM features the LMZ36002 synchronous buck power module configured for operation with typical 12-V to 60-V input bus applications. The output voltage can be set to one of five popular values by using a configuration jumper. In similar fashion, the switching frequency can be set to one of five values with a jumper. The full output current rating of the device can be supplied by the EVM. Input and output capacitors are included on the board to accommodate the entire range of input and output voltages. Monitoring test points are provided to allow measurement of efficiency, power dissipation, input ripple, output ripple, line and load regulation, and transient response. Control test points are provided for use of the slow-start/tracking, Inhibit/UVLO, PWRGD, and synchronization features of the LMZ36002 device. The EVM uses a recommended PCB layout that maximizes thermal performance and minimizes output ripple and noise.

2 Getting Started

[Figure 1](#) highlights the user interface items associated with the EVM. The polarized *PVin* Power terminal block (TB1) is used for connection to the host input supply and the polarized *Vout* Power terminal block (TB2) is used for connection to the load. These terminal blocks can accept up to 16-AWG wire. Verify the polarity of the PVIN and PGND connections for TB1 based on the label beneath the terminal block.

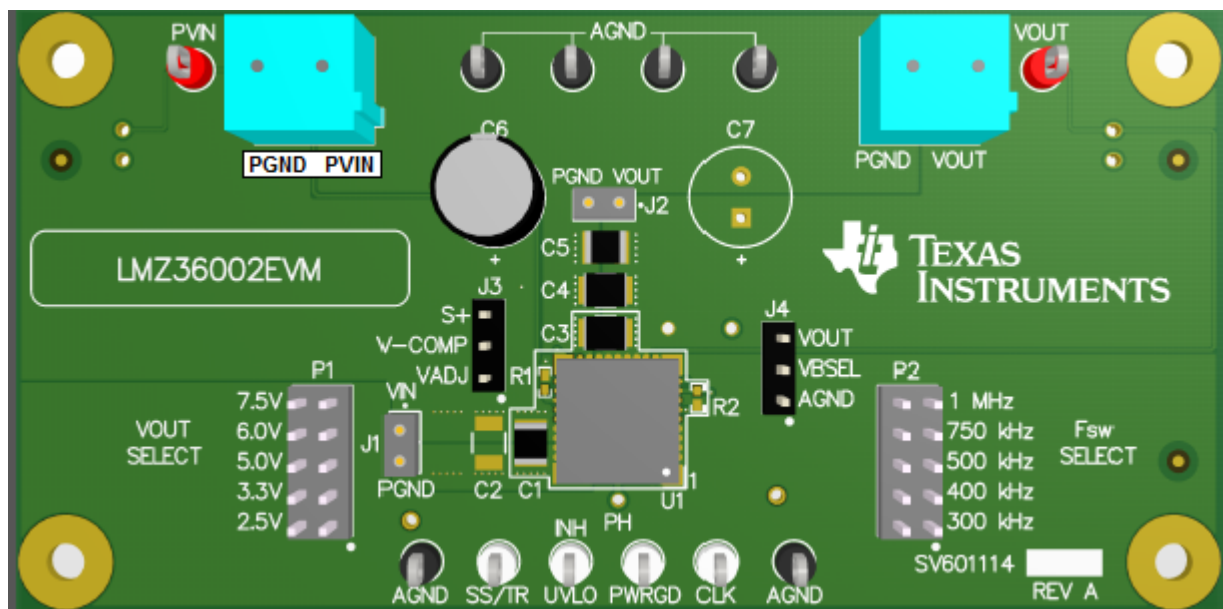

Figure 1. LMZ36002EVM User Interface

The *PVin Monitor* and *Vout Monitor* test points located near the power terminal blocks are intended to be used as voltage monitoring points where voltmeters can be connected to measure PVin and Vout. The voltmeter references should be connected to any of the four *PVin/Vout Monitor Grounds* test points located between the power terminal blocks (labeled AGND). Do *not* use these PVin and Vout monitoring test points as the input supply or output load connection points. The PCB traces connecting to these test points are not designed to support high currents.

The *PVin Scope* (J1) and *Vout Scope* (J2) test points can be used to monitor PVin and Vout waveforms with an oscilloscope. These test points are intended for use with un-hooded scope probes outfitted with a low-inductance ground lead (ground spring) mounted to the scope barrel. The two sockets of each test point are on 0.1 in centers. The scope probe tip should be connected to the socket labeled VIN or VOUT, and the scope ground lead should be connected to the socket labeled PGND.

The controls test points located directly below the device are made available to test the features of the device. Any external connections made to these test points should be referenced to the AGND test point located along the bottom of the EVM. Refer to the [Test Points Descriptions](#) section of this guide for more information on the individual control test points.

The *Vout Select* jumper (P1) and *Fsw Select* jumper (P2) are provided for selecting the desired output voltage and appropriate switching frequency. Before applying power to the EVM, ensure that the jumpers are present and properly positioned for the intended output voltage. Refer to [Table 1](#) for the recommended jumper settings. Always remove input power before changing the jumper settings.

Once the jumper settings have been confirmed, configure the host input supply to apply the appropriate bus voltage listed in [Table 1](#) and confirm that the selected output voltage is obtained.

Table 1. Output Voltage and Switching Frequency Jumper Settings

LMZ36002	
Vout Select	Fsw Select
2.5 V	300 kHz
3.3 V	300 kHz
5.0 V	500 kHz
6.0 V	500 kHz
7.5 V	500 kHz

The Versa-Comp settings can be adjusted using jumper J3. The Versa-Comp feature of the LMZ36002 provides the user with a simple method of adjusting the module's internal compensation network to provide the optimized phase and gain margin based on the output voltage and amount of output capacitance. Remove the jumper from J3 when operating the EVM as received from the factory. When operating the EVM with additional output capacitance, see the LMZ36002 datasheet for Versa-Comp settings.

Jumper J4 allows the user to select the input source of the internal bias circuitry to improve efficiency. For output voltages $\geq 4.5V$, place the jumper across the center and top position of J4. For output voltages $< 4.5V$, place the jumper across the center and bottom position of J4.

3 Test Point Descriptions

Twelve wire-loop test points and two scope probe test points have been provided as convenient connection points for digital voltmeters (DVM) or oscilloscope probes to aid in the evaluation of the device. A description of each test point follows:

Table 2. Test Point Descriptions⁽¹⁾

PVIN	Input voltage monitor. Connect DVM to this point for measuring efficiency.
VOUT	Output voltage monitor. Connect DVM to this point for measuring efficiency, line regulation, and load regulation.
AGND	Input and output voltage monitor grounds (located between terminal blocks). Reference the above DVMs to any of these four analog ground points.

⁽¹⁾ Refer to the LMZ36002/H datasheet for absolute maximum ratings associated with above features.

Table 2. Test Point Descriptions⁽¹⁾ (continued)

PVIN Scope (J1)	Input voltage scope monitor. Connect an oscilloscope to this set of points to measure input ripple voltage.
VOUT Scope (J2)	Output voltage scope monitor. Connect an oscilloscope to this set of points to measure output ripple voltage and transient response.
PWRGD	Monitors the power good signal of the device. This is an open drain signal that requires an external pullup resistor if monitoring is desired. A 10-k Ω to 100-k Ω pullup resistor is recommended. PWRGD is high if the output voltage is within 92% to 107% of its nominal value.
INH/UVLO	Connect this point to control ground to inhibit the device. Allow this point to float to enable the device. An external resistor divider can be connected between this point, control ground, and V_{in} to adjust the UVLO of the device.
CLK	Connects to the CLK pin of the device. An external clock signal can be applied to this point to synchronize the device to an appropriate frequency.
SS/TR	Connects to the internal slow-start capacitor of the device. An external capacitor can be connected from this point to control ground to increase the slow-start time of the device. This point can also be used as for tracking applications.
AGND	Control ground (located along bottom of EVM). Reference any signals associated with the control test points to this analog ground point.

4 Operation Notes

In order to operate the EVM apply a voltage in the range of 4.5V to 60V for the LMZ36002. The UVLO threshold of the EVM is approximately 4 V with 0.4 V of hysteresis. The input voltage must be above the UVLO threshold in order for the device to startup. After startup, the minimum input voltage to the device must be at least 4.5 V or ($V_{out} + 2 V$), whichever is greater. Refer to the LMZ36002 datasheet for further information on the input voltage range and UVLO operation.

After application of the proper input voltage, the output voltage of the device will ramp to its final value in approximately 4.1 ms. If desired, this soft-start time can be increased by adding a capacitor to the SS/TR test point as described above. Refer to the LMZ36002 datasheet for further information on adjusting the soft-start time.

[Table 1](#) lists the recommended switching frequencies for each of the V_{out} selections. These recommendations cover operation over a wide range of input voltage and output load conditions. Several factors such as duty cycle, minimum on-time, minimum off-time, and current limit influence selection of the appropriate switching frequency. In some applications, other switching frequencies might be used for particular output voltages, depending on the above factors. Refer to the LMZ36002 datasheet for further information on switching frequency selection, including synchronization.

The EVM includes input and output capacitors to accommodate the entire range of input and output voltage conditions. The actual capacitance required will depend on the input and output voltage conditions of the particular application, along with the desired transient response. In most cases, the required output capacitance will be less than that supplied on the EVM. Refer to the LMZ36002 datasheet for further information on the minimum required input and output capacitance.

5 Performance Data

[Figure 2](#) through [Figure 7](#) demonstrate the LMZ36002EVM performance. For more data regarding the LMZ36002 please see the product data sheet.

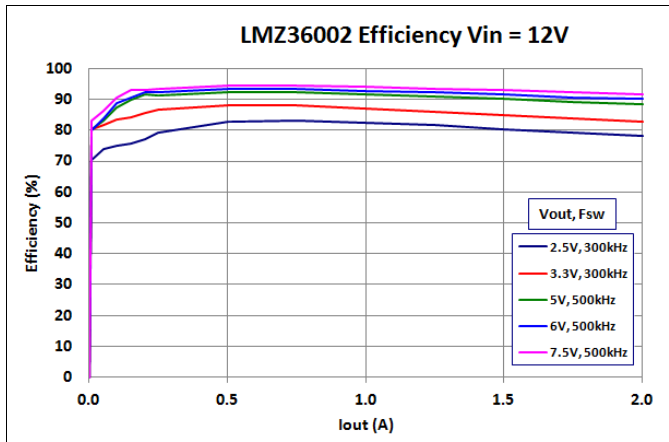

Figure 2. LMZ36002EVM Efficiency (Vin = 12V)

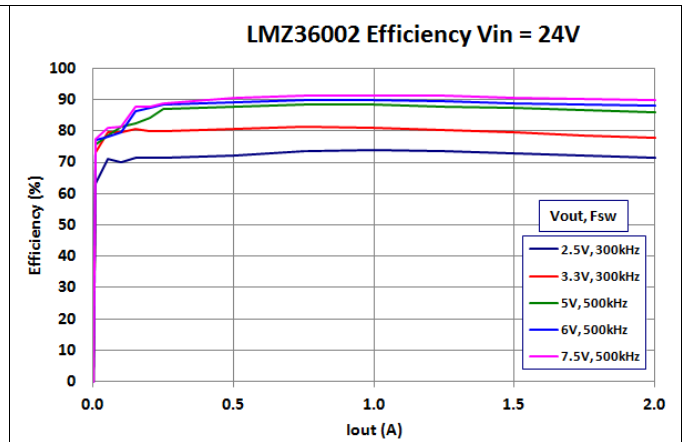

Figure 3. LMZ36002EVM Efficiency (Vin = 24V)

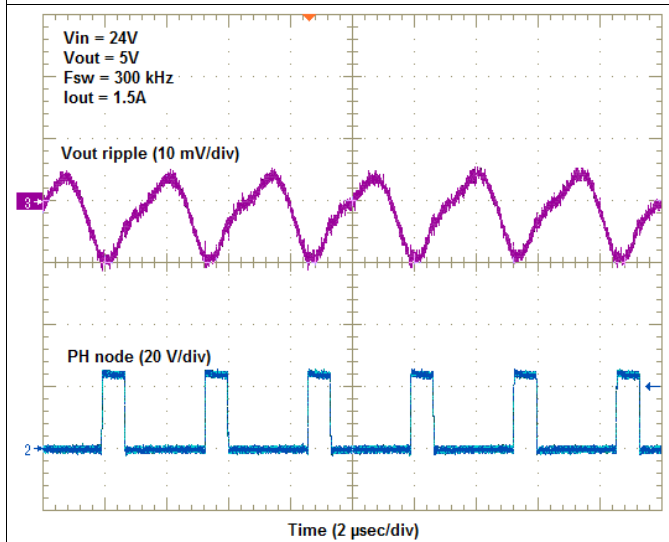

Figure 4. LMZ36002EVM Ripple Voltage (Fsw = 300 KHz)

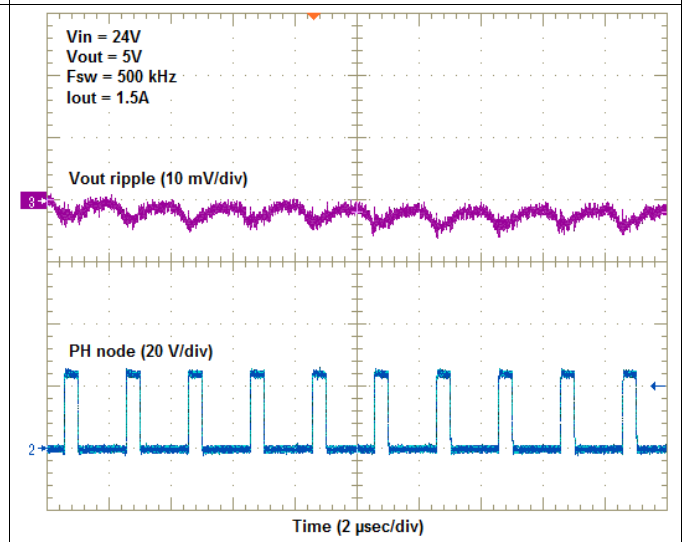

Figure 5. LMZ36002EVM Ripple Voltage (Fsw = 500 KHz)

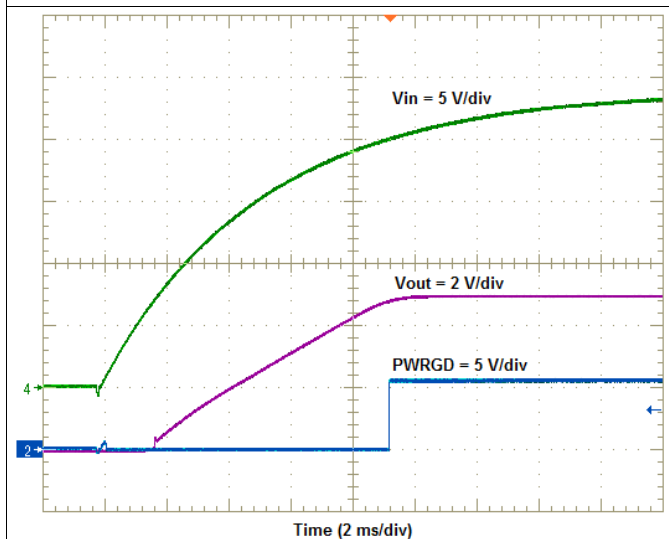

Figure 6. LMZ36002EVM Start-up Waveforms

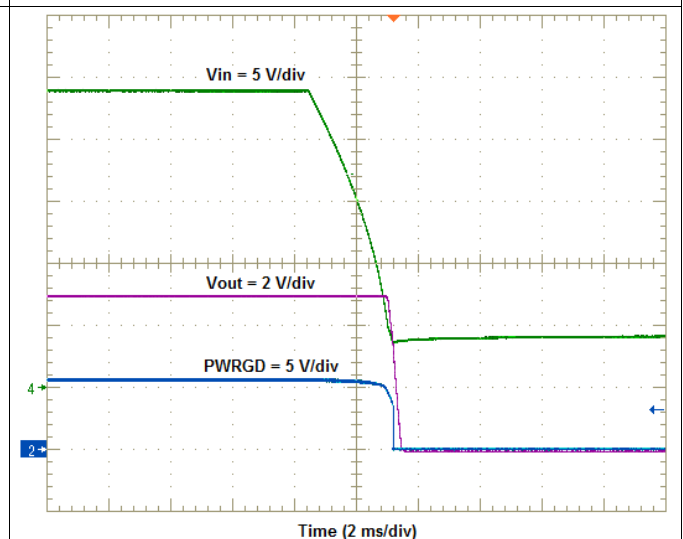

Figure 7. LMZ36002EVM Shut-down Waveforms

6 Schematic

Figure 8 is the schematic for this EVM.

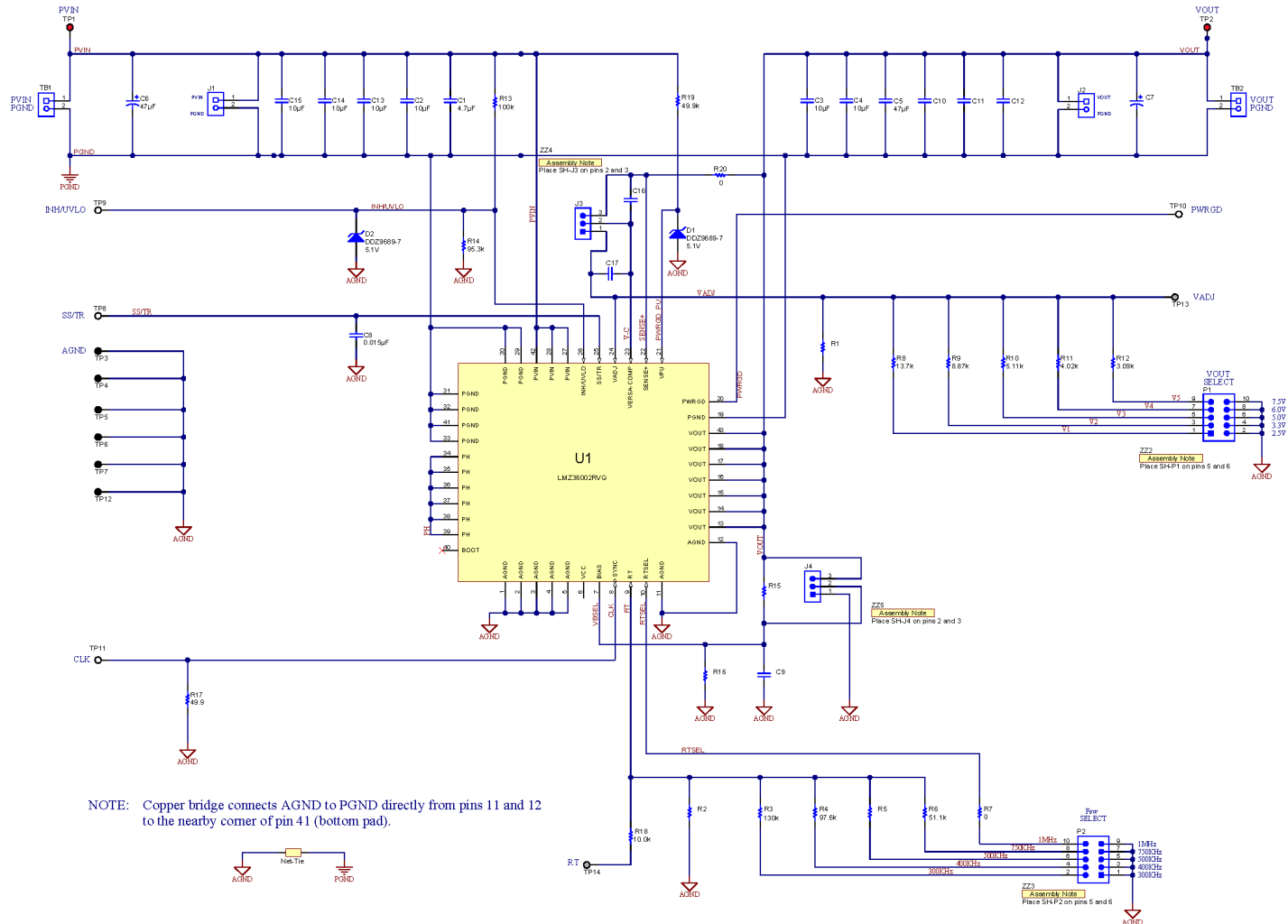

Figure 8. LMZ3602EVM Schematic

7 Bill of Materials

Figure 9 is the BOM for the EVM.

Quantity	Designator	Value	Description	Package Reference	Part Number	Manufacturer
1	PCB	PCB	Printed Circuit Board		SV601114	Any
1	C1	4.7uF	CAP, CERM, 4.7uF, 100V, 20%, X7S, 1210 (H=2.0mm)	1210	C3225X7S2A475M200AB	TDK
2	C3, C4	10uF	CAP, CERM, 10uF, 50V, +/-10%, X5R, 1210 (H=2.5mm)	1210	C3225X5R1H106K250AB	TDK
1	C5	47uF	CAP, CERM, 47 uF, 16 V, +/- 10%, X5R, 1210	1210	GRM32ER61C476KE15L	MuRata
1	C6	47uF	CAP, AL, 47 uF, 100 V, +/- 20%, 0.14 ohm, TH	D8xL15mm	EKZN101ELL470MH15D	Chemi-Con
1	C8	0.015uF	CAP, CERM, 0.015 uF, 100 V, +/- 10%, X7R, 0603	0603	C0603C153K1RACTU	Kemet
2	D1, D2	5.1V	Diode, Zener, 5.1 V, 500 mW, SOD-123	SOD-123	DDZ9689-7	Diodes Inc.
2	J1, J2	2pin Socket	Socket Strip, 2x1, 100mil, Black, Tin, TH	Socket Strip, 100mil, 2pin	310-43-102-41-001000	Mill-Max
2	J3, J4	PEC03SAAN	Header, 100mil, 3x1, Tin, TH	Header, 3 PIN, 100mil, Tin	PEC03SAAN	Sullins Connector Solutions
2	P1, P2	PEC05DAAN	Header, 100mil, 5x2, Tin, TH	Header, 5x2, 100mil, Tin	PEC05DAAN	Sullins Connector Solutions
1	R3	130k	RES, 130 k, 1%, 0.1 W, 0603	0603	CRCW0603130KFKEA	Vishay-Dale
1	R4	97.6k	RES, 97.6 k, 1%, 0.1 W, 0603	0603	CRCW060397K6FKEA	Vishay-Dale
1	R6	51.1k	RES, 51.1 k, 1%, 0.1 W, 0603	0603	CRCW060351K1FKEA	Vishay-Dale
2	R7, R20	0	RES, 0, 5%, 0.1 W, 0603	0603	CRCW06030000Z0EA	Vishay-Dale
1	R8	13.7k	RES, 13.7 k, 1%, 0.1 W, 0603	0603	CRCW060313K7FKEA	Vishay-Dale
1	R9	8.87k	RES, 8.87 k, 1%, 0.1 W, 0603	0603	CRCW06038K87FKEA	Vishay-Dale
1	R10	5.11k	RES, 5.11 k, 1%, 0.1 W, 0603	0603	CRCW06035K11FKEA	Vishay-Dale
1	R11	4.02k	RES, 4.02 k, 1%, 0.1 W, 0603	0603	CRCW06034K02FKEA	Vishay-Dale
1	R12	3.09k	RES, 3.09 k, 1%, 0.1 W, 0603	0603	CRCW06033K09FKEA	Vishay-Dale
1	R13	100k	RES, 100 k, 1%, 0.125 W, 0805	0805	CRCW0805100KFKEA	Vishay-Dale
1	R14	95.3k	RES, 95.3 k, 1%, 0.1 W, 0603	0603	CRCW060395K3FKEA	Vishay-Dale
1	R17	49.9	RES, 49.9, 1%, 0.25 W, 1206	1206	CRCW120649R9FKEA	Vishay-Dale
1	R18	10.0k	RES, 10.0 k, 1%, 0.1 W, 0603	0603	CRCW060310K0FKEA	Vishay-Dale
1	R19	49.9k	RES, 49.9 k, 1%, 0.125 W, 0805	0805	CRCW080549K9FKEA	Vishay-Dale
4	SH-J3, SH-J4, SH-P1, SH-P2	1x2	Shunt, 2mm, Gold plated, Black	2mm Shunt, Closed Top	2SN-BK-G	Samtec
2	TB1, TB2	ED120/2DS	TERMINAL BLOCK 5.08MM VERT 2POS, TH	TERM_BLK, 2pos, 5.08mm	ED120/2DS	On-Shore Technology
2	TP1, TP2	Red	Test Point, Multipurpose, Red, TH	Red Multipurpose Testpoint	5010	Keystone
6	TP3, TP4, TP5, TP6, TP7, TP12	Black	Test Point, Multipurpose, Black, TH	Black Multipurpose Testpoint	5011	Keystone
4	TP8, TP9, TP10, TP11	White	Test Point, Multipurpose, White, TH	White Multipurpose Testpoint	5012	Keystone
1	U1	LMZ36002	2A SIMPLE SWITCHER Power Module, 4.5V-60V Input, 2.5V-7.5V Output, QFN Package, RVQ0043A	RVQ0043A	LMZ36002RVQ	Texas Instruments
0	C2, C13, C14, C15	4.7uF	CAP, CERM, 4.7uF, 100V, 20%, X7S, 1210 (H=2.0mm)	1210	C3225X7S2A475M200AB	TDK
0	C7	100uF	CAP, AL, 100 uF, 50 V, +/- 20%, 0.12 ohm, TH	CAP, 8x11.5mm	50ZLJ100MT78X11.5	Rubycon
0	C9	1000pF	CAP, CERM, 1000 pF, 50 V, +/- 5%, C0G/NP0, 0603	0603	C0603C102J5GACTU	Kemet
0	C10, C11, C12	47uF	CAP, CERM, 47 uF, 16 V, +/- 10%, X5R, 1210	1210	GRM32ER61C476KE15L	MuRata
0	C16, C17	220pF	CAP, CERM, 220 pF, 50 V, +/- 5%, C0G/NP0, 0603	0603	C0603C221J5GACTU	Kemet
0	R1, R2	0	RES, 0, 5%, 0.063 W, 0402	0402	ERJ-2GE0R00X	Panasonic
0	R5, R15, R16	0	RES, 0, 5%, 0.1 W, 0603	0603	CRCW06030000Z0EA	Vishay-Dale

Figure 9. LMZ36002 Bill Of Material

8 PCB Layout

Figure 10 through Figure 17 show the PCB layers of the LMZ36002HEVM. The layout is the same for the LMZ36002EVM.

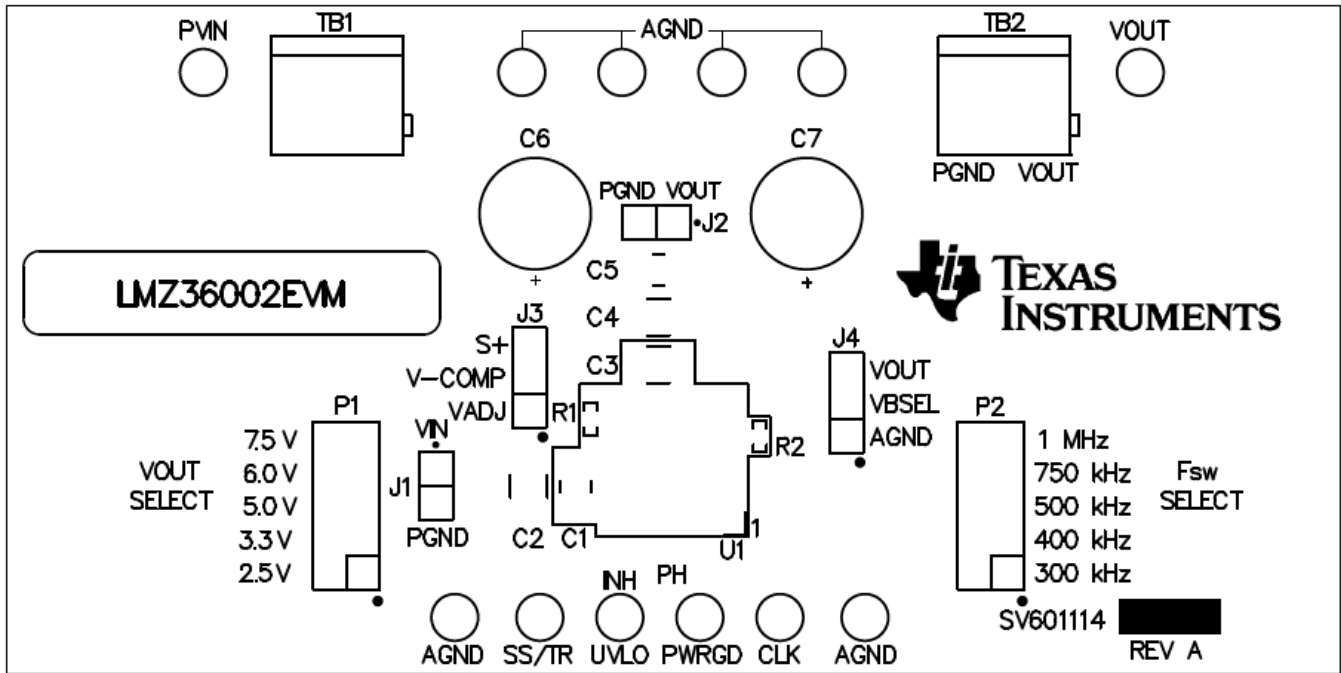

Figure 10. LMZ36002HEVM Topside Component Layout

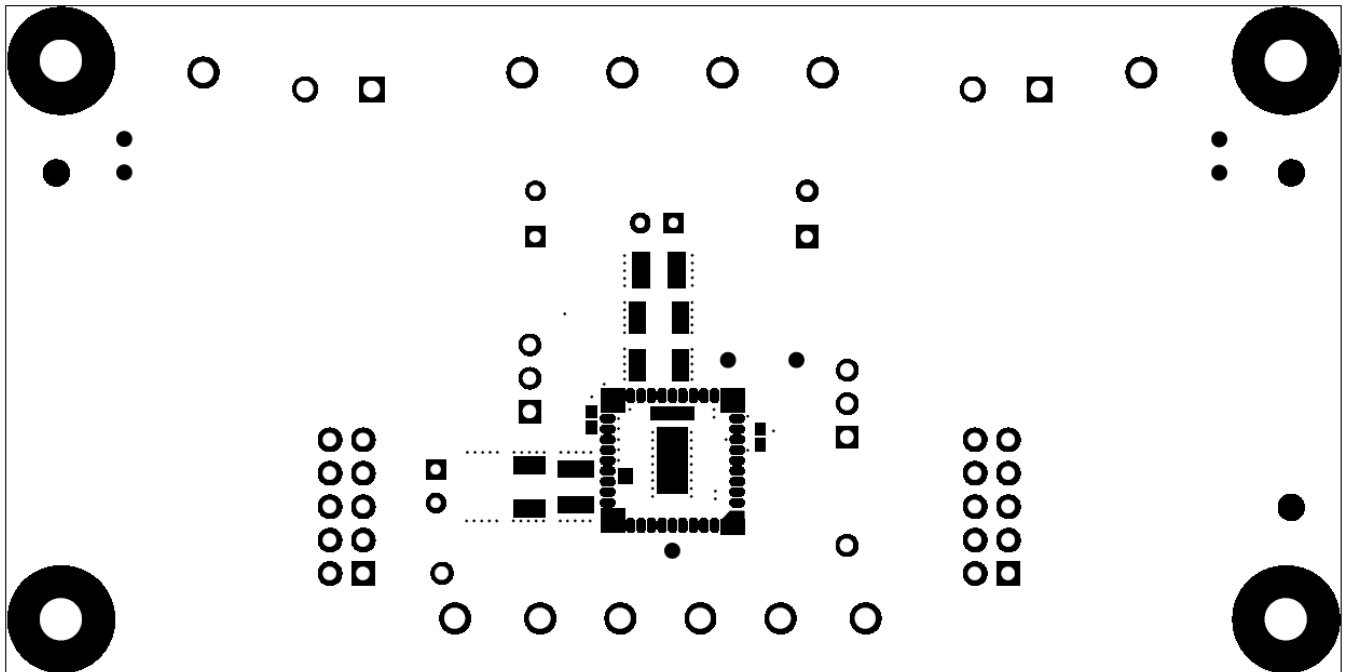

Figure 11. LMZ36002HEVM Topside Soldermask

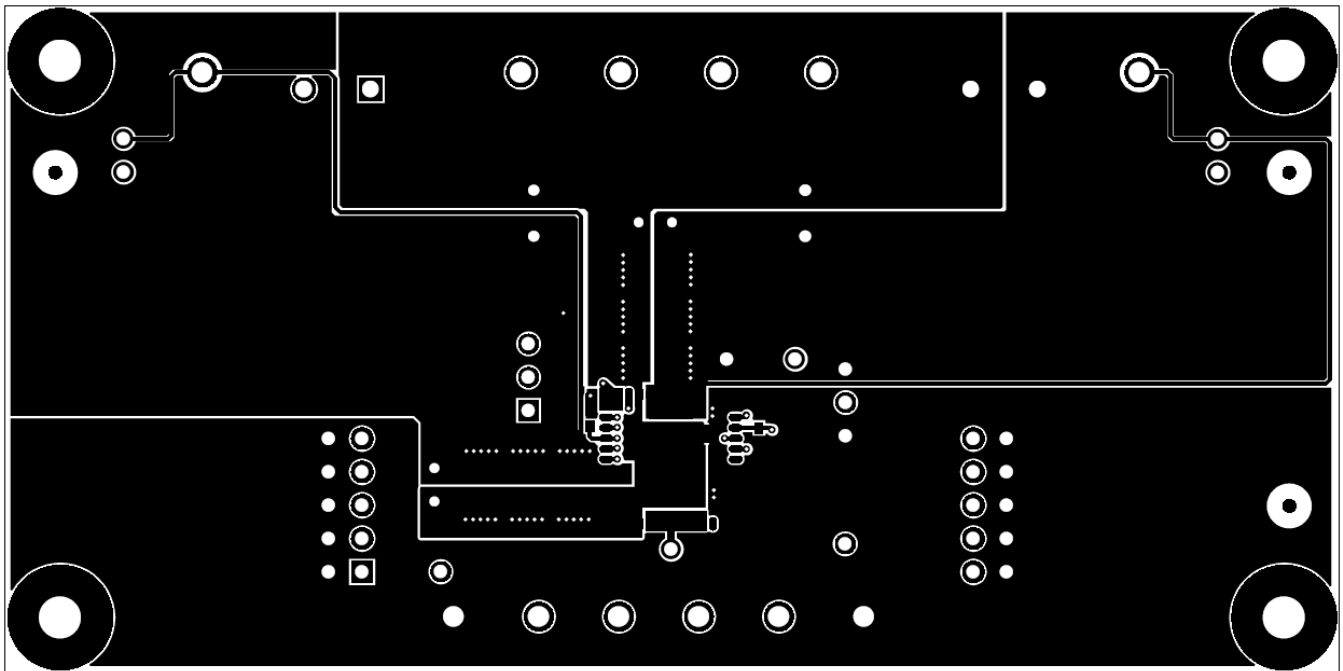

Figure 12. LMZ36002HEVM Layer 1 Copper

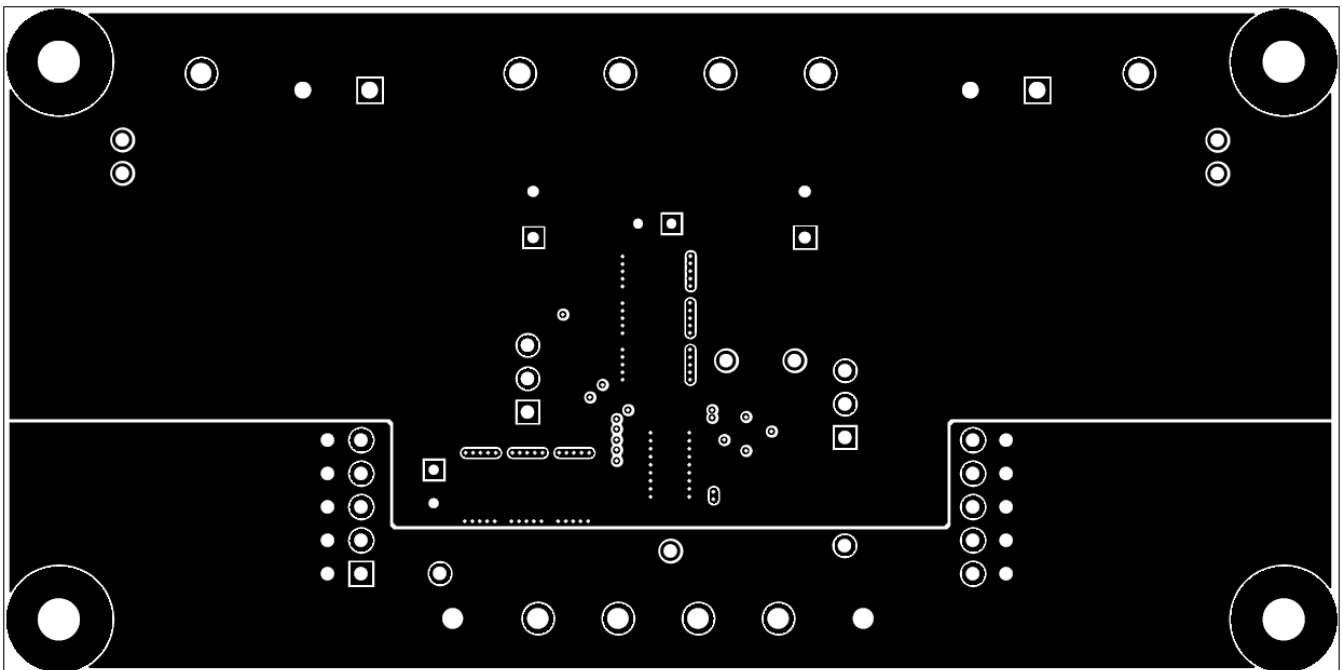

Figure 13. LMZ36002HEVM Layer 2 Copper

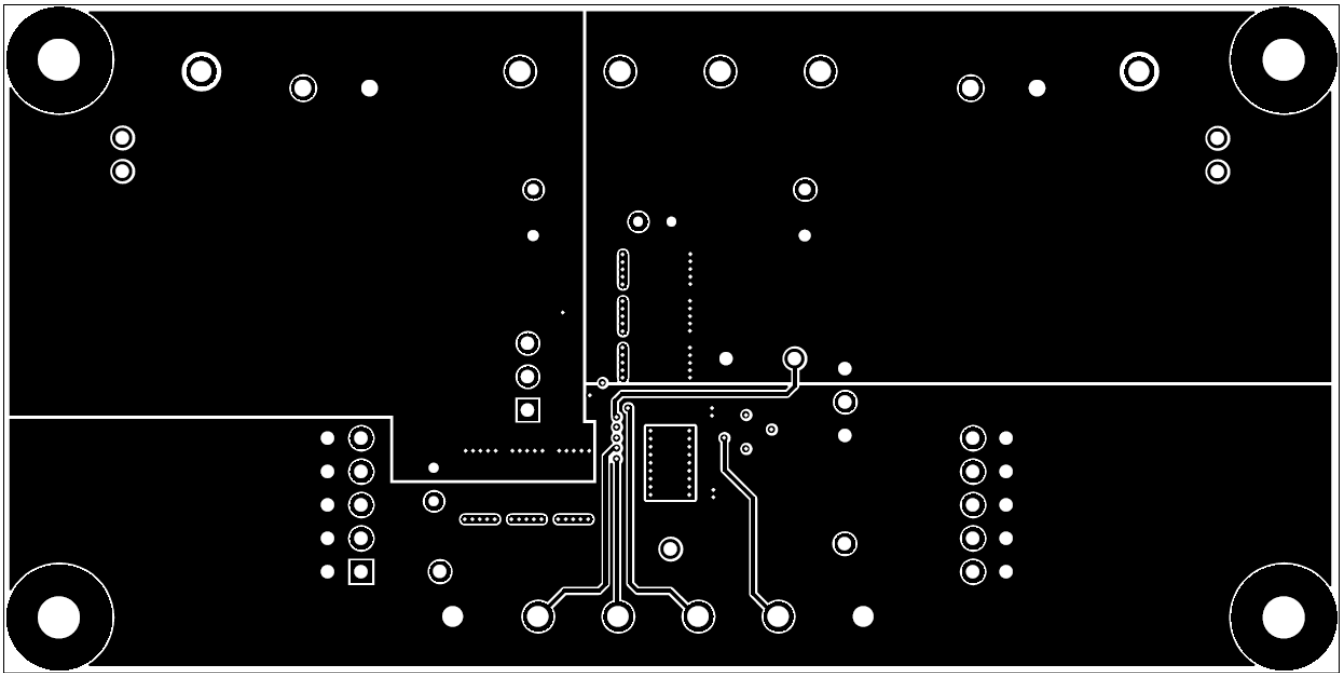

Figure 14. LMZ36002HEVM Layer 3 Copper

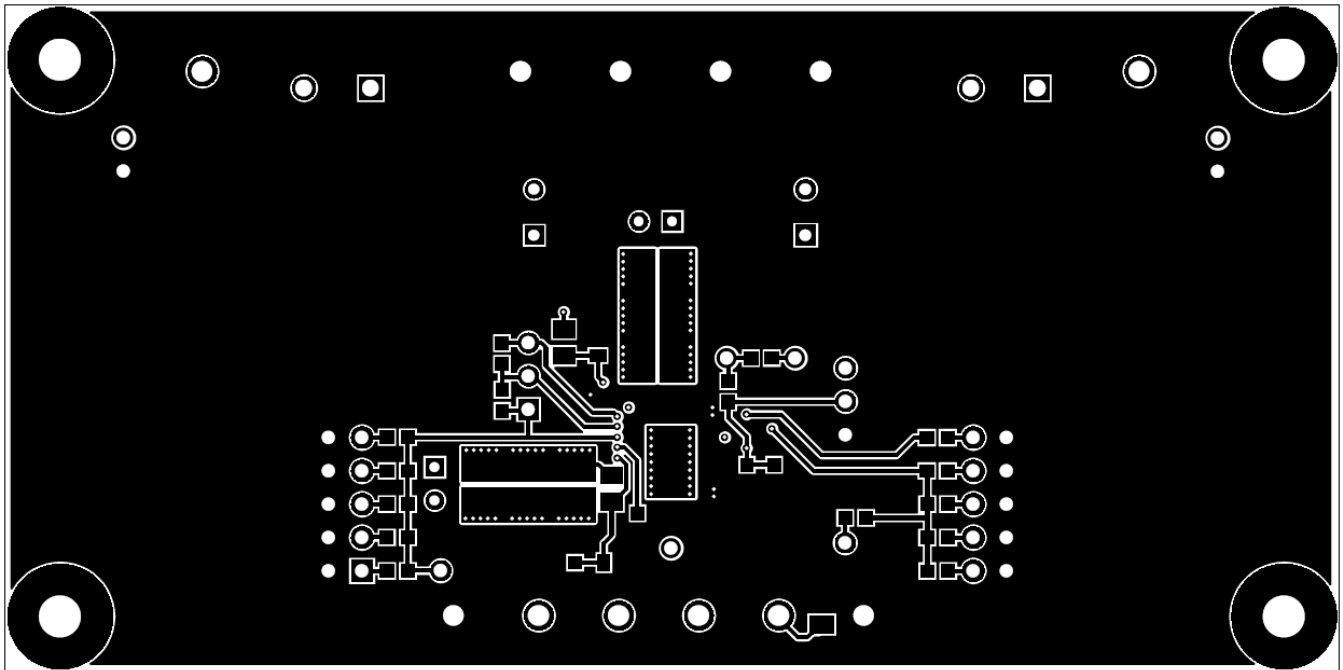

Figure 15. LMZ36002HEVM Bottom-Side Copper

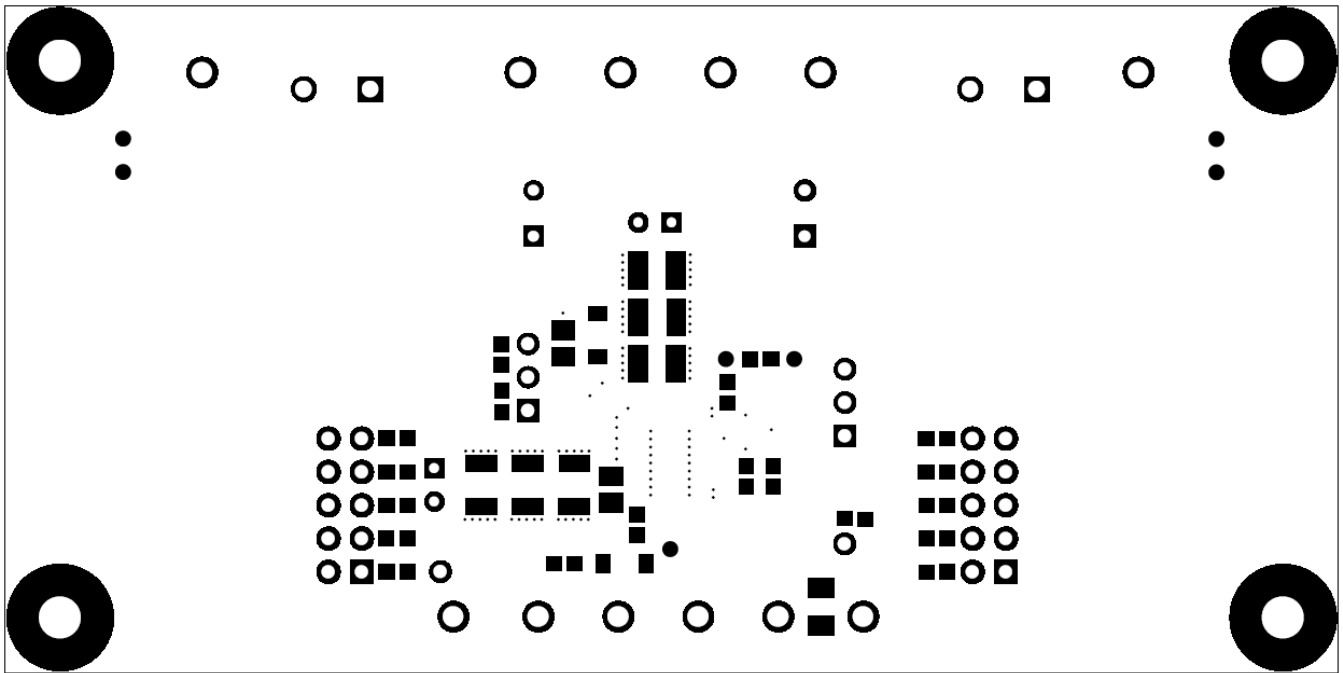

Figure 16. LMZ36002HEVM Bottom Solder Mask

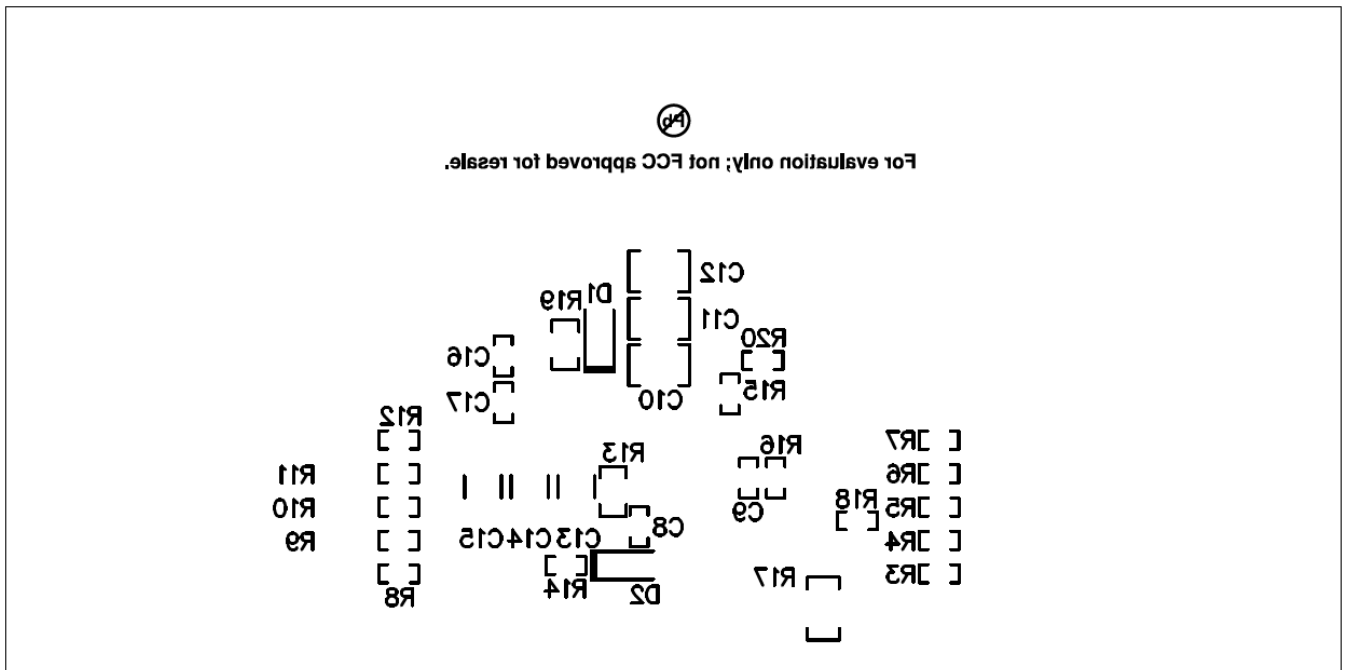

Figure 17. LMZ36002HEVM Bottom-Side Component Layout

STANDARD TERMS AND CONDITIONS FOR EVALUATION MODULES

1. *Delivery:* TI delivers TI evaluation boards, kits, or modules, including any accompanying demonstration software, components, or documentation (collectively, an "EVM" or "EVMs") to the User ("User") in accordance with the terms and conditions set forth herein. Acceptance of the EVM is expressly subject to the following terms and conditions.
 - 1.1 EVMs are intended solely for product or software developers for use in a research and development setting to facilitate feasibility evaluation, experimentation, or scientific analysis of TI semiconductors products. EVMs have no direct function and are not finished products. EVMs shall not be directly or indirectly assembled as a part or subassembly in any finished product. For clarification, any software or software tools provided with the EVM ("Software") shall not be subject to the terms and conditions set forth herein but rather shall be subject to the applicable terms and conditions that accompany such Software
 - 1.2 EVMs are not intended for consumer or household use. EVMs may not be sold, sublicensed, leased, rented, loaned, assigned, or otherwise distributed for commercial purposes by Users, in whole or in part, or used in any finished product or production system.
2. *Limited Warranty and Related Remedies/Disclaimers:*
 - 2.1 These terms and conditions do not apply to Software. The warranty, if any, for Software is covered in the applicable Software License Agreement.
 - 2.2 TI warrants that the TI EVM will conform to TI's published specifications for ninety (90) days after the date TI delivers such EVM to User. Notwithstanding the foregoing, TI shall not be liable for any defects that are caused by neglect, misuse or mistreatment by an entity other than TI, including improper installation or testing, or for any EVMs that have been altered or modified in any way by an entity other than TI. Moreover, TI shall not be liable for any defects that result from User's design, specifications or instructions for such EVMs. Testing and other quality control techniques are used to the extent TI deems necessary or as mandated by government requirements. TI does not test all parameters of each EVM.
 - 2.3 If any EVM fails to conform to the warranty set forth above, TI's sole liability shall be at its option to repair or replace such EVM, or credit User's account for such EVM. TI's liability under this warranty shall be limited to EVMs that are returned during the warranty period to the address designated by TI and that are determined by TI not to conform to such warranty. If TI elects to repair or replace such EVM, TI shall have a reasonable time to repair such EVM or provide replacements. Repaired EVMs shall be warranted for the remainder of the original warranty period. Replaced EVMs shall be warranted for a new full ninety (90) day warranty period.
3. *Regulatory Notices:*
 - 3.1 *United States*
 - 3.1.1 *Notice applicable to EVMs not FCC-Approved:*

This kit is designed to allow product developers to evaluate electronic components, circuitry, or software associated with the kit to determine whether to incorporate such items in a finished product and software developers to write software applications for use with the end product. This kit is not a finished product and when assembled may not be resold or otherwise marketed unless all required FCC equipment authorizations are first obtained. Operation is subject to the condition that this product not cause harmful interference to licensed radio stations and that this product accept harmful interference. Unless the assembled kit is designed to operate under part 15, part 18 or part 95 of this chapter, the operator of the kit must operate under the authority of an FCC license holder or must secure an experimental authorization under part 5 of this chapter.
 - 3.1.2 *For EVMs annotated as FCC – FEDERAL COMMUNICATIONS COMMISSION Part 15 Compliant:*

CAUTION

This device complies with part 15 of the FCC Rules. Operation is subject to the following two conditions: (1) This device may not cause harmful interference, and (2) this device must accept any interference received, including interference that may cause undesired operation.

Changes or modifications not expressly approved by the party responsible for compliance could void the user's authority to operate the equipment.

FCC Interference Statement for Class A EVM devices

NOTE: This equipment has been tested and found to comply with the limits for a Class A digital device, pursuant to part 15 of the FCC Rules. These limits are designed to provide reasonable protection against harmful interference when the equipment is operated in a commercial environment. This equipment generates, uses, and can radiate radio frequency energy and, if not installed and used in accordance with the instruction manual, may cause harmful interference to radio communications. Operation of this equipment in a residential area is likely to cause harmful interference in which case the user will be required to correct the interference at his own expense.

FCC Interference Statement for Class B EVM devices

NOTE: This equipment has been tested and found to comply with the limits for a Class B digital device, pursuant to part 15 of the FCC Rules. These limits are designed to provide reasonable protection against harmful interference in a residential installation. This equipment generates, uses and can radiate radio frequency energy and, if not installed and used in accordance with the instructions, may cause harmful interference to radio communications. However, there is no guarantee that interference will not occur in a particular installation. If this equipment does cause harmful interference to radio or television reception, which can be determined by turning the equipment off and on, the user is encouraged to try to correct the interference by one or more of the following measures:

- Reorient or relocate the receiving antenna.
- Increase the separation between the equipment and receiver.
- Connect the equipment into an outlet on a circuit different from that to which the receiver is connected.
- Consult the dealer or an experienced radio/TV technician for help.

3.2 Canada

3.2.1 For EVMs issued with an Industry Canada Certificate of Conformance to RSS-210

Concerning EVMs Including Radio Transmitters:

This device complies with Industry Canada license-exempt RSS standard(s). Operation is subject to the following two conditions: (1) this device may not cause interference, and (2) this device must accept any interference, including interference that may cause undesired operation of the device.

Concernant les EVMs avec appareils radio:

Le présent appareil est conforme aux CNR d'Industrie Canada applicables aux appareils radio exempts de licence. L'exploitation est autorisée aux deux conditions suivantes: (1) l'appareil ne doit pas produire de brouillage, et (2) l'utilisateur de l'appareil doit accepter tout brouillage radioélectrique subi, même si le brouillage est susceptible d'en compromettre le fonctionnement.

Concerning EVMs Including Detachable Antennas:

Under Industry Canada regulations, this radio transmitter may only operate using an antenna of a type and maximum (or lesser) gain approved for the transmitter by Industry Canada. To reduce potential radio interference to other users, the antenna type and its gain should be so chosen that the equivalent isotropically radiated power (e.i.r.p.) is not more than that necessary for successful communication. This radio transmitter has been approved by Industry Canada to operate with the antenna types listed in the user guide with the maximum permissible gain and required antenna impedance for each antenna type indicated. Antenna types not included in this list, having a gain greater than the maximum gain indicated for that type, are strictly prohibited for use with this device.

Concernant les EVMs avec antennes détachables

Conformément à la réglementation d'Industrie Canada, le présent émetteur radio peut fonctionner avec une antenne d'un type et d'un gain maximal (ou inférieur) approuvé pour l'émetteur par Industrie Canada. Dans le but de réduire les risques de brouillage radioélectrique à l'intention des autres utilisateurs, il faut choisir le type d'antenne et son gain de sorte que la puissance isotrope rayonnée équivalente (p.i.r.e.) ne dépasse pas l'intensité nécessaire à l'établissement d'une communication satisfaisante. Le présent émetteur radio a été approuvé par Industrie Canada pour fonctionner avec les types d'antenne énumérés dans le manuel d'usage et ayant un gain admissible maximal et l'impédance requise pour chaque type d'antenne. Les types d'antenne non inclus dans cette liste, ou dont le gain est supérieur au gain maximal indiqué, sont strictement interdits pour l'exploitation de l'émetteur.

3.3 Japan

3.3.1 *Notice for EVMs delivered in Japan:* Please see http://www.tij.co.jp/lstds/ti_ja/general/eStore/notice_01.page 日本国内に輸入される評価用キット、ボードについては、次のところをご覧ください。
http://www.tij.co.jp/lstds/ti_ja/general/eStore/notice_01.page

3.3.2 *Notice for Users of EVMs Considered "Radio Frequency Products" in Japan:* EVMs entering Japan may not be certified by TI as conforming to Technical Regulations of Radio Law of Japan.

If User uses EVMs in Japan, not certified to Technical Regulations of Radio Law of Japan, User is required by Radio Law of Japan to follow the instructions below with respect to EVMs:

1. Use EVMs in a shielded room or any other test facility as defined in the notification #173 issued by Ministry of Internal Affairs and Communications on March 28, 2006, based on Sub-section 1.1 of Article 6 of the Ministry's Rule for Enforcement of Radio Law of Japan,
2. Use EVMs only after User obtains the license of Test Radio Station as provided in Radio Law of Japan with respect to EVMs, or
3. Use of EVMs only after User obtains the Technical Regulations Conformity Certification as provided in Radio Law of Japan with respect to EVMs. Also, do not transfer EVMs, unless User gives the same notice above to the transferee. Please note that if User does not follow the instructions above, User will be subject to penalties of Radio Law of Japan.

【無線電波を送信する製品の開発キットをお使いになる際の注意事項】 開発キットの中には技術基準適合証明を受けていないものがあります。技術適合証明を受けていないものご使用に際しては、電波法遵守のため、以下のいずれかの措置を取っていただく必要がありますのでご注意ください。

1. 電波法施行規則第6条第1項第1号に基づく平成18年3月28日総務省告示第173号で定められた電波暗室等の試験設備でご使用いただく。
2. 実験局の免許を取得後ご使用いただく。
3. 技術基準適合証明を取得後ご使用いただく。

なお、本製品は、上記の「ご使用にあたっての注意」を譲渡先、移転先に通知しない限り、譲渡、移転できないものとします。

上記を遵守頂けない場合は、電波法の罰則が適用される可能性があることをご留意ください。日本テキサス・インスツルメンツ株式会社

東京都新宿区西新宿 6 丁目 2 4 番 1 号

西新宿三井ビル

3.3.3 *Notice for EVMs for Power Line Communication:* Please see http://www.tij.co.jp/llds/ti_ja/general/eStore/notice_02.page

電力線搬送波通信についての開発キットをお使いになる際の注意事項については、次のところをご覧ください。http://www.tij.co.jp/llds/ti_ja/general/eStore/notice_02.page

4 *EVM Use Restrictions and Warnings:*

4.1 EVMS ARE NOT FOR USE IN FUNCTIONAL SAFETY AND/OR SAFETY CRITICAL EVALUATIONS, INCLUDING BUT NOT LIMITED TO EVALUATIONS OF LIFE SUPPORT APPLICATIONS.

4.2 User must read and apply the user guide and other available documentation provided by TI regarding the EVM prior to handling or using the EVM, including without limitation any warning or restriction notices. The notices contain important safety information related to, for example, temperatures and voltages.

4.3 *Safety-Related Warnings and Restrictions:*

4.3.1 User shall operate the EVM within TI's recommended specifications and environmental considerations stated in the user guide, other available documentation provided by TI, and any other applicable requirements and employ reasonable and customary safeguards. Exceeding the specified performance ratings and specifications (including but not limited to input and output voltage, current, power, and environmental ranges) for the EVM may cause personal injury or death, or property damage. If there are questions concerning performance ratings and specifications, User should contact a TI field representative prior to connecting interface electronics including input power and intended loads. Any loads applied outside of the specified output range may also result in unintended and/or inaccurate operation and/or possible permanent damage to the EVM and/or interface electronics. Please consult the EVM user guide prior to connecting any load to the EVM output. If there is uncertainty as to the load specification, please contact a TI field representative. During normal operation, even with the inputs and outputs kept within the specified allowable ranges, some circuit components may have elevated case temperatures. These components include but are not limited to linear regulators, switching transistors, pass transistors, current sense resistors, and heat sinks, which can be identified using the information in the associated documentation. When working with the EVM, please be aware that the EVM may become very warm.

4.3.2 EVMs are intended solely for use by technically qualified, professional electronics experts who are familiar with the dangers and application risks associated with handling electrical mechanical components, systems, and subsystems. User assumes all responsibility and liability for proper and safe handling and use of the EVM by User or its employees, affiliates, contractors or designees. User assumes all responsibility and liability to ensure that any interfaces (electronic and/or mechanical) between the EVM and any human body are designed with suitable isolation and means to safely limit accessible leakage currents to minimize the risk of electrical shock hazard. User assumes all responsibility and liability for any improper or unsafe handling or use of the EVM by User or its employees, affiliates, contractors or designees.

4.4 User assumes all responsibility and liability to determine whether the EVM is subject to any applicable international, federal, state, or local laws and regulations related to User's handling and use of the EVM and, if applicable, User assumes all responsibility and liability for compliance in all respects with such laws and regulations. User assumes all responsibility and liability for proper disposal and recycling of the EVM consistent with all applicable international, federal, state, and local requirements.

5. *Accuracy of Information:* To the extent TI provides information on the availability and function of EVMs, TI attempts to be as accurate as possible. However, TI does not warrant the accuracy of EVM descriptions, EVM availability or other information on its websites as accurate, complete, reliable, current, or error-free.

6. *Disclaimers:*
- 6.1 EXCEPT AS SET FORTH ABOVE, EVMS AND ANY WRITTEN DESIGN MATERIALS PROVIDED WITH THE EVM (AND THE DESIGN OF THE EVM ITSELF) ARE PROVIDED "AS IS" AND "WITH ALL FAULTS." TI DISCLAIMS ALL OTHER WARRANTIES, EXPRESS OR IMPLIED, REGARDING SUCH ITEMS, INCLUDING BUT NOT LIMITED TO ANY IMPLIED WARRANTIES OF MERCHANTABILITY OR FITNESS FOR A PARTICULAR PURPOSE OR NON-INFRINGEMENT OF ANY THIRD PARTY PATENTS, COPYRIGHTS, TRADE SECRETS OR OTHER INTELLECTUAL PROPERTY RIGHTS.
- 6.2 EXCEPT FOR THE LIMITED RIGHT TO USE THE EVM SET FORTH HEREIN, NOTHING IN THESE TERMS AND CONDITIONS SHALL BE CONSTRUED AS GRANTING OR CONFERRING ANY RIGHTS BY LICENSE, PATENT, OR ANY OTHER INDUSTRIAL OR INTELLECTUAL PROPERTY RIGHT OF TI, ITS SUPPLIERS/LICENSORS OR ANY OTHER THIRD PARTY, TO USE THE EVM IN ANY FINISHED END-USER OR READY-TO-USE FINAL PRODUCT, OR FOR ANY INVENTION, DISCOVERY OR IMPROVEMENT MADE, CONCEIVED OR ACQUIRED PRIOR TO OR AFTER DELIVERY OF THE EVM.
7. *USER'S INDEMNITY OBLIGATIONS AND REPRESENTATIONS.* USER WILL DEFEND, INDEMNIFY AND HOLD TI, ITS LICENSORS AND THEIR REPRESENTATIVES HARMLESS FROM AND AGAINST ANY AND ALL CLAIMS, DAMAGES, LOSSES, EXPENSES, COSTS AND LIABILITIES (COLLECTIVELY, "CLAIMS") ARISING OUT OF OR IN CONNECTION WITH ANY HANDLING OR USE OF THE EVM THAT IS NOT IN ACCORDANCE WITH THESE TERMS AND CONDITIONS. THIS OBLIGATION SHALL APPLY WHETHER CLAIMS ARISE UNDER STATUTE, REGULATION, OR THE LAW OF TORT, CONTRACT OR ANY OTHER LEGAL THEORY, AND EVEN IF THE EVM FAILS TO PERFORM AS DESCRIBED OR EXPECTED.
8. *Limitations on Damages and Liability:*
- 8.1 *General Limitations.* IN NO EVENT SHALL TI BE LIABLE FOR ANY SPECIAL, COLLATERAL, INDIRECT, PUNITIVE, INCIDENTAL, CONSEQUENTIAL, OR EXEMPLARY DAMAGES IN CONNECTION WITH OR ARISING OUT OF THESE TERMS AND CONDITIONS OR THE USE OF THE EVMS PROVIDED HEREUNDER, REGARDLESS OF WHETHER TI HAS BEEN ADVISED OF THE POSSIBILITY OF SUCH DAMAGES. EXCLUDED DAMAGES INCLUDE, BUT ARE NOT LIMITED TO, COST OF REMOVAL OR REINSTALLATION, ANCILLARY COSTS TO THE PROCUREMENT OF SUBSTITUTE GOODS OR SERVICES, RETESTING, OUTSIDE COMPUTER TIME, LABOR COSTS, LOSS OF GOODWILL, LOSS OF PROFITS, LOSS OF SAVINGS, LOSS OF USE, LOSS OF DATA, OR BUSINESS INTERRUPTION. NO CLAIM, SUIT OR ACTION SHALL BE BROUGHT AGAINST TI MORE THAN ONE YEAR AFTER THE RELATED CAUSE OF ACTION HAS OCCURRED.
- 8.2 *Specific Limitations.* IN NO EVENT SHALL TI'S AGGREGATE LIABILITY FROM ANY WARRANTY OR OTHER OBLIGATION ARISING OUT OF OR IN CONNECTION WITH THESE TERMS AND CONDITIONS, OR ANY USE OF ANY TI EVM PROVIDED HEREUNDER, EXCEED THE TOTAL AMOUNT PAID TO TI FOR THE PARTICULAR UNITS SOLD UNDER THESE TERMS AND CONDITIONS WITH RESPECT TO WHICH LOSSES OR DAMAGES ARE CLAIMED. THE EXISTENCE OF MORE THAN ONE CLAIM AGAINST THE PARTICULAR UNITS SOLD TO USER UNDER THESE TERMS AND CONDITIONS SHALL NOT ENLARGE OR EXTEND THIS LIMIT.
9. *Return Policy.* Except as otherwise provided, TI does not offer any refunds, returns, or exchanges. Furthermore, no return of EVM(s) will be accepted if the package has been opened and no return of the EVM(s) will be accepted if they are damaged or otherwise not in a resalable condition. If User feels it has been incorrectly charged for the EVM(s) it ordered or that delivery violates the applicable order, User should contact TI. All refunds will be made in full within thirty (30) working days from the return of the components(s), excluding any postage or packaging costs.
10. *Governing Law:* These terms and conditions shall be governed by and interpreted in accordance with the laws of the State of Texas, without reference to conflict-of-laws principles. User agrees that non-exclusive jurisdiction for any dispute arising out of or relating to these terms and conditions lies within courts located in the State of Texas and consents to venue in Dallas County, Texas. Notwithstanding the foregoing, any judgment may be enforced in any United States or foreign court, and TI may seek injunctive relief in any United States or foreign court.

Mailing Address: Texas Instruments, Post Office Box 655303, Dallas, Texas 75265
Copyright © 2015, Texas Instruments Incorporated

IMPORTANT NOTICE

Texas Instruments Incorporated and its subsidiaries (TI) reserve the right to make corrections, enhancements, improvements and other changes to its semiconductor products and services per JESD46, latest issue, and to discontinue any product or service per JESD48, latest issue. Buyers should obtain the latest relevant information before placing orders and should verify that such information is current and complete. All semiconductor products (also referred to herein as "components") are sold subject to TI's terms and conditions of sale supplied at the time of order acknowledgment.

TI warrants performance of its components to the specifications applicable at the time of sale, in accordance with the warranty in TI's terms and conditions of sale of semiconductor products. Testing and other quality control techniques are used to the extent TI deems necessary to support this warranty. Except where mandated by applicable law, testing of all parameters of each component is not necessarily performed.

TI assumes no liability for applications assistance or the design of Buyers' products. Buyers are responsible for their products and applications using TI components. To minimize the risks associated with Buyers' products and applications, Buyers should provide adequate design and operating safeguards.

TI does not warrant or represent that any license, either express or implied, is granted under any patent right, copyright, mask work right, or other intellectual property right relating to any combination, machine, or process in which TI components or services are used. Information published by TI regarding third-party products or services does not constitute a license to use such products or services or a warranty or endorsement thereof. Use of such information may require a license from a third party under the patents or other intellectual property of the third party, or a license from TI under the patents or other intellectual property of TI.

Reproduction of significant portions of TI information in TI data books or data sheets is permissible only if reproduction is without alteration and is accompanied by all associated warranties, conditions, limitations, and notices. TI is not responsible or liable for such altered documentation. Information of third parties may be subject to additional restrictions.

Resale of TI components or services with statements different from or beyond the parameters stated by TI for that component or service voids all express and any implied warranties for the associated TI component or service and is an unfair and deceptive business practice. TI is not responsible or liable for any such statements.

Buyer acknowledges and agrees that it is solely responsible for compliance with all legal, regulatory and safety-related requirements concerning its products, and any use of TI components in its applications, notwithstanding any applications-related information or support that may be provided by TI. Buyer represents and agrees that it has all the necessary expertise to create and implement safeguards which anticipate dangerous consequences of failures, monitor failures and their consequences, lessen the likelihood of failures that might cause harm and take appropriate remedial actions. Buyer will fully indemnify TI and its representatives against any damages arising out of the use of any TI components in safety-critical applications.

In some cases, TI components may be promoted specifically to facilitate safety-related applications. With such components, TI's goal is to help enable customers to design and create their own end-product solutions that meet applicable functional safety standards and requirements. Nonetheless, such components are subject to these terms.

No TI components are authorized for use in FDA Class III (or similar life-critical medical equipment) unless authorized officers of the parties have executed a special agreement specifically governing such use.

Only those TI components which TI has specifically designated as military grade or "enhanced plastic" are designed and intended for use in military/aerospace applications or environments. Buyer acknowledges and agrees that any military or aerospace use of TI components which have **not** been so designated is solely at the Buyer's risk, and that Buyer is solely responsible for compliance with all legal and regulatory requirements in connection with such use.

TI has specifically designated certain components as meeting ISO/TS16949 requirements, mainly for automotive use. In any case of use of non-designated products, TI will not be responsible for any failure to meet ISO/TS16949.

Products

Audio	www.ti.com/audio
Amplifiers	amplifier.ti.com
Data Converters	dataconverter.ti.com
DLP® Products	www.dlp.com
DSP	dsp.ti.com
Clocks and Timers	www.ti.com/clocks
Interface	interface.ti.com
Logic	logic.ti.com
Power Mgmt	power.ti.com
Microcontrollers	microcontroller.ti.com
RFID	www.ti-rfid.com
OMAP Applications Processors	www.ti.com/omap
Wireless Connectivity	www.ti.com/wirelessconnectivity

Applications

Automotive and Transportation	www.ti.com/automotive
Communications and Telecom	www.ti.com/communications
Computers and Peripherals	www.ti.com/computers
Consumer Electronics	www.ti.com/consumer-apps
Energy and Lighting	www.ti.com/energy
Industrial	www.ti.com/industrial
Medical	www.ti.com/medical
Security	www.ti.com/security
Space, Avionics and Defense	www.ti.com/space-avionics-defense
Video and Imaging	www.ti.com/video

TI E2E Community

e2e.ti.com