

LM34936EVM User's Guide

The LM34936EVM features a four switch buck-boost converter based on TI's LM34936 wide V_{IN} buck-boost controller.

Contents

| | | |
|---|---|---|
| 1 | Description | 2 |
| 2 | Setup | 3 |
| | 2.1 Input/Output Connector Description | 3 |
| | 2.2 Test Points..... | 3 |
| | 2.3 Test Bench Setup..... | 4 |
| 3 | Performance..... | 5 |
| 4 | Complete Schematic | 7 |
| 5 | Bill of Materials (BOM) | 8 |
| 6 | Re-Configuring the Average Current Loop | 9 |
| 7 | Board PCB..... | 9 |

List of Figures

| | | |
|----|---|----|
| 1 | LM34936Evaluation Board | 2 |
| 2 | Test Bench Setup..... | 4 |
| 3 | Efficiency vs Load Current..... | 5 |
| 4 | Efficiency vs Input Voltage | 5 |
| 5 | Input Current vs Input Voltage | 5 |
| 6 | Output Voltage Ripple..... | 5 |
| 7 | Load Transient Response (Load 2A to 4A, AC Coupled) | 5 |
| 8 | Line Transient Response | 5 |
| 9 | Hiccup Mode Current Limit | 6 |
| 10 | Start-up (Load = 1 A)..... | 6 |
| 11 | Shutdown (Load = 1 A) | 6 |
| 12 | LM34936EVM Schematic..... | 7 |
| 13 | Top Overlay | 9 |
| 14 | Top Layer | 10 |
| 15 | Top Solder | 10 |
| 16 | Mid Layer 2 | 11 |
| 17 | Mid Layer 3 | 11 |
| 18 | Bottom Layer..... | 12 |
| 19 | Bottom Solder..... | 12 |
| 20 | Bottom Overlay | 13 |

List of Tables

| | | |
|---|-------------------------------|---|
| 1 | Board Specifications..... | 2 |
| 2 | Bill of Materials (BOM) | 8 |

Trademarks

All trademarks are the property of their respective owners.

1 Description

The LM34936EVM features a four switch buck-boost converter based on TI's LM34936 wide V_{IN} buck-boost controller. This converter is designed to operate from input voltage from 6 V to 24 V (42-V transient) and provide a 12 V regulated output with a load current of up to 6 A. The board specifications are listed in [Table 1](#).

Table 1. Board Specifications

| PARAMETER | VALUE |
|--|-------------------------------------|
| Input voltage (V_{IN}) | 6 V to 24 V (42-V transient) |
| Output voltage (V_{OUT}) | 12 V |
| Maximum output current (I_{OUT}) | 6 A |
| Default switching frequency (f_{sw}) | 300 kHz |
| Synchronizable frequency range | 300 kHz to 600 kHz |
| Efficiency ($I_{OUT} = 5\text{ A}$, $V_{IN} = 6\text{ V to }36\text{ V}$) | 93.8% to 98.5% |
| Board size (4 layers) | 96.4 mm × 91.5 mm (3.8 in × 3.6 in) |

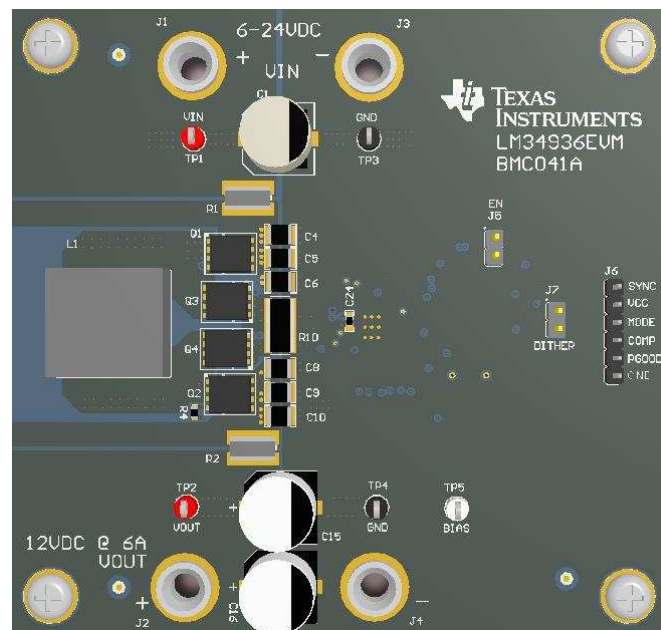

Figure 1. LM34936Evaluation Board

2 Setup

This section describes input and output connectors on the EVM and the step-by-step procedure for setting up and using the LM34936 Evaluation Board.

2.1 Input/Output Connector Description

| REF | NAME | DESCRIPTION |
|------|--------|--|
| TP1 | VIN | VIN sense terminal |
| TP2 | VOUT | VOUT sense terminal |
| J1 | VIN | Positive input power terminal for the EVM |
| J2 | VOUT | Positive output from the converter |
| TP3 | GND | Input ground sense terminal |
| TP4 | GND | Output ground sense terminal |
| J3 | GND | Return input power terminal for the EVM |
| J4 | GND | Ground or return terminal for the output |
| J5 | ENABLE | 3 terminal ENABLE selections. Short pin 1 and 2 to disable the DC/DC converter. Removing the short allows the converter to start up depending on the EN pin voltage. |
| J6-6 | GND | Unpopulated |

2.2 Test Points

| | | |
|------|-------|---|
| J6-2 | VCC | Internal VCC regulator output |
| J6-3 | MODE | MODE pin voltage. See LM34936 data sheet for details on this pin |
| J6-5 | PGOOD | Power good indicator. There is a 10-k Ω pullup to VCC on the board. |
| J6-1 | SYNC | External frequency synchronization input terminal (SYNC). This is connected to the RT/SYNC pin of the LM5175 controller IC through a 100-pF capacitor on the board. |
| J6-4 | COMP | Output of the LM5175 GM error amplifier. |

2.3 Test Bench Setup

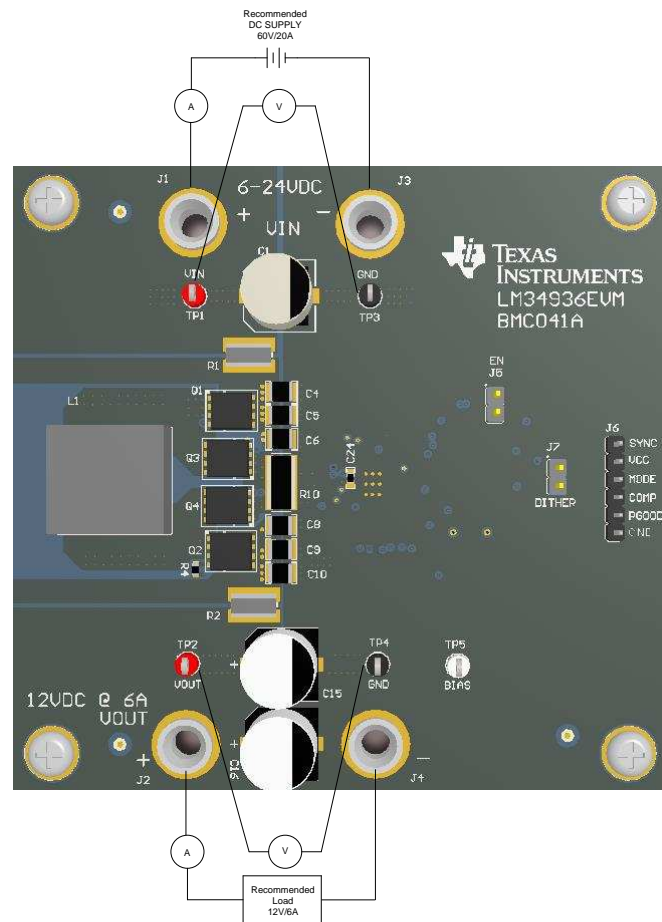

Figure 2. Test Bench Setup

A typical LM34936 test bench setup is shown in [Figure 2](#). The power supply and the load should be capable of handling the input and output voltage and current rating of the board. Follow these steps to get started with the LM34936EVM.

1. Connect the power and ground connectors VIN (J1) and GND (J3) to the power supply.
2. Connect an ammeter in series with the input if needed.
3. Connect a voltmeter across the input terminals (TP1, TP3).
4. Connect a resistive load or an electronic load across terminals VOUT (J2) and GND (J4).
5. An ammeter can be inserted in series with the load to observe the load current.
6. Connect a voltmeter across the output terminals (TP2, TP4) to observe the output voltage.
7. With the load initially set to no load, set the power supply between 6 V and 24 V and turn on the power supply. Check for 12 V at the output.
8. Once the output is at the expected target (12 V), increase the load gradually within the operating range.

3 Performance

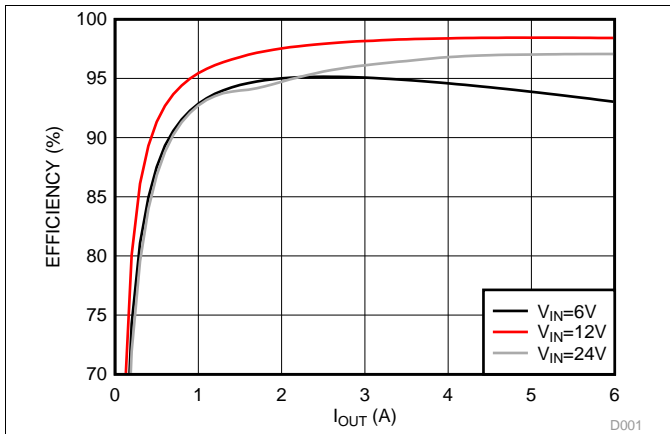

Figure 3. Efficiency vs Load Current

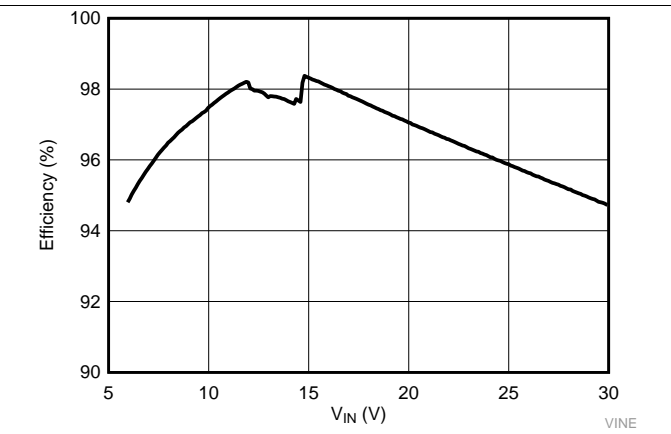

Figure 4. Efficiency vs Input Voltage

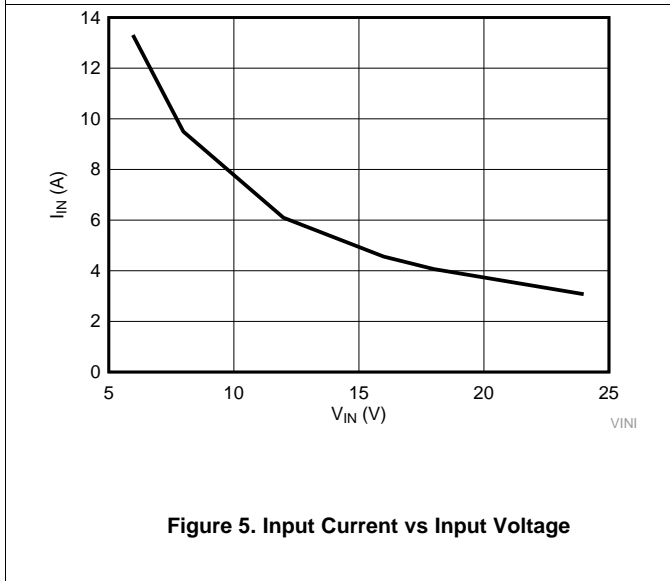

Figure 5. Input Current vs Input Voltage

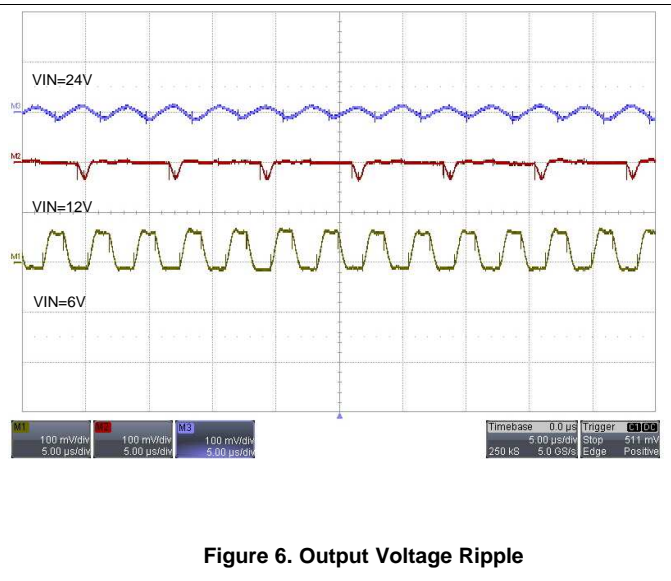
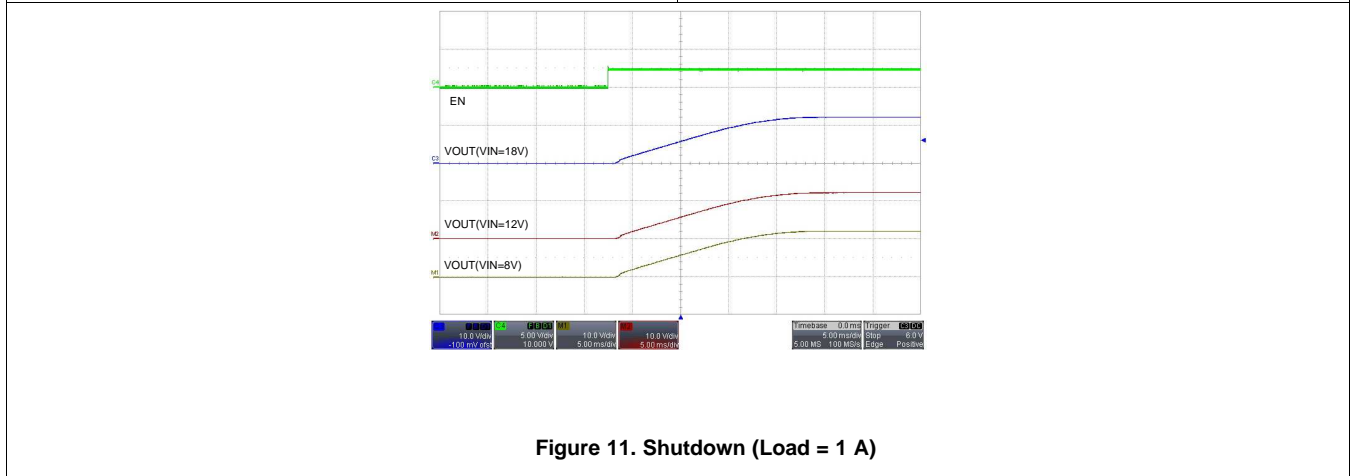
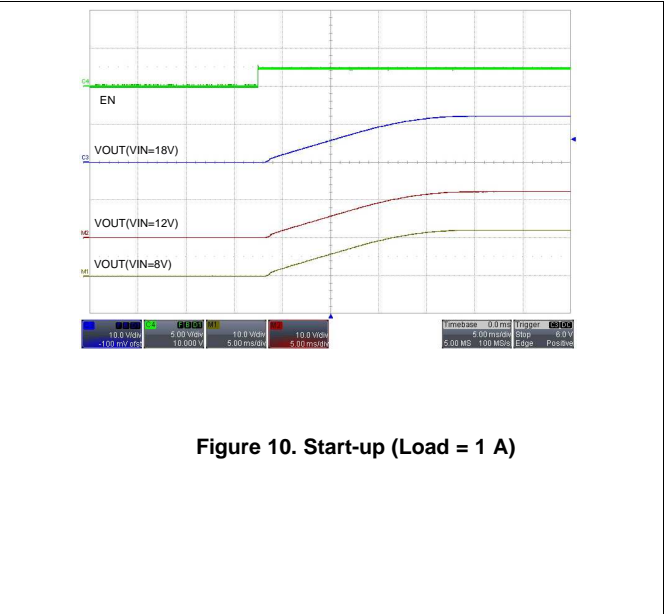
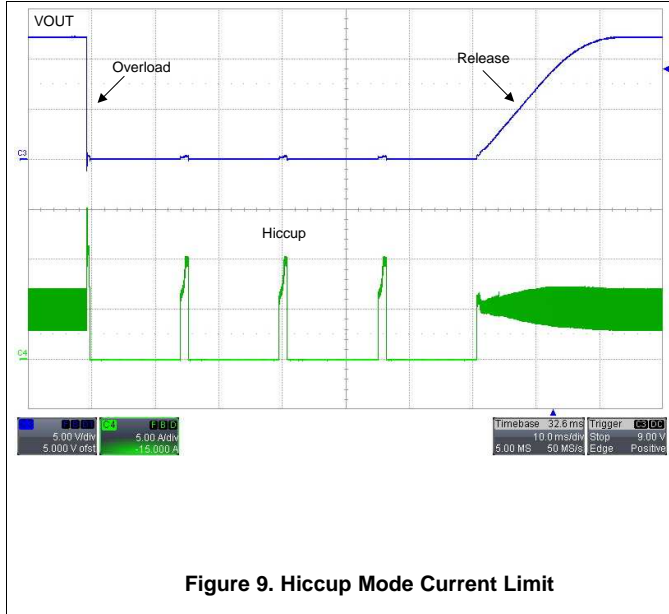
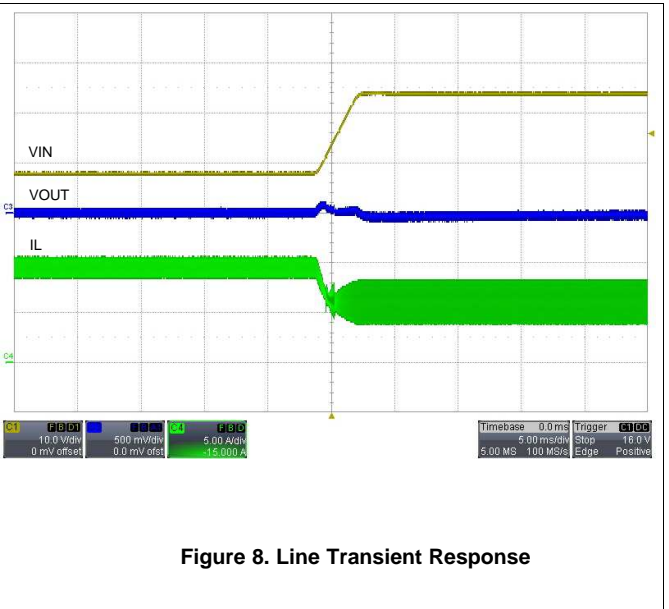
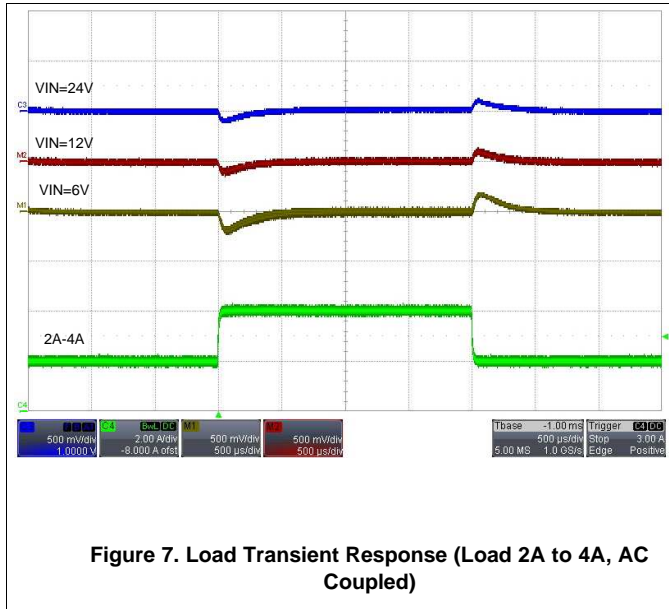

Figure 6. Output Voltage Ripple



4 Complete Schematic

The complete schematic of LM34936 evaluation board is shown in Figure 12.

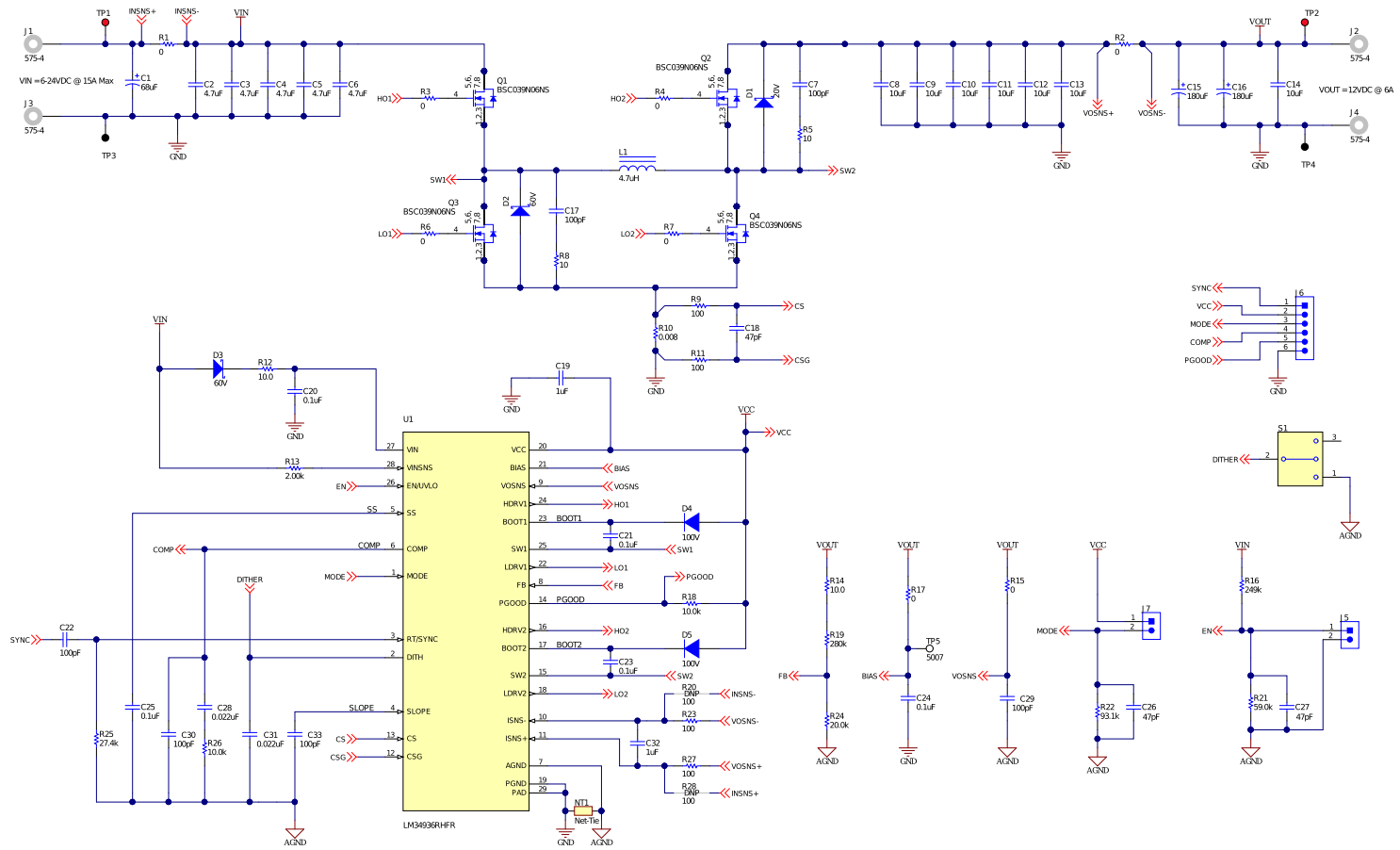

Figure 12. LM34936EVM Schematic

5 Bill of Materials (BOM)

Table 2. Bill of Materials (BOM)

| DESIGNATOR | DESCRIPTION | MANUFACTURER | PART NUMBER | QTY |
|---------------------------------|---|-----------------------------|---------------------|-----|
| PCB | Printed Circuit Board | Any | SV601130 | 1 |
| C1 | CAP, Aluminum Polymer, 68 μ F, 63 V, \pm 20%, 0.028 ohm, 2-Pin SMD, Body 10.3 x 10.3 mm, Height 10 mm SMD | Nichicon | PCR1J680MCL1GS | 1 |
| C2, C3, C4, C5, C6 | CAP, CERM, 4.7 μ F, 100 V, \pm 10%, X7S, 1210 | TDK | C3225X7S2A475K200AB | 5 |
| C8, C9, C10, C11, C12, C13, C14 | CAP, CERM, 10 μ F, 50 V, \pm 10%, X7R, 1210 | MuRata | GRM32ER71H106KA12L | 7 |
| C7, C17 | CAP, CERM, 100 pF, 100 V, \pm 5%, COG/NP0, 1206 | AVX | 12061A101JAT2A | 2 |
| C15, C16 | CAP, Aluminum Polymer, 180 μ F, 50 V, \pm 20%, 0.019 ohm, SMD, 2-Leads, Dia 10.5mm, Pin Spacing 8mm SMD | Nichicon | PCR1H181MCL1GS | 2 |
| C18 | CAP, CERM, 47 pF, 50 V, \pm 5%, COG/NP0, 0603 | MuRata | GRM1885C1H470JA01D | 1 |
| C19, C32 | CAP, CERM, 1 μ F, 25 V, \pm 10%, X7R, 0603 | MuRata | GRM188R71E105KA12D | 2 |
| C20, C25 | CAP, CERM, 0.1 μ F, 100 V, \pm 10%, X7R, 0603 | MuRata | GRM188R72A104KA35D | 2 |
| C21, C23, C24 | CAP, CERM, 0.1 μ F, 100 V, \pm 10%, X7R, 0603 | MuRata | GRM188R72A104KA35D | 3 |
| C22, C29, C30, C33 | CAP, CERM, 100 pF, 100 V, \pm 5%, COG/NP0, 0603 | MuRata | GRM1885C2A101JA01D | 4 |
| C28, C31 | CAP, CERM, 0.022 μ F, 50 V, \pm 10%, X7R, 0603 | Kemet | C0603C223K5RACTU | 2 |
| D3 | Diode, Schottky, 60 V, 1 A, SOD-323F | NXP Semiconductor | PMEG6010CEJ,115 | 1 |
| D4, D5 | Diode, Ultrafast, 100V, 0.25A, SOD-323 | NXP Semiconductor | BAS316,115 | 2 |
| H1, H2, H3, H4 | Machine Screw, Round, 4-40 x 1/4, Nylon, Philips Panhead | B and F Fastener Supply | NY PMS 440 0025 PH | 4 |
| H5, H6, H7, H8 | Standoff, Hex, 0.5 inch Long 4-40 Nylon | Keystone | 1902C | 4 |
| J1, J2, J3, J4 | Standard Banana Jack, Uninsulated, 5.5mm | Keystone | 575-4 | 4 |
| J5, J17 | Header, TH, 100mil, 2x1, Gold plated, 230 mil above insulator | Sullins Connector Solutions | PBC02SAAN | 2 |
| L1 | Inductor, Shielded, Composite, 4.7 μ H, 29A, 0.00335 ohm, SMD | Coilcraft | XAL1510-472MEB | 1 |
| Q1, Q2, Q3, Q4 | MOSFET, N-CH, 60 V, 19 A, PG-TDSON-8 | Infineon Technologies | BSC039N06NS | 4 |
| R1, R2 | RES, 0 Ω , 5%, 2 W, 2512 WIDE | Vishay Draloric | RCL12250000Z0EG | 2 |
| R3, R4, R6, R7, R15, R17 | RES, 0 Ω , 5%, 0.1 W, 0603 | Yageo America | RC0603JR-070RL | 6 |
| R5, R8 | RES, 10.0 Ω , 1%, 0.25 W, 1206 | Yageo America | RC1206FR-0710RL | 2 |
| R9, R11, | RES, 100 Ω , 1%, 0.1 W, 0603 | Yageo America | RC0603FR-07100RL | 2 |
| R10 | RES, 0.008 Ω , 1%, 4 W, 3015 WIDE | Susumu Co Ltd | KRL7638-C-R008-F-T1 | 1 |
| R12, R14 | RES, 10.0 Ω , 1%, 0.1 W, 0603 | Yageo America | RC0603FR-0710RL | 2 |
| R13 | RES, 2.0 k Ω , 1%, 0.1 W, 0603 | Yageo America | RC0603FR-0702KL | 1 |
| R16 | RES, 249 k Ω , 1%, 0.1 W, 0603 | Yageo America | RC0603FR-07249KL | 1 |
| R18, R26 | RES, 10.0 k Ω , 1%, 0.1 W, 0603 | Yageo America | RC0603FR-0710KL | 2 |
| R19 | RES, 280 k Ω , 1%, 0.1 W, 0603 | Yageo America | RC0603FR-07280KL | 1 |
| R21 | RES, 59.0 k Ω , 1%, 0.1 W, 0603 | Yageo America | RC0603FR-0759KL | 1 |
| R22 | RES, 93.1 k Ω , 1%, 0.1 W, 0603 | Yageo America | RC0603FR-0793K1L | 1 |
| R23, R27 | RES, 100, 1%, 0.1 W, 0603 | Vishay Dale | CRCW0603100RFKEAL | 2 |
| R24 | RES, 20.0 k Ω , 1%, 0.1 W, 0603 | Yageo America | RC0603FR-0720KL | 1 |
| R25 | RES, 27.4 k Ω , 1%, 0.1 W, 0603 | Yageo America | RC0603FR-0727K4L | 1 |
| TP1, TP2 | Test Point, Compact, Red, TH | Keystone | 5005 | 2 |
| TP3, TP4 | Test Point, Compact, Black, TH | Keystone | 5006 | 2 |

Table 2. Bill of Materials (BOM) (continued)

| DESIGNATOR | DESCRIPTION | MANUFACTURER | PART NUMBER | QTY |
|-------------------------------|--|-------------------|-------------|-----|
| TP5, TP6, TP7, TP8, TP9, TP10 | Test Point, Compact, White, TH | Keystone | 5007 | 6 |
| U1 | 30V Wide VIN 4-Switch Synchronous Buck-Boost Controller, RHF (R-PVQFN-N28) | Texas Instruments | LM34936RHFT | 1 |

6 Re-Configuring the Average Current Loop

| PART | USE I _{OUT} LOOP | USE I _{IN} LOOP |
|----------|-------------------------------------|------------------------------------|
| R2 | Populate (see data sheet for value) | 0 Ω (default) |
| R23, R27 | 100 Ω (default) | De-populate |
| R1 | 0 Ω (default) | Populate (see datasheet for value) |
| R20, R28 | De-populate | 100 Ω |
| C32 | Populate (see datasheet for value) | Populate (see datasheet for value) |

7 Board PCB

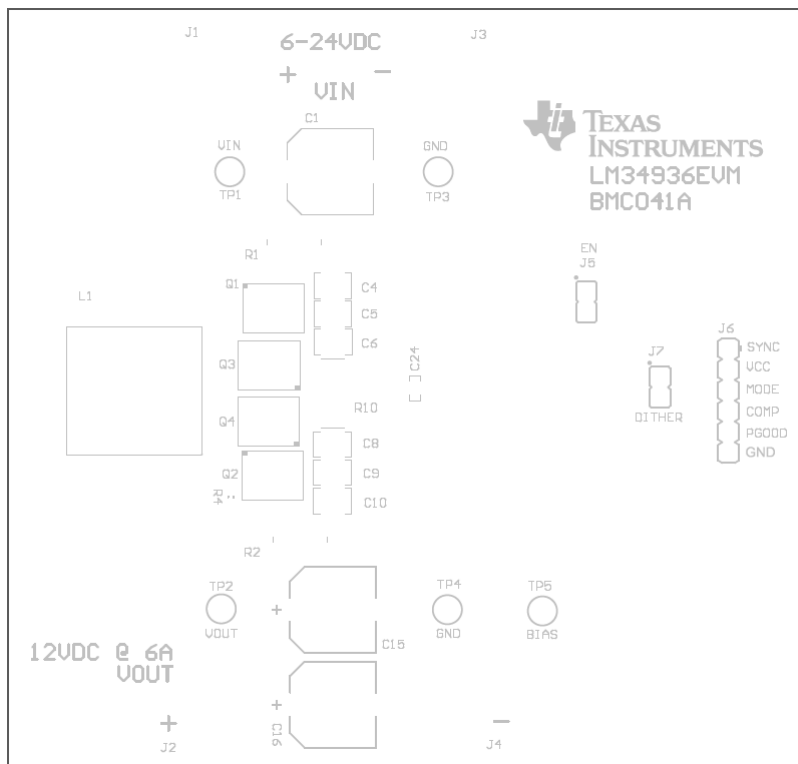

Figure 13. Top Overlay

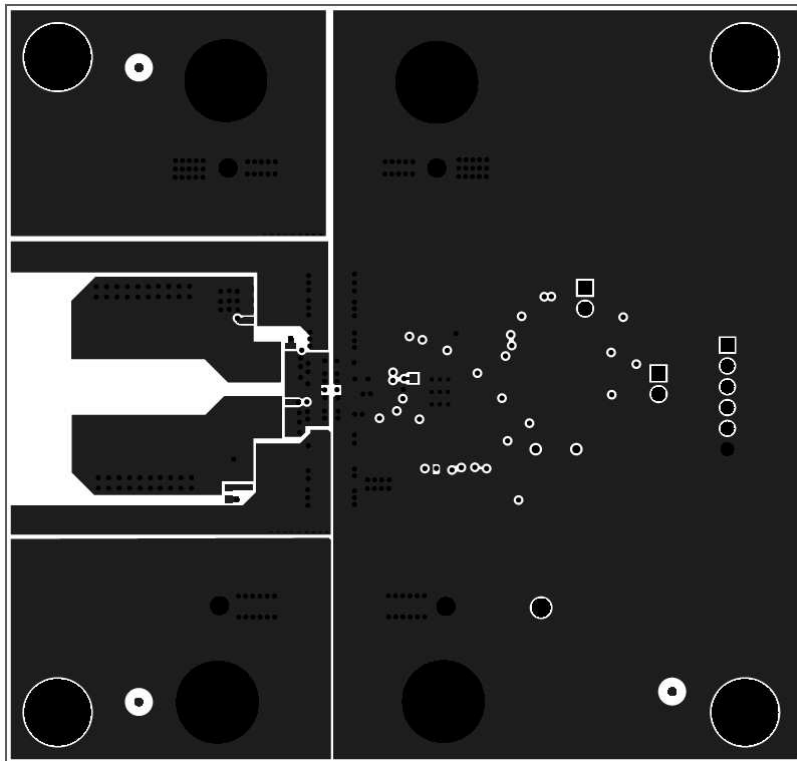

Figure 14. Top Layer

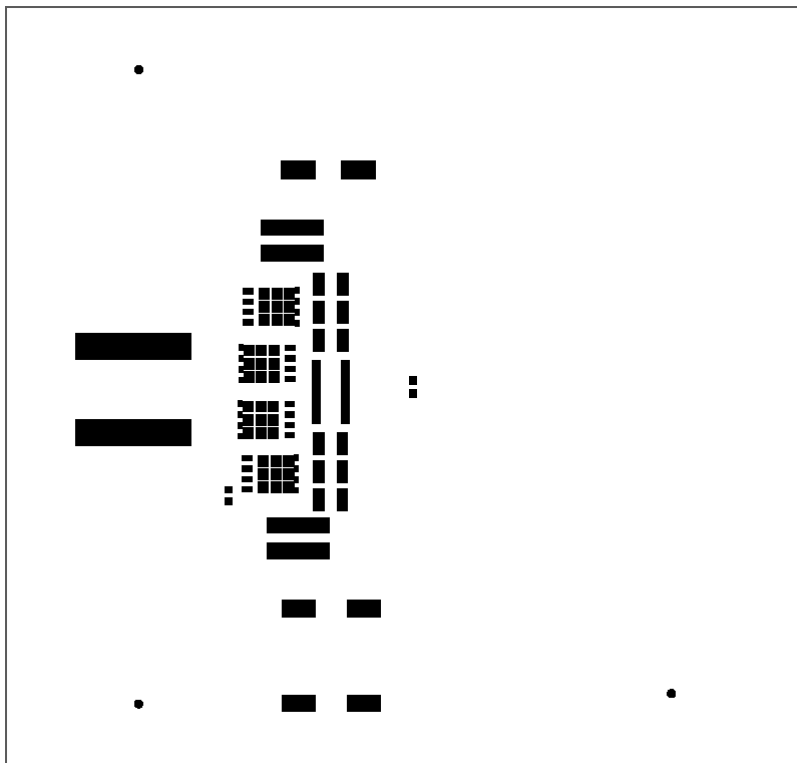

Figure 15. Top Solder

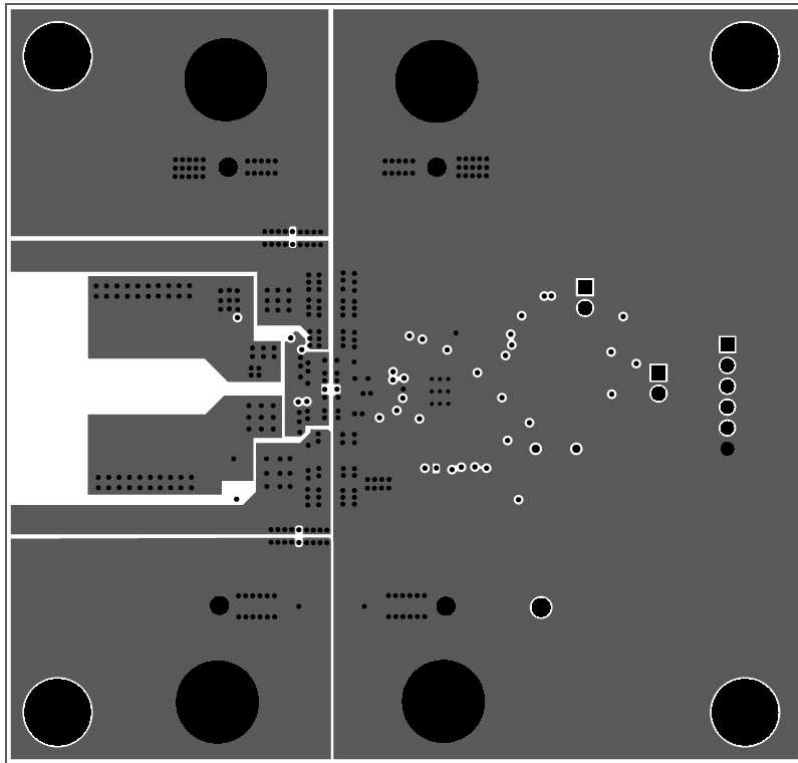

Figure 16. Mid Layer 2

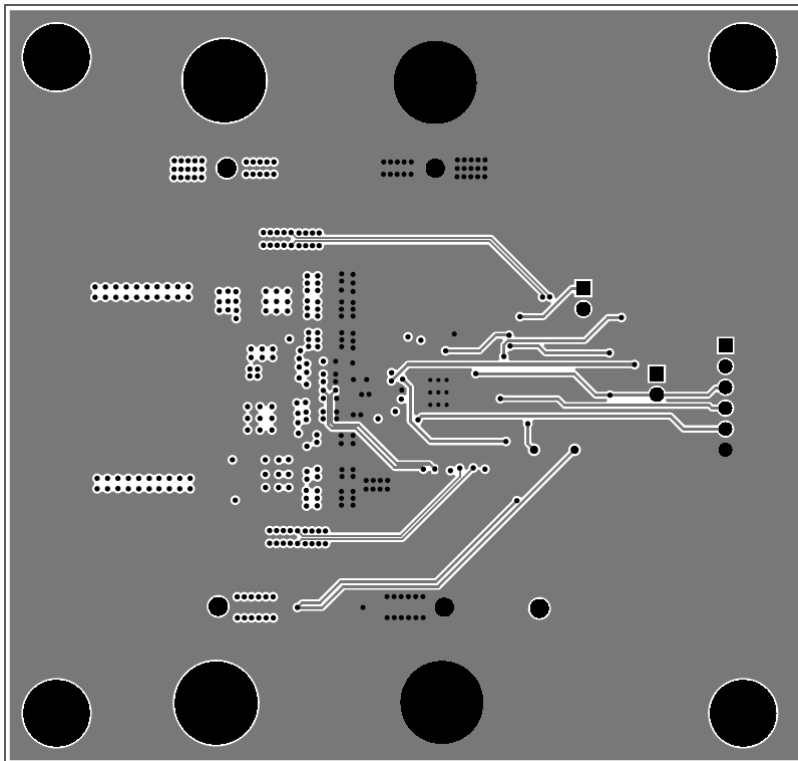

Figure 17. Mid Layer 3

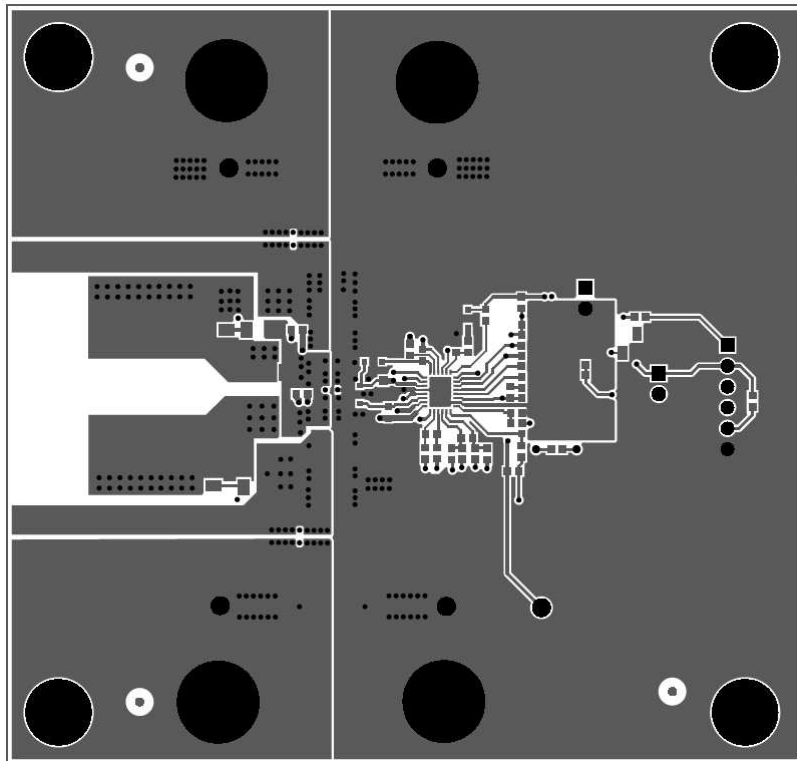

Figure 18. Bottom Layer

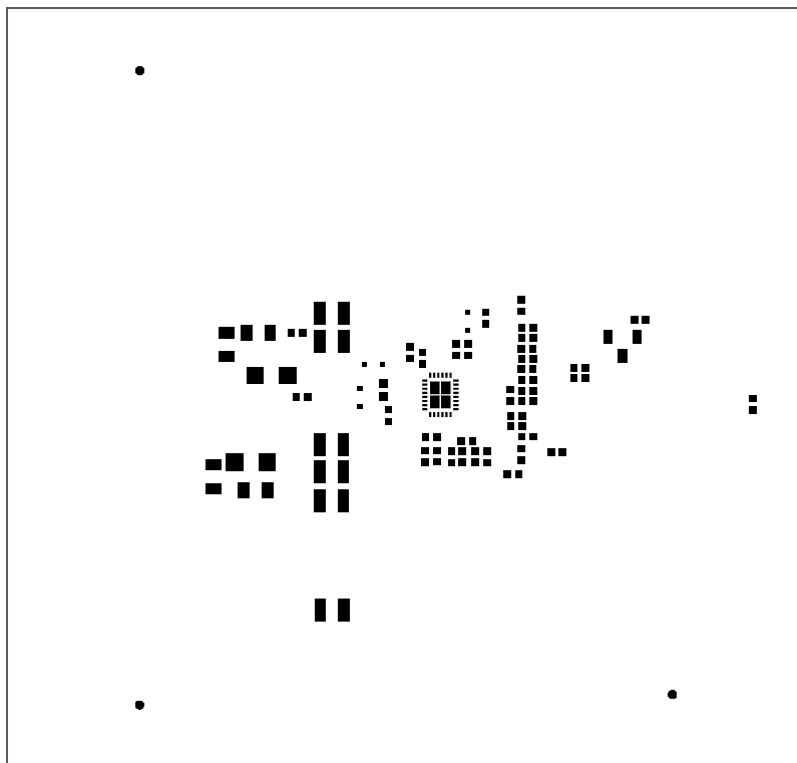

Figure 19. Bottom Solder

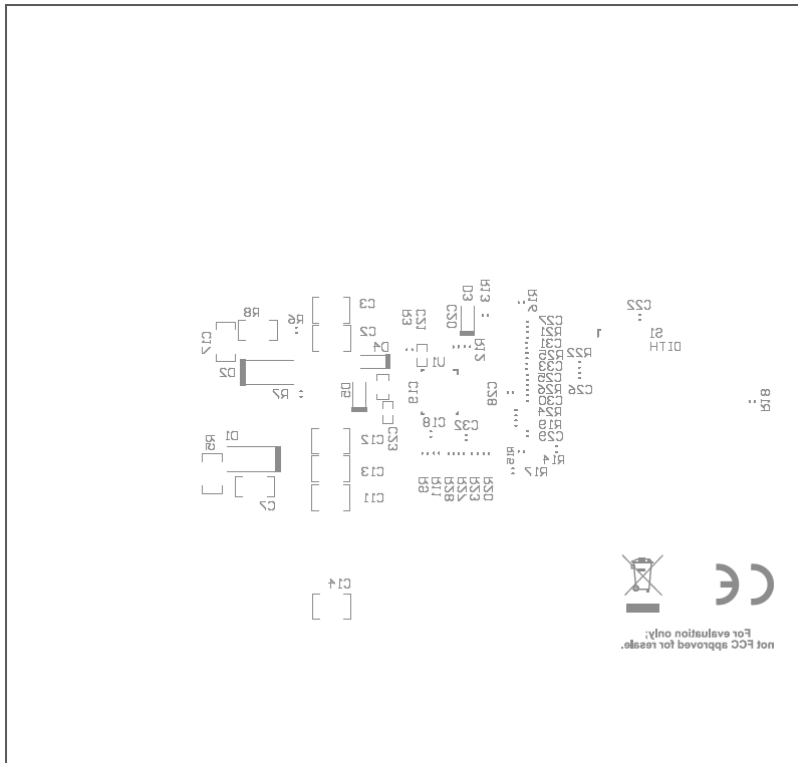

Figure 20. Bottom Overlay

STANDARD TERMS FOR EVALUATION MODULES

1. *Delivery:* TI delivers TI evaluation boards, kits, or modules, including any accompanying demonstration software, components, and/or documentation which may be provided together or separately (collectively, an "EVM" or "EVMs") to the User ("User") in accordance with the terms set forth herein. User's acceptance of the EVM is expressly subject to the following terms.
 - 1.1 EVMs are intended solely for product or software developers for use in a research and development setting to facilitate feasibility evaluation, experimentation, or scientific analysis of TI semiconductor products. EVMs have no direct function and are not finished products. EVMs shall not be directly or indirectly assembled as a part or subassembly in any finished product. For clarification, any software or software tools provided with the EVM ("Software") shall not be subject to the terms and conditions set forth herein but rather shall be subject to the applicable terms that accompany such Software
 - 1.2 EVMs are not intended for consumer or household use. EVMs may not be sold, sublicensed, leased, rented, loaned, assigned, or otherwise distributed for commercial purposes by Users, in whole or in part, or used in any finished product or production system.
2. *Limited Warranty and Related Remedies/Disclaimers:*
 - 2.1 These terms do not apply to Software. The warranty, if any, for Software is covered in the applicable Software License Agreement.
 - 2.2 TI warrants that the TI EVM will conform to TI's published specifications for ninety (90) days after the date TI delivers such EVM to User. Notwithstanding the foregoing, TI shall not be liable for a nonconforming EVM if (a) the nonconformity was caused by neglect, misuse or mistreatment by an entity other than TI, including improper installation or testing, or for any EVMs that have been altered or modified in any way by an entity other than TI, (b) the nonconformity resulted from User's design, specifications or instructions for such EVMs or improper system design, or (c) User has not paid on time. Testing and other quality control techniques are used to the extent TI deems necessary. TI does not test all parameters of each EVM. User's claims against TI under this Section 2 are void if User fails to notify TI of any apparent defects in the EVMs within ten (10) business days after delivery, or of any hidden defects with ten (10) business days after the defect has been detected.
 - 2.3 TI's sole liability shall be at its option to repair or replace EVMs that fail to conform to the warranty set forth above, or credit User's account for such EVM. TI's liability under this warranty shall be limited to EVMs that are returned during the warranty period to the address designated by TI and that are determined by TI not to conform to such warranty. If TI elects to repair or replace such EVM, TI shall have a reasonable time to repair such EVM or provide replacements. Repaired EVMs shall be warranted for the remainder of the original warranty period. Replaced EVMs shall be warranted for a new full ninety (90) day warranty period.
3. *Regulatory Notices:*
 - 3.1 *United States*
 - 3.1.1 *Notice applicable to EVMs not FCC-Approved:*

FCC NOTICE: This kit is designed to allow product developers to evaluate electronic components, circuitry, or software associated with the kit to determine whether to incorporate such items in a finished product and software developers to write software applications for use with the end product. This kit is not a finished product and when assembled may not be resold or otherwise marketed unless all required FCC equipment authorizations are first obtained. Operation is subject to the condition that this product not cause harmful interference to licensed radio stations and that this product accept harmful interference. Unless the assembled kit is designed to operate under part 15, part 18 or part 95 of this chapter, the operator of the kit must operate under the authority of an FCC license holder or must secure an experimental authorization under part 5 of this chapter.
 - 3.1.2 *For EVMs annotated as FCC – FEDERAL COMMUNICATIONS COMMISSION Part 15 Compliant:*

CAUTION

This device complies with part 15 of the FCC Rules. Operation is subject to the following two conditions: (1) This device may not cause harmful interference, and (2) this device must accept any interference received, including interference that may cause undesired operation.

Changes or modifications not expressly approved by the party responsible for compliance could void the user's authority to operate the equipment.

FCC Interference Statement for Class A EVM devices

NOTE: This equipment has been tested and found to comply with the limits for a Class A digital device, pursuant to part 15 of the FCC Rules. These limits are designed to provide reasonable protection against harmful interference when the equipment is operated in a commercial environment. This equipment generates, uses, and can radiate radio frequency energy and, if not installed and used in accordance with the instruction manual, may cause harmful interference to radio communications. Operation of this equipment in a residential area is likely to cause harmful interference in which case the user will be required to correct the interference at his own expense.

FCC Interference Statement for Class B EVM devices

NOTE: This equipment has been tested and found to comply with the limits for a Class B digital device, pursuant to part 15 of the FCC Rules. These limits are designed to provide reasonable protection against harmful interference in a residential installation. This equipment generates, uses and can radiate radio frequency energy and, if not installed and used in accordance with the instructions, may cause harmful interference to radio communications. However, there is no guarantee that interference will not occur in a particular installation. If this equipment does cause harmful interference to radio or television reception, which can be determined by turning the equipment off and on, the user is encouraged to try to correct the interference by one or more of the following measures:

- Reorient or relocate the receiving antenna.
- Increase the separation between the equipment and receiver.
- Connect the equipment into an outlet on a circuit different from that to which the receiver is connected.
- Consult the dealer or an experienced radio/TV technician for help.

3.2 Canada

3.2.1 For EVMs issued with an Industry Canada Certificate of Conformance to RSS-210 or RSS-247

Concerning EVMs Including Radio Transmitters:

This device complies with Industry Canada license-exempt RSSs. Operation is subject to the following two conditions:

(1) this device may not cause interference, and (2) this device must accept any interference, including interference that may cause undesired operation of the device.

Concernant les EVMs avec appareils radio:

Le présent appareil est conforme aux CNR d'Industrie Canada applicables aux appareils radio exempts de licence. L'exploitation est autorisée aux deux conditions suivantes: (1) l'appareil ne doit pas produire de brouillage, et (2) l'utilisateur de l'appareil doit accepter tout brouillage radioélectrique subi, même si le brouillage est susceptible d'en compromettre le fonctionnement.

Concerning EVMs Including Detachable Antennas:

Under Industry Canada regulations, this radio transmitter may only operate using an antenna of a type and maximum (or lesser) gain approved for the transmitter by Industry Canada. To reduce potential radio interference to other users, the antenna type and its gain should be so chosen that the equivalent isotropically radiated power (e.i.r.p.) is not more than that necessary for successful communication. This radio transmitter has been approved by Industry Canada to operate with the antenna types listed in the user guide with the maximum permissible gain and required antenna impedance for each antenna type indicated. Antenna types not included in this list, having a gain greater than the maximum gain indicated for that type, are strictly prohibited for use with this device.

Concernant les EVMs avec antennes détachables

Conformément à la réglementation d'Industrie Canada, le présent émetteur radio peut fonctionner avec une antenne d'un type et d'un gain maximal (ou inférieur) approuvé pour l'émetteur par Industrie Canada. Dans le but de réduire les risques de brouillage radioélectrique à l'intention des autres utilisateurs, il faut choisir le type d'antenne et son gain de sorte que la puissance isotrope rayonnée équivalente (p.i.r.e.) ne dépasse pas l'intensité nécessaire à l'établissement d'une communication satisfaisante. Le présent émetteur radio a été approuvé par Industrie Canada pour fonctionner avec les types d'antenne énumérés dans le manuel d'usage et ayant un gain admissible maximal et l'impédance requise pour chaque type d'antenne. Les types d'antenne non inclus dans cette liste, ou dont le gain est supérieur au gain maximal indiqué, sont strictement interdits pour l'exploitation de l'émetteur.

3.3 Japan

3.3.1 *Notice for EVMs delivered in Japan:* Please see http://www.tij.co.jp/lstds/ti_ja/general/eStore/notice_01.page 日本国内に輸入される評価用キット、ボードについては、次のところをご覧ください。
http://www.tij.co.jp/lstds/ti_ja/general/eStore/notice_01.page

3.3.2 *Notice for Users of EVMs Considered "Radio Frequency Products" in Japan:* EVMs entering Japan may not be certified by TI as conforming to Technical Regulations of Radio Law of Japan.

If User uses EVMs in Japan, not certified to Technical Regulations of Radio Law of Japan, User is required to follow the instructions set forth by Radio Law of Japan, which includes, but is not limited to, the instructions below with respect to EVMs (which for the avoidance of doubt are stated strictly for convenience and should be verified by User):

1. Use EVMs in a shielded room or any other test facility as defined in the notification #173 issued by Ministry of Internal Affairs and Communications on March 28, 2006, based on Sub-section 1.1 of Article 6 of the Ministry's Rule for Enforcement of Radio Law of Japan,
2. Use EVMs only after User obtains the license of Test Radio Station as provided in Radio Law of Japan with respect to EVMs, or
3. Use of EVMs only after User obtains the Technical Regulations Conformity Certification as provided in Radio Law of Japan with respect to EVMs. Also, do not transfer EVMs, unless User gives the same notice above to the transferee. Please note that if User does not follow the instructions above, User will be subject to penalties of Radio Law of Japan.

【無線電波を送信する製品の開発キットをお使いになる際の注意事項】 開発キットの中には技術基準適合証明を受けていないものがあります。技術適合証明を受けていないものご使用に際しては、電波法遵守のため、以下のいずれかの措置を取っていただく必要がありますのでご注意ください。

1. 電波法施行規則第6条第1項第1号に基づく平成18年3月28日総務省告示第173号で定められた電波暗室等の試験設備でご使用いただく。
2. 実験局の免許を取得後ご使用いただく。
3. 技術基準適合証明を取得後ご使用いただく。

なお、本製品は、上記の「ご使用にあたっての注意」を譲渡先、移転先に通知しない限り、譲渡、移転できないものとします。

上記を遵守頂けない場合は、電波法の罰則が適用される可能性があることをご留意ください。日本テキサス・インスツルメンツ株式会社
東京都新宿区西新宿 6 丁目 2 4 番 1 号
西新宿三井ビル

3.3.3 *Notice for EVMs for Power Line Communication:* Please see http://www.tij.co.jp/lstds/ti_ja/general/eStore/notice_02.page
電力線搬送波通信についての開発キットをお使いになる際の注意事項については、次のところをご覧ください。 http://www.tij.co.jp/lstds/ti_ja/general/eStore/notice_02.page

3.4 *European Union*

3.4.1 *For EVMs subject to EU Directive 2014/30/EU (Electromagnetic Compatibility Directive):*

This is a class A product intended for use in environments other than domestic environments that are connected to a low-voltage power-supply network that supplies buildings used for domestic purposes. In a domestic environment this product may cause radio interference in which case the user may be required to take adequate measures.

4 *EVM Use Restrictions and Warnings:*

4.1 EVMS ARE NOT FOR USE IN FUNCTIONAL SAFETY AND/OR SAFETY CRITICAL EVALUATIONS, INCLUDING BUT NOT LIMITED TO EVALUATIONS OF LIFE SUPPORT APPLICATIONS.

4.2 User must read and apply the user guide and other available documentation provided by TI regarding the EVM prior to handling or using the EVM, including without limitation any warning or restriction notices. The notices contain important safety information related to, for example, temperatures and voltages.

4.3 *Safety-Related Warnings and Restrictions:*

4.3.1 User shall operate the EVM within TI's recommended specifications and environmental considerations stated in the user guide, other available documentation provided by TI, and any other applicable requirements and employ reasonable and customary safeguards. Exceeding the specified performance ratings and specifications (including but not limited to input and output voltage, current, power, and environmental ranges) for the EVM may cause personal injury or death, or property damage. If there are questions concerning performance ratings and specifications, User should contact a TI field representative prior to connecting interface electronics including input power and intended loads. Any loads applied outside of the specified output range may also result in unintended and/or inaccurate operation and/or possible permanent damage to the EVM and/or interface electronics. Please consult the EVM user guide prior to connecting any load to the EVM output. If there is uncertainty as to the load specification, please contact a TI field representative. During normal operation, even with the inputs and outputs kept within the specified allowable ranges, some circuit components may have elevated case temperatures. These components include but are not limited to linear regulators, switching transistors, pass transistors, current sense resistors, and heat sinks, which can be identified using the information in the associated documentation. When working with the EVM, please be aware that the EVM may become very warm.

4.3.2 EVMs are intended solely for use by technically qualified, professional electronics experts who are familiar with the dangers and application risks associated with handling electrical mechanical components, systems, and subsystems. User assumes all responsibility and liability for proper and safe handling and use of the EVM by User or its employees, affiliates, contractors or designees. User assumes all responsibility and liability to ensure that any interfaces (electronic and/or mechanical) between the EVM and any human body are designed with suitable isolation and means to safely limit accessible leakage currents to minimize the risk of electrical shock hazard. User assumes all responsibility and liability for any improper or unsafe handling or use of the EVM by User or its employees, affiliates, contractors or designees.

4.4 User assumes all responsibility and liability to determine whether the EVM is subject to any applicable international, federal, state, or local laws and regulations related to User's handling and use of the EVM and, if applicable, User assumes all responsibility and liability for compliance in all respects with such laws and regulations. User assumes all responsibility and liability for proper disposal and recycling of the EVM consistent with all applicable international, federal, state, and local requirements.

5. *Accuracy of Information:* To the extent TI provides information on the availability and function of EVMs, TI attempts to be as accurate as possible. However, TI does not warrant the accuracy of EVM descriptions, EVM availability or other information on its websites as accurate, complete, reliable, current, or error-free.

6. *Disclaimers:*
- 6.1 EXCEPT AS SET FORTH ABOVE, EVMS AND ANY MATERIALS PROVIDED WITH THE EVM (INCLUDING, BUT NOT LIMITED TO, REFERENCE DESIGNS AND THE DESIGN OF THE EVM ITSELF) ARE PROVIDED "AS IS" AND "WITH ALL FAULTS." TI DISCLAIMS ALL OTHER WARRANTIES, EXPRESS OR IMPLIED, REGARDING SUCH ITEMS, INCLUDING BUT NOT LIMITED TO ANY EPIDEMIC FAILURE WARRANTY OR IMPLIED WARRANTIES OF MERCHANTABILITY OR FITNESS FOR A PARTICULAR PURPOSE OR NON-INFRINGEMENT OF ANY THIRD PARTY PATENTS, COPYRIGHTS, TRADE SECRETS OR OTHER INTELLECTUAL PROPERTY RIGHTS.
- 6.2 EXCEPT FOR THE LIMITED RIGHT TO USE THE EVM SET FORTH HEREIN, NOTHING IN THESE TERMS SHALL BE CONSTRUED AS GRANTING OR CONFERRING ANY RIGHTS BY LICENSE, PATENT, OR ANY OTHER INDUSTRIAL OR INTELLECTUAL PROPERTY RIGHT OF TI, ITS SUPPLIERS/LICENSORS OR ANY OTHER THIRD PARTY, TO USE THE EVM IN ANY FINISHED END-USER OR READY-TO-USE FINAL PRODUCT, OR FOR ANY INVENTION, DISCOVERY OR IMPROVEMENT, REGARDLESS OF WHEN MADE, CONCEIVED OR ACQUIRED.
7. *USER'S INDEMNITY OBLIGATIONS AND REPRESENTATIONS.* USER WILL DEFEND, INDEMNIFY AND HOLD TI, ITS LICENSORS AND THEIR REPRESENTATIVES HARMLESS FROM AND AGAINST ANY AND ALL CLAIMS, DAMAGES, LOSSES, EXPENSES, COSTS AND LIABILITIES (COLLECTIVELY, "CLAIMS") ARISING OUT OF OR IN CONNECTION WITH ANY HANDLING OR USE OF THE EVM THAT IS NOT IN ACCORDANCE WITH THESE TERMS. THIS OBLIGATION SHALL APPLY WHETHER CLAIMS ARISE UNDER STATUTE, REGULATION, OR THE LAW OF TORT, CONTRACT OR ANY OTHER LEGAL THEORY, AND EVEN IF THE EVM FAILS TO PERFORM AS DESCRIBED OR EXPECTED.
8. *Limitations on Damages and Liability:*
- 8.1 *General Limitations.* IN NO EVENT SHALL TI BE LIABLE FOR ANY SPECIAL, COLLATERAL, INDIRECT, PUNITIVE, INCIDENTAL, CONSEQUENTIAL, OR EXEMPLARY DAMAGES IN CONNECTION WITH OR ARISING OUT OF THESE TERMS OR THE USE OF THE EVMS , REGARDLESS OF WHETHER TI HAS BEEN ADVISED OF THE POSSIBILITY OF SUCH DAMAGES. EXCLUDED DAMAGES INCLUDE, BUT ARE NOT LIMITED TO, COST OF REMOVAL OR REINSTALLATION, ANCILLARY COSTS TO THE PROCUREMENT OF SUBSTITUTE GOODS OR SERVICES, RETESTING, OUTSIDE COMPUTER TIME, LABOR COSTS, LOSS OF GOODWILL, LOSS OF PROFITS, LOSS OF SAVINGS, LOSS OF USE, LOSS OF DATA, OR BUSINESS INTERRUPTION. NO CLAIM, SUIT OR ACTION SHALL BE BROUGHT AGAINST TI MORE THAN TWELVE (12) MONTHS AFTER THE EVENT THAT GAVE RISE TO THE CAUSE OF ACTION HAS OCCURRED.
- 8.2 *Specific Limitations.* IN NO EVENT SHALL TI'S AGGREGATE LIABILITY FROM ANY USE OF AN EVM PROVIDED HEREUNDER, INCLUDING FROM ANY WARRANTY, INDEMNITY OR OTHER OBLIGATION ARISING OUT OF OR IN CONNECTION WITH THESE TERMS, , EXCEED THE TOTAL AMOUNT PAID TO TI BY USER FOR THE PARTICULAR EVM(S) AT ISSUE DURING THE PRIOR TWELVE (12) MONTHS WITH RESPECT TO WHICH LOSSES OR DAMAGES ARE CLAIMED. THE EXISTENCE OF MORE THAN ONE CLAIM SHALL NOT ENLARGE OR EXTEND THIS LIMIT.
9. *Return Policy.* Except as otherwise provided, TI does not offer any refunds, returns, or exchanges. Furthermore, no return of EVM(s) will be accepted if the package has been opened and no return of the EVM(s) will be accepted if they are damaged or otherwise not in a resalable condition. If User feels it has been incorrectly charged for the EVM(s) it ordered or that delivery violates the applicable order, User should contact TI. All refunds will be made in full within thirty (30) working days from the return of the components(s), excluding any postage or packaging costs.
10. *Governing Law:* These terms and conditions shall be governed by and interpreted in accordance with the laws of the State of Texas, without reference to conflict-of-laws principles. User agrees that non-exclusive jurisdiction for any dispute arising out of or relating to these terms and conditions lies within courts located in the State of Texas and consents to venue in Dallas County, Texas. Notwithstanding the foregoing, any judgment may be enforced in any United States or foreign court, and TI may seek injunctive relief in any United States or foreign court.

IMPORTANT NOTICE FOR TI DESIGN INFORMATION AND RESOURCES

Texas Instruments Incorporated ("TI") technical, application or other design advice, services or information, including, but not limited to, reference designs and materials relating to evaluation modules, (collectively, "TI Resources") are intended to assist designers who are developing applications that incorporate TI products; by downloading, accessing or using any particular TI Resource in any way, you (individually or, if you are acting on behalf of a company, your company) agree to use it solely for this purpose and subject to the terms of this Notice.

TI's provision of TI Resources does not expand or otherwise alter TI's applicable published warranties or warranty disclaimers for TI products, and no additional obligations or liabilities arise from TI providing such TI Resources. TI reserves the right to make corrections, enhancements, improvements and other changes to its TI Resources.

You understand and agree that you remain responsible for using your independent analysis, evaluation and judgment in designing your applications and that you have full and exclusive responsibility to assure the safety of your applications and compliance of your applications (and of all TI products used in or for your applications) with all applicable regulations, laws and other applicable requirements. You represent that, with respect to your applications, you have all the necessary expertise to create and implement safeguards that (1) anticipate dangerous consequences of failures, (2) monitor failures and their consequences, and (3) lessen the likelihood of failures that might cause harm and take appropriate actions. You agree that prior to using or distributing any applications that include TI products, you will thoroughly test such applications and the functionality of such TI products as used in such applications. TI has not conducted any testing other than that specifically described in the published documentation for a particular TI Resource.

You are authorized to use, copy and modify any individual TI Resource only in connection with the development of applications that include the TI product(s) identified in such TI Resource. NO OTHER LICENSE, EXPRESS OR IMPLIED, BY ESTOPPEL OR OTHERWISE TO ANY OTHER TI INTELLECTUAL PROPERTY RIGHT, AND NO LICENSE TO ANY TECHNOLOGY OR INTELLECTUAL PROPERTY RIGHT OF TI OR ANY THIRD PARTY IS GRANTED HEREIN, including but not limited to any patent right, copyright, mask work right, or other intellectual property right relating to any combination, machine, or process in which TI products or services are used. Information regarding or referencing third-party products or services does not constitute a license to use such products or services, or a warranty or endorsement thereof. Use of TI Resources may require a license from a third party under the patents or other intellectual property of the third party, or a license from TI under the patents or other intellectual property of TI.

TI RESOURCES ARE PROVIDED "AS IS" AND WITH ALL FAULTS. TI DISCLAIMS ALL OTHER WARRANTIES OR REPRESENTATIONS, EXPRESS OR IMPLIED, REGARDING TI RESOURCES OR USE THEREOF, INCLUDING BUT NOT LIMITED TO ACCURACY OR COMPLETENESS, TITLE, ANY EPIDEMIC FAILURE WARRANTY AND ANY IMPLIED WARRANTIES OF MERCHANTABILITY, FITNESS FOR A PARTICULAR PURPOSE, AND NON-INFRINGEMENT OF ANY THIRD PARTY INTELLECTUAL PROPERTY RIGHTS.

TI SHALL NOT BE LIABLE FOR AND SHALL NOT DEFEND OR INDEMNIFY YOU AGAINST ANY CLAIM, INCLUDING BUT NOT LIMITED TO ANY INFRINGEMENT CLAIM THAT RELATES TO OR IS BASED ON ANY COMBINATION OF PRODUCTS EVEN IF DESCRIBED IN TI RESOURCES OR OTHERWISE. IN NO EVENT SHALL TI BE LIABLE FOR ANY ACTUAL, DIRECT, SPECIAL, COLLATERAL, INDIRECT, PUNITIVE, INCIDENTAL, CONSEQUENTIAL OR EXEMPLARY DAMAGES IN CONNECTION WITH OR ARISING OUT OF TI RESOURCES OR USE THEREOF, AND REGARDLESS OF WHETHER TI HAS BEEN ADVISED OF THE POSSIBILITY OF SUCH DAMAGES.

You agree to fully indemnify TI and its representatives against any damages, costs, losses, and/or liabilities arising out of your non-compliance with the terms and provisions of this Notice.

This Notice applies to TI Resources. Additional terms apply to the use and purchase of certain types of materials, TI products and services. These include; without limitation, TI's standard terms for semiconductor products (<http://www.ti.com/sc/docs/stdterms.htm>), [evaluation modules](#), and [samples](http://www.ti.com/sc/docs/sampterm.htm) (<http://www.ti.com/sc/docs/sampterm.htm>).

Mailing Address: Texas Instruments, Post Office Box 655303, Dallas, Texas 75265
Copyright © 2018, Texas Instruments Incorporated