

**ABSTRACT**

The LM5158EVM-FLY evaluation module showcases the features and performance of the LM5158 as wide input non-synchronous flyback controller to produce multiple output voltage rails for typical applications of the 3-phase inverter gate driver bias supplies. The standard configuration is designed to provide a regulated output of 10 V at 250 mA from an input of 8 V to 16 V, and three isolated 20-V rails at 75 mA, 75 mA, and 150 mA, respectively. The switching frequency is 250 kHz. This evaluation module was designed for ease of configuration, enabling the user to evaluate different applications on the same module. The PCB has two copper layers.

Table of Contents

1 Introduction	2
2 Electrical Parameters	3
3 Application Schematic	4
4 EVM Picture	5
5 Test Setup and Procedure	6
5.1 EVM Test Setup Schematic.....	6
5.2 Test Equipment	6
6 Test Data and Performance Curves	7
6.1 Efficiency.....	7
6.2 Output Regulation.....	7
6.3 Steady-State Waveforms.....	8
6.4 Start-Up Waveforms.....	9
6.5 Dynamic Responses.....	10
6.6 Short-Circuit Protection.....	10
6.7 Bode Plots.....	11
6.8 Thermal Image.....	12
7 Schematic	13
8 Bill of Materials	14
9 EVM Layout	16

List of Figures

Figure 3-1. Application Circuit.....	4
Figure 4-1. EVM Picture.....	5
Figure 5-1. Test Setup.....	6
Figure 6-1. Efficiency Under Different Input Voltages and Load Levels.....	7
Figure 6-2. Main Output Voltage Regulation Versus Main Output Load (I_{O2} , I_{O3} , I_{O4} = 10%).....	7
Figure 6-3. Main Output Voltage Regulation Versus Main Output Load (I_{O2} , I_{O3} , I_{O4} = 100%).....	7
Figure 6-4. Main Output Voltage Regulation Versus Input Voltage (I_{O2} , I_{O3} , I_{O4} = 100%).....	7
Figure 6-5. Voltage Regulation of Isolated Outputs Versus Input Voltage at 10% load.....	7
Figure 6-6. SW Waveform at 100% Load, Under 16-V Maximum V_{IN}	8
Figure 6-7. Zoomed SW Waveform at 100% Load, Under 16-V Maximum V_{IN}	8
Figure 6-8. SW Waveform at 10% Load, Under 16-V Maximum V_{IN}	8
Figure 6-9. PIV of D7 (main Output Rectifier) Under 100% Load and 16-V Maximum V_{IN}	8
Figure 6-10. PIV of D1 (V_{O2} Rectifier) Under 100% Load and 16-V Maximum V_{IN}	8
Figure 6-11. PIV of D4 (V_{O3} Rectifier) Under 100% Load and 16-V Maximum V_{IN}	8
Figure 6-12. PIV of D5 (V_{O4} Rectifier) Under 100% Load and 16-V Maximum V_{IN}	9
Figure 6-13. Main Output V_{O1} Ripple Voltage Under 250-mA Load.....	9
Figure 6-14. Isolated Output V_{O4} Ripple Voltage Under 150-mA Load.....	9
Figure 6-15. Start-Up at 10% Load on Each Output Rail.....	9

Figure 6-16. Start-Up at 100% Load on Each Output Rail.....	9
Figure 6-17. V_{O1} Response Under Step Load Between 125 mA and 250 mA, $V_{IN} = 12$ V, $I_{O2-4} = 10\%$	10
Figure 6-18. V_{O1} Response Under Step Load Between 1 mA to 250 mA, $V_{IN} = 12$ V, $I_{O2-4} = 10\%$	10
Figure 6-19. V_{O4} Response Under Step Load Between 100 mA and 150 mA, $V_{IN} = 12$ V, $I_{O1-3} = 10\%$	10
Figure 6-20. V_{O1} Response Under Input Change From 8 V to 16 V, 10% Load.....	10
Figure 6-21. Short-Circuit Protection With Hiccup Mode Disabled, $V_{IN} = 12$ V ($R_{13} = 0 \Omega$).....	10
Figure 6-22. Short-Circuit Protection With Hiccup Mode Enabled, $V_{IN} = 12$ V ($R_{13} = 62$ k Ω , $C_{29} = 47$ nF).....	10
Figure 6-23. Bode Plot ($V_{IN} = 12$ V).....	11
Figure 6-24. Bode Plot (V_{O1-4} : 100% Load).....	11
Figure 6-25. EVM Thermal Image at 12 V_{IN} and 100% Load.....	12
Figure 7-1. EVM Complete Schematic.....	13
Figure 9-1. Top Layer with Silkscreen.....	16
Figure 9-2. Top Layer.....	16
Figure 9-3. Bottom Layer Viewed From Top.....	17
Figure 9-4. Bottom Layer with Silkscreen Viewed From Bottom.....	17

List of Tables

Table 2-1. Electrical Performance Standard Configuration.....	3
Table 8-1. LM5158EVM-FLY Bill of Materials.....	14

Trademarks

All trademarks are the property of their respective owners.

1 Introduction

The LM5158EVM-FLY supports the following features and performance capabilities:

- Tightly regulated main output voltage: $V_{O1} = 10$ V $\pm 1\%$
- Three cross-regulated, isolated output voltages:
 - $V_{O2} = 20$ V
 - $V_{O3} = 20$ V
 - $V_{O4} = 20$ V
- Total rated load of 8.5 W:
 - 250 mA at V_{O1}
 - 75 mA at V_{O2}
 - 75 mA at V_{O3}
 - 150 mA at V_{O4}
- Peak efficiency > 90%
- Optional hiccup mode overloading protection
- 250-kHz switching frequency
- 2-layer PCB, 3.5 in \times 2.3 in

2 Electrical Parameters

Table 2-1 details the electrical performance standard configuration.

Table 2-1. Electrical Performance Standard Configuration

PARAMETER	TEST CONDITIONS	MIN	TYP	MAX	UNIT
Input Characteristics					
Input voltage range V_{IN}	Operation	8	12	16	V
Abs max input voltage V_{INMAX}	Operation without damage			18	V
Input voltage turn-on $V_{IN(ON)}$	Adjustable by the UVLO/SYNC resistors		7.6		V
Input voltage turn-on $V_{IN(OFF)}$			7.1		V
Output Characteristics					
Main output voltage V_{O1}			10		V
First isolated output voltage V_{O2}			20		V
Second isolated output voltage V_{O3}			20		V
Third isolated output voltage V_{O4}			20		V
Main output load current I_{O1}				0.250	A
First isolated output load current I_{O2}				0.075	A
Second isolated output load current I_{O3}				0.075	A
Third isolated output load current I_{O4}				0.150	A
System Characteristics					
Switching frequency			250		kHz
Peak efficiency	$V_{IN} = 12$ V, rated load at all output rails		90		%
Junction temperature		-40		150	°C
Transformer Specifications (Coilcraft ZB1324-AL)					
Primary inductances			8		μH
Turns ratio	(2-4) : (1-3)		1		
	(5-6) : (1-3)		1.2		
	(8-7) : (1-3)		2.4		
	(10-9) : (1-3)		2.4		
	(12-11) : (1-3)		2.4		
Saturation current	20% inductance reduction		5.5		A
Leakage inductance				90	nH

4 EVM Picture

Figure 4-1 is a 3D printout of the EVM from the CAD tool. The actual color of the board can differ. The EVM also includes circuits for extra configurations. Not all components are populated on the EVM.

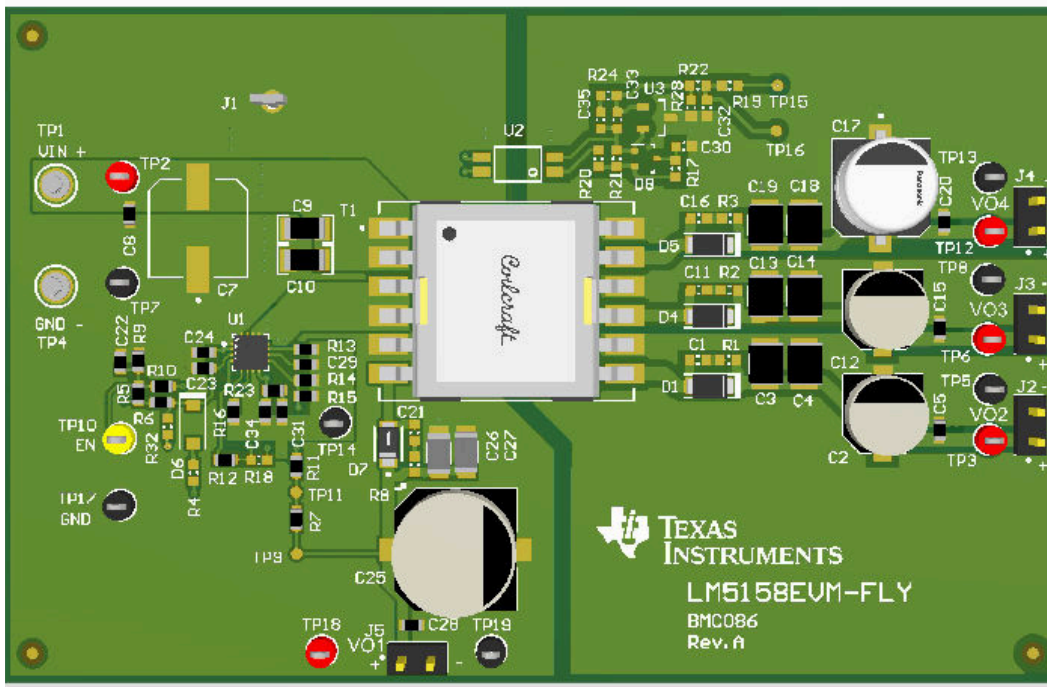

Figure 4-1. EVM Picture

5 Test Setup and Procedure

5.1 EVM Test Setup Schematic

Figure 5-1 shows the correct equipment connections and measurement points.

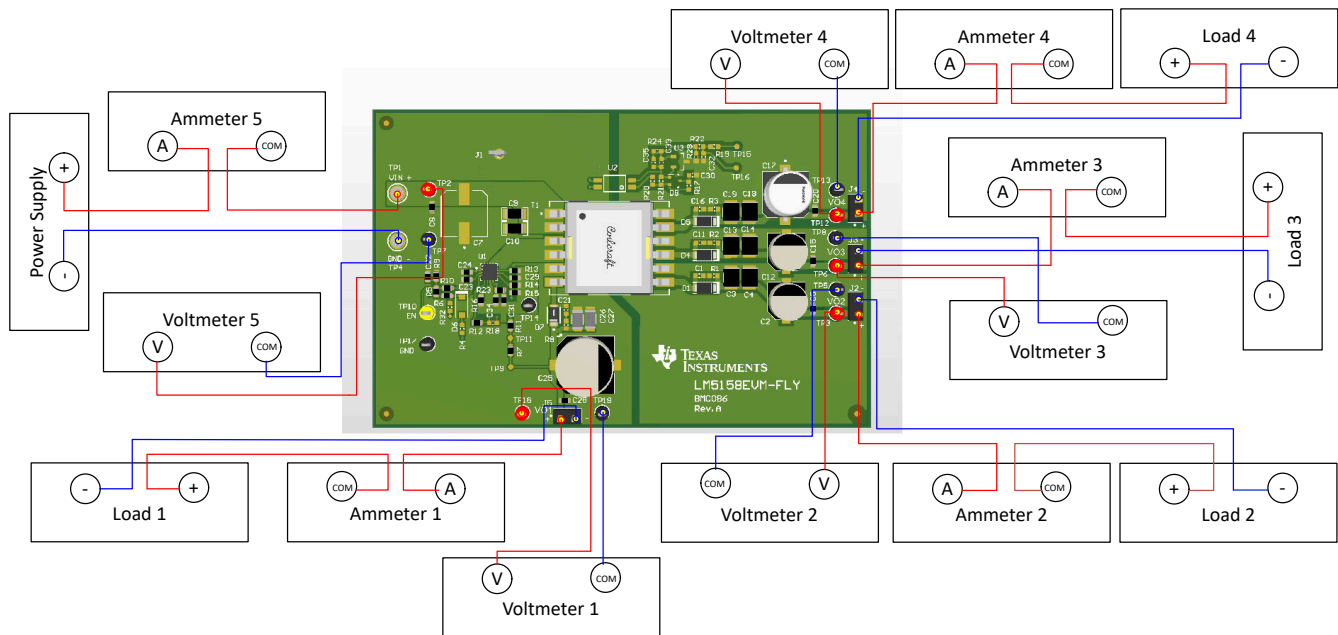

Figure 5-1. Test Setup

5.2 Test Equipment

Power Supply: Use an input voltage source that is a variable supply capable of 0 V to 16 V and sources at least 5 A.

Multimeters:

- Voltmeter 1: Non-isolated 10-V main output voltage V_{O1} , connect from TP18 (+) to TP19 (-).
- Voltmeter 2: Isolated 20-V output voltage V_{O2} , connect from TP3 (+) to TP5 (-).
- Voltmeter 3: Isolated 20-V output voltage V_{O3} , connect from TP6 (+) to TP8 (-).
- Voltmeter 4: Isolated 20-V output voltage V_{O4} , connect from TP12 (+) to TP13 (-).
- Voltmeter 5: Input voltage V_I , connect from TP2 (+) to TP7 (-).
- Ammeter 1: V_{O1} main output current, must be able to handle 1 A
- Ammeter 2: V_{O2} output current, must be able to handle 0.5 A
- Ammeter 3: V_{O3} output current, must be able to handle 0.5 A
- Ammeter 4: V_{O4} output current, must be able to handle 0.5 A
- Ammeter 5: Input current, must be able to handle 3 A

Loads: Electronic loads, pure resistive loads, or a combination of both, can be used at the four outputs.

- An electronic load can be used for each output rail. The electronic load should be constant resistance (CR) or constant current (CC) capable. It should safely handle 0.5 A at 20 V.
- Resistive load can also be used. Limit the minimum resistance for each output, which corresponds to the maximum power, with the following:
 - Load 1: 40 Ω or 250 mA
 - Load 2: 266.7 Ω or 75 mA
 - Load 3: 266.7 Ω or 75 mA
 - Load 4: 133.3 Ω or 150 mA

6 Test Data and Performance Curves

Figure 6-1 through Figure 6-24 present the typical performance of the LM5158EVM-FLY. Based on measurement techniques and environmental variables, measurements can differ slightly to the data presented.

6.1 Efficiency

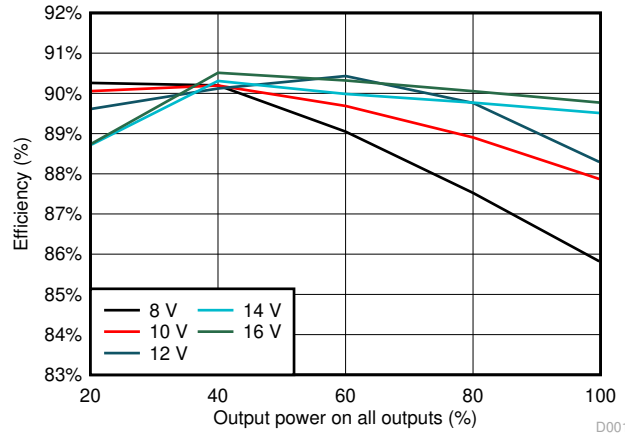

Figure 6-1. Efficiency Under Different Input Voltages and Load Levels

6.2 Output Regulation

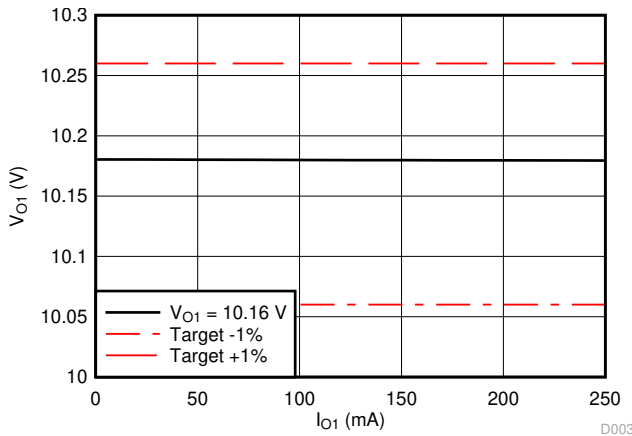

Figure 6-2. Main Output Voltage Regulation Versus Main Output Load (I_{O2} , I_{O3} , I_{O4} = 10%)

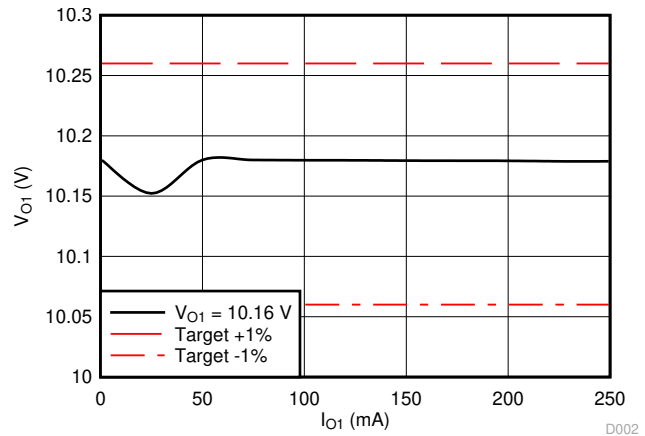

Figure 6-3. Main Output Voltage Regulation Versus Main Output Load (I_{O2} , I_{O3} , I_{O4} = 100%)

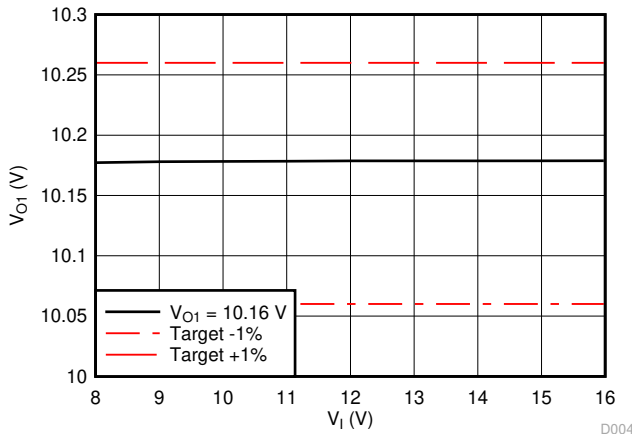

Figure 6-4. Main Output Voltage Regulation Versus Input Voltage (I_{O2} , I_{O3} , I_{O4} = 100%)

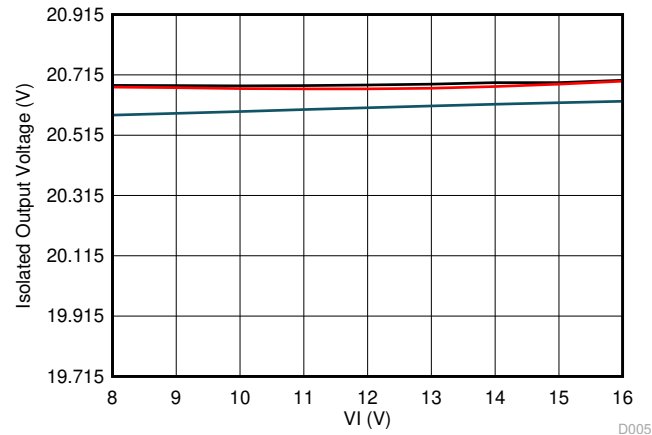

Figure 6-5. Voltage Regulation of Isolated Outputs Versus Input Voltage at 10% load

6.3 Steady-State Waveforms

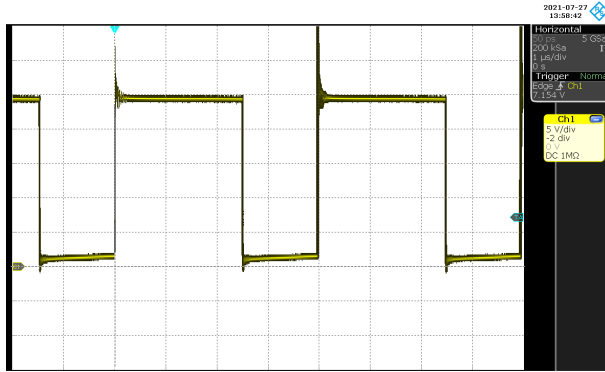

Figure 6-6. SW Waveform at 100% Load, Under 16-V Maximum V_{IN}

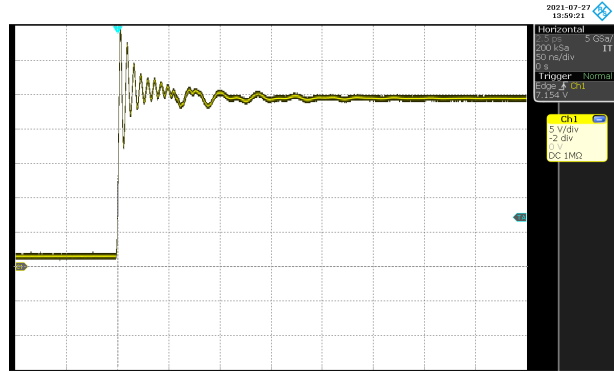

Figure 6-7. Zoomed SW Waveform at 100% Load, Under 16-V Maximum V_{IN}

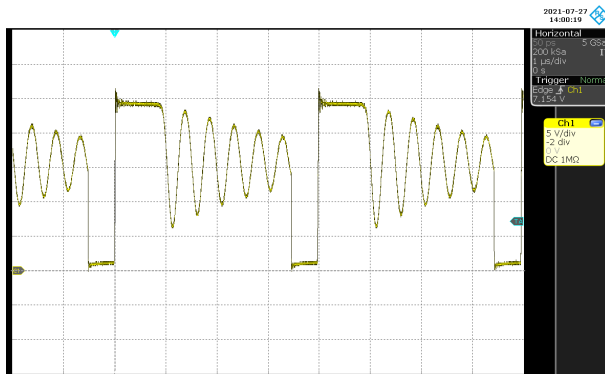

Figure 6-8. SW Waveform at 10% Load, Under 16-V Maximum V_{IN}



Figure 6-9. PIV of D7 (main Output Rectifier) Under 100% Load and 16-V Maximum V_{IN}

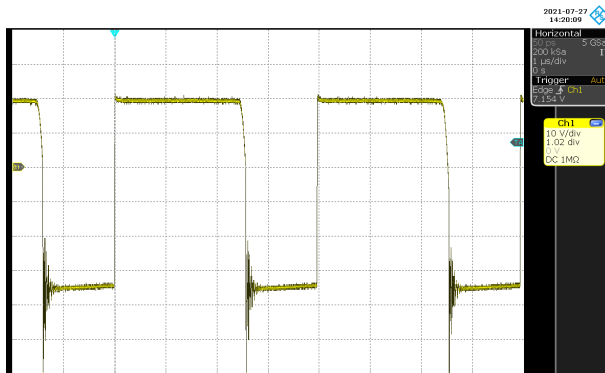

Figure 6-10. PIV of D1 (V_{O2} Rectifier) Under 100% Load and 16-V Maximum V_{IN}

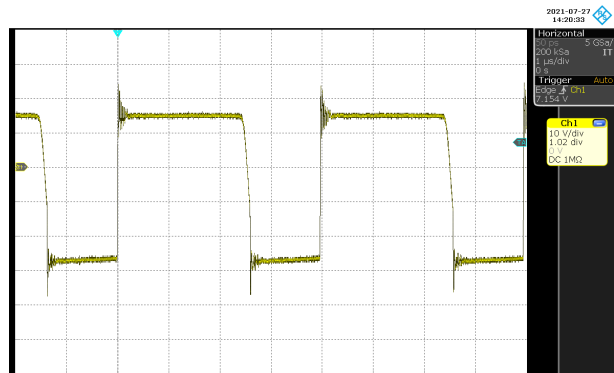

Figure 6-11. PIV of D4 (V_{O3} Rectifier) Under 100% Load and 16-V Maximum V_{IN}

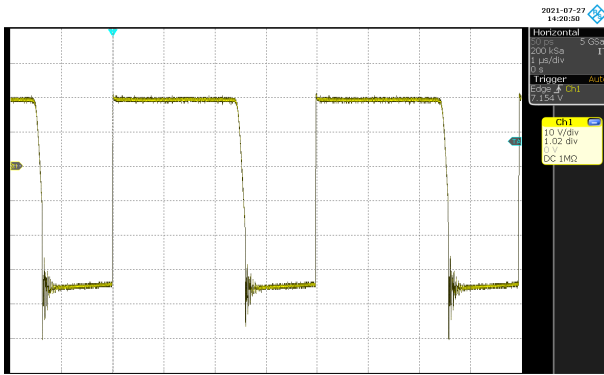

Figure 6-12. PIV of D5 (V_{O4} Rectifier) Under 100% Load and 16-V Maximum V_{IN}

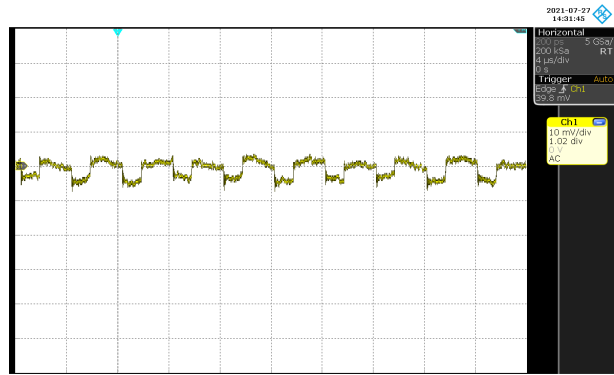

Figure 6-13. Main Output V_{O1} Ripple Voltage Under 250-mA Load

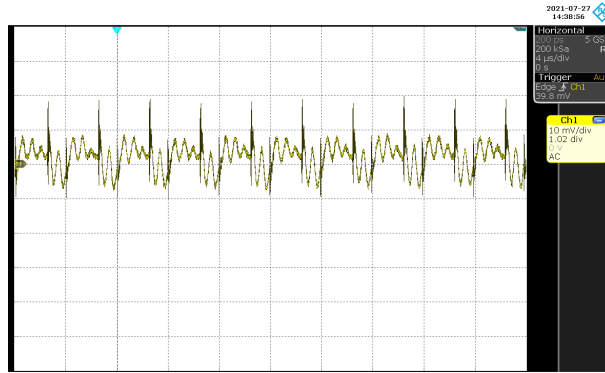

Figure 6-14. Isolated Output V_{O4} Ripple Voltage Under 150-mA Load

6.4 Start-Up Waveforms

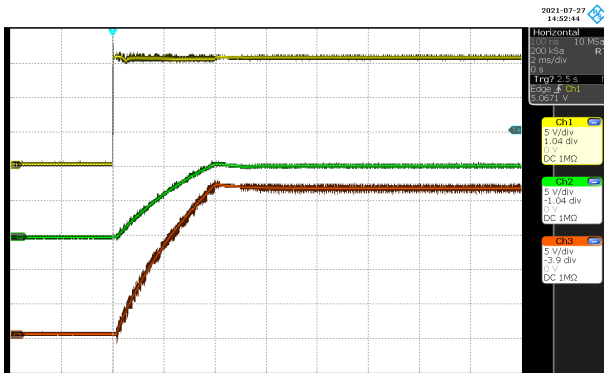

Figure 6-15. Start-Up at 10% Load on Each Output Rail

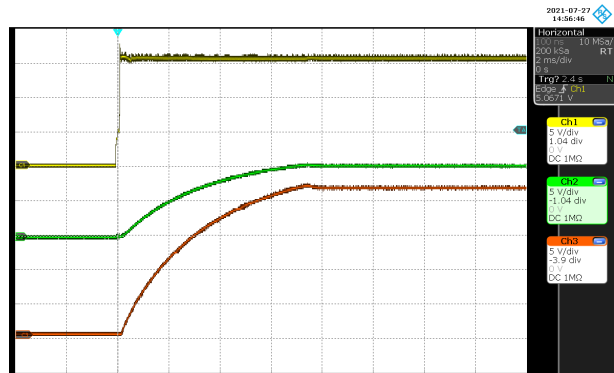

Figure 6-16. Start-Up at 100% Load on Each Output Rail

6.5 Dynamic Responses

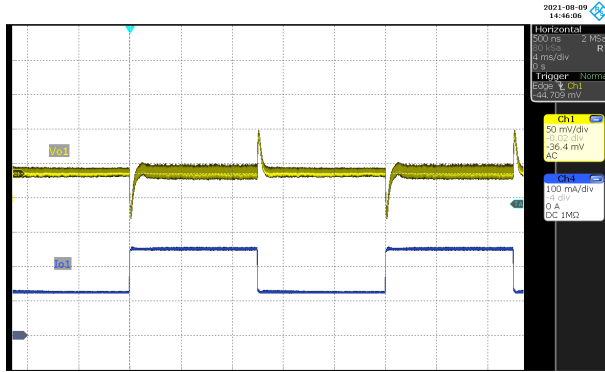

Figure 6-17. V_{O1} Response Under Step Load Between 125 mA and 250 mA, $V_{IN} = 12$ V, $I_{O2-4} = 10\%$

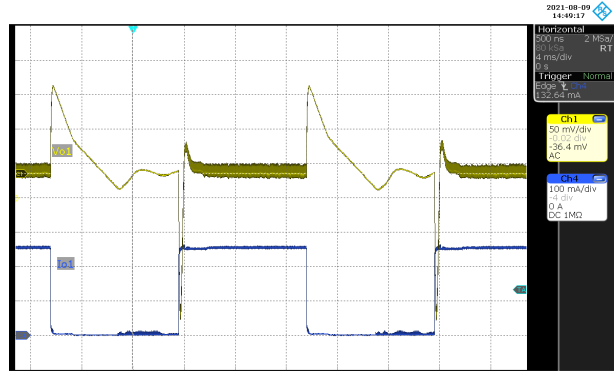

Figure 6-18. V_{O1} Response Under Step Load Between 1 mA to 250 mA, $V_{IN} = 12$ V, $I_{O2-4} = 10\%$

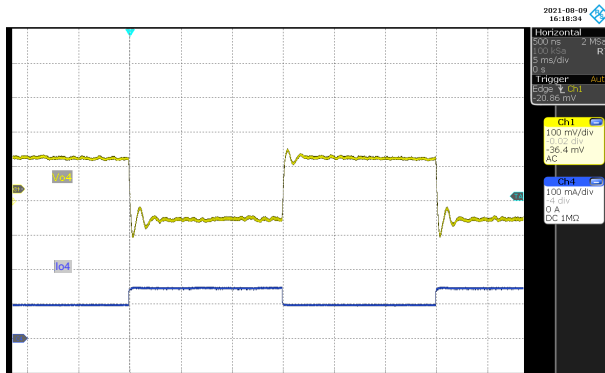

Figure 6-19. V_{O4} Response Under Step Load Between 100 mA and 150 mA, $V_{IN} = 12$ V, $I_{O1-3} = 10\%$

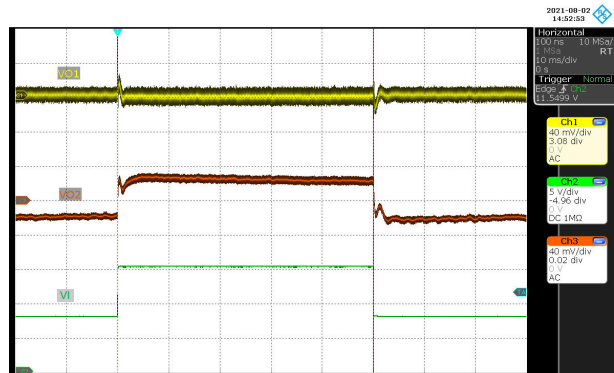

Figure 6-20. V_{O1} Response Under Input Change From 8 V to 16 V, 10% Load

6.6 Short-Circuit Protection

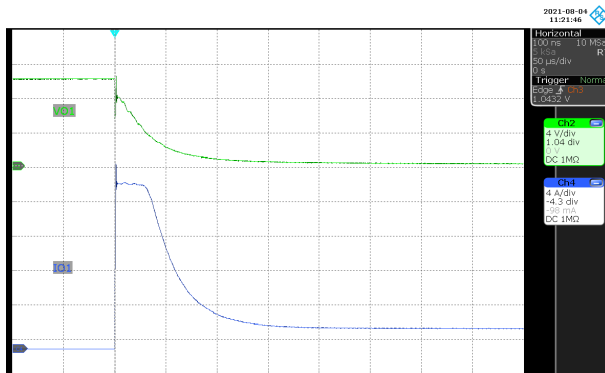

Figure 6-21. Short-Circuit Protection With Hiccup Mode Disabled, $V_{IN} = 12$ V ($R_{13} = 0 \Omega$)

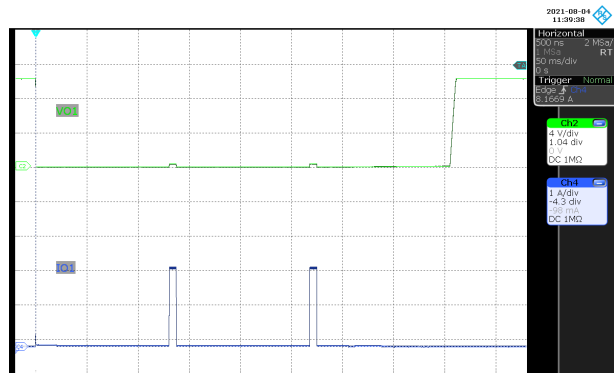

Figure 6-22. Short-Circuit Protection With Hiccup Mode Enabled, $V_{IN} = 12$ V ($R_{13} = 62$ k Ω , $C_{29} = 47$ nF)

6.7 Bode Plots

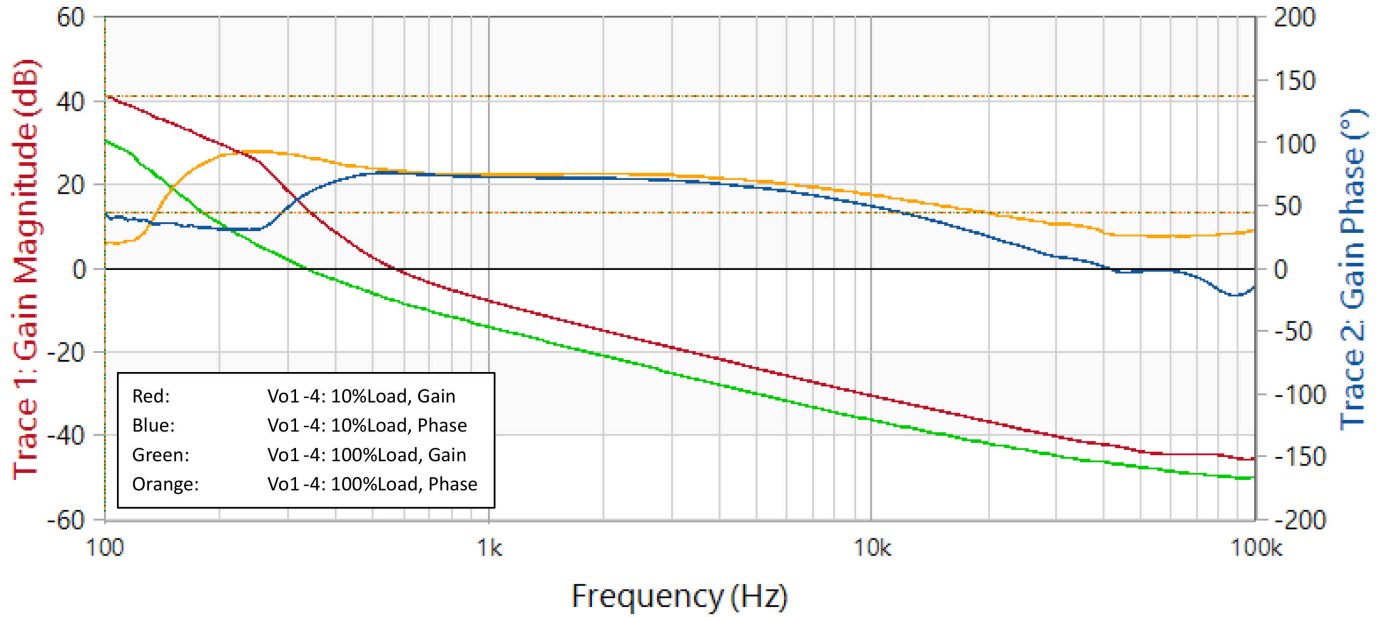

Figure 6-23. Bode Plot ($V_{IN} = 12\text{ V}$)

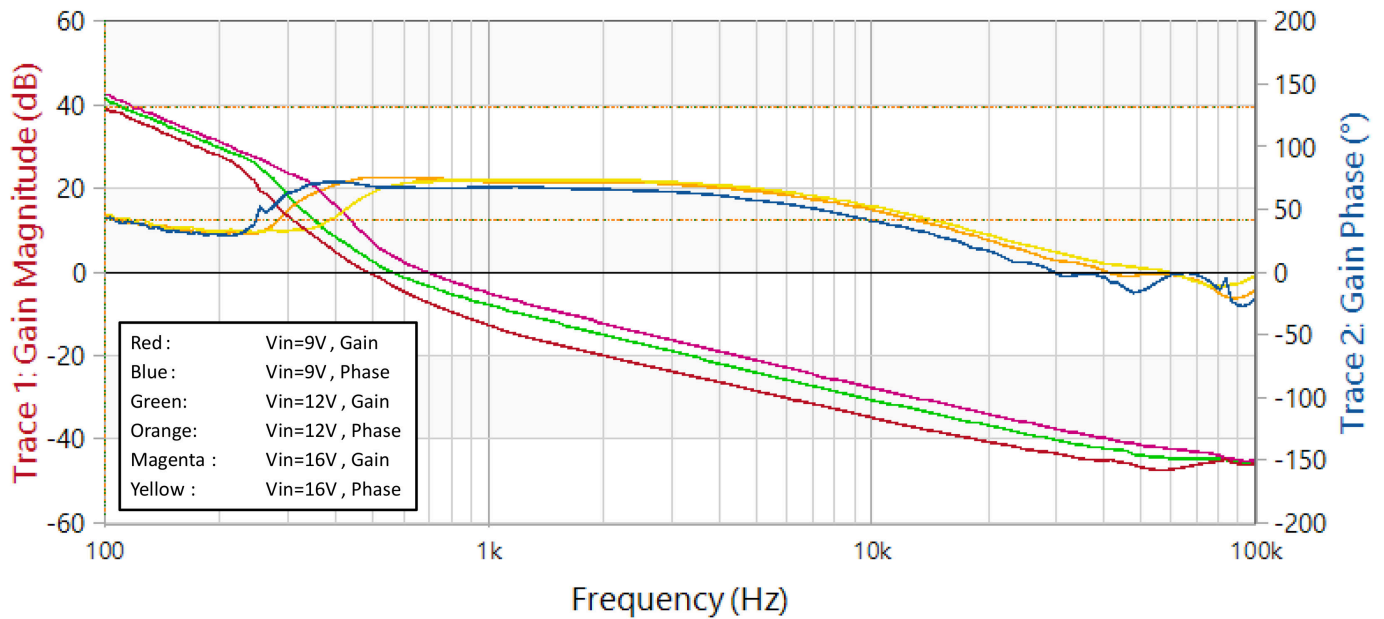

Figure 6-24. Bode Plot (V_{o1-4} : 100% Load)

6.8 Thermal Image

Figure 6-25 shows the thermal image of the EVM at 12 V_{IN} and 100% load.



Figure 6-25. EVM Thermal Image at 12 V_{IN} and 100% Load

7 Schematic

Figure 7-1 shows the EVM schematic.

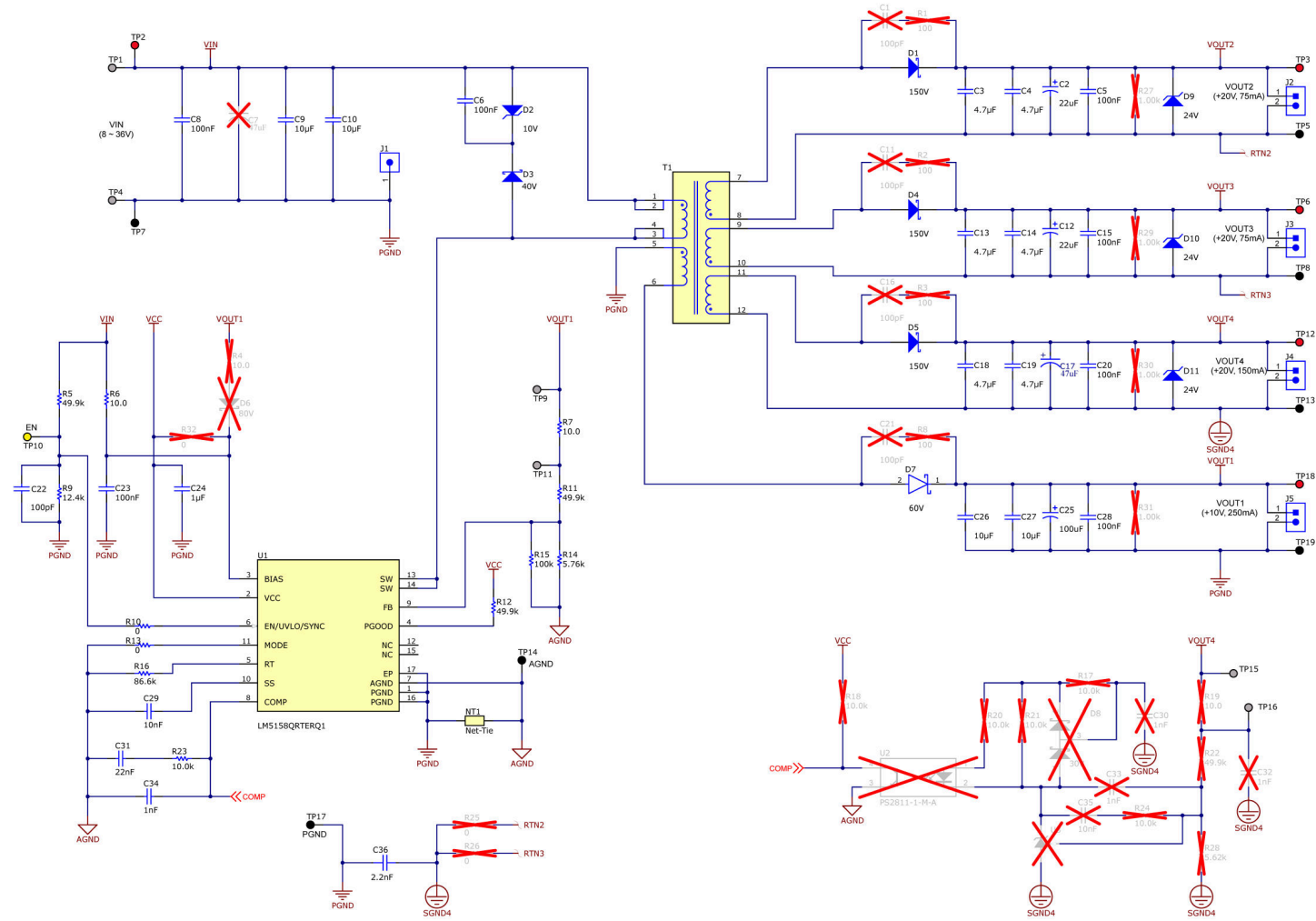

Non-populated components are crossed out.

Figure 7-1. EVM Complete Schematic

8 Bill of Materials

Table 8-1 details the EVM BOM.

Table 8-1. LM5158EVM-FLY Bill of Materials

DESIGNATOR	QUANTITY	VALUE	DESCRIPTION	PACKAGE REFERENCE	PART NUMBER	MANUFACTURER
C2, C12	2	22 μ F	CAP, Polymer Hybrid, 22 μ F, 50 V, \pm 20%, 0.08 Ω , AEC-Q200 Grade 1, D6.3xL5.8mm SMD	D6.3xL5.8mm	EEH-ZC1H220P	Panasonic
C3, C4, C13, C14, C18, C19	6	4.7 μ F	CAP, CERM, 4.7 μ F, 50 V, \pm 10%, X7R, AEC-Q200 Grade 1, 1210	1210	C1210C475K5RACAUTO	Kemet
C5, C6, C8, C15, C20, C23, C28	7	0.1 μ F	CAP, CERM, 0.1 μ F, 50 V, \pm 10%, X7R, AEC-Q200 Grade 1, 0603	603	C0603C104K5RACAUTO	Kemet
C9, C10	2	10 μ F	CAP, CERM, 10 μ F, 50 V, \pm 10%, X7R, AEC-Q200 Grade 1, 1206 (alternate: CAP, CERM, 10 μ F, 50 V, \pm 10%, X5R, AEC-Q200, 1206)	1206	CGA5L1X7R1H106K160AE (alternate: GRT31CR61H106KE01L)	TDK (alternate: muRata)
C17	1	47 μ F	47- μ F 50-V Aluminum - Polymer Capacitors Radial, Can - SMD 30 m Ω 4000 Hrs at 125°C	SMD2	EEH-ZC1H470P	Panasonic
C22	1	100 pF	CAP, CERM, 100 pF, 50 V, \pm 5%, C0G/NP0, AEC-Q200 Grade 0, 0603	603	CGA3E2NP01H101J080AA	TDK
C24	1	1 μ F	CAP, CERM, 1 μ F, 25 V, \pm 10%, X7R, 0603	603	06033C105KAT2A	AVX
C25	1	100 μ F	CAP, Aluminum Polymer, 100 μ F, 16 V, \pm 20%, 0.035 Ω , 10 \times 10.3 SMD	10 \times 10.3	16SVP100M	Panasonic
C26, C27	2	10 μ F	CAP, CERM, 10 μ F, 16 V, \pm 10%, X7R, AEC-Q200 Grade 1, 1206	1206	C1206C106K4RACAUTO	Kemet
C29	1	0.01 μ F	CAP, CERM, 0.01 μ F, 16 V, \pm 10%, X7R, 0603	603	C0603C103K4RACTU	Kemet
C31	1	0.022 μ F	CAP, CERM, 0.022 μ F, 25 V, \pm 10%, X7R, 0603	603	C0603C223K3RACTU	Kemet
C34	1	1000 pF	CAP, CERM, 1000 pF, 50 V, \pm 5%, X7R, 0603	603	C0603C102J5RACTU	Kemet
C36	1	2.2 nF	2200-pF \pm 10% 2000-V (2-kV) Ceramic Capacitor X7R (2R1) 1206 (3216 Metric)	1206	1206Y2K00222KET	Knowles Syfer
D1, D4, D5	3	150 V	Diode, Schottky, 150 V, 1 A, PowerDI123	PowerDI123	DFLS1150-7	Diodes Inc.
D2	1	10 V	Diode, Zener, 10 V, 1.5 W, SMA	SMA	1SMA5925BT3G	ON Semiconductor
D3	1	40 V	Diode, Schottky, 40 V, 1 A, AEC-Q101, SMA	SMA	B140Q-13-F	Diodes Inc.
D7	1		DIODE SCHOTTKY 60-V 1-A POWERDI123	PowerDI123	DFLS160-7	Diodes
D9, D10, D11	3	24 V	Diode, Zener, 24 V, 500 mW, SOD-123	SOD-123	DDZ24C-7	Diodes Inc.
R5, R11, R12	3	49.9 k	RES, 49.9 k, 1%, 0.1 W, 0603	603	RC0603FR-0749K9L	Yageo
R6, R7	2	10	RES, 10.0, 1%, 0.1 W, 0603	603	RC0603FR-0710RL	Yageo
R9	1	12.4 k	RES, 12.4 k, 1%, 0.1 W, 0603	603	RC0603FR-0712K4L	Yageo
R10, R13	2	0	RES, 0, 5%, 0.1 W, AEC-Q200 Grade 0, 0603	603	ERJ-3GEY0R00V	Panasonic
R14	1	5.76 k	RES, 5.76 k, 1%, 0.1 W, 0603	603	RC0603FR-075K76L	Yageo

Table 8-1. LM5158EVM-FLY Bill of Materials (continued)

DESIGNATOR	QUANTIT Y	VALUE	DESCRIPTION	PACKAGE REFERENCE	PART NUMBER	MANUFACTURER
R15	1	100 k	RES, 100 k, 0.1%, 0.1 W, AEC-Q200 Grade 0, 0603	603	ERA-3AEB104V	Panasonic
R16	1	86.6 k	RES, 86.6 k, 1%, 0.1 W, 0603	603	RC0603FR-0786K6L	Yageo
R23	1	10.0 k	RES, 10.0 k, 1%, 0.1 W, 0603	603	RC0603FR-0710KL	Yageo
T1	1		FLYBACK TRANSFORMER	SMT_TRANSFORMER_17MM20_21MM97	ZB1324-AL	Coilcraft
U1	1		2.2-MHz Wide VIN 85-V Boost/Sepic/Flyback Converter with Dual Random Spread Spectrum	WQFN16	LM5158QRTERQ1	Texas Instruments
C1, C11, C16, C21	0	100 pF	CAP, CERM, 100 pF, 100 V, $\pm 1\%$, C0G/NP0, 0603	603	C1608C0G2A101F080AA	TDK
C7	0	47 μ F	47- μ F 50-V Aluminum - Polymer Capacitors Radial, Can - SMD 30 m Ω 4000 Hrs at 125°C	SMD2	EEH-ZC1H470P	Panasonic
C30, C32, C33	0	1000 pF	CAP, CERM, 1000 pF, 50 V, $\pm 5\%$, X7R, 0603	603	C0603C102J5RACTU	Kemet
C35	0	0.01 μ F	CAP, CERM, 0.01 μ F, 16 V, $\pm 10\%$, X7R, 0603	603	C0603C103K4RACTU	Kemet
D6	0	80 V	Diode, Schottky, 80 V, 0.5 A, SOD-123	SOD-123	MBR0580-TP	Micro Commercial Components
D8	0	30 V	Diode, Schottky, 30 V, 0.2 A, SOT-323	SOT-323	BAT54SWT1G	Fairchild Semiconductor
R1, R2, R3, R8	0	100	RES, 100, 1%, 0.1 W, 0603	603	RC0603FR-07100RL	Yageo
R4, R19	0	10	RES, 10.0, 1%, 0.1 W, 0603	603	RC0603FR-0710RL	Yageo
R17, R18, R20, R21, R24	0	10.0 k	RES, 10.0 k, 1%, 0.1 W, 0603	603	RC0603FR-0710KL	Yageo
R22	0	49.9 k	RES, 49.9 k, 1%, 0.1 W, 0603	603	RC0603FR-0749K9L	Yageo
R25, R26	0	0	RES, 0, 5%, 0.25 W, AEC-Q200 Grade 0, 1206	1206	ERJ-8GEY0R00V	Panasonic
R27, R29, R30, R31	0	1.00 k	RES, 1.00 k, 1%, 0.25 W, AEC-Q200 Grade 0, 1206	1206	ERJ-8ENF1001V	Panasonic
R28	0	5.62 k	RES, 5.62 k, 1%, 0.1 W, 0603	603	RC0603FR-075K62L	Yageo
R32	0	0	RES, 0, 5%, 0.1 W, AEC-Q200 Grade 0, 0603	603	ERJ-3GEY0R00V	Panasonic
U2	0		Optocoupler, 2.5 kV, 100-200% CTR, SMT	PS2811-1	PS2811-1-M-A	California Eastern Laboratories
U3	0		Low-Voltage (1.24V) Adjustable Precision Shunt Regulators, 3-pin SOT-23, Pb-Free	DBZ0003A		Texas Instruments

9 EVM Layout

Figure 9-1 through Figure 9-4 illustrate the EVM

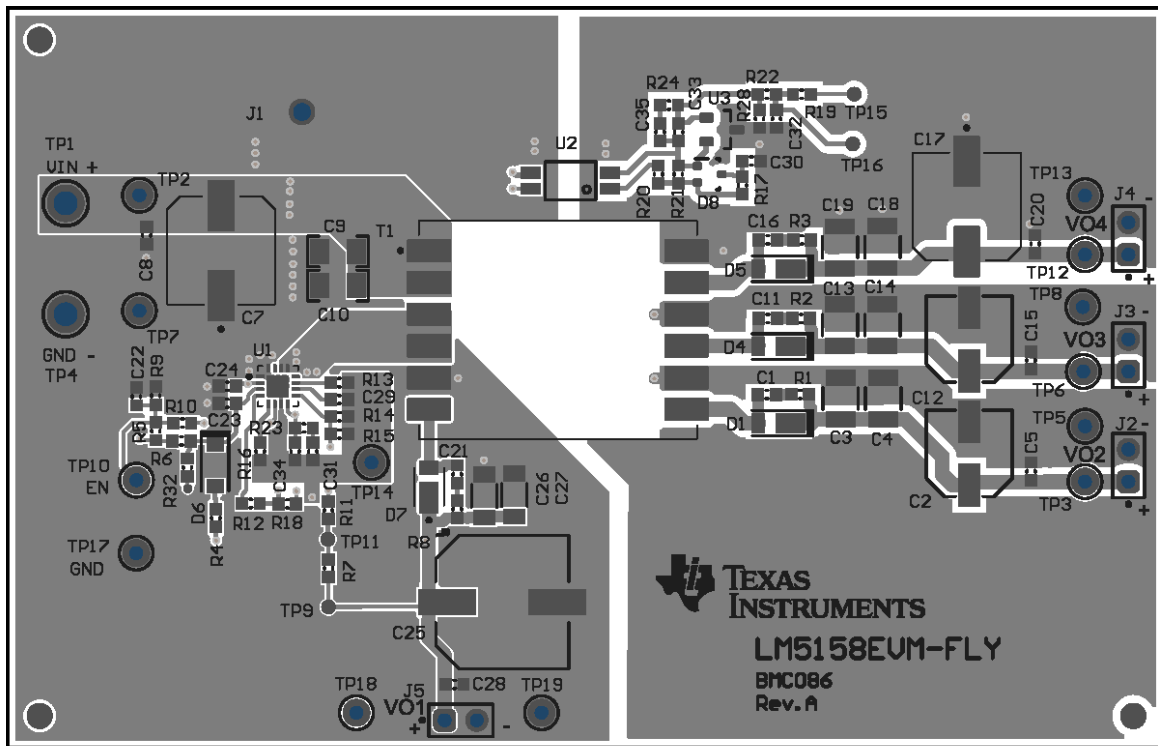

Figure 9-1. Top Layer with Silkscreen

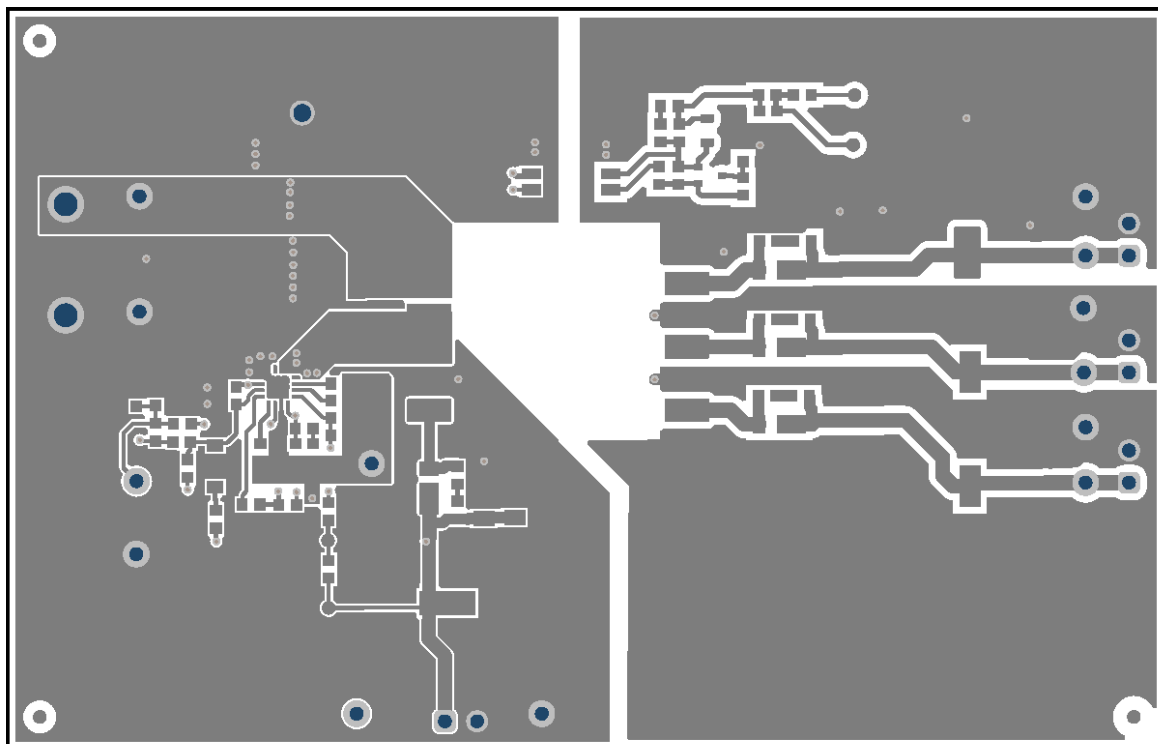

Figure 9-2. Top Layer

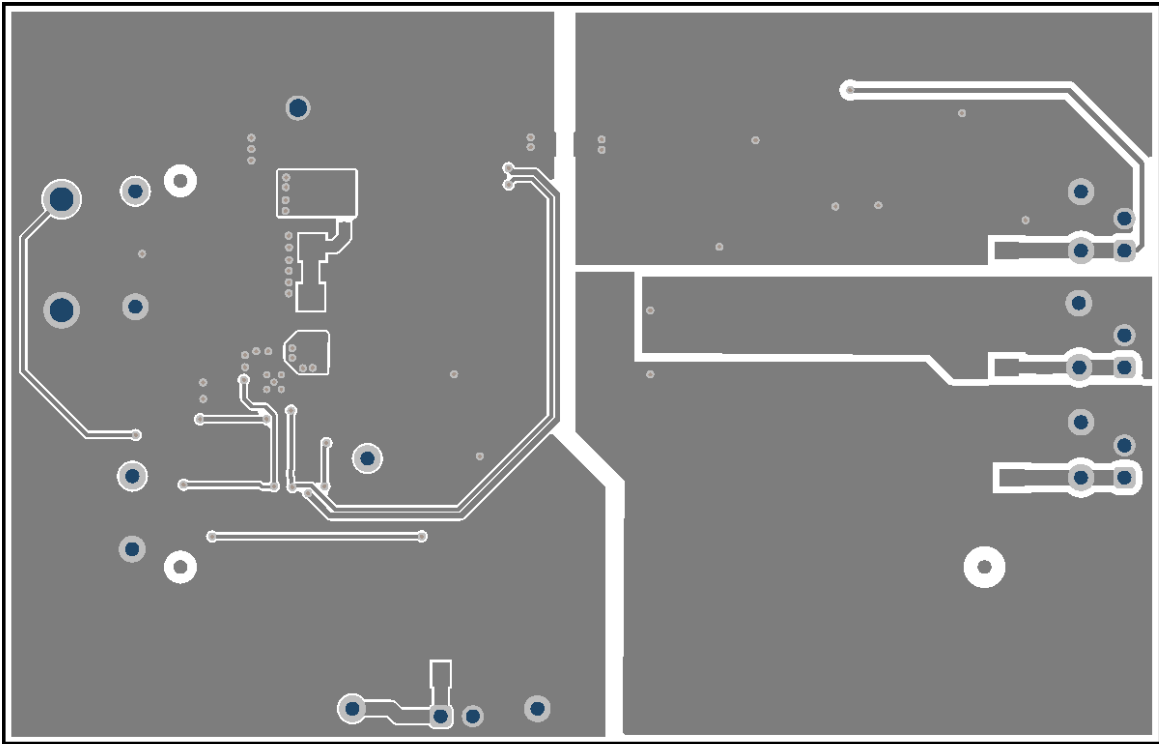

Figure 9-3. Bottom Layer Viewed From Top

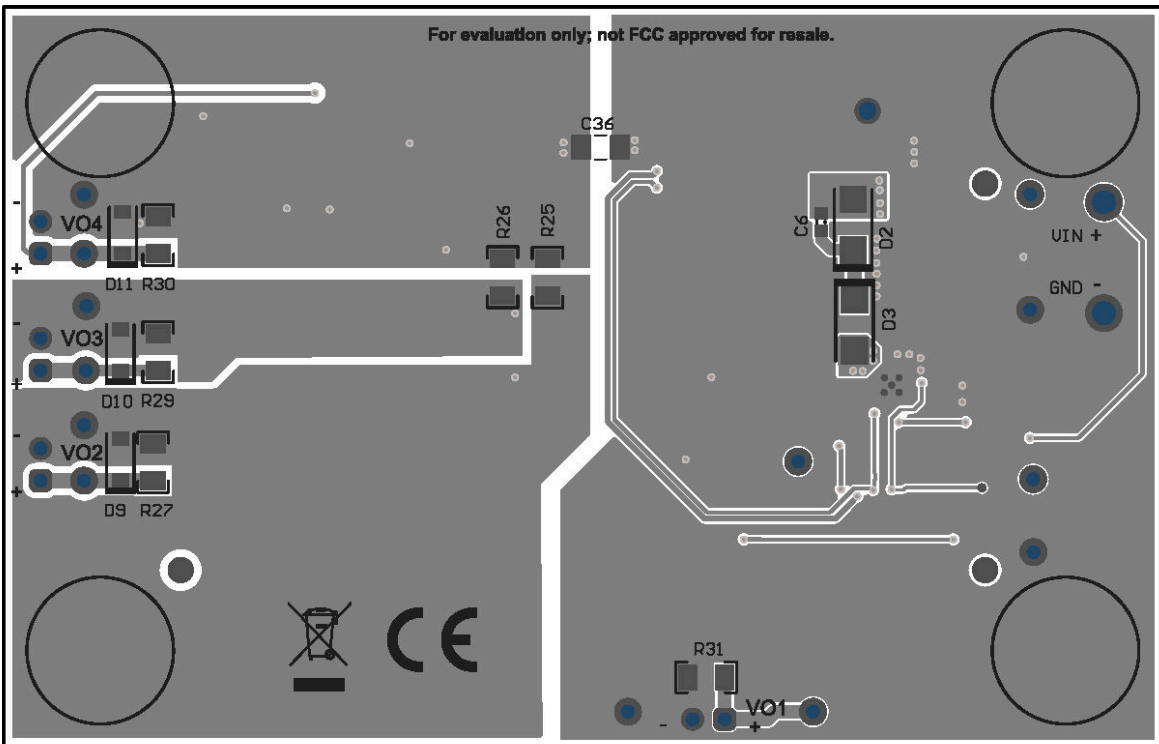

Figure 9-4. Bottom Layer with Silkscreen Viewed From Bottom

IMPORTANT NOTICE AND DISCLAIMER

TI PROVIDES TECHNICAL AND RELIABILITY DATA (INCLUDING DATA SHEETS), DESIGN RESOURCES (INCLUDING REFERENCE DESIGNS), APPLICATION OR OTHER DESIGN ADVICE, WEB TOOLS, SAFETY INFORMATION, AND OTHER RESOURCES "AS IS" AND WITH ALL FAULTS, AND DISCLAIMS ALL WARRANTIES, EXPRESS AND IMPLIED, INCLUDING WITHOUT LIMITATION ANY IMPLIED WARRANTIES OF MERCHANTABILITY, FITNESS FOR A PARTICULAR PURPOSE OR NON-INFRINGEMENT OF THIRD PARTY INTELLECTUAL PROPERTY RIGHTS.

These resources are intended for skilled developers designing with TI products. You are solely responsible for (1) selecting the appropriate TI products for your application, (2) designing, validating and testing your application, and (3) ensuring your application meets applicable standards, and any other safety, security, regulatory or other requirements.

These resources are subject to change without notice. TI grants you permission to use these resources only for development of an application that uses the TI products described in the resource. Other reproduction and display of these resources is prohibited. No license is granted to any other TI intellectual property right or to any third party intellectual property right. TI disclaims responsibility for, and you will fully indemnify TI and its representatives against, any claims, damages, costs, losses, and liabilities arising out of your use of these resources.

TI's products are provided subject to [TI's Terms of Sale](#) or other applicable terms available either on ti.com or provided in conjunction with such TI products. TI's provision of these resources does not expand or otherwise alter TI's applicable warranties or warranty disclaimers for TI products.

TI objects to and rejects any additional or different terms you may have proposed.

Mailing Address: Texas Instruments, Post Office Box 655303, Dallas, Texas 75265
Copyright © 2022, Texas Instruments Incorporated