

## TEST REPORT

**Product** : BeaglePlay  
**Trade mark** : Beagleboard.org  
**Model/Type reference** : BeaglePlay  
**Serial Number** : N/A  
**Report Number** : EED32P80002204  
**Date of Issue** : Feb. 22, 2023  
**Test Standards** : ETSI EN 301 893 V2.1.1(2017-05)  
**Test result** : PASS

Prepared for:

**Seeed Technology Co., Ltd**  
**9F, Building G3, TCL International E city, Zhongshanyuan Road,**  
**Nanshan, Shenzhen, China.**

Prepared by:

**Centre Testing International Group Co., Ltd.**  
**Hongwei Industrial Zone, Bao'an 70 District,**  
**Shenzhen, Guangdong, China**  
**TEL: +86-755-3368 3668**  
**FAX: +86-755-3368 3385**

Compiled by:

*mark.chen*

Mark Chen

Approved by:

*Aaron Ma*

Aaron Ma

Reviewed by:

*Tom Chen*

Tom Chen

Date:

Feb. 22, 2023

Check No.: 5404030123



## 2 Version

Version No.	Date	Description
00	Feb. 22, 2023	Original

### 3 Test Summary

Test Item	Test Requirement	Test Method	Limit	Result
Carrier frequencies	EN 301 893 V2.1.1 Clause 4.2.1	EN 301 893 V2.1.1 Clause 5.4.2	Clause 4.2.1.3	PASS*
Nominal Channel Bandwidth and Occupied Channel Bandwidth	EN 301 893 V2.1.1 Clause 4.2.2	EN 301 893 V2.1.1 Clause 5.4.3	Clause 4.2.2.2	PASS*
RF output power	EN 301 893 V2.1.1 Clause 4.2.3	EN 301 893 V2.1.1 Clause 5.4.4	Clause 4.2.3.2	PASS*
Transmit Power Control (TPC)	EN 301 893 V2.1.1 Clause 4.2.3	EN 301 893 V2.1.1 Clause 5.4.4	Clause 4.2.3.2	N/A <sup>1</sup>
Power density	EN 301 893 V2.1.1 Clause 4.2.3	EN 301 893 V2.1.1 Clause 5.4.4	Clause 4.2.3.2	PASS*
Transmitter unwanted emissions outside the 5 GHz RLAN bands	EN 301 893 V2.1.1 Clause 4.2.4.1	EN 301 893 V2.1.1 Clause 5.4.5	Clause 4.2.4.1.2	PASS
Transmitter unwanted emissions within the 5 GHz RLAN bands	EN 301 893 V2.1.1 Clause 4.2.4.2	EN 301 893 V2.1.1 Clause 5.4.6	Clause 4.2.4.2.2	PASS*
Receiver spurious emissions	EN 301 893 V2.1.1 Clause 4.2.5	EN 301 893 V2.1.1 Clause 5.4.7	Clause 4.2.5.2	PASS
Dynamic Frequency Selection (DFS)	EN 301 893 V2.1.1 Clause 4.2.6	EN 301 893 V2.1.1 Clause 5.4.8	Clause 4.2.6.2	N/A
Adaptivity (channel access mechanism)	EN 301 893 V2.1.1 Clause 4.2.7	EN 301 893 V2.1.1 Clause 5.4.9	Clause 4.2.7.2	PASS*
Receiver Blocking	EN 301 893 V2.1.1 Clause 4.2.8	EN 301 893 V2.1.1 Clause 5.4.10	Clause 4.2.8.4	PASS*
User Access Restrictions	EN 301 893 V2.1.1 Clause 4.2.9	EN 301 893 V2.1.1 Clause 4.2.9.2	Clause 4.2.9.2	PASS <sup>1</sup>
Geo-location capability	EN 301 893 V2.1.1 Clause 4.2.10	EN 301 893 V2.1.1 Clause 4.2.10.3	Clause 4.2.10.3	N/A <sup>2</sup>

Remark:

PASS<sup>1</sup> Because this test product has user access restrictions.

N/A<sup>1</sup> Because these requirements apply to equipment with Transmit Power Control.

N/A<sup>2</sup> Because these requirements apply to equipment with geo-location capability.

Company Name and Address shown on Report, the sample(s) and sample Information was/ were provided by the applicant who should be responsible for the authenticity which CTI hasn't verified.

Tx: In this whole report Tx (or tx) means Transmitter.

Rx: In this whole report Rx (or rx) means Receiver.

RF: In this whole report RF means Radiated Frequency.

CH: In this whole report CH means channel.

Volt: In this whole report Volt means Voltage.

Temp: In this whole report Temp means Temperature.

Humid: In this whole report Humid means humidity.

Press: In this whole report Press means Pressure.

N/A: In this whole report not application

Remark\*: All test data come from the report of No.ER741330-02, use the same RF module.

## 4 Content

	Page
<b>1 COVER PAGE</b> .....	<b>1</b>
<b>2 VERSION</b> .....	<b>2</b>
<b>3 TEST SUMMARY</b> .....	<b>3</b>
<b>4 CONTENT</b> .....	<b>4</b>
<b>5 TEST REQUIREMENT</b> .....	<b>5</b>
5.1 TEST SETUP .....	5
5.1.1 For Conducted test setup .....	5
5.1.2 For Radiated Emissions test setup .....	5
5.2 TEST ENVIRONMENT .....	6
5.3 TEST CONDITION .....	7
<b>6 GENERAL INFORMATION</b> .....	<b>9</b>
6.1 CLIENT INFORMATION .....	9
6.2 GENERAL DESCRIPTION OF EUT .....	9
6.3 OTHER INFORMATION .....	10
6.4 DESCRIPTION OF SUPPORT UNITS .....	11
6.5 TEST LOCATION .....	11
6.6 DEVIATION FROM STANDARDS .....	11
6.7 ABNORMALITIES FROM STANDARD CONDITIONS .....	11
6.8 OTHER INFORMATION REQUESTED BY THE CUSTOMER .....	11
6.9 MEASUREMENT UNCERTAINTY (95% CONFIDENCE LEVELS, K=2) .....	12
<b>7 EQUIPMENT LIST</b> .....	<b>13</b>
<b>8 RADIO TECHNICAL REQUIREMENTS SPECIFICATION</b> .....	<b>14</b>
Appendix A: Spurious emissions .....	15
<b>PHOTOGRAPHS OF TEST SETUP</b> .....	<b>18</b>
<b>PHOTOGRAPHS OF EUT CONSTRUCTIONAL DETAILS</b> .....	<b>20</b>



## 5 Test Requirement

### 5.1 Test setup

#### 5.1.1 For Conducted test setup

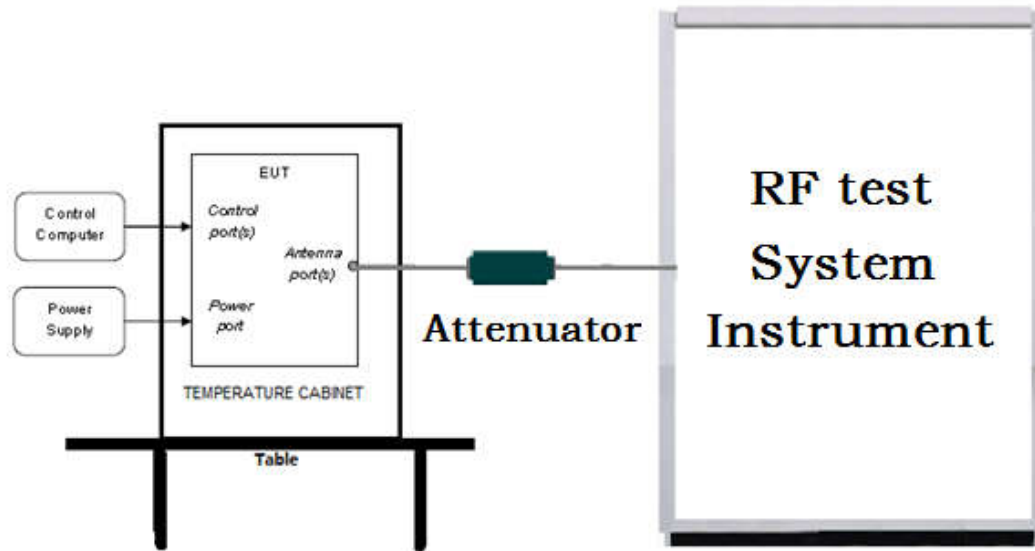

#### 5.1.2 For Radiated Emissions test setup

Radiated Emissions setup:

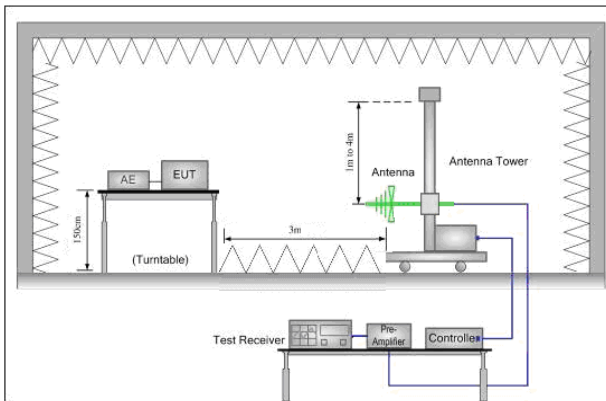

Figure 1. 30MHz to 1GHz

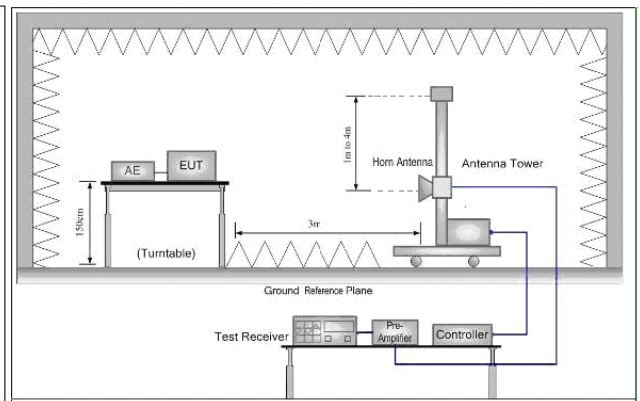

Figure 2. Above 1GHz

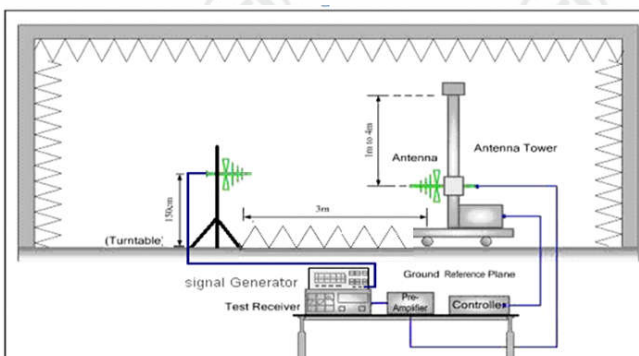

Figure 1. 30MHz to 1GHz

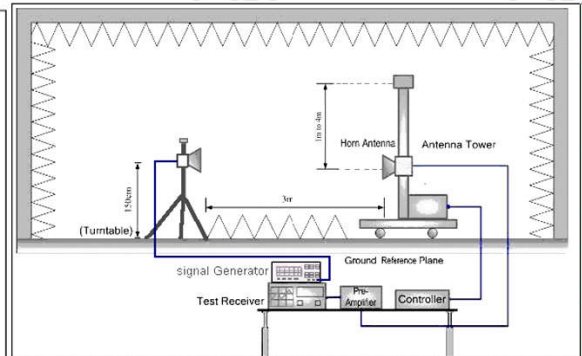

Figure 2. Above 1GHz

## 5.2 Test Environment

Environment Parameter	Selected Values During Tests		
	Ambient		
Test condition	Temperature(°C)	Voltage(V)	Humidity%
NT/NV	23	DC 5V	54
LT/NV	0	DC 5V	54
HT/NV	60	DC 5V	54

Note:

- 1) The EUT just work in such extreme temperature of 0°C~+60°C, so here the EUT is tested in the temperature of 0°C~+60°C.
- 2) NV: Normal Voltage NT: Normal Temperature  
LT: Low Extreme Test Temperature, HT: High Extreme Test Temperature.

### 5.1.2 Normal test conditions

#### 5.1.2.1 Normal temperature and humidity

Unless otherwise declared by the manufacturer, the normal temperature and humidity conditions for tests shall be any convenient combination of temperature and humidity within the following ranges:

- temperature: +15 °C to +35 °C;
- relative humidity: 20 % to 75 %.

The actual values during the tests shall be recorded.

#### 5.1.2.2 Normal power source

The normal test voltage for the equipment shall be the nominal voltage for which the equipment was designed.

#### 5.1.3 Extreme test conditions

Some tests in the present document need to be repeated at extreme temperatures. Where that is the case, measurements shall be made over the extremes of the operating temperature range as declared by the manufacturer.

## 5.3 Test Condition

Test	Clause	Test channels		
		Lower sub-band (5 150 MHz to 5 350 MHz)		Higher sub-band 5 470 MHz to 5 725 MHz
		5 150 MHz to 5 250 MHz	5 250 MHz to 5 350 MHz	
Centre frequencies	5.4.2	C7 (see note 1)		C8 (see note 1)
Occupied Channel Bandwidth	5.4.3	C7		C8
Power, Power Density	5.4.4	C1	C2	C3, C4
Transmitter unwanted emissions outside the 5 GHz RLAN bands	5.4.5	C7 (see note 1)		C8 (see note 1)
Transmitter unwanted emissions within the 5 GHz RLAN bands	5.4.6	C1	C2	C3, C4
Receiver spurious emissions	5.4.7	C7 (see note 1)		C8 (see note 1)

Test	Clause	Test channels		
		Lower sub-band (5 150 MHz to 5 350 MHz)		Higher sub-band 5 470 MHz to 5 725 MHz
		5 150 MHz to 5 250 MHz	5 250 MHz to 5 350 MHz	
Transmit Power Control (TPC)	5.4.4	n.a. (see note 2)	C2 (see note 1)	C3, C4 (see note 1)
Dynamic Frequency Selection (DFS)	5.4.8	n.a. (see note 2)	C5	C6 (see note 3)
Adaptivity	5.4.9	C9		
Receiver Blocking	5.4.10	C7		C8
C1, C3:	The lowest declared channel for every declared <i>Nominal Channel Bandwidth</i> within this band. For the Power Density testing, it is sufficient to only perform this test using the lowest <i>Nominal Channel Bandwidth</i> .			
C2, C4:	The highest declared channel for every declared <i>Nominal Channel Bandwidth</i> within this band. For the Power Density testing, it is sufficient to only perform this test using the lowest <i>Nominal Channel Bandwidth</i> .			
C5, C6:	One channel out of the declared channels for this frequency range. If more than one <i>Nominal Channel Bandwidth</i> has been declared for this sub-band, testing shall be performed using the lowest and highest <i>Nominal Channel Bandwidth</i> .			
C7, C8:	One channel out of the declared channels for this sub-band. For <i>Occupied Channel Bandwidth</i> , testing shall be repeated for every declared <i>Nominal Channel Bandwidth</i> within this sub-band.			
C9:	One channel (in case of single-channel testing) or a group of channels (in case of multi-channel testing) out of the declared channels.			
NOTE 1:	In case of more than one channel plan has been declared, testing of these specific requirements need only be performed using one of the declared channel plans.			
NOTE 2:	Testing is not required for <i>Nominal Channel Bandwidths</i> that fall completely within the frequency range 5 150 MHz to 5 250 MHz.			
NOTE 3:	Where the declared channel plan includes channels whose <i>Nominal Channel Bandwidth</i> falls completely or partly within the 5 600 MHz to 5 650 MHz band, the tests for the <i>Channel Availability Check</i> (and where implemented, for the <i>Off-Channel CAC</i> ) shall be performed on one of these channels in addition to a channel within the band 5 470 MHz to 5 600 MHz or within the band 5 650 MHz to 5 725 MHz.			

The worse case configurations, The worst case data was recorded in the report.  
SISO

Operating Frequency	802.11 Mode	Data rate (in Mb/s)
5180-5240MHz	a	6
	n(HT20)	MCS0
	n(HT40)	MCS0

## 6 General Information

### 6.1 Client Information

Applicant:	Seeed Technology Co., Ltd
Address of Applicant:	9F, Building G3, TCL International E city, Zhongshanyuan Road, Nanshan, Shenzhen, China.
Manufacturer:	Seeed Technology Co., Ltd
Address of Manufacturer:	9F, Building G3, TCL International E city, Zhongshanyuan Road, Nanshan, Shenzhen, China.
Factory:	Shenzhen Xinxian Technology Co., Limited
Address of Factory:	F5, Building B17, Hengfeng Industrial City, No. 739 Zhoushi Rd, Baoan District, Shenzhen, Guangdong, P.R.C.

### 6.2 General Description of EUT

Product Name:	BeaglePlay
Model No.(EUT):	BeaglePlay
Trade mark:	Beagleboard.org
Type of Modulation:	IEEE 802.11a: OFDM (BPSK, QPSK, 16QAM, 64QAM) IEEE 802.11n(HT20/HT40): OFDM (BPSK, QPSK, 16QAM, 64QAM)
Frequency band(s) of operation	U-NII-1: 5150-5250MHz
Operating Frequency	U-NII-1: 5150-5250MHz
Sample Type:	Fixed-Use
Test Power Grade:	Default
Test Software of EUT:	SecureCRT
Antenna Type:	PCB Antenna
Antenna Gain:	ANT1: 3.40dBi; ANT2: 3.40dBi
Function	<input checked="" type="checkbox"/> SISO <input type="checkbox"/> 2x2 MIMO <input type="checkbox"/> 3x3 MIMO <input type="checkbox"/> 4x4MIMO <input type="checkbox"/> Beamforming <input type="checkbox"/> TPC
Power Supply:	DC 5V
Test voltage:	DC 5V



### 6.3 Other Information

RED Directive:	2014/53/EU
Sample Received Date:	Jan. 03, 2023
Sample tested Date:	Jan. 03, 2023 to Feb. 16, 2023

Operation Frequency each of channel

802.11a/802.11n(20MHz) Frequency/Channel Operations:

U-NII-1	
Channel	Frequency(MHz)
36	5180
40	5200
44	5220
48	5240

802.11n(40MHz) Frequency/Channel Operations:

U-NII-1	
Channel	Frequency(MHz)
38	5190
46	5230

## 6.4 Description of Support Units

The EUT has been tested with associated equipment below.

1) support equipment

Description	Manufacturer	Model No.	Certification	Supplied by
Netbook	DELL	Latitude 3490	FCC&CE	CTI

## 6.5 Test Location

All tests were performed at:

Centre Testing International Group Co., Ltd.

Hongwei Industrial Zone, Bao'an 70 District, Shenzhen, Guangdong, China518101

Telephone: +86 (0) 755 33683668 Fax:+86 (0) 755 33683385

No tests were sub-contracted.

## 6.6 Deviation from Standards

None.

## 6.7 Abnormalities from Standard Conditions

None.

## 6.8 Other Information Requested by the Customer

None.

## 6.9 Measurement Uncertainty (95% confidence levels, k=2)

No.	Item	Measurement Uncertainty
1	Radio frequency	$7.8 \times 10^{-8}$
2	RF Power conducted	0.46dB(30MHz-1GHz)
		0.55dB(1GHz-18GHz)
3	Unwanted Emission, conducted	0.46dB(30MHz-1GHz)
		0.55dB(1GHz-18GHz)
4	Spurious Emission, radiated	4.3dB (30MHz-1GHz)
		4.5dB (1GHz-18GHz)
		3.4dB (18GHz-26GHz)
5	Temperature test	0.64°C
6	Humidity test	3.8%
7	DC and low frequency voltages test	0.026%

## 7 Equipment List

3M full-anechoic Chamber					
Equipment	Manufacturer	Model No.	Serial Number	Cal. Date (mm-dd-yyyy)	Cal. Due date (mm-dd-yyyy)
RSE Automatic test software	JS Tonscend	JS36-RSE	10166	---	---
Receiver	Keysight	N9038A	MY57290136	03-01-2022	02-28-2023
Spectrum Analyzer	Keysight	N9020B	MY57111112	03-01-2022	02-28-2023
Spectrum Analyzer	Keysight	N9030B	MY57140871	03-01-2022	02-28-2023
TRILOG Broadband Antenna	Schwarzbeck	VULB 9163	9163-1148	04-28-2021	04-27-2024
Horn Antenna	Schwarzbeck	BBHA 9170	9170-832	04-15-2021	04-14-2024
Horn Antenna	ETS-LINDGREN	3117	57407	07-04-2021	07-03-2024
Preamplifier	EMCI	EMC184055SE	980597	04-20-2022	04-19-2023
Preamplifier	EMCI	EMC001330	980563	04-13-2022	04-12-2023
Preamplifier	JS Tonscend	TAP-011858	AP21B806112	07-29-2022	07-28-2023
Communication test set	R&S	CMW500	102898	12-23-2022	12-22-2023
Temperature/Humidity Indicator	biaozhi	GM1360	EE1186631	02-21-2022	02-20-2023
Fully Anechoic Chamber	TDK	FAC-3	---	01-09-2021	01-08-2024
Cable line	Times	SFT205-NMSM-2.50M	394812-0001	---	---
Cable line	Times	SFT205-NMSM-2.50M	394812-0002	---	---
Cable line	Times	SFT205-NMSM-2.50M	394812-0003	---	---
Cable line	Times	SFT205-NMSM-2.50M	393495-0001	---	---
Cable line	Times	EMC104-NMNM-1000	SN160710	---	---
Cable line	Times	SFT205-NMSM-3.00M	394813-0001	---	---
Cable line	Times	SFT205-NMNM-1.50M	381964-0001	---	---
Cable line	Times	SFT205-NMSM-7.00M	394815-0001	---	---
Cable line	Times	HF160-KMKM-3.00M	393493-0001	---	---

## 8 Radio Technical Requirements Specification

### Reference documents for testing:

No.	Identity	Document Title
1	EN 301 893 V2.1.1 (2017-05)	5 GHz RLAN; Harmonised Standard covering the essential requirements of article 3.2 of Directive 2014/53/EU

### Test Results List:

EN 301 893 V2.1.1		Test Descriptions & Test Conditions	Verdict	Note
Test Requirement	Test Method			
Clause 4.2.1	Clause 5.4.2	Center frequencies		Note 1
		NT/NV	PASS	
		LT/NV	PASS	
Clause 4.2.1	Clause 5.4.2	HT/NV	PASS	
		Nominal Channel Bandwidth and Occupied Channel Bandwidth.		Note 1
		NT/NV	PASS	
Clause 4.2.3	Clause 5.4.4	RF output power		Note 1
		NT/NV	PASS	
		LT/NV	PASS	
Clause 4.2.3	Clause 5.4.4	HT/NV	PASS	
		Transmit Power Control (TPC)		N/A
		NT/NV	N/A	
LT/NV	N/A			
Clause 4.2.3	Clause 5.4.4	HT/NV	N/A	
		Power density		Note 1
		NT/NV	PASS	
Clause 4.2.6	Clause 5.4.8	Dynamic Frequency Selection (DFS)		N/A
		NT/NV	N/A	
Clause 4.2.7	Clause 5.4.9	Adaptivity (channel access mechanism)		Note 1
		NT/NV	PASS	
Clause 4.2.7	Clause 5.4.10	Receiver Blocking		Note 1
		NT/NV	PASS	
Clause 4.2.4.2	Clause 5.4.6	Transmitter unwanted emissions within the 5 GHz RLAN bands		Note 1
		NT/NV	PASS	
Clause 4.2.4.1	Clause 5.4.5	Transmitter unwanted emissions outside the 5 GHz RLAN bands		Appendix A
		NT/NV	PASS	
Clause 4.2.8	Clause 5.4.7	Receiver spurious emissions		Appendix A
		NT/NV	PASS	
Clause 4.2.10	Clause 4.2.10.3	Geo-location capability		N/A
		NT/NV	N/A	

Note 1: The test data please refer to report of No.ER741330-02.



## Appendix A: Spurious emissions

<b>Test Procedure:</b>				
<p>1. Scan from 30MHz to 26GHz; find the maximum radiation frequency to measure.</p> <p>2. The technique used to find the Spurious Emissions of the transmitter was the antenna substitution method. Substitution method was performed to determine the actual ERP/EIRP emission levels of the EUT.</p> <p>Test procedure as below:</p> <p>1) The EUT was powered ON and placed on a 1.5m high table at a 3 meter fully Anechoic Chamber. The antenna of the transmitter was extended to its maximum length. Modulation mode and the measuring receiver shall be tuned to the frequency of the transmitter under test.</p> <p>2) The EUT was set 3 meters (above 18GHz the distance is 1 meter) away from the interference-receiving antenna, which was mounted on the top of a variable-height antenna tower.</p> <p>3) The disturbance of the transmitter was maximized on the test receiver display by raising and lowering from 1m to 4m the receive antenna and by rotating through 360° the turntable. After the fundamental emission was maximized, a field strength measurement was made.</p> <p>4) Steps 1) to 3) were performed with the EUT and the receive antenna in both vertical and horizontal polarization.</p> <p>5) The transmitter was then removed and replaced with another antenna. The center of the antenna was approximately at the same location as the center of the transmitter.</p> <p>6) A signal at the disturbance was fed to the substitution antenna by means of a non-radiating cable. With both the substitution and the receive antennas horizontally polarized, the receive antenna was raised and lowered to obtain a maximum reading at the test receiver. The level of the signal generator was adjusted until the measured field strength level in step 3) is obtained for this set of conditions.</p> <p>7) The output power into the substitution antenna was then measured.</p> <p>8) Steps 6) and 7) were repeated with both antennas polarized.</p> <p>9) Calculate power in dBm by the following formula:  <math>ERP(dBm) = Pg(dBm) - \text{cable loss (dB)} + \text{antenna gain (dBd)}</math>  <math>EIRP(dBm) = Pg(dBm) - \text{cable loss (dB)} + \text{antenna gain (dBi)}</math>  <math>EIRP=ERP+2.15dB</math>                      where:                      Pg is the generator output power into the substitution antenna.</p> <p>10) Test the EUT in the lowest channel , the Highest channel                      Repeat above procedures until all frequencies measured was complete.</p>				
<b>Limit:</b>		<b>Frequency range</b>	<b>Maximum power,</b>	<b>Bandwidth</b>
		30 MHz to 47 MHz	-36dBm	100 kHz
		47 MHz to 74 MHz	-54 dBm	100 kHz
		74 MHz to 87,5 MHz	-36dBm	100 kHz
		87,5 MHz to 118 MHz	-54 dBm	100 kHz
		118 MHz to 174 MHz	-36dBm	100 kHz
		174 MHz to 230 MHz	-54 dBm	100 kHz
		230 MHz to 470 MHz	-36dBm	100 kHz
		470 MHz to 862 MHz	-54 dBm	100 kHz
		862 MHz to 1 GHz	-36dBm	100 kHz
		1 GHz to 5.15 GHz	-30dBm	1MHz
		5.35GHz to 5.47GHz	-30dBm	1MHz
		5.725GHz to 26GHz	-30dBm	1MHz
<b>Transmitter limits for spurious emissions</b>				
	<b>Frequency range</b>	<b>Maximum power</b>	<b>bandwidth</b>	
	30MHz to 1GHz	-57dBm	100kHz	
	1GHz to 26GHz	-47dBm	1MHz	
<b>Spurious emission limits for receivers</b>				

## Radiated Spurious Emissions test Data:

### 1) Transmitter unwanted emissions outside the 5 GHz RLAN bands

Remark: Through Pre-scan, for 20MHz Occupied Bandwidth, 802.11 a mode was the worst case; for 40MHz Occupied Bandwidth, 802.11 n(HT40) mode was the worst case; only the worst case of Ant 1 was recorded in the report.

ANT1:

Mode:		802.11 a Transmitting						
Channel:		5180 MHz						
NO.	Freq. [MHz]	Height [cm]	Azimuth [deg]	Level [dBm]	Limit [dBm]	Margin [dB]	Result	Polarity
1	99.1679	150	246	-63.93	-54.00	9.93	Pass	Horizontal
2	192.0062	150	327	-61.19	-54.00	7.19	Pass	Horizontal
3	600.029	150	175	-60.53	-54.00	6.53	Pass	Horizontal
4	1429.593	150	3	-50.36	-30.00	20.36	Pass	Horizontal
5	14412.3956	150	255	-43.58	-30.00	13.58	Pass	Horizontal
6	22148.4148	150	61	-54.88	-30.00	24.88	Pass	Horizontal
7	48.0438	150	77	-61.30	-54.00	7.30	Pass	Vertical
8	107.9958	150	3	-63.92	-54.00	9.92	Pass	Vertical
9	600.029	150	144	-62.91	-54.00	8.91	Pass	Vertical
10	1254.1254	150	325	-50.20	-30.00	20.20	Pass	Vertical
11	14404.9202	150	71	-43.52	-30.00	13.52	Pass	Vertical
12	21643.5644	150	296	-55.75	-30.00	25.75	Pass	Vertical

Mode:		802.11 n(HT40) Transmitting						
Channel:		5190 MHz						
NO.	Freq. [MHz]	Height [cm]	Azimuth [deg]	Level [dBm]	Limit [dBm]	Margin [dB]	Result	Polarity
1	60.461	150	357	-64.39	-54.00	10.39	Pass	Horizontal
2	216.0646	150	31	-60.94	-54.00	6.94	Pass	Horizontal
3	600.029	150	60	-61.66	-54.00	7.66	Pass	Horizontal
4	1278.8779	150	203	-48.90	-30.00	18.90	Pass	Horizontal
5	14463.5732	150	168	-44.37	-30.00	14.37	Pass	Horizontal
6	21538.7539	150	52	-54.50	-30.00	24.50	Pass	Horizontal
7	48.0438	150	93	-63.25	-54.00	9.25	Pass	Vertical
8	107.9958	150	141	-69.72	-54.00	15.72	Pass	Vertical
9	600.029	150	74	-62.94	-54.00	8.94	Pass	Vertical
10	1314.0814	150	159	-49.58	-30.00	19.58	Pass	Vertical
11	15927.5964	150	220	-42.88	-30.00	12.88	Pass	Vertical
12	23603.7604	150	53	-53.71	-30.00	23.71	Pass	Vertical

## 2) Receiver spurious emissions test data

Remark: Through Pre-scan, for 20MHz Occupied Bandwidth, 802.11 a mode was the worst case; for 40MHz Occupied Bandwidth, 802.11 n(HT40) mode was the worst case; only the worst case of Ant 1 was recorded was in the report.

ANT1:

Mode:		802.11 a Receiving						
Channel:		5180 MHz						
NO.	Freq. [MHz]	Height [cm]	Azimuth [deg]	Level [dBm]	Limit [dBm]	Margin [dB]	Result	Polarity
1	39.9915	150	102	-72.59	-57.00	15.59	Pass	Horizontal
2	127.9749	150	174	-68.00	-57.00	11.00	Pass	Horizontal
3	540.003	150	147	-67.06	-57.00	10.06	Pass	Horizontal
4	1593.6637	150	102	-67.35	-47.00	20.35	Pass	Horizontal
5	15900.756	150	288	-53.17	-47.00	6.17	Pass	Horizontal
6	21780.589	150	55	-64.12	-47.00	17.12	Pass	Horizontal
7	36.9358	150	47	-66.70	-57.00	9.70	Pass	Vertical
8	80.006	150	3	-70.21	-57.00	13.21	Pass	Vertical
9	750.067	150	3	-67.12	-57.00	10.12	Pass	Vertical
10	1195.8478	150	164	-64.14	-47.00	17.14	Pass	Vertical
11	5760.1904	150	214	-54.44	-47.00	7.44	Pass	Vertical
12	23600.28	150	93	-63.96	-47.00	16.96	Pass	Vertical

Mode:		802.11 n(HT40) Receiving						
Channel:		5190 MHz						
NO.	Freq. [MHz]	Height [cm]	Azimuth [deg]	Level [dBm]	Limit [dBm]	Margin [dB]	Result	Polarity
1	39.9915	150	1	-72.76	-57.00	15.76	Pass	Horizontal
2	226.5318	150	178	-69.37	-57.00	12.37	Pass	Horizontal
3	540.003	150	152	-68.03	-57.00	11.03	Pass	Horizontal
4	1592.9837	150	178	-68.04	-47.00	21.04	Pass	Horizontal
5	14410.8164	150	337	-52.46	-47.00	5.46	Pass	Horizontal
6	21832.1916	150	13	-64.51	-47.00	17.51	Pass	Horizontal
7	37.2269	150	256	-67.89	-57.00	10.89	Pass	Vertical
8	184.3347	150	3	-68.48	-57.00	11.48	Pass	Vertical
9	750.067	150	209	-70.28	-57.00	13.28	Pass	Vertical
10	1395.0958	150	90	-63.57	-47.00	16.57	Pass	Vertical
11	5760.1904	150	209	-54.70	-47.00	7.70	Pass	Vertical
12	23583.4792	150	69	-65.12	-47.00	18.12	Pass	Vertical

**PHOTOGRAPHS OF TEST SETUP**

Test model No.: BeaglePlay



**Radiated spurious emission Test Setup-1(Below 1GHz)**

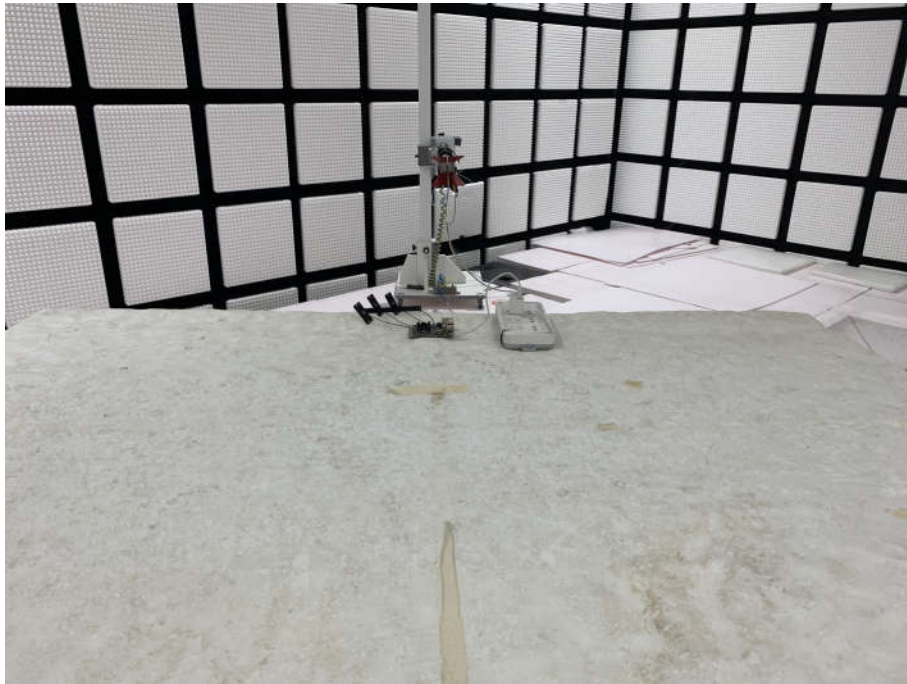

**Radiated spurious emission Test Setup-2(Above 1GHz)**





**Radiated spurious emission Test Setup-2(Above 18GHz)**



## PHOTOGRAPHS OF EUT Constructional Details

Refer to Report No. EED32P80002201 for EUT external and internal photos.

The test report is effective only with both signature and specialized stamp; the result(s) shown in this report refer only to the sample(s) tested. Without written approval of CTI, this report can't be reproduced except in full.

\*\*\* End of Report \*\*\*

## TEST REPORT

**Product** : BeaglePlay  
**Trade mark** : Beagleboard.org  
**Model/Type reference** : BeaglePlay  
**Serial Number** : N/A  
**Report Number** : EED32P80002205  
**Date of Issue** : Feb. 22, 2023  
**Test Standards** : ETSI EN 300 440 V2.2.1 (2018-07)  
**Test result** : PASS

Prepared for:

**Seed Technology Co., Ltd**  
9F, Building G3, TCL International E city, Zhongshanyuan Road,  
Nanshan, Shenzhen, China.

Prepared by:

**Centre Testing International Group Co., Ltd.**  
Hongwei Industrial Zone, Bao'an 70 District,  
Shenzhen, Guangdong, China  
**TEL: +86-755-3368 3668**  
**FAX: +86-755-3368 3385**

Compiled by:

*mark.chen*

Reviewed by:

*Tom Chen*

Mark Chen

Tom Chen

Approved by:

*Aaron Ma*

Date:

Feb. 22, 2023

Aaron Ma

Check No.: 5404030123



## 1 Version

Version No.	Date	Description
00	Feb. 22, 2023	Original

## 2 Test Summary

Radio Spectrum Matter (RSM) Part			
Test item	Test Requirement	Limit	Result
e.i.r.p.	EN 300 440 V2.2.1 Clause 4.2.2	Clause 4.2.2.4	PASS
Permitted Range of Operating Frequencies	EN 300 440 V2.2.1 Clause 4.2.3	Clause 4.2.3.5	PASS
Unwanted emissions in the spurious domain	EN 300 440 V2.2.1 Clause 4.2.4	Clause 4.2.4.4	PASS
Adjacent channel selectivity	EN 300 440 V2.2.1 Clause 4.3.3	Clause 4.3.3.4	PASS
Blocking or desensitization	EN 300 440 V2.2.1 Clause 4.3.4	Clause 4.3.4.4	PASS
Spurious radiation	EN 300 440 V2.2.1 Clause 4.3.5	Clause 4.3.5.4	PASS

Remark:

Company Name and Address shown on Report, the sample(s) and sample Information was/ were provided by the applicant who should be responsible for the authenticity which CTI hasn't verified.

Tx: In this whole report Tx (or tx) means Transmitter.

Rx: In this whole report Rx (or rx) means Receiver.

RF: In this whole report RF means Radiated Frequency.

CH: In this whole report CH means channel.

Volt: In this whole report Volt means Voltage.

Temp: In this whole report Temp means Temperature.

Humid: In this whole report Humid means humidity.

Press: In this whole report Press means Pressure.

N/A: In this whole report not application.

## 3 Contents

	Page
<b>1 VERSION</b> .....	<b>2</b>
<b>2 TEST SUMMARY</b> .....	<b>3</b>
<b>3 CONTENTS</b> .....	<b>4</b>
<b>4 GENERAL INFORMATION</b> .....	<b>5</b>
4.1 CLIENT INFORMATION .....	5
4.2 GENERAL DESCRIPTION OF EUT .....	5
4.3 OTHER INFORMATION .....	6
4.4 TEST ENVIRONMENT .....	6
4.5 DESCRIPTION OF SUPPORT UNITS .....	7
4.6 TEST LOCATION .....	7
4.7 DEVIATION FROM STANDARDS .....	7
4.8 ABNORMALITIES FROM STANDARD CONDITIONS .....	7
4.9 OTHER INFORMATION REQUESTED BY THE CUSTOMER .....	7
4.10 MEASUREMENT UNCERTAINTY (95% CONFIDENCE LEVELS, $k=2$ ) .....	8
<b>5 EQUIPMENT LIST</b> .....	<b>9</b>
<b>6 RADIO TECHNICAL REQUIREMENTS SPECIFICATION IN EN 300 440</b> .....	<b>11</b>
6.1 TRANSMITTER REQUIREMENTS .....	11
6.1.1 <i>Equivalent Isotropically Radiated Power</i> .....	11
6.1.2 <i>Permitted Range of Operating Frequencies</i> .....	14
6.1.3 <i>Unwanted emissions in the spurious domain</i> .....	16
6.2 RECEIVER REQUIREMENTS .....	20
6.2.1 <i>Adjacent Channel Selectivity</i> .....	21
6.2.2 <i>Blocking or Desensitization</i> .....	22
6.2.3 <i>Spurious Radiations</i> .....	24
<b>APPENDIX 1 PHOTOGRAPHS OF TEST SETUP</b> .....	<b>27</b>
<b>APPENDIX 2 PHOTOGRAPHS OF EUT CONSTRUCTIONAL DETAILS</b> .....	<b>29</b>



## 4 General Information

### 4.1 Client information

Applicant:	Seeed Technology Co., Ltd
Address of Applicant:	9F, Building G3, TCL International E city, Zhongshanyuan Road, Nanshan, Shenzhen, China.
Manufacturer:	Seeed Technology Co., Ltd
Address of Manufacturer:	9F, Building G3, TCL International E city, Zhongshanyuan Road, Nanshan, Shenzhen, China.
Factory:	Shenzhen Xinxian Technology Co., Limited
Address of Factory:	F5, Building B17, Hengfeng Industrial City, No. 739 Zhoushi Rd, Baoan District, Shenzhen, Guangdong, P.R.C.

### 4.2 General Description of EUT

Product Name:	BeaglePlay
Model No.(EUT):	BeaglePlay
Trade Mark:	Beagleboard.org
Type of Modulation:	IEEE 802.11a: OFDM (BPSK, QPSK, 16QAM, 64QAM) IEEE 802.11n(HT20/HT40): OFDM (BPSK, QPSK, 16QAM, 64QAM)
Operating Frequency	5745-5825MHz
Operating Temperature:	0°C to +60°C
Sample Type:	Fixed-Use
Test Power Grade:	Default
Test Software of EUT:	SecureCRT
Antenna Type:	PCB Antenna
Antenna Gain:	ANT1: 3.40dBi; ANT2: 3.40dBi
Function	<input checked="" type="checkbox"/> SISO <input type="checkbox"/> 2x2 MIMO <input type="checkbox"/> 3x3 MIMO <input type="checkbox"/> 4x4MIMO <input type="checkbox"/> Beamforming <input type="checkbox"/> TPC
Power Supply:	DC 5V
Test voltage:	DC 5V

### 4.3 Other Information

RED Directive:	2014/53/EU
Sample Received Date:	Jan. 03, 2023
Sample tested Date:	Jan. 03, 2023 to Feb. 16, 2023

### 4.4 Test Environment

Environment Parameter	Selected Values During Tests		
	Ambient		
Test condition	Temperature(°C)	Voltage(V)	Humidity(%)
NT/NV	23	DC 5V	54
LT/HV	0	DC 5.5V	54
LT/LV	0	DC 4.75V	54
HT/HV	60	DC 5.5V	54
HT/LV	60	DC 4.75V	54

Note:

- 1) The EUT just work in such extreme temperature of 0°C~+60°C and the voltage of DC 4.75V~DC 5.5V, so here the EUT is tested in the temperature of 0°C~+60°C and the voltage of DC 4.75V~DC 5.5V.
- 2) NV: Normal Voltage NT: Normal Temperature  
 LT: Low Extreme Test Temperature HT: High Extreme Test Temperature  
 LV: Low Extreme Test Voltage HT: High Extreme Test Voltage

The worst case configurations, The worst case data was recorded in the report.

SISO:

Band	802.11 Mode	Data rate
5745-5825MHz	a	6 Mbps
	n(HT20)	MCS7
	n(HT40)	MCS7

Operation Frequency each of channel

802.11a/802.11n(20MHz) Frequency/Channel Operations:

Channel	Frequency(MHz)
149	5745
153	5765
157	5785
161	5805
165	5825

802.11n(40MHz) Frequency/Channel Operations:

Channel	Frequency(MHz)
151	5755
159	5795

## 4.5 Description of Support Units

The EUT has been tested with associated equipment below.  
support equipment

Description	Manufacturer	Model No.	Certification	Supplied by
Netbook	DELL	Latitude 3490	FCC&CE	CTI

## 4.6 Test Location

All tests were performed at:

Centre Testing International Group Co., Ltd.

Hongwei Industrial Zone, Bao'an 70 District, Shenzhen, Guangdong, China 518101

Telephone: +86 (0) 755 3368 3668 Fax:+86 (0) 755 3368 3385

No tests were sub-contracted.

## 4.7 Deviation from Standards

None.

## 4.8 Abnormalities from Standard Conditions

None.

## 4.9 Other Information Requested by the Customer

None.

**4.10 Measurement Uncertainty (95% confidence levels, k=2)**

No.	Item	Measurement Uncertainty
1	Radio frequency	$7.9 \times 10^{-8}$
2	RF power (conducted)	0.46dB (30MHz-1GHz)
		0.55dB (1GHz-25GHz)
3	Radiated Spurious emission	4.3dB (30MHz-1GHz)
		4.5dB (1GHz-18GHz)
		3.4dB (18GHz-40GHz)
4	Temperature test	0.64°C
5	Humidity test	3.8%
6	DC and low frequency voltages test	0.026%
7	AC and low frequency voltages test(< 10 kHz)	1.2%

## 5 Equipment List

RF test system					
Equipment	Manufacturer	Mode No.	Serial Number	Cal. Date (mm-dd-yyyy)	Cal. Due date (mm-dd-yyyy)
Communication test set	R&S	CMW500	107929	07-06-2022	07-05-2023
Signal Generator	R&S	SMBV100A	1407.6004K02- 262149-CV	09-09-2022	09-08-2023
Spectrum Analyzer	R&S	FSV40	101200	08-01-2022	07-31-2023
RF control unit(power unit)	MWRF-test	MW100-RFCB	MW220620CTI-42	07-06-2022	07-05-2023
high-low temperature test chamber	Dong Guang Qin Zhuo	LK-80GA	QZ20150611879	12-19-2022	12-18-2023
Temperature/ Humidity Indicator	biaozhi	HM10	1804186	06-16-2022	06-15-2023
BT&WI-FI Automatic test software	MWRF-test	MTS 8310	2.0.0.0	---	---



3M full-anechoic Chamber					
Equipment	Manufacturer	Model No.	Serial Number	Cal. Date (mm-dd-yyyy)	Cal. Due date (mm-dd-yyyy)
RSE Automatic test software	JS Tonscend	JS36-RSE	10166	---	---
Receiver	Keysight	N9038A	MY57290136	03-01-2022	02-28-2023
Spectrum Analyzer	Keysight	N9020B	MY57111112	03-01-2022	02-28-2023
Spectrum Analyzer	Keysight	N9030B	MY57140871	03-01-2022	02-28-2023
TRILOG Broadband Antenna	Schwarzbeck	VULB 9163	9163-1148	04-28-2021	04-27-2024
Horn Antenna	Schwarzbeck	BBHA 9170	9170-832	04-15-2021	04-14-2024
Horn Antenna	ETS-LINDGREN	3117	57407	07-04-2021	07-03-2024
Preamplifier	EMCI	EMC184055SE	980597	04-20-2022	04-19-2023
Preamplifier	EMCI	EMC001330	980563	04-13-2022	04-12-2023
Preamplifier	JS Tonscend	TAP-011858	AP21B806112	07-29-2022	07-28-2023
Communication test set	R&S	CMW500	102898	12-23-2022	12-22-2023
Temperature/ Humidity Indicator	biaozhi	GM1360	EE1186631	02-21-2022	02-20-2023
Fully Anechoic Chamber	TDK	FAC-3	---	01-09-2021	01-08-2024
Cable line	Times	SFT205-NMSM-2.50M	394812-0001	---	---
Cable line	Times	SFT205-NMSM-2.50M	394812-0002	---	---
Cable line	Times	SFT205-NMSM-2.50M	394812-0003	---	---
Cable line	Times	SFT205-NMSM-2.50M	393495-0001	---	---
Cable line	Times	EMC104-NMNM-1000	SN160710	---	---
Cable line	Times	SFT205-NMSM-3.00M	394813-0001	---	---
Cable line	Times	SFT205-NMNM-1.50M	381964-0001	---	---
Cable line	Times	SFT205-NMSM-7.00M	394815-0001	---	---
Cable line	Times	HF160-KMKM-3.00M	393493-0001	---	---

## 6 Radio Technical Requirements Specification in EN 300 440

### 6.1 Transmitter Requirements

#### 6.1.1 Equivalent Isotropically Radiated Power

**Test Requirement:** EN 300 440 Clause 4.2.2

**Equipment Used:** Refer to section 5 for details.

**Test Setup:**

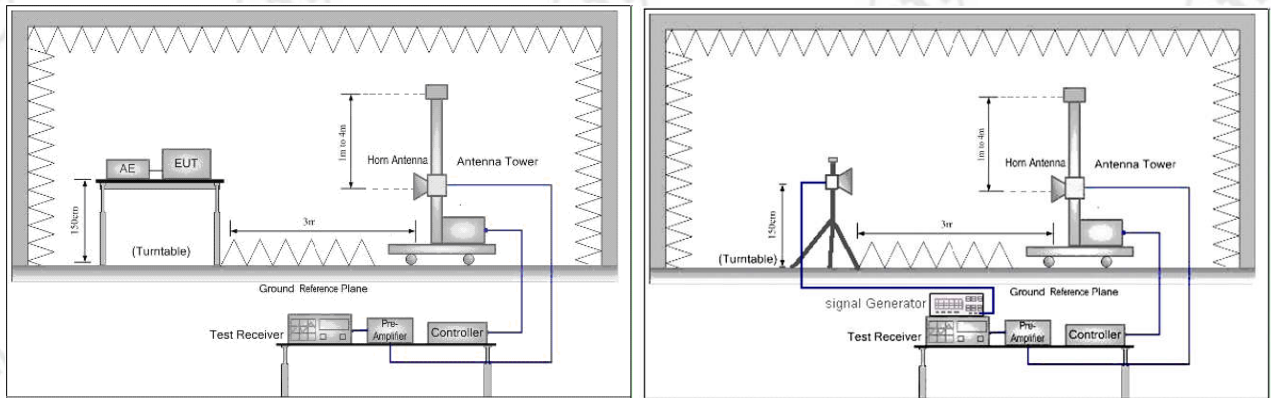
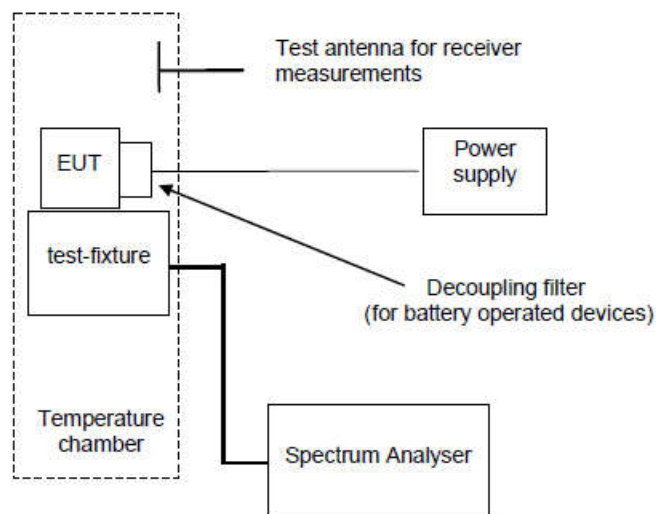

Figure 1. Above 1GHz(Normal Condition)

**Test Setup:**

**(Extreme Condition)**



**Test Procedure:**

Test procedure as below:

- 1) The EUT was powered ON and placed on a 1.5m high table at a 3 meter fully Anechoic Chamber. The antenna of the transmitter was extended to its maximum length. Modulation mode and the measuring receiver shall be tuned to the frequency of the transmitter under test.
- 2) The EUT was set 3 meters (above 18GHz the distance is 1 meter) away from the interference-receiving antenna, which was mounted on the top of a variable-height antenna tower.
- 3) The disturbance of the transmitter was maximized on the test receiver display by raising and lowering from 1m to 4m the receive antenna and by rotating through 360° the turntable. After the fundamental emission was maximized, a field strength measurement was made.
- 4) Steps 1) to 3) were performed with the EUT and the receive antenna in both vertical and horizontal polarization.
- 5) The transmitter was then removed and replaced with another antenna. The center of the antenna was approximately at the same location as the center of the transmitter.

- 6) A signal at the disturbance was fed to the substitution antenna by means of a non-radiating cable. With both the substitution and the receive antennas horizontally polarized, the receive antenna was raised and lowered to obtain a maximum reading at the test receiver. The level of the signal generator was adjusted until the measured field strength level in step 3) is obtained for this set of conditions.
- 7) The output power into the substitution antenna was then measured.
- 8) Steps 6) and 7) were repeated with both antennas polarized.
- 9) Calculate power in dBm by the following formula:

$$\text{EIRP(dBm)} = \text{Pg(dBm)} - \text{cable loss (dB)} + \text{antenna gain (dBi)}$$

$$\text{EIRP} = \text{ERP} + 2.15\text{dB}$$

Where: Pg is the generator output power into the substitution antenna.

- 10) Test the EUT in the lowest channel, middle channel, the Highest channel
- 11) Repeat above procedures until all frequencies measured was complete.

**Limit:**

14dBm

**Test result:**

PASS

**Test Data:**

Condition	Mode	Frequency (MHz)	Antenna	Max Burst RMS Power (dBm)	Burst Number	Max EIRP (dBm)	Limit (dBm)	Verdict
NVNT	a	5745	Ant1	8.07	12	11.47	13.98	Pass
NVNT	a	5785	Ant1	9.11	12	12.51	13.98	Pass
NVNT	a	5825	Ant1	9.5	12	12.9	13.98	Pass
NVNT	a	5745	Ant2	9.39	23	12.79	13.98	Pass
NVNT	a	5785	Ant2	8.4	23	11.8	13.98	Pass
NVNT	a	5825	Ant2	8.96	23	12.36	13.98	Pass
LVLT	a	5745	Ant1	8.07	12	11.47	13.98	Pass
LVLT	a	5785	Ant1	9.01	12	12.41	13.98	Pass
LVLT	a	5745	Ant2	9.74	24	13.14	13.98	Pass
LVLT	a	5785	Ant2	8.35	23	11.75	13.98	Pass
LVLT	a	5825	Ant2	8.9	24	12.3	13.98	Pass
LVHT	a	5745	Ant1	8.07	12	11.47	13.98	Pass
LVHT	a	5785	Ant1	8.97	13	12.37	13.98	Pass
LVHT	a	5745	Ant2	9.66	23	13.06	13.98	Pass
LVHT	a	5785	Ant2	8.4	24	11.8	13.98	Pass
LVHT	a	5825	Ant2	8.9	24	12.3	13.98	Pass
HVLT	a	5745	Ant1	7.93	12	11.33	13.98	Pass
HVLT	a	5785	Ant1	8.94	12	12.34	13.98	Pass
HVLT	a	5745	Ant2	9.77	23	13.17	13.98	Pass
HVLT	a	5785	Ant2	8.35	24	11.75	13.98	Pass
HVLT	a	5825	Ant2	8.87	23	12.27	13.98	Pass
HVHT	a	5745	Ant1	8.09	12	11.49	13.98	Pass
HVHT	a	5785	Ant1	8.92	12	12.32	13.98	Pass
HVHT	a	5745	Ant2	9.67	23	13.07	13.98	Pass
HVHT	a	5785	Ant2	8.35	23	11.75	13.98	Pass
HVHT	a	5825	Ant2	8.88	23	12.28	13.98	Pass
NVNT	n20	5745	Ant1	9.62	124	13.02	13.98	Pass
NVNT	n20	5785	Ant1	9.1	124	12.5	13.98	Pass
NVNT	n20	5825	Ant1	8.86	124	12.26	13.98	Pass
NVNT	n20	5745	Ant2	9.48	124	12.88	13.98	Pass
NVNT	n20	5785	Ant2	9.38	124	12.78	13.98	Pass
NVNT	n20	5825	Ant2	9.2	123	12.6	13.98	Pass

LVLT	n20	5745	Ant1	9.6	124	13	13.98	Pass
LVLT	n20	5785	Ant1	9.11	124	12.51	13.98	Pass
LVLT	n20	5825	Ant1	8.86	123	12.26	13.98	Pass
LVLT	n20	5745	Ant2	9.34	123	12.74	13.98	Pass
LVLT	n20	5785	Ant2	9.25	124	12.65	13.98	Pass
LVLT	n20	5825	Ant2	9.2	124	12.6	13.98	Pass
LVHT	n20	5745	Ant1	9.63	124	13.03	13.98	Pass
LVHT	n20	5785	Ant1	9.12	124	12.52	13.98	Pass
LVHT	n20	5825	Ant1	8.86	124	12.26	13.98	Pass
LVHT	n20	5745	Ant2	9.36	124	12.76	13.98	Pass
LVHT	n20	5785	Ant2	9.27	124	12.67	13.98	Pass
LVHT	n20	5825	Ant2	9.19	124	12.59	13.98	Pass
HVLT	n20	5745	Ant1	9.63	124	13.03	13.98	Pass
HVLT	n20	5785	Ant1	9.12	124	12.52	13.98	Pass
HVLT	n20	5825	Ant1	8.86	124	12.26	13.98	Pass
HVLT	n20	5745	Ant2	9.36	124	12.76	13.98	Pass
HVLT	n20	5785	Ant2	9.22	124	12.62	13.98	Pass
HVLT	n20	5825	Ant2	9.2	124	12.6	13.98	Pass
HVHT	n20	5745	Ant1	9.62	124	13.02	13.98	Pass
HVHT	n20	5785	Ant1	9.12	124	12.52	13.98	Pass
HVHT	n20	5825	Ant1	8.85	124	12.25	13.98	Pass
HVHT	n20	5745	Ant2	9.35	124	12.75	13.98	Pass
HVHT	n20	5785	Ant2	9.27	124	12.67	13.98	Pass
HVHT	n20	5825	Ant2	9.16	124	12.56	13.98	Pass
NVNT	n40	5755	Ant1	8.81	163	12.21	13.98	Pass
NVNT	n40	5795	Ant1	7.97	163	11.37	13.98	Pass
NVNT	n40	5755	Ant2	7.44	163	10.84	13.98	Pass
NVNT	n40	5795	Ant2	8.96	163	12.36	13.98	Pass
LVLT	n40	5755	Ant1	8.76	164	12.16	13.98	Pass
LVLT	n40	5795	Ant1	7.97	163	11.37	13.98	Pass
LVLT	n40	5755	Ant2	7.44	163	10.84	13.98	Pass
LVLT	n40	5795	Ant2	8.86	163	12.26	13.98	Pass
LVHT	n40	5755	Ant1	8.75	163	12.15	13.98	Pass
LVHT	n40	5795	Ant1	7.98	163	11.38	13.98	Pass
LVHT	n40	5755	Ant2	7.44	164	10.84	13.98	Pass
LVHT	n40	5795	Ant2	8.86	163	12.26	13.98	Pass
HVLT	n40	5755	Ant1	8.75	163	12.15	13.98	Pass
HVLT	n40	5795	Ant1	8	163	11.4	13.98	Pass
HVLT	n40	5755	Ant2	7.4	164	10.8	13.98	Pass
HVLT	n40	5795	Ant2	8.84	163	12.24	13.98	Pass
HVHT	n40	5755	Ant1	8.73	163	12.13	13.98	Pass
HVHT	n40	5795	Ant1	8	163	11.4	13.98	Pass
HVHT	n40	5755	Ant2	7.41	163	10.81	13.98	Pass
HVHT	n40	5795	Ant2	8.85	163	12.25	13.98	Pass



## 6.1.2 Permitted Range of Operating Frequencies

**Test Requirement:** EN 300 440 Clause 4.2.3  
**Equipment Used:** Refer to section 5 for details.  
**Test Setup:**

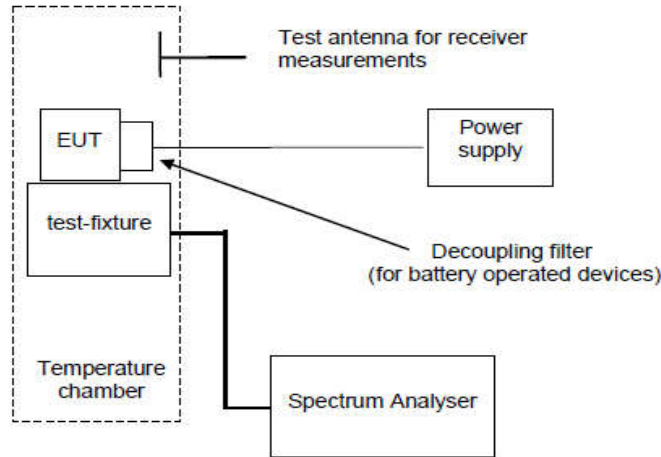

**Limit:**  $F_L > 5.725\text{GHz}$  and  $F_H < 5.875\text{GHz}$  (-30dBm)  
**Test result:** PASS  
**Test Data:**

Condition	Mode	Frequency (MHz)	Antenna	Frequency Range (MHz)	Limit (MHz)	Verdict
NVNT	a	5745	Ant1	5736	$\geq 5725$	Pass
NVNT	a	5825	Ant1	5834.52	$\leq 5875$	Pass
NVNT	a	5745	Ant2	5732.44	$\geq 5725$	Pass
NVNT	a	5825	Ant2	5835.04	$\leq 5875$	Pass
LVLT	a	5745	Ant1	5736.2	$\geq 5725$	Pass
LVLT	a	5825	Ant1	5834.6	$\leq 5875$	Pass
LVLT	a	5745	Ant2	5732.48	$\geq 5725$	Pass
LVLT	a	5825	Ant2	5834.76	$\leq 5875$	Pass
LVHT	a	5745	Ant1	5735.96	$\geq 5725$	Pass
LVHT	a	5825	Ant1	5834.32	$\leq 5875$	Pass
LVHT	a	5745	Ant2	5732.44	$\geq 5725$	Pass
LVHT	a	5825	Ant2	5835.04	$\leq 5875$	Pass
HVLT	a	5745	Ant1	5736.2	$\geq 5725$	Pass
HVLT	a	5825	Ant1	5834.36	$\leq 5875$	Pass
HVLT	a	5745	Ant2	5731.84	$\geq 5725$	Pass
HVLT	a	5825	Ant2	5834.08	$\leq 5875$	Pass
HVHT	a	5745	Ant1	5736.16	$\geq 5725$	Pass
HVHT	a	5825	Ant1	5834.56	$\leq 5875$	Pass
HVHT	a	5745	Ant2	5733.44	$\geq 5725$	Pass
HVHT	a	5825	Ant2	5833.84	$\leq 5875$	Pass
NVNT	n20	5745	Ant1	5735.6	$\geq 5725$	Pass
NVNT	n20	5825	Ant1	5834.92	$\leq 5875$	Pass
NVNT	n20	5745	Ant2	5735.56	$\geq 5725$	Pass
NVNT	n20	5825	Ant2	5840.04	$\leq 5875$	Pass
LVLT	n20	5745	Ant1	5735.36	$\geq 5725$	Pass
LVLT	n20	5825	Ant1	5834.92	$\leq 5875$	Pass
LVLT	n20	5745	Ant2	5729.64	$\geq 5725$	Pass
LVLT	n20	5825	Ant2	5840.36	$\leq 5875$	Pass
LVHT	n20	5745	Ant1	5735.64	$\geq 5725$	Pass
LVHT	n20	5825	Ant1	5834.56	$\leq 5875$	Pass
LVHT	n20	5745	Ant2	5735.84	$\geq 5725$	Pass



LVHT	n20	5825	Ant2	5840.6	<=5875	Pass
HVLT	n20	5745	Ant1	5735.56	>=5725	Pass
HVLT	n20	5825	Ant1	5834.72	<=5875	Pass
HVLT	n20	5745	Ant2	5735.84	>=5725	Pass
HVLT	n20	5825	Ant2	5842.6	<=5875	Pass
HVHT	n20	5745	Ant1	5735.36	>=5725	Pass
HVHT	n20	5825	Ant1	5834.96	<=5875	Pass
HVHT	n20	5745	Ant2	5735.56	>=5725	Pass
HVHT	n20	5825	Ant2	5841.36	<=5875	Pass
NVNT	n40	5755	Ant1	5736.64	>=5725	Pass
NVNT	n40	5795	Ant1	5813.6	<=5875	Pass
NVNT	n40	5755	Ant2	5736.46	>=5725	Pass
NVNT	n40	5795	Ant2	5818.82	<=5875	Pass
LVLT	n40	5755	Ant1	5736.46	>=5725	Pass
LVLT	n40	5795	Ant1	5813.54	<=5875	Pass
LVLT	n40	5755	Ant2	5736.46	>=5725	Pass
LVLT	n40	5795	Ant2	5818.82	<=5875	Pass
LVHT	n40	5755	Ant1	5736.64	>=5725	Pass
LVHT	n40	5795	Ant1	5813.42	<=5875	Pass
LVHT	n40	5755	Ant2	5736.46	>=5725	Pass
LVHT	n40	5795	Ant2	5817.62	<=5875	Pass
HVLT	n40	5755	Ant1	5736.64	>=5725	Pass
HVLT	n40	5795	Ant1	5813.54	<=5875	Pass
HVLT	n40	5755	Ant2	5736.46	>=5725	Pass
HVLT	n40	5795	Ant2	5818.22	<=5875	Pass
HVHT	n40	5755	Ant1	5736.64	>=5725	Pass
HVHT	n40	5795	Ant1	5813.54	<=5875	Pass
HVHT	n40	5755	Ant2	5736.46	>=5725	Pass
HVHT	n40	5795	Ant2	5818.82	<=5875	Pass

## 6.1.3 Unwanted emissions in the spurious domain

**Test** EN 300 440 Clause 4.2.4

**Requirement:**

**Receiver Setup:**

Frequency range	Measuring receiver bandwidth	Detector mode
25MHz-1000MHz	120kHz	QP
1GHz-40GHz	1MHz	Peak

**Equipment Used:** Refer to section 5 for details.

**Test Setup:**

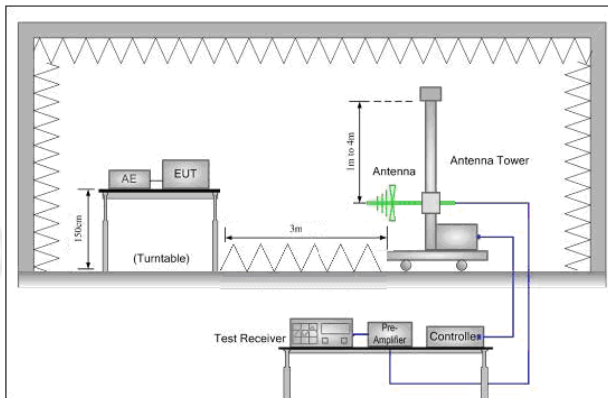

Figure 1. 25MHz to 1GHz

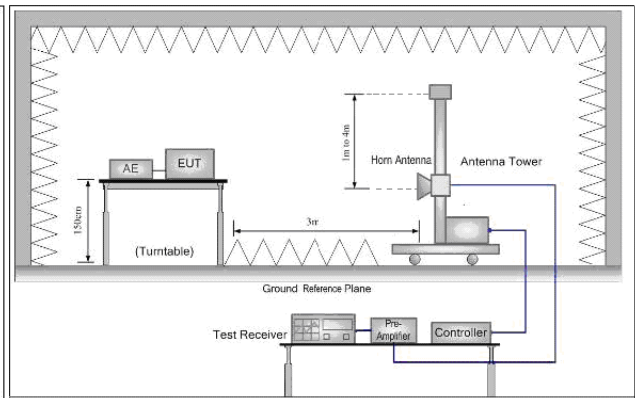

Figure 2. Above 1GHz

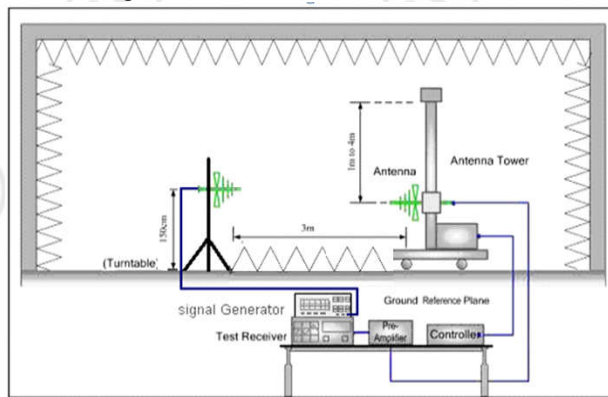

Figure 1. 25MHz to 1GHz

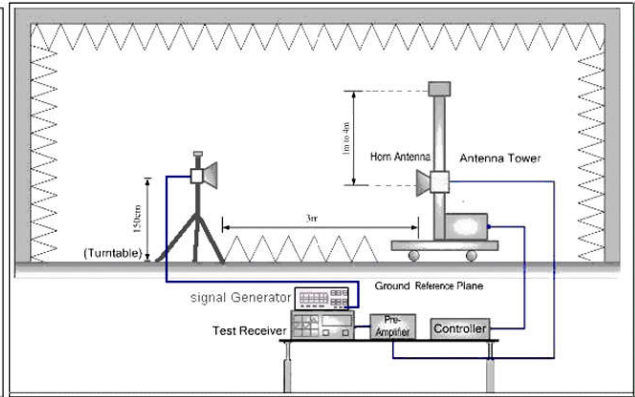

Figure 2. Above 1GHz

**Test Procedure:**

- 1 Scan from 25MHz to 40GHz; find the maximum radiation frequency to measure.
- 2 The technique used to find the Spurious Emissions of the transmitter was the antenna substitution method. Substitution method was performed to determine the actual ERP/EIRP emission levels of the EUT.

Test procedure as below:

- 1) The EUT was powered ON and placed on a 1.5m high table at a 3 meter fully Anechoic Chamber. The antenna of the transmitter was extended to its maximum length. Modulation mode and the measuring receiver shall be tuned to the frequency of the transmitter under test.
- 2) The EUT was set 3 meters (above 18GHz the distance is 1 meter) away from the interference-receiving antenna, which was mounted on the top of a variable-height antenna tower.
- 3) The disturbance of the transmitter was maximized on the test receiver display by raising and lowering from 1m to 4m the receive antenna and by rotating through 360° the turntable. After the fundamental emission was maximized, a field strength measurement was made.
- 4) Steps 1) to 3) were performed with the EUT and the receive antenna in both vertical

and horizontal polarization.

- 5) The transmitter was then removed and replaced with another antenna. The center of the antenna was approximately at the same location as the center of the transmitter.
- 6) A signal at the disturbance was fed to the substitution antenna by means of a non-radiating cable. With both the substitution and the receive antennas horizontally polarized, the receive antenna was raised and lowered to obtain a maximum reading at the test receiver. The level of the signal generator was adjusted until the measured field strength level in step 3) is obtained for this set of conditions.
- 7) The output power into the substitution antenna was then measured.
- 8) Steps 6) and 7) were repeated with both antennas polarized.
- 9) Calculate power in dBm by the following formula:  

$$\text{ERP(dBm)} = \text{Pg(dBm)} - \text{cable loss (dB)} + \text{antenna gain (dB)}$$

$$\text{EIRP(dBm)} = \text{Pg(dBm)} - \text{cable loss (dB)} + \text{antenna gain (dBi)}$$

$$\text{EIRP} = \text{ERP} + 2.15\text{dB}$$

Where: Pg is the generator output power into the substitution antenna.

- 10) Test the EUT in the lowest channel and the Highest channel  
 Repeat above procedures until all frequencies measured was complete.

**Limit:**

Frequency ranges	47 MHz to 74 MHz 87.5 MHz to 108 MHz 174 MHz to 230 MHz 470 MHz to 862 MHz	Other Frequencies ≤ 1000 MHz	Frequencies > 1000 MHz
Operating	4 nW	250 nW	1 μW
Standby	2 nW	2 nW	20 nW

**Test result:** PASS

**Remark:**

For SISO mode, the worst case was 802.11a;  
 for 40MHz bandwidth of MIMO mode, the worst case was 802.11n(HT40);  
 only the worst case was recorded in the report.

**Standby mode test result:**

Not any spurious emissions have been observed.

**Test Data:**

Remark: Through Pre-scan, for 20MHz Occupied Bandwidth, 802.11 a mode was the worst case; for 40MHz Occupied Bandwidth, 802.11 n(HT40) mode was the worst case; only the worst case of Ant 1 was recorded in the report.

Ant 1:

Mode:		802.11 a Transmitting						
Channel:		5745						
NO.	Freq. [MHz]	Height [cm]	Azimuth [deg]	Level [dBm]	Limit [dBm]	Margin [dB]	Result	Polarity
1	96.3613	150	188	-62.99	-54.00	8.99	Pass	Horizontal
2	192.0224	150	319	-58.78	-54.00	4.78	Pass	Horizontal
3	600.086	150	59	-60.83	-54.00	6.83	Pass	Horizontal
4	1361.3861	150	69	-48.68	-30.00	18.68	Pass	Horizontal
5	14397.1931	150	90	-43.70	-30.00	13.70	Pass	Horizontal
6	26565.4565	150	28	-51.20	-30.00	21.20	Pass	Horizontal
7	60.076	150	222	-62.18	-54.00	8.18	Pass	Vertical
8	95.9732	150	134	-59.91	-54.00	5.91	Pass	Vertical
9	600.086	150	274	-62.62	-54.00	8.62	Pass	Vertical
10	5749.725	150	166	-37.87	-30.00	7.87	Pass	Vertical
11	15894.593	150	154	-42.92	-30.00	12.92	Pass	Vertical
12	30864.6865	150	207	-52.14	-30.00	22.14	Pass	Vertical

Mode:		802.11 a Transmitting						
Channel:		5825						
NO.	Freq. [MHz]	Height [cm]	Azimuth [deg]	Level [dBm]	Limit [dBm]	Margin [dB]	Result	Polarity
1	60.076	150	357	-62.56	-54.00	8.56	Pass	Horizontal
2	192.0224	150	308	-58.93	-54.00	4.93	Pass	Horizontal
3	600.086	150	66	-61.60	-54.00	7.60	Pass	Horizontal
4	1284.9285	150	134	-47.56	-30.00	17.56	Pass	Horizontal
5	14414.0609	150	66	-43.06	-30.00	13.06	Pass	Horizontal
6	30827.2827	150	66	-52.09	-30.00	22.09	Pass	Horizontal
7	48.0456	150	49	-63.26	-54.00	9.26	Pass	Vertical
8	192.0224	150	357	-65.85	-54.00	11.85	Pass	Vertical
9	600.086	150	81	-61.58	-54.00	7.58	Pass	Vertical
10	1278.8779	150	70	-48.58	-30.00	18.58	Pass	Vertical
11	14299.82	150	360	-43.46	-30.00	13.46	Pass	Vertical
12	29511.5512	150	135	-50.60	-30.00	20.60	Pass	Vertical

Mode:		802.11 n(HT40) Transmitting						
Channel:		5755						
NO.	Freq. [MHz]	Height [cm]	Azimuth [deg]	Level [dBm]	Limit [dBm]	Margin [dB]	Result	Polarity
1	63.1806	150	357	-64.36	-54.00	10.36	Pass	Horizontal
2	192.0224	150	315	-59.73	-54.00	5.73	Pass	Horizontal
3	600.086	150	57	-61.28	-54.00	7.28	Pass	Horizontal
4	1305.2805	150	67	-49.36	-30.00	19.36	Pass	Horizontal
5	14399.4933	150	330	-43.18	-30.00	13.18	Pass	Horizontal
6	29502.7503	150	24	-51.59	-30.00	21.59	Pass	Horizontal
7	48.0456	150	81	-62.85	-54.00	8.85	Pass	Vertical
8	192.0224	150	208	-65.48	-54.00	11.48	Pass	Vertical
9	600.086	150	208	-62.60	-54.00	8.60	Pass	Vertical
10	1279.978	150	36	-48.91	-30.00	18.91	Pass	Vertical
11	14457.7639	150	201	-43.42	-30.00	13.42	Pass	Vertical
12	27020.9021	150	56	-52.65	-30.00	22.65	Pass	Vertical

Mode:		802.11 n(HT40) Transmitting						
Channel:		5795						
NO.	Freq. [MHz]	Height [cm]	Azimuth [deg]	Level [dBm]	Limit [dBm]	Margin [dB]	Result	Polarity
1	60.6581	150	357	-62.68	-54.00	8.68	Pass	Horizontal
2	216.0832	150	20	-61.25	-54.00	7.25	Pass	Horizontal
3	600.086	150	62	-61.28	-54.00	7.28	Pass	Horizontal
4	1287.1287	150	7	-49.40	-30.00	19.40	Pass	Horizontal
5	14395.6597	150	11	-43.98	-30.00	13.98	Pass	Horizontal
6	27826.1826	150	293	-52.45	-30.00	22.45	Pass	Horizontal
7	51.3443	150	104	-66.26	-54.00	12.26	Pass	Vertical
8	192.0224	150	8	-66.14	-54.00	12.14	Pass	Vertical
9	600.086	150	274	-62.87	-54.00	8.87	Pass	Vertical
10	1284.3784	150	0	-49.11	-30.00	19.11	Pass	Vertical
11	14393.3596	150	307	-42.85	-30.00	12.85	Pass	Vertical
12	29619.3619	150	211	-52.43	-30.00	22.43	Pass	Vertical



## 6.2 Receiver Requirements

Receiver Classification, Table 5 of EN 300 440.		
Receiver category	Relevant receiver clauses	Risk assessment of receiver performance
1	4.3.3, 4.3.4 and 4.3.5	Highly reliable SRD communication media; e.g. serving human life inherent systems (may result in a physical risk to a person).
2	4.3.4 and 4.3.5	Medium reliable SRD communication media e.g. causing Inconvenience to persons, which cannot simply be overcome by other means.
3	4.3.5	Standard reliable SRD communication media e.g. Inconvenience to persons, which can simply be overcome by other means (e.g. manual).

**Remark: The EUT belong to Receiver category 1.**

## 6.2.1 Adjacent Channel Selectivity

**Test Requirement:** EN 300 440 Clause 4.3.3

**Test Status:** Keep the Rx operating with receiver mode under normal test conditions.

**Test Setup:**

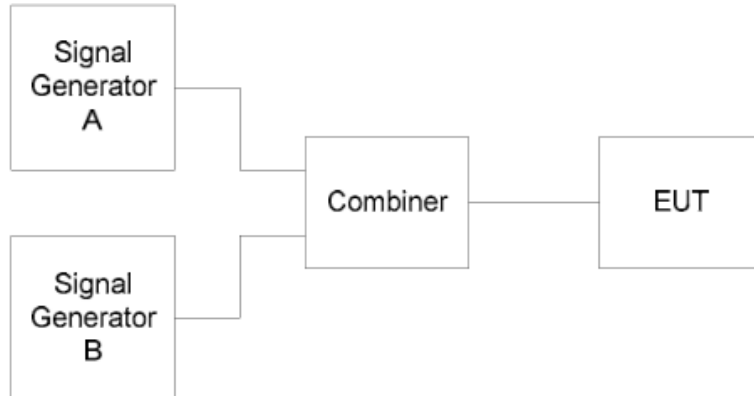

**Equipment Used:** Refer to section 6 for details.

### Limit for adjacent channel selectivity

Limit
-30 dBm + k

The correction factor, k, is as follows:

$$k = -20 \log f - 10 \log BW$$

**Limit:**

Where:

- f is the frequency in GHz;
- BW is the channel bandwidth in MHz.

The factor k is limited within the following:

$$-40 \text{ dB} < k < 0 \text{ dB}.$$

**Test result:** PASS

Test data:

Condition	Mode	Frequency (MHz)	Antenna	Pmin (dBm)	Wanted Power (dBm)	Blocking Frequency (MHz)	Blocking Power (dBm)	Limit (dBm)	PER (%)	Verdict
NVNT	a	5745	Ant1	-60	Pmin+3	5725	-50	-57.31	0.7	Pass
NVNT	a	5745	Ant1	-60	Pmin+3	5765	-50	-57.31	0.4	Pass
NVNT	a	5785	Ant1	-60	Pmin+3	5765	-50	-57.45	1.7	Pass
NVNT	a	5785	Ant1	-60	Pmin+3	5805	-50	-57.45	0.9	Pass
NVNT	a	5825	Ant1	-60	Pmin+3	5805	-50	-57.45	1.2	Pass
NVNT	a	5825	Ant1	-60	Pmin+3	5845	-50	-57.45	1.4	Pass
NVNT	n20	5745	Ant1	-60	Pmin+3	5725	-50	-57.61	0.4	Pass
NVNT	n20	5745	Ant1	-60	Pmin+3	5765	-50	-57.61	0.5	Pass
NVNT	n20	5785	Ant1	-60	Pmin+3	5765	-50	-57.68	0.5	Pass
NVNT	n20	5785	Ant1	-60	Pmin+3	5805	-50	-57.68	0.6	Pass
NVNT	n20	5825	Ant1	-60	Pmin+3	5805	-50	-57.83	1.1	Pass
NVNT	n20	5825	Ant1	-60	Pmin+3	5845	-50	-57.83	1	Pass
NVNT	n40	5755	Ant1	-60	Pmin+3	5715	-50	-60.75	0.5	Pass
NVNT	n40	5755	Ant1	-60	Pmin+3	5795	-50	-60.75	0.3	Pass
NVNT	n40	5795	Ant1	-60	Pmin+3	5755	-50	-60.81	0.4	Pass
NVNT	n40	5795	Ant1	-60	Pmin+3	5835	-50	-60.81	1.3	Pass

## 6.2.2 Blocking or Desensitization

**Test Requirement:** EN 300 440 Clause 4.3.4

**Test Status:** Keep the Rx operating with receiver mode under normal test conditions.

**Test Setup:**

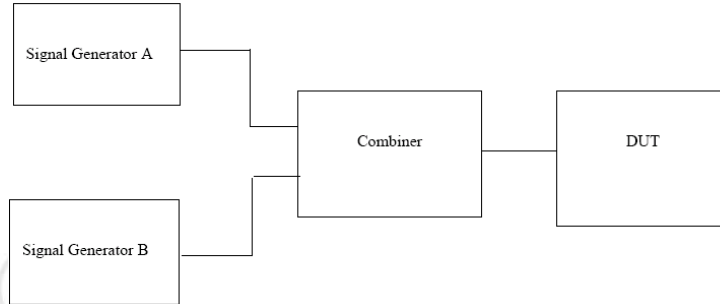

**Equipment Used:** Refer to section 6 for details.

**Limits for blocking or desensitization**

Receiver category	Limit
1	-30 dBm + k
2	-45 dBm + k
3	-60 dBm + k

**Limit:**

The correction factor, k, is as follows:

$$k = -20 \log f - 10 \log BW$$

Where:

- f is the frequency in GHz;
- BW is the channel bandwidth in MHz.

The factor k is limited within the following:

$$-40 < k < 0 \text{ dB.}$$

**Test result:** PASS

Test data:

Condition	Mode	Frequency (MHz)	Antenna	Pmin (dBm)	Wanted Power (dBm)	Blocking Frequency (MHz)	Blocking Power (dBm)	Limit (dBm)	PER (%)	Verdict
NVNT	a	5745	Ant1	-60	Pmin+3	4921.749	-50	-57.31	0.7	Pass
NVNT	a	5745	Ant1	-60	Pmin+3	5410.809	-50	-57.31	0.7	Pass
NVNT	a	5745	Ant1	-60	Pmin+3	5573.829	-50	-57.31	0.6	Pass
NVNT	a	5745	Ant1	-60	Pmin+3	5916.171	-50	-57.31	0.9	Pass
NVNT	a	5745	Ant1	-60	Pmin+3	6079.191	-50	-57.31	1	Pass
NVNT	a	5745	Ant1	-60	Pmin+3	6568.251	-50	-57.31	0.6	Pass
NVNT	a	5825	Ant1	-60	Pmin+3	4997.911	-50	-57.45	0.6	Pass
NVNT	a	5825	Ant1	-60	Pmin+3	5489.251	-50	-57.45	0.6	Pass
NVNT	a	5825	Ant1	-60	Pmin+3	5653.031	-50	-57.45	0.6	Pass
NVNT	a	5825	Ant1	-60	Pmin+3	5996.969	-50	-57.45	1	Pass
NVNT	a	5825	Ant1	-60	Pmin+3	6160.749	-50	-57.45	0.9	Pass
NVNT	a	5825	Ant1	-60	Pmin+3	6652.089	-50	-57.45	0.4	Pass
NVNT	n20	5745	Ant1	-60	Pmin+3	4862.563	-50	-57.61	0.5	Pass
NVNT	n20	5745	Ant1	-60	Pmin+3	5386.783	-50	-57.61	0.7	Pass
NVNT	n20	5745	Ant1	-60	Pmin+3	5561.523	-50	-57.61	1	Pass
NVNT	n20	5745	Ant1	-60	Pmin+3	5928.477	-50	-57.61	1	Pass
NVNT	n20	5745	Ant1	-60	Pmin+3	6103.217	-50	-57.61	1	Pass
NVNT	n20	5745	Ant1	-60	Pmin+3	6627.437	-50	-57.61	0.7	Pass
NVNT	n20	5825	Ant1	-60	Pmin+3	4922.363	-50	-57.83	0.7	Pass
NVNT	n20	5825	Ant1	-60	Pmin+3	5458.583	-50	-57.83	0.5	Pass
NVNT	n20	5825	Ant1	-60	Pmin+3	5637.323	-50	-57.83	1.1	Pass
NVNT	n20	5825	Ant1	-60	Pmin+3	6012.677	-50	-57.83	1	Pass
NVNT	n20	5825	Ant1	-60	Pmin+3	6191.417	-50	-57.83	0.7	Pass
NVNT	n20	5825	Ant1	-60	Pmin+3	6727.637	-50	-57.83	0.5	Pass

## 6.2.3 Spurious Radiations

- Test Requirement:** EN 300 440 Clause 4.3.5
- Test Status:**
- 1) Keep the EUT in continuously receiver with test single.
  - 2) Keep the EUT searching and receiving the useful test signal.
  - 3) Test EUT in normal conditions.

**Receiver Setup:**

Frequency range	Measuring receiver bandwidth	Detector mode
25MHz-1000MHz	120kHz	QP
1GHz-40GHz	1MHz	Peak

**Equipment Used:** Refer to section 6 for details.

**Test Setup:**

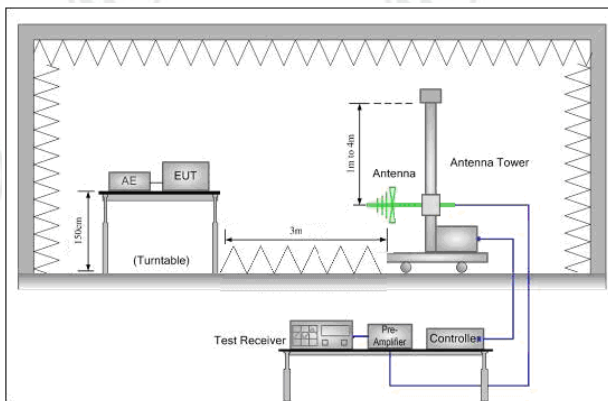

Figure 1. 25MHz to 1GHz

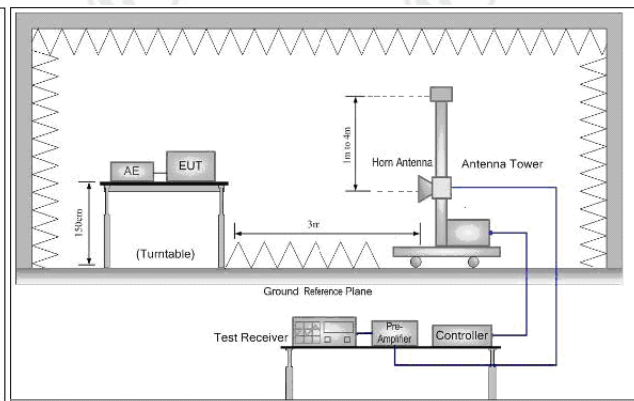

Figure 2. Above 1GHz

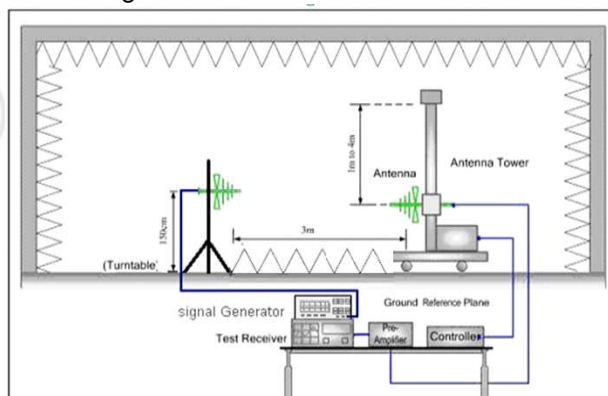

Figure 1. 25MHz to 1GHz

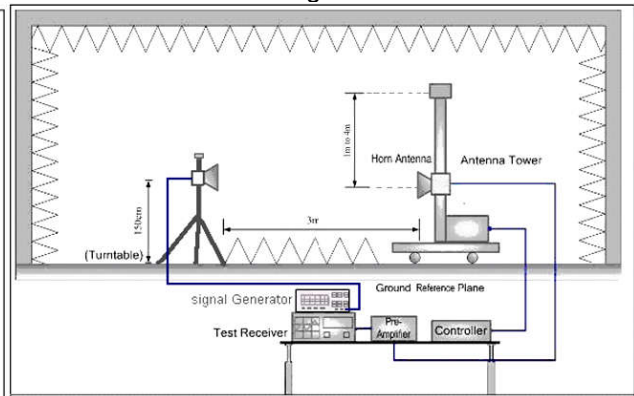

Figure 2. Above 1GHz

1. Scan from 25MHz to 40GHz; find the maximum radiation frequency to measure.
2. The technique used to find the Spurious Emissions of the transmitter was the antenna substitution method. Substitution method was performed to determine the actual ERP/EIRP emission levels of the EUT.

Test procedure as below:

- 1) The EUT was powered ON and placed on a 1.5m high table at a 3 meter fully Anechoic Chamber. The antenna of the transmitter was extended to its maximum length. Modulation mode and the measuring receiver shall be tuned to the frequency of the transmitter under test.
- 2) The EUT was set 3 meters (above 18GHz the distance is 1 meter) away from the interference-receiving antenna, which was mounted on the top of a variable-height antenna tower.
- 3) The disturbance of the transmitter was maximized on the test receiver display by raising and lowering from 1m to 4m the receive antenna and by rotating through 360° the turntable. After the fundamental emission was maximized, a field strength

**Test Procedure:**



- measurement was made.
- 4) Steps 1) to 3) were performed with the EUT and the receive antenna in both vertical and horizontal polarization.
  - 5) The transmitter was then removed and replaced with another antenna. The center of the antenna was approximately at the same location as the center of the transmitter.
  - 6) A signal at the disturbance was fed to the substitution antenna by means of a non-radiating cable. With both the substitution and the receive antennas horizontally polarized, the receive antenna was raised and lowered to obtain a maximum reading at the test receiver. The level of the signal generator was adjusted until the measured field strength level in step 3) is obtained for this set of conditions.
  - 7) The output power into the substitution antenna was then measured.
  - 8) Steps 6) and 7) were repeated with both antennas polarized.
  - 9) Calculate power in dBm by the following formula:  
$$\text{ERP(dBm)} = \text{Pg(dBm)} - \text{cable loss (dB)} + \text{antenna gain (dBd)}$$
$$\text{EIRP(dBm)} = \text{Pg(dBm)} - \text{cable loss (dB)} + \text{antenna gain (dBi)}$$
$$\text{EIRP} = \text{ERP} + 2.15\text{dB}$$

Where: Pg is the generator output power into the substitution antenna.
  - 10) Test the EUT in the lowest channel and the Highest channel
  - 11) Repeat above procedures until all frequencies measured was complete.

**Limit:**

Frequency range	Limit
25MHz-1000MHz	2nW
1GHz-40GHz	20nW

**Test result:**

PASS

**Remark:**

For SISO mode, the worst case was 802.11a;  
for 40MHz bandwidth of MIMO mode, the worst case was 802.11n(HT40);  
only the worst case was recorded in the report.

**Test Data:**

Ant 1:

Mode:		802.11 a Receiving						
Channel:		5745						
NO.	Freq. [MHz]	Height [cm]	Azimuth [deg]	Level [dBm]	Limit [dBm]	Margin [dB]	Result	Polarity
1	40.3795	150	12	-72.76	-57.00	15.76	Pass	Horizontal
2	160.035	150	357	-71.46	-57.00	14.46	Pass	Horizontal
3	540.003	150	150	-66.37	-57.00	9.37	Pass	Horizontal
4	1439.9776	150	130	-67.46	-47.00	20.46	Pass	Horizontal
5	14401.9761	150	84	-53.15	-47.00	6.15	Pass	Horizontal
6	21791.7896	150	316	-64.02	-47.00	17.02	Pass	Horizontal
7	36.8388	150	255	-67.18	-57.00	10.18	Pass	Vertical
8	167.0679	150	22	-67.01	-57.00	10.01	Pass	Vertical
9	750.067	150	3	-68.21	-57.00	11.21	Pass	Vertical
10	1397.1359	150	114	-60.93	-47.00	13.93	Pass	Vertical
11	5760.1904	150	209	-54.44	-47.00	7.44	Pass	Vertical
12	23572.2786	150	230	-64.29	-47.00	17.29	Pass	Vertical

Mode:		802.11 n(HT40) Receiving						
Channel:		5755						
NO.	Freq. [MHz]	Height [cm]	Azimuth [deg]	Level [dBm]	Limit [dBm]	Margin [dB]	Result	Polarity
1	40.3795	150	90	-72.95	-57.00	15.95	Pass	Horizontal
2	214.6972	150	161	-67.61	-57.00	10.61	Pass	Horizontal
3	540.003	150	134	-67.59	-57.00	10.59	Pass	Horizontal
4	1595.0238	150	90	-67.48	-47.00	20.48	Pass	Horizontal
5	14401.9761	150	44	-52.52	-47.00	5.52	Pass	Horizontal
6	21827.7914	150	114	-65.17	-47.00	18.17	Pass	Horizontal
7	37.0814	150	295	-68.29	-57.00	11.29	Pass	Vertical
8	184.2862	150	3	-68.71	-57.00	11.71	Pass	Vertical
9	832.2301	150	249	-69.91	-57.00	12.91	Pass	Vertical
10	1199.248	150	113	-65.86	-47.00	18.86	Pass	Vertical
11	5760.1904	150	204	-54.65	-47.00	7.65	Pass	Vertical
12	23557.0779	150	43	-66.61	-47.00	19.61	Pass	Vertical

**APPENDIX 1 PHOTOGRAPHS OF TEST SETUP**

Test model No.: BeaglePlay



**Radiated spurious emission Test Setup-1(Below 1GHz)**

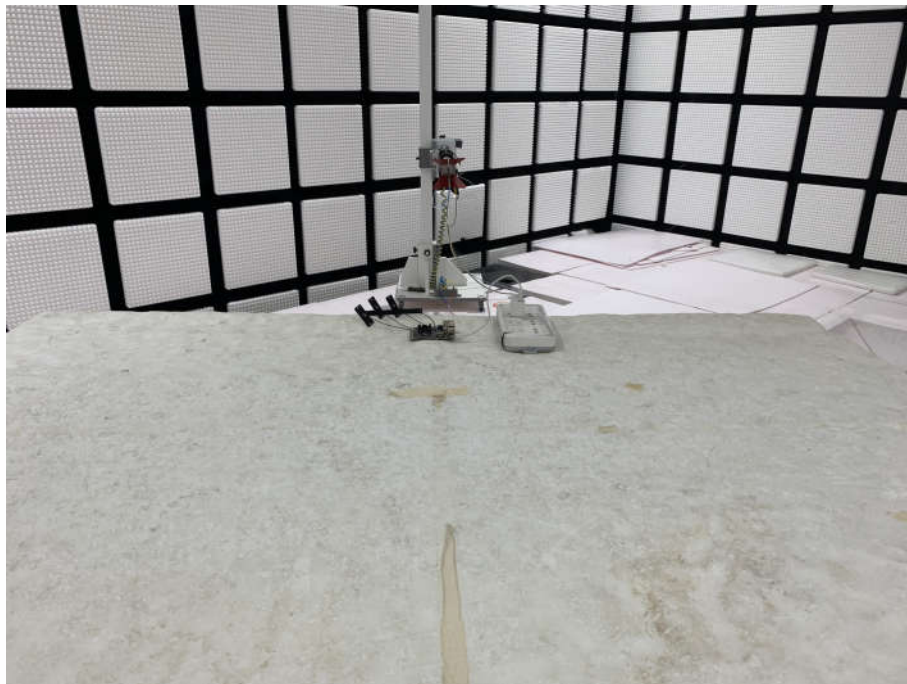

**Radiated spurious emission Test Setup-2(Above 1GHz)**



**Radiated spurious emission Test Setup-2(Above 18GHz)**



## APPENDIX 2 PHOTOGRAPHS OF EUT Constructional Details

Refer to Report No. ED32P80002201 for EUT external and internal photos.

The test report is effective only with both signature and specialized stamp, The result(s) shown in this report refer only to the sample(s) tested. Without written approval of CTI, this report can't be reproduced except in full.

\*\*\* End of Report \*\*\*



## RF Exposure Evaluation Report

**Product** : BeaglePlay  
**Trade mark** : Beagleboard.org  
**Model/Type reference** : BeaglePlay  
**Serial Number** : N/A  
**Report Number** : EED32P80002206  
**Date of Issue** : Feb. 22, 2023  
**Test Standards** : EN 50665:2017  
**Test result** : PASS

Prepared for:  
**Seed Technology Co., Ltd**  
**9F, Building G3, TCL International E city, Zhongshanyuan Road,**  
**Nanshan, Shenzhen, China.**

Prepared by:  
**Centre Testing International Group Co., Ltd.**  
**Hongwei Industrial Zone, Bao'an 70 District,**  
**Shenzhen, Guangdong, China**  
**TEL: +86-755-3368 3668**  
**FAX: +86-755-3368 3385**

Compiled by:

*mark.chen*

Reviewed by:

*Tom Chen*

Approved by:

*Aaron Ma*

Date:

Feb. 22, 2023

Aaron Ma

Check No.: 5404030123



## 2 Version

Version No.	Date	Description
00	Feb. 22, 2023	Original

## 3 Contents

	Page
<b>1 COVER PAGE</b> .....	<b>1</b>
<b>2 VERSION</b> .....	<b>2</b>
<b>3 3 CONTENTS</b> .....	<b>3</b>
<b>4 GENERAL INFORMATION</b> .....	<b>4</b>
4.1 CLIENT INFORMATION .....	4
4.2 GENERAL DESCRIPTION OF EUT .....	4
4.3 TEST LOCATION .....	6
4.4 DEVIATION FROM STANDARDS .....	6
4.5 ABNORMALITIES FROM STANDARD CONDITIONS .....	6
4.6 OTHER INFORMATION REQUESTED BY THE CUSTOMER .....	6
<b>5 TECHNICAL REQUIREMENTS SPECIFICATION IN EN 50665</b> .....	<b>7</b>
5.1 GENERAL DESCRIPTION OF APPLIED STANDARDS .....	7
5.2 RF EXPOSURE EVALUATION .....	7
5.2.1 HUMAN EXPOSURE ASSESSMENT .....	8

## 4 General Information

### 4.1 Client Information

Applicant:	Seeed Technology Co., Ltd
Address of Applicant:	9F, Building G3, TCL International E city, Zhongshanyuan Road, Nanshan, Shenzhen, China.
Manufacturer:	Seeed Technology Co., Ltd
Address of Manufacturer:	9F, Building G3, TCL International E city, Zhongshanyuan Road, Nanshan, Shenzhen, China.
Factory:	Shenzhen Xinxian Technology Co., Limited
Address of Factory:	F5, Building B17, Hengfeng Industrial City, No. 739 Zhoushi Rd, Baoan District, Shenzhen, Guangdong, P.R.C.

### 4.2 General Description of EUT

Product Name:	BeaglePlay
Model No.(EUT):	BeaglePlay
Trade Mark:	Beagleboard.org
Frequency Range:	BLE: 2402MHz to 2480MHz DTS LORA: 830MHz~870MHz 2.4 G WIFI: IEEE 802.11b/g/n(HT20): 2412MHz to 2472MHz IEEE 802.11n(HT40): 2422MHz to 2462MHz 5G WIFI: 5150-5250MHz 5745-5825MHz
Modulation Type:	BLE: GFSK DTS: LORA Chirp Spread Spectrum 2.4G WIFI: IEEE for 802.11b:DSSS(CCK,DQPSK,DBPSK) IEEE for 802.11g:OFDM(64QAM, 16QAM, QPSK, BPSK) IEEE for 802.11n(HT20 and HT40): OFDM (64QAM, 16QAM,QPSK,BPSK) 5G WIFI: IEEE 802.11a: OFDM (BPSK, QPSK, 16QAM, 64QAM) IEEE 802.11n(HT20/HT40): OFDM (BPSK, QPSK, 16QAM, 64QAM)
Sample Type:	Fixed-Use
Test Power Grade:	Default
Test Software of EUT:	BLE/LORA: Setup_SmartRF_Studio_7 WIFI: SecureCRT
Antenna Type:	PCB Antenna
Antenna Gain:	BLE: 1.54dBi ,LORA: 1.0dBi 2.4G WIFI: ANT1: 1.54dBi; ANT2: 1.54dBi 5G WIFI: ANT1: 3.40dBi; ANT2: 3.40dBi
Power Supply:	DC 5V
EIRP:	BLE: 2.93dBm, LORA: 15.07dBm(EPR:12.92 dBm), 2.4G WIFI: 18.24dBm, 5G WIFI: 19.36dBm The EIRP data refer to the report EED32P80002201, EED32P80002202, ER741330-06, ER741330-02,
Sample Received Date:	Jan. 03, 2023
Sample tested Date:	Jan. 03, 2023 to Feb. 16, 2023

Remark:

Company Name and Address shown on Report, the sample(s) and sample Information was/ were provided by the applicant who should be responsible for the authenticity which CTI hasn't verified.



### 4.3 Test Location

All tests were performed at:

Centre Testing International Group Co., Ltd.

Building C, Hongwei Industrial Park Block 70, Bao'an District, Shenzhen, China

Telephone: +86 (0) 755 3368 3668 Fax: +86 (0) 755 3368 3385

No tests were sub-contracted.

### 4.4 Deviation from Standards

None.

### 4.5 Abnormalities from Standard Conditions

None.

### 4.6 Other Information Requested by the Customer

None.

## 5 Technical Requirements Specification in EN 50665

### 5.1 General Description of Applied Standards

EN 50665 Generic standard to demonstrate the compliance of electronic and electrical apparatus with the basic restrictions related to human exposure to electromagnetic fields (0 Hz–300 GHz) is to demonstrate the compliance of apparatus with the basic restrictions or reference levels on exposure of the general public related to electric, magnetic, electromagnetic fields as well as induced and contact current

### 5.2 RF Exposure Evaluation

#### Limit

For equipment intended for use by the general public the relevant exposure restrictions in Council Recommendation 1999/519/EC shall be applied

Reference levels for electric, magnetic and electromagnetic fields  
(0 Hz to 300 GHz, unperturbed rms values)

Frequency range	E-field strength (V/m)	H-field strength (A/m)	B-field (μT)	Equivalent plane wave power density $S_{eq}$ (W/m <sup>2</sup> )
0-1 Hz	—	$3,2 \times 10^4$	$4 \times 10^4$	—
1-8 Hz	10 000	$3,2 \times 10^4/f^2$	$4 \times 10^4/f^2$	—
8-25 Hz	10 000	$4\,000/f$	$5\,000/f$	—
0,025-0,8 kHz	$250/f$	$4/f$	$5/f$	—
0,8-3 kHz	$250/f$	5	6,25	—
3-150 kHz	87	5	6,25	—
0,15-1 MHz	87	$0,73/f$	$0,92/f$	—
1-10 MHz	$87/f^{1/2}$	$0,73/f$	$0,92/f$	—
10-400 MHz	28	0,073	0,092	2
400-2 000 MHz	$1,375 f^{1/2}$	$0,0037 f^{1/2}$	$0,0046 f^{1/2}$	$f/200$
2-300 GHz	61	0,16	0,20	10

#### Notes:

1.  $f$  as indicated in the frequency range column.
2. For frequencies between 100 kHz and 10 GHz,  $S_{eq}$ ,  $E^2$ ,  $H^2$ , and  $B^2$  are to be averaged over any six-minute period.
3. For frequencies exceeding 10 GHz,  $S_{eq}$ ,  $E^2$ ,  $H^2$ , and  $B^2$  are to be averaged over any  $68/f^{1,05}$  -minute period ( $f$  in GHz).
4. No E-field value is provided for frequencies  $< 1$  Hz, which are effectively static electric fields. For most people the annoying perception of surface electric charges will not occur at field strengths less than 25 kV/m. Spark discharges causing stress or annoyance should be avoided.

## 5.2.1 Human Exposure Assessment

Exposure evaluation	
<p>Given</p> $E = \frac{\sqrt{30 \times TP}}{D}$ $D = \frac{\sqrt{30 \times TP}}{E}$	<p>Where:</p> <ul style="list-style-type: none"> <li>● E: E field Strength</li> <li>● TP: Transmitted power in watt</li> <li>● D: distance from the transmitting antenna in meter</li> </ul>

BLE:						
Frequency	EIRP (dBm)	TP (W)	D (m)	Electric Field(V/m)	Limit of Electric Field (V/m)	Result
2402	2.93	0.0020	0.2	1.21	61	Pass
2.4G WIFI:						
Frequency	EIRP (dBm)	TP (W)	D (m)	Electric Field(V/m)	Limit of Electric Field (V/m)	Result
2442	18.24	0.0667	0.2	7.07	61	Pass
5G WIFI:						
Frequency	EIRP (dBm)	TP (W)	D (m)	Electric Field(V/m)	Limit of Electric Field (V/m)	Result
5180	19.36	0.0863	0.2	8.05	61	Pass
LoRa:						
Frequency	EIRP (dBm)	TP (W)	D (m)	Electric Field(V/m)	Limit of Electric Field (V/m)	Result
868.3	15.07	0.0321	0.2	4.91	40.52	Pass
Conclusion:						
<p>→ <math>E = 8.05V/m</math> (max) is the E-Field strength when safety distance between the EUT and human body is 0.2m, which is below 61V/m as required 1999/519/EC Annex III Table 2</p> <p>→ <math>E = 4.91V/m</math> (max) is the E-Field strength when safety distance between the EUT and human body is 0.2m, which is below 40.52V/m as required 1999/519/EC Annex III Table 2</p>						

The test report is effective only with both signature and specialized stamp, The result(s) shown in this report refer only to the sample(s) tested. Without written approval of CTI, this report can't be reproduced except in full.

\*\*\* End of Report \*\*\*

## EMC TEST REPORT

**Product** : BeaglePlay  
**Trade mark** : Beagleboard.org  
**Model/Type reference** : BeaglePlay  
**Serial Number** : N/A  
**Ratings** : DC 5V  
**Report Number** : EED32P80002301  
**Date of Issue** : Feb. 21, 2023  
**Regulations** : See below

Test Standards	Results
<input checked="" type="checkbox"/> EN 55032:2015+A11:2020	PASS
<input checked="" type="checkbox"/> EN IEC 61000-3-2:2019+A1:2021	PASS
<input checked="" type="checkbox"/> EN 61000-3-3:2013+A2:2021	PASS
<input checked="" type="checkbox"/> EN 55035:2017+A11:2020	PASS

Prepared for:  
**Seed Technology Co., Ltd**  
**9F, Building G3, TCL International E city, Zhongshanyuan**  
**Road, Nanshan, Shenzhen, China.**

Prepared by:  
**Centre Testing International Group Co., Ltd.**  
**Hongwei Industrial Zone, Bao'an 70 District,**  
**Shenzhen, Guangdong, China**  
**TEL: +86-755-3368 3668**  
**FAX: +86-755-3368 3385**

Compiled by:

Wifi. Lei

Reviewed by:

Deng Binbin

Approved by:

Aaron Ma

Date of Issue:

Feb. 21, 2023

Aaron Ma

Check No.:5404030123





## TABLE OF CONTENTS

<b>1. GENERAL INFORMATION</b> .....	<b>4</b>
<b>2. TEST SUMMARY</b> .....	<b>5</b>
<b>3. TEST UNCERTAINTY</b> .....	<b>6</b>
<b>4. PRODUCT INFORMATION AND TEST SETUP</b> .....	<b>7</b>
4.1 PRODUCT INFORMATION .....	7
4.2 TEST SETUP CONFIGURATION .....	7
4.3 SUPPORT EQUIPMENT .....	7
<b>5. FACILITIES AND ACCREDITATIONS</b> .....	<b>8</b>
5.1 TEST FACILITY .....	8
5.2 TEST EQUIPMENT LIST .....	8
5.3 LABORATORY ACCREDITATIONS AND LISTINGS .....	10
<b>6. CONDUCTED DISTURBANCE</b> .....	<b>11</b>
6.1 LIMITS .....	11
6.2 BLOCK DIAGRAM OF TEST SETUP .....	11
6.3 TEST PROCEDURE .....	12
6.4 GRAPHS AND DATA .....	13
<b>7. RADIATED DISTURBANCE (RE)</b> .....	<b>17</b>
7.1 LIMITS .....	17
7.2 BLOCK DIAGRAM OF TEST SETUP .....	17
7.3 TEST PROCEDURE .....	18
7.4 GRAPHS AND DATA .....	19
<b>8. VOLTAGE FLUCTUATIONS &amp; FLICKER (FLICKER)</b> .....	<b>23</b>
8.1 LIMITS .....	23
8.2 BLOCK DIAGRAM OF TEST SETUP .....	23
8.3 TEST PROCEDURE .....	23
8.4 TEST RESULTS .....	23
<b>9. IMMUNITY TEST</b> .....	<b>25</b>
9.1 ELECTROSTATIC DISCHARGE (ESD) .....	26
9.1.1 TEST SPECIFICATION .....	26
9.1.2 BLOCK DIAGRAM OF TEST SETUP .....	26
9.1.3 TEST PROCEDURE .....	26
9.1.4 RESULTS & PERFORMANCE .....	27
9.2 RADIO-FREQUENCY ELECTROMAGNETIC FIELD IMMUNITY .....	28
9.2.1 TEST SPECIFICATION .....	28
9.2.2 BLOCK DIAGRAM OF TEST SETUP .....	28
9.2.3 TEST PROCEDURE .....	29
9.2.4 RESULTS & PERFORMANCE .....	29
9.3 ELECTRICAL FAST TRANSIENTS (EFT) .....	30
9.3.1 TEST SPECIFICATION .....	30
9.3.2 BLOCK DIAGRAM OF TEST SETUP .....	30
9.3.3 TEST PROCEDURE .....	31
9.3.4 RESULTS & PERFORMANCE .....	32
9.4 SURGES .....	33
9.4.1 TEST SPECIFICATION .....	33
9.4.2 BLOCK DIAGRAM OF TEST SETUP .....	33
9.4.3 TEST PROCEDURE .....	34
9.4.4 RESULTS & PERFORMANCE .....	34

9.5 RADIO-FREQUENCY CONTINUOUS CONDUCTED IMMUNITY .....	35
9.5.1 TEST SPECIFICATION .....	35
9.5.2 BLOCK DIAGRAM OF TEST SETUP .....	35
9.5.3 TEST PROCEDURE .....	36
9.5.4 RESULTS & PERFORMANCE .....	37
9.6 VOLTAGE DIPS AND INTERRUPTIONS .....	38
9.6.1 TEST SPECIFICATION .....	38
9.6.2 BLOCK DIAGRAM OF TEST SETUP .....	38
9.6.3 TEST PROCEDURE .....	38
9.6.4 RESULTS & PERFORMANCE .....	38
<b>APPENDIX 1 PHOTOGRAPHS OF TEST SETUP .....</b>	<b>39</b>
<b>APPENDIX 2 PHOTOGRAPHS OF PRODUCT .....</b>	<b>45</b>

*(Note: N/A means not applicable)*

## 1. GENERAL INFORMATION

**Applicant:** Seeed Technology Co., Ltd  
9F,Building G3,TCL International E city,Zhongshanyuan  
Road,Nanshan,Shenzhen,China.

**Manufacturer:** Seeed Technology Co., Ltd  
9F,Building G3,TCL International E city,Zhongshanyuan  
Road,Nanshan,Shenzhen,China.

**Factory :** Shenzhen Xinxian Technology Co; Limited  
F5, Building B17, Hengfeng Industrial City,No. 739 Zhoushi  
Rd, Baoan District, Shenzhen,Guangdong, P.R.C.F5, Building  
B17, Hengfeng Industrial City,No. 739 Zhoushi Rd, Baoan  
District, Shenzhen,Guangdong, P.R.C.

**EMC Directive:** 2014/30/EU

**Product:** BeaglePlay

**Trade mark:** Beagleboard.org

**Model/Type reference:** BeaglePlay

**Serial Number:** N/A

**Report Number:** EED32P800023

**State of Sample(s):** Normal

**Sample Received Date:** Jan. 03, 2023

**Sample tested Date:** Jan. 03, 2023 to Jan .06, 2023

Company Name and Address shown on Report, the sample(s) and sample Information was/ were provided by the applicant who should be responsible for the authenticity which CTI hasn't verified.

## 2. TEST SUMMARY

The Product has been tested according to the following specifications:

EMISSION		
Standard	Test Item	Test
EN 55032	Conducted disturbance	Yes
EN 55032	Radiated disturbance	Yes
EN IEC 61000-3-2	Harmonic current emission	N/A <sup>1</sup>
EN 61000-3-3	Voltage fluctuations & flicker	Yes

IMMUNITY (EN 55035)		
Standard	Test Item	Test
IEC 61000-4-2	Electrostatic discharge (ESD)	Yes
IEC 61000-4-3	Radio-frequency electromagnetic field Immunity	Yes
IEC 61000-4-4	Electrical fast transients (EFT)	Yes
IEC 61000-4-5	Surges	Yes
IEC 61000-4-6	Radio-frequency continuous conducted Immunity	Yes
IEC 61000-4-8	Power-frequency magnetic fields Immunity	N/A <sup>2</sup>
IEC 61000-4-11	Voltage dips and interruptions	Yes

Remark:

1. The Product belongs to Class A, and its power is less than 75W, so it deems to fulfil this standard without testing.
2. The Product doesn't contain any device susceptible to magnetic fields.

### 3. TEST UNCERTAINTY

Where relevant, the following test uncertainty levels have been estimated for tests performed on the Product as specified in CISPR 16-4-2. This uncertainty represents an expanded uncertainty expressed at approximately the 95% confidence level using a coverage factor of  $k=2$ .

Test item	Value (dB)
Conducted disturbance	3.1
Radiated disturbance (30MHz to 1GHz)	4.9
Radiated disturbance (1GHz to 6GHz)	4.7



## 4. PRODUCT INFORMATION AND TEST SETUP

### 4.1 PRODUCT INFORMATION

Ratings: DC 5V

The highest frequency of the internal sources of the EUT is:

- less than 108 MHz, the measurement shall only be made up to 1 GHz.
- between 108 MHz and 500 MHz, the measurement shall only be made up to 2 GHz.
- between 500 MHz and 1 GHz, the measurement shall only be made up to 5 GHz.
- above 1 GHz, the measurement shall be made up to 5 times the highest frequency or 6 GHz, whichever is less.

### 4.2 TEST SETUP CONFIGURATION

See test photographs attached in Appendix 1 for the actual connections between Product and support equipment.

### 4.3 SUPPORT EQUIPMENT

No.	Device Type	Brand	Model	Series No.	Data Cable	Power Cord
1.	Notebook	HP	C1260	---	---	---

#### Notes:

1. All the equipment/cables were placed in the worst-case configuration to maximize the emission during the test.
2. Grounding was established in accordance with the manufacturer's requirements and conditions for the intended use.

## 5. FACILITIES AND ACCREDITATIONS

### 5.1 TEST FACILITY

All test facilities used to collect the test data are located at Hongwei Industrial Zone, Bao'an 70 District, Shenzhen, Guangdong, China. The site and apparatus are constructed in conformance with the requirements of ANSI C63.4, CISPR 16-1-1 and other equivalent standards.

### 5.2 TEST EQUIPMENT LIST

**Instrumentation:** The following list contains equipments used at CTI for testing.

The calibrations of the measuring instruments, including any accessories that may effect such calibration, are checked frequently to assure their accuracy. Adjustments are made and correction factors applied in accordance with instructions contained in the manual for the measuring instrument.

#### Equipment used during the tests:

Shielding Room No. 3 - Conducted disturbance Test				
Equipment	Manufacturer	Model	Serial No.	Due Date
Receiver	R&S	ESCI	100435	04/14/2023
LISN	R&S	ENV216	100098	03/01/2023
ISN	TESEQ GmbH	ISN T800	30297	01/03/2023
ISN	R&S	NTFM 8158	NTFM 8158 #91	08/25/2023

3M Semi-anechoic Chamber (2)- Radiated emissions Test				
Equipment	Manufacturer	Model	Serial No.	Due Date
3M Chamber & Accessory Equipment	TDK	SAC-3	---	05/21/2025
Receiver	R&S	ESCI7	100938-003	10/13/2023
TRILOG Broadband Antenna	schwarzbeck	VULB 9163	401	10/15/2023
Multi device Controller	matur	NCD/070/10711 112	---	---
Horn Antenna	ETS-LINGREN	BBHA 9120D	9120D-1869	04/16/2024
Microwave Preamplifier	Agilent	8449B	3008A02425	06/22/2023
Loop Antenna	schwarzbeck	FMZB 1519B	1519B-075	04/16/2024
Loop Antenna	schwarzbeck	FMZB 1519B	1519B-076	04/16/2024

Shielding Room No. 2 - Flicker Test (EN 61000-3-3)				
Shielding Room No. 2 -Voltage dips and interruptions Test (IEC 61000-4-11)				
Equipment	Manufacturer	Model	Serial No.	Due Date
AC / DC programmable regulated power supply	EM TEST	Net Wave 30	P1613178144	06/12/2023
Single / three phase scintillation simulator	EM TEST	503N32	P1613178045	06/12/2023
Three phase harmonic and scintillation analyzer	EM TEST	DPA 503N	P154516605	06/12/2023
Voltage dip simulator	EM TEST	PFS 503N32.2	P1919229535	04/06/2023

Shielding Room No. 1 - ESD Test (IEC 61000-4-2)				
Equipment	Manufacturer	Model	Serial No.	Due Date
ESD Simulator	TESEQ	NSG437	1182	06/09/2023

3M Full-anechoic Chamber - Continuous RF electromagnetic radiated field disturbances Test (IEC 61000-4-3)				
Equipment	Manufacturer	Model	Serial No.	Due Date
3M Chamber & Accessory Equipment	ETS-LINDGREN	FACT-3	3510	05/19/2025
Signal Generator	R&S	SMB 100B	103084	05/19/2023
Power Probe	R&S	NRP6A	103342	07/12/2023
Power Probe	R&S	NRP6A	103343	07/13/2023
Power Amplifier	R&S	BBA 150-BC500	104743	06/06/2023
Power Amplifier	BONN	BLMA 1060-100	2113427	08/24/2023
RF switch	R&S	OSP220	102205	---
Directional coupler	BONN	BDC 1060-40/500	2128343-04	11/27/2023
Stacked double Log.-Per. Antenna	schwarzbeck	STLP 9128 E special	9128ES-110	---
Horn Antenna	schwarzbeck	STLP 9149	0776	05/21/2023

Shielding Room No. 2 - Voltage changes, voltage fluctuations and flicker Test (EN 61000-3-2) / (EN 61000-3-3)				
Equipment	Manufacturer	Model	Serial No.	Due Date
AC / DC programmable regulated power supply	EM TEST	Net Wave 30	P1613178144	06/12/2023
Single / three phase scintillation simulator	EM TEST	503N32	P1613178045	06/12/2023
Three phase harmonic and scintillation analyzer	EM TEST	DPA 503N	P1545166605	06/12/2023
Three-phase harmonic voltage flicker analyzer	California instruments	15003iX-CTS-400-411-413	/	05/05/2023
Flicker & Harmonic Tester	California instruments	300-CTS-230	1724A02035	05/05/2023
Power	California instruments	15003ix-CTS-400-413-EOS 3-LF	1726A00002	05/05/2023

Shielding Room No. 3 - EFT / Surges Test (IEC 61000-4-4) (IEC 61000-4-5)				
Equipment	Manufacturer	Model	Serial No.	Due Date
Compact Generator	EM-Test	UCS500M/6B	V0603101093	04/14/2023
Capacitive Clamp	EM-Test	C Clamp HFK	0306-43	02/23/2023

Shielding Room No. 2 - Continuous induced RF disturbances Test (IEC 61000-4-6)				
Equipment	Manufacturer	Model	Serial No.	Due Date
Conducted immunity test system	TESEQ	NSG 4070C-80	59089	08/26/2023
CDN	TESEQ	CDNE M210	59083	09/13/2023
CDN	TESEQ	CDNE M310	59040	09/13/2023
Attenuator	BIRD	75-A-MFN-06	0543	08/03/2024

### 5.3 LABORATORY ACCREDITATIONS AND LISTINGS

The measuring equipment utilized to perform the tests documented in this report has been calibrated once a year or in accordance with the manufacturer's recommendations, and is traceable under the ISO/IEC 17025 to international or national standards. Equipment has been calibrated by accredited calibration laboratories.

## 6. CONDUCTED DISTURBANCE

### 6.1 LIMITS

Requirements for conducted emissions from the AC mains power ports of Class B equipment

Frequency range (MHz)	Limits dB(μV)	
	Quasi-peak	Average
0,15 to 0,50	66 to 56	56 to 46
0,50 to 5	56	46
5 to 30	60	50

Requirements for conducted emissions from the Telecommunication ports of Class B equipment

Frequency Range (MHz)	Class B Limit (dBμV)	
	Quasi-peak	Average
0.15 to 0.50	84 to 74	74 to 64
0.50 to 30	74	64

NOTE 1: The limit decreases linearly with the logarithm of the frequency in the range 0.15 MHz to 0.50 MHz.

- NOTE:**
1. The lower limit shall apply at the transition frequencies.
  2. The limit decreases linearly with the logarithm of the frequency in the range 0.15 to 0.50 MHz.

### 6.2 BLOCK DIAGRAM OF TEST SETUP

For AC mains power port:

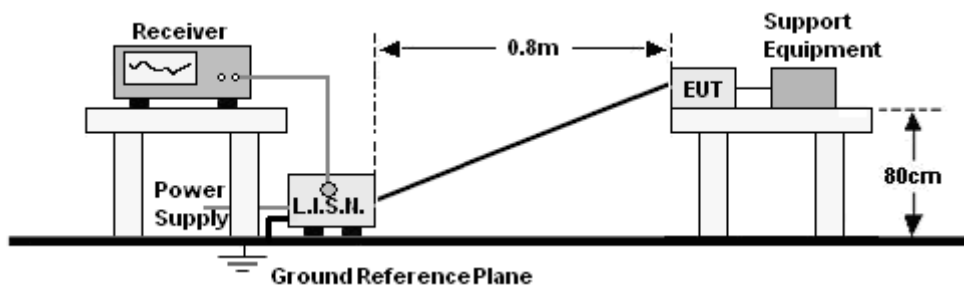

For Telecommunication port:

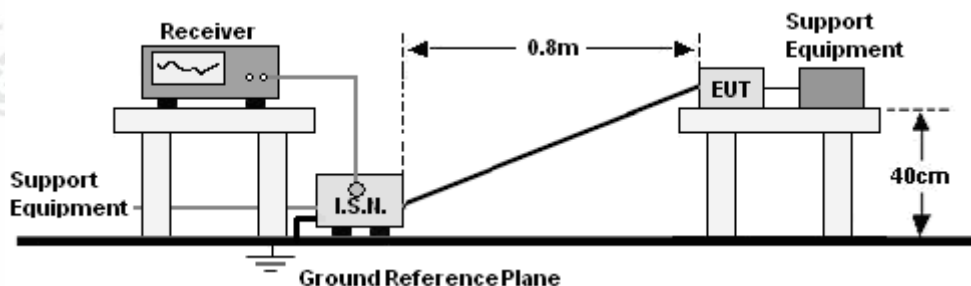



## 6.3 TEST PROCEDURE

### For AC mains power port:

- a. The Product was placed on a nonconductive table 0.8 m above the horizontal ground reference plane, and 0.4 m from the vertical ground reference plane, and connected to the main through Line Impedance Stability Network (L.I.S.N).
- b. The RBW of the receiver was set at 9 kHz in 150 kHz ~ 30MHz with Peak and AVG detector in Max Hold mode. Run the receiver's pre-scan to record the maximum disturbance generated from Product in all power lines in the full band.
- c. For each frequency whose maximum record was higher or close to limit, measure its QP and AVG values and record.

### For telecommunication port:

- a. The Product was placed on a non-conductive table 0.4m above the horizontal ground reference plane, and 0.4 m from the vertical ground reference plane, and connected to the telecommunication port through Impedance Stability Network (I.S.N).
- b. The RBW of the receiver was set at 9 kHz in 150 kHz ~ 30MHz with Peak and AVG detector in Max Hold mode. Run the receiver's pre-scan to record the maximum disturbance generated from Product in all power lines in the full band.
- c. For each frequency whose maximum record was higher or close to limit, measure its QP and AVG values and record.

## 6.4 GRAPHS AND DATA

For AC mains power port:

Product : BeaglePlay

Model/Type reference : BeaglePlay

Power : AC 230V/50Hz

Mode : Normal

Phase : L1

Temperature : 24°C

Humidity : 52%

Press : 101kPa

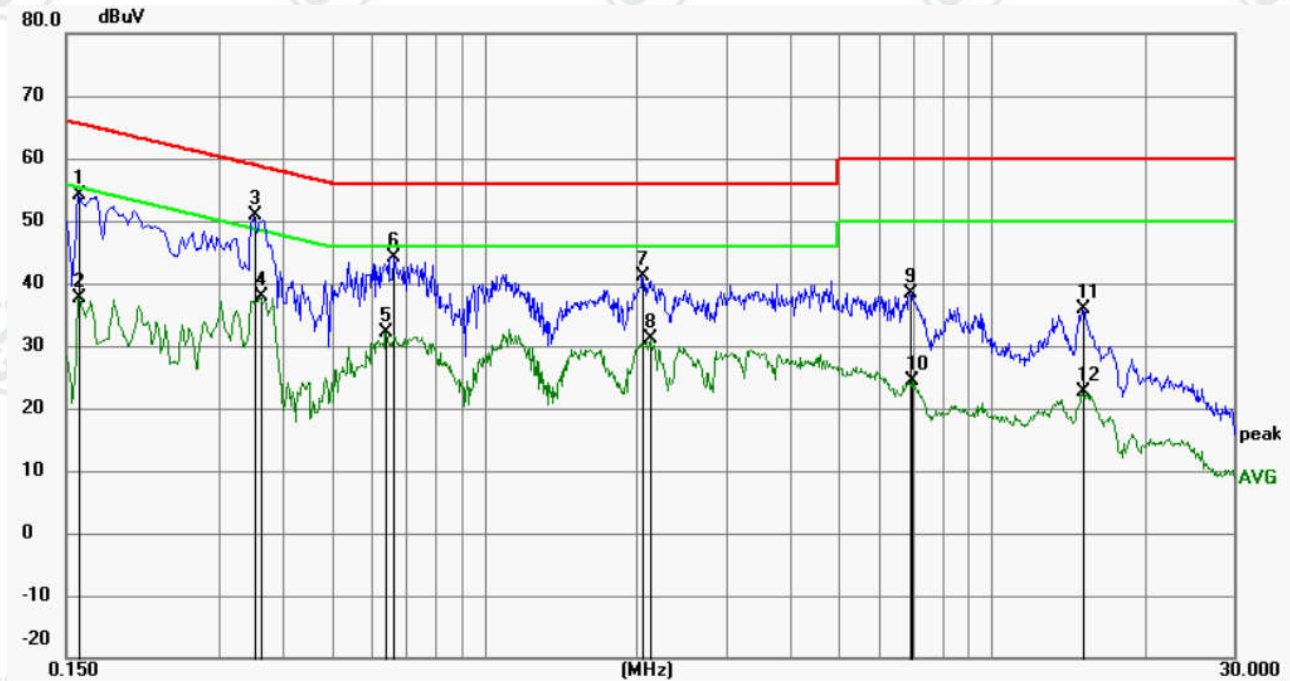

No.	Mk.	Freq. MHz	Reading Level dBuV	Correct Factor dB	Measure- ment dBuV	Limit dBuV	Margin dB	Detector	Comment
1		0.1590	44.28	9.87	54.15	65.52	-11.37	QP	
2		0.1590	27.85	9.87	37.72	55.52	-17.80	AVG	
3	*	0.3525	40.76	10.02	50.78	58.90	-8.12	QP	
4		0.3615	27.87	10.01	37.88	48.69	-10.81	AVG	
5		0.6405	22.07	9.99	32.06	46.00	-13.94	AVG	
6		0.6629	34.21	9.95	44.16	56.00	-11.84	QP	
7		2.0444	31.29	9.79	41.08	56.00	-14.92	QP	
8		2.1254	21.32	9.79	31.11	46.00	-14.89	AVG	
9		6.8910	28.62	9.79	38.41	60.00	-21.59	QP	
10		6.9540	14.50	9.79	24.29	50.00	-25.71	AVG	
11		15.1215	25.86	9.93	35.79	60.00	-24.21	QP	
12		15.1215	12.59	9.93	22.52	50.00	-27.48	AVG	

**Product** : BeaglePlay  
**Model/Type reference** : BeaglePlay  
**Power** : AC 230V/50Hz  
**Mode** : Normal  
**Phase** : N  
**Temperature** : 24°C  
**Humidity** : 52%  
**Press** : 101kPa

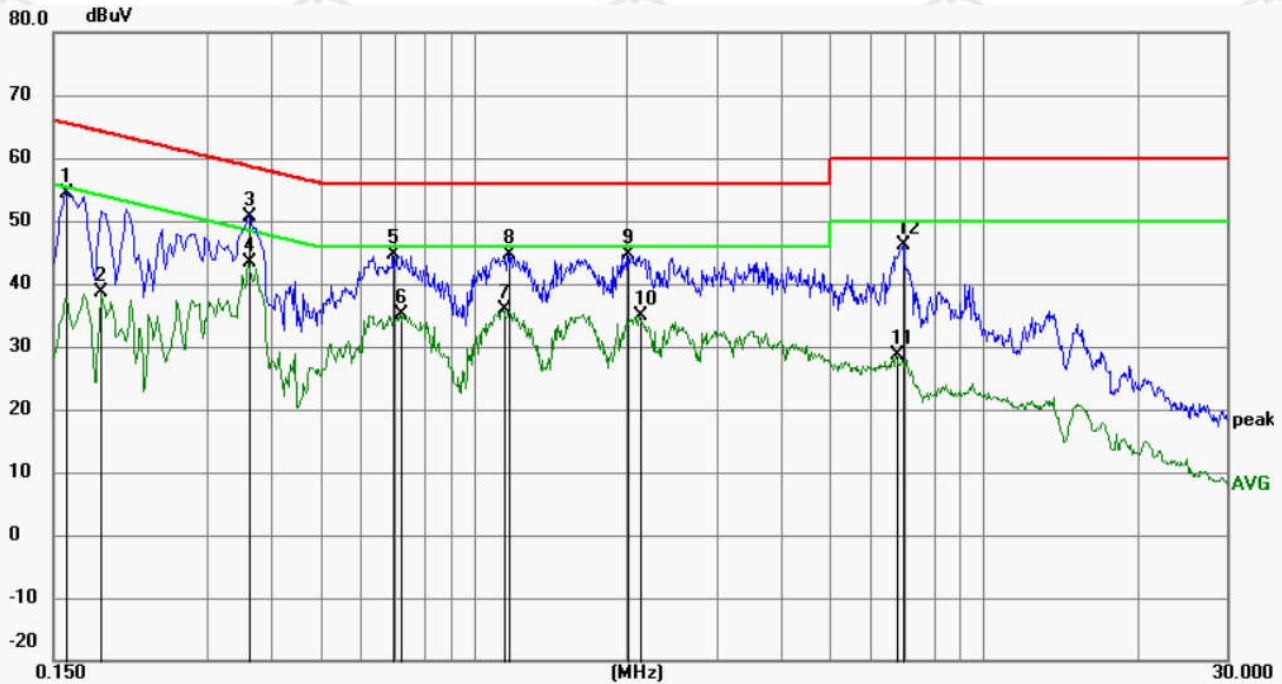

No.	Mk.	Freq. MHz	Reading Level dBuV	Correct Factor dB	Measure- ment dBuV	Limit dBuV	Margin dB	Detector	Comment
1		0.1590	44.54	9.87	54.41	65.52	-11.11	QP	
2		0.1860	28.65	9.87	38.52	54.21	-15.69	AVG	
3		0.3615	40.74	10.01	50.75	58.69	-7.94	QP	
4	*	0.3615	33.33	10.01	43.34	48.69	-5.35	AVG	
5		0.6944	34.85	9.89	44.74	56.00	-11.26	QP	
6		0.7169	25.25	9.87	35.12	46.00	-10.88	AVG	
7		1.1444	26.03	9.82	35.85	46.00	-10.15	AVG	
8		1.1669	34.90	9.82	44.72	56.00	-11.28	QP	
9		2.0039	34.81	9.79	44.60	56.00	-11.40	QP	
10		2.1164	24.99	9.79	34.78	46.00	-11.22	AVG	
11		6.7515	18.82	9.79	28.61	50.00	-21.39	AVG	
12		6.9630	36.26	9.79	46.05	60.00	-13.95	QP	

**Telecommunication ports:**

**Product** : BeaglePlay  
**Model/Type reference** : BeaglePlay  
**Power** : AC230V/50Hz  
**Mode** : Normal  
**Note** : 100Mb/s  
**Temperature** : 24°C  
**Humidity** : 52%  
**Press** : 101kPa

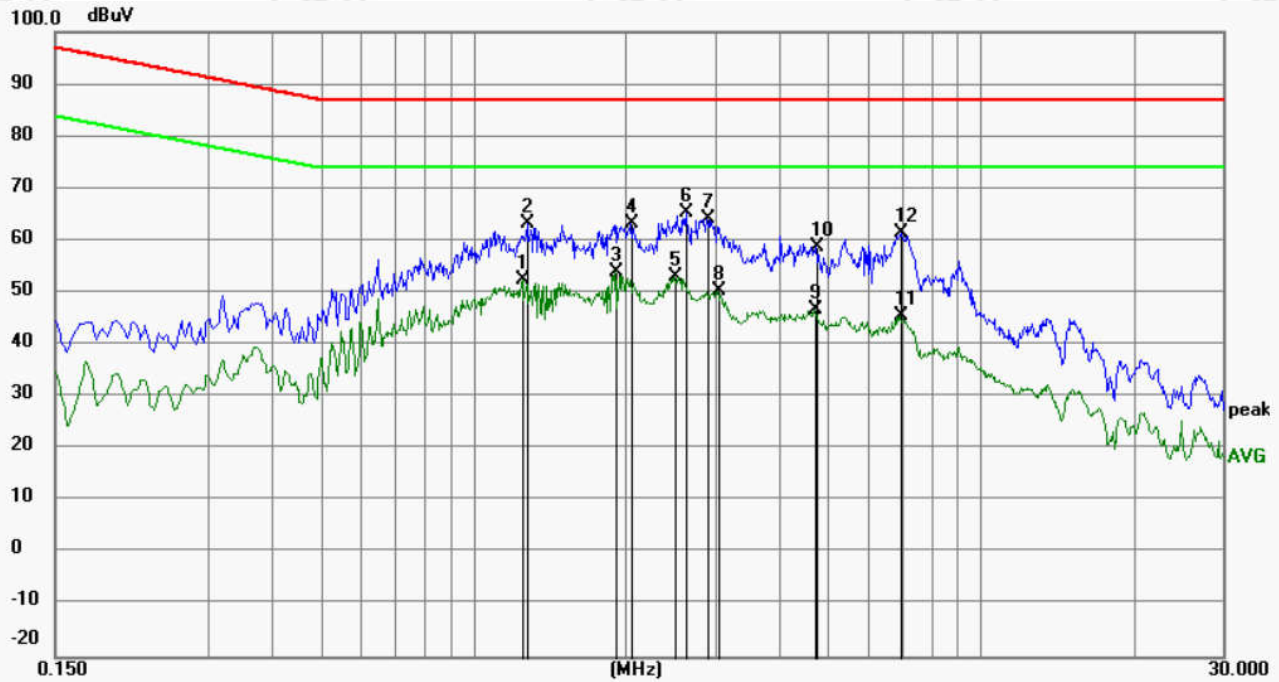

No.	Mk.	Freq. MHz	Reading Level dBuV	Correct Factor dB	Measurement dBuV	Limit dBuV	Margin dB	Detector	Comment
1		1.2525	42.81	9.67	52.48	74.00	-21.52	AVG	
2		1.2795	53.66	9.67	63.33	87.00	-23.67	QP	
3	*	1.9005	44.07	9.81	53.88	74.00	-20.12	AVG	
4		2.0445	53.57	9.83	63.40	87.00	-23.60	QP	
5		2.4990	43.25	9.80	53.05	74.00	-20.95	AVG	
6		2.6250	55.43	9.79	65.22	87.00	-21.78	QP	
7		2.8905	54.37	9.77	64.14	87.00	-22.86	QP	
8		3.0300	40.70	9.76	50.46	74.00	-23.54	AVG	
9		4.7085	36.97	9.65	46.62	74.00	-27.38	AVG	
10		4.7310	49.24	9.65	58.89	87.00	-28.11	QP	
11		6.9315	35.98	9.56	45.54	74.00	-28.46	AVG	
12		6.9720	51.86	9.56	61.42	87.00	-25.58	QP	



**Product** : BeaglePlay  
**Model/Type reference** : BeaglePlay  
**Power** : AC230V/50Hz  
**Mode** : Normal  
**Note** : 1000Mb/s  
**Temperature** : 24°C  
**Humidity** : 52%  
**Press** : 101kPa

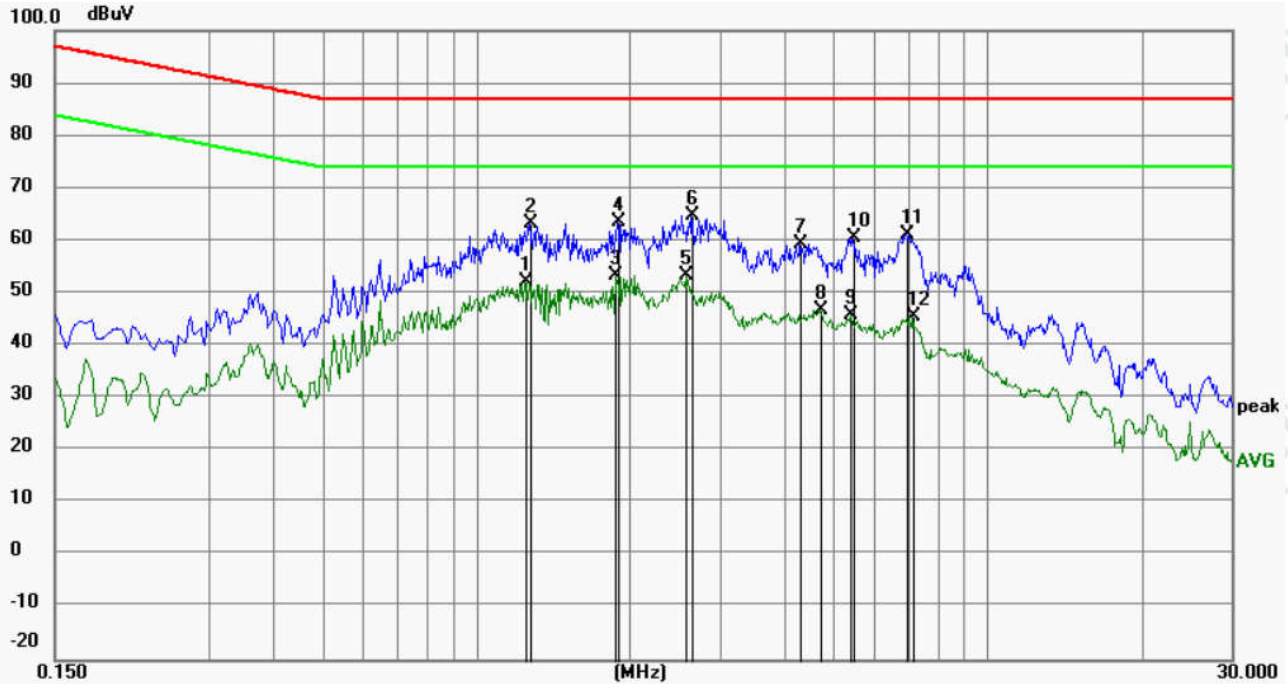

No.	Mk.	Freq. MHz	Reading Level dBuV	Correct Factor dB	Measure- ment dBuV	Limit dBuV	Margin dB	Detector	Comment
1		1.2480	42.56	9.66	52.22	74.00	-21.78	AVG	
2		1.2750	53.73	9.67	63.40	87.00	-23.60	QP	
3		1.8735	43.48	9.80	53.28	74.00	-20.72	AVG	
4		1.8960	53.67	9.81	63.48	87.00	-23.52	QP	
5	*	2.5710	43.54	9.79	53.33	74.00	-20.67	AVG	
6		2.6475	55.04	9.79	64.83	87.00	-22.17	QP	
7		4.2990	49.58	9.68	59.26	87.00	-27.74	QP	
8		4.7040	37.01	9.65	46.66	74.00	-27.34	AVG	
9		5.4015	36.10	9.62	45.72	74.00	-28.28	AVG	
10		5.4600	50.87	9.61	60.48	87.00	-26.52	QP	
11		6.9225	51.54	9.56	61.10	87.00	-25.90	QP	
12		7.1655	35.92	9.56	45.48	74.00	-28.52	AVG	

**Remark:**

1. Margin=Measurement-Limit.
2. Measurement=Reading\_Level+Correct Factor.
3. Correct Factor=Cable Factor+Lisn Factor.
4. Through Pre-scan, AC230V/50Hz of Adapter 1 was the worst case; only the worst case was in the report.



## 7. RADIATED DISTURBANCE (RE)

### 7.1 LIMITS

Requirements for radiated emissions at frequencies up to 1 GHz  
for Class B equipment

Frequency (MHz)	Quasi-peak limits at 3m dB( $\mu$ V/m)
30-230	40
230-1000	47

Frequency (GHz)	limit above 1GHz at 3m dB( $\mu$ V/m)	
	Average	peak
1-3	50	70
3-6	54	74

### 7.2 BLOCK DIAGRAM OF TEST SETUP

30MHz ~ 1GHz:

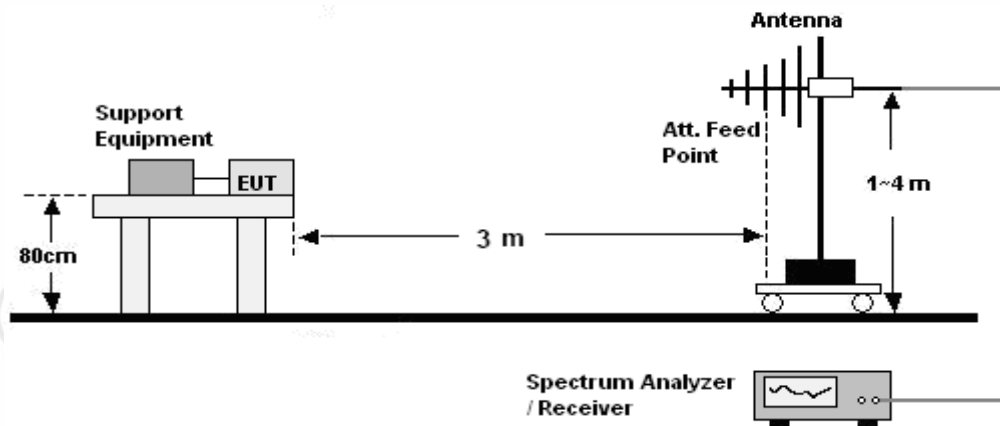

Above 1GHz:

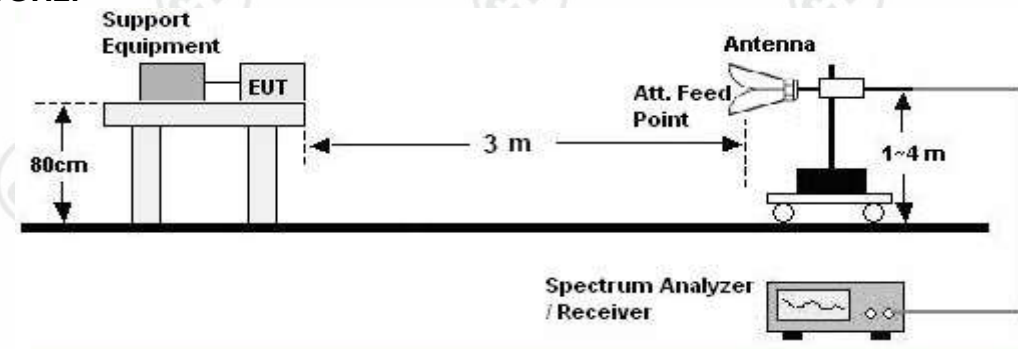

## 7.3 TEST PROCEDURE

### 30MHz ~ 1GHz:

- a. The Product was placed on the non-conductive turntable 0.8 m above the ground at a chamber.
- b. Set the spectrum analyzer/receiver in Peak detector, Max Hold mode, and 120 kHz RBW. Record the maximum field strength of all the pre-scan process in the full band when the antenna is varied between 1~4 m in both horizontal and vertical, and the turntable is rotated from 0 to 360 degrees.
- c. For each frequency whose maximum record was higher or close to limit, measure its QP value: vary the antenna's height and rotate the turntable from 0 to 360 degrees to find the height and degree where Product radiated the maximum emission, then set the test frequency analyzer/receiver to QP Detector and specified bandwidth with Maximum Hold Mode, and record the maximum value.

### Above 1GHz:

- a. The Product was placed on the non-conductive turntable 0.8m above the ground at a chamber.
- b. Set the spectrum analyzer/receiver in Peak detector, Max Hold mode, and 1MHz RBW. Record the maximum field strength of all the pre-scan process in the full band when the antenna is varied in both horizontal and vertical, and the turntable is rotated from 0 to 360 degrees.
- c. For each frequency whose maximum record was higher or close to limit, measure its AV value: rotate the turntable from 0 to 360 degrees to find the degree where Product radiated the maximum emission, then set the test frequency analyzer/receiver to AV value and specified bandwidth with Maximum Hold Mode, and record the maximum value.

## 7.4 GRAPHS AND DATA

30MHz ~ 1GHz:

<b>Product</b>	: BeaglePlay	<b>Temperature</b>	: 22°C
<b>Model/Type reference</b>	: BeaglePlay	<b>Humidity</b>	: 53%
<b>Power</b>	: AC 230V/50Hz	<b>Press</b>	: 101kPa
<b>Mode</b>	: Normal		
<b>Polarization</b>	: Horizontal		

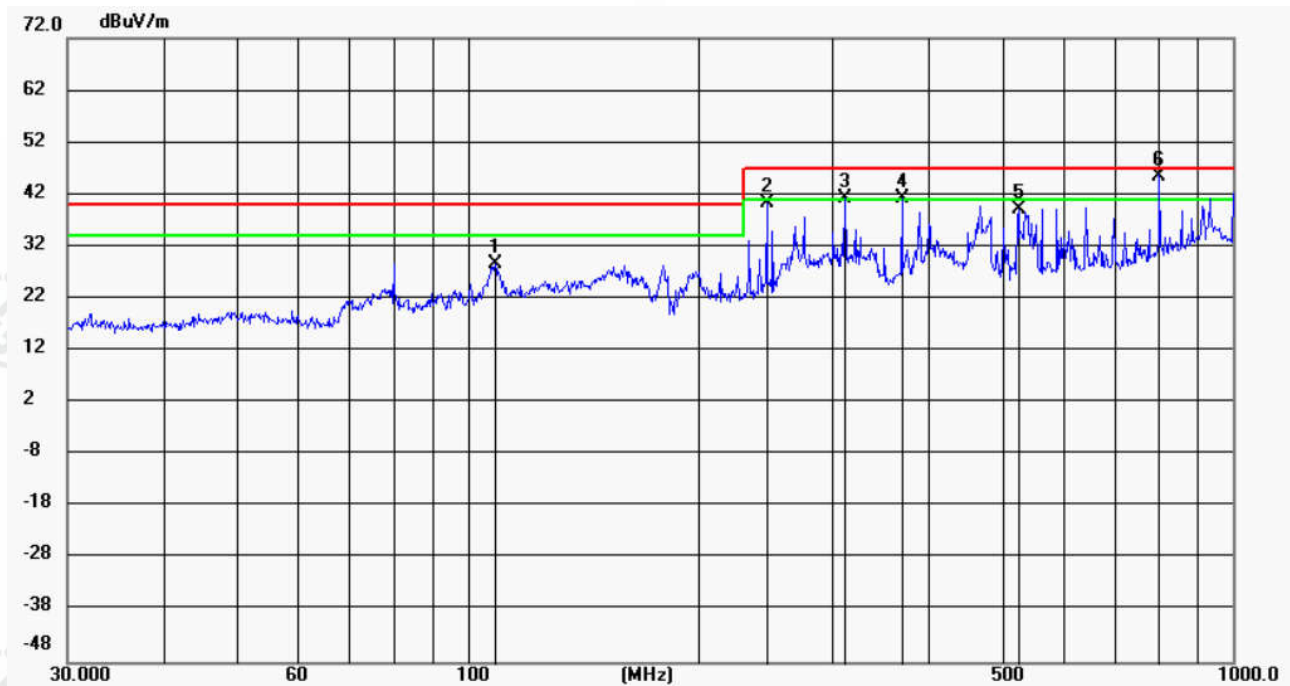

No.	Mk.	Freq. MHz	Reading Level dBuV	Correct Factor dB	Measure- ment dBuV/m	Limit dBuV/m	Margin dB	Antenna Height cm	Table Degree	Comment
1		108.6470	15.19	13.54	28.73	40.00	-11.27	QP 100	191	
2		245.9508	25.63	14.71	40.34	47.00	-6.66	QP 100	262	
3	!	311.0865	24.33	17.01	41.34	47.00	-5.66	QP 100	60	
4	!	369.4045	23.38	17.85	41.23	47.00	-5.77	QP 100	161	
5		524.5540	17.99	21.21	39.20	47.00	-7.80	QP 200	356	
6	*	801.7863	20.16	25.34	45.50	47.00	-1.50	QP 100	357	

**Product** : BeaglePlay  
**Model/Type reference** : BeaglePlay  
**Power** : AC 230V/50Hz  
**Mode** : Normal  
**Polarization** : Vertical  
**Temperature** : 22°C  
**Humidity** : 53%  
**Press** : 101kPa

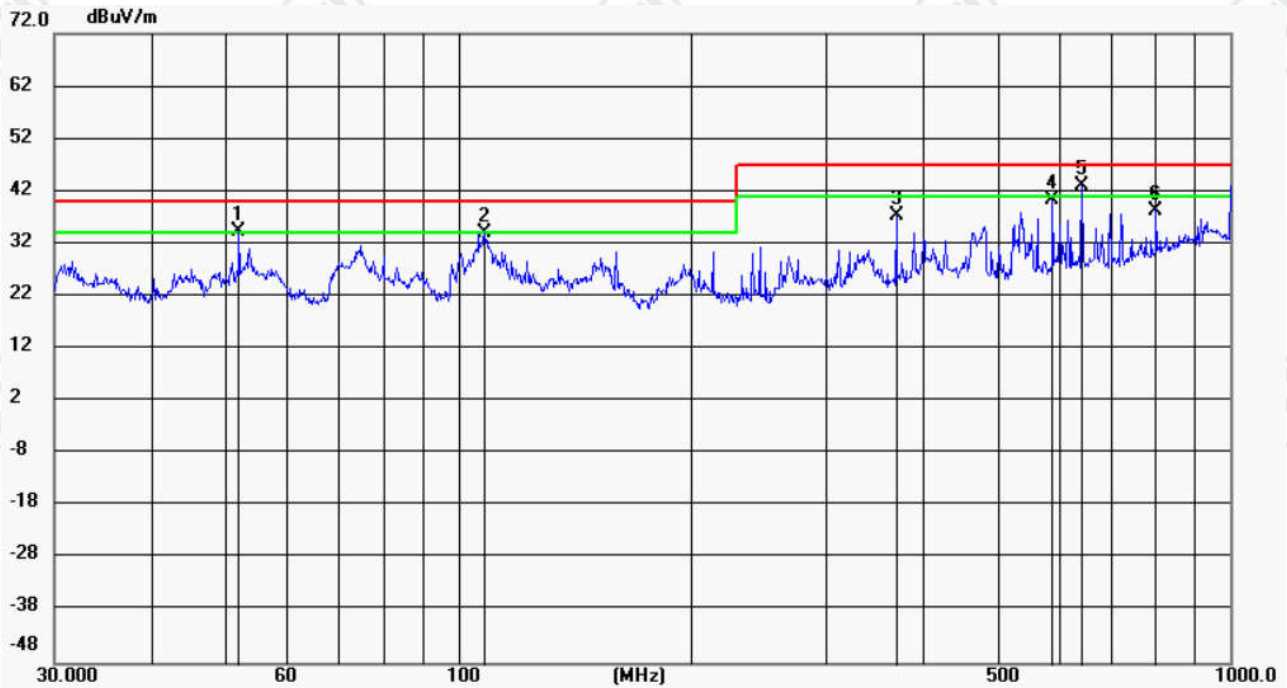

No.	Mk.	Freq. MHz	Reading Level dBuV	Correct Factor dB	Measure- ment dBuV/m	Limit dBuV/m	Margin dB	Detector	Antenna Height cm	Table Degree	Comment
1	!	52.0251	19.94	14.55	34.49	40.00	-5.51	QP	100	230	
2	!	108.2666	20.52	13.55	34.07	40.00	-5.93	QP	100	356	
3		369.4047	19.47	17.85	37.32	47.00	-9.68	QP	100	356	
4		588.9050	17.99	22.42	40.41	47.00	-6.59	QP	200	89	
5	*	642.8612	20.22	22.86	43.08	47.00	-3.92	QP	100	331	
6		801.7863	13.06	25.34	38.40	47.00	-8.60	QP	100	38	



## Above 1GHz:

**Product** : BeaglePlay  
**Model/Type reference** : BeaglePlay  
**Power** : AC 230V/50Hz  
**Mode** : Normal  
**Polarization** : Horizontal  
**Temperature** : 22°C  
**Humidity** : 53%  
**Press** : 101kPa

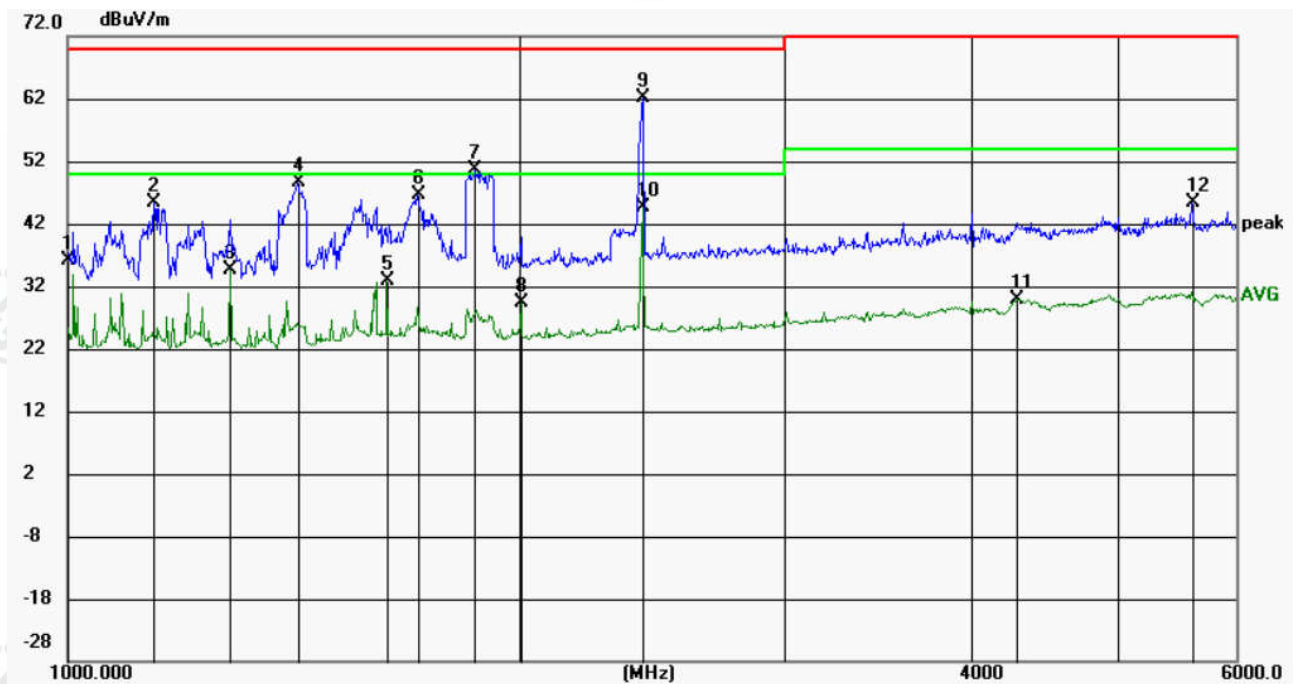

No.	Mk.	Freq. MHz	Reading Level dBuV	Correct Factor dB	Measure- ment dBuV/m	Limit dBuV/m	Margin dB	Antenna Height cm	Table Degree	Comment
1		1000.0000	50.87	-14.86	36.01	50.00	-13.99	AVG	100	340
2		1141.782	59.50	-14.12	45.38	70.00	-24.62	peak	100	302
3		1282.812	48.24	-13.66	34.58	50.00	-15.42	AVG	200	348
4		1423.298	61.90	-13.20	48.70	70.00	-21.30	peak	200	8
5		1630.930	45.24	-12.38	32.86	50.00	-17.14	AVG	100	302
6		1708.706	58.68	-12.06	46.62	70.00	-23.38	peak	100	24
7		1868.851	62.10	-11.59	50.51	70.00	-19.49	peak	100	24
8		2004.115	40.49	-11.00	29.49	50.00	-20.51	AVG	100	62
9		2414.629	71.84	-9.63	62.21	70.00	-7.79	peak	200	356
10	*	2414.629	54.38	-9.63	44.75	50.00	-5.25	AVG	200	356
11		4291.775	33.14	-3.16	29.98	54.00	-24.02	AVG	100	124
12		5605.076	46.65	-1.37	45.28	74.00	-28.72	peak	200	159



**Product** : BeaglePlay  
**Model/Type reference** : BeaglePlay  
**Power** : AC 230V/50Hz  
**Mode** : Normal  
**Polarization** : Vertical  
**Temperature** : 22°C  
**Humidity** : 53%  
**Press** : 101kPa

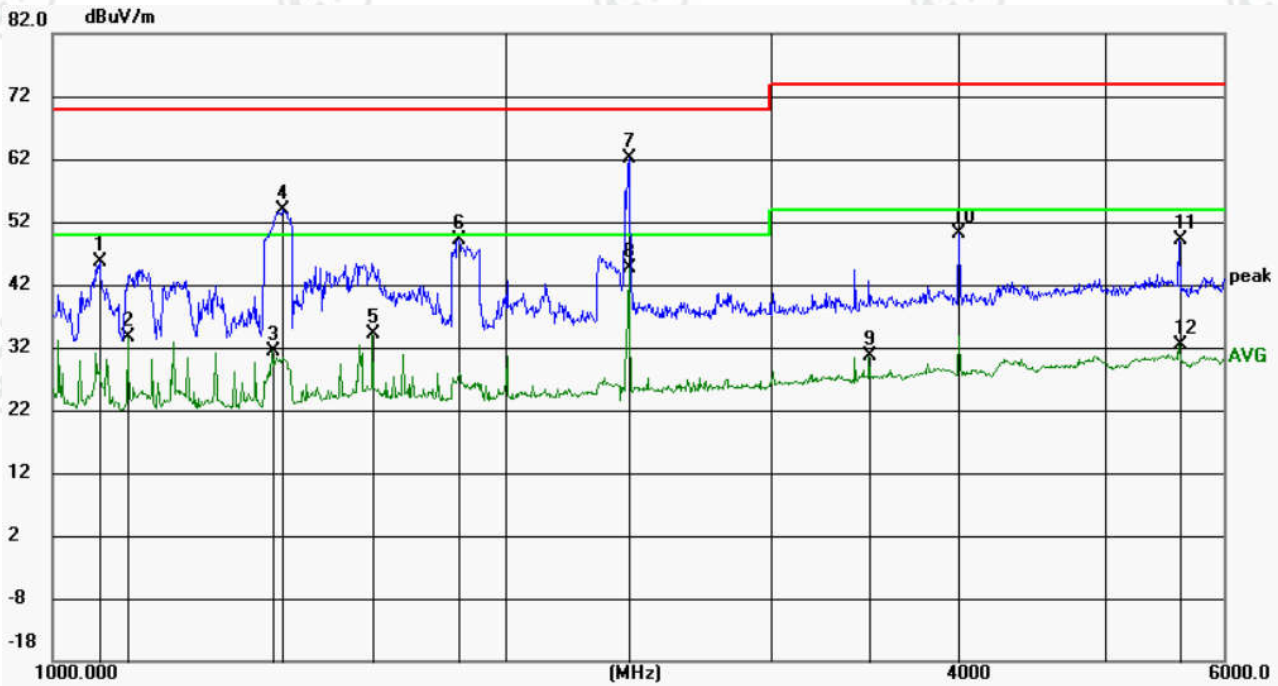

No.	Mk.	Freq.	Reading Level	Correct Factor	Measurement	Limit	Margin	Antenna Height	Table Degree	
		MHz	dBuV	dB	dBuV/m	dBuV/m	dB	cm	degree	Comment
1		1074.301	59.96	-14.44	45.52	70.00	-24.48	100	184	peak
2		1121.506	47.99	-14.25	33.74	50.00	-16.26	100	19	AVG
3		1398.023	44.60	-13.31	31.29	50.00	-18.71	200	4	AVG
4		1420.750	67.07	-13.21	53.86	70.00	-16.14	200	4	peak
5		1630.930	46.50	-12.38	34.12	50.00	-15.88	100	356	AVG
6		1858.833	60.61	-11.60	49.01	70.00	-20.99	200	314	peak
7		2414.629	71.85	-9.63	62.22	70.00	-7.78	200	137	peak
8	*	2414.629	54.25	-9.63	44.62	50.00	-5.38	200	137	AVG
9		3486.354	36.56	-6.04	30.52	54.00	-23.48	100	336	AVG
10		4002.110	55.42	-5.31	50.11	74.00	-23.89	200	302	peak
11		5605.076	50.48	-1.37	49.11	74.00	-24.89	100	323	peak
12		5605.076	33.81	-1.37	32.44	54.00	-21.56	100	323	AVG

**Note:**

1. Margin=Measurement-Limit.
2. Measurement=Reading\_Level+Correct Factor.
3. Correct Factor=Ant Factor+Cable loss.
4. Through Pre-scan, AC230V/50Hz of Adapter 1 was the worst case; only the worst case was in the report.

## 8. VOLTAGE FLUCTUATIONS & FLICKER (FLICKER)

### 8.1 LIMITS

Please refer to EN 61000-3-3:2013+A1:2019 Clause 5.

### 8.2 BLOCK DIAGRAM OF TEST SETUP

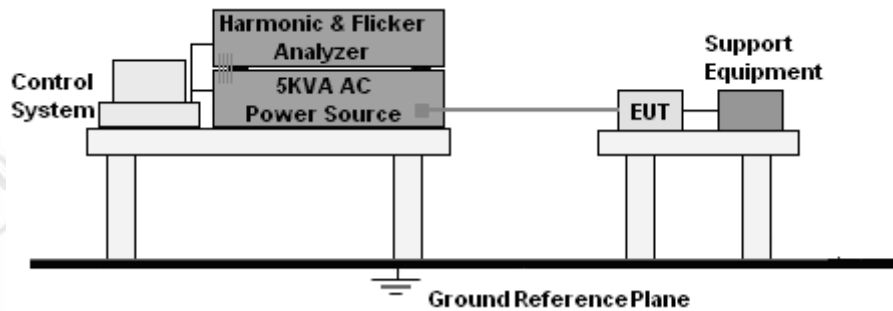

### 8.3 TEST PROCEDURE

- The Product was placed on the top of a non-conductive table above the ground and operated to produce the most unfavorable sequence of voltage changes under normal operating conditions.
- During the flick test, the measure time shall include that part of whole operation cycle in which the Product produce the most unfavorable sequence of voltage changes. The observation period for short-term flicker indicator is 10 minutes and the observation period for long-term flicker indicator is 2 hours.

### 8.4 TEST RESULTS

<b>Product</b>	: BeaglePlay	<b>Temperature</b>	: 22°C
<b>Model/Type reference</b>	: BeaglePlay	<b>Humidity</b>	: 53%
<b>Power</b>	: AC 230V/50Hz		
<b>Mode</b>	: Normal		
<b>Press</b>	: 101kPa		

**Test Result: Pass**

**Status: Test Completed**

**Pst and limit line**

**European Limits**



**Plt and limit line**

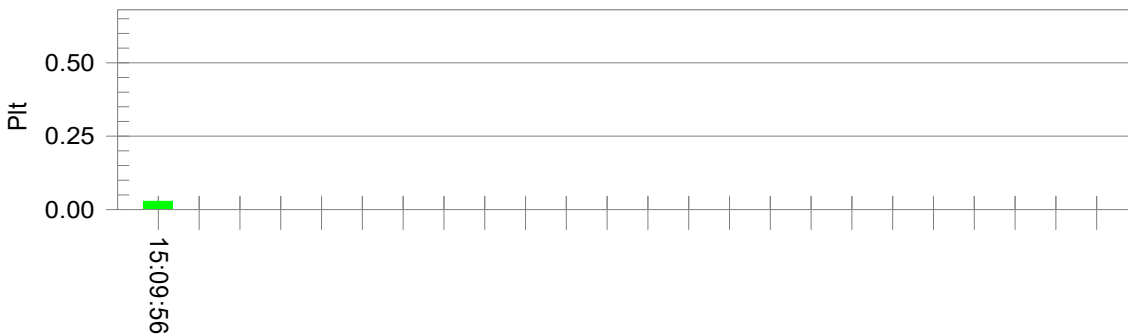

**Parameter values recorded during the test:**

Vrms at the end of test (Volt):	229.36		
T-max (mS):	0	Test limit (mS):	500.0 Pass
Highest dc (%):	0.00	Test limit (%):	3.30 Pass
Highest dmax (%):	0.00	Test limit (%):	4.00 Pass
Highest Pst (10 min. period):	0.064	Test limit:	1.000 Pass
Highest Plt (2 hr. period):	0.028	Test limit:	0.650 Pass

## 9. IMMUNITY TEST

<b>General Performance Criteria</b>	
<b>Product Standard</b>	<b>EN 55035:2017+A11:2020 clause 8</b>
<b>CRITERION A</b>	<p>The equipment shall continue to operate as intended without operator intervention. No degradation of performance, loss of function or change of operating state is allowed below a performance level specified by the manufacturer when the equipment is used as intended. The performance level may be replaced by a permissible loss of performance. If the minimum performance level or the permissible performance loss is not specified by the manufacturer, then either of these may be derived from the product description and documentation, and by what the user may reasonably expect from the equipment if used as intended.</p>
<b>CRITERION B</b>	<p>During the application of the disturbance, degradation of performance is allowed. However, no unintended change of actual operating state or stored data is allowed to persist after the test.</p> <p>After the test, the equipment shall continue to operate as intended without operator intervention; no degradation of performance or loss of function is allowed, below a performance level specified by the manufacturer, when the equipment is used as intended. The performance level may be replaced by a permissible loss of performance.</p> <p>If the minimum performance level (or the permissible performance loss), or recovery time, is not specified by the manufacturer, then either of these may be derived from the product description and documentation, and by what the user may reasonably expect from the equipment if used as intended.</p>
<b>CRITERION C</b>	<p>Loss of function is allowed, provided the function is self-recoverable, or can be restored by the operation of the controls by the user in accordance with the manufacturer's instructions. A reboot or re-start operation is allowed.</p> <p>Information stored in non-volatile memory, or protected by a battery backup, shall not be lost.</p>

## 9.1 ELECTROSTATIC DISCHARGE (ESD)

### 9.1.1 TEST SPECIFICATION

Basic Standard	: EN 55035 & IEC 61000-4-2
Test Port	: Enclosure port
Discharge Impedance	: 330 ohm / 150 pF
Discharge Mode	: Single Discharge
Discharge Period	: one second between each discharge

### 9.1.2 BLOCK DIAGRAM OF TEST SETUP

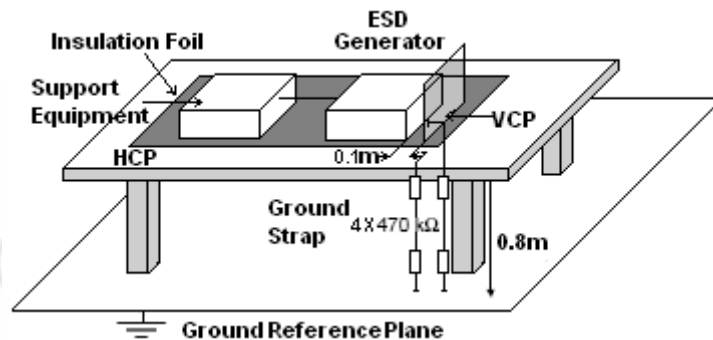

### 9.1.3 TEST PROCEDURE

- Electrostatic discharges were applied only to those points and surfaces of the Product that are accessible to users during normal operation.
- The test was performed with at least ten single discharges on the pre-selected points in the most sensitive polarity.
- The time interval between two successive single discharges was at least 1 second.
- The ESD generator was held perpendicularly to the surface to which the discharge was applied and the return cable was at least 0.2 meters from the Product.
- Contact discharges were applied to the non-insulating coating, with the pointed tip of the generator penetrating the coating and contacting the conducting substrate.
- Air discharges were applied with the round discharge tip of the discharge electrode approaching the Product as fast as possible (without causing mechanical damage) to touch the Product. After each discharge, the ESD generator was removed from the Product and re-triggered for a new single discharge. The test was repeated until all discharges were complete.
- At least ten single discharges (in the most sensitive polarity) were applied to the Horizontal Coupling Plane at points on each side of the Product. The ESD generator was positioned vertically at a distance of 0.1 meters from the Product with the discharge electrode touching the HCP.
- At least ten single discharges (in the most sensitive polarity) were applied to the center of one vertical edge of the Vertical Coupling Plane in sufficiently different positions that the four faces of the Product were completely illuminated. The VCP (dimensions 0.5m x 0.5m) was placed vertically to and 0.1 meters from the Product.



## 9.1.4 RESULTS & PERFORMANCE

**Product** : BeaglePlay  
**Model/Type reference** : BeaglePlay  
**Power** : AC 110V/60Hz  
          : AC 230V/50Hz  
**Temperature** : 22°C  
**Mode** : Normal  
**Humidity** : 53%  
**Press** : 101kPa

Discharge Method	Discharge Position	Voltage (±kV)	Min. No. of Discharge per polarity (Each Point)	Required Level	Performance Criterion
Contact Discharge	Conductive Surfaces	4	10	B	A
	Indirect Discharge HCP	4	10	B	A
	Indirect Discharge VCP	4	10	B	A
Air Discharge	Slots, Apertures, and Insulating Surfaces	8	10	B	A

## 9.2 RADIO-FREQUENCY ELECTROMAGNETIC FIELD IMMUNITY

### 9.2.1 TEST SPECIFICATION

Basic Standard	: EN 55035 & IEC 61000-4-3
Test Port	: Enclosure port
Step Size	: 1%
Modulation	: 1kHz, 80% AM
Dwell Time	: 1 second
Polarization	: Horizontal & Vertical

### 9.2.2 BLOCK DIAGRAM OF TEST SETUP

80-1000MHz:

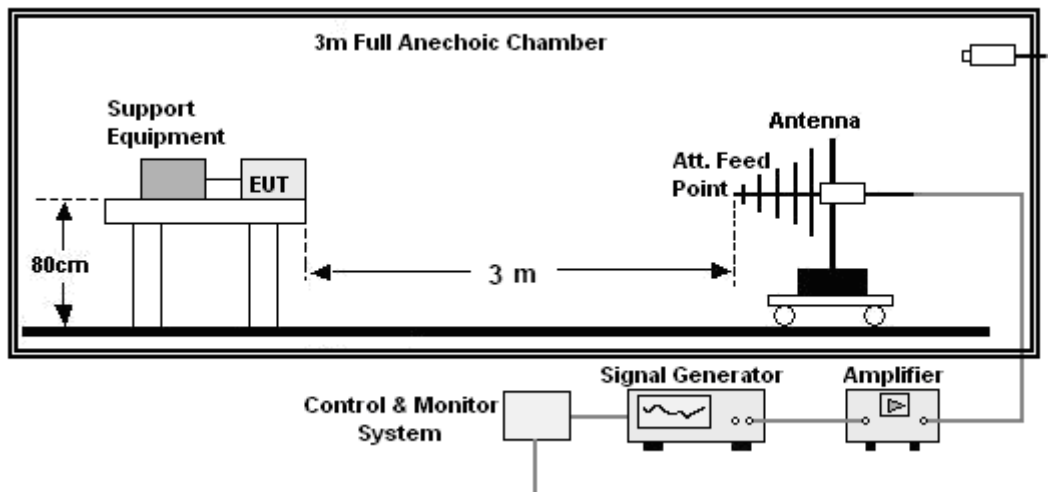

1000-6000MHz:

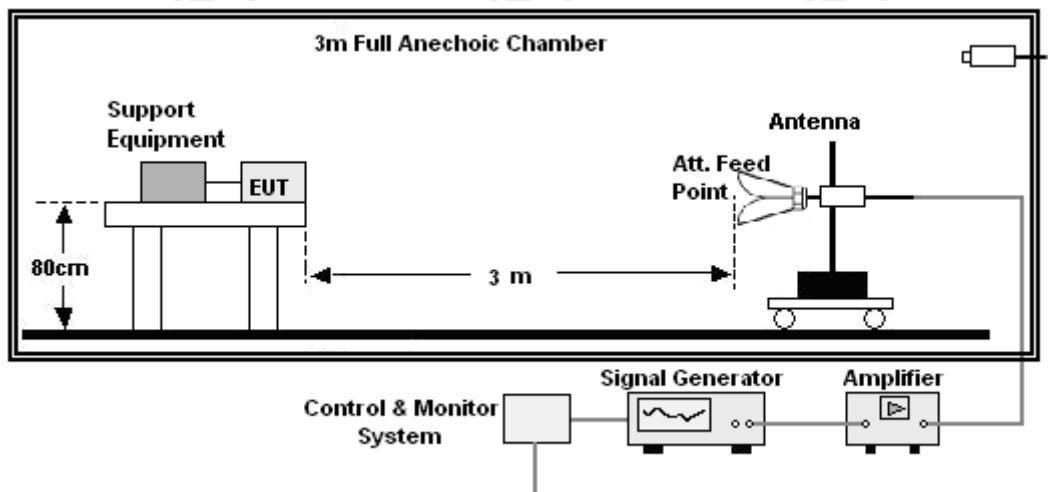

**9.2.3 TEST PROCEDURE**

- a. The testing was performed in a fully-anechoic chamber. The transmit antenna was located at a distance of 3 meters from the Product.
- b. The frequency range is swept from 80MHz to 1000MHz, 1800MHz, 2600MHz, 3500MHz, 5000MHz with the signal 80% amplitude modulated with a 1 kHz sine wave. The rate of sweep did not exceed  $1.5 \times 10^{-3}$  decade/s. Where the frequency range is swept incrementally, the step size was 1%.
- c. The test was performed with the Product exposed to both vertically and horizontally polarized fields on each of the four sides.

**9.2.4 RESULTS & PERFORMANCE**

<b>Product</b>	: BeaglePlay		
<b>Model/Type reference</b>	: BeaglePlay		
<b>Power</b>	: AC 110V/60Hz AC 230V/50Hz	<b>Temperature</b>	: 22°C
<b>Mode</b>	: Normal	<b>Humidity</b>	: 53%
<b>Press</b>	: 101kPa		

Frequency (MHz)	Position	Field Strength (V/m)	Required Level	Performance Criterion
80 - 1000	Front, Right, Back, Left	3	A	A
1800	Front, Right, Back, Left	3	A	A
2600	Front, Right, Back, Left	3	A	A
3500	Front, Right, Back, Left	3	A	A
5000	Front, Right, Back, Left	3	A	A

## 9.3 ELECTRICAL FAST TRANSIENTS (EFT)

### 9.3.1 TEST SPECIFICATION

<b>Basic Standard</b>	: EN 55035 & IEC 61000-4-4
<b>Test Port</b>	: Normal & LAN port
<b>Impulse Frequency</b>	: 5kHz
<b>Impulse Wave-shape</b>	: 5/50 ns
<b>Burst Duration</b>	: 15 ms
<b>Burst Period</b>	: 300 ms
<b>Test Duration</b>	: 2 minute per polarity

### 9.3.2 BLOCK DIAGRAM OF TEST SETUP

For input AC mains power port:

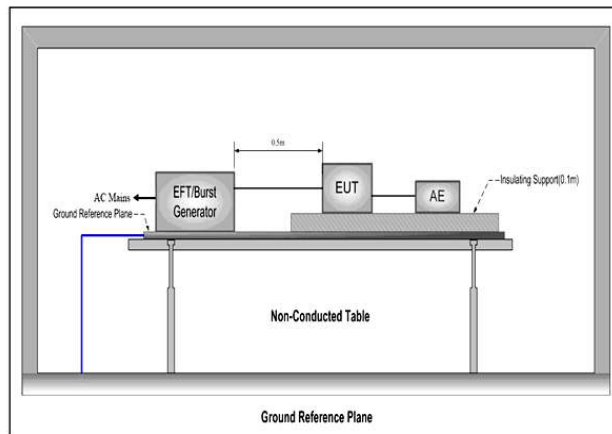

For telecommunication port:

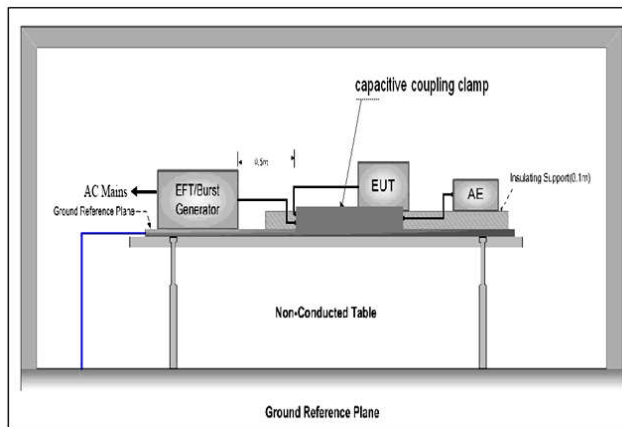

## 9.3.3 TEST PROCEDURE

- 1) The EUT was placed on a ground reference plane(GRP) insulated by an insulating support 0.1 m thick and the GRP was placed on a 0.8m high wooden table for table-top equipment. For floor standing equipment, the EUT was placed on a 0.1m high wooden support above the GRP.
- 2) The GRP shall project beyond the EUT and the clamp by at least 0.1m on all sides. The distance between the EUT and any other of the metallic surface except the GRP was greater than 0.5m. All cables to the EUT was placed on the insulation support 0.1m above GRP. A cable not subject to EFT was routed as far as possible from cable under test to minimize the coupling between the cables.
- 3) The length of signal and power cable between the EUT and EFT generator was 0.5m. If the cable is a non-detachable supply cable more than 0.5m, the excess length of this cable shall be folded to avoid a flat coil and situated at a distance of 0.1m above the GRP.
- 4) The EUT was conducted the below specified test voltages for line and neutral or line, neutral and earth simultaneously (for telecommunication, single, control and DC port line with capacitive coupling clamp), 120 seconds duration. If the equipment contains identical ports, only one was tested; multicomputer cables, such as a 50-pair telecommunication cable, were tested as a single cable. Cables did not be split or divided into groups of conductors for this test; interface ports, which were intended by the manufacturer to be connected to data cables not longer than 3 m, did not be tested.



## 9.3.4 RESULTS & PERFORMANCE

**Product** : BeaglePlay  
**Model/Type reference** : BeaglePlay  
**Power** : AC 110V/60Hz  
AC 230V/50Hz  
**Mode** : Normal  
**Press** : 101kPa

**Temperature** : 22°C  
**Humidity** : 53%

### Test data:

Lead under Test	Level (kV)	Coupling Direct/Clamp	EUT operating mode	Observations (Performance Criterion)
L, N	± 1.0	Direct	Normal	A
LAN port	± 0.5	Clamp	Normal	A

## 9.4 SURGES

### 9.4.1 TEST SPECIFICATION

<b>Basic Standard</b>	: EN 55035 & IEC 61000-4-5
<b>Test Port</b>	: Normal & LAN port & phone port
<b>Wave-Shape</b>	: Open Circuit Voltage - 1.2 / 50 us Short Circuit Current - 8 / 20 us
<b>Pulse Repetition Rate</b>	: 1 pulse / min.
<b>Test Events</b>	: Five positive polarity pulses at the 90° phase angle Five negative polarity pulses at the 270° phase angle

### 9.4.2 BLOCK DIAGRAM OF TEST SETUP

For input AC mains power port:

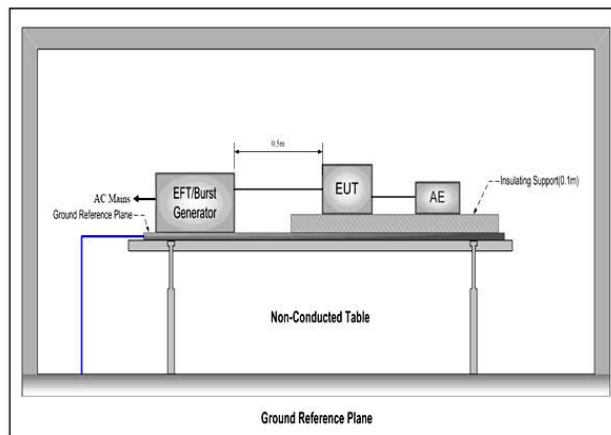

For telecommunication port:

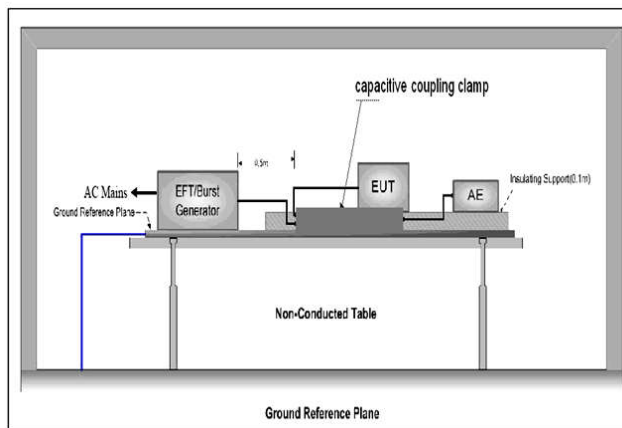

## 9.4.3 TEST PROCEDURE

- a. The surge is to be applied to the Product power supply terminals via the capacitive coupling network. Decoupling networks are required in order to avoid possible adverse effects on equipment not under test that may be powered by the same lines, and to provide sufficient decoupling impedance to the surge wave.
- b. The power cord between the Product and the coupling/decoupling networks shall be 2 meters in length (or shorter). Interconnection line between the Product and the coupling/decoupling networks shall be 2 meters in length (or shorter).

## 9.4.4 RESULTS & PERFORMANCE

<b>Product</b>	: BeaglePlay		
<b>Model/Type reference</b>	: BeaglePlay		
<b>Power</b>	: AC 110V/60Hz	<b>Temperature</b>	: 22°C
	: AC 230V/50Hz		
<b>Mode</b>	: Normal	<b>Humidity</b>	: 53%
<b>Press</b>	: 101kPa		

### AC port:

For AC port (2 line)					
Pulse No	Line-Line	Level (kV)	Surge interval	phase (deg)	Observation (Performance Criterion)
1-5	L-N	+1	60s	90°	A
6-10	L-N	-1	60s	270°	A

### Telecommunication ports:

For telecommunication ports (2 line)					
Pulse No	Line-Line	Level (kV)	Surge interval	phase (deg)	Observation (Performance Criterion)
1-5	telecomm	+0.5	60s	--	A
6-10	telecomm	-0.5	60s	--	A

### Remark:

A: No performance degradation during test.

## 9.5 RADIO-FREQUENCY CONTINUOUS CONDUCTED IMMUNITY

### 9.5.1 TEST SPECIFICATION

<b>Basic Standard</b>	: EN 55035 & IEC 61000-4-6
<b>Test Port</b>	: Normal & LAN port
<b>Step Size</b>	: 1%
<b>Modulation</b>	: 1kHz, 80% AM
<b>Dwell Time</b>	: 1 second

### 9.5.2 BLOCK DIAGRAM OF TEST SETUP

For input AC mains power port:

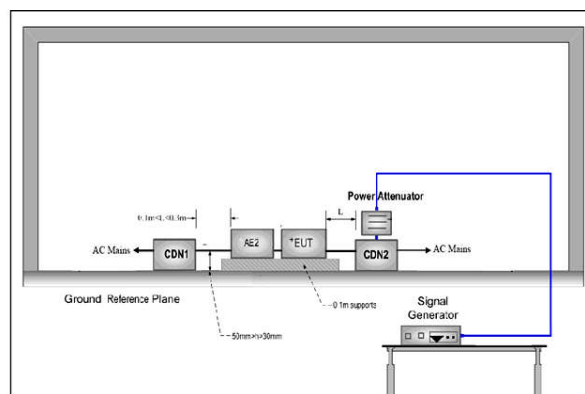

For telecommunication port:

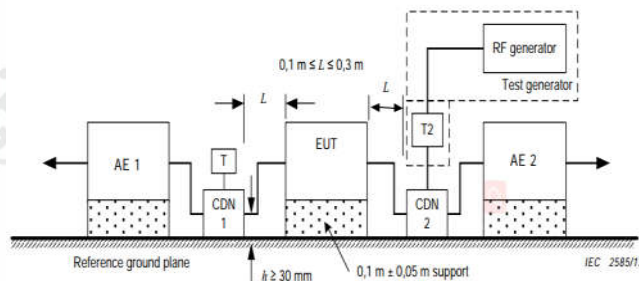

## 9.5.3 TEST PROCEDURE

- 1) The EUT was placed on an insulating support of 0.1m height above a ground reference Plane, arranged and connected to satisfy its functional requirement. All cables exiting the EUT was supported at a height of at least 30 mm above the ground reference plane.
- 2) The coupling and decoupling devices were required, they were located between 0.1 m and 0.3 m from the EUT. This distance was to be measured horizontally from the projection of the EUT on to the ground reference plane to the coupling and decoupling device.
- 3) Each AE, used with clamp injection, shall be placed on an insulating support 0.1 m above the ground reference plane. A decoupling network shall be installed on each cable between the EUT and AE except the cable under test. All cables connected to each AE, other than those being connected to the EUT, shall be provided with decoupling networks. The decoupling networks connected to each AE (except those on cables between the EUT and AE) shall be applied no further than 0.3 m from the AE. The cable(s) between the AE and the decoupling network (s) or in between the AE and the injection clamp shall not be bundled nor wrapped and shall be kept between 30 mm and 50 mm above the ground reference plane
- 4) The frequency range was swept from 150 kHz to 80 MHz, using the signal levels established during the setting process, and with the disturbance signal 80 % amplitude modulated with a 1 kHz sine wave, pausing to adjust the RF signal level or to change coupling devices as necessary. Where the frequency was swept incrementally, the step size does not exceed 1 % of the preceding frequency value. The dwell time of the amplitude modulated carrier at each frequency was not less than the time necessary for the EUT to be exercised and to respond, and was not less than 0.5 s.



## 9.5.4 RESULTS & PERFORMANCE

**Product** : BeaglePlay  
**Model/Type reference** : BeaglePlay  
**Power** : AC 110V/60Hz  
           AC 230V/50Hz  
**Mode** : Normal  
**Press** : 101kPa  
**Temperature** : 22°C  
**Humidity** : 53%

### AC port:

Frequency	Line	Test Level	Modulation	Step Size	Dwell Time	Observation (Performance Criterion)
150kHz to 10MHz	AC port	3Vrms	80%, 1kHz Amp. Mod.	1%	2 S	A
10MHz to 30MHz	AC port	3 to1Vrms	80%, 1kHz Amp. Mod.	1%	2 S	A
30MHz to 80MHz	AC port	1Vrms	80%, 1kHz Amp. Mod.	1%	2 S	A

### Telecommunication ports

Frequency	Line	Test Level	Modulation	Step Size	Dwell Time	Observation (Performance Criterion)
150kHz to 10MHz	telecommunication ports	3Vrms	80%, 1kHz Amp. Mod.	1%	2 S	A
10MHz to 30MHz	telecommunication ports	3 to1Vrms	80%, 1kHz Amp. Mod.	1%	2 S	A
30MHz to 80MHz	telecommunication ports	1Vrms	80%, 1kHz Amp. Mod.	1%	2 S	A

### Remark:

A: No performance degradation during test.

## 9.6 VOLTAGE DIPS AND INTERRUPTIONS

### 9.6.1 TEST SPECIFICATION

**Basic Standard** : EN 55035 & IEC 61000-4-11  
**Test Ports** : AC mains power ports  
**Phase Angle** : 0°, 180°

### 9.6.2 BLOCK DIAGRAM OF TEST SETUP

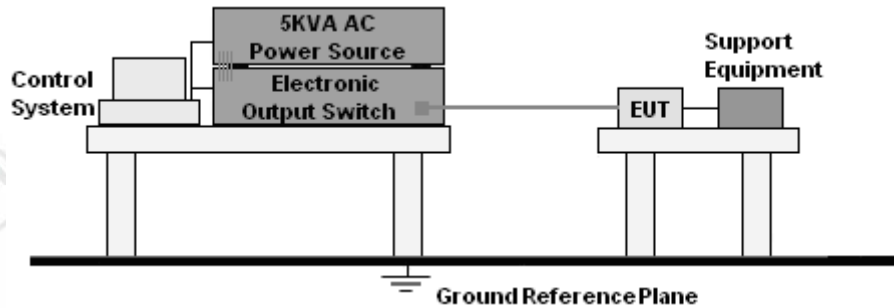

### 9.6.3 TEST PROCEDURE

- The Product and support units were located on a non-conductive table above ground floor.
- Set the parameter of tests and then perform the test software of test simulator.
- Conditions changes to occur at 0 degree crossover point of the voltage waveform.

### 9.6.4 RESULTS & PERFORMANCE

**Product** : BeaglePlay  
**Model/Type reference** : BeaglePlay  
**Power** : AC 100V, AC 240V  
**Mode** : Normal  
**Press** : 101kPa  
**Temperature** : 22°C  
**Humidity** : 53%

#### Voltage Dips:

Test Level % UT	Reduction (%)	Number of cycles		Required Level	Performance criteria
		50Hz	60Hz		
<5	>95	0.5		B	A
70	30	25	30	C	A

#### Voltage Interruptions:

Test Level % UT	Reduction (%)	Number of cycles		Required Level	Performance criteria
		50Hz	60Hz		
<5	>95	250		C	C*

Remark\*: The product stop working during the test and it can recover by manual after test.

## APPENDIX 1 PHOTOGRAPHS OF TEST SETUP

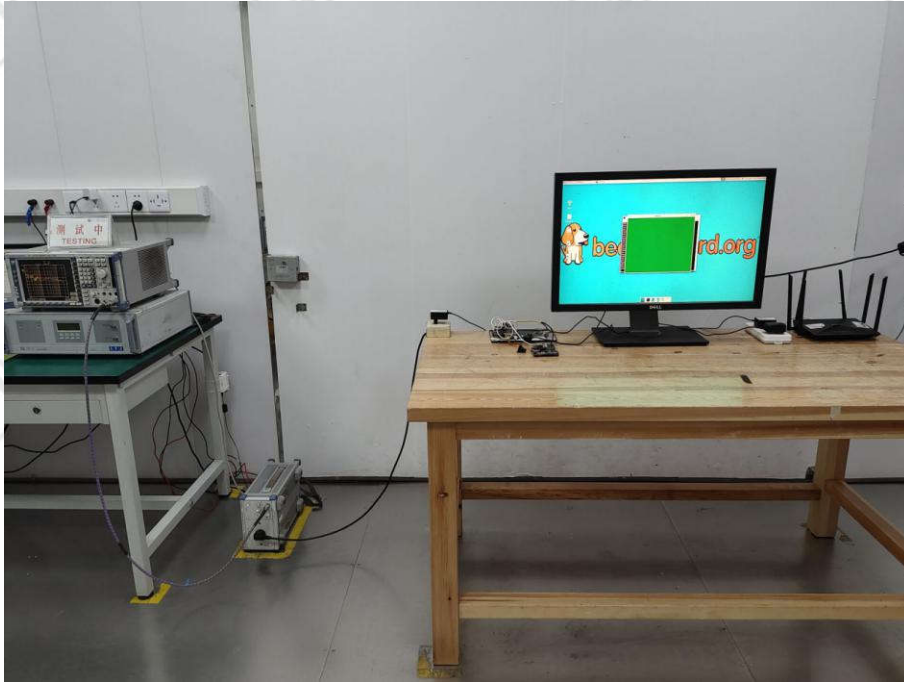

**CONDUCTED DISTURBANCE TEST SETUP**

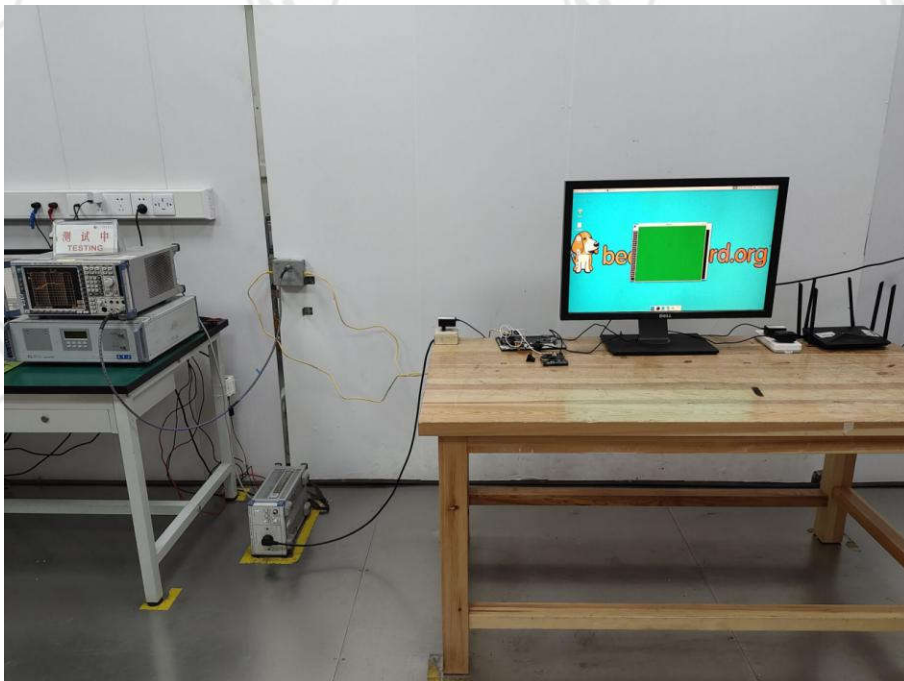

**CONDUCTED DISTURBANCE TEST SETUP-2**



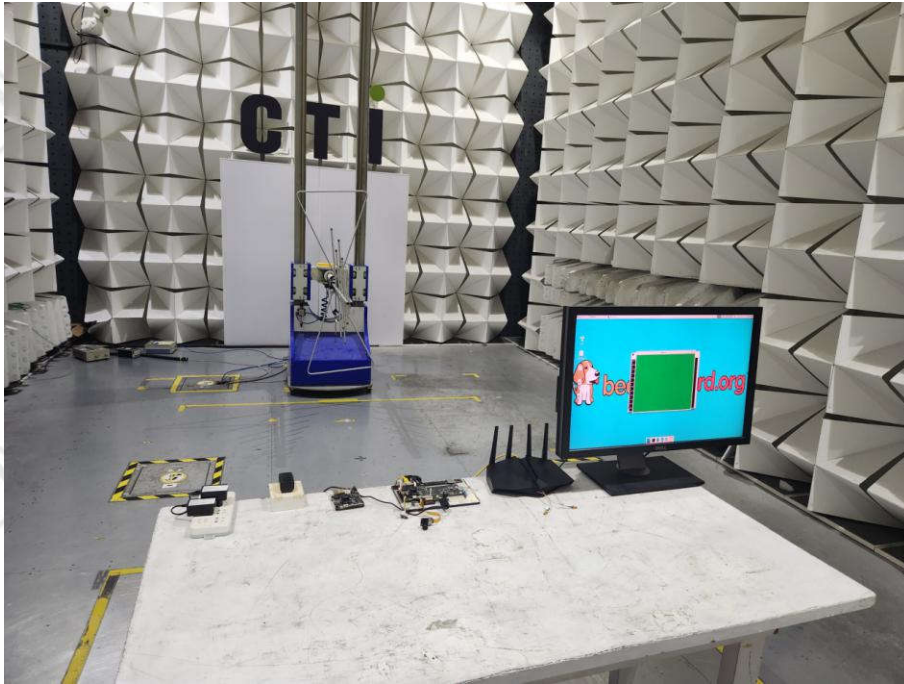

**RADIATED DISTURBANCE TEST SETUP-1**

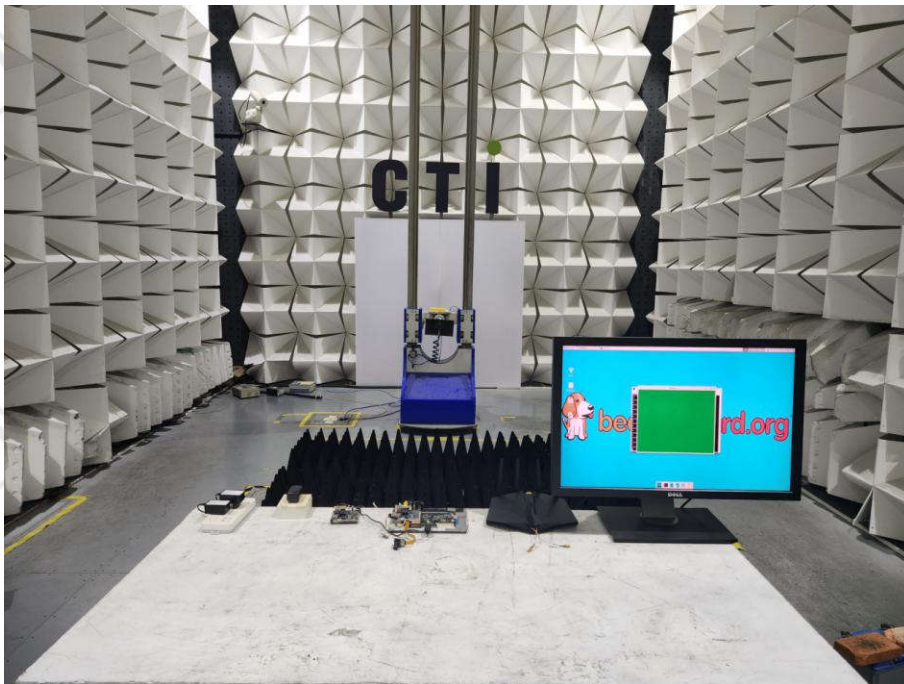

**RADIATED DISTURBANCE TEST SETUP-2**



**FLICKER TEST SETUP**

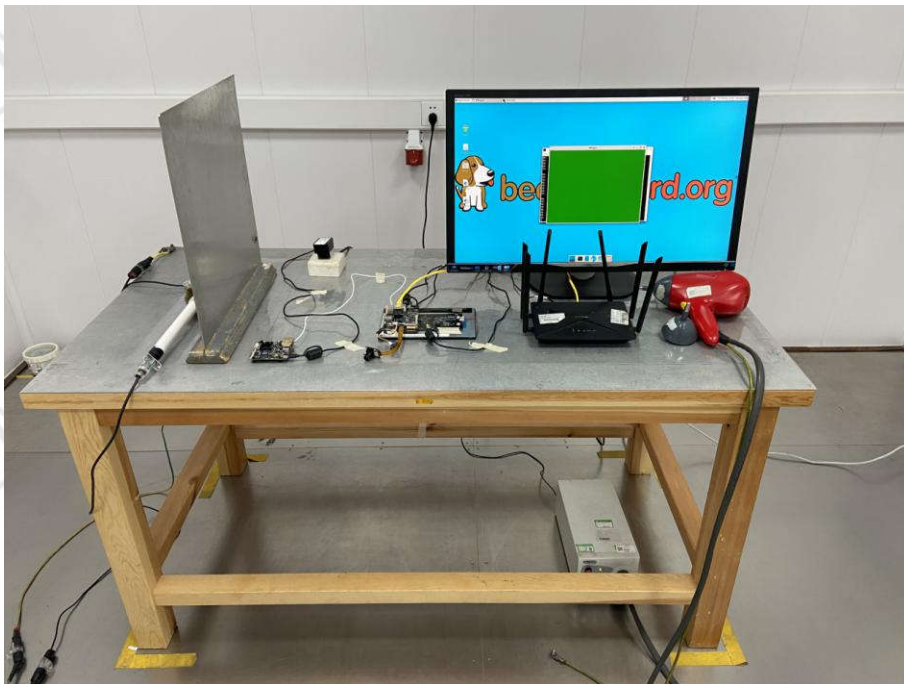

**ESD TEST SETUP**





**RADIO-FREQUENCY ELECTROMAGNETIC FIELD IMMUNITY TEST SETUP**

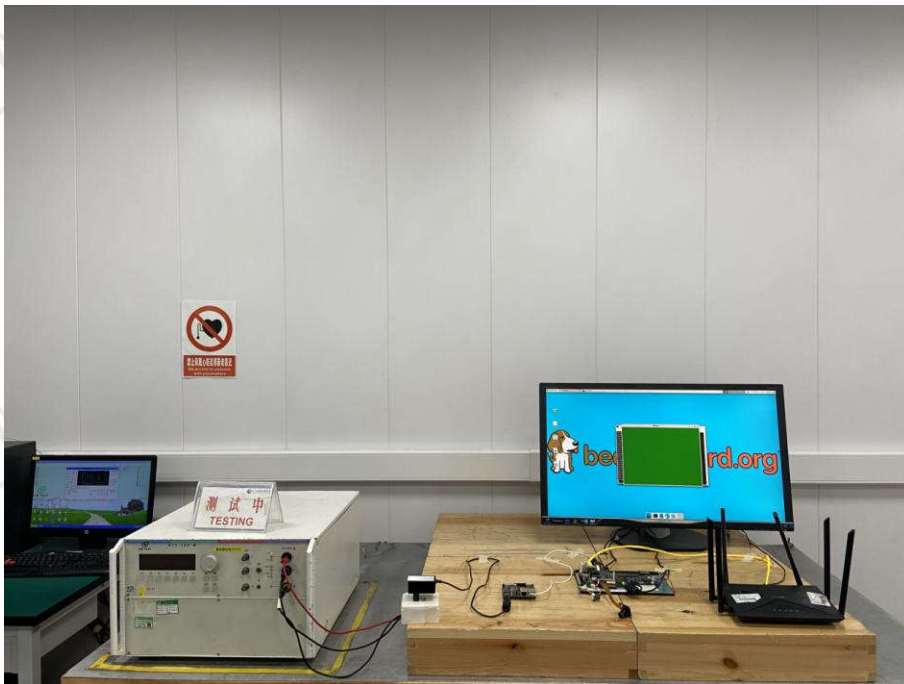

**EFT TEST SETUP**



**SURGES TEST SETUP**

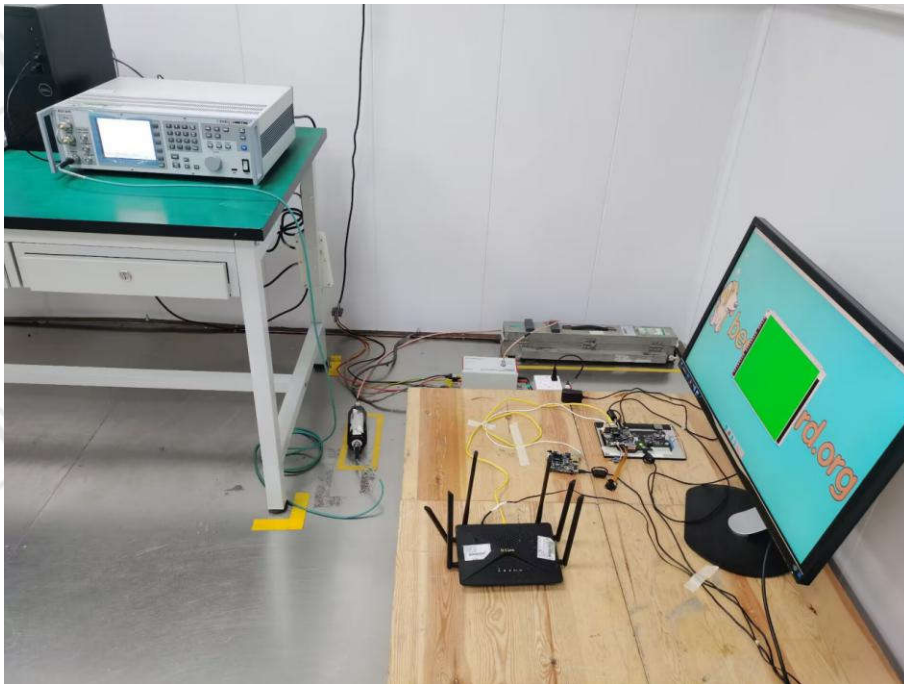

**RADIO-FREQUENCY CONTINUOUS CONDUCTED IMMUNITY TEST SETUP**



**VOLTAGE DIPS AND INTERRUPTIONS TEST SETUP**



**APPENDIX 2 PHOTOGRAPHS OF PRODUCT**

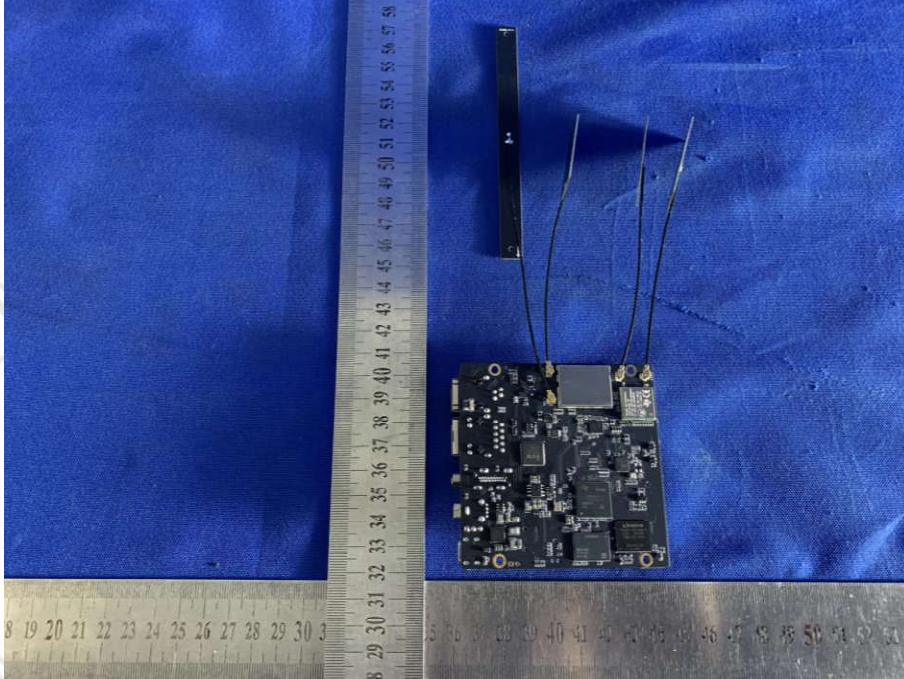

View of Product-1

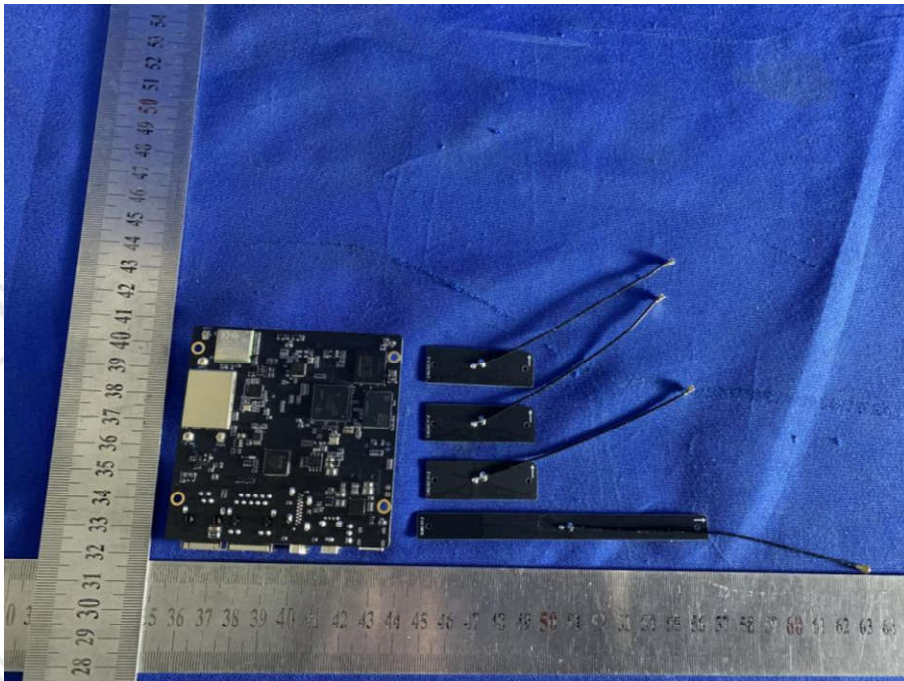

View of Product-2



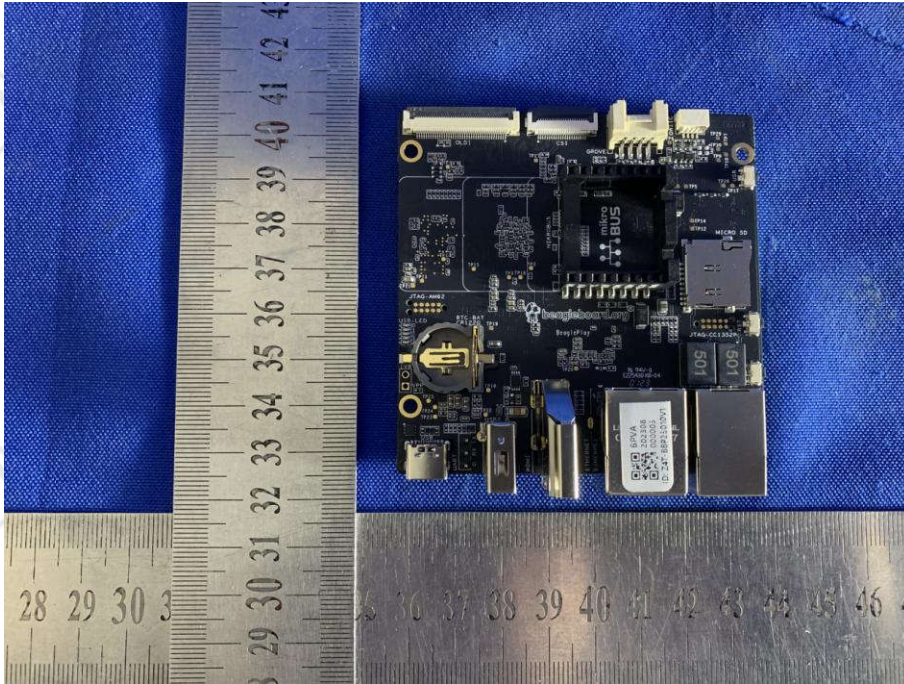

View of Product-3

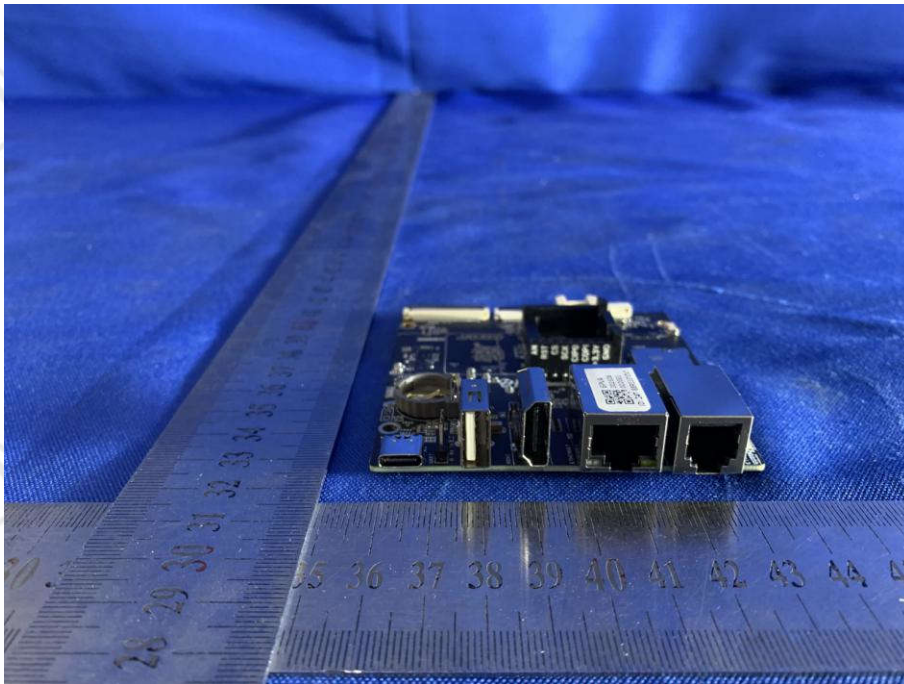

View of Product-4



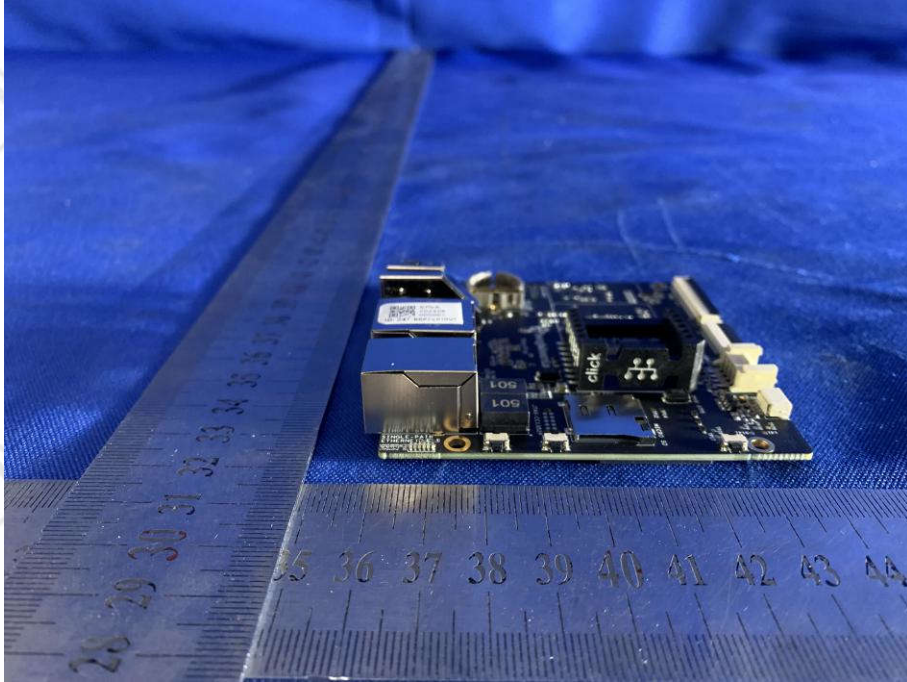

View of Product-5

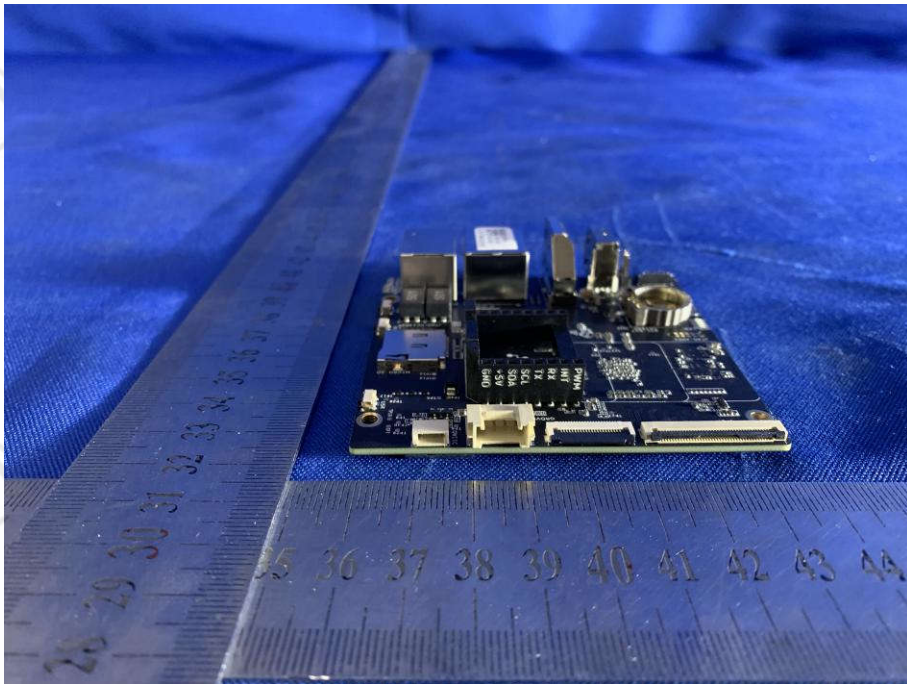

View of Product-6



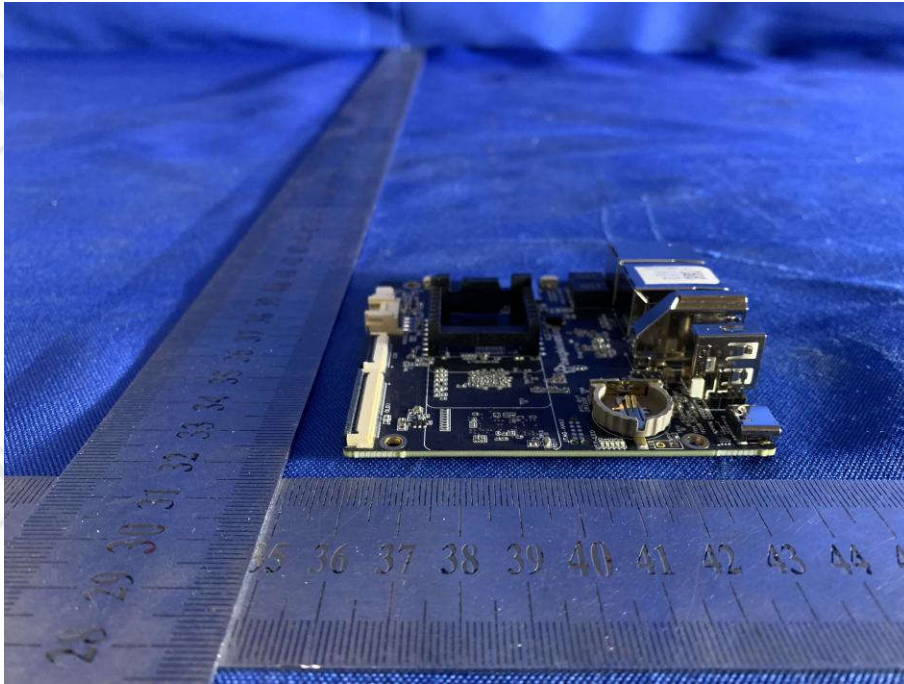

View of Product-7

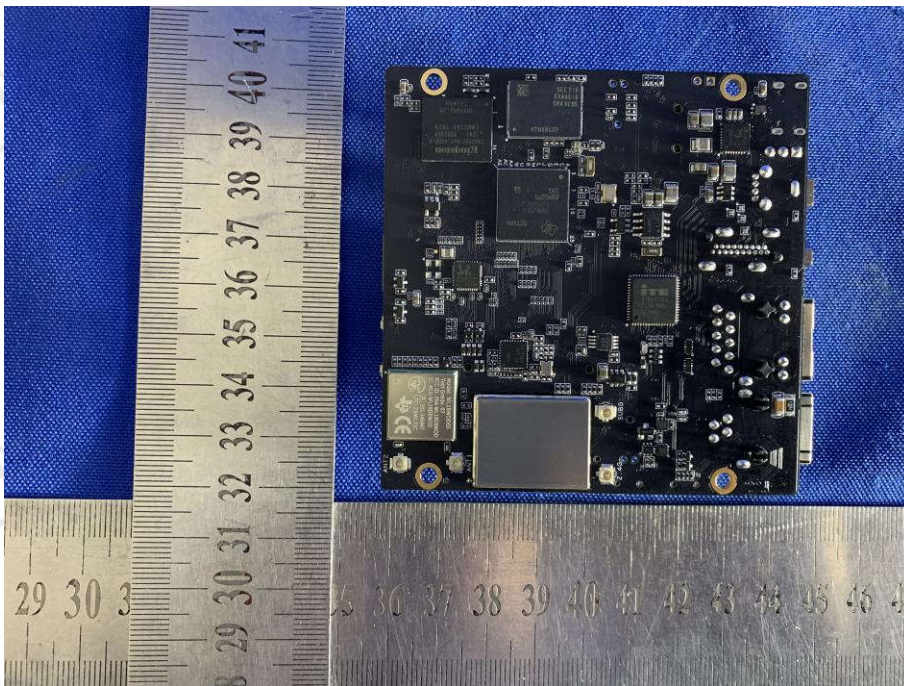

View of Product-8

The test report is effective only with both signature and specialized stamp. The result(s) shown in this report refer only to the sample(s) tested. Without written approval of CTI, this report can't be reproduced except in full.

\*\*\* End of Report \*\*\*

## TEST REPORT

**Product** : BeaglePlay  
**Trade mark** : Beagleboard.org  
**Model/Type reference** : BeaglePlay  
**Serial Number** : N/A  
**Report Number** : EED32P80002302  
**Date of Issue** : Feb. 21, 2023  
**Test Standards** : ETSI EN 301 489-1 V2.2.3 (2019-11)  
: ETSI EN 301 489-3 V2.1.1 (2019-03)  
: ETSI EN 301 489-17 V3.2.4 (2020-09)  
**Test result** : PASS

Prepared for:

**Seed Technology Co., Ltd**  
9F,Building G3,TCL International E city,Zhongshanyuan  
Road,Nanshan,Shenzhen,China.

Prepared by:

**Centre Testing International Group Co., Ltd.**  
Hongwei Industrial Zone, Bao'an 70 District,  
Shenzhen, Guangdong, China  
**TEL: +86-755-3368 3668**  
**FAX: +86-755-3368 3385**

Compiled by: WIFI. Wei

Reviewed by: Deng Binbin

Approved by: Aaron Ma  
Aaron Ma



Date of Issue: Feb. 21, 2023  
Check No.:5404030123

## 1 Version

Version No.	Date	Description
00	Feb. 21, 2023	Original



## 2 Test Summary

<b>Electromagnetic Compatibility (EMC) Part</b>				
<b>Electromagnetic Interference (EMI)</b>				
<b>Test</b>	<b>Test Requirement</b>	<b>Test Method</b>	<b>Limit</b>	<b>Result</b>
<b>Radiated Emission</b>	ETSI EN 301 489-17 V3.2.4 (2020-09) Clause 7.1, ETSI EN 301 489-3 V2.1.1 (2019-03) Clause 7.1	EN 301 489-1 V2.2.3 (2019-11) Clause 8.2	Clause 8.2.3	PASS
<b>Conducted Emission (DC port)</b>	ETSI EN 301 489-17 V3.2.4 (2020-09) Clause 7.1, ETSI EN 301 489-3 V2.1.1 (2019-03) Clause 7.1	EN 301 489-1 V2.2.3 (2019-11) Clause 8.3	Clause 8.3.3	N/A <sup>1</sup>
<b>Conducted Emission (AC port)</b>	ETSI EN 301 489-17 V3.2.4 (2020-09) Clause 7.1, ETSI EN 301 489-3 V2.1.1 (2019-03) Clause 7.1	EN 301 489-1 V2.2.3 (2019-11) Clause 8.4	Clause 8.4.3	PASS
<b>Harmonic Emission on AC, 50Hz to 2kHz</b>	ETSI EN 301 489-17 V3.2.4 (2020-09) Clause 7.1, ETSI EN 301 489-3 V2.1.1 (2019-03) Clause 7.1	EN 301 489-1 V2.2.3 (2019-11) Clause 8.5	Clause 8.5	N/A <sup>2</sup>
<b>Flicker Emission on AC</b>	ETSI EN 301 489-17 V3.2.4 (2020-09) Clause 7.1, ETSI EN 301 489-3 V2.1.1 (2019-03) Clause 7.1	EN 301 489-1 V2.2.3 (2019-11) Clause 8.6	Clause 8.6	PASS
<b>Conducted Emission (telecommunication port)</b>	ETSI EN 301 489-17 V3.2.4 (2020-09) Clause 7.1, ETSI EN 301 489-3 V2.1.1 (2019-03) Clause 7.1	EN 301 489-1 V2.2.3 (2019-11) Clause 8.7	Clause 8.7.3	N/A
<b>Electromagnetic Susceptibility(EMS)</b>				
<b>ESD (Electrostatic Discharge)</b>	ETSI EN 301 489-17 V3.2.4 (2020-09) Clause 7.2, ETSI EN 301 489-3 V2.1.1 (2019-03) Clause 7.1	EN 301 489-1 V2.2.3 (2019-11) Clause 9.3	Clause 9.3.3	PASS
<b>Radiated Immunity, 80MHz to 6 GHz</b>	ETSI EN 301 489-17 V3.2.4 (2020-09) Clause 7.2, ETSI EN 301 489-3 V2.1.1 (2019-03) Clause 7.1, 7.3	EN 301 489-1 V2.2.3 (2019-11) Clause 9.2	Clause 9.2.3	PASS
<b>EFT (Electrical Fast Transients)</b>	ETSI EN 301 489-17 V3.2.4 (2020-09) Clause 7.2, ETSI EN 301 489-3 V2.1.1 (2019-03) Clause 7.1	EN 301 489-1 V2.2.3 (2019-11) Clause 9.4	Clause 9.4.3	PASS
<b>Surge Immunity</b>	ETSI EN 301 489-17 V3.2.4 (2020-09) Clause 7.2, ETSI EN 301 489-3 V2.1.1 (2019-03) Clause 7.1	EN 301 489-1 V2.2.3 (2019-11) Clause 9.8	Clause 9.8.3	PASS
<b>Injected Currents 150kHz to 80MHz</b>	ETSI EN 301 489-17 V3.2.4 (2020-09) Clause 7.2, ETSI EN 301 489-3 V2.1.1 (2019-03) Clause 7.1, 7.3	EN 301 489-1 V2.2.3 (2019-11) Clause 9.5	Clause 9.5.3	PASS
<b>Voltage Dips and Interruptions</b>	ETSI EN 301 489-17 V3.2.4 (2020-09) Clause 7.2, ETSI EN 301 489-3 V2.1.1 (2019-03) Clause 7.1	EN 301 489-1 V2.2.3 (2019-11) Clause 9.7	Clause 9.7.3	PASS
<b>Transients and Surges in the Vehicular Environment</b>	ETSI EN 301 489-17 V3.2.4 (2020-09) Clause 7.2, ETSI EN 301 489-3 V2.1.1 (2019-03) Clause 7.1	EN 301 489-1 V2.2.3 (2019-11) Clause 9.6	Clause 9.6.3	N/A <sup>3</sup>

Remark:

Company Name and Address shown on Report, the sample(s) and sample Information was/ were Provided by the applicant who should be responsible for the authenticity which CTI hasn't verified.

Tx: In this whole report Tx (or tx) means Transmitter.

Rx: In this whole report Rx (or rx) means Receiver.

RF: In this whole report RF means Radiated Frequency.

CH: In this whole report CH means channel.

Volt: In this whole report Volt means Voltage.

Temp: In this whole report Temp means Temperature.

Humid: In this whole report Humid means humidity.

Press: In this whole report Press means Pressure.

N/A: In this whole report not application.

N/A<sup>1)</sup> The tested sample has no DC mains input/output port , therefore it is not applicable.

N/A<sup>2)</sup> The Product belongs to Class A, and its power is less than 75W, so it deems to fulfil this standard without testing.

N/A<sup>3)</sup> The tested sample is not used in the vehicle, therefore it is not applicable.

## 3 Contents

	Page
<b>1 VERSION</b> .....	<b>2</b>
<b>2 TEST SUMMARY</b> .....	<b>3</b>
<b>3 CONTENTS</b> .....	<b>5</b>
<b>4 GENERAL INFORMATION</b> .....	<b>6</b>
4.1 CLIENT INFORMATION .....	6
4.2 GENERAL DESCRIPTION OF EUT .....	6
4.3 PRODUCT SPECIFICATION SUBJECTIVE TO THIS STANDARD .....	6
4.4 OTHER INFORMATION .....	6
4.5 DESCRIPTION OF SUPPORT UNITS .....	7
4.6 TEST LOCATION .....	7
4.7 DEVIATION FROM STANDARDS .....	7
4.8 ABNORMALITIES FROM STANDARD CONDITIONS .....	7
4.9 OTHER INFORMATION REQUESTED BY THE CUSTOMER .....	7
4.10 MONITORING OF EUT FOR THE IMMUNITY TEST .....	7
4.11 MEASUREMENT UNCERTAINTY (95% CONFIDENCE LEVELS, K=2) .....	7
<b>5 EQUIPMENT LIST</b> .....	<b>8</b>
<b>6 EMC REQUIREMENTS SPECIFICATION IN EN 301 489-17</b> .....	<b>10</b>
6.1 EMI (EMISSION) .....	10
6.1.1 Radiated Emission .....	10
6.1.2 Conducted Emission .....	15
6.1.3 Flicker Test Results .....	20
6.2 EMS (IMMUNITY) .....	22
6.2.1 Radiated Immunity .....	23
6.2.2 ESD .....	25
6.2.3 RF Common Mode 0.15MHz to 80MHz .....	27
6.2.4 Electrical Fast Transients (EFT) .....	29
6.2.5 Surge .....	31
6.2.6 Voltage Dips and Interruptions .....	33
<b>APPENDIX PHOTOGRAPHS OF TEST SETUP</b> .....	<b>35</b>
<b>PHOTOGRAPHS OF EUT CONSTRUCTIONAL DETAILS</b> .....	<b>41</b>

## 4 General Information

### 4.1 Client Information

Applicant:	Seed Technology Co., Ltd
Address of Applicant:	9F,Building G3,TCL International E city,Zhongshanyuan Road,Nanshan,Shenzhen,China.
Manufacturer:	Seed Technology Co., Ltd
Address of Manufacturer:	9F,Building G3,TCL International E city,Zhongshanyuan Road,Nanshan,Shenzhen,China.
Factory:	Shenzhen Xinxian Technology Co; Limited
Address of Factory:	F5, Building B17, Hengfeng Industrial City,No. 739 Zhoushi Rd, Baoan District, Shenzhen,Guangdong, P.R.C.F5, Building B17, Hengfeng Industrial City,No. 739 Zhoushi Rd, Baoan District, Shenzhen,Guangdong, P.R.C.

### 4.2 General Description of EUT

Product Name:	BeaglePlay
Model No.:	BeaglePlay
Trade Mark:	Beagleboard.org
Power Supply:	DC 5V

### 4.3 Product Specification subjective to this standard

Test Mode:	
Wi-Fi mode:	Keep the EUT in Wi-Fi mode.
Bluetooth mode:	Keep the EUT in Bluetooth mode.
Standby mode:	Keep the EUT in Standby mode.

### 4.4 Other Information

RED Directive:	2014/53/EU
Sample Received Date:	Jan. 03, 2023
Sample tested Date:	Jan. 03, 2023 to Jan .06, 2023



## 4.5 Description of Support Units

The EUT has been tested with associated equipment below.  
support equipment

Description	Manufacturer	Model No.	Certification	Supplied by
Notebook	HP	C1260	-	-

## 4.6 Test Location

All tests were performed at:

Centre Testing International Group Co., Ltd

Building C, Hongwei Industrial Park Block 70, Bao'an District, Shenzhen, China

Telephone: +86 (0) 755 33683668 Fax: +86 (0) 755 33683385

No tests were sub-contracted.

## 4.7 Deviation from Standards

None.

## 4.8 Abnormalities from Standard Conditions

None.

## 4.9 Other Information Requested by the Customer

None.

## 4.10 Monitoring of EUT for the Immunity Test

Visual: Monitoring the data communication of EUT.

## 4.11 Measurement Uncertainty (95% confidence levels, k=2)

No.	Item	Measurement Uncertainty
1	Conduction emission	3.5dB (9kHz to 150kHz)
		3.1dB (150kHz to 30MHz)
2	Radiated emission	4.9dB (30MHz-1GHz )
		4.7dB (1GHz-6GHz )
3	Temperature test	0.64°C
4	Humidity test	3.8%
5	DC power test	0.026%

## 5 Equipment List

Shielding Room No. 3 - Conducted disturbance Test				
Equipment	Manufacturer	Model	Serial No.	Due Date
Receiver	R&S	ESCI	100435	04/14/2023
LISN	R&S	ENV216	100098	03/01/2023

3M Semi-anechoic Chamber (2)- Radiated disturbance Test				
Equipment	Manufacturer	Model	Serial No.	Due Date
3M Chamber & Accessory Equipment	TDK	SAC-3	---	05/21/2025
Receiver	R&S	ESCI7	100938-003	10/13/2023
TRILOG Broadband Antenna	schwarzbeck	VULB 9163	401	10/15/2023
Multi device Controller	matur	NCD/070/10711 112	---	---
Horn Antenna	ETS-LINGREN	BBHA 9120D	9120D-1869	04/16/2024
Microwave Preamplifier	Agilent	8449B	3008A02425	06/22/2023

Shielding Room No. 2 - Flicker Test (EN 61000-3-3) Shielding Room No. 2 -Voltage dips and interruptions Test (IEC 61000-4-11)				
Equipment	Manufacturer	Model	Serial No.	Due Date
AC / DC programmable regulated power supply	EM TEST	Net Wave 30	P1613178144	06/12/2023
Single / three phase scintillation simulator	EM TEST	503N32	P1613178045	06/12/2023
Three phase harmonic and scintillation analyzer	EM TEST	DPA 503N	P154516605	06/12/2023
Voltage dip simulator	EM TEST	PFS 503N32.2	P1919229535	04/06/2023

Shielding Room No. 1 - ESD Test (IEC 61000-4-2)				
Equipment	Manufacturer	Model	Serial No.	Due Date
ESD Simulator	TESEQ	NSG437	1182	06/09/2023

<b>3M Full-anechoic Chamber - Continuous RF electromagnetic radiated field disturbances Test (IEC 61000-4-3)</b>				
<b>Equipment</b>	<b>Manufacturer</b>	<b>Model</b>	<b>Serial No.</b>	<b>Due Date</b>
3M Chamber & Accessory Equipment	ETS-LINDGREN	FACT-3	3510	05/19/2025
Signal Generator	R&S	SMB 100B	103084	05/19/2023
Power Probe	R&S	NRP6A	103342	07/12/2023
Power Probe	R&S	NRP6A	103343	07/13/2023
Power Amplifier	R&S	BBA 150-BC500	104743	06/06/2023
Power Amplifier	BONN	BLMA 1060-100	2113427	08/24/2023
RF switch	R&S	OSP220	102205	---
Directional coupler	BONN	BDC 1060-40/500	2128343-04	111/27/2023
Stacked double Log.-Per. Antenna	schwarzbeck	STLP 9128 E special	9128ES-110	---
Horn Antenna	schwarzbeck	STLP 9149	0776	05/21/2023

<b>Shielding Room No. 3 - EFT / Surges Test (IEC 61000-4-4) (IEC 61000-4-5)</b>				
<b>Equipment</b>	<b>Manufacturer</b>	<b>Model</b>	<b>Serial No.</b>	<b>Due Date</b>
Compact Generator	EM-Test	UCS500M/6B	V0603101093	04/14/2023

<b>Shielding Room No. 2 - Radio-frequency continuous conducted Immunity Test (IEC 61000-4-6)</b>				
<b>Equipment</b>	<b>Manufacturer</b>	<b>Model</b>	<b>Serial No.</b>	<b>Due Date</b>
RF conduction immunity test system	TESEQ	NSG 4070C-80	59089	08/26/2023
CDN	EM-Test	CDN M2/M3	0204-01	10/13/2023
Attenuator	BIRD	75-A-MFN-06	0543	08/03/2024
Electronic output switch	California instruments	EOS-230	1726A00001	03/02/2023

## 6 EMC Requirements Specification in EN 301 489-17

EMI in EN 301 489-1, sub clause 7.1 table 1.

EMS in EN 301 489-1, sub clause 7.2 table 2.

### 6.1 EMI (Emission)

#### 6.1.1 Radiated Emission

**Test Requirement:** EN 301 489-3 Clause 7.1, EN 301 489-17 Clause 7.1

**Test Method:** EN 301 489-1 Clause 8.2.2

**EUT Operation:**

Ambient: Temp.: 22°C Humid.: 53% Press.: 1010mbar

Test Mode: Wi-Fi mode, Bluetooth mode, 2.4G mode

Test Status: Pretest the EUT at different test mode and found the Wi-Fi mode which is worst case, the test worst case mode is recorded in the report.

**Receive Setup:**

Frequency range (MHz)	Detector	RBW	VBW
30-1000	Quasi-peak	120kHz	300kHz
Above 1000	Peak	1MHz	3MHz

**Limit:**

Frequency	Limit(@3m)	Remark
30MHz-230MHz	40dBuV/m	QP value
230MHz-1GHz	47dBuV/m	QP value
1GHz-3GHz	50dBuV/m	Average value
	70dBuV/m	PK value
3GHz-6GHz	54dBuV/m	Average value
	74dBuV/m	PK value

**Test Setup:**

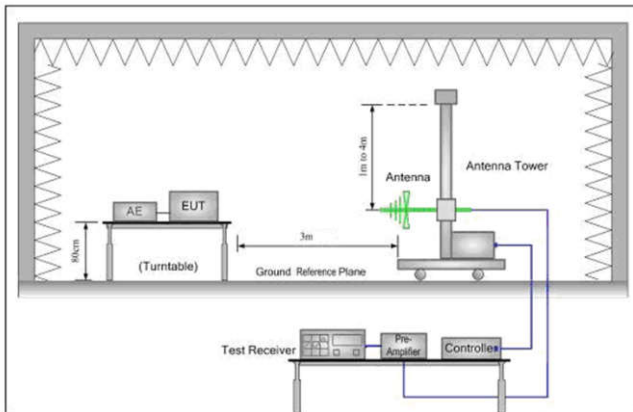
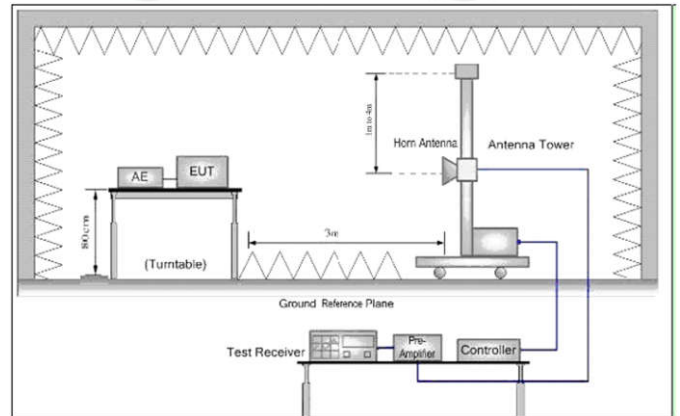

Figure1. 30MHz to 1GHz



Figure

2. Above 1 GHz

**Test Procedure:**

- From 30 MHz to 1GHz test Procedure as below:
  - The radiated emissions were tested in a semi-anechoic chamber.
  - The EUT is placed on a turntable, which is 0.8m above ground plane.
  - The turntable shall be rotated for 360 degrees to determine the position of maximum emission level.
  - EUT is set 3m away from the receiving antenna, which is moved from 1m to 4m to find out the maximum emissions.
  - Maximum Procedure was performed on the six highest emissions to ensure EUT compliance.
  - And also, each emission was to be maximized by changing the polarization of receiving antenna both horizontal and vertical.
  - Repeat above Procedures until the measurements for all frequencies are complete.
- Above 1GHz test Procedure as below:
  - Different between above is the test site, change from Semi- Anechoic Chamber to fully Anechoic Chamber

**Equipment Used:** Refer to section 5 for details.



Test result: PASS

**Measurement Data:**

**30MHz ~ 1GHz:**

**Product** : BeaglePlay

**Model/Type reference** : BeaglePlay

**Power** : AC 230V/50Hz

**Temperature** : 22°C

**Mode** : Normal

**Humidity** : 53%

**Polarization** : Horizontal

**Press** : 101kPa

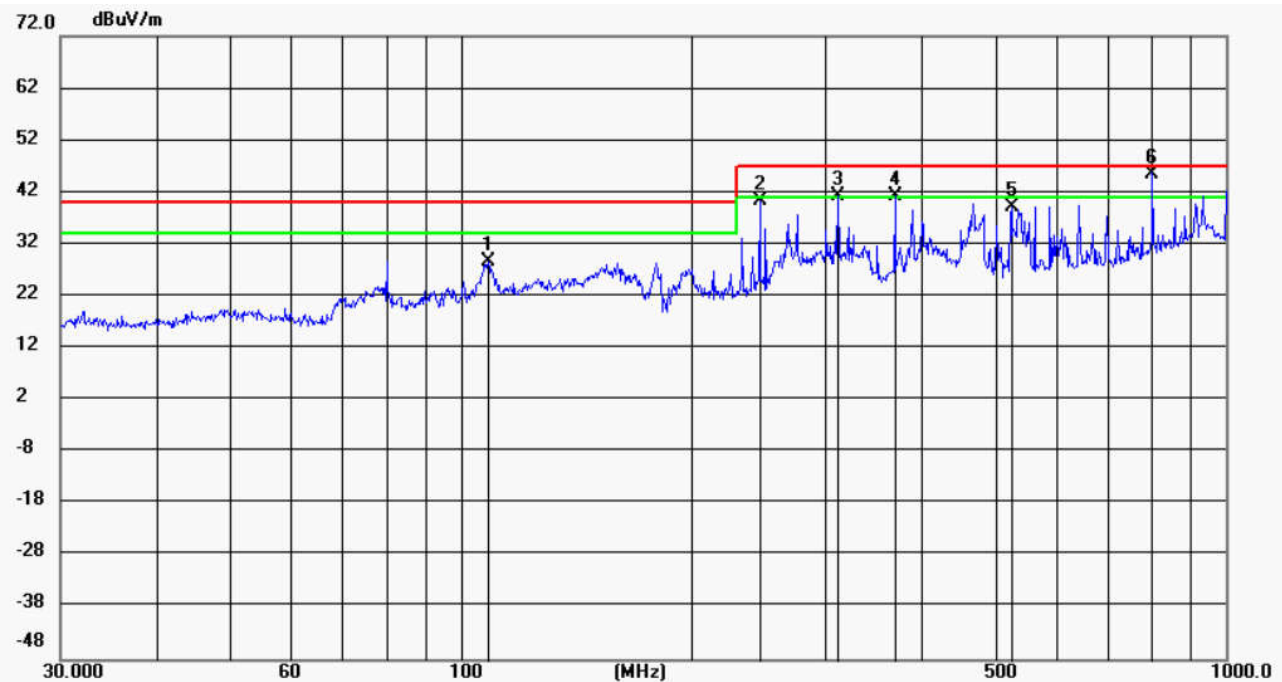

No.	Mk.	Freq.	Reading Level	Correct Factor	Measurement	Limit	Margin	Antenna Height	Table Degree	
		MHz	dBuV	dB	dBuV/m	dBuV/m	dB	cm	degree	Comment
1		108.6470	15.19	13.54	28.73	40.00	-11.27	QP	100	191
2		245.9508	25.63	14.71	40.34	47.00	-6.66	QP	100	262
3	!	311.0865	24.33	17.01	41.34	47.00	-5.66	QP	100	60
4	!	369.4045	23.38	17.85	41.23	47.00	-5.77	QP	100	161
5		524.5540	17.99	21.21	39.20	47.00	-7.80	QP	200	356
6	*	801.7863	20.16	25.34	45.50	47.00	-1.50	QP	100	357

**Product** : BeaglePlay  
**Model/Type reference** : BeaglePlay  
**Power** : AC 230V/50Hz  
**Mode** : Normal  
**Polarization** : Vertical  
**Temperature** : 22°C  
**Humidity** : 53%  
**Press** : 101kPa

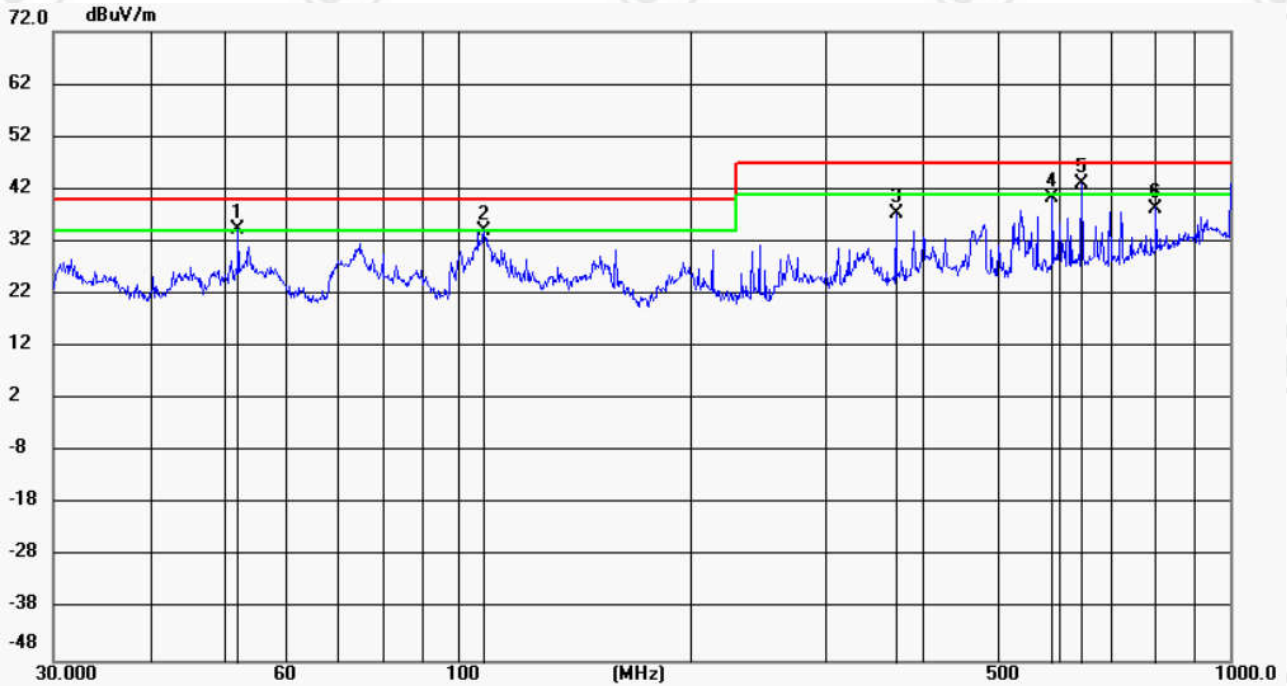

No.	Mk.	Freq. MHz	Reading Level dBuV	Correct Factor dB	Measure- ment dBuV/m	Limit dBuV/m	Margin dB	Antenna Height cm	Table Degree degree	Comment
1	!	52.0251	19.94	14.55	34.49	40.00	-5.51	QP 100	230	
2	!	108.2666	20.52	13.55	34.07	40.00	-5.93	QP 100	356	
3		369.4047	19.47	17.85	37.32	47.00	-9.68	QP 100	356	
4		588.9050	17.99	22.42	40.41	47.00	-6.59	QP 200	89	
5	*	642.8612	20.22	22.86	43.08	47.00	-3.92	QP 100	331	
6		801.7863	13.06	25.34	38.40	47.00	-8.60	QP 100	38	

**Above 1GHz:**

**Product** : BeaglePlay  
**Model/Type reference** : BeaglePlay  
**Power** : AC 230V/50Hz  
**Temperature** : 22°C  
**Mode** : Normal  
**Humidity** : 53%  
**Polarization** : Horizontal  
**Press** : 101kPa

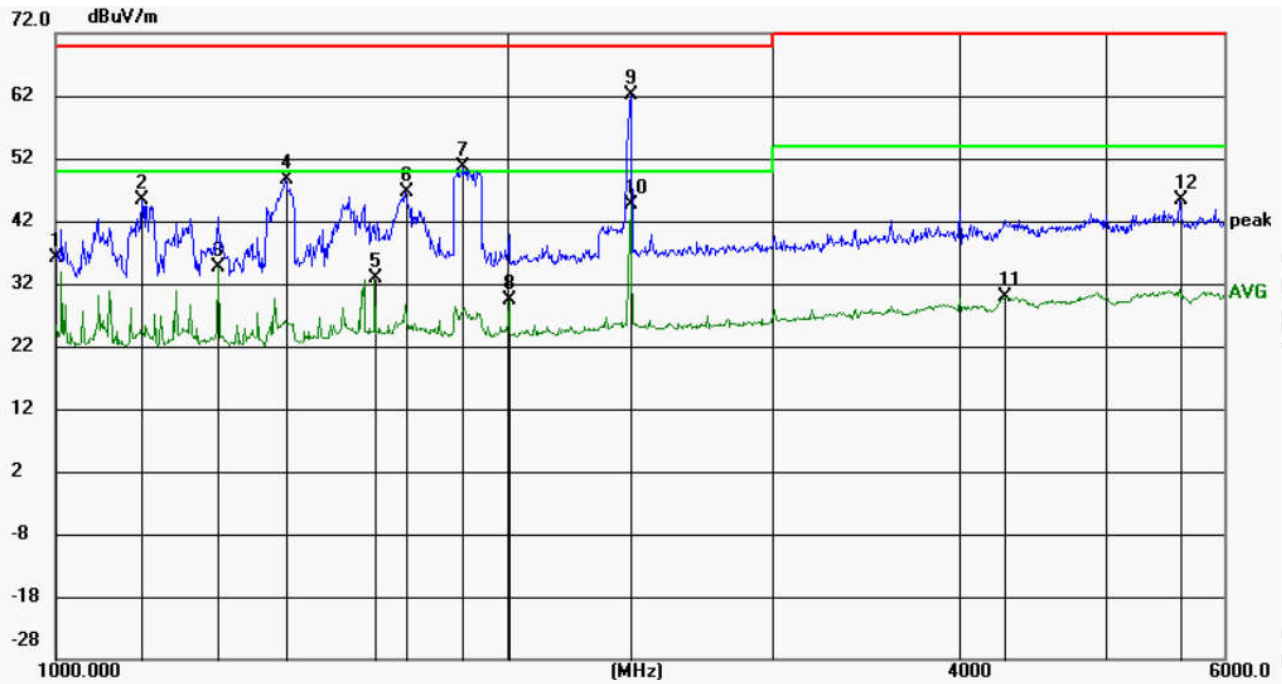

No. Mk.	Freq.	Reading Level	Correct Factor	Measurement	Limit	Margin	Antenna Height	Table Degree
	MHz	dBuV	dB	dBuV/m	dBuV/m	dB	cm	degree
1	1000.0000	50.87	-14.86	36.01	50.00	-13.99	100	340
2	1141.782	59.50	-14.12	45.38	70.00	-24.62	100	302
3	1282.812	48.24	-13.66	34.58	50.00	-15.42	200	348
4	1423.298	61.90	-13.20	48.70	70.00	-21.30	200	8
5	1630.930	45.24	-12.38	32.86	50.00	-17.14	100	302
6	1708.706	58.68	-12.06	46.62	70.00	-23.38	100	24
7	1868.851	62.10	-11.59	50.51	70.00	-19.49	100	24
8	2004.115	40.49	-11.00	29.49	50.00	-20.51	100	62
9	2414.629	71.84	-9.63	62.21	70.00	-7.79	200	356
10 *	2414.629	54.38	-9.63	44.75	50.00	-5.25	200	356
11	4291.775	33.14	-3.16	29.98	54.00	-24.02	100	124
12	5605.076	46.65	-1.37	45.28	74.00	-28.72	200	159

**Product** : BeaglePlay  
**Model/Type reference** : BeaglePlay  
**Power** : AC 230V/50Hz  
**Temperature** : 22°C  
**Mode** : Normal  
**Humidity** : 53%  
**Polarization** : Vertical  
**Press** : 101kPa

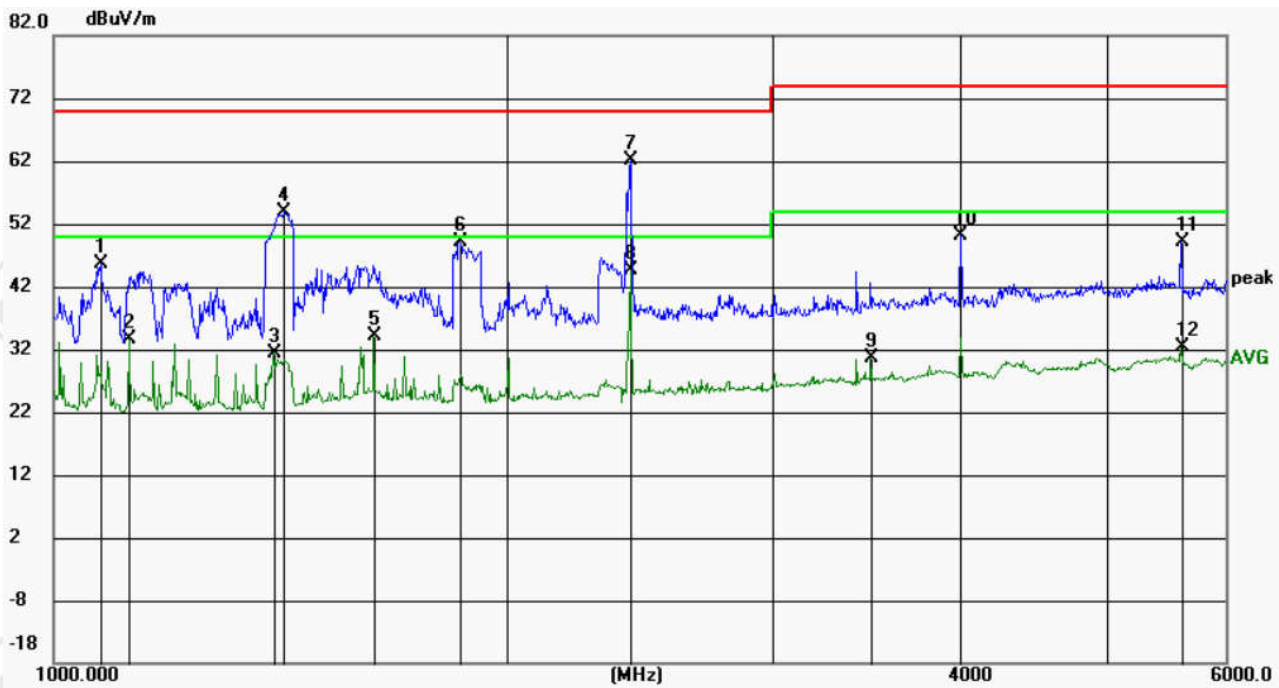

No.	Mk.	Freq.	Reading Level	Correct Factor	Measurement	Limit	Margin	Antenna Height	Table Degree	
		MHz	dBuV	dB	dBuV/m	dBuV/m	dB	cm	degree	Comment
1		1074.301	59.96	-14.44	45.52	70.00	-24.48	peak	100	184
2		1121.506	47.99	-14.25	33.74	50.00	-16.26	AVG	100	19
3		1398.023	44.60	-13.31	31.29	50.00	-18.71	AVG	200	4
4		1420.750	67.07	-13.21	53.86	70.00	-16.14	peak	200	4
5		1630.930	46.50	-12.38	34.12	50.00	-15.88	AVG	100	356
6		1858.833	60.61	-11.60	49.01	70.00	-20.99	peak	200	314
7		2414.629	71.85	-9.63	62.22	70.00	-7.78	peak	200	137
8	*	2414.629	54.25	-9.63	44.62	50.00	-5.38	AVG	200	137
9		3486.354	36.56	-6.04	30.52	54.00	-23.48	AVG	100	336
10		4002.110	55.42	-5.31	50.11	74.00	-23.89	peak	200	302
11		5605.076	50.48	-1.37	49.11	74.00	-24.89	peak	100	323
12		5605.076	33.81	-1.37	32.44	54.00	-21.56	AVG	100	323

**Note:**

1. Margin=Measurement-Limit.
2. Measurement=Reading\_Level+Correct Factor.
3. Correct Factor=Ant Factor+Cable loss.
4. Through Pre-scan, AC230V/50Hz of Adapter 1 was the worst case; only the worst case was in the report.



## 6.1.2 Conducted Emission

### 1) For AC Main Port

**Test Requirement:** EN 301 489-3 Clause 7.1, EN 301 489-17 Clause 7.1

**Test Method:** EN 301 489-1 Clause 8.4.2

**Detector:** Peak for pre-scan (9kHz Resolution Bandwidth)  
Quasi-Peak if maximized peak within 6dB of Quasi-Peak limit

### EUT Operation:

**Ambient:** Temp.: 24°C Humid.: 52% Press.: 1010mbar  
**Test Mode:** Wi-Fi mode, Bluetooth mode, 2.4G mode  
**Test Status:** Pretest the EUT at different test mode and found the Wi-Fi mode which is worst case, the test worst case mode is recorded in the report.

**Equipment Used:** Refer to section 5 for details.

**Limit:** Limits for conducted disturbance at the mains ports of class B

Frequency Range (MHz)	Class B Limit (dB $\mu$ V)	
	Quasi-peak	Average
0.15 to 0.50	66 to 56	56 to 46
0.50 to 5	56	46
5 to 30	60	50

NOTE 1: The limit decreases linearly with the logarithm of the frequency in the range 0.15 MHz to 0.50 MHz.  
NOTE 2: The lower limit is applicable at the transition frequency.

### Test Setup:

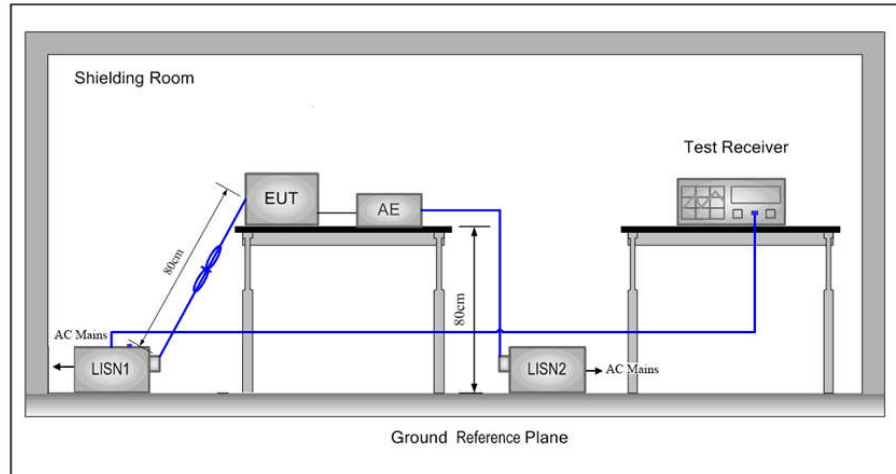

### Test Procedure:

- 1) The mains terminal disturbance voltage test was conducted in a shielded room.
- 2) The EUT was connected to AC power source through a LISN 1 (Line Impedance Stabilization Network) which Provides a 50 $\Omega$ /50 $\mu$ H + 5 $\Omega$  linear impedance. The power cables of all other units of the EUT were connected to a second LISN 2, which was bonded to the ground reference plane in the same way as the LISN 1 for the unit being measured. A multiple socket outlet strip was used to connect multiple power cables to a single LISN Provided the rating of the LISN was not exceeded.
- 3) The tabletop EUT was placed upon a non-metallic table 0.8m above the ground reference plane. And for floor-standing arrangement, the EUT was placed on the horizontal ground reference plane.
- 4) The test was performed with a vertical ground reference plane. The rear of the EUT shall be 0.4 m from the vertical ground reference plane. The vertical ground reference plane was bonded to the horizontal ground reference plane. The LISN 1 was placed 0.8 m from the boundary of the unit under test and bonded to a ground reference plane for LISNs mounted on top of the ground reference plane. This distance was between the closest points of the LISN 1 and the EUT. All other units of the EUT and associated equipment was at least 0.8 m from the LISN 2.

Test result: PASS

Measurement Data:

For AC mains power port:

**Product** : BeaglePlay  
**Model/Type reference** : BeaglePlay  
**Power** : AC 230V/50Hz  
**Mode** : Normal  
**Phase** : L1  
**Temperature** : 24°C  
**Humidity** : 52%  
**Press** : 101kPa

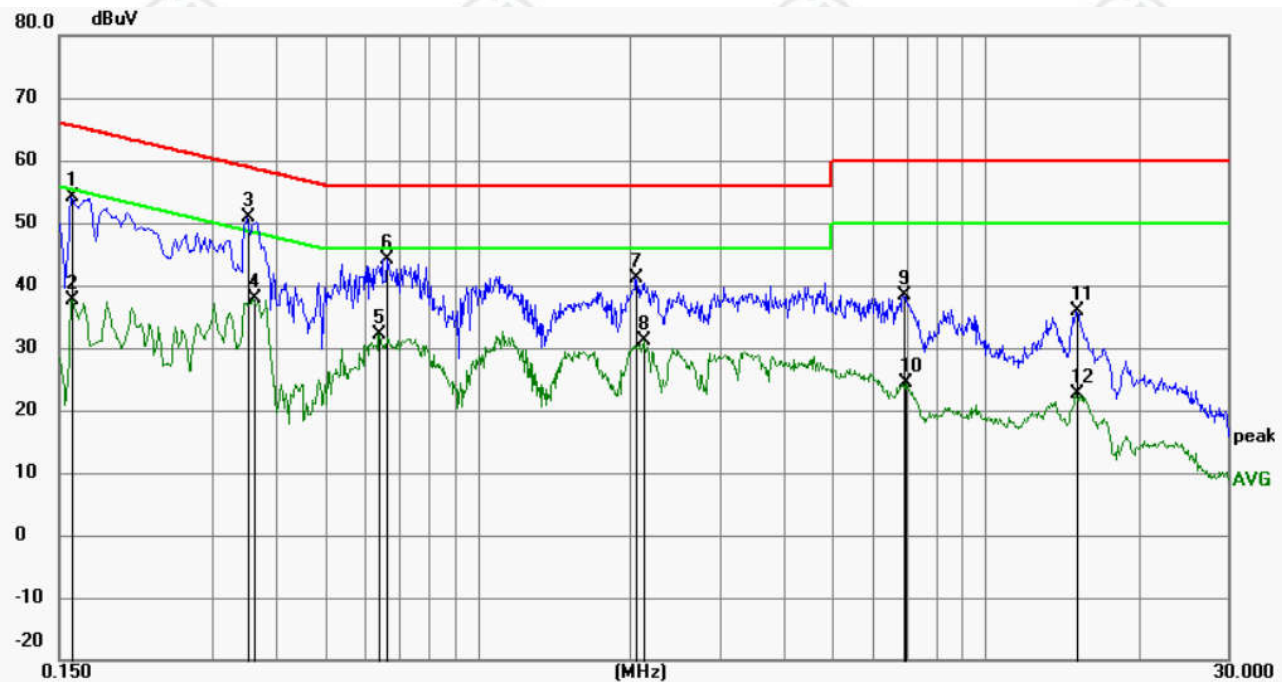

No.	Mk.	Freq. MHz	Reading Level dBuV	Correct Factor dB	Measure- ment dBuV	Limit dBuV	Margin dB	Detector	Comment
1		0.1590	44.28	9.87	54.15	65.52	-11.37	QP	
2		0.1590	27.85	9.87	37.72	55.52	-17.80	AVG	
3	*	0.3525	40.76	10.02	50.78	58.90	-8.12	QP	
4		0.3615	27.87	10.01	37.88	48.69	-10.81	AVG	
5		0.6405	22.07	9.99	32.06	46.00	-13.94	AVG	
6		0.6629	34.21	9.95	44.16	56.00	-11.84	QP	
7		2.0444	31.29	9.79	41.08	56.00	-14.92	QP	
8		2.1254	21.32	9.79	31.11	46.00	-14.89	AVG	
9		6.8910	28.62	9.79	38.41	60.00	-21.59	QP	
10		6.9540	14.50	9.79	24.29	50.00	-25.71	AVG	
11		15.1215	25.86	9.93	35.79	60.00	-24.21	QP	
12		15.1215	12.59	9.93	22.52	50.00	-27.48	AVG	

**Product** : BeaglePlay  
**Model/Type reference** : BeaglePlay  
**Power** : AC 230V/50Hz  
**Temperature** : 24°C  
**Mode** : Normal  
**Humidity** : 52%  
**Phase** : N  
**Press** : 101kPa

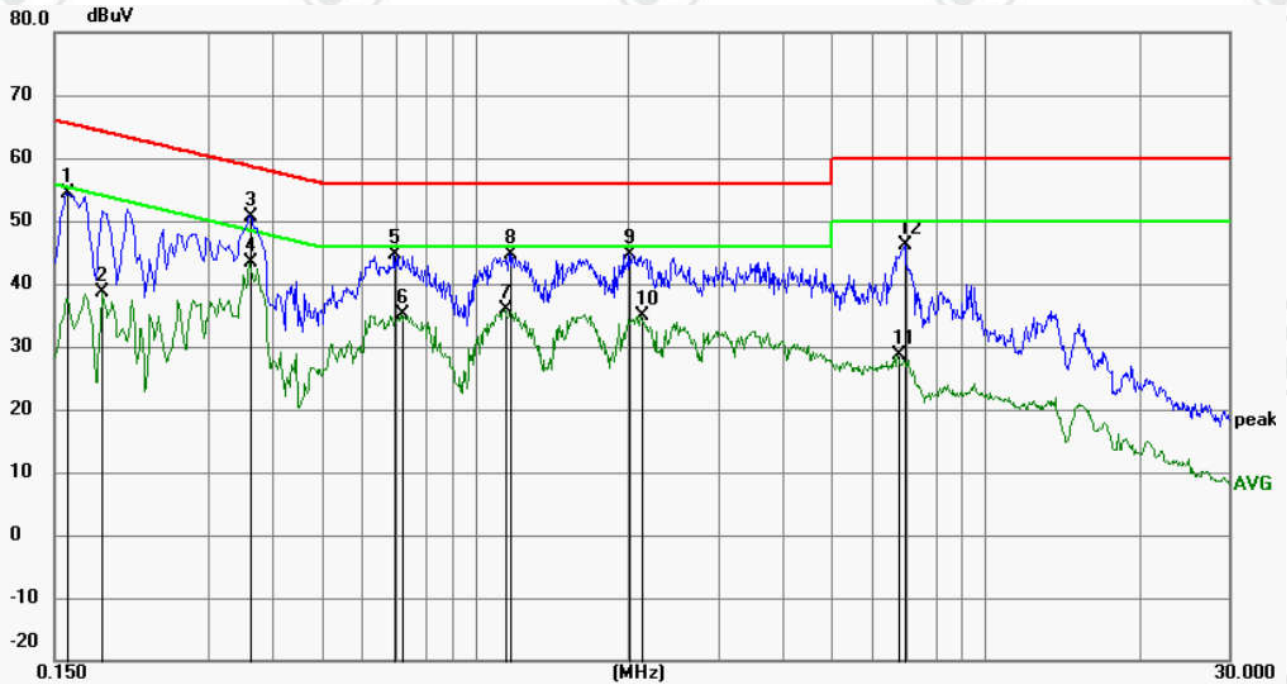

No.	Mk.	Freq. MHz	Reading Level dBuV	Correct Factor dB	Measure- ment dBuV	Limit dBuV	Margin dB	Detector	Comment
1		0.1590	44.54	9.87	54.41	65.52	-11.11	QP	
2		0.1860	28.65	9.87	38.52	54.21	-15.69	AVG	
3		0.3615	40.74	10.01	50.75	58.69	-7.94	QP	
4	*	0.3615	33.33	10.01	43.34	48.69	-5.35	AVG	
5		0.6944	34.85	9.89	44.74	56.00	-11.26	QP	
6		0.7169	25.25	9.87	35.12	46.00	-10.88	AVG	
7		1.1444	26.03	9.82	35.85	46.00	-10.15	AVG	
8		1.1669	34.90	9.82	44.72	56.00	-11.28	QP	
9		2.0039	34.81	9.79	44.60	56.00	-11.40	QP	
10		2.1164	24.99	9.79	34.78	46.00	-11.22	AVG	
11		6.7515	18.82	9.79	28.61	50.00	-21.39	AVG	
12		6.9630	36.26	9.79	46.05	60.00	-13.95	QP	



**Telecommunication ports:**

**Product** : BeaglePlay  
**Model/Type reference** : BeaglePlay  
**Power** : AC230V/50Hz  
**Temperature** : 24℃  
**Mode** : Normal  
**Humidity** : 52%  
**Note** : 100Mb/s  
**Press** : 101kPa

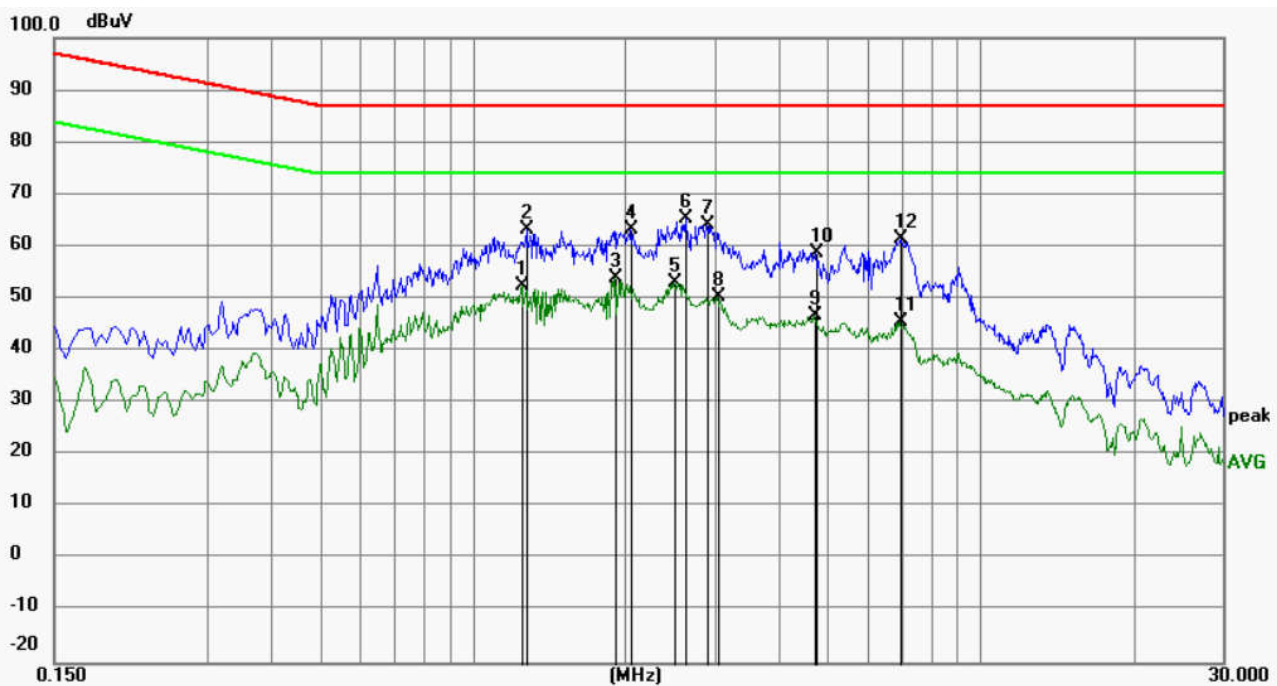

No.	Mk.	Freq. MHz	Reading Level dBuV	Correct Factor dB	Measure- ment dBuV	Limit dBuV	Margin dB	Detector	Comment
1		1.2525	42.81	9.67	52.48	74.00	-21.52	AVG	
2		1.2795	53.66	9.67	63.33	87.00	-23.67	QP	
3	*	1.9005	44.07	9.81	53.88	74.00	-20.12	AVG	
4		2.0445	53.57	9.83	63.40	87.00	-23.60	QP	
5		2.4990	43.25	9.80	53.05	74.00	-20.95	AVG	
6		2.6250	55.43	9.79	65.22	87.00	-21.78	QP	
7		2.8905	54.37	9.77	64.14	87.00	-22.86	QP	
8		3.0300	40.70	9.76	50.46	74.00	-23.54	AVG	
9		4.7085	36.97	9.65	46.62	74.00	-27.38	AVG	
10		4.7310	49.24	9.65	58.89	87.00	-28.11	QP	
11		6.9315	35.98	9.56	45.54	74.00	-28.46	AVG	
12		6.9720	51.86	9.56	61.42	87.00	-25.58	QP	



**Product** : BeaglePlay  
**Model/Type reference** : BeaglePlay  
**Power** : AC230V/50Hz  
**Temperature** : 24°C  
**Mode** : Normal  
**Humidity** : 52%  
**Note** : 1000Mb/s  
**Press** : 101kPa

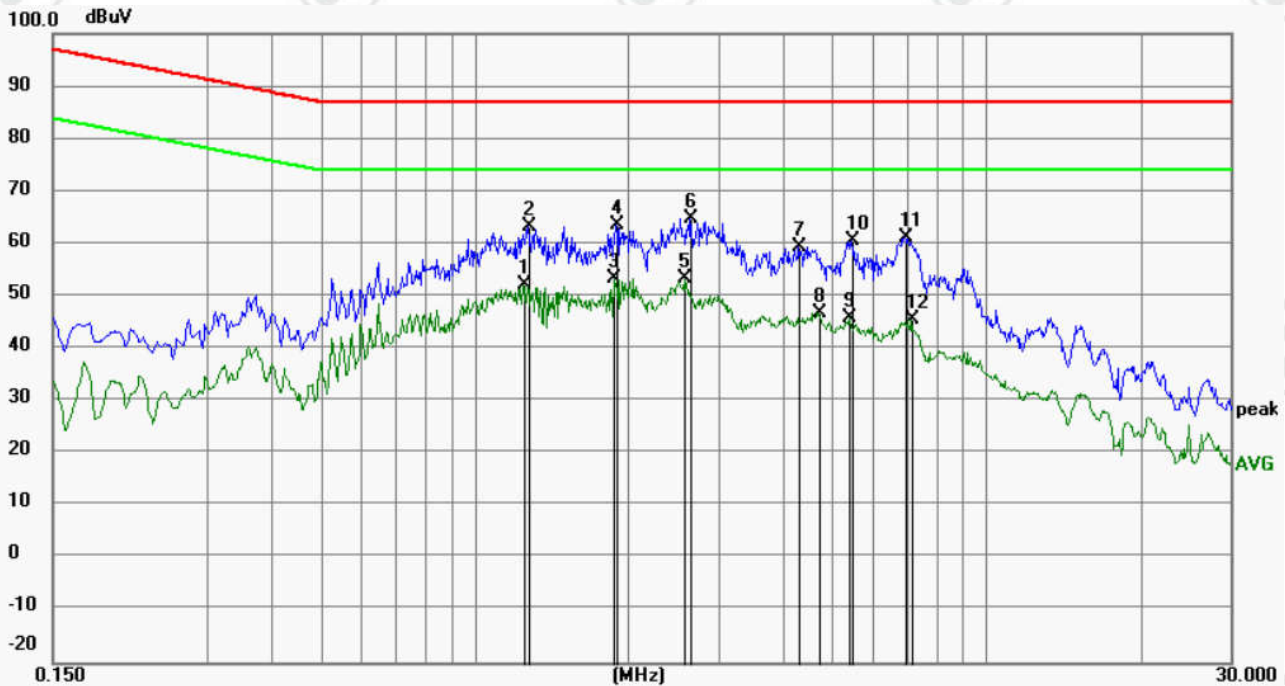

No.	Mk.	Freq. MHz	Reading Level dBuV	Correct Factor dB	Measure- ment dBuV	Limit dBuV	Margin dB	Detector	Comment
1		1.2480	42.56	9.66	52.22	74.00	-21.78	AVG	
2		1.2750	53.73	9.67	63.40	87.00	-23.60	QP	
3		1.8735	43.48	9.80	53.28	74.00	-20.72	AVG	
4		1.8960	53.67	9.81	63.48	87.00	-23.52	QP	
5	*	2.5710	43.54	9.79	53.33	74.00	-20.67	AVG	
6		2.6475	55.04	9.79	64.83	87.00	-22.17	QP	
7		4.2990	49.58	9.68	59.26	87.00	-27.74	QP	
8		4.7040	37.01	9.65	46.66	74.00	-27.34	AVG	
9		5.4015	36.10	9.62	45.72	74.00	-28.28	AVG	
10		5.4600	50.87	9.61	60.48	87.00	-26.52	QP	
11		6.9225	51.54	9.56	61.10	87.00	-25.90	QP	
12		7.1655	35.92	9.56	45.48	74.00	-28.52	AVG	

**Note:**

1. Margin=Measurement-Limit.
2. Measurement=Reading\_Level+Correct Factor.
3. Correct Factor=Cable Factor+Lisn Factor.
4. Through Pre-scan, AC230V/50Hz of Adapter 1 was the worst case; only the worst case was in the report.

## 6.1.3 Flicker Test Results

**Test Requirement:** EN 301 489-3 Clause 7.1, EN 301 489-17 Clause 7.1

**Test Method:** EN 301 489-1 Clause 8.6

### EUT Operation:

**Ambient:** Temp.: 22°C Humid.: 53% Press.: 1010mbar

**Test Mode:** Wi-Fi mode, Bluetooth mode, 2.4G mode and Standby mode

**Test Status:** Pretest the EUT at different test mode and found the Wi-Fi mode which is worst case, the test worst case mode is recorded in the report.

**Equipment Used:** Refer to section 5 for details.

### Test Setup:

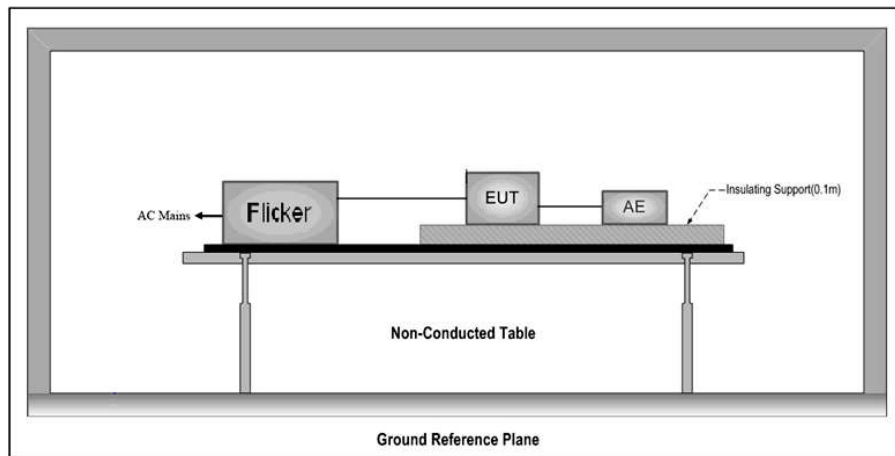

**Test result:** PASS

### Test Data:

## Maximum Flicker results

Test Result: Pass

Status: Test Completed

### Pst<sub>i</sub> and limit line

### European Limits

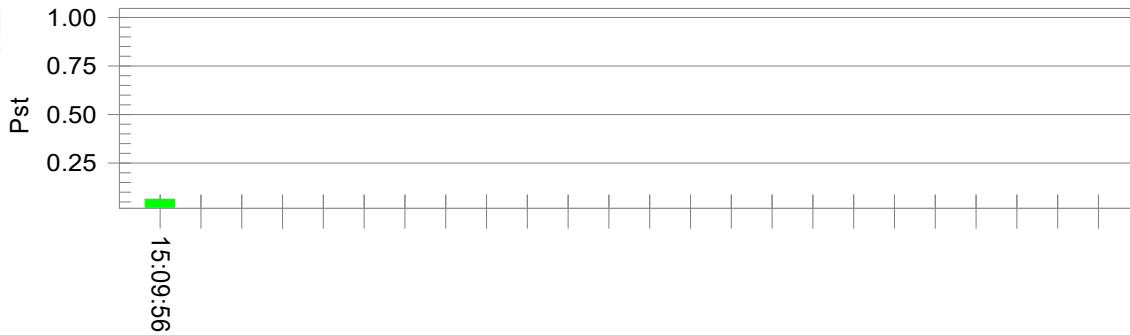

### Plt and limit line

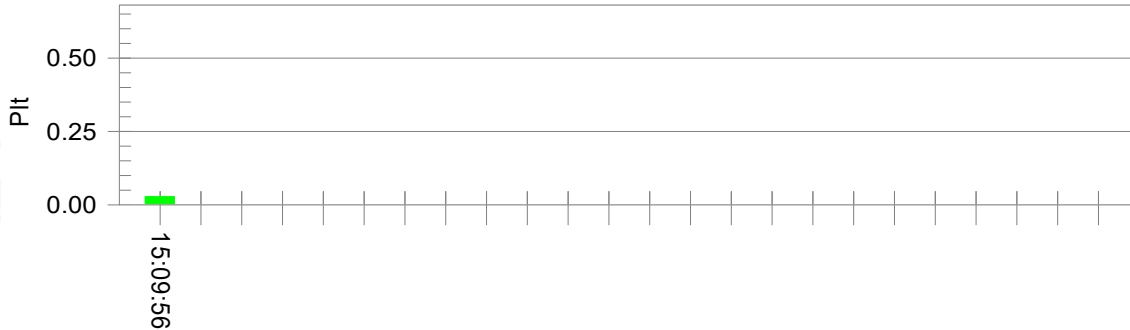

### Parameter values recorded during the test:

Vrms at the end of test (Volt):	229.36		
T-max (mS):	0	Test limit (mS):	500.0 Pass
Highest dc (%):	0.00	Test limit (%):	3.30 Pass
Highest dmax (%):	0.00	Test limit (%):	4.00 Pass
Highest Pst (10 min. period):	0.064	Test limit:	1.000 Pass
Highest Plt (2 hr. period):	0.028	Test limit:	0.650 Pass

## 6.2 EMS (Immunity)

Performance Criteria of EN 301 489-3, sub clause 6.2 table 2.

**Table 2: Performance Requirements**

Criterion	During test	After test
A	Operate as intended No loss of function No unintentional responses	Operate as intended No loss of function No degradation of performance No loss of stored data or user programmable functions
B	May show loss of function No unintentional responses	Operate as intended Lost function(s) shall be self-recoverable No degradation of performance No loss of stored data or user programmable functions

Performance Criteria of EN 301 489-17, sub clause 6.2.1 table 2.

**Table 2: Performance criteria**

Criteria	During test	After test (i.e. as a result of the application of the test)
A	Shall operate as intended. (See note). Shall be no loss of function. Shall be no unintentional transmissions.	Shall operate as intended. Shall be no degradation of performance. Shall be no loss of function. Shall be no loss of critical stored data.
B	May be loss of function.	Functions shall be self-recoverable. Shall operate as intended after recovering. Shall be no loss of critical stored data.
C	May be loss of function.	Functions shall be recoverable by the operator. Shall operate as intended after recovering. Shall be no loss of critical stored data.

NOTE: Operate as intended during the test allows a level of degradation in accordance with clause 6.2.2.



## 6.2.1 Radiated Immunity

<b>Test Requirement:</b>	EN 301 489-3 Clause 7.1&7.3, EN 301 489-17 Clause 7.2		
<b>Test Method:</b>	EN 301 489-1 Clause 9.2.2		
<b>EUT Operation:</b>			
Ambient:	Temp.: 22°C	Humid.:53%	Press.: 1010mbar
Test Mode:	Wi-Fi mode, Bluetooth mode,2.4G mode and Standby mode		
<b>Criterion Required:</b>	A		
<b>Equipment Used:</b>	Refer to section 5 for details.		
<b>Test Setup:</b>			

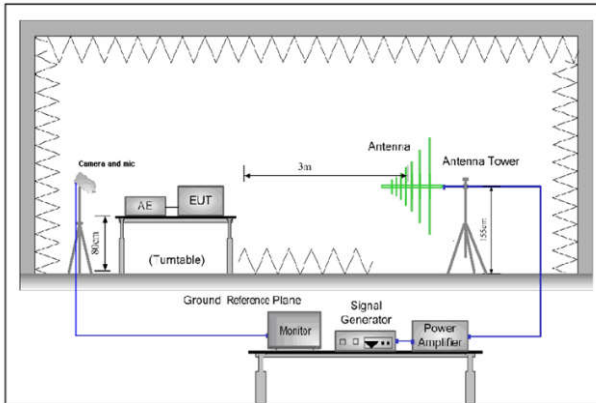

Figure 1. 80MHz to 1GHz

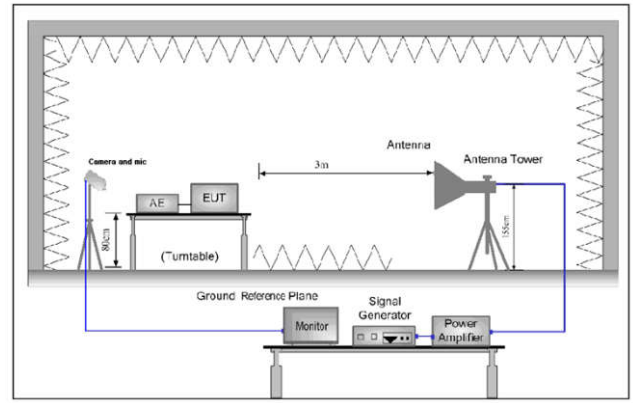

Figure 2. 1GHz to 6GHz

### Test Procedure:

- 1) For table-top equipment, the EUT was placed in the chamber on a non-conductive table 0.8m high. For arrangement of floor-standing equipment, the EUT was mounted on a non-conductive support 0.1m above the supporting plane. For human body-mounted equipment, the EUT may be tested in the same manner as table top items.
- 2) If possible, a minimum of 1 m of cable is exposed to the electromagnetic field. Excess length of cables interconnecting units of the EUT shall be bundled low-inductively in the approximate center of the cable to form a bundle 30 cm to 40 cm in length.
- 3) The EUT was initially placed with one face coincident with the calibration plane. The EUT face being illuminated was contained within the UFA (Uniform Field Area).
- 4) The frequency ranges to be considered were swept with the signal modulated and pausing to adjust the RF signal level or to switch oscillators and antennas as necessary. Where the frequency range was swept incrementally, the step size was not exceed 1% of the preceding frequency value.
- 5) The dwell time of the amplitude modulated carrier at each frequency was not be less than the time necessary for the EUT to be exercised and to respond, and was not less than 0.5 s.
- 6) The test normally was performed with the generating antenna facing each side of the EUT.
- 7) The polarization of the field generated by each antenna necessitates testing each selected side twice, once with the antenna positioned vertically and again with the antenna positioned horizontally.
- 8) The EUT was performed in a configuration to actual installation conditions, a video camera and/or an audio monitor were used to monitor the performance of the EUT.

### Test result:

PASS

### Test Data

Frequency	Level	Modulation	EUT Face	Antenna Polaxis	Result / Observations
80MHz-1GHz, 1GHz to 6GHz	3V/m	1kHz, 80% Amp. Mod, 1% increment Dwell time: 1 seconds	Front	V	A
				H	A
			Back	V	A
				H	A
			Left	V	A
				H	A
			Right	V	A
				H	A

### Remark:

A: No performance degradation during test.

## 6.2.2 ESD

<b>Test Requirement:</b>	EN 301 489-3 Clause 7.1, EN 301 489-17 Clause 7.2		
<b>Test Method:</b>	EN 301 489-1 Clause 9.3.2		
<b>EUT Operation:</b>			
Ambient:	Temp.: 22°C	Humid.: 53%	Press.: 1010 mbar
Test Mode:	Wi-Fi mode, Bluetooth mode, 2.4G mode and Standby mode		
<b>Criterion Required:</b>	B		
<b>Discharge Impedance:</b>	330 Ω / 150 pF		
<b>Polarity:</b>	Positive & Negative		
<b>Number of Discharge:</b>	Minimum 10 times at each test point		
<b>Discharge Mode:</b>	Single Discharge		
<b>Discharge Period:</b>	1 second minimum		
<b>Equipment Used:</b>	Refer to section 5 for details.		
<b>Test Setup:</b>			

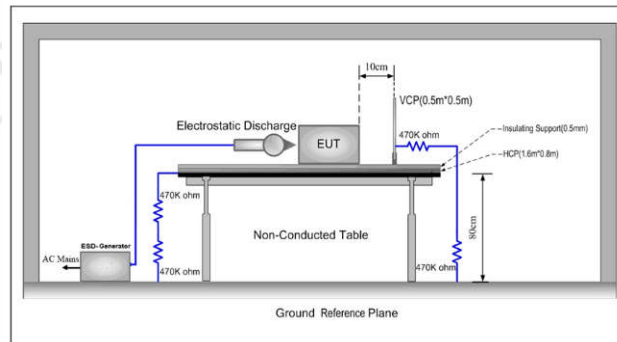

Test set-up for tabletop equipment

### Test Procedure:

- 1) Contact discharges to the conductive surfaces and to coupling planes:  
The EUT was exposed to at least 200 discharges, 100 each at negative and positive polarity, at a minimum of four test points (a minimum of 50 discharges at each point). One of the test points was subjected to at least 50 indirect discharges (contact) to the centre of the front edge of the horizontal coupling plane. The remaining three test points shall each receive at least 50 direct contact discharges. If no direct contact test points were available, then at least 200 indirect discharges were applied in the indirect mode. Tests were performed at a maximum repetition rate of one discharge per second.  
Air discharge at slots and apertures, and insulating surfaces:  
On those parts of the EUT where it was not possible to perform contact discharge testing, the equipment was investigated to identify user accessible points where breakdown may occur. This investigation was restricted to those areas normally handled by the user. A minimum of 10 single air discharges were applied to the selected test point for each such area.  
The application of electrostatic discharges to the contacts of open connectors was not required by this standard.
- 2) The EUT was put on a 0.8m high wooden table for table-top equipment or 0.1m high for floor standing equipment standing on the ground reference plane (GRP).
- 3) A horizontal coupling plane (HCP) 1.6m by 0.8m in size was placed on the table, and the EUT with its cables were isolated from the HCP by an insulating support thick than 0.5mm. The VCP 0.5m by 0.5m in size & HCP were constructed from the same material type & thickness as that of the GRP, and connected to the GRP via a 470kΩ resistor at each end. The distance between EUT and any of the other metallic surface excepted the GRP, HCP and VCP was greater than 1m.
- 4) During the contact discharges, the tip of the discharge electrode was touch the EUT before the discharge switch is operated. During the air discharges, the round

discharge tip of the discharge electrode was approached as fast as possible to touch the EUT.

- 5) After each discharge, the ESD generator was removed from the EUT, the generator was then retriggered for a new single discharge. For ungrounded Product, a discharge cable with two resistances was used after each discharge to remove remnant electrostatic voltage. 10 times of each polarity single discharge were applied to HCP and VCP.

**Test Results:** PASS

Observations:		Test Point:		
		<ol style="list-style-type: none"> <li>1. All insulated enclosure and seams.</li> <li>2. All accessible metal parts of the enclosure.</li> </ol>		
Direct Application Test Results				
Direct Application			Test Results	
Discharge Level (kV)	Pulse No.	Test Point	Contact Discharge	Air Discharge
± 8	10 for every level	1	N/A <sup>1</sup>	A
± 4	10 for every level	2	A	N/A <sup>1</sup>
Indirect Application for tabletop equipment Test Results				
Indirect Application			Test Results	
Discharge Level (kV)	Pulse No.	Horizontal Coupling	Vertical Coupling	
± 4	10 for every level	A	A	
Criterion Required:	B			

**Remark:**

A: No performance degradation during test.

N/A: Not applicable.



## 6.2.3 RF Common Mode 0.15MHz to 80MHz

<b>Test Requirement:</b>	EN 301 489-3 Clause 7.1&7.3, EN 301 489-17 Clause 7.2		
<b>Test Method:</b>	EN 301 489-1 Clause 9.5.2		
<b>Test Level:</b>	3V rms		
<b>Modulation:</b>	80%, 1kHz Amplitude Modulation		
<b>Test Port :</b>	AC port.		
<b>Criterion Required:</b>	A		
<b>EUT Operation:</b>			
Ambient:	Temp.: 22°C	Humid.: 53%	Press.: 1010mbar
Test Mode:	Wi-Fi mode, Bluetooth mode, 2.4G mode and Standby mode		
<b>Equipment Used:</b>	Refer to section 5 for details.		
<b>Test Setup:</b>			

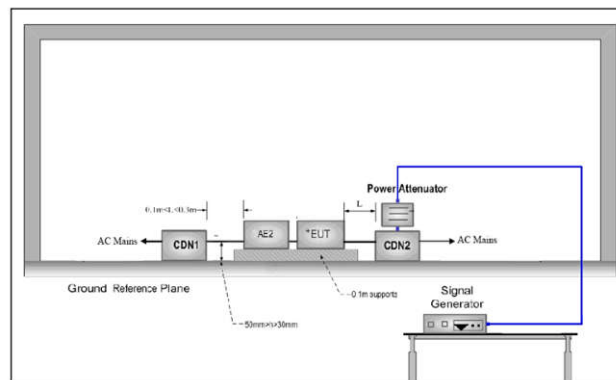

Figure 1. For AC port

### Test Procedure:

- 1) The EUT was placed on an insulating support of 0.1m height above a ground reference Plane, arranged and connected to satisfy its functional requirement. All cables exiting the EUT was supported at a height of at least 30 mm above the ground reference plane.
- 2) The coupling and decoupling devices were required, they were located between 0.1 m and 0.3 m from the EUT. This distance was to be measured horizontally from the Projection of the EUT on to the ground reference plane to the coupling and decoupling device.
- 3) Each AE, used with clamp injection, shall be placed on an insulating support 0.1 m above the ground reference plane. A decoupling network shall be installed on each cable between the EUT and AE except the cable under test. All cables connected to each AE, other than those being connected to the EUT, shall be Provided with decoupling networks. The decoupling networks connected to each AE (except those on cables between the EUT and AE) shall be applied no further than 0.3 m from the AE. The cable(s) between the AE and the decoupling network (s) or in between the AE and the injection clamp shall not be bundled nor wrapped and shall be kept between 30 mm and 50 mm above the ground reference plane
- 4) The frequency range was swept from 150 kHz to 80 MHz, using the signal levels established during the setting Process, and with the disturbance signal 80 % amplitude modulated with a 1 kHz sine wave, pausing to adjust the RF signal level or to change coupling devices as necessary. Where the frequency was swept incrementally, the step size does not exceed 1 % of the preceding frequency value. The dwell time of the amplitude modulated carrier at each frequency was not less than the time necessary for the EUT to be exercised and to respond, and was not less than 0.5 s.

### Test result:

PASS

**Test data:**

Frequency	Line	Test Level	Modulation	Step Size	Dwell Time	Observation (Performance Criterion)
150kHz to 80MHz	AC port	3Vrms	80%, 1kHz Amp. Mod.	1%	2 S	A

**Remark:**

A: No performance degradation during test.

## 6.2.4 Electrical Fast Transients (EFT)

<b>Test Requirement:</b>	EN 301 489-3 Clause 7.1, EN 301 489-17 Clause 7.2		
<b>Test Method:</b>	EN 301 489-1 Clause 9.4.2		
<b>Test Level:</b>	$\pm 0.5\text{kV}$ , $\pm 1.0\text{kV}$ on AC port.		
<b>Polarity:</b>	Positive & Negative		
<b>Repetition Frequency:</b>	5kHz		
<b>Burst Period:</b>	300ms		
<b>Test Duration:</b>	2 minute per level & polarity		
<b>EUT Operation:</b>			
<b>Ambient:</b>	Temp.: 22°C	Humid.: 53%	Press.: 1010mbar
<b>Test Mode:</b>	Wi-Fi mode, Bluetooth mode, 2.4G mode and Standby mode		
<b>Equipment Used:</b>	Refer to section 5 for details.		
<b>Test Setup:</b>			

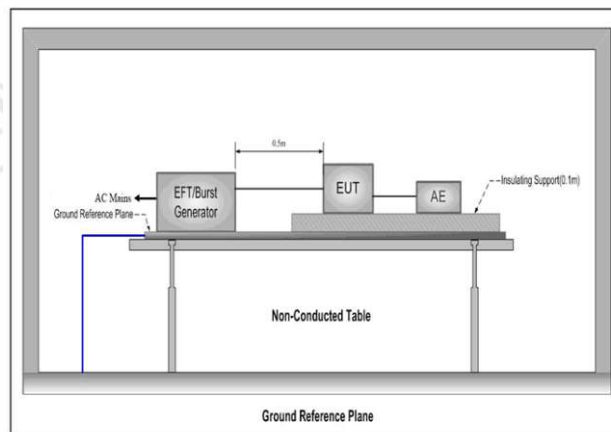

Figure 1. For AC port

### Test Procedure:

- 1) The EUT was placed on a ground reference plane (GRP) insulated by an insulating support 0.1m thick and the GRP was placed on a 0.8m high wooden table for table-top equipment. For floor standing equipment, the EUT was placed on a 0.1m high wooden support above the GRP.
- 2) The GRP shall extend beyond the EUT and the clamp by at least 0.1m on all sides. The distance between the EUT and any other of the metallic surface except the GRP was greater than 0.5m. All cables to the EUT were placed on the insulating support 0.1m above GRP. A cable not subject to EFT was routed as far as possible from cable under test to minimize the coupling between the cables.
- 3) The length of signal and power cable between the EUT and EFT generator was 0.5m. If the cable is a non-detachable supply cable more than 0.5m, the excess length of this cable shall be folded to avoid a flat coil and situated at a distance of 0.1m above the GRP.
- 4) The EUT was conducted the below specified test voltages for line and neutral or line, neutral and earth simultaneously (for telecommunication, single, control and DC port line with capacitive coupling clamp), 120 seconds duration. If the equipment contains identical ports, only one was tested; multicomputer cables, such as a 50-pair telecommunication cable, were tested as a single cable. Cables did not be split or divided into groups of conductors for this test; interface ports, which were intended by the manufacturer to be connected to data cables not longer than 3 m, did not be tested.

### Test result:

PASS

**Test data:**

Lead under Test	Level (kV)	Coupling Direct/Clamp	Observations (Performance Criterion)
Live	± 1.0	Direct	A
Neutral	± 1.0	Direct	A
Live, Neutral	± 1.0	Direct	A

**Remark:**

A: No performance degradation during test.



## 6.2.5 Surge

<b>Test Requirement:</b>	EN 301 489-3 Clause 7.1, EN 301 489-17 Clause 7.2		
<b>Test Method:</b>	EN 301 489-1 Clause 9.8.2		
<b>Test Level:</b>	For AC port ± 1kV Live to Neutral		
<b>Criterion Required:</b>	B		
<b>Polarity:</b>	Positive & Negative		
<b>Interval:</b>	60s between each surge		
<b>No. of Surges:</b>	5 positive, 5 negative at 0°, 90°, 180°, 270°.		
<b>EUT Operation:</b>			
<b>Ambient:</b>	Temp.: 22°C	Humid.: 53%	Press.: 1010mbar
<b>Test Mode:</b>	Wi-Fi mode, Bluetooth mode, 2.4G mode and Standby mode		
<b>Equipment Used:</b>	Refer to section 5 for details.		
<b>Test Setup:</b>			

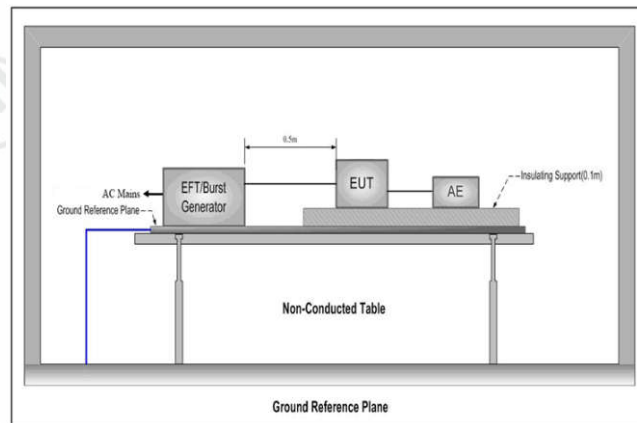

Figure 1. For AC port

### Test Procedure:

- 1) The EUT was placed on a ground reference plane (GRP) insulated by an insulating support 0.1 m thick and the GRP was placed on a 0.8m high wooden table for table-top equipment. For floor standing equipment, the EUT was placed on a 0.1m high wooden support above the GRP.
- 2) The 1.2/50 μs surge was to be applied to the EUT power supply terminals via the capacitive coupling network. Decoupling networks were required in order to avoid possible adverse effects on equipment not under test that may be powered by the same lines and to provide sufficient decoupling impedance to the surge wave so that the specified wave may be applied on the lines under test.
- 3) The power cord between the EUT and the coupling/decoupling network was not exceed 2 m in length. The interconnection line between the EUT and the coupling/decoupling network shall not exceed 2 m in length.
- 4) The EUT was conducted 0.5 kV and 1 kV test voltage for line to line and line to neutral and conducted 0.5 kV, 1 kV and 2 kV test voltage for line to earth and neutral to earth, five positive pulses and five negative pulses each at 0°, 90°, 180° and 270° for a.c. power ports and five positive pulses and five negative surge pulses for d.c. power ports (for telecommunication port, it was 0.5 kV for indoor cable longer than 10m line to ground and 0.5kV, 1kV test voltage for outdoor cable line to ground, five positive pulses and five negative surge pulses), The test levels were applied on the EUT with a 2 Ω generator source impedance for power supply terminals and 40Ω output impedance for interconnection lines. The tests were done at repetition rate one per minute.

### Test result:

PASS

**Test data:**

For AC port (2 line)					
Pulse No	Line-Line	Level (kV)	Surge interval	phase (deg)	Observation (Performance Criterion)
1-10	L-N	+1/-1	60s	0°	A
11-20	L-N	+1/-1	60s	90°	A
21-30	L-N	+1/-1	60s	180°	A
31-40	L-N	+1/-1	60s	270°	A

**Remark:**

A: No performance degradation during test.

## 6.2.6 Voltage Dips and Interruptions

**Test Requirement:** EN 301 489-3 Clause 7.1, EN 301 489-17 Clause 7.2  
**Test Method:** EN 301 489-1 Clause 9.7.2  
**Test Level:** Voltage dip: 0 % residual voltage for 0.5 cycle;  
 Voltage dip: 0 % residual voltage for 1 cycle;  
 Voltage dip: 70 % residual voltage for 25 cycles(at 50 Hz),30 cycles(at 60 Hz)  
 Voltage interruption: 0 % residual voltage for 250 cycles(at 50 Hz),300 cycles(at 60 Hz).

**No. of Dips / Interruptions:** 3 per Level

### EUT Operation:

**Ambient:** Temp.: 22°C Humid.: 53% Press.:1010mbar  
**Test Mode:** Wi-Fi mode, Bluetooth mode,2.4G mode and Standby mode

### Test Setup:

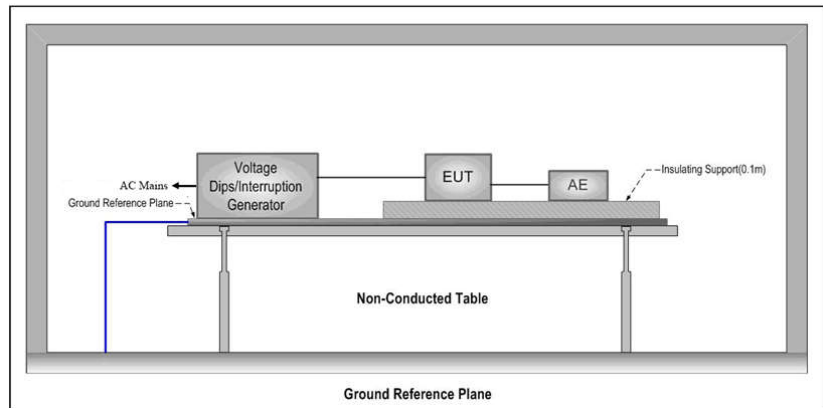

### Test Procedure:

- 1) The EUT was placed on a ground reference plane(GRP) insulated by an insulating support 0.1 m thick and the GRP was placed on a 0.8m high wooden table for table-top equipment. For floor standing equipment, the EUT was placed on a 0.1m high wooden support above the GRP.
- 2) The test was performed with the EUT connected to the test generator with the shortest power supply cable as specified by the EUT manufacturer.
- 3) The EUT was tested for each selected combination of test level and duration with a sequence of three dips /interruptions with intervals of 10 s minimum. Each representative mode of operation was tested.
- 4) For EUT with more than one power cord, each power cord was tested individually.

### Equipment Used:

Refer to section 5 for details.

### Test result:

PASS

**Test Results:****Voltage Dips:**

Test Level % UT	Reduction (%)	Number of cycles		Required Level	Performance criteria
		50Hz	60Hz		
<5	>95	0.5		B	A
<5	>95	1		B	A
70	30	25	30	C	A

**Voltage Interruptions:**

Test Level % UT	Reduction (%)	Number of cycles		Required Level	Performance criteria
		50Hz	60Hz		
<5	>95	250	300	C	A

## Remark:

A: No performance degradation during test.



**APPENDIX PHOTOGRAPHS OF TEST SETUP**

Test Model No.: BeaglePlay

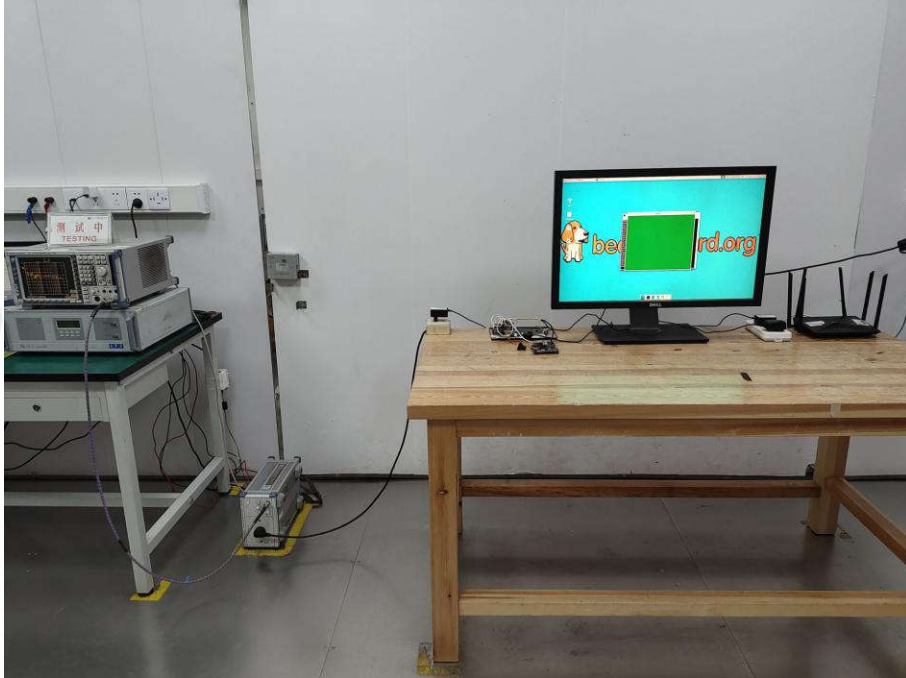

**CONDUCTED DISTURBANCE TEST SETUP-1**

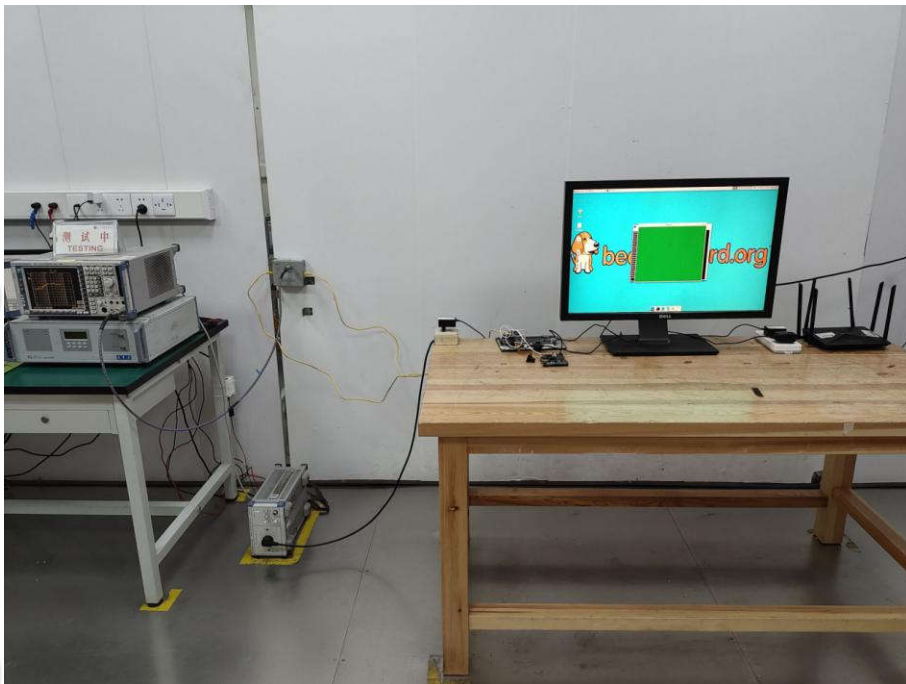

**CONDUCTED DISTURBANCE TEST SETUP-2**

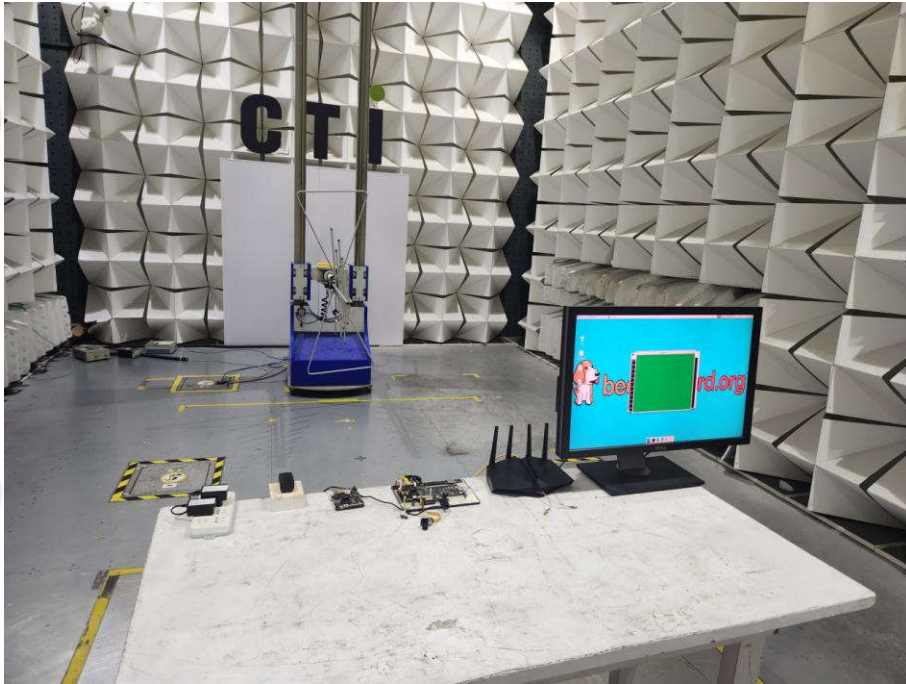

**RADIATED DISTURBANCE TEST SETUP-1**

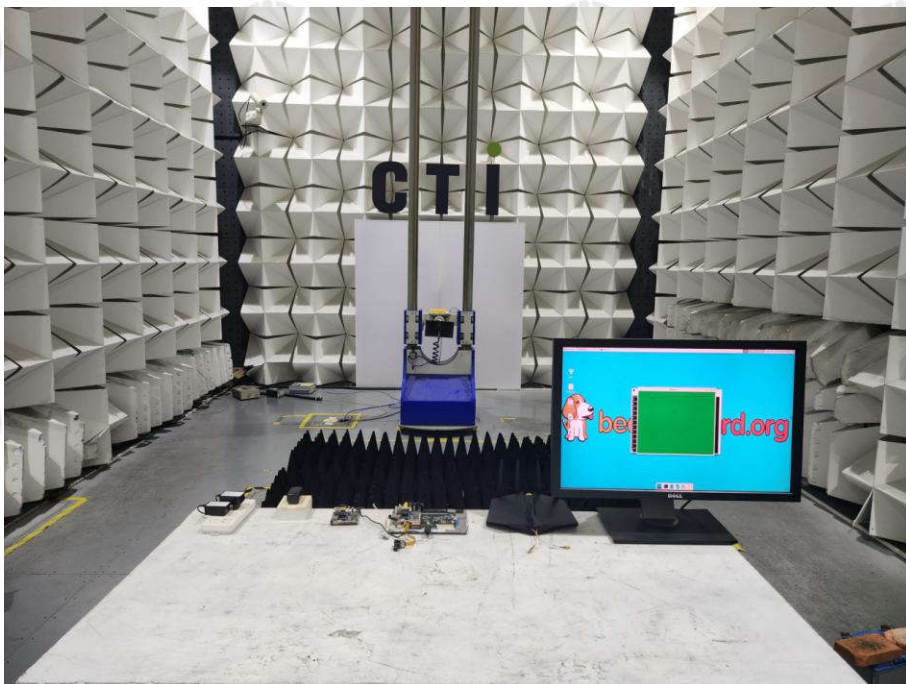

**RADIATED DISTURBANCE TEST SETUP-2**



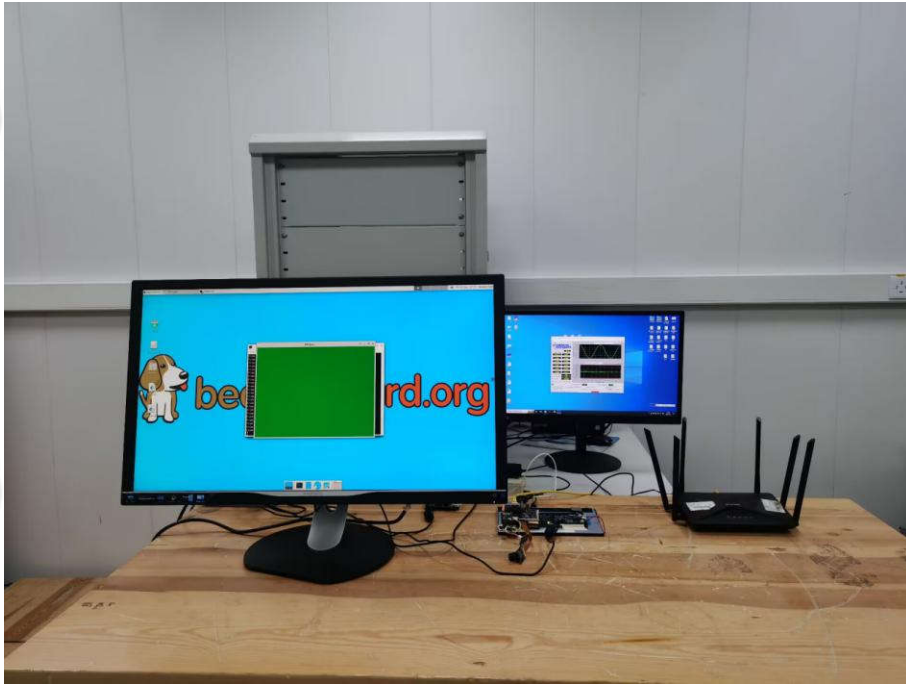

**FLICKER TEST SETUP**

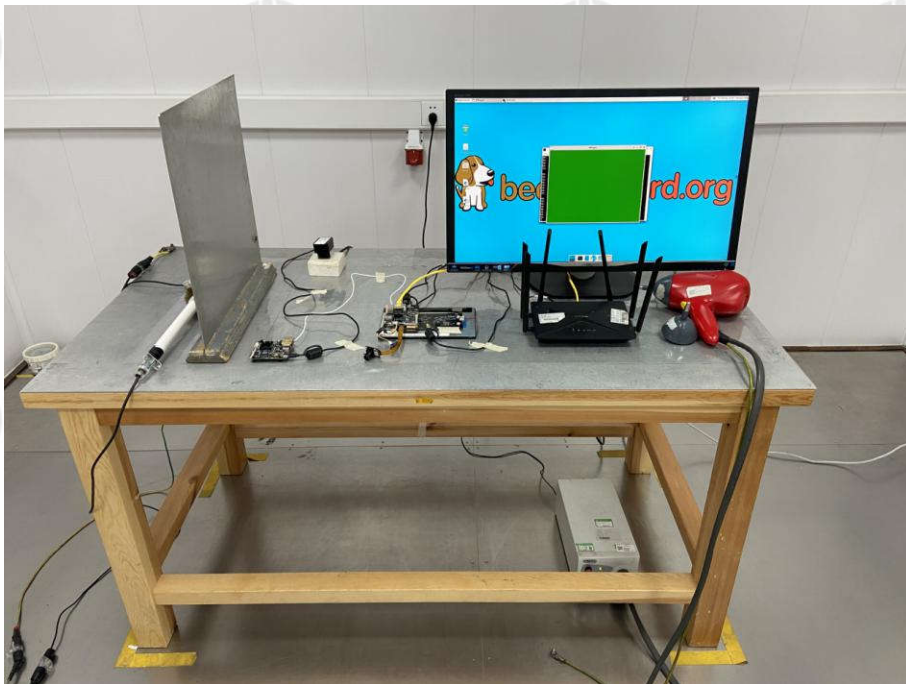

**ESD TEST SETUP**

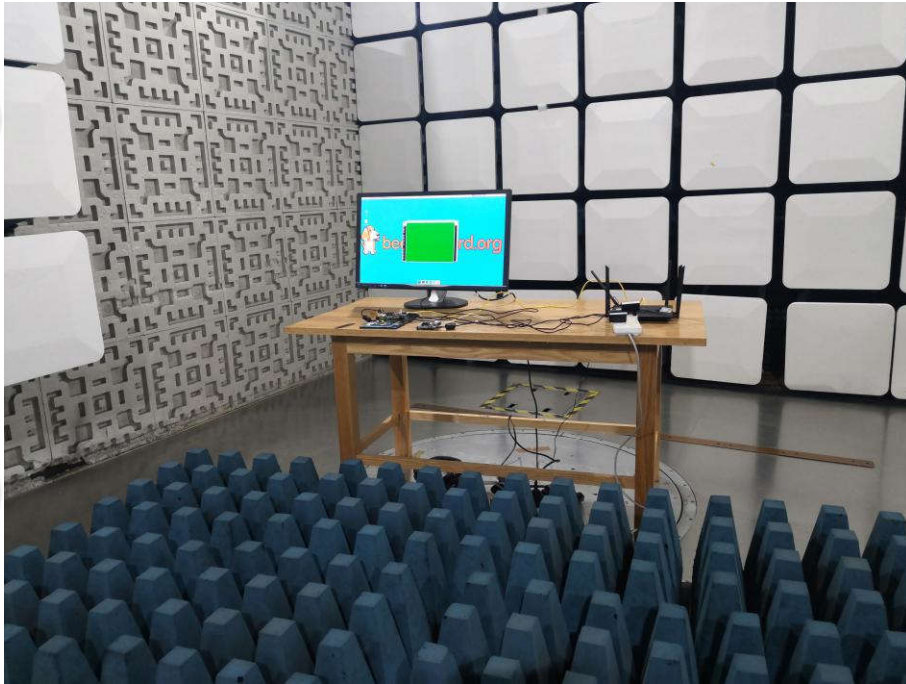

**RADIO-FREQUENCY ELECTROMAGNETIC FIELD IMMUNITY TEST SETUP**

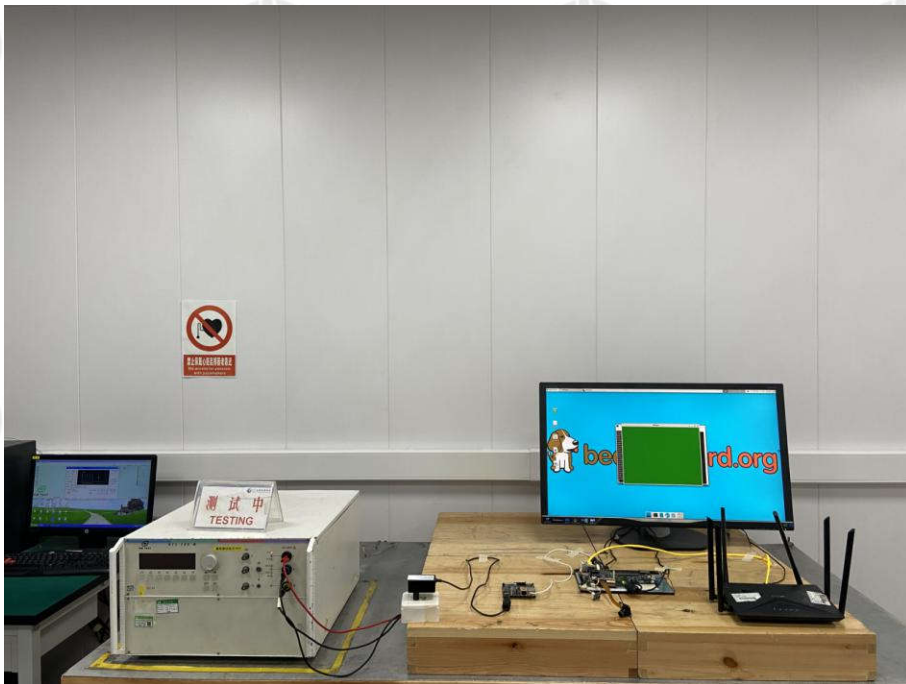

**EFT TEST SETUP-1**





**SURGES TEST SETUP**

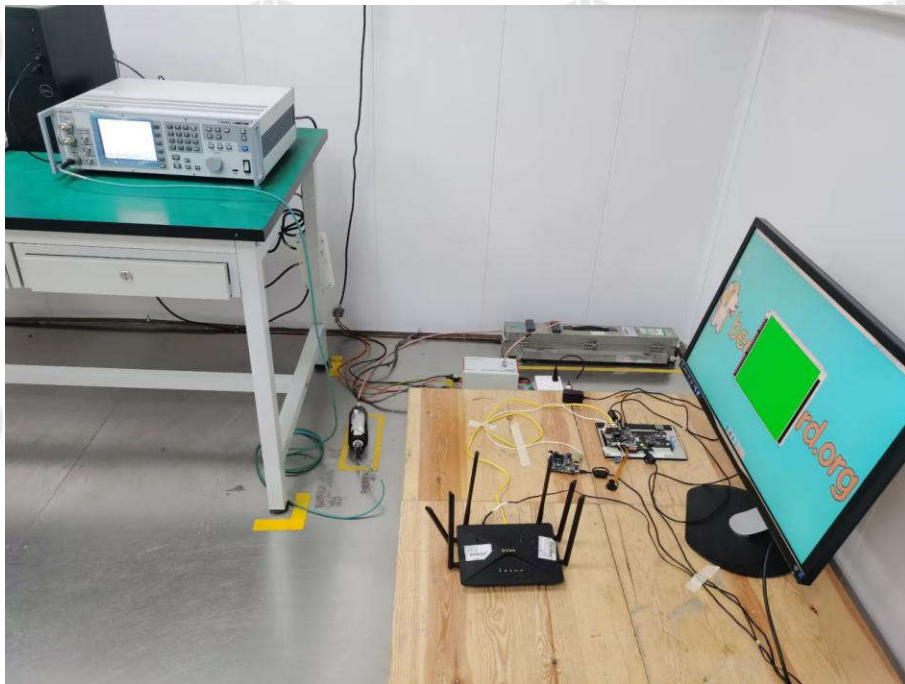

**RADIO-FREQUENCY CONTINUOUS CONDUCTED IMMUNITY TEST SETUP**

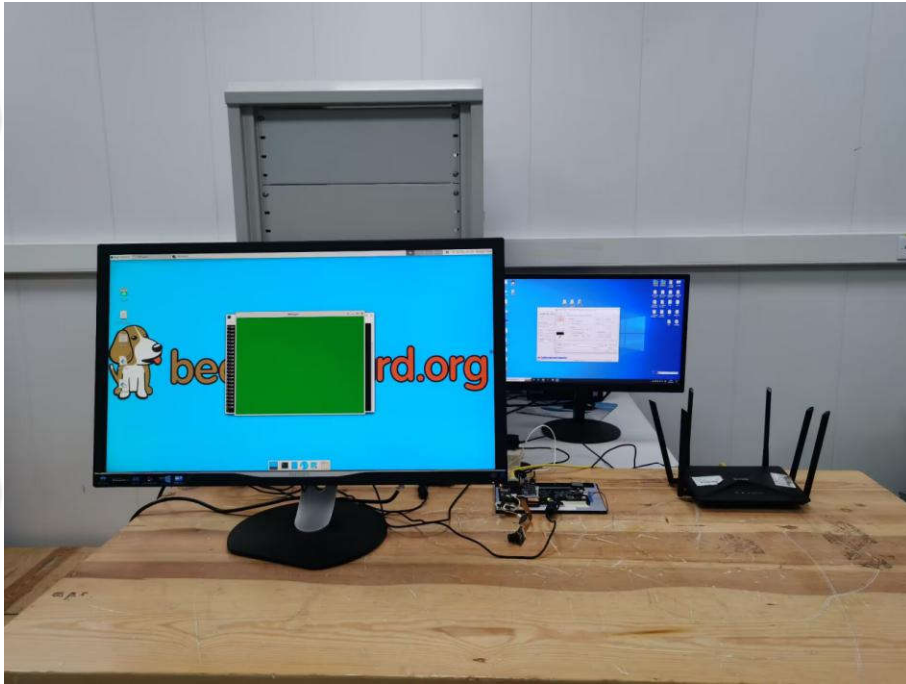

**VOLTAGE DIPS AND INTERRUPTIONS TEST SETUP**

## PHOTOGRAPHS OF EUT Constructional Details

Refer to Report No. EED32P80002301 for EUT external and internal photos.

The test report is effective only with both signature and specialized stamp, The result(s) shown in this report refer only to the sample(s) tested. Without written approval of CTI, this report can't be reProduced except in full.

\*\*\* End of Report \*\*\*

## TEST REPORT

IEC 62368-1

### Audio/video, information and communication technology equipment

### Part 1: Safety requirements

Report Number.....: EED31P800024

Tested by (name + signature).....: Sun Yangyang

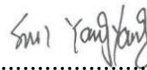

Reviewed by (name + signature)..: Leo Zeng



Approved by (name + signature)..: King Li

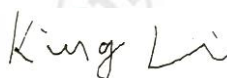

Lab Supervisor

Date of issue.....: Feb. 16, 2023

Total number of pages.....: 76 (including 2 attachments)

Testing Laboratory.....: Centre Testing International Group Co., Ltd.

Address.....: Hongwei Industrial Zone, Bao'an 70 District, Shenzhen, Guangdong, China

Applicant's name.....: Seeed Technology Co., Ltd.

Address.....: 9F, Building G3, TCL International E city, Zhongshanyuan Road, Nanshan, Shenzhen, China.

#### Test specification:

Standard.....: EN IEC 62368-1:2020+A11:2020

Test procedure.....: Test report

Non-standard test method.....: N/A

Test Report Form No.....: IEC62368\_1E

Test Report Form(s) Originator.....: UL(US)

Master TRF.....: Dated 2022-04-14

Test Item description.....: BeaglePlay

Trade Mark.....: Beagleboard.org

Manufacturer.....: Same as applicant

Model/Type reference.....: BeaglePlay

Ratings .....: 5V  3A

Check No.: 5404030123



**List of Attachments (including a total number of pages in each attachment):**

- Attachment 1 (27 pages): European group difference and national differences
- Attachment 2 (2 pages): Product photos

**Summary of testing:**

**Tests performed (name of test and test clause):**

The submitted samples were tested and found to comply with the requirements of:  
EN IEC 62368-1:2020+A11:2020

Refer to appended clause table for details

**Testing location:**

Centre Testing International Group Co., Ltd.  
Hongwei Industrial Zone, Bao'an 70 District, Shenzhen,  
Gongdong, China

**Summary of compliance with National Differences:**

- The product fulfils the requirements of EN IEC 62368-1:2020+A11:2020.

**Copy of marking plate**



**Note:**

- The above markings are the minimum requirements required by the safety standard. For the final production samples, the additional markings which do not give rise to misunderstanding may be added.
- The height dimension of CE and UKCA mark should not less than 5mm.

*As declared by the applicant the authorized EEA representative or importer was not decided at the time of application, but will be marked on the products before placing them on the market.*

*Note: According to ProdSG Art. 6 when placing the products on the market the authorized representative / importer within the European Economic Area (EEA) must be marked on the product if the manufacturer is not located within the EEA. Marking on the packaging is only acceptable if it is not possible to place such markings on the product.*

**Test item particulars:**

**Product group** .....:  end product  built-in component  
**Classification of use by**.....:  Ordinary person  
 Children likely present  
 Instructed person  
 Skilled person  
**Supply connection**.....:  AC mains  DC mains  
 not mains connected:  
 ES1  ES2  ES3  
**Supply tolerance** .....:  +10%/-10%  
 +20%/-15%  
 + %/ - %  
 None  
**Supply connection – type** .....:  pluggable equipment type A -  
 non-detachable supply cord  
 appliance coupler  
 direct plug-in  
 pluggable equipment type B -  
 non-detachable supply cord  
 appliance coupler  
 permanent connection  
 mating connector  
 other: Not directly connect to mains  
 A;  
**Considered current rating of protective device**.....: Location:  building  equipment  
 N/A  
**Equipment mobility**.....:  movable  hand-held  transportable  
 direct plug-in  stationary  for building-in  
 wall/ceiling-mounted  SRME/rack-mounted  
 other:  
**Overvoltage category (OVC)** .....:  OVC I  OVC II  OVC III  
 OVC IV  other: Not directly connect to mains  
**Class of equipment** .....:  Class I  Class II  Class III  
 Not classified   
**Special installation location** .....:  N/A  restricted access area  
 outdoor location   
**Pollution degree (PD)** .....:  PD 1  PD 2  PD 3  
**Manufacturer’s specified T<sub>ma</sub>**.....: 60 °C  Outdoor: minimum °C  
**IP protection class** .....:  IPX0  IP\_\_\_\_  
**Power systems** .....:  TN  TT  IT - V<sub>LL</sub>  
 not AC mains  
**Altitude during operation (m)** .....:  2000 m or less  m  
**Altitude of test laboratory (m)** .....:  2000 m or less  m  
**Mass of equipment (kg)** .....: Approx. 0.65 kg

<b>POSSIBLE TEST CASE VERDICTS:</b>	
- test case does not apply to the test object..... :	N/A
- test object does meet the requirement..... :	P (Pass)
- test object does not meet the requirement..... :	F (Fail)
<b>TESTING:</b>	
Date of receipt of test item..... :	2023-01-09
Date (s) of performance of tests..... :	2023-01-09 to 2023-02-08
<b>GENERAL REMARKS:</b>	
<p>The test results presented in this report relate only to the object tested.          This report shall not be reproduced, except in full, without the written approval of the Issuing testing laboratory.          "(see Enclosure #)" refers to additional information appended to the report.          "(see appended table)" refers to a table appended to the report.          The tested sample(s) and the sample information are provided by the client.          These tests fulfill the requirements of standard ISO/IEC 17025.          When determining the test conclusion, the Measurement Uncertainty of test has been considered.          Throughout this report a <input type="checkbox"/> comma / <input checked="" type="checkbox"/> point is used as the decimal separator.</p>	
<b>Name and address of factory (ies)..... :</b>	Shenzhen Xinxian Technology Co., Limited F5, Building B17, Hengfeng Industrial City, No. 739 Zhoushi Rd, Baoan District, Shenzhen, Guangdong, P.R.C.
<b>GENERAL PRODUCT INFORMATION:</b>	
<p>1. The equipment is BeaglePlay which is Class III equipment, supplied by end product powered, and used for information and communication technology equipment.          2. The maximum operating temperature is 60°C.          3. The USB port is used only for data transmission.</p>	
<b>Model Differences:</b>	N/A.
<b>Additional application considerations – (Considerations used to test a component or sub-assembly)</b>	
N/A.	

OVERVIEW OF ENERGY SOURCES AND SAFEGUARDS				
Clause	Possible Hazard			
5	Electrically-caused injury			
Class and Energy Source (e.g. ES3: Primary circuit)	Body Part (e.g. Ordinary)	Safeguards		
		B	S	R
ES1: All circuits	Ordinary	N/A	N/A	N/A
6	Electrically-caused fire			
Class and Energy Source (e.g. PS2: 100 Watt circuit)	Material part (e.g. Printed board)	Safeguards		
		B	1 <sup>st</sup> S	2 <sup>nd</sup> S
PS1: ≤15W	All circuits	N/A	N/A	N/A
PS1: ≤15W	Signal terminal	N/A	N/A	N/A
7	Injury caused by hazardous substances			
Class and Energy Source (e.g. Ozone)	Body Part (e.g., Skilled)	Safeguards		
		B	S	R
N/A	N/A	N/A	N/A	N/A
8	Mechanically-caused injury			
Class and Energy Source (e.g. MS3: Plastic fan blades)	Body Part (e.g. Ordinary)	Safeguards		
		B	S	R
N/A(Building-in Equipment)	N/A	N/A	N/A	N/A
9	Thermal burn			
Class and Energy Source (e.g. TS1: Keyboard caps)	Body Part (e.g., Ordinary)	Safeguards		
		B	S	R
N/A(Building-in Equipment)	N/A	N/A	N/A	N/A
10	Radiation			
Class and Energy Source (e.g. RS1: PMP sound output)	Body Part (e.g., Ordinary)	Safeguards		
		B	S	R
RS1:LED indicator	Ordinary	N/A	N/A	N/A
Supplementary Information:				
"B" – Basic Safeguard; "S" – Supplementary Safeguard; "R" – Reinforced Safeguard				



## ENERGY SOURCE DIAGRAM

**Optional.** Manufacturers are to provide the energy sources diagram identify declared energy sources and identifying the demarcations are between power sources. Recommend diagram be provided included in power supply and multipart systems.

Insert diagram below. Example diagram designs are; Block diagrams; image(s) with layered data; mechanical drawings

ES     PS     MS     TS     RS

ES1(For all circuits)

PS1(For all circuit)

PS1(For Signal terminal)

RS1(For LED indicator)

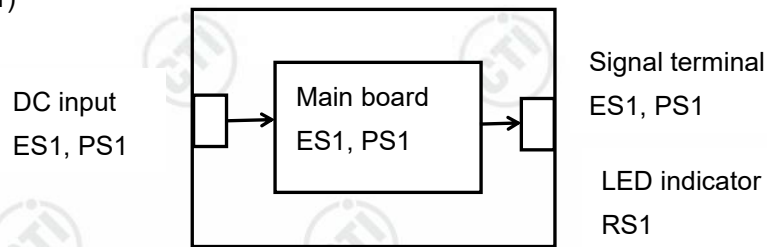

IEC 62368-1			
Clause	Requirement + Test	Result - Remark	Verdict
<b>4</b>	<b>GENERAL REQUIREMENTS</b>		P
4.1.1	Acceptance of materials, components and subassemblies	See appended table 4.1.2	P
4.1.2	Use of components	Safeguard components are certified to IEC and/or national standards and are used correctly within their ratings.	P
4.1.3	Equipment design and construction		P
4.1.4	Specified ambient temperature for outdoor use (°C) ..... :		N/A
4.1.5	Constructions and components not specifically covered		N/A
4.1.8	Liquids and liquid filled components (LFC)	(See G.15)	N/A
4.1.15	Markings and instructions	(See Annex F)	P
4.4.3	Safeguard robustness		N/A
4.4.3.1	General		N/A
4.4.3.2	Steady force tests		N/A
4.4.3.3	Drop tests		N/A
4.4.3.4	Impact tests		N/A
4.4.3.5	Internal accessible safeguard tests		N/A
4.4.3.6	Glass impact tests		N/A
4.4.3.7	Glass fixation tests		N/A
	Glass impact test (1J)		N/A
	Push/pull test (10 N)		N/A
4.4.3.8	Thermoplastic material tests		N/A
4.4.3.9	Air comprising a safeguard		N/A
4.4.3.10	Accessibility, glass, safeguard effectiveness		N/A
4.4.4	Displacement of a safeguard by an insulating liquid		N/A
4.4.5	Safety interlocks		N/A
<b>4.5</b>	<b>Explosion</b>		P
4.5.1	General	No explosion occurs during normal/abnormal operation and single fault conditions.	P
4.5.2	No explosion during normal/abnormal operating condition	(See Clause B.2, B.3)	P

TRF No. IEC62368\_1E

IEC 62368-1			
Clause	Requirement + Test	Result - Remark	Verdict
	No harm by explosion during single fault conditions	(See Clause B.4)	P
<b>4.6</b>	<b>Fixing of conductors</b>		N/A
	Fix conductors not to defeat a safeguard		N/A
	Compliance is checked by test..... :		N/A
<b>4.7</b>	<b>Equipment for direct insertion into mains socket-outlets</b>		N/A
4.7.2	Mains plug part complies with relevant standard... :		N/A
4.7.3	Torque (Nm)..... :		N/A
<b>4.8</b>	<b>Equipment containing coin/button cell batteries</b>		N/A
4.8.1	General	No coin/button cell batteries used.	N/A
4.8.2	Instructional safeguard..... :		N/A
4.8.3	Battery compartment door/cover construction		N/A
	Open torque test		N/A
4.8.4.2	Stress relief test		N/A
4.8.4.3	Battery replacement test		N/A
4.8.4.4	Drop test		N/A
4.8.4.5	Impact test		N/A
4.8.4.6	Crush test		N/A
4.8.5	Compliance		N/A
	30N force test with test probe		N/A
	20N force test with test hook		N/A
<b>4.9</b>	<b>Likelihood of fire or shock due to entry of conductive object</b>		P
<b>4.10</b>	<b>Component requirements</b>		N/A
4.10.1	Disconnect Device		N/A
4.10.2	Switches and relays		N/A

<b>5</b>	<b>ELECTRICALLY-CAUSED INJURY</b>		P
<b>5.2</b>	<b>Classification and limits of electrical energy sources</b>		P
5.2.2	ES1, ES2 and ES3 limits		P
5.2.2.2	Steady-state voltage and current limits..... :	(See appended table 5.2)	P
5.2.2.3	Capacitance limits..... :	No such capacitor.	N/A
5.2.2.4	Single pulse limits..... :	No such single pulse.	N/A

TRF No. IEC62368\_1E

IEC 62368-1			
Clause	Requirement + Test	Result - Remark	Verdict
5.2.2.5	Limits for repetitive pulses..... :	No such repetitive pulses.	N/A
5.2.2.6	Ringing signals	No such ringing signals.	N/A
5.2.2.7	Audio signals		N/A
<b>5.3</b>	<b>Protection against electrical energy sources</b>		N/A
5.3.1	General Requirements for accessible parts to ordinary, instructed and skilled persons	Built-in type, shall be evaluated in end product.	N/A
5.3.1 a)	Accessible ES1/ES2 derived from ES2/ES3 circuits		N/A
5.3.1 b)	Skilled persons not unintentional contact ES3 bare conductors		N/A
5.3.2.1	Accessibility to electrical energy sources and safeguards		N/A
	Accessibility to outdoor equipment bare parts		N/A
5.3.2.2	Contact requirements		N/A
	Test with test probe from Annex V		—
5.3.2.2 a)	Air gap – electric strength test potential (V)..... :		N/A
5.3.2.2 b)	Air gap – distance (mm) ..... :		N/A
5.3.2.3	Compliance		N/A
5.3.2.4	Terminals for connecting stripped wire		N/A
<b>5.4</b>	<b>Insulation materials and requirements</b>		P
5.4.1.2	Properties of insulating material		N/A
5.4.1.3	Material is non-hygroscopic		N/A
5.4.1.4	Maximum operating temperature for insulating materials..... :		N/A
5.4.1.5	Pollution degrees..... :	2	P
5.4.1.5.2	Test for pollution degree 1 environment and for an insulating compound		N/A
5.4.1.5.3	Thermal cycling test		N/A
5.4.1.6	Insulation in transformers with varying dimensions	No such transformer.	N/A
5.4.1.7	Insulation in circuits generating starting pulses	No such starting pulses.	N/A
5.4.1.8	Determination of working voltage..... :		N/A
5.4.1.9	Insulating surfaces		N/A
5.4.1.10	Thermoplastic parts on which conductive metallic parts are directly mounted		N/A
5.4.1.10.2	Vicat test..... :		N/A

TRF No. IEC62368\_1E



IEC 62368-1			
Clause	Requirement + Test	Result - Remark	Verdict
5.4.1.10.3	Ball pressure test..... :		N/A
5.4.2	Clearances		N/A
5.4.2.1	General requirements		N/A
	Clearances in circuits connected to AC Mains, Alternative method		N/A
5.4.2.2	Procedure 1 for determining clearance		N/A
	Temporary overvoltage ..... :		—
5.4.2.3	Procedure 2 for determining clearance		N/A
5.4.2.3.2.2	a.c. mains transient voltage..... :		—
5.4.2.3.2.3	d.c. mains transient voltage ..... :		—
5.4.2.3.2.4	External circuit transient voltage..... :		—
5.4.2.3.2.5	Transient voltage determined by measurement..... :		—
5.4.2.4	Determining the adequacy of a clearance using an electric strength test ..... :		N/A
5.4.2.5	Multiplication factors for clearances and test voltages ..... :		N/A
5.4.2.6	Clearance measurement..... :		N/A
5.4.3	Creepage distances		N/A
5.4.3.1	General		N/A
5.4.3.3	Material group..... :		—
5.4.3.4	Creepage distances measurement..... :		N/A
5.4.4	Solid insulation		N/A
5.4.4.1	General requirements		N/A
5.4.4.2	Minimum distance through insulation ..... :		N/A
5.4.4.3	Insulating compound forming solid insulation		N/A
5.4.4.4	Solid insulation in semiconductor devices		N/A
5.4.4.5	Insulating compound forming cemented joints		N/A
5.4.4.6	Thin sheet material		N/A
5.4.4.6.1	General requirements		N/A
5.4.4.6.2	Separable thin sheet material		N/A
	Number of layers (pcs) ..... :		N/A
5.4.4.6.3	Non-separable thin sheet material		N/A
	Number of layers (pcs) ..... :		N/A

TRF No. IEC62368\_1E

IEC 62368-1			
Clause	Requirement + Test	Result - Remark	Verdict
5.4.4.6.4	Standard test procedure for non-separable thin sheet material..... :		N/A
5.4.4.6.5	Mandrel test		N/A
5.4.4.7	Solid insulation in wound components		N/A
5.4.4.9	Solid insulation at frequencies >30 kHz, $E_P$ , $K_R$ , $d$ , $V_{PW}$ (V)..... :		N/A
	Alternative by electric strength test, tested voltage (V), $K_R$ ..... :		N/A
5.4.5	Antenna terminal insulation		N/A
5.4.5.1	General		N/A
5.4.5.2	Voltage surge test		N/A
5.4.5.3	Insulation resistance (M $\Omega$ )..... :		N/A
	Electric strength test..... :		N/A
5.4.6	Insulation of internal wire as part of supplementary safeguard		N/A
5.4.7	Tests for semiconductor components and for cemented joints		N/A
5.4.8	Humidity conditioning		N/A
	Relative humidity (%), temperature ( $^{\circ}$ C), duration (h)..... :		—
5.4.9	Electric strength test		N/A
5.4.9.1	Test procedure for type test of solid insulation..... :		N/A
5.4.9.2	Test procedure for routine test		N/A
5.4.10	Safeguards against transient voltages from external circuits		N/A
5.4.10.1	Parts and circuits separated from external circuits		N/A
5.4.10.2	Test methods		N/A
5.4.10.2.1	General		N/A
5.4.10.2.2	Impulse test..... :		N/A
5.4.10.2.3	Steady-state test..... :		N/A
5.4.10.3	Verification for insulation breakdown for impulse test..... :		N/A
5.4.11	Separation between external circuits and earth	No such external circuits	N/A
5.4.11.1	Exceptions to separation between external circuits and earth		N/A

TRF No. IEC62368\_1E

IEC 62368-1			
Clause	Requirement + Test	Result - Remark	Verdict
5.4.11.2	Requirements		N/A
	SPDs bridge separation between external circuit and earth		N/A
	Rated operating voltage $U_{op}$ (V).....:		—
	Nominal voltage $U_{peak}$ (V).....:		—
	Max increase due to variation $\Delta U_{sp}$ .....		—
	Max increase due to ageing $\Delta U_{sa}$ .....		—
5.4.11.3	Test method and compliance.....:		N/A
5.4.12	Insulating liquid		N/A
5.4.12.1	General requirements		N/A
5.4.12.2	Electric strength of an insulating liquid.....:		N/A
5.4.12.3	Compatibility of an insulating liquid.....:		N/A
5.4.12.4	Container for insulating liquid.....:		N/A
<b>5.5</b>	<b>Components as safeguards</b>		N/A
5.5.1	General		N/A
5.5.2	Capacitors and RC units		N/A
5.5.2.1	General requirement		N/A
5.5.2.2	Safeguards against capacitor discharge after disconnection of a connector.....:		N/A
5.5.3	Transformers		N/A
5.5.4	Optocouplers		N/A
5.5.5	Relays		N/A
5.5.6	Resistors		N/A
5.5.7	SPDs		N/A
5.5.8	Insulation between the mains and an external circuit consisting of a coaxial cable.....:		N/A
5.5.9	Safeguards for socket-outlets in outdoor equipment		N/A
	RCD rated residual operating current (mA).....:		—
<b>5.6</b>	<b>Protective conductor</b>		N/A
5.6.2	Requirement for protective conductors	Class III equipment	N/A
5.6.2.1	General requirements		N/A
5.6.2.2	Colour of insulation		N/A
5.6.3	Requirement for protective earthing conductors		N/A

TRF No. IEC62368\_1E

IEC 62368-1			
Clause	Requirement + Test	Result - Remark	Verdict
	Protective earthing conductor size (mm <sup>2</sup> ) ..... :		—
	Protective earthing conductor serving as a reinforced safeguard		N/A
	Protective earthing conductor serving as a double safeguard		N/A
5.6.4	Requirements for protective bonding conductors		N/A
5.6.4.1	Protective bonding conductors		N/A
	Protective bonding conductor size (mm <sup>2</sup> )..... :		—
5.6.4.2	Protective current rating (A)..... :		N/A
5.6.5	Terminals for protective conductors		N/A
5.6.5.1	Terminal size for connecting protective earthing conductors (mm)..... :		N/A
	Terminal size for connecting protective bonding conductors (mm)..... :		N/A
5.6.5.2	Corrosion		N/A
5.6.6	Resistance of the protective bonding system		N/A
5.6.6.1	Requirements		N/A
5.6.6.2	Test Method..... :		N/A
5.6.6.3	Resistance ( $\Omega$ ) or voltage drop..... :		N/A
5.6.7	Reliable connection of a protective earthing conductor		N/A
5.6.8	Functional earthing		N/A
	Conductor size (mm <sup>2</sup> )..... :		N/A
	Class II with functional earthing marking ..... :		N/A
	Appliance inlet cl & cr (mm)..... :		N/A
<b>5.7</b>	<b>Prospective touch voltage, touch current and protective conductor current</b>		N/A
5.7.2	Measuring devices and networks		N/A
5.7.2.1	Measurement of touch current	Class III equipment	N/A
5.7.2.2	Measurement of voltage		N/A
5.7.3	Equipment set-up, supply connections and earth connections		N/A
5.7.4	Unearthed accessible parts..... :		N/A
5.7.5	Earthed accessible conductive parts..... :		N/A



IEC 62368-1			
Clause	Requirement + Test	Result - Remark	Verdict
5.7.6	Requirements when touch current exceeds ES2 limits		N/A
	Protective conductor current (mA)..... :		N/A
	Instructional Safeguard..... :		N/A
5.7.7	Prospective touch voltage and touch current associated with external circuits		N/A
5.7.7.1	Touch current from coaxial cables		N/A
5.7.7.2	Prospective touch voltage and touch current associated with paired conductor cables		N/A
5.7.8	Summation of touch currents from external circuits		N/A
	a) Equipment connected to earthed external circuits, current (mA)..... :		N/A
	b) Equipment connected to unearthed external circuits, current (mA)..... :		N/A
<b>5.8</b>	<b>Backfeed safeguard in battery backed up supplies</b>		N/A
	Mains terminal ES..... :		N/A
	Air gap (mm)..... :		N/A

<b>6</b>	<b>ELECTRICALLY- CAUSED FIRE</b>		P
<b>6.2</b>	<b>Classification of PS and PIS</b>		P
6.2.2	Power source circuit classifications..... :	(See appended table 6.2.2)	P
6.2.3	Classification of potential ignition sources		N/A
6.2.3.1	Arcing PIS .....		N/A
6.2.3.2	Resistive PIS .....		N/A
<b>6.3</b>	<b>Safeguards against fire under normal operating and abnormal operating conditions</b>		P
6.3.1	No ignition and attainable temperature value less than 90 % defined by ISO 871 or less than 300 °C for unknown materials..... :	(See appended table B.1.5 and B.3)	P
	Combustible materials outside fire enclosure..... :		N/A
<b>6.4</b>	<b>Safeguards against fire under single fault conditions</b>		P
6.4.1	Safeguard method		P
6.4.2	Reduction of the likelihood of ignition under single fault conditions in PS1 circuits		N/A
6.4.3	Reduction of the likelihood of ignition under single fault conditions in PS2 and PS3 circuits		N/A

TRF No. IEC62368\_1E

IEC 62368-1			
Clause	Requirement + Test	Result - Remark	Verdict
6.4.3.1	Supplementary safeguards		N/A
6.4.3.2	Single Fault Conditions.....:		N/A
	Special conditions for temperature limited by fuse		N/A
6.4.4	Control of fire spread in PS1 circuits		P
6.4.5	Control of fire spread in PS2 circuits		N/A
6.4.5.2	Supplementary safeguards	Built-in type, shall be evaluated in end product.	N/A
6.4.6	Control of fire spread in PS3 circuits		N/A
6.4.7	Separation of combustible materials from a PIS		N/A
6.4.7.2	Separation by distance		N/A
6.4.7.3	Separation by a fire barrier		N/A
6.4.8	Fire enclosures and fire barriers		N/A
6.4.8.2	Fire enclosure and fire barrier material properties		N/A
6.4.8.2.1	Requirements for a fire barrier		N/A
6.4.8.2.2	Requirements for a fire enclosure		N/A
6.4.8.3	Constructional requirements for a fire enclosure and a fire barrier		N/A
6.4.8.3.1	Fire enclosure and fire barrier openings		N/A
6.4.8.3.2	Fire barrier dimensions		N/A
6.4.8.3.3	Top openings and properties		N/A
	Openings dimensions (mm).....:	No openings	N/A
6.4.8.3.4	Bottom openings and properties		N/A
	Openings dimensions (mm).....:	No openings	N/A
	Flammability tests for the bottom of a fire enclosure		N/A
	Instructional Safeguard.....:		N/A
6.4.8.3.5	Side openings and properties		N/A
	Openings dimensions (mm).....:	No openings	N/A
6.4.8.3.6	Integrity of a fire enclosure, condition met: a), b) or c).....:		N/A
6.4.8.4	Separation of a PIS from a fire enclosure and a fire barrier distance (mm) or flammability rating.....:		N/A
6.4.9	Flammability of insulating liquid.....:		N/A
<b>6.5</b>	<b>Internal and external wiring</b>		N/A

TRF No. IEC62368\_1E

IEC 62368-1			
Clause	Requirement + Test	Result - Remark	Verdict
6.5.1	General requirements	(See appended table 4.1.2)	N/A
6.5.2	Requirements for interconnection to building wiring ..... :		N/A
6.5.3	Internal wiring size (mm <sup>2</sup> ) for socket-outlets..... :		N/A
6.6	<b>Safeguards against fire due to the connection to additional equipment</b>		P

<b>7</b>	<b>INJURY CAUSED BY HAZARDOUS SUBSTANCES</b>		N/A
<b>7.2</b>	<b>Reduction of exposure to hazardous substances</b>		N/A
<b>7.3</b>	<b>Ozone exposure</b>		N/A
<b>7.4</b>	<b>Use of personal safeguards or personal protective equipment (PPE)</b>		N/A
	Personal safeguards and instructions..... :		
<b>7.5</b>	<b>Use of instructional safeguards and instructions</b>		N/A
	Instructional safeguard (ISO 7010)..... :		
<b>7.6</b>	<b>Batteries and their protection circuits</b>		N/A

<b>8</b>	<b>MECHANICALLY-CAUSED INJURY</b>		N/A
<b>8.2</b>	<b>Mechanical energy source classifications</b>		N/A
<b>8.3</b>	<b>Safeguards against mechanical energy sources</b>		N/A
<b>8.4</b>	<b>Safeguards against parts with sharp edges and corners</b>		N/A
8.4.1	Safeguards	Building-in type, shall be evaluated in end product.	N/A
	Instructional Safeguard..... :		N/A
8.4.2	Sharp edges or corners		N/A
<b>8.5</b>	<b>Safeguards against moving parts</b>		N/A
8.5.1	Fingers, jewellery, clothing, hair, etc., contact with MS2 or MS3 parts		N/A
	MS2 or MS3 part required to be accessible for the function of the equipment		N/A
	Moving MS3 parts only accessible to skilled person		N/A
8.5.2	Instructional safeguard..... :		N/A
8.5.4	Special categories of equipment containing moving parts		N/A
8.5.4.1	General		N/A
8.5.4.2	Equipment containing work cells with MS3 parts		N/A

TRF No. IEC62368\_1E

IEC 62368-1			
Clause	Requirement + Test	Result - Remark	Verdict
8.5.4.2.1	Protection of persons in the work cell		N/A
8.5.4.2.2	Access protection override		N/A
8.5.4.2.2.1	Override system		N/A
8.5.4.2.2.2	Visual indicator		N/A
8.5.4.2.3	Emergency stop system		N/A
	Maximum stopping distance from the point of activation (m)..... :		N/A
	Space between end point and nearest fixed mechanical part (mm)..... :		N/A
8.5.4.2.4	Endurance requirements		N/A
	Mechanical system subjected to 100 000 cycles of operation		N/A
	- Mechanical function check and visual inspection		N/A
	- Cable assembly..... :		N/A
8.5.4.3	Equipment having electromechanical device for destruction of media		N/A
8.5.4.3.1	Equipment safeguards		N/A
8.5.4.3.2	Instructional safeguards against moving parts..... :		N/A
8.5.4.3.3	Disconnection from the supply		N/A
8.5.4.3.4	Cut type and test force (N)..... :		N/A
8.5.4.3.5	Compliance		N/A
8.5.5	High pressure lamps		N/A
	Explosion test..... :		N/A
8.5.5.3	Glass particles dimensions (mm)..... :		N/A
<b>8.6</b>	<b>Stability of equipment</b>		N/A
8.6.1	General		N/A
	Instructional safeguard..... :		N/A
8.6.2	Static stability		N/A
8.6.2.2	Static stability test..... :		N/A
8.6.2.3	Downward force test		N/A
8.6.3	Relocation stability		N/A
	Wheels diameter (mm)..... :		—
	Tilt test		N/A
8.6.4	Glass slide test		N/A

TRF No. IEC62368\_1E



IEC 62368-1			
Clause	Requirement + Test	Result - Remark	Verdict
8.6.5	Horizontal force test..... :		N/A
<b>8.7</b>	<b>Equipment mounted to wall, ceiling or other structure</b>		N/A
8.7.1	Mount means type..... :		N/A
8.7.2	Test methods		N/A
	Test 1, additional downwards force (N)..... :		N/A
	Test 2, number of attachment points and test force (N)..... :		N/A
	Test 3 Nominal diameter (mm) and applied torque (Nm)..... :		N/A
<b>8.8</b>	<b>Handles strength</b>		N/A
8.8.1	General		N/A
8.8.2	Handle strength test		N/A
	Number of handles..... :		—
	Force applied (N)..... :		—
<b>8.9</b>	<b>Wheels or casters attachment requirements</b>		N/A
8.9.2	Pull test		N/A
<b>8.10</b>	<b>Carts, stands and similar carriers</b>		N/A
8.10.1	General		N/A
8.10.2	Marking and instructions..... :		N/A
8.10.3	Cart, stand or carrier loading test		N/A
	Loading force applied (N)..... :		N/A
8.10.4	Cart, stand or carrier impact test		N/A
8.10.5	Mechanical stability		N/A
	Force applied (N)..... :		—
8.10.6	Thermoplastic temperature stability		N/A
<b>8.11</b>	<b>Mounting means for slide-rail mounted equipment (SRME)</b>		N/A
8.11.1	General		N/A
8.11.2	Requirements for slide rails		N/A
	Instructional Safeguard..... :		N/A
8.11.3	Mechanical strength test		N/A
8.11.3.1	Downward force test, force (N) applied..... :		N/A
8.11.3.2	Lateral push force test		N/A

TRF No. IEC62368\_1E

IEC 62368-1			
Clause	Requirement + Test	Result - Remark	Verdict
8.11.3.3	Integrity of slide rail end stops		N/A
8.11.4	Compliance		N/A
<b>8.12</b>	<b>Telescoping or rod antennas</b>		N/A
	Button/ball diameter (mm)..... :		—

<b>9</b>	<b>THERMAL BURN INJURY</b>		N/A
<b>9.2</b>	<b>Thermal energy source classifications</b>		N/A
<b>9.3</b>	<b>Touch temperature limits</b>		N/A
9.3.1	Touch temperatures of accessible parts..... :	Built-in type, shall be evaluated in end product.	N/A
9.3.2	Test method and compliance		N/A
<b>9.4</b>	<b>Safeguards against thermal energy sources</b>		N/A
<b>9.5</b>	<b>Requirements for safeguards</b>		N/A
9.5.1	Equipment safeguard	No safeguard required	N/A
9.5.2	Instructional safeguard..... :	No safeguard required	N/A
<b>9.6</b>	<b>Requirements for wireless power transmitters</b>		N/A
9.6.1	General		N/A
9.6.2	Specification of the foreign objects		N/A
9.6.3	Test method and compliance..... :		N/A

<b>10</b>	<b>RADIATION</b>		P
<b>10.2</b>	<b>Radiation energy source classification</b>		P
10.2.1	General classification		P
	Lasers..... :		—
	Lamps and lamp systems..... :	LED indicator is classified RS1	—
	Image projectors..... :		—
	X-Ray..... :		—
	Personal music player..... :		—
<b>10.3</b>	<b>Safeguards against laser radiation</b>		N/A
	The standard(s) equipment containing laser(s) comply..... :		N/A
<b>10.4</b>	<b>Safeguards against optical radiation from lamps and lamp systems (including</b>		P

TRF No. IEC62368\_1E

IEC 62368-1			
Clause	Requirement + Test	Result - Remark	Verdict
	<b>LED types)</b>		
10.4.1	General requirements		P
	Instructional safeguard provided for accessible radiation level needs to exceed		N/A
	Risk group marking and location..... :		N/A
	Information for safe operation and installation		N/A
10.4.2	Requirements for enclosures		N/A
	UV radiation exposure..... :		N/A
10.4.3	Instructional safeguard..... :		N/A
<b>10.5</b>	<b>Safeguards against X-radiation</b>		N/A
10.5.1	Requirements		N/A
	Instructional safeguard for skilled persons..... :		—
10.5.3	Maximum radiation (pA/kg)..... :		—
<b>10.6</b>	<b>Safeguards against acoustic energy sources</b>		N/A
10.6.1	General		N/A
10.6.2	Classification		N/A
	Acoustic output $L_{Aeq,T}$ , dB(A)..... :		N/A
	Unweighted RMS output voltage (mV)..... :		N/A
	Digital output signal (dBFS)..... :		N/A
10.6.3	Requirements for dose-based systems		N/A
10.6.3.1	General requirements		N/A
10.6.3.2	Dose-based warning and automatic decrease		N/A
10.6.3.3	Exposure-based warning and requirements		N/A
	30 s integrated exposure level (MEL30)..... :		N/A
	Warning for MEL $\geq$ 100 dB(A)..... :		N/A
10.6.4	Measurement methods		N/A
10.6.5	Protection of persons		N/A
	Instructional safeguards..... :		N/A
10.6.6	Requirements for listening devices (headphones, earphones, etc.)		N/A
10.6.6.1	Corded listening devices with analogue input		N/A
	Listening device input voltage (mV)..... :		N/A
10.6.6.2	Corded listening devices with digital input		N/A

TRF No. IEC62368\_1E

IEC 62368-1			
Clause	Requirement + Test	Result - Remark	Verdict
	Max. acoustic output $L_{Aeq,T}$ , dB(A)..... :		N/A
10.6.6.3	Cordless listening devices		N/A
	Max. acoustic output $L_{Aeq,T}$ , dB(A)..... :		N/A

<b>B</b>	<b>NORMAL OPERATING CONDITION TESTS, ABNORMAL OPERATING CONDITION TESTS AND SINGLE FAULT CONDITION TESTS</b>		P
<b>B.1</b>	<b>General</b>		P
B.1.5	Temperature measurement conditions	(See appended table B.1.5)	P
<b>B.2</b>	<b>Normal operating conditions</b>		P
B.2.1	General requirements..... :	(See Test Item Particulars and appended test tables)	P
	Audio Amplifiers and equipment with audio amplifiers..... :		N/A
B.2.3	Supply voltage and tolerances		N/A
B.2.5	Input test..... :	(See appended table B.2.5)	P
<b>B.3</b>	<b>Simulated abnormal operating conditions</b>		N/A
B.3.1	General		N/A
B.3.2	Covering of ventilation openings	No openings on enclosure.	N/A
	Instructional safeguard..... :		N/A
B.3.3	DC mains polarity test	Not connected to D.C. mains.	N/A
B.3.4	Setting of voltage selector	No voltage selector.	N/A
B.3.5	Maximum load at output terminals		N/A
B.3.6	Reverse battery polarity	No such battery.	N/A
B.3.7	Audio amplifier abnormal operating conditions		N/A
B.3.8	Safeguards functional during and after abnormal operating conditions..... :	(See appended table B.3, B.4)	N/A
<b>B.4</b>	<b>Simulated single fault conditions</b>		P
B.4.1	General		P
B.4.2	Temperature controlling device	No temperature controlling device.	N/A
B.4.3	Blocked motor test	(See appended table B.3, B.4)	P
B.4.4	Functional insulation		P
B.4.4.1	Short circuit of clearances for functional insulation		N/A

TRF No. IEC62368\_1E



IEC 62368-1			
Clause	Requirement + Test	Result - Remark	Verdict
B.4.4.2	Short circuit of creepage distances for functional insulation		N/A
B.4.4.3	Short circuit of functional insulation on coated printed boards	Not such coated printed board.	N/A
B.4.5	Short-circuit and interruption of electrodes in tubes and semiconductors	(See appended table B.3, B.4)	P
B.4.6	Short circuit or disconnection of passive components		N/A
B.4.7	Continuous operation of components		N/A
B.4.8	Compliance during and after single fault conditions ..... :		N/A
B.4.9	Battery charging and discharging under single fault conditions		N/A
<b>C</b>	<b>UV RADIATION</b>		N/A
<b>C.1</b>	<b>Protection of materials in equipment from UV radiation</b>		N/A
C.1.2	Requirements		N/A
C.1.3	Test method		N/A
<b>C.2</b>	<b>UV light conditioning test</b>		N/A
C.2.1	Test apparatus..... :		N/A
C.2.2	Mounting of test samples		N/A
C.2.3	Carbon-arc light-exposure test		N/A
C.2.4	Xenon-arc light-exposure test		N/A
<b>D</b>	<b>TEST GENERATORS</b>		N/A
<b>D.1</b>	<b>Impulse test generators</b>		N/A
<b>D.2</b>	<b>Antenna interface test generator</b>		N/A
<b>D.3</b>	<b>Electronic pulse generator</b>		N/A
<b>E</b>	<b>TEST CONDITIONS FOR EQUIPMENT CONTAINING AUDIO AMPLIFIERS</b>		N/A
<b>E.1</b>	<b>Electrical energy source classification for audio signals</b>		N/A
	Maximum non-clipped output power (W)..... :		—
	Rated load impedance ( $\Omega$ ) ..... :		—
	Open-circuit output voltage (V)..... :		—
	Instructional safeguard..... :		—
<b>E.2</b>	<b>Audio amplifier normal operating conditions</b>		N/A
	Audio signal source type..... :		—

TRF No. IEC62368\_1E

IEC 62368-1			
Clause	Requirement + Test		Verdict
	Audio output power (W).....:		—
	Audio output voltage (V).....:		—
	Rated load impedance ( $\Omega$ ) .....		—
	Requirements for temperature measurement		N/A
E.3	Audio amplifier abnormal operating conditions		N/A
<b>F</b>	<b>EQUIPMENT MARKINGS, INSTRUCTIONS, AND INSTRUCTIONAL SAFEGUARDS</b>		<b>P</b>
<b>F.1</b>	<b>General</b>		<b>P</b>
	Language .....	English	—
<b>F.2</b>	<b>Letter symbols and graphical symbols</b>		<b>P</b>
F.2.1	Letter symbols according to IEC60027-1	Letter symbols for quantities and units complied with IEC 60027-1.	P
F.2.2	Graphic symbols according to IEC, ISO or manufacturer specific		P
<b>F.3</b>	<b>Equipment markings</b>		<b>P</b>
F.3.1	Equipment marking locations	Located on the outside of the enclosure	P
F.3.2	Equipment identification markings		P
F.3.2.1	Manufacturer identification .....	See marking plate	P
F.3.2.2	Model identification .....	See marking plate	P
F.3.3	Equipment rating markings	See marking plate	P
F.3.3.1	Equipment with direct connection to mains		N/A
F.3.3.2	Equipment without direct connection to mains		P
F.3.3.3	Nature of the supply voltage.....:	==	N/A
F.3.3.4	Rated voltage.....:	See marking plate	N/A
F.3.3.5	Rated frequency.....:		N/A
F.3.3.6	Rated current or rated power.....:	See marking plate	N/A
F.3.3.7	Equipment with multiple supply connections	No such device	N/A
F.3.4	Voltage setting device	No such device	N/A
F.3.5	Terminals and operating devices	No such device	N/A
F.3.5.1	Mains appliance outlet and socket-outlet markings .....	No outlet used.	N/A
F.3.5.2	Switch position identification marking.....:	No switch used.	N/A

TRF No. IEC62368\_1E

IEC 62368-1			
Clause	Requirement + Test	Result - Remark	Verdict
F.3.5.3	Replacement fuse identification and rating markings .....:		N/A
	Instructional safeguards for neutral fuse.....:		N/A
F.3.5.4	Replacement battery identification marking.....:		N/A
F.3.5.5	Neutral conductor terminal		N/A
F.3.5.6	Terminal marking location		N/A
F.3.6	Equipment markings related to equipment classification		N/A
F.3.6.1	Class I equipment	Class III equipment.	N/A
F.3.6.1.1	Protective earthing conductor terminal.....:		N/A
F.3.6.1.2	Protective bonding conductor terminals .....		N/A
F.3.6.2	Equipment class marking.....:		N/A
F.3.6.3	Functional earthing terminal marking.....:		N/A
F.3.7	Equipment IP rating marking.....:	IPX0	N/A
F.3.8	External power supply output marking.....:		N/A
F.3.9	Durability, legibility and permanence of marking	Marking is considered to be legible and easily discernible. See also the following details.	P
F.3.10	Test for permanence of markings	After test there was no damage on the label. The marking on the label did not fade. There was no curling and lifting of the label edge.	P
<b>F.4</b>	<b>Instructions</b>		P
	a) Information prior to installation and initial use	See user manual	P
	b) Equipment for use in locations where children not likely to be present		N/A
	c) Instructions for installation and interconnection		N/A
	d) Equipment intended for use only in restricted access area		N/A
	e) Equipment intended to be fastened in place		N/A
	f) Instructions for audio equipment terminals		N/A
	g) Protective earthing used as a safeguard		N/A
	h) Protective conductor current exceeding ES2 limits		N/A
	i) Graphic symbols used on equipment		N/A

TRF No. IEC62368\_1E

IEC 62368-1			
Clause	Requirement + Test	Result - Remark	Verdict
	j) Permanently connected equipment not provided with all-pole mains switch		N/A
	k) Replaceable components or modules providing safeguard function		N/A
	l) Equipment containing insulating liquid		N/A
	m) Installation instructions for outdoor equipment		N/A
<b>F.5</b>	Instructional safeguards		N/A
<b>G</b>	<b>COMPONENTS</b>		P
<b>G.1</b>	<b>Switches</b>		N/A
G.1.1	General	No switch used	N/A
G.1.2	Ratings, endurance, spacing, maximum load		N/A
G.1.3	Test method and compliance		N/A
<b>G.2</b>	<b>Relays</b>		N/A
G.2.1	Requirements		N/A
G.2.2	Overload test		N/A
G.2.3	Relay controlling connectors supplying power to other equipment		N/A
G.2.4	Test method and compliance		N/A
<b>G.3</b>	<b>Protective devices</b>		N/A
G.3.1	Thermal cut-offs		N/A
	Thermal cut-outs separately approved according to IEC 60730 with conditions indicated in a) & b)		N/A
	Thermal cut-outs tested as part of the equipment as indicated in c)		N/A
G.3.1.2	Test method and compliance		N/A
G.3.2	Thermal links		N/A
G.3.2.1	a) Thermal links tested separately according to IEC 60691 with specifics		N/A
	b) Thermal links tested as part of the equipment		N/A
G.3.2.2	Test method and compliance		N/A
G.3.3	PTC thermistors		N/A
G.3.4	Overcurrent protection devices		N/A
G.3.5	Safeguards components not mentioned in G.3.1 to G.3.4		N/A

TRF No. IEC62368\_1E



IEC 62368-1			
Clause	Requirement + Test	Result - Remark	Verdict
G.3.5.1	Non-resettable devices suitably rated and marking provided		N/A
G.3.5.2	Single faults conditions..... :		N/A
<b>G.4</b>	<b>Connectors</b>		N/A
G.4.1	Spacings		N/A
G.4.2	Mains connector configuration..... :		N/A
G.4.3	Plug is shaped that insertion into mains socket-outlets or appliance coupler is unlikely		N/A
<b>G.5</b>	<b>Wound components</b>		P
G.5.1	Wire insulation in wound components		N/A
G.5.1.2	Protection against mechanical stress		N/A
G.5.2	Endurance test		N/A
G.5.2.1	General test requirements		N/A
G.5.2.2	Heat run test		N/A
	Test time (days per cycle)..... :		—
	Test temperature (°C)..... :		—
G.5.2.3	Wound components supplied from the mains		N/A
G.5.2.4	No insulation breakdown		N/A
G.5.3	Transformers		N/A
G.5.3.1	Compliance method..... :		N/A
	Position..... :		N/A
	Method of protection..... :		N/A
G.5.3.2	Insulation		N/A
	Protection from displacement of windings..... :		—
G.5.3.3	Transformer overload tests		N/A
G.5.3.3.1	Test conditions		N/A
G.5.3.3.2	Winding temperatures		N/A
G.5.3.3.3	Winding temperatures - alternative test method		N/A
G.5.3.4	Transformers using FIW		N/A
G.5.3.4.1	General		N/A
	FIW wire nominal diameter..... :		—
G.5.3.4.2	Transformers with basic insulation only		N/A

TRF No. IEC62368\_1E

IEC 62368-1			
Clause	Requirement + Test	Result - Remark	Verdict
G.5.3.4.3	Transformers with double insulation or reinforced insulation..... :		N/A
G.5.3.4.4	Transformers with FIW wound on metal or ferrite core		N/A
G.5.3.4.5	Thermal cycling test and compliance		N/A
G.5.3.4.6	Partial discharge test		N/A
G.5.3.4.7	Routine test		N/A
G.5.4	Motors		N/A
G.5.4.1	General requirements		N/A
G.5.4.2	Motor overload test conditions		N/A
G.5.4.3	Running overload test		N/A
G.5.4.4.2	Locked-rotor overload test		N/A
	Test duration (days) ..... :		—
G.5.4.5	Running overload test for DC motors		N/A
G.5.4.5.2	Tested in the unit		N/A
G.5.4.5.3	Alternative method		N/A
G.5.4.6	Locked-rotor overload test for DC motors		N/A
G.5.4.6.2	Tested in the unit		N/A
	Maximum Temperature ..... :		N/A
G.5.4.6.3	Alternative method		N/A
G.5.4.7	Motors with capacitors		N/A
G.5.4.8	Three-phase motors		N/A
G.5.4.9	Series motors		N/A
	Operating voltage ..... :		—
<b>G.6</b>	<b>Wire Insulation</b>		N/A
G.6.1	General		N/A
G.6.2	Enamelled winding wire insulation		N/A
<b>G.7</b>	<b>Mains supply cords</b>		N/A
G.7.1	General requirements		N/A
	Type..... :		—
G.7.2	Cross sectional area (mm <sup>2</sup> or AWG)..... :		N/A
G.7.3	Cord anchorages and strain relief for non-detachable power supply cords		N/A

TRF No. IEC62368\_1E

IEC 62368-1			
Clause	Requirement + Test	Result - Remark	Verdict
G.7.3.2	Cord strain relief		N/A
G.7.3.2.1	Requirements		N/A
	Strain relief test force (N)..... :		N/A
G.7.3.2.2	Strain relief mechanism failure		N/A
G.7.3.2.3	Cord sheath or jacket position, distance (mm)..... :		N/A
G.7.3.2.4	Strain relief and cord anchorage material		N/A
G.7.4	Cord Entry		N/A
G.7.5	Non-detachable cord bend protection		N/A
G.7.5.1	Requirements		N/A
G.7.5.2	Test method and compliance		N/A
	Overall diameter or minor overall dimension, $D$ (mm)..... :		—
	Radius of curvature after test (mm)..... :		—
G.7.6	Supply wiring space		N/A
G.7.6.1	General requirements		N/A
G.7.6.2	Stranded wire		N/A
G.7.6.2.1	Requirements		N/A
G.7.6.2.2	Test with 8 mm strand		N/A
<b>G.8</b>	<b>Varistors</b>		N/A
G.8.1	General requirements		N/A
G.8.2	Safeguards against fire		N/A
G.8.2.1	General		N/A
G.8.2.2	Varistor overload test		N/A
G.8.2.3	Temporary overvoltage test		N/A
<b>G.9</b>	<b>Integrated circuit (IC) current limiters</b>		N/A
G.9.1	Requirements		N/A
	IC limiter output current (max. 5A)..... :		—
	Manufacturers' defined drift ..... :		—
G.9.2	Test Program		N/A
G.9.3	Compliance		N/A
<b>G.10</b>	<b>Resistors</b>		N/A
G.10.1	General		N/A

TRF No. IEC62368\_1E

IEC 62368-1			
Clause	Requirement + Test	Result - Remark	Verdict
G.10.2	Conditioning		N/A
G.10.3	Resistor test		N/A
G.10.4	Voltage surge test		N/A
G.10.5	Impulse test		N/A
G.10.6	Overload test		N/A
<b>G.11</b>	<b>Capacitors and RC units</b>		N/A
G.11.1	General requirements		N/A
G.11.2	Conditioning of capacitors and RC units		N/A
G.11.3	Rules for selecting capacitors		N/A
<b>G.12</b>	<b>Optocouplers</b>		N/A
	Optocouplers comply with IEC 60747-5-5 with specifics		N/A
	Type test voltage $V_{ini,a}$ ..... :		—
	Routine test voltage, $V_{ini,b}$ ..... :		—
<b>G.13</b>	<b>Printed boards</b>		P
G.13.1	General requirements	See below.	P
G.13.2	Uncoated printed boards	Certified uncoated printed board used.	P
G.13.3	Coated printed boards		N/A
G.13.4	Insulation between conductors on the same inner surface		N/A
G.13.5	Insulation between conductors on different surfaces		N/A
	Distance through insulation..... :		N/A
	Number of insulation layers (pcs) ..... :		—
G.13.6	Tests on coated printed boards		N/A
G.13.6.1	Sample preparation and preliminary inspection		N/A
G.13.6.2	Test method and compliance		N/A
<b>G.14</b>	<b>Coating on components terminals</b>		N/A
G.14.1	Requirements ..... :		N/A
<b>G.15</b>	<b>Pressurized liquid filled components</b>		N/A
G.15.1	Requirements		N/A
G.15.2	Test methods and compliance		N/A
G.15.2.1	Hydrostatic pressure test		N/A

TRF No. IEC62368\_1E



IEC 62368-1			
Clause	Requirement + Test	Result - Remark	Verdict
G.15.2.2	Creep resistance test		N/A
G.15.2.3	Tubing and fittings compatibility test		N/A
G.15.2.4	Vibration test		N/A
G.15.2.5	Thermal cycling test		N/A
G.15.2.6	Force test		N/A
G.15.3	Compliance		N/A
<b>G.16</b>	<b>IC including capacitor discharge function (ICX)</b>		N/A
G.16.1	Condition for fault tested is not required		N/A
	ICX with associated circuitry tested in equipment		N/A
	ICX tested separately		N/A
G.16.2	Tests		N/A
	Smallest capacitance and smallest resistance specified by ICX manufacturer for impulse test..... :		—
	Mains voltage that impulses to be superimposed on ..... :		—
	Largest capacitance and smallest resistance for ICX tested by itself for 10000 cycles test..... :		—
G.16.3	Capacitor discharge test..... :		N/A
<b>H</b>	<b>CRITERIA FOR TELEPHONE RINGING SIGNALS</b>		N/A
<b>H.1</b>	<b>General</b>		N/A
<b>H.2</b>	<b>Method A</b>		N/A
<b>H.3</b>	<b>Method B</b>		N/A
H.3.1	Ringling signal		N/A
H.3.1.1	Frequency (Hz) ..... :		—
H.3.1.2	Voltage (V) ..... :		—
H.3.1.3	Cadence; time (s) and voltage (V) ..... :		—
H.3.1.4	Single fault current (mA):..... :		—
H.3.2	Tripping device and monitoring voltage		N/A
H.3.2.1	Conditions for use of a tripping device or a monitoring voltage		N/A
H.3.2.2	Tripping device		N/A
H.3.2.3	Monitoring voltage (V)..... :		N/A

IEC 62368-1			
Clause	Requirement + Test		Verdict
<b>J</b>	<b>INSULATED WINDING WIRES FOR USE WITHOUT INTERLEAVED INSULATION</b>		N/A
<b>J.1</b>	<b>General</b>		N/A
	Winding wire insulation..... :		—
	Solid round winding wire, diameter (mm)..... :		N/A
	Solid square and rectangular (flatwise bending) winding wire, cross-sectional area (mm <sup>2</sup> )..... :		N/A
<b>J.2/J.3</b>	Tests and Manufacturing		—
<b>K</b>	<b>SAFETY INTERLOCKS</b>		N/A
<b>K.1</b>	<b>General requirements</b>		N/A
	Instructional safeguard..... :		N/A
<b>K.2</b>	<b>Components of safety interlock safeguard mechanism</b>		N/A
<b>K.3</b>	<b>Inadvertent change of operating mode</b>		N/A
<b>K.4</b>	<b>Interlock safeguard override</b>		N/A
<b>K.5</b>	<b>Fail-safe</b>		N/A
K.5.1	Under single fault condition		N/A
<b>K.6</b>	<b>Mechanically operated safety interlocks</b>		N/A
K.6.1	Endurance requirement		N/A
K.6.2	Test method and compliance..... :		N/A
<b>K.7</b>	<b>Interlock circuit isolation</b>		N/A
K.7.1	Separation distance for contact gaps & interlock circuit elements		N/A
	In circuit connected to mains, separation distance for contact gaps (mm)..... :		N/A
	In circuit isolated from mains, separation distance for contact gaps (mm)..... :		N/A
	Electric strength test before and after the test of K.7.2..... :	(See appended table 5.4.9)	N/A
K.7.2	Overload test, Current (A)..... :		N/A
K.7.3	Endurance test		N/A
K.7.4	Electric strength test		N/A
<b>L</b>	<b>DISCONNECT DEVICES</b>		N/A
<b>L.1</b>	<b>General requirements</b>		N/A
<b>L.2</b>	<b>Permanently connected equipment</b>		N/A

TRF No. IEC62368\_1E

IEC 62368-1			
Clause	Requirement + Test	Result - Remark	Verdict
L.3	<b>Parts that remain energized</b>		N/A
L.4	<b>Single-phase equipment</b>		N/A
L.5	<b>Three-phase equipment</b>		N/A
L.6	<b>Switches as disconnect devices</b>		N/A
L.7	<b>Plugs as disconnect devices</b>		N/A
L.8	<b>Multiple power sources</b>		N/A
	Instructional safeguard..... :		N/A
<b>M</b>	<b>EQUIPMENT CONTAINING BATTERIES AND THEIR PROTECTION CIRCUITS</b>		N/A
<b>M.1</b>	<b>General requirements</b>		N/A
<b>M.2</b>	<b>Safety of batteries and their cells</b>		N/A
M.2.1	Batteries and their cells comply with relevant IEC standards..... :		N/A
<b>M.3</b>	<b>Protection circuits for batteries provided within the equipment</b>		N/A
M.3.1	Requirements		N/A
M.3.2	Test method		N/A
	Overcharging of a rechargeable battery		N/A
	Excessive discharging		N/A
	Unintentional charging of a non-rechargeable battery		N/A
	Reverse charging of a rechargeable battery		N/A
M.3.3	Compliance		N/A
<b>M.4</b>	<b>Additional safeguards for equipment containing a portable secondary lithium battery</b>		N/A
M.4.1	General		N/A
M.4.2	Charging safeguards		N/A
M.4.2.1	Requirements		N/A
M.4.2.2	Compliance..... :		N/A
M.4.3	Fire enclosure..... :		N/A
M.4.4	Drop test of equipment containing a secondary lithium battery		N/A
M.4.4.2	Preparation and procedure for the drop test		N/A
M.4.4.3	Drop, Voltage on reference and dropped batteries (V); voltage difference during 24 h period (%): ..... :		N/A

TRF No. IEC62368\_1E

IEC 62368-1			
Clause	Requirement + Test	Result - Remark	Verdict
M.4.4.4	Check of the charge/discharge function		N/A
M.4.4.5	Charge / discharge cycle test		N/A
M.4.4.6	Compliance		N/A
<b>M.5</b>	<b>Risk of burn due to short-circuit during carrying</b>		N/A
M.5.1	Requirement		N/A
M.5.2	Test method and compliance		N/A
<b>M.6</b>	<b>Safeguards against short-circuits</b>		N/A
M.6.1	External and internal faults		N/A
M.6.2	Compliance		N/A
<b>M.7</b>	<b>Risk of explosion from lead acid and NiCd batteries</b>		N/A
M.7.1	Ventilation preventing explosive gas concentration		N/A
	Calculated hydrogen generation rate..... :		N/A
M.7.2	Test method and compliance		N/A
	Minimum air flow rate, Q (m <sup>3</sup> /h)..... :		N/A
M.7.3	Ventilation tests		N/A
M.7.3.1	General		N/A
M.7.3.2	Ventilation test – alternative 1		N/A
	Hydrogen gas concentration (%)..... :		N/A
M.7.3.3	Ventilation test – alternative 2		N/A
	Obtained hydrogen generation rate..... :		N/A
M.7.3.4	Ventilation test – alternative 3		N/A
	Hydrogen gas concentration (%)..... :		N/A
M.7.4	Marking..... :		N/A
<b>M.8</b>	<b>Protection against internal ignition from external spark sources of batteries with aqueous electrolyte</b>		N/A
M.8.1	General		N/A
M.8.2	Test method		N/A
M.8.2.1	General		N/A
M.8.2.2	Estimation of hypothetical volume V <sub>Z</sub> (m <sup>3</sup> /s)..... :		—
M.8.2.3	Correction factors..... :		—
M.8.2.4	Calculation of distance d (mm) ..... :		—
<b>M.9</b>	<b>Preventing electrolyte spillage</b>		N/A

TRF No. IEC62368\_1E



IEC 62368-1			
Clause	Requirement + Test	Result - Remark	Verdict
M.9.1	Protection from electrolyte spillage		N/A
M.9.2	Tray for preventing electrolyte spillage		N/A
<b>M.10</b>	Instructions to prevent reasonably foreseeable misuse		N/A
	Instructional safeguard..... :		N/A
<b>N</b>	<b>ELECTROCHEMICAL POTENTIALS</b>		N/A
	Material(s) used..... :		—
<b>O</b>	<b>MEASUREMENT OF CREEPAGE DISTANCES AND CLEARANCES</b>		N/A
	Value of X (mm)..... :		—
<b>P</b>	<b>SAFEGUARDS AGAINST CONDUCTIVE OBJECTS</b>		N/A
<b>P.1</b>	<b>General</b>	Building-in Equipment, shall be evaluated in end product.	N/A
<b>P.2</b>	<b>Safeguards against entry or consequences of entry of a foreign object</b>		N/A
P.2.1	General		N/A
P.2.2	Safeguards against entry of a foreign object		N/A
	Location and Dimensions (mm) .....:		—
P.2.3	Safeguards against the consequences of entry of a foreign object		N/A
P.2.3.1	Safeguard requirements		N/A
	The ES3 and PS3 keep-out volume in Figure P.3 not applicable to transportable equipment		N/A
	Transportable equipment with metalized plastic parts..... :		N/A
P.2.3.2	Consequence of entry test..... :		N/A
<b>P.3</b>	<b>Safeguards against spillage of internal liquids</b>		N/A
P.3.1	General		N/A
P.3.2	Determination of spillage consequences		N/A
P.3.3	Spillage safeguards		N/A
P.3.4	Compliance		N/A
<b>P.4</b>	<b>Metallized coatings and adhesives securing parts</b>		N/A
P.4.1	General		N/A
P.4.2	Tests		N/A
	Conditioning, T <sub>c</sub> (°C)..... :		—

IEC 62368-1			
Clause	Requirement + Test	Result - Remark	Verdict
	Duration (weeks).....:		—
<b>Q</b>	<b>CIRCUITS INTENDED FOR INTERCONNECTION WITH BUILDING WIRING</b>		P
<b>Q.1</b>	<b>Limited power sources</b>		P
Q.1.1	Requirements		P
	a) Inherently limited output		N/A
	b) Impedance limited output		P
	c) Regulating network limited output		N/A
	d) Overcurrent protective device limited output		N/A
	e) IC current limiter complying with G.9		N/A
Q.1.2	Test method and compliance.....:	(See appended table Q.1)	P
	Current rating of overcurrent protective device (A) .....:		N/A
<b>Q.2</b>	<b>Test for external circuits – paired conductor cable</b>		N/A
	Maximum output current (A) .....		N/A
	Current limiting method.....:		—
<b>R</b>	<b>LIMITED SHORT CIRCUIT TEST</b>		N/A
<b>R.1</b>	<b>General</b>		N/A
<b>R.2</b>	<b>Test setup</b>		N/A
	Overcurrent protective device for test.....:		—
<b>R.3</b>	<b>Test method</b>		N/A
	Cord/cable used for test.....:		—
<b>R.4</b>	<b>Compliance</b>		N/A
<b>S</b>	<b>TESTS FOR RESISTANCE TO HEAT AND FIRE</b>		N/A
<b>S.1</b>	<b>Flammability test for fire enclosures and fire barrier materials of equipment where the steady state power does not exceed 4 000 W</b>		N/A
	Samples, material.....:		—
	Wall thickness (mm).....:		—
	Conditioning (°C).....:		—
	Test flame according to IEC 60695-11-5 with conditions as set out		N/A
	- Material not consumed completely		N/A
	- Material extinguishes within 30s		N/A

TRF No. IEC62368\_1E

IEC 62368-1			
Clause	Requirement + Test	Result - Remark	Verdict
	- No burning of layer or wrapping tissue		N/A
<b>S.2</b>	<b>Flammability test for fire enclosure and fire barrier integrity</b>		N/A
	Samples, material..... :		—
	Wall thickness (mm)..... :		—
	Conditioning (°C)..... :		—
<b>S.3</b>	<b>Flammability test for the bottom of a fire enclosure</b>		N/A
S.3.1	Mounting of samples		N/A
S.3.2	Test method and compliance		N/A
	Mounting of samples ..... :		—
	Wall thickness (mm)..... :		—
<b>S.4</b>	<b>Flammability classification of materials</b>		N/A
<b>S.5</b>	<b>Flammability test for fire enclosure materials of equipment with a steady state power exceeding 4 000 W</b>		N/A
	Samples, material..... :		—
	Wall thickness (mm)..... :		—
	Conditioning (°C)..... :		—
<b>T</b>	<b>MECHANICAL STRENGTH TESTS</b>		N/A
<b>T.1</b>	<b>General</b>		N/A
<b>T.2</b>	<b>Steady force test, 10 N</b> .....		N/A
<b>T.3</b>	<b>Steady force test, 30 N</b> .....		N/A
<b>T.4</b>	<b>Steady force test, 100 N</b> .....		N/A
<b>T.5</b>	<b>Steady force test, 250 N</b> .....		N/A
<b>T.6</b>	<b>Enclosure impact test</b>		N/A
	Fall test		N/A
	Swing test		N/A
<b>T.7</b>	<b>Drop test</b> .....		N/A
<b>T.8</b>	<b>Stress relief test</b> ..... :		N/A
<b>T.9</b>	<b>Glass Impact Test</b> ..... :		N/A
<b>T.10</b>	<b>Glass fragmentation test</b>		N/A
	Number of particles counted..... :		N/A
<b>T.11</b>	<b>Test for telescoping or rod antennas</b>		N/A

TRF No. IEC62368\_1E

IEC 62368-1			
Clause	Requirement + Test		Verdict
	Torque value (Nm) ..... :		N/A
<b>U</b>	<b>MECHANICAL STRENGTH OF CATHODE RAY TUBES (CRT) AND PROTECTION AGAINST THE EFFECTS OF IMPLOSION</b>		N/A
<b>U.1</b>	<b>General</b>		N/A
	Instructional safeguard :		N/A
<b>U.2</b>	<b>Test method and compliance for non-intrinsically protected CRTs</b>		N/A
<b>U.3</b>	<b>Protective screen</b>		N/A
<b>V</b>	<b>DETERMINATION OF ACCESSIBLE PARTS</b>		N/A
<b>V.1</b>	<b>Accessible parts of equipment</b>		N/A
V.1.1	General	Built-in type, shall be evaluated in end product.	N/A
V.1.2	Surfaces and openings tested with jointed test probes		N/A
V.1.3	Openings tested with straight unjointed test probes		N/A
V.1.4	Plugs, jacks, connectors tested with blunt probe		N/A
V.1.5	Slot openings tested with wedge probe		N/A
V.1.6	Terminals tested with rigid test wire		N/A
<b>V.2</b>	<b>Accessible part criterion</b>		P
<b>X</b>	<b>ALTERNATIVE METHOD FOR DETERMINING CLEARANCES FOR INSULATION IN CIRCUITS CONNECTED TO AN AC MAINS NOT EXCEEDING 420 V PEAK (300 V RMS)</b>		N/A
	Clearance..... :	(See appended table X)	N/A
<b>Y</b>	<b>CONSTRUCTION REQUIREMENTS FOR OUTDOOR ENCLOSURES</b>		N/A
<b>Y.1</b>	<b>General</b>		N/A
<b>Y.2</b>	<b>Resistance to UV radiation</b>		N/A
<b>Y.3</b>	<b>Resistance to corrosion</b>		N/A
<b>Y.3</b>	<b>Resistance to corrosion</b>		N/A
Y.3.1	Metallic parts of outdoor enclosures are resistant to effects of water-borne contaminants by..... :		N/A
Y.3.2	Test apparatus		N/A
Y.3.3	Water – saturated sulphur dioxide atmosphere		N/A
Y.3.4	Test procedure..... :		N/A
Y.3.5	Compliance		N/A
<b>Y.4</b>	<b>Gaskets</b>		N/A

TRF No. IEC62368\_1E



**IEC 62368-1**

Clause	Requirement + Test	Result - Remark	Verdict
Y.4.1	General		N/A
Y.4.2	Gasket tests		N/A
Y.4.3	Tensile strength and elongation tests		N/A
	Alternative test methods..... :		N/A
Y.4.4	Compression test		N/A
Y.4.5	Oil resistance		N/A
Y.4.6	Securing means		N/A
<b>Y.5</b>	<b>Protection of equipment within an outdoor enclosure</b>		N/A
Y.5.1	General		N/A
Y.5.2	Protection from moisture		N/A
	Relevant tests of IEC 60529 or Y.5.3..... :		N/A
Y.5.3	Water spray test		N/A
Y.5.4	Protection from plants and vermin		N/A
Y.5.5	Protection from excessive dust		N/A
Y.5.5.1	General		N/A
Y.5.5.2	IP5X equipment		N/A
Y.5.5.3	IP6X equipment		N/A
<b>Y.6</b>	<b>Mechanical strength of enclosures</b>		N/A
Y.6.1	General		N/A
Y.6.2	Impact test..... :		N/A

IEC 62368-1			
Clause	Requirement + Test	Result - Remark	Verdict

5.2	TABLE: Classification of electrical energy sources						P
Supply Voltage	Location (e.g. circuit designation)	Test conditions	Parameters				ES Class
			U (V)	I (mA)	Type <sup>1)</sup>	Additional Info <sup>2)</sup>	
5Vdc	Input circuits	Normal	5.0Vrms	--	SS	--	ES1
		Abnormal	--	--	--	--	
		Single fault - SC/OC	--	--	--	--	
5Vdc	Signal terminal	Normal	0Vrms	--	SS	--	ES1
		Abnormal	--	--	--	--	
		Single fault - SC/OC	--	--	--	--	
Supplementary information:							
1) Type: Steady state (SS), Capacitance (CP), Single pulse (SP), Repetitive pulses (RP), etc.							
2) Additional Info: Frequency, Pulse duration, Pulse off time, Capacitance value, etc.							

5.4.1.8	TABLE: Working voltage measurement				N/A
Location	RMS voltage (V)	Peak voltage (V)	Frequency (Hz)	Comments	
--	--	--	--	--	
--	--	--	--	--	
Supplementary information:					

5.4.1.10.2	TABLE: Vicat softening temperature of thermoplastics			N/A
Method..... : ISO 306 / B50			—	
Object/ Part No./Material	Manufacturer/trademark	Thickness (mm)	T softening (°C)	
--	--	--	--	
--	--	--	--	
Supplementary information:				

5.4.1.10.3	TABLE: Ball pressure test of thermoplastics		N/A
Allowed impression diameter (mm)..... : ≤ 2 mm		—	

IEC 62368-1				
Clause	Requirement + Test		Result - Remark	Verdict
Object/Part No./Material	Manufacturer/trademark	Thickness (mm)	Test temperature (°C)	Impression diameter (mm)
--	--	--	--	--
--	--	--	--	--
Supplementary information:				

5.4.2, 5.4.3 TABLE: Minimum Clearances/Creepage distance								N/A
Clearance (cl) and creepage distance (cr) at/of/between:	U <sub>p</sub> (V)	U <sub>rms</sub> (V)	Freq <sup>1)</sup> (Hz)	Required cl (mm)	cl (mm)	E.S. <sup>2)</sup> (V)	Required cr (mm)	cr (mm)
--	--	--	--	--	--	--	--	--
--	--	--	--	--	--	--	--	--
Supplementary information:								
1) Only for frequency above 30 kHz								
2) Complete Electric Strength voltage (E.S. (V) when 5.4.2.4 applied)								

5.4.4.2 TABLE: Minimum distance through insulation					N/A
Distance through insulation (DTI) at/of	Peak voltage (V)	Insulation	Required DTI (mm)	Measured DTI (mm)	
--	--	--	--	--	
Supplementary information:					

5.4.4.9 TABLE: Solid insulation at frequencies >30 kHz							N/A
Insulation material	E <sub>p</sub>	Frequency (kHz)	K <sub>R</sub>	Thickness d (mm)	Insulation	V <sub>PW</sub> (Vpk)	
--	--	--	--	--	--	--	
Supplementary information:							

5.4.9 TABLE: Electric strength tests				N/A
Test voltage applied between:	Voltage shape (Surge, Impulse, AC, DC, etc.)	Test voltage (V)	Breakdown Yes / No	
--	--	--	--	

TRF No. IEC62368\_1E

IEC 62368-1			
Clause	Requirement + Test	Result - Remark	Verdict
--	--	--	--
Supplementary information:			

5.5.2.2	TABLE: Stored discharge on capacitors					N/A
Location	Supply voltage (V)	Operating and fault condition <sup>1)</sup>	Switch position	Measured voltage (Vpk)	ES Class	
--	--	--	--	--	--	
Supplementary information:						
X-capacitors installed for testing:						
[ ] bleeding resistor rating:						
[ ] ICX:						
1) Normal operating condition (e.g., normal operation, or open fuse), SC= short circuit, OC= open circuit						

5.6.6	TABLE: Resistance of protective conductors and terminations				N/A
Location	Test current (A)	Duration (min)	Voltage drop (V)	Resistance (Ω)	
--	--	--	--	--	
Supplementary information:					

5.7.4	TABLE: Unearthed accessible parts					N/A
Location	Operating and fault conditions	Supply Voltage (V)	Parameters			ES class
			Voltage (V <sub>rms</sub> or V <sub>pk</sub> )	Current (A <sub>rms</sub> or A <sub>pk</sub> )	Freq. (Hz)	
--	--	--	--	--	--	--
Supplementary information:						
Abbreviation: SC= short circuit; OC= open circuit						

5.7.5	TABLE: Earthed accessible conductive part			N/A
Supply voltage (V).....:				—
Phase(s) .....	[ ] Single Phase; [ ] Three Phase: [ ] Delta [ ] Wye			
Power Distribution System .....	[ ] TN [ ] TT [ ] IT			
Location	Fault Condition No in IEC 60990 clause 6.2.2	Touch current (mA)	Comment	

TRF No. IEC62368\_1E



IEC 62368-1			
Clause	Requirement + Test	Result - Remark	Verdict
--	--	--	--
Supplementary Information:			

5.8	TABLE: Backfeed safeguard in battery backed up supplies					N/A
Location	Supply voltage (V)	Operating and fault condition	Time (s)	Open-circuit voltage (V)	Touch current (A)	ES Class
--	--	--	--	--	--	--
Supplementary information:						
Abbreviation: SC= short circuit, OC= open circuit						

6.2.2	TABLE: Power source circuit classifications					P
Location	Operating and fault condition	Voltage (V)	Current (A)	Max. Power <sup>1)</sup> (W)	Time (S)	PS class
Internal circuits	Normal	--	--	--	--	PS1 (Declared)
Signal terminal	Normal	0	0	0	3	PS1
Supplementary information:						
Abbreviation: SC= short circuit; OC= open circuit						
1) Measured after 3 s for PS1 and measured after 5 s for PS2 and PS3.						

6.2.3.1	TABLE: Determination of Arcing PIS				N/A
Location	Open circuit voltage after 3 s (Vpk)	Measured r.m.s current (A)	Calculated value	Arcing PIS? Yes / No	
--	--	--	--	--	
Supplementary information:					

6.2.3.2	TABLE: Determination of resistive PIS			N/A
Location	Operating and fault condition	Dissipate power (W)		Arcing PIS? Yes / No
--	--	--		--
Supplementary information:				
Abbreviation: SC= short circuit; OC= open circuit				

TRF No. IEC62368\_1E

IEC 62368-1			
Clause	Requirement + Test	Result - Remark	Verdict

8.5.5	TABLE: High pressure lamp				N/A
Lamp manufacturer	Lamp type	Explosion method	Longest axis of glass particle (mm)	Particle found beyond 1 m Yes / No	
--	--	--	--	--	
Supplementary information:					

9.6	TABLE: Temperature measurements for wireless power transmitters							N/A
Supply voltage (V).....:								—
Max. transmit power of transmitter (W).....:								—
Foreign objects	w/o receiver and direct contact		with receiver and direct contact		with receiver and at distance of 2 mm		with receiver and at distance of 5 mm	
	Object (°C)	Ambient (°C)	Object (°C)	Ambient (°C)	Object (°C)	Ambient (°C)	Object (°C)	Ambient (°C)
--	--	--	--	--	--	--	--	--
Supplementary information:								

5.4.1.4, 9.3, B.1.5, B.2.6	TABLE: Temperature measurements							P
Supply voltage (V).....:		5Vdc						—
Ambient temperature during test $T_{amb}$ (°C).....:		--		--		--		—
Maximum measured temperature $T$ of part/at:		$T$ (°C)						Allowed $T_{max}$ (°C)
PCB near U1		42.6		78.4		130		
PCB near U7		38.6		74.4		130		
PCB near U9		35.9		71.7		130		
Ambient		24.2		Shift to 60.0		--		
Temperature $T$ of winding:	$t_1$ (°C)	$R_1$ (Ω)	$t_2$ (°C)	$R_2$ (Ω)	$T$ (°C)	Allowed $T_{max}$ (°C)	Insulation class	
--	--	--	--	--	--	--	--	

IEC 62368-1			
Clause	Requirement + Test	Result - Remark	Verdict

Supplementary information:

B.2.5		TABLE: Input test							P
U (V)	Hz	I (A)	I rated (A)	P (W)	P rated (W)	Fuse No	I fuse (A)	Condition/status	
5Vdc	--	0.16	3.0	0.80	--	--	--	Operation normally	

Supplementary information:

B.3, B.4		TABLE: Abnormal operating and fault condition tests					P
Ambient temperature $T_{amb}$ (°C)..... :						See below	—
Power source for EUT: Manufacturer, model/type, output rating.... :						See marking plate	—
Component No.	Condition	Supply voltage (V)	Test time	Fuse no.	Fuse current (A)	Observation	
C110	SC	5Vdc	10mins	--	--	Unit shut down immediately, no damaged, no hazards	

Supplementary information: SC: Short circuits.

M.3		TABLE: Protection circuits for batteries provided within the equipment					N/A
Is it possible to install the battery in a reverse polarity position?..... :						--	—
Equipment Specification	Charging						
	Voltage (V)				Current (A)		
	--				--		
Manufacturer/type	Battery specification						
	Non-rechargeable batteries			Rechargeable batteries			
	Discharging current (A)	Unintentional charging current (A)	Charging		Discharging current (A)	Reverse charging current (A)	
			Voltage (V)	Current (A)			
	--	--	--	--	--	--	

Note: The tests of M.3.2 are applicable only when above appropriate data is not available.

Specified battery temperature (°C)..... :

Component No.	Fault condition	Charge/discharge mode	Test time	Temp. (°C)	Current (A)	Voltage (V)	Observation
--	--	--	--	--	--	--	--

TRF No. IEC62368\_1E

IEC 62368-1								
Clause	Requirement + Test					Result - Remark		Verdict
--	--	--	--	--	--	--	--	
--	--	--	--	--	--	--	--	
--	--	--	--	--	--	--	--	
Supplementary information:								
Abbreviation: SC= short circuit; OC= open circuit NL= no chemical leakage; NS= no spillage of liquid; NE= no explosion; NF= no emission of flame or expulsion of molten metal.								

M.4.2	TABLE: Charging safeguards for equipment containing a secondary lithium battery					N/A
Maximum specified charging voltage (V)..... :					--	—
Maximum specified charging current (A) .....					--	—
Highest specified charging temperature (°C) .....					--	
Lowest specified charging temperature (°C) .....					--	
Battery manufacturer/type	Operating and fault condition	Measurement			Observation	
		Charging voltage (V)	Charging current (A)	Temp. (°C)		
--	--	--	--	--	--	
--	--	--	--	--	--	
--	--	--	--	--	--	
--	--	--	--	--	--	
Supplementary information:						
Abbreviation: SC= short circuit; OC= open circuit; MSCV= maximum specified charging voltage; MSCC= maximum specified charging current; HSCT= highest specified charging temperature; LSCT= lowest specified charging temperature						

Q.1	TABLE: Circuits intended for interconnection with building wiring (LPS)						P
Output Circuit	Condition	U <sub>oc</sub> (V)	Time (s)	I <sub>sc</sub> (A)		S (VA)	
				Meas.	Limit	Meas.	Limit
Signal terminal	Normal	0	5	0	8	0	100
Supplementary Information:							

T.2, T.3, T.4, T.5	TABLE: Steady force test	N/A
--------------------	--------------------------	-----



IEC 62368-1			
Clause	Requirement + Test	Result - Remark	Verdict

Location/Part	Material	Thickness (mm)	Probe	Force (N)	Test Duration (s)	Observation
--	--	--	--	--	--	--

Supplementary information:

T.6, T.9	TABLE: Impact test				N/A
Location/Part	Material	Thickness (mm)	Height (mm)	Observation	
--	--	--	--	--	

Supplementary information:

T.7	TABLE: Drop test				N/A
Location/Part	Material	Thickness (mm)	Height (mm)	Observation	
--	--	--	--	--	

Supplementary information:

T.8	TABLE: Stress relief test				N/A
Location/Part	Material	Thickness (mm)	Oven Temperature (°C)	Duration (h)	Observation
--	--	--	--	--	--

Supplementary information:

X	TABLE: Alternative method for determining minimum clearances distances			N/A
Clearance distanced between:	Peak of working voltage (V)	Required cl (mm)	Measured cl (mm)	
--	--	--	--	

Supplementary information:

IEC 62368-1			
Clause	Requirement + Test	Result - Remark	Verdict

4.1.2	<b>TABLE: List of critical components</b>				P
Object / part No.	Manufacturer/ trademark	Type / model	Technical data	Standard <sup>2)</sup>	Mark(s) of conformity <sup>1)</sup>
PCB	SHENZHEN KING BROTHER ELECTRONICS TECHNOLOGY CO LTD	KB-04	V-0, 130°C	UL94, UL746	UL E225430
(Alternative)	Interchangeable	Interchangeable	V-0, 130°C	UL94, UL746	UL
Supplementary information:					
1) Provided evidence ensures the agreed level of compliance. See OD-CB2039.					
2) License available upon request.					

The test report is effective only with both signature and specialized stamp. The result(s) shown in this report refer only to the sample(s) tested. Without written approval of CTI, this report can't be reproduced except in full.

- - - End of Report - - -

National Differences			
Clause	Requirement + Test	Result - Remark	Verdict

ATTACHMENT TO TEST REPORT IEC 62368-1 EUROPEAN GROUP DIFFERENCES AND NATIONAL DIFFERENCES (Audio/video, information and communication technology equipment - Part 1: Safety requirements)		
<b>Differences according to</b> .....: EN IEC 62368-1:2020+A11:2020		
<b>Attachment Form No</b> .....: EU_GD_IEC62368_1E		
<b>Attachment Originator</b> .....: UL(Demko)		
<b>Master Attachment</b> .....: 2021-02-04		
<b>Copyright © 2021 IEC System for Conformity Testing and Certification of Electrical Equipment (IECEE), Geneva, Switzerland. All rights reserved.</b>		
	<b>CENELEC COMMON MODIFICATIONS (EN)</b>	--
	Clause numbers in the cells that are shaded light grey are clause references in EN IEC 62368-1:2020+A11:2020. All other clause numbers in that column, except for those in the paragraph below, refers to IEC 62368-1:2018.	--
	Clauses, subclauses, notes, tables, figures and annexes which are additional to those in IEC 62368-1:2018 are prefixed "Z".	
	Add the following annexes: Annex ZA (normative) Normative references to international publications with their corresponding European publications Annex ZB (normative) Special national conditions Annex ZC (informative) A-deviations Annex ZD (informative) IEC and CENELEC code designations for flexible cords	P
<b>1</b>	<b>Modification to Clause 3 .</b>	N/A
<b>3.3.19</b>	<b>Sound exposure</b> <i>Replace 3.3.19 of IEC 62368-1 with the following definitions:</i>	N/A

National Differences			
Clause	Requirement + Test	Result - Remark	Verdict
3.3.19.1	<p><b>momentary exposure level, MEL</b></p> <p>metric for estimating 1 s sound exposure level from the HD 483-1 S2 test signal applied to both channels, based on EN 50332-1:2013, 4.2.</p> <p>Note 1 to entry: MEL is measured as A-weighted levels in dB.</p> <p>Note 2 to entry: See B.3 of EN 50332-3:2017 for additional information.</p>		N/A
3.3.19.3	<p><b>sound exposure, E</b></p> <p>A-weighted sound pressure (<math>p</math>) squared and integrated over a stated period of time, <math>T</math></p> <p>Note 1 to entry: The SI unit is Pa<sup>2</sup> s.</p> $E = \int_0^T p(t)^2 dt$		N/A
3.3.19.4	<p><b>sound exposure level, SEL</b></p> <p>logarithmic measure of sound exposure relative to a reference value, <math>E_0</math>, typically the 1 kHz threshold of hearing in humans.</p> <p>Note 1 to entry: SEL is measured as A-weighted levels in dB.</p> $SEL = 10 \lg \left( \frac{E}{E_0} \right) \text{ dB}$ <p>Note 2 to entry: See B.4 of EN 50332-3:2017 for additional information.</p>		N/A



National Differences			
Clause	Requirement + Test	Result - Remark	Verdict
3.3.19.5	<p><b>digital signal level relative to full scale, dBFS</b></p> <p>levels reported in dBFS are always r.m.s. Full scale level, 0 dBFS, is the level of a dc-free 997-Hz sine wave whose undithered positive peak value is positive digital full scale, leaving the code corresponding to negative digital full scale unused</p> <p>Note 1 to entry: It is invalid to use dBFS for non-r.m.s. levels. Because the definition of full scale is based on a sine wave, the level of signals with a crest factor lower than that of a sine wave may exceed 0 dBFS. In particular, square wave signals may reach +3,01 dBFS.</p>		N/A
2	<b>Modification to Clause 10</b>		N/A
10.6	<p><b>Safeguards against acoustic energy sources</b></p> <p>Replace 10.6 of IEC 62368-1 with the following:</p>		N/A
10.6.1.1	<p><b>Introduction</b></p> <p><b>Safeguard</b> requirements for protection against long-term exposure to excessive sound pressure levels from personal music players closely coupled to the ear are specified below. Requirements for earphones and headphones intended for use with personal music players are also covered.</p> <p>A personal music player is a portable equipment intended for use by an <b>ordinary person</b>, that:</p> <ul style="list-style-type: none"> <li>– is designed to allow the user to listen to audio or audiovisual content / material; and</li> <li>– uses a listening device, such as headphones or earphones that can be worn in or on or around the ears; and</li> <li>– has a player that can be body worn (of a size suitable to be carried in a clothing pocket) and is intended for the user to walk around with while in continuous use (for example, on a street, in a subway, at an airport, etc.).</li> </ul> <p>EXAMPLES Portable CD players, MP3 audio players, mobile phones with MP3 type features,</p>		N/A

TRF No. IEC62368\_1E

National Differences			
Clause	Requirement + Test	Result - Remark	Verdict
	<p>PDA's or similar equipment.</p> <p>Personal music players shall comply with the requirements of either 10.6.2 or 10.6.3.</p> <p>NOTE 1 Protection against acoustic energy sources from telecom applications is referenced to ITU-T P.360.</p> <p>NOTE 2 It is the intention of the Committee to allow the alternative methods for now, but to only use the dose measurement method as given in 10.6.5 in future. Therefore, manufacturers are encouraged to implement 10.6.5 as soon as possible.</p> <p>Listening devices sold separately shall comply with the requirements of 10.6.6.</p> <p>These requirements are valid for music or video mode only.</p> <p>The requirements do not apply to:</p> <ul style="list-style-type: none"> <li>- professional equipment;</li> </ul> <p>NOTE 3 Professional equipment is equipment sold through special sales channels. All products sold through normal electronics stores are considered not to be professional equipment.</p> <ul style="list-style-type: none"> <li>- hearing aid equipment and other devices for assistive listening;</li> <li>- the following type of analogue personal music players:                             <ul style="list-style-type: none"> <li>• long distance radio receiver (for example, a multiband radio receiver or world band radio receiver, an AM radio receiver), and</li> <li>• cassette player/recorder;</li> </ul> </li> </ul> <p>NOTE 4 This exemption has been allowed because this technology is falling out of use and it is expected that within a few years it will no longer exist. This</p>		

TRF No. IEC62368\_1E

National Differences			
Clause	Requirement + Test	Result - Remark	Verdict
	<p>exemption will not be extended to other technologies.</p> <p>– a player while connected to an external amplifier that does not allow the user to walk around while in use.</p> <p>For equipment that is clearly designed or intended primarily for use by children, the limits of the relevant toy standards may apply.</p> <p>The relevant requirements are given in EN 71-1:2011, 4.20 and the related tests methods and measurement distances apply.</p>		
<b>10.6.1.2</b>	<p><b>Non-ionizing radiation from radio frequencies in the range 0 to 300 GHz</b></p> <p>The amount of non-ionizing radiation is regulated by European Council Recommendation 1999/519/EC of 12 July 1999 on the limitation of exposure of the general public to electromagnetic fields (0 Hz to 300 GHz).</p> <p>For intentional radiators, ICNIRP guidelines should be taken into account for Limiting Exposure to Time-Varying Electric, Magnetic, and Electromagnetic Fields (up to 300 GHz). For hand-held and body mounted devices, attention is drawn to EN 50360 and EN 50566.</p>		N/A
<b>10.6.2</b>	<p><b>Classification of devices without the capacity to estimate sound dose</b></p>		N/A
<b>10.6.2.1</b>	<p><b>General</b></p> <p>This standard is transitioning from short-term based (30 s) requirements to long-term based (40 hour) requirements. These clauses remain in effect only for devices that do not comply with sound dose estimation as stipulated in EN 50332-3.</p> <p>For classifying the acoustic output <math>L_{Aeq,T}</math>, measurements are based on the A-weighted equivalent sound pressure level over a 30 s period.</p> <p>For music where the average sound pressure (long</p>		N/A

TRF No. IEC62368\_1E

National Differences			
Clause	Requirement + Test	Result - Remark	Verdict
	<p>term <math>L_{Aeq,T}</math>) measured over the duration of the song is lower than the average produced by the programme simulation noise, measurements may be done over the duration of the complete song. In this case, <math>T</math> becomes the duration of the song.</p> <p>NOTE Classical music, acoustic music and broadcast typically has an average sound pressure (long term <math>L_{Aeq,T}</math>) which is much lower than the average programme simulation noise. Therefore, if the player is capable to analyse the content and compare it with the programme simulation noise, the warning does not need to be given as long as the average sound pressure of the song does not exceed the required limit.</p> <p>For example, if the player is set with the programme simulation noise to 85 dB, but the average music level of the song is only 65 dB, there is no need to give a warning or ask an acknowledgement as long as the average sound level of the song is not above the basic limit of 85 dB.</p>		
10.6.2.2	<p><b>RS1 limits (to be superseded, see 10.6.3.2)</b></p> <p>RS1 is a class 1 acoustic energy source that does not exceed the following:</p> <ul style="list-style-type: none"> <li>– for equipment provided as a package (player with its listening device), and with a proprietary connector between the player and its listening device, or where the combination of player and listening device is known by other means such as setting or automatic detection, the <math>L_{Aeq,T}</math> acoustic output shall be <math>\leq 85</math> dB when playing the fixed “programme simulation noise” described in EN 50332-1.</li> <li>– for equipment provided with a standardized connector (for example, a 3,5 phone jack) that allows connection to a listening device for general use, the unweighted r.m.s. output voltage shall be <math>\leq 27</math> mV (analogue interface) or -25 dBFS (digital interface) when playing the fixed “programme simulation noise” described in EN 50332-1.</li> <li>– The RS1 limits will be updated for all devices as per 10.6.3.2.</li> </ul>		N/A



National Differences			
Clause	Requirement + Test	Result - Remark	Verdict
10.6.2.3	<p><b>RS2 limits (to be superseded, see 10.6.3.3)</b></p> <p>RS2 is a class 2 acoustic energy source that does not exceed the following:</p> <ul style="list-style-type: none"> <li>– for equipment provided as a package (player with its listening device), and with a proprietary connector between the player and its listening device, or when the combination of player and listening device is known by other means such as setting or automatic 130 detection, the <math>L_{Aeq,T}</math> acoustic output shall be <math>\leq 100</math> dB(A) when playing the fixed “programme simulation noise” as described in EN 50332-1.</li> <li>– for equipment provided with a standardized connector (for example, a 3,5 phone jack) that allows connection to a listening device for general use, the unweighted r.m.s. output voltage shall be <math>\leq 150</math> mV (analogue interface) or -10 dBFS (digital interface) when playing the fixed “programme simulation noise” as described in EN 50332-1.</li> </ul>		N/A
10.6.2.4	<p><b>RS3 limits</b></p> <p>RS3 is a class 3 acoustic energy source that exceeds RS2 limits.</p>		N/A
10.6.3	<b>Classification of devices (new)</b>		N/A
10.6.3.1	<p><b>General</b></p> <p>Previous limits (10.6.2) created abundant false negative and false positive PMP sound level warnings. New limits, compliant with The Commission Decision of 23 June 2009, are given below.</p>		N/A
10.6.3.2	<p><b>RS1 limits (new)</b></p> <p>RS1 is a class 1 acoustic energy source that does not exceed the following:</p> <ul style="list-style-type: none"> <li>– for equipment provided as a package (player with its listening device), and with a proprietary connector between the player and its listening device, or where the combination of player and listening device is known by other means such as setting or automatic detection, the <math>L_{Aeq,T}</math> acoustic output shall be <math>\leq 80</math> dB when playing the fixed</li> </ul>		N/A

TRF No. IEC62368\_1E

National Differences			
Clause	Requirement + Test	Result - Remark	Verdict
	<p>“programme simulation noise” described in EN 50332-1.</p> <p>– for equipment provided with a standardized connector (for example, a 3,5 phone jack) that allows connection to a listening device for general use, the unweighted r.m.s. output voltage shall be <math>\leq 15</math> mV (analogue interface) or -30 dBFS (digital interface) when playing the fixed “programme simulation noise” described in EN 50332-1.</p>		
<b>10.6.3.3</b>	<p><b>RS2 limits (new)</b></p> <p>RS2 is a class 2 acoustic energy source that does not exceed the following:</p> <p>– for equipment provided as a package (player with its listening device), and with a proprietary connector between the player and its listening device, or where the combination of player and listening device is known by other means such as setting or automatic detection, the weekly sound exposure level, as described in EN 50332-3, shall be <math>\leq 80</math> dB when playing the fixed “programme simulation noise” described in EN 50332-1.</p> <p>– for equipment provided with a standardized connector (for example, a 3,5 phone jack) that allows connection to a listening device for general use, the unweighted r.m.s. output level, integrated over one week, as described in EN50332-3, shall be <math>\leq 15</math> mV (analogue interface) or -30 dBFS (digital interface) when playing the fixed “programme simulation noise” described in EN 50332-1.</p>		N/A
<b>10.6.4</b>	<b>Requirements for maximum sound exposure</b>		N/A
<b>10.6.4.1</b>	<p><b>Measurement methods</b></p> <p>All volume controls shall be turned to maximum during tests.</p> <p>Measurements shall be made in accordance with EN 50332-1 or EN 50332-2 as applicable.</p>		N/A
<b>10.6.4.2</b>	<p><b>Protection of persons</b></p> <p>Except as given below, protection requirements for parts <b>accessible to ordinary persons, instructed</b></p>		N/A

TRF No. IEC62368\_1E

National Differences			
Clause	Requirement + Test	Result - Remark	Verdict
	<p><b>persons</b> and <b>skilled persons</b> are given in 4.3.</p> <p>NOTE 1 Volume control is not considered a <b>safeguard</b>.</p> <p>Between RS2 and an <b>ordinary person</b>, the <b>basic safeguard</b> may be replaced by an <b>instructional safeguard</b> in accordance with Clause F.5, except that the <b>instructional safeguard</b> shall be placed on the equipment, or on the packaging, or in the instruction manual.</p> <p>Alternatively, the <b>instructional safeguard</b> may be given through the equipment display during use.</p> <p>The elements of the <b>instructional safeguard</b> shall be as follows:</p> <ul style="list-style-type: none"> <li>– element 1a: the symbol , IEC 60417-6044 (2011-01)</li> <li>– element 2: “High sound pressure” or equivalent wording</li> <li>– element 3: “Hearing damage risk” or equivalent wording</li> <li>– element 4: “Do not listen at high volume levels for long periods.” or equivalent wording</li> </ul> <p>An <b>equipment safeguard</b> shall prevent exposure of an <b>ordinary person</b> to an RS2 source without intentional physical action from the <b>ordinary person</b> and shall automatically return to an output level not exceeding what is specified for an RS1 source when the power is switched off.</p> <p>The equipment shall provide a means to actively inform the user of the increased sound level when the equipment is operated with an output exceeding RS1. Any means used shall be acknowledged by the user before activating a mode of operation which allows for an output exceeding RS1. The acknowledgement does not need to be repeated more than once every 20 h of cumulative listening time.</p>		

TRF No. IEC62368\_1E

National Differences			
Clause	Requirement + Test	Result - Remark	Verdict
	<p>NOTE 2 Examples of means include visual or audible signals. Action from the user is always needed.</p> <p>NOTE 3 The 20 h listening time is the accumulative listening time, independent of how often and how long the personal music player has been switched off.</p> <p>A <b>skilled person</b> shall not be unintentionally exposed to RS3.</p>		
<b>10.6.5</b>	<b>Requirements for dose-based systems</b>		N/A
<b>10.6.5.1</b>	<p><b>General requirements</b></p> <p>Personal music players shall give the warnings as provided below when tested according to EN 50332-3, using the limits from this clause.</p> <p>The manufacturer may offer optional settings to allow the users to modify when and how they wish to receive the notifications and warnings to promote a better user experience without defeating the safeguards. This allows the users to be informed in a method that best meets their physical capabilities and device usage needs. If such optional settings are offered, an administrator (for example, parental restrictions, business/educational administrators, etc.) shall be able to lock any optional settings into a specific configuration.</p> <p>The personal music player shall be supplied with easy to understand explanation to the user of the dose management system, the risks involved, and how to use the system safely. The user shall be made aware that other sources may significantly contribute to their sound exposure, for example work, transportation, concerts, clubs, cinema, car races, etc.</p>		N/A
<b>10.6.5.2</b>	<p><b>Dose-based warning and requirements</b></p> <p>When a dose of 100 % CSD is reached, and at least at every 100 % further increase of CSD, the</p>		N/A

TRF No. IEC62368\_1E



National Differences			
Clause	Requirement + Test	Result - Remark	Verdict
	<p>device shall warn the user and require an acknowledgement. In case the user does not acknowledge, the output level shall automatically decrease to compliance with class RS1.</p> <p>The warning shall at least clearly indicate that listening above 100 % CSD leads to the risk of hearing damage or loss.</p>		
<b>10.6.5.3</b>	<p><b>Exposure-based requirements</b></p> <p>With only dose-based requirements, cause and effect could be far separated in time, defying the purpose of educating users about safe listening practice. In addition to dose-based requirements, a PMP shall therefore also put a limit to the short-term sound level a user can listen at.</p> <p>The exposure-based limiter (EL) shall automatically reduce the sound level not to exceed 100 dB(A) or 150 mV integrated over the past 180 s, based on methodology defined in EN 50332-3.</p> <p>The EL settling time (time from starting level reduction to reaching target output) shall be 10 s or faster.</p> <p>Test of EL functionality is conducted according to EN 50332-3, using the limits from this clause. For equipment provided as a package (player with its listening device), the level integrated over 180 s shall be 100 dB or lower. For equipment provided with a standardized connector, the unweighted level integrated over 180 s shall be no more than 150 mV for an analogue interface and no more than -10 dBFS for a digital interface.</p> <p>NOTE In case the source is known not to be music (or test signal), the EL may be disabled.</p>		N/A
<b>10.6.6</b>	<b>Requirements for listening devices (headphones, earphones, etc.)</b>		N/A
<b>10.6.6.1</b>	<b>Corded listening devices with analogue input</b>		N/A
	With 94 dB LAeq acoustic pressure output of the		

National Differences			
Clause	Requirement + Test	Result - Remark	Verdict
	<p>listening device, and with the volume and sound settings in the listening device (for example, built-in volume level control, additional sound features like equalization, etc.) set to the combination of positions that maximize the measured acoustic output, the input voltage of the listening device when playing the fixed “programme simulation noise” as described in EN 50332-1 shall be <math>\geq 75</math> mV.</p> <p>NOTE The values of 94 dB and 75 mV correspond with 85 dB and 27 mV or 100 dB and 150 mV.</p>		
<b>10.6.6.2</b>	<p><b>Corded listening devices with digital input</b></p> <p>With any playing device playing the fixed “programme simulation noise” described in EN 50332-1, and with the volume and sound settings in the listening device (for example, built-in volume level control, additional sound features like equalization, etc.) set to the combination of positions that maximize the measured acoustic output, the <math>L_{Aeq,T}</math> acoustic output of the listening device shall be <math>\leq 100</math> dB with an input signal of -10 dBFS.</p>		N/A
<b>10.6.6.3</b>	<p><b>Cordless listening devices</b></p> <p>In cordless mode,</p> <ul style="list-style-type: none"> <li>– with any playing and transmitting device playing the fixed programme simulation noise described in EN 50332-1; and</li> <li>– respecting the cordless transmission standards, where an air interface standard exists that specifies the equivalent acoustic level; and</li> <li>– with volume and sound settings in the receiving device (for example, built-in volume level control, additional sound features like equalization, etc.) set to the combination of positions that maximize the measured acoustic output for the above mentioned programme simulation noise, the <math>L_{Aeq,T}</math> acoustic output of the listening device shall be <math>\leq 100</math> dB with an input signal of -10 dBFS.</li> </ul>		N/A
<b>10.6.6.4</b>	<p><b>Measurement method</b></p>		N/A

TRF No. IEC62368\_1E

National Differences							
Clause	Requirement + Test				Result - Remark		Verdict
	<i>Measurements shall be made in accordance with EN 50332-2 as applicable.</i>						
<b>3</b>	<b>Modification to the whole document</b>						<b>P</b>
	<b>Delete</b> all the "country" notes in the reference document according to the following list:						<b>P</b>
	0.2.1	Note 1 and 2	1	Note 4 and 5	3.3.8.1	Note 2	
	3.3.8.3	Note 1	4.1.15	Note	4.7.3	Note 1 and 2	
	5.2.2.2	Note	5.4.2.3.2.2 Table 12	Note c	5.4.2.3.2.4	Note 1 and 3	
	5.4.2.3.2.4 Table 13	Note 2	5.4.2.5	Note 2	5.4.5.1	Note	
	5.4.10.2.1	Note	5.4.10.2.2	Note	5.4.10.2.3	Note	
	5.5.2.1	Note	5.5.8	Note	5.6.4.2.1	Note 2 and 3 and 4	
	5.6.8	Note 2	5.7.8	Note	5.7.7.1	Note 1 and Note 2	
	8.5.4.2.3	Note	10.2.1 Table 39	Note 3 and 4 and 5	10.5.3	Note 2	
	<del>10.6.4</del>	Note 3	F.3.3.6	Note 3	Y.4.1	Note	
	Y.4.5	Note					
<b>4</b>	<b>Modification to Clause 1</b>						<b>P</b>
<b>1</b>	<b>Add</b> the following note:						<b>P</b>
	<i>NOTE Z1 The use of certain substances in electrical and electronic equipment is restricted within the EU: see Directive 2011/65/EU.</i>						
<b>5</b>	<b>Modification to 4.Z1</b>						<b>N/A</b>

National Differences			
Clause	Requirement + Test	Result - Remark	Verdict
4.Z1	<p><b>Add the following new subclause after 4.9:</b></p> <p>To protect against excessive current, short-circuits and earth faults in circuits connected to an a.c. <b>mains</b>, protective devices shall be included either as integral parts of the equipment or as parts of the building installation, subject to the following, a), b) and c):</p> <p>a) except as detailed in b) and c), protective devices necessary to comply with the requirements of B.3.1 and B.4 shall be included as parts of the equipment;</p> <p>b) for components in series with the mains input to the equipment such as the supply cord, appliance coupler, r.f.i. filter and switch, short-circuit and earth fault protection may be provided by protective devices in the building installation;</p> <p>c) it is permitted for <b>pluggable equipment type B</b> or <b>permanently connected equipment</b>, to rely on dedicated overcurrent and short-circuit protection in the building installation, provided that the means of protection, e.g. fuses or circuit breakers, is fully specified in the installation instructions.</p> <p>If reliance is placed on protection in the building installation, the installation instructions shall so state, except that for <b>pluggable equipment type A</b> the building installation shall be regarded as providing protection in accordance with the rating of the wall socket outlet.</p>		N/A
<b>6</b>	<b>Modification to 5.4.2.3.2.4</b>		N/A
5.4.2.3.2.4	<p><b>Add the following to the end of this subclause:</b></p> <p>The requirement for interconnection with <b>external circuit</b> is in addition given in EN 50491-3:2009.</p>		N/A
<b>7</b>	<b>Modification to 10.2.1</b>		N/A
10.2.1	<p>Add the following to <sup>c)</sup> and <sup>d)</sup> in table 39:</p> <p>For additional requirements, see 10.5.1.</p>		N/A
<b>8</b>	<b>Modification to 10.5.1</b>		N/A



National Differences			
Clause	Requirement + Test	Result - Remark	Verdict
10.5.1	<p><b>Add the following after the first paragraph:</b></p> <p>For RS 1 compliance is checked by measurement under the following conditions:</p> <p>In addition to the normal operating conditions, all controls adjustable from the outside by hand, by any object such as a tool or a coin, and those internal adjustments or pre-sets which are not locked in a reliable manner, are adjusted so as to give maximum radiation whilst maintaining an intelligible picture for 1 h, at the end of which the measurement is made.</p> <p>NOTE Z1 Soldered joints and paint lockings are examples of adequate locking.</p> <p>The dose-rate is determined by means of a radiation monitor with an effective area of 10 cm<sup>2</sup>, at any point 10 cm from the outer surface of the apparatus.</p> <p>Moreover, the measurement shall be made under fault conditions causing an increase of the high voltage, provided an intelligible picture is maintained for 1 h, at the end of which the measurement is made.</p> <p>For RS1, the dose-rate shall not exceed 1 μSv/h taking account of the background level.</p> <p>NOTE Z2 These values appear in Directive 96/29/Euratom of 13 May 1996.</p>		N/A
<b>9</b>	<b>Modification to G.7.1</b>		N/A
G.7.1	<p><b>Add the following note:</b></p> <p>NOTE Z1 The harmonized code designations corresponding to the IEC cord types are given in Annex ZD.</p>		N/A
<b>10</b>	<b>Modification to Bibliography</b>		N/A

National Differences			
Clause	Requirement + Test	Result - Remark	Verdict
	<p><b>Add the following notes for the standards indicated:</b></p> <p>IEC 60130-9 NOTE Harmonized as EN 60130-9.                      IEC 60269-2 NOTE Harmonized as HD 60269-2.                      IEC 60309-1 NOTE Harmonized as EN 60309-1.                      IEC 60364 NOTE some parts harmonized in HD 384/HD 60364 series.                      IEC 60601-2-4 NOTE Harmonized as EN 60601-2-4.                      IEC 60664-5 NOTE Harmonized as EN 60664-5.                      IEC 61032:1997 NOTE Harmonized as EN 61032:1998 (not modified).                      IEC 61508-1 NOTE Harmonized as EN 61508-1.                      IEC 61558-2-1 NOTE Harmonized as EN 61558-2-1.                      IEC 61558-2-4 NOTE Harmonized as EN 61558-2-4.                      IEC 61558-2-6 NOTE Harmonized as EN 61558-2-6.                      IEC 61643-1 NOTE Harmonized as EN 61643-1.                      IEC 61643-21 NOTE Harmonized as EN 61643-21.                      IEC 61643-311 NOTE Harmonized as EN 61643-311.                      IEC 61643-321 NOTE Harmonized as EN 61643-321.                      IEC 61643-331 NOTE Harmonized as EN 61643-331.</p>		N/A
<b>11</b>	<b>ADDITION OF ANNEXES</b>		N/A
<b>ZB</b>	<b>ANNEX ZB, SPECIAL NATIONAL CONDITIONS (EN)</b>		N/A

National Differences			
Clause	Requirement + Test	Result - Remark	Verdict
4.1.15	<p><b>Denmark, Finland, Norway and Sweden</b></p> <p>To the end of the subclause the following is added:</p> <p><b>Class I pluggable equipment type A</b> intended for connection to other equipment or a network shall, if safety relies on connection to reliable earthing or if surge suppressors are connected between the network terminals and <b>accessible</b> parts, have a marking stating that the equipment shall be connected to an earthed <b>mains</b> socket-outlet.</p> <p>The marking text in the applicable countries shall be as follows:</p> <p>In <b>Denmark</b>: "Apparatets stikprop skal tilsluttes en stikkontakt med jord som giver forbindelse til stikproppens jord."</p> <p>In <b>Finland</b>: "Laitte on liitettävä suojakoskettimilla varustettuun pistorasiaan"</p> <p>In <b>Norway</b>: "Apparatet må tilkoples jordet stikkontakt"</p> <p>In <b>Sweden</b>: "Apparaten skall anslutas till jordat uttag"</p>		N/A

National Differences			
Clause	Requirement + Test	Result - Remark	Verdict
4.7.3	<p><b>United Kingdom</b></p> <p>To the end of the subclause the following is added:</p> <p>The torque test is performed using a socket-outlet complying with BS 1363, and the plug part shall be assessed to the relevant clauses of BS 1363. Also see Annex G.4.2 of this annex</p>		N/A
5.2.2.2	<p><b>Denmark</b></p> <p>After the 2nd paragraph add the following:</p> <p>A warning (marking safeguard) for high touch current is required if the touch current exceeds the limits of 3,5 mA a.c. or 10 mA d.c.</p>		N/A
5.4.11.1 and Annex G	<p><b>Finland and Sweden</b></p> <p>To the end of the subclause the following is added:</p> <p>For separation of the telecommunication network from earth the following is applicable:</p> <p>If this insulation is solid, including insulation forming part of a component, it shall at least consist of either</p> <ul style="list-style-type: none"> <li>• two layers of thin sheet material, each of which shall pass the electric strength test below, or</li> <li>• one layer having a distance through insulation of at least 0,4 mm, which shall pass the electric strength test below.</li> </ul> <p>If this insulation forms part of a semiconductor component (e.g. an optocoupler), there is no distance through insulation requirement for the insulation consisting of an insulating compound completely filling the casing, so that clearances and creepage distances do not exist, if the component passes the electric strength test in accordance with the compliance clause below and in addition</p>		N/A

TRF No. IEC62368\_1E



National Differences			
Clause	Requirement + Test	Result - Remark	Verdict
	<ul style="list-style-type: none"> <li>passes the tests and inspection criteria of 5.4.8 with an electric strength test of 1,5 kV multiplied by 1,6 (the electric strength test of 5.4.9 shall be performed using 1,5 kV),</li> </ul> <p>and</p> <ul style="list-style-type: none"> <li>is subject to routine testing for electric strength during manufacturing, using a test voltage of 1,5 kV.</li> </ul> <p>It is permitted to bridge this insulation with a capacitor complying with EN 60384-14:2005, subclass Y2.</p> <p>A capacitor classified Y3 according to EN 60384-14:2005, may bridge this insulation under the following conditions:</p> <ul style="list-style-type: none"> <li>the insulation requirements are satisfied by having a capacitor classified Y3 as defined by EN 60384-14, which in addition to the Y3 testing, is tested with an impulse test of 2,5 kV defined in 5.4.11;</li> <li>the additional testing shall be performed on all the test specimens as described in EN 60384-14;</li> </ul> <p>the impulse test of 2,5 kV is to be performed before the endurance test in EN 60384-14, in the sequence of tests as described in EN 60384-14.</p>		
5.5.2.1	<p><b>Norway</b></p> <p>After the 3rd paragraph the following is added:</p> <p>Due to the IT power system used, capacitors are required to be rated for the applicable line-to-line voltage (230 V).</p>		N/A

National Differences			
Clause	Requirement + Test	Result - Remark	Verdict
5.5.6	<p><b>Finland, Norway and Sweden</b></p> <p>To the end of the subclause the following is added:</p> <p>Resistors used as <b>basic safeguard</b> or bridging <b>basic insulation in class I pluggable equipment type A</b> shall comply with G.10.1 and the test of G.10.2.</p>		N/A
5.6.1	<p><b>Denmark</b></p> <p><b>Add</b> to the end of the subclause</p> <p>Due to many existing installations where the socket-outlets can be protected with fuses with higher rating than the rating of the socket-outlets the protection for pluggable equipment type A shall be an integral part of the equipment.</p> <p><i>Justification:</i></p> <p>In Denmark an existing 13 A socket outlet can be protected by a 20 A fuse.</p>		N/A
5.6.4.2.1	<p><b>Ireland and United Kingdom</b></p> <p>After the indent for <b>pluggable equipment type A</b>, the following is added:</p> <p>– the <b>protective current rating</b> is taken to be 13 A, this being the largest rating of fuse used in the <b>mains</b> plug.</p>		N/A
5.6.4.2.1	<p><b>France</b></p> <p>After the indent for <b>pluggable equipment type A</b>, the following is added:</p> <p>– in certain cases, the <b>protective current rating</b> of the circuit supplied from the mains is taken as 20 A instead of 16 A.</p>		N/A
5.6.5.1	<p>To the second paragraph the following is added:</p> <p>The range of conductor sizes of flexible cords to be accepted by terminals for equipment with a rated current over 10 A and up to and including 13 A is: 1,25 mm<sup>2</sup> to 1,5 mm<sup>2</sup> in cross-sectional area.</p>		N/A

TRF No. IEC62368\_1E

National Differences			
Clause	Requirement + Test	Result - Remark	Verdict
5.6.8	<p><b>Norway</b></p> <p>To the end of the subclause the following is added: Equipment connected with an earthed mains plug is classified as <b>class I equipment</b>. See the Norway marking requirement in 4.1.15. The symbol IEC 60417-6092, as specified in F.3.6.2, is accepted.</p>		N/A
5.7.6	<p><b>Denmark</b></p> <p>To the end of the subclause the following is added:</p> <p>The installation instruction shall be affixed to the equipment if the <b>protective conductor current</b> exceeds the limits of 3,5 mA a.c. or 10 mA d.c.</p>		N/A
5.7.6.2	<p><b>Denmark</b></p> <p>To the end of the subclause the following is added: The warning (marking safeguard) for high touch current is required if the touch current or the protective current exceed the limits of 3,5 mA .</p>		N/A
5.7.7.1	<p><b>Norway and Sweden</b></p> <p>To the end of the subclause the following is added: The screen of the television distribution system is normally not earthed at the entrance of the building and there is normally no equipotential bonding system within the building. Therefore the protective earthing of the building installation needs to be isolated from the screen of a cable distribution system.</p> <p>It is however accepted to provide the insulation external to the equipment by an adapter or an interconnection cable with galvanic isolator, which may be provided by a retailer, for example.</p> <p>The user manual shall then have the following or similar information in Norwegian and Swedish language respectively, depending on in what country the equipment is intended to be used in:</p>		N/A

TRF No. IEC62368\_1E

National Differences			
Clause	Requirement + Test	Result - Remark	Verdict
	<p>“Apparatus connected to the protective earthing of the building installation through the mains connection or through other apparatus with a connection to protective earthing – and to a television distribution system using coaxial cable, may in some circumstances create a fire hazard. Connection to a television distribution system therefore has to be provided through a device providing electrical isolation below a certain frequency range (galvanic isolator, see EN 60728-11)”</p> <p>NOTE In Norway, due to regulation for CATV-installations, and in Sweden, a galvanic isolator shall provide electrical insulation below 5 MHz. The insulation shall withstand a dielectric strength of 1,5 kV r.m.s., 50 Hz or 60 Hz, for 1 min.</p> <p>Translation to Norwegian (the Swedish text will also be accepted in Norway):</p> <p>“Apparater som er koplet til beskyttelsesjord via nettplugg og/eller via annet jordtilkoplede utstyr – og er tilkoplede et koaksialbasert kabel-TV nett, kan forårsake brannfare.</p> <p>For å unngå dette skal det ved tilkopling av apparater til kabel-TV nett installeres en galvanisk isolator mellom apparatet og kabel-TV nettet.”</p> <p>Translation to Swedish:</p> <p>”Apparater som är kopplad till skyddsjord via jordat vägguttag och/eller via annan utrustning och samtidigt är kopplad till kabel-TV nät kan i vissa fall medföra risk för brand. För att undvika detta skall vid anslutning av apparaten till kabel-TV nät galvanisk isolator finnas mellan apparaten och kabel-TV nätet.”.</p>		



National Differences			
Clause	Requirement + Test	Result - Remark	Verdict
8.5.4.2.3	<p><b>United Kingdom</b></p> <p>Add the following after the 2<sup>nd</sup> dash bullet in 3<sup>rd</sup> paragraph:</p> <p>An emergency stop system complying with the requirements of IEC 60204-1 and ISO 13850 is required where there is a risk of personal injury.</p>		N/A
B.3.1 and B.4	<p><b>Ireland and United Kingdom</b></p> <p>The following is applicable:</p> <p>To protect against excessive currents and short-circuits in the primary circuit of <b>direct plug-in equipment</b>, tests according to Annexes B.3.1 and B.4 shall be conducted using an external miniature circuit breaker complying with EN 60898-1, Type B, rated 32A. If the equipment does not pass these tests, suitable protective devices shall be included as an integral part of the <b>direct plug-in equipment</b>, until the requirements of Annexes B.3.1 and B.4 are met</p>		N/A
G.4.2	<p><b>Denmark</b></p> <p>To the end of the subclause the following is added:</p> <p>Supply cords of single phase appliances having a rated current not exceeding 13 A shall be provided with a plug according to DS 60884-2-D1:2011.</p> <p>CLASS I EQUIPMENT provided with socket-outlets with earth contacts or which are intended to be used in locations where protection against indirect contact is required according to the wiring rules shall be provided with a plug in accordance with standard sheet DK 2-1a or DK 2-5a.</p> <p>If a single-phase equipment having a RATED CURRENT exceeding 13 A or if a polyphase equipment is provided with a supply cord with a plug, this plug shall be in accordance with the</p>		N/A

TRF No. IEC62368\_1E

National Differences			
Clause	Requirement + Test	Result - Remark	Verdict
	<p>standard sheets DK 6-1a in DS 60884-2-D1 or EN 60309-2.</p> <p>Mains socket outlets intended for providing power to Class II apparatus with a rated current of 2,5 A shall be in accordance DS 60884-2-D1:2011 standard sheet DKA 1-4a.</p> <p>Other current rating socket outlets shall be in compliance with Standard Sheet DKA 1-3a or DKA 1-1c.</p> <p>Mains socket-outlets with earth shall be in compliance with DS 60884-2-D1:2011 Standard Sheet DK 1-3a, DK 1-1c, DK1-1d, DK 1-5a or DK 1-7a</p> <p><i>Justification:</i> Heavy Current Regulations, Section 6c</p>		
<b>G.4.2</b>	<p><b>United Kingdom</b></p> <p>To the end of the subclause the following is added:</p> <p>The plug part of direct plug-in equipment shall be assessed to BS 1363: Part 1, 12.1, 12.2, 12.3, 12.9, 12.11, 12.12, 12.13, 12.16, and 12.17, except that the test of 12.17 is performed at not less than 125 °C. Where the metal earth pin is replaced by an Insulated Shutter Opening Device (ISOD), the requirements of clauses 22.2 and 23 also apply.</p>		N/A

<b>National Differences</b>			
<b>Clause</b>	<b>Requirement + Test</b>	<b>Result - Remark</b>	<b>Verdict</b>
<b>G.7.1</b>	<p><b>United Kingdom</b></p> <p>To the first paragraph the following is added:</p> <p>Equipment which is fitted with a flexible cable or cord and is designed to be connected to a mains socket conforming to BS 1363 by means of that flexible cable or cord shall be fitted with a 'standard plug' in accordance with the Plugs and Sockets etc. (Safety) Regulations 1994, Statutory Instrument 1994 No. 1768, unless exempted by those regulations.</p> <p>NOTE "Standard plug" is defined in SI 1768:1994 and essentially means an approved plug conforming to BS 1363 or an approved conversion plug.</p>		N/A
<b>G.7.1</b>	<p><b>Ireland</b></p> <p>To the first paragraph the following is added:</p> <p>Apparatus which is fitted with a flexible cable or cord shall be provided with a plug in accordance with Statutory Instrument 525: 1997, "13 A Plugs and Conversion Adapters for Domestic Use Regulations: 1997. S.I. 525 provides for the recognition of a standard of another Member State which is equivalent to the relevant Irish Standard</p>		N/A
<b>G.7.2</b>	<p><b>Ireland and United Kingdom</b></p> <p>To the first paragraph the following is added:</p> <p>A power supply cord with a conductor of 1,25 mm<sup>2</sup> is allowed for equipment which is rated over 10 A and up to and including 13 A.</p>		N/A
<b>ZC</b>	<b>ANNEX ZC, NATIONAL DEVIATIONS (EN)</b>		P

National Differences			
Clause	Requirement + Test	Result - Remark	Verdict
10.5.2	<p><b>Germany</b></p> <p>The following requirement applies:</p> <p>For the operation of any cathode ray tube intended for the display of visual images operating at an acceleration voltage exceeding 40 kV, authorization is required, or application of type approval (Bauartzulassung) and marking.</p> <p><i>Justification:</i></p> <p>German ministerial decree against ionizing radiation (Röntgenverordnung), in force since 2002-07-01, implementing the European Directive 96/29/EURATOM.</p> <p><b>NOTE</b> Contact address:                      Physikalisch-Technische Bundesanstalt,                      Bundesallee 100, D-38116 Braunschweig,                      Tel.: Int+49-531-592-6320, Internet:  <a href="http://www.ptb.de">http://www.ptb.de</a></p>		P



National Differences																																																							
Clause	Requirement + Test	Result - Remark	Verdict																																																				
ZD	<b>IEC and CENELEC CODE DESIGNATIONS FOR FLEXIBLE CORDS (EN)</b>		P																																																				
	<table border="1"> <thead> <tr> <th rowspan="2">Type of flexible cord</th> <th colspan="2">Code designations</th> </tr> <tr> <th>IEC</th> <th>CENELEC</th> </tr> </thead> <tbody> <tr> <td colspan="3"><b>PVC insulated cords</b></td> </tr> <tr> <td>Flat twin tinsel cord</td> <td>60227 IEC 41</td> <td>H03VH-Y</td> </tr> <tr> <td>Light polyvinyl chloride sheathed flexible cord</td> <td>60227 IEC 52</td> <td>H03VV-F H03VVH2-F</td> </tr> <tr> <td>Ordinary polyvinyl chloride sheathed flexible cord</td> <td>60227 IEC 53</td> <td>H05VV-F H05VVH2-F</td> </tr> <tr> <td colspan="3"><b>Rubber insulated cords</b></td> </tr> <tr> <td>Braided cord</td> <td>60245 IEC 51</td> <td>H03RT-F</td> </tr> <tr> <td>Ordinary tough rubber sheathed flexible cord</td> <td>60245 IEC 53</td> <td>H05RR-F</td> </tr> <tr> <td>Ordinary polychloroprene sheathed flexible cord</td> <td>60245 IEC 57</td> <td>H05RN-F</td> </tr> <tr> <td>Heavy polychloroprene sheathed flexible cord</td> <td>60245 IEC 66</td> <td>H07RN-F</td> </tr> <tr> <td colspan="3"><b>Cords having high flexibility</b></td> </tr> <tr> <td>Rubber insulated and sheathed cord</td> <td>60245 IEC 86</td> <td>H03RR-H</td> </tr> <tr> <td>Rubber insulated, crosslinked PVC sheathed cord</td> <td>60245 IEC 87</td> <td>H03RV4-H</td> </tr> <tr> <td>Crosslinked PVC insulated and sheathed cord</td> <td>60245 IEC 88</td> <td>H03V4V4-H</td> </tr> <tr> <td colspan="3"><b>Cords insulated and sheathed with halogen-free thermoplastic compounds</b></td> </tr> <tr> <td>Light halogen-free thermoplastic insulated and sheathed flexible cords</td> <td></td> <td>H03Z1Z1-F H03Z1Z1H2-F</td> </tr> <tr> <td>Ordinary halogen-free thermoplastic insulated and sheathed flexible cords</td> <td></td> <td>H05Z1Z1-F H05Z1Z1H2-F</td> </tr> </tbody> </table>	Type of flexible cord	Code designations		IEC	CENELEC	<b>PVC insulated cords</b>			Flat twin tinsel cord	60227 IEC 41	H03VH-Y	Light polyvinyl chloride sheathed flexible cord	60227 IEC 52	H03VV-F H03VVH2-F	Ordinary polyvinyl chloride sheathed flexible cord	60227 IEC 53	H05VV-F H05VVH2-F	<b>Rubber insulated cords</b>			Braided cord	60245 IEC 51	H03RT-F	Ordinary tough rubber sheathed flexible cord	60245 IEC 53	H05RR-F	Ordinary polychloroprene sheathed flexible cord	60245 IEC 57	H05RN-F	Heavy polychloroprene sheathed flexible cord	60245 IEC 66	H07RN-F	<b>Cords having high flexibility</b>			Rubber insulated and sheathed cord	60245 IEC 86	H03RR-H	Rubber insulated, crosslinked PVC sheathed cord	60245 IEC 87	H03RV4-H	Crosslinked PVC insulated and sheathed cord	60245 IEC 88	H03V4V4-H	<b>Cords insulated and sheathed with halogen-free thermoplastic compounds</b>			Light halogen-free thermoplastic insulated and sheathed flexible cords		H03Z1Z1-F H03Z1Z1H2-F	Ordinary halogen-free thermoplastic insulated and sheathed flexible cords		H05Z1Z1-F H05Z1Z1H2-F	P
Type of flexible cord	Code designations																																																						
	IEC	CENELEC																																																					
<b>PVC insulated cords</b>																																																							
Flat twin tinsel cord	60227 IEC 41	H03VH-Y																																																					
Light polyvinyl chloride sheathed flexible cord	60227 IEC 52	H03VV-F H03VVH2-F																																																					
Ordinary polyvinyl chloride sheathed flexible cord	60227 IEC 53	H05VV-F H05VVH2-F																																																					
<b>Rubber insulated cords</b>																																																							
Braided cord	60245 IEC 51	H03RT-F																																																					
Ordinary tough rubber sheathed flexible cord	60245 IEC 53	H05RR-F																																																					
Ordinary polychloroprene sheathed flexible cord	60245 IEC 57	H05RN-F																																																					
Heavy polychloroprene sheathed flexible cord	60245 IEC 66	H07RN-F																																																					
<b>Cords having high flexibility</b>																																																							
Rubber insulated and sheathed cord	60245 IEC 86	H03RR-H																																																					
Rubber insulated, crosslinked PVC sheathed cord	60245 IEC 87	H03RV4-H																																																					
Crosslinked PVC insulated and sheathed cord	60245 IEC 88	H03V4V4-H																																																					
<b>Cords insulated and sheathed with halogen-free thermoplastic compounds</b>																																																							
Light halogen-free thermoplastic insulated and sheathed flexible cords		H03Z1Z1-F H03Z1Z1H2-F																																																					
Ordinary halogen-free thermoplastic insulated and sheathed flexible cords		H05Z1Z1-F H05Z1Z1H2-F																																																					

--- End of Attachment 1 ---

Details of: Fig.1- External view

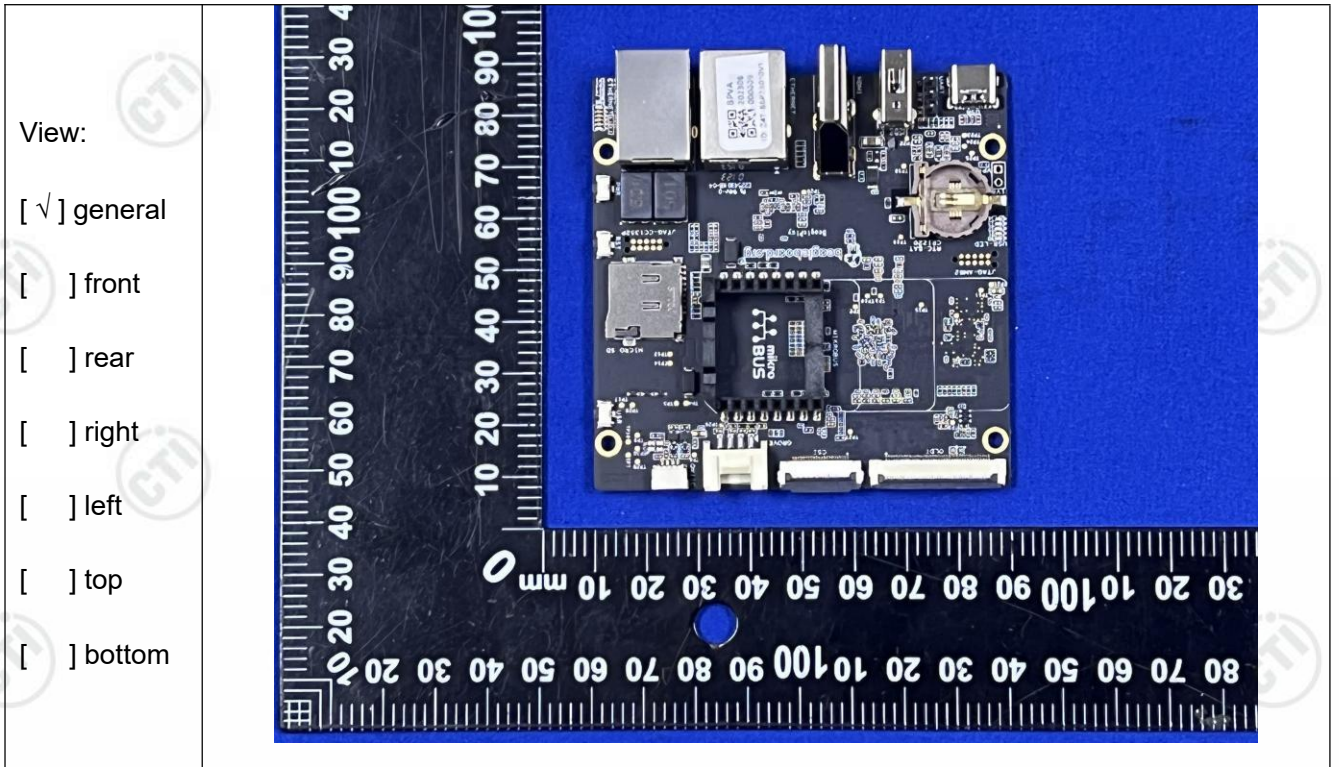

Details of: Fig.2- External view

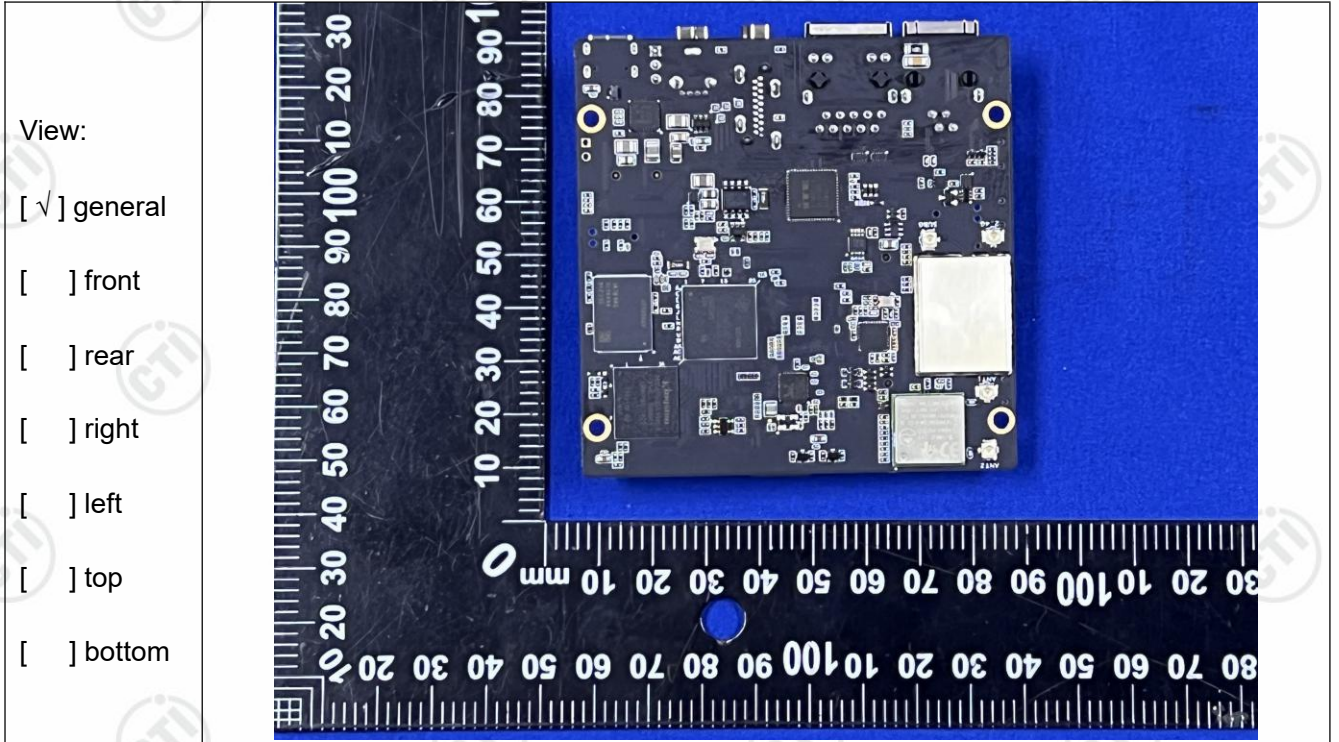

TRF No. IEC62368\_1E



Details of: Fig.3- External view

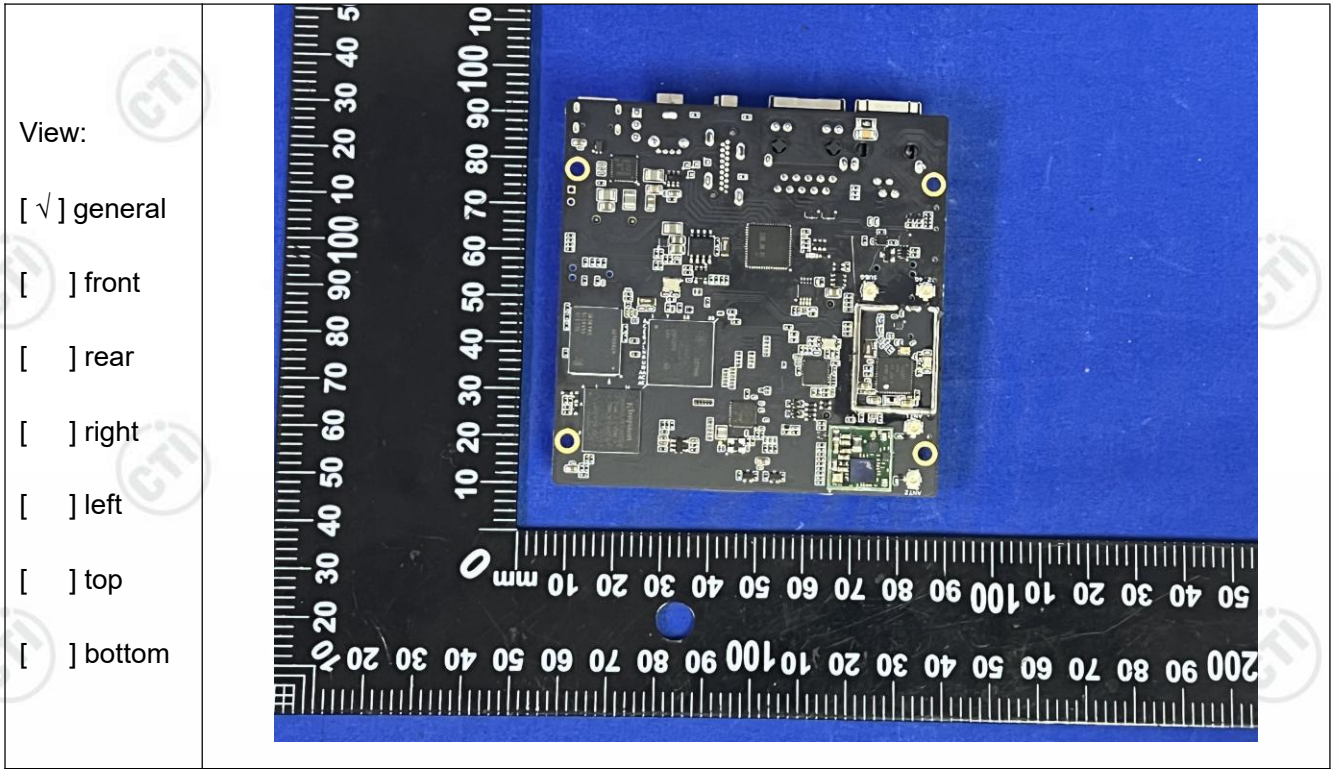

--- End of Attachment 2 ---



# Verification of Compliance

The submitted sample of the following equipment has been tested for CE marking according to the following European Directive: the RED Directive 2014/53/EU.

**Applicant name & address** : Seeed Technology Co., Ltd  
9F, Building G3, TCL International E city, Zhongshanyuan Road, Nanshan, Shenzhen, China.

**Manufacturer name & address** : Seeed Technology Co., Ltd  
9F, Building G3, TCL International E city, Zhongshanyuan Road, Nanshan, Shenzhen, China.

**Product** : BeaglePlay

**Model/Type reference** : BeaglePlay

**Trade mark** : Beagleboard.org

**Order No.** : EED32P800022

Essential Requirements		Applied Specification/Standards	Documentary Evidence
Art 3.1 (a)	Health	EN 50665:2017	Test Report EED32P80002206
Art 3.1 (a)	Safety	EN IEC 62368-1:2020+A11:2020	Test Report EED31P800024
Art 3.1 (b)	EMC	EN 55032:2015+A11:2020, EN IEC 61000-3-2:2019+A1:2021, EN 61000-3-3:2013+A2:2021, EN 55035:2017+A11:2020, ETSI EN 301 489-1 V2.2.3 (2019-11), ETSI EN 301 489-3 V2.1.1 (2019-03), ETSI EN 301 489-17 V3.2.4 (2020-09)	Test Report EED32P80002301, EED32P80002302
Art 3.2	Radio	ETSI EN 300 328 V2.2.2(2019-07), ETSI EN 300 220-1 V3.1.1 (2017-02), ETSI EN 300 220-2 V3.2.1 (2018-06), ETSI EN 301 893 V2.1.1(2017-05), ETSI EN 300 440 V2.2.1 (2018-07)	Test Report EED32P80002201, EED32P80002202, EED32P80002203, EED32P80002204, EED32P80002205

This Verification is for the exclusive use of CTI's Client and is provided pursuant to the agreement between CTI and its Client. The observations and test results referenced from this Verification are relevant only to the sample tested. This Verification by itself does not imply that the material, product, or service is or has ever been under a CTI certification program.

**Note: This Verification is part of the full test report(s) and should be read in conjunction with it.**



Aaron Ma

Aaron Ma

Date: Feb. 22, 2023

Check No.:5404030123

CENTRE TESTING INTERNATIONAL GROUP CO., LTD.

Hongwei Industrial Zone, Bao'an 70 District, Shenzhen, Guangdong, China

www.cti-cert.com E-mail:info@cti-cert.com

Hotline  
400-6788-333



## Appendix: Bluetooth LE



## Contents

Contents .....	2
1. RF Output Power .....	3
2. Power Spectral Density .....	13
3. Occupied Channel Bandwidth .....	17
4. Transmitter unwanted emissions in the out-of-band domain .....	21
5. Receiver Blocking .....	24

## 1. RF Output Power

Condition	Mode	Frequency (MHz)	Antenna	Max Burst RMS Power (dBm)	Burst Number	Max EIRP (dBm)	Limit (dBm)	Verdict
NVNT	BLE 1M	2402	Ant1	1.28	1	2.82	20	Pass
NVNT	BLE 1M	2440	Ant1	1.36	1	2.9	20	Pass
NVNT	BLE 1M	2480	Ant1	1.23	1	2.77	20	Pass
NVLT	BLE 1M	2402	Ant1	1.3	1	2.84	20	Pass
NVLT	BLE 1M	2440	Ant1	1.35	1	2.89	20	Pass
NVLT	BLE 1M	2480	Ant1	1.24	1	2.78	20	Pass
NVHT	BLE 1M	2402	Ant1	1.28	1	2.82	20	Pass
NVHT	BLE 1M	2440	Ant1	1.35	1	2.89	20	Pass
NVHT	BLE 1M	2480	Ant1	1.22	1	2.76	20	Pass
NVNT	BLE 2M	2402	Ant1	1.37	1	2.91	20	Pass
NVNT	BLE 2M	2440	Ant1	1.32	1	2.86	20	Pass
NVNT	BLE 2M	2480	Ant1	1.22	1	2.76	20	Pass
NVLT	BLE 2M	2402	Ant1	1.37	1	2.91	20	Pass
NVLT	BLE 2M	2440	Ant1	1.33	1	2.87	20	Pass
NVLT	BLE 2M	2480	Ant1	1.24	1	2.78	20	Pass
NVHT	BLE 2M	2402	Ant1	1.39	1	<b>2.93</b>	20	Pass
NVHT	BLE 2M	2440	Ant1	1.33	1	2.87	20	Pass
NVHT	BLE 2M	2480	Ant1	1.23	1	2.77	20	Pass

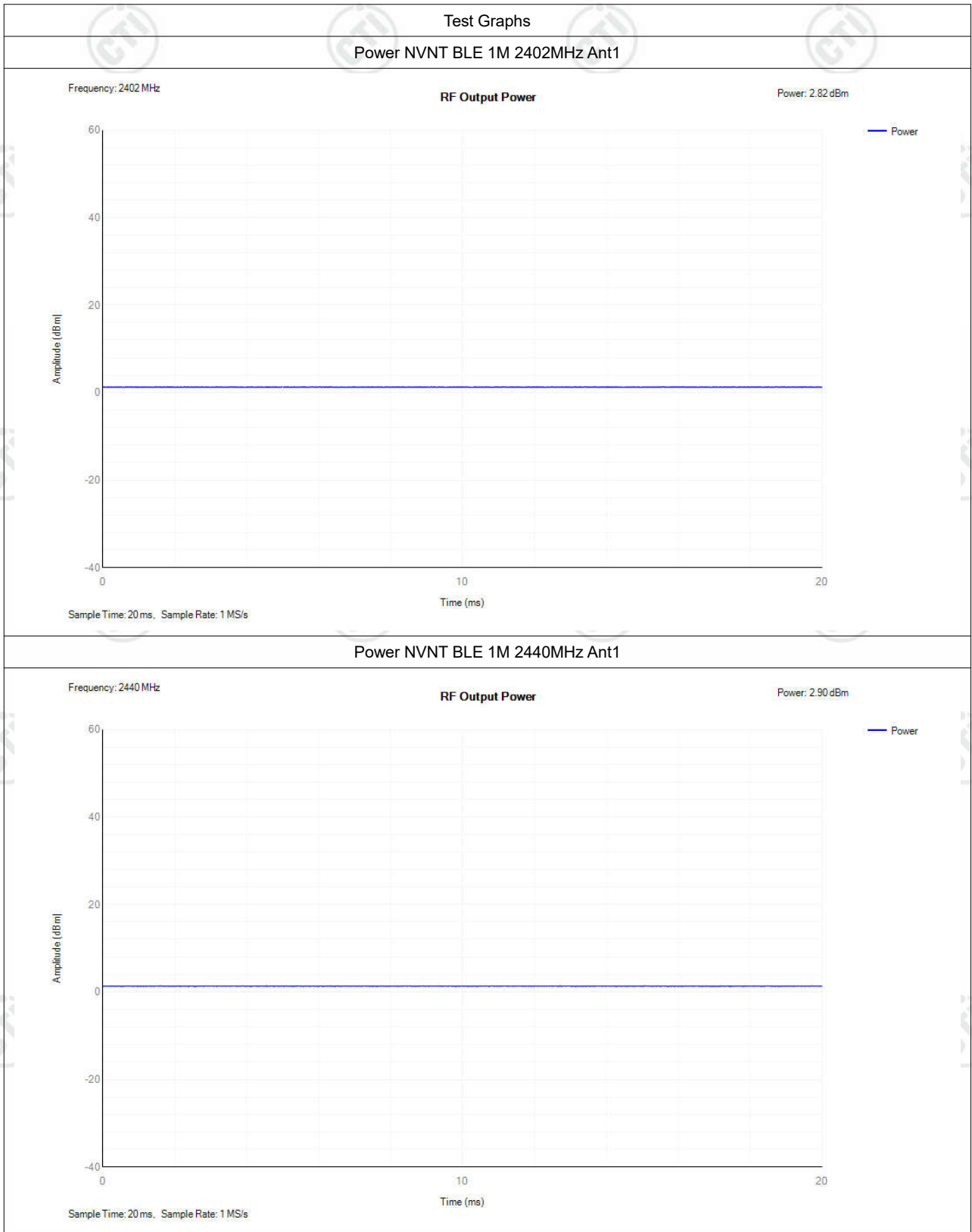



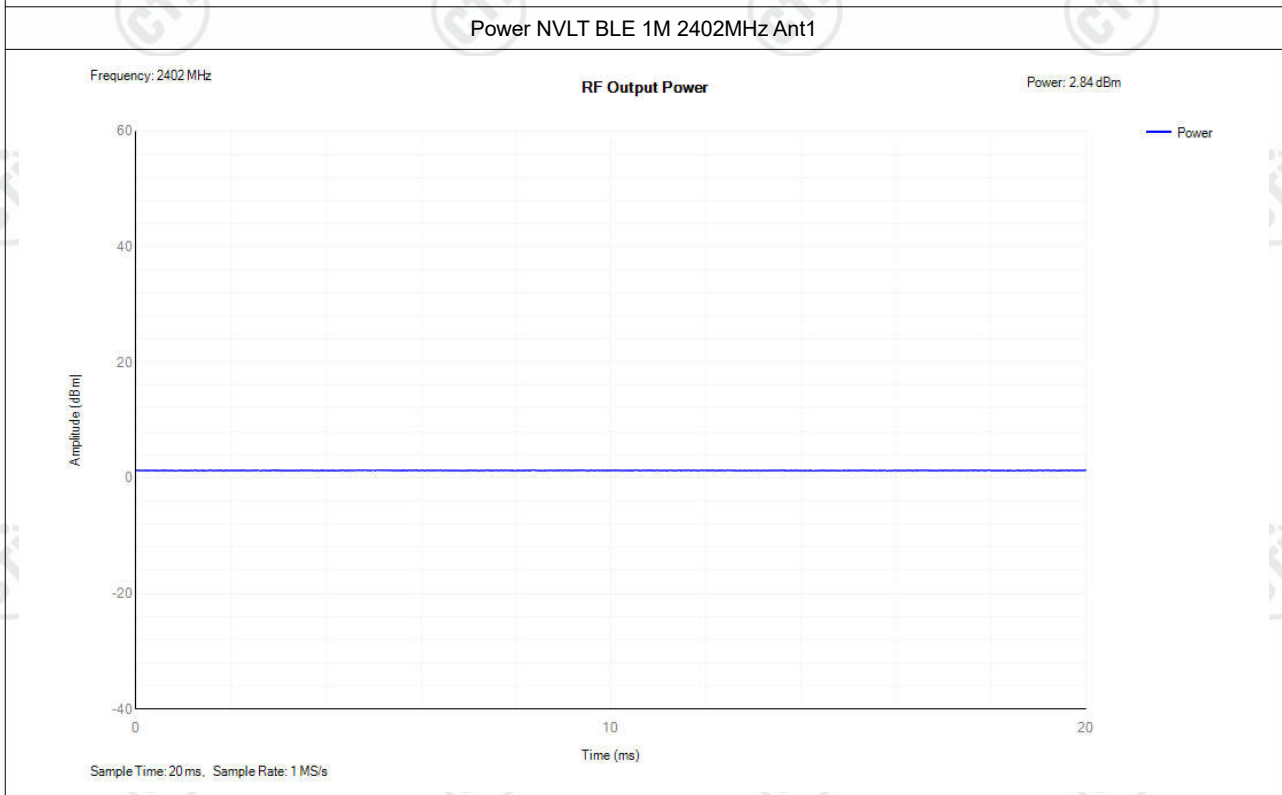
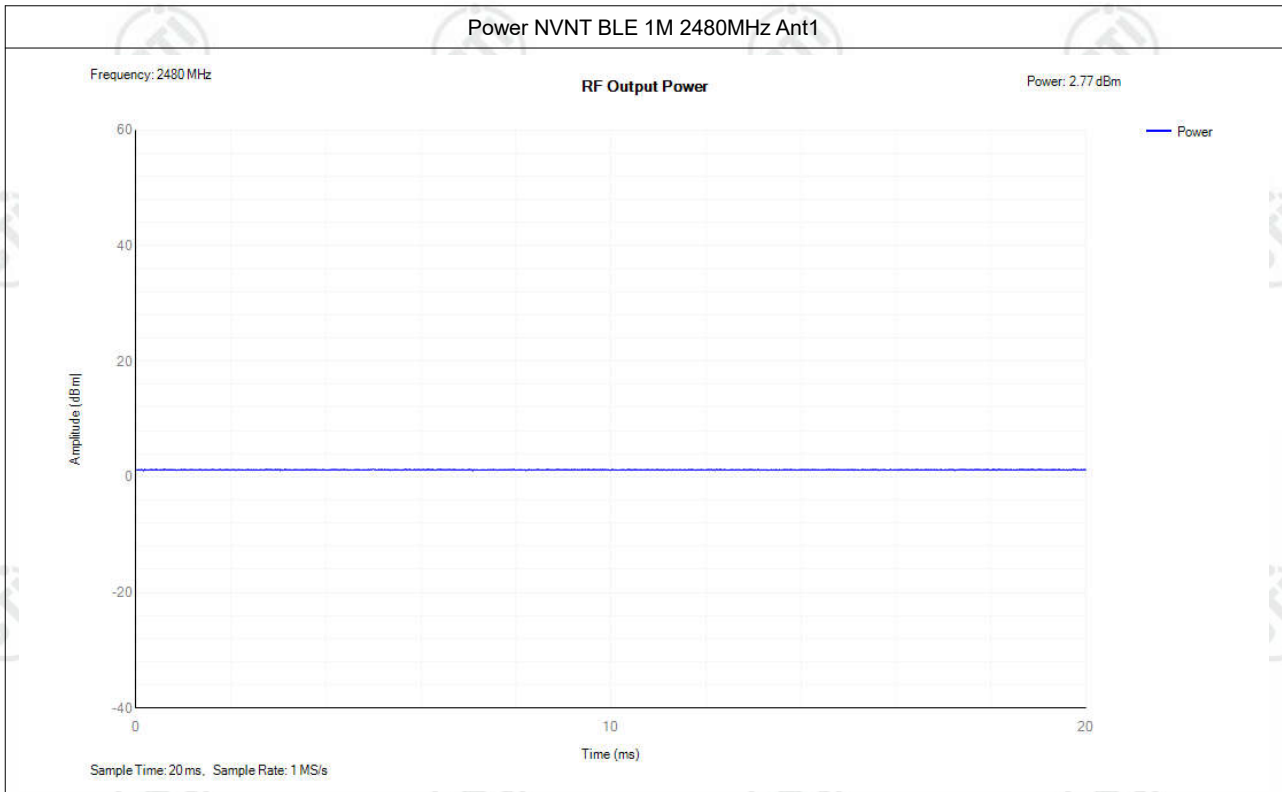

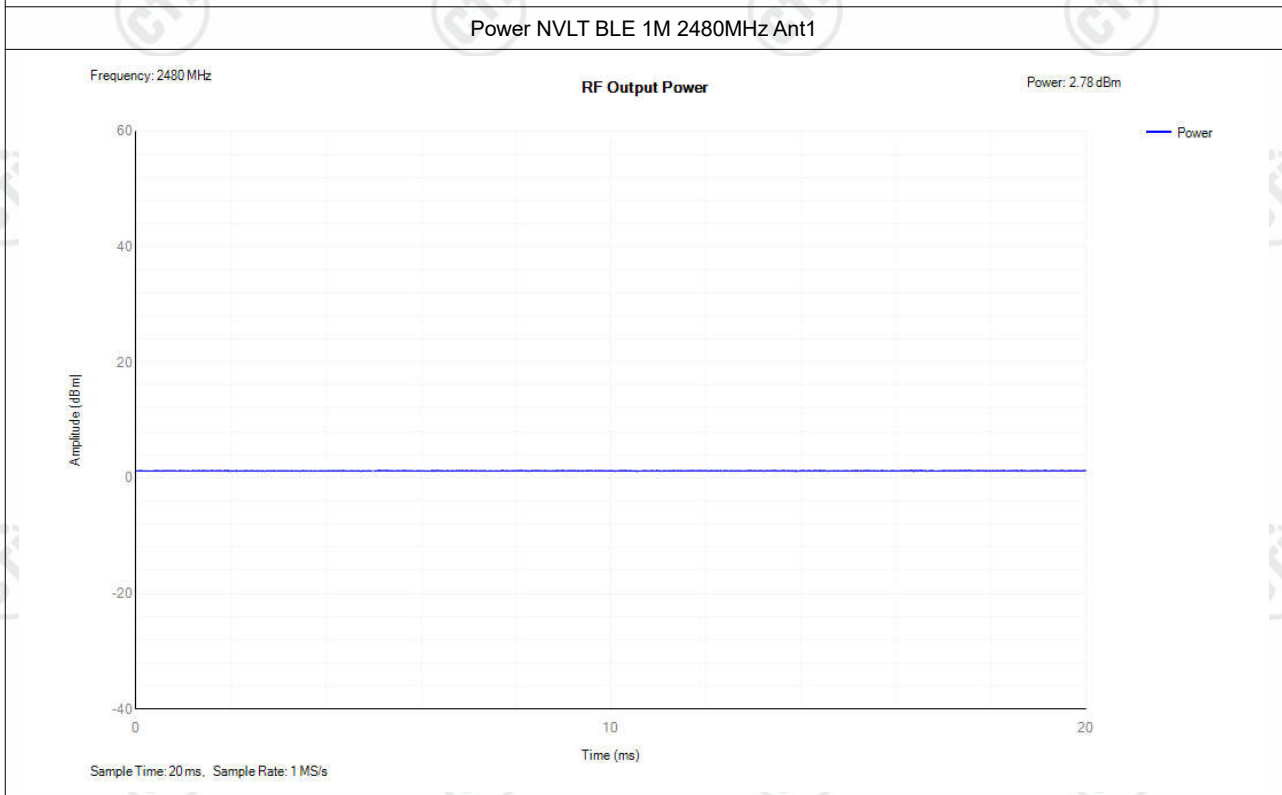
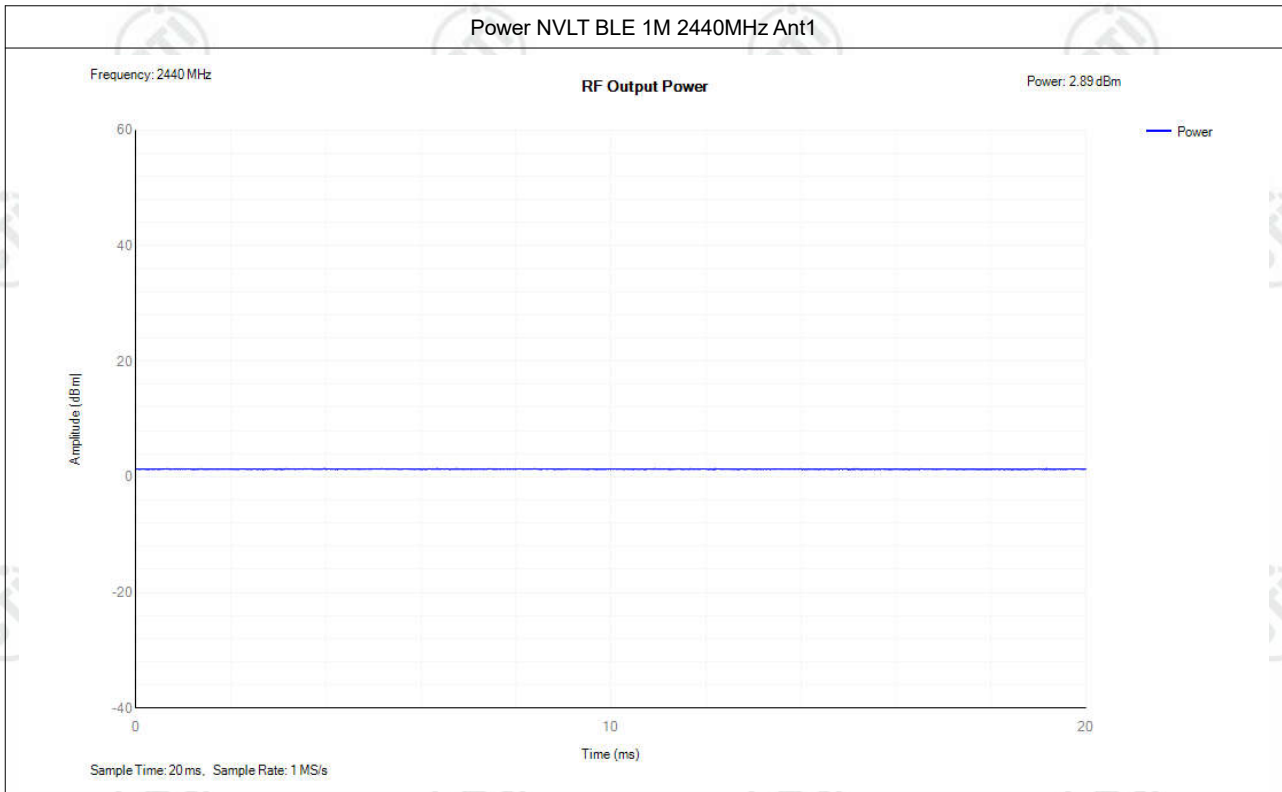

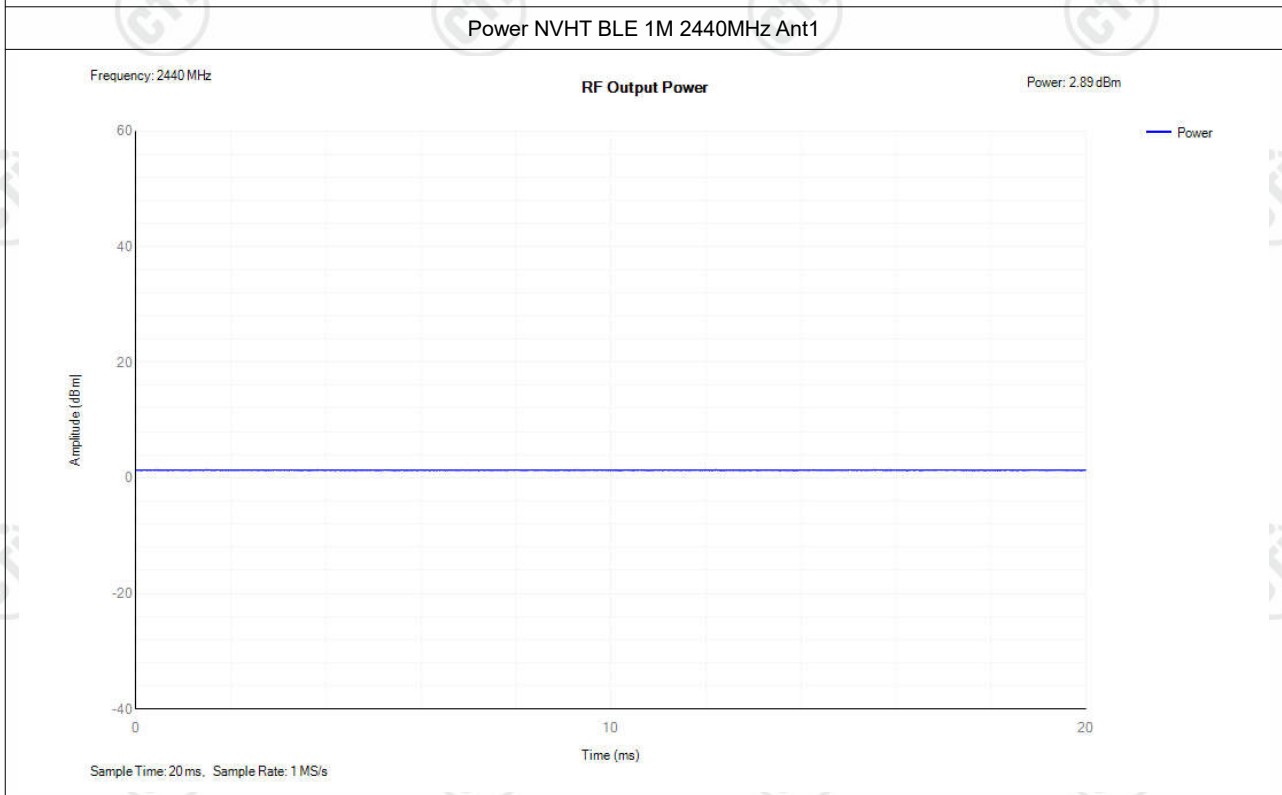
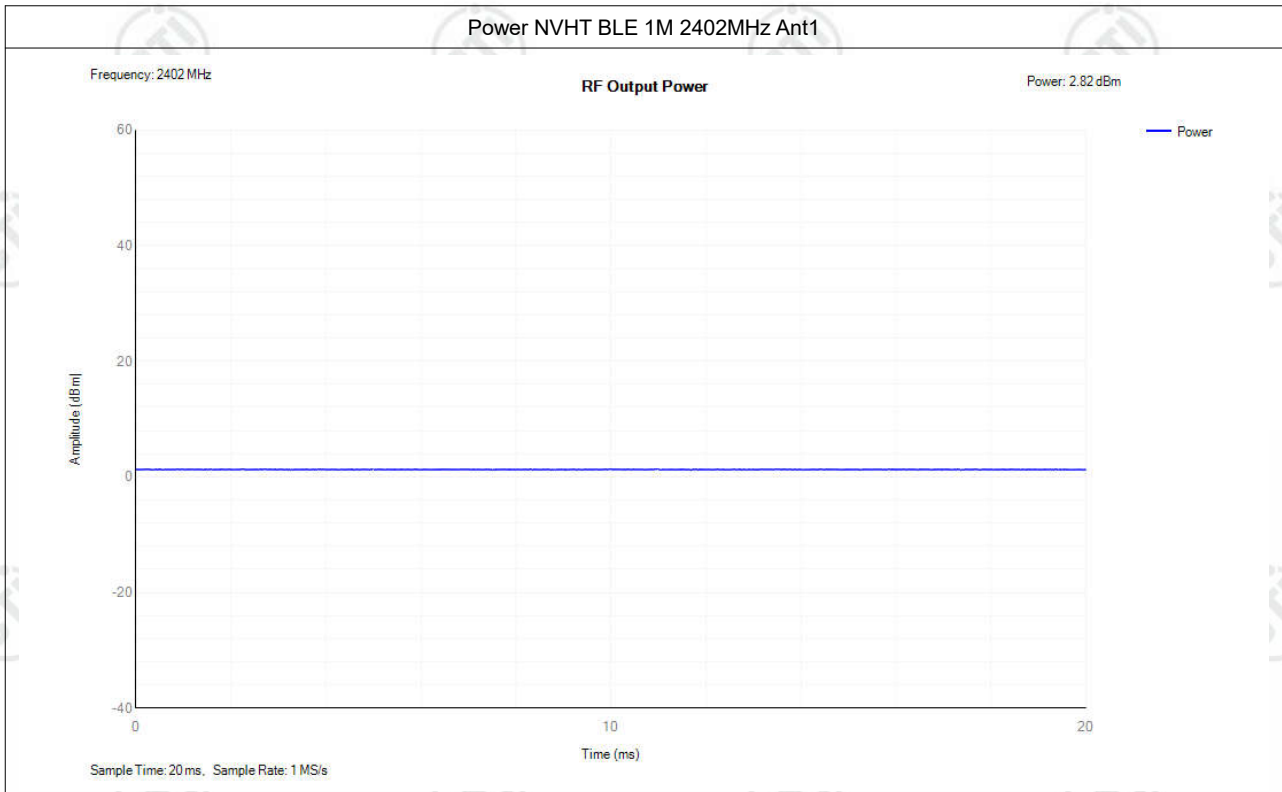

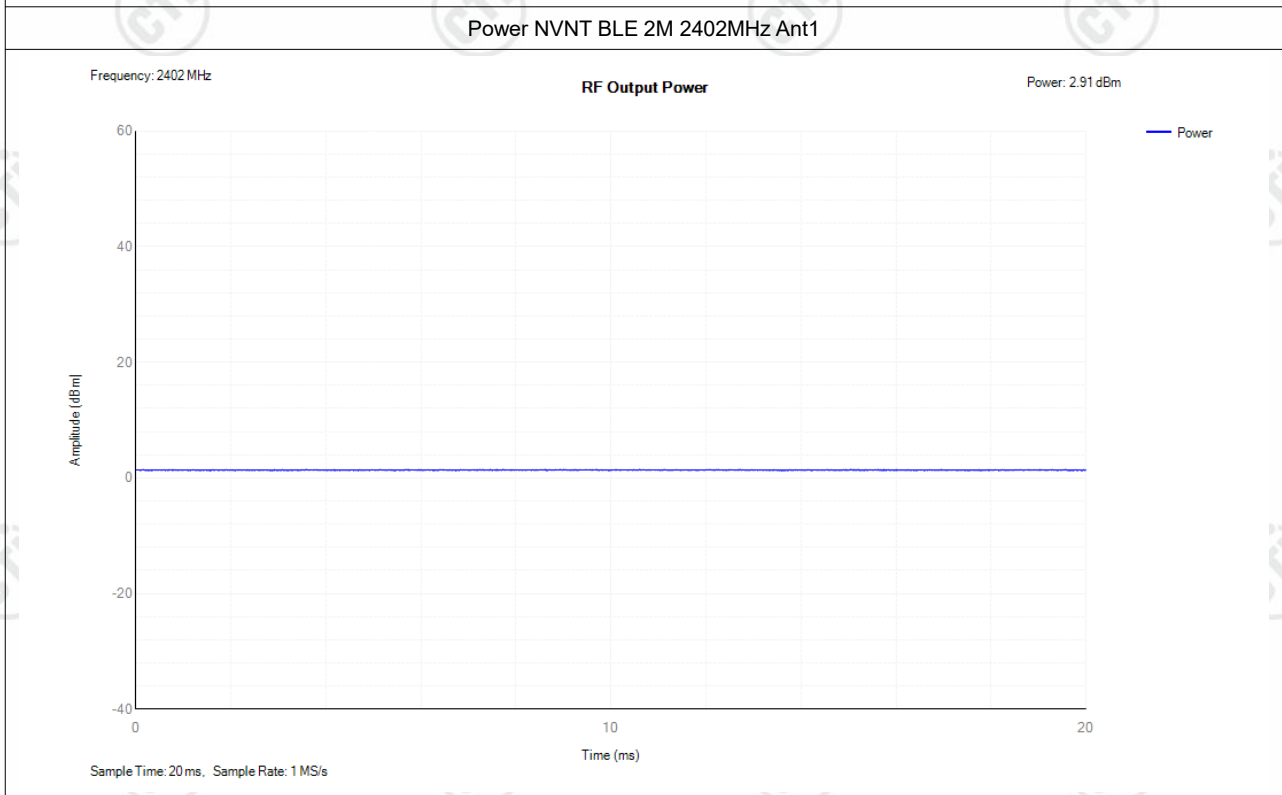
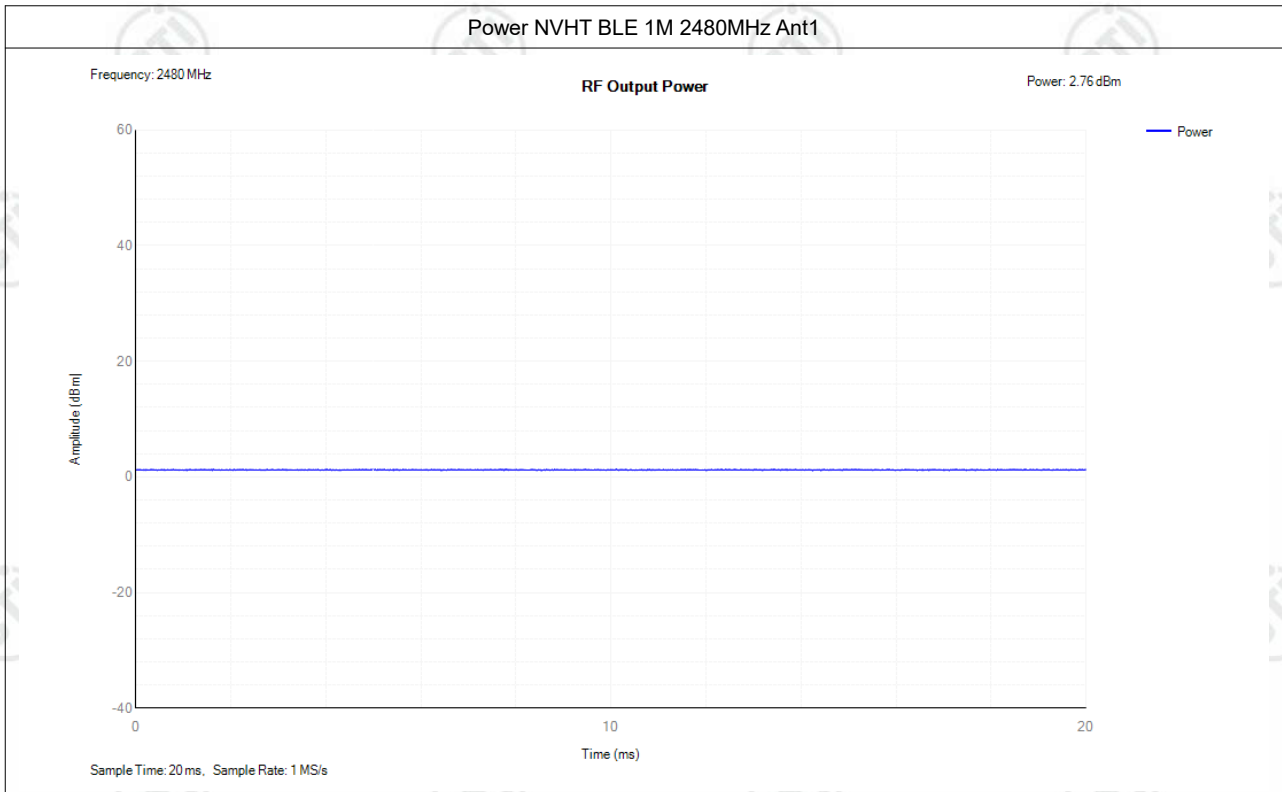



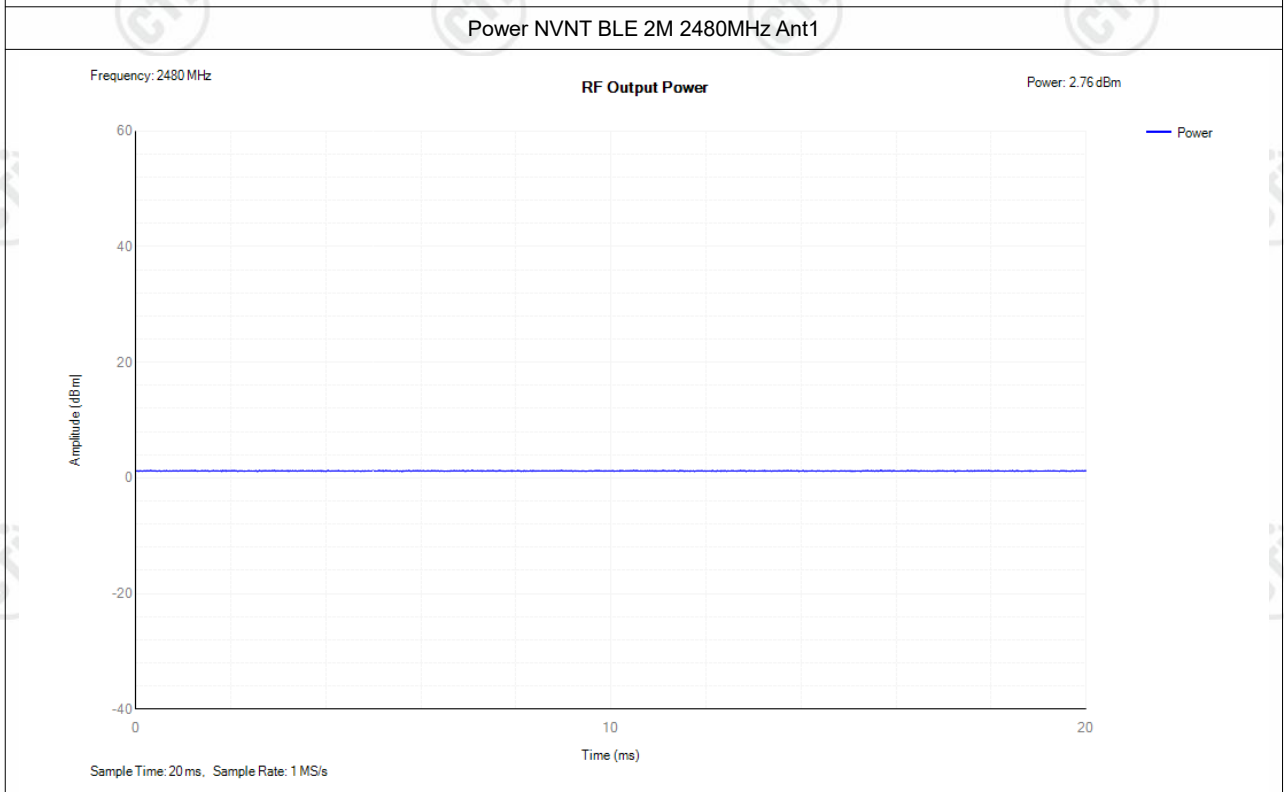
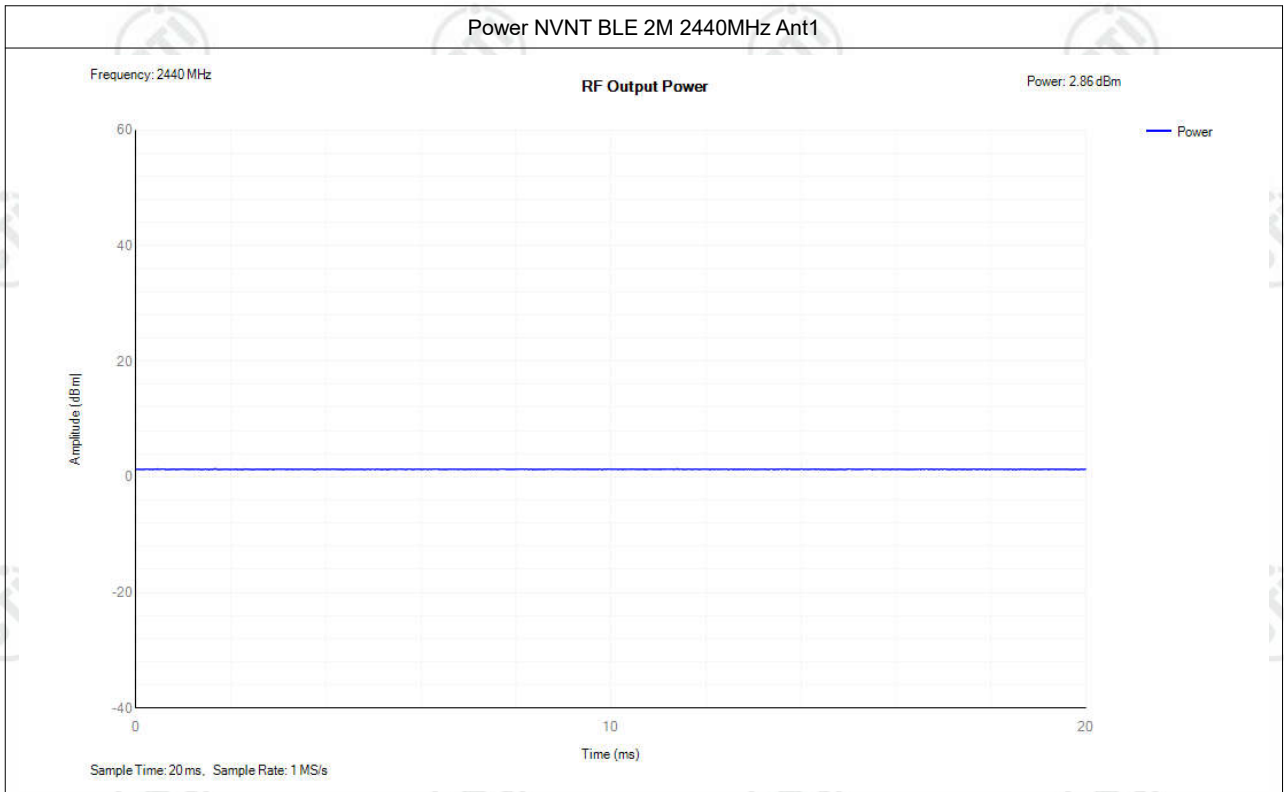

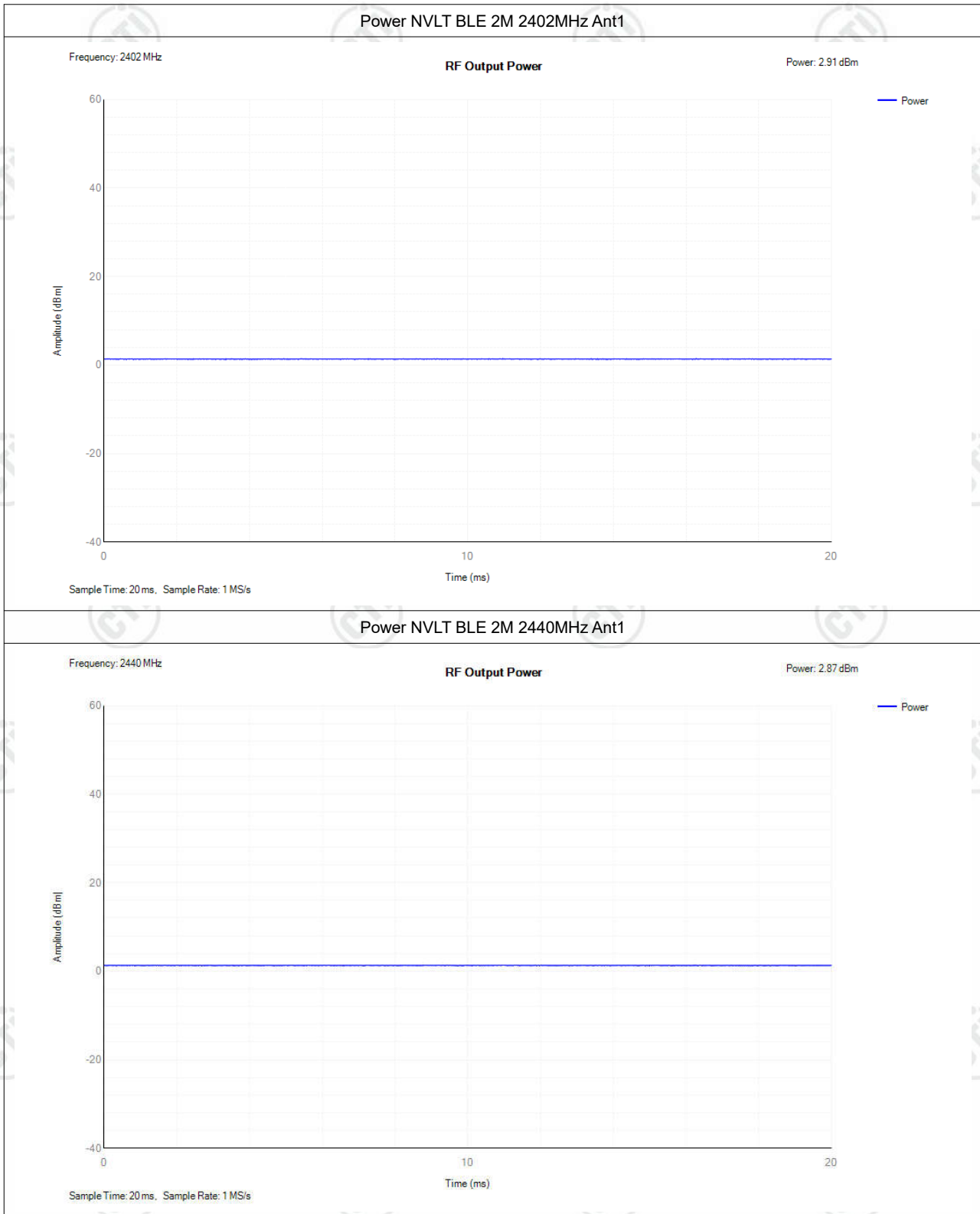

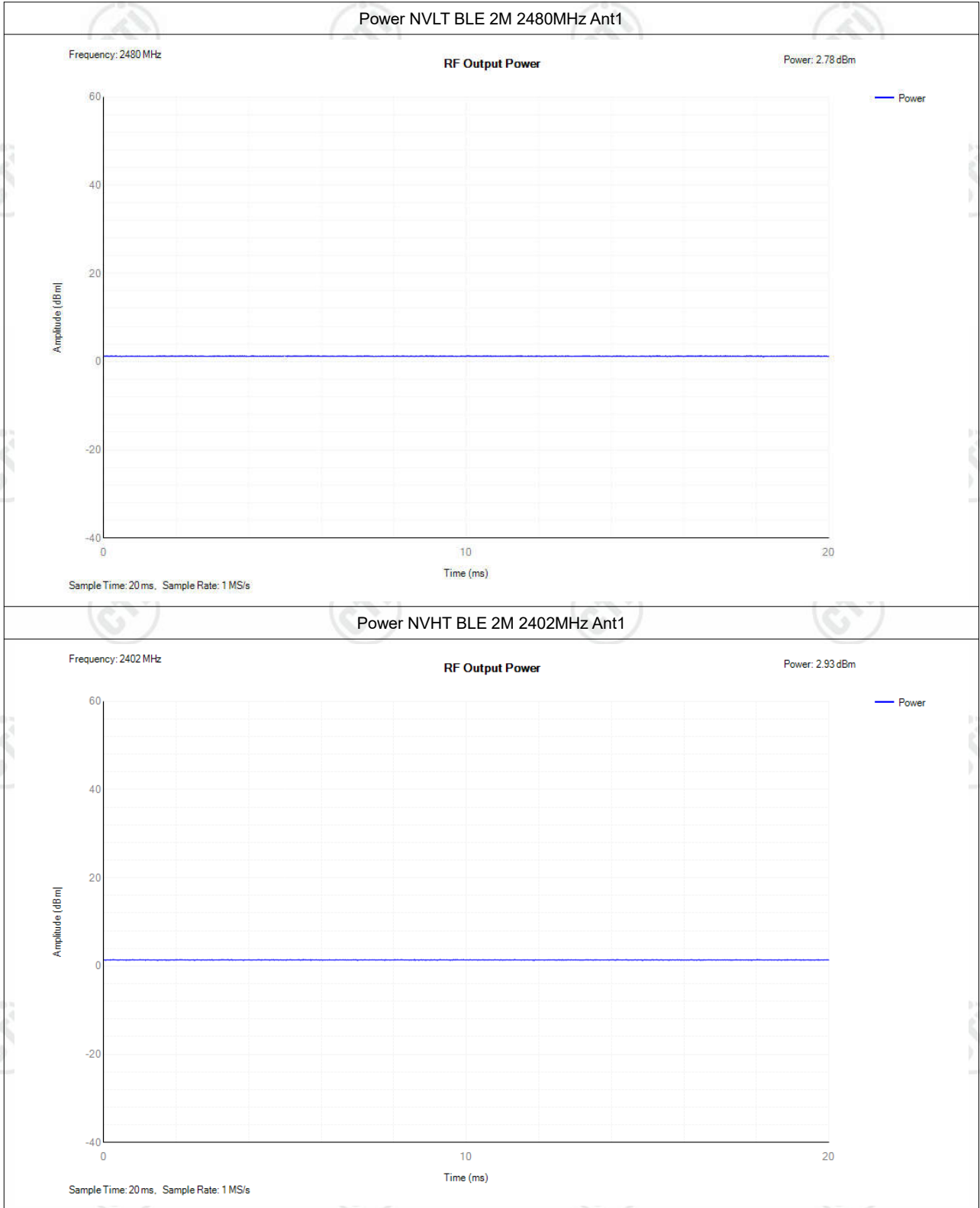

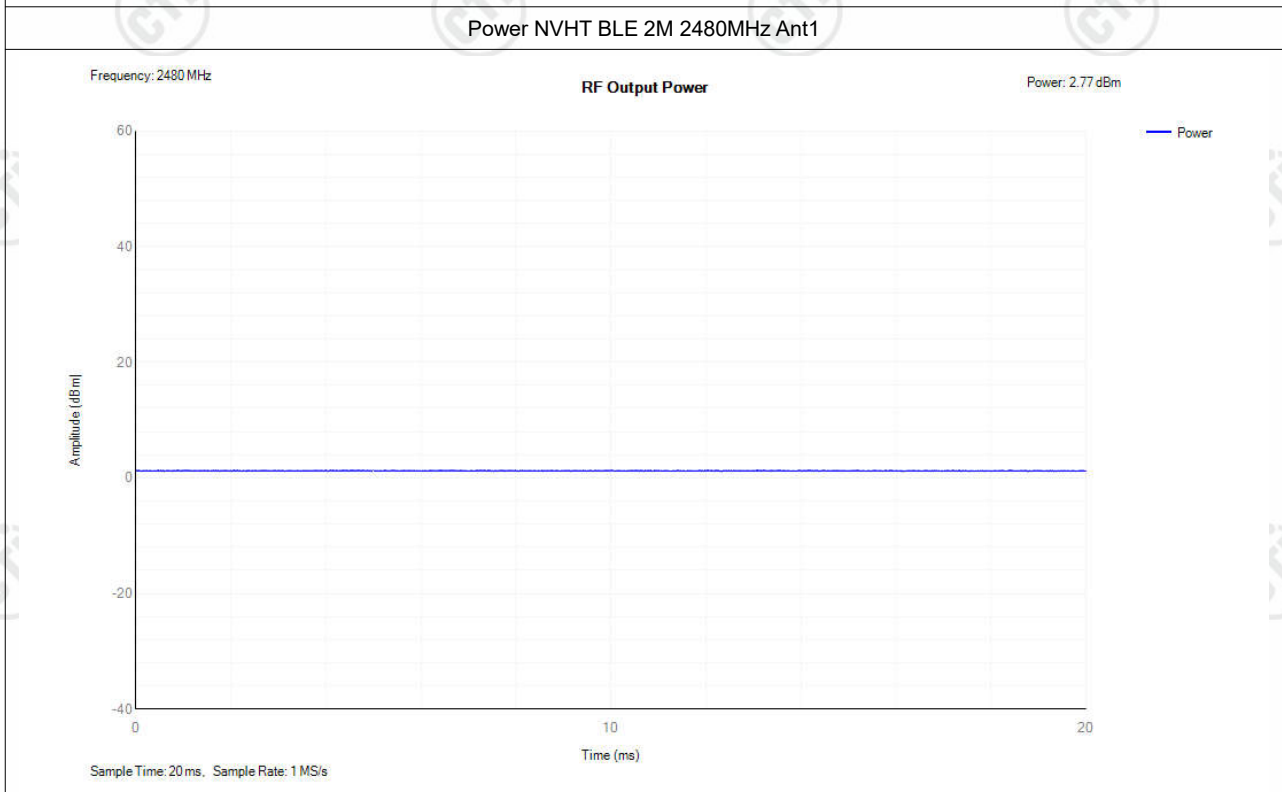
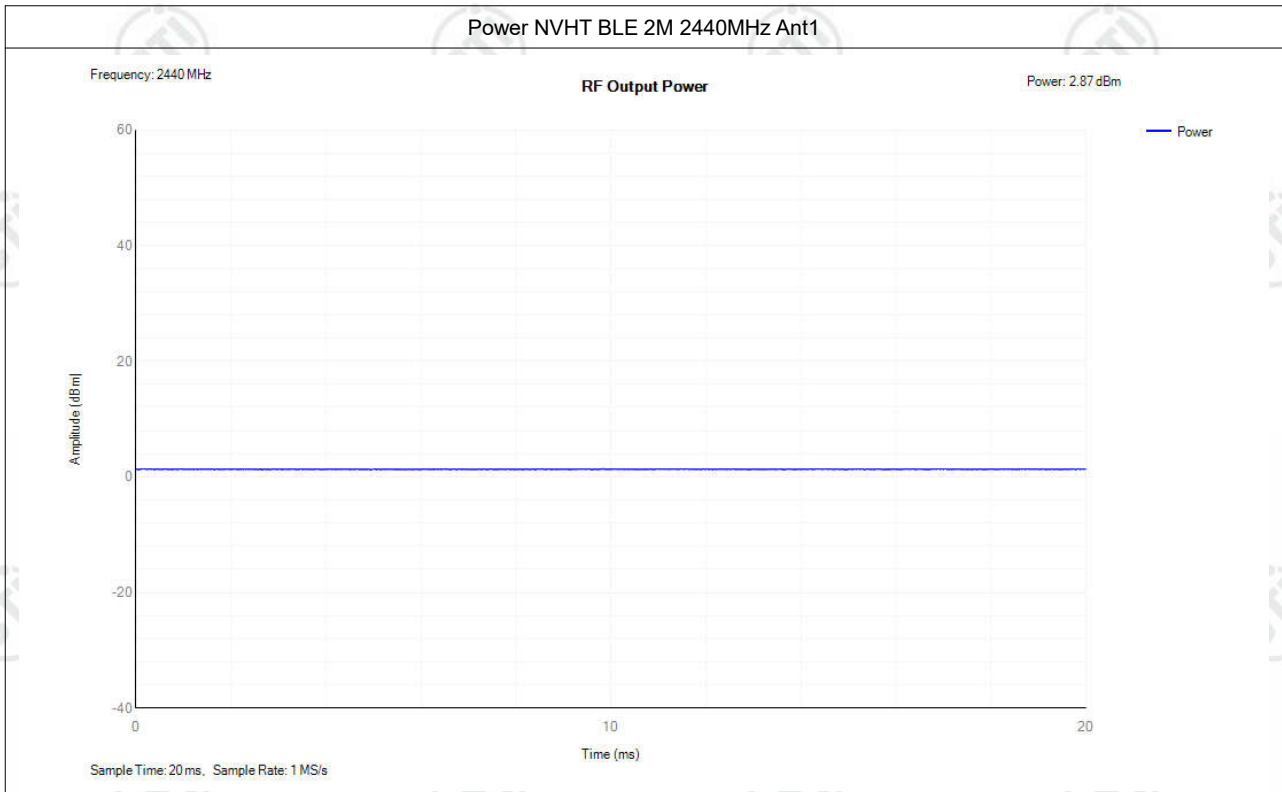



## 2. Power Spectral Density

Condition	Mode	Frequency (MHz)	Antenna	Max PSD (dBm/MHz)	Limit (dBm/MHz)	Verdict
NVNT	BLE 1M	2402	Ant1	2.76	10	Pass
NVNT	BLE 1M	2440	Ant1	2.83	10	Pass
NVNT	BLE 1M	2480	Ant1	2.72	10	Pass
NVNT	BLE 2M	2402	Ant1	1.74	10	Pass
NVNT	BLE 2M	2440	Ant1	1.65	10	Pass
NVNT	BLE 2M	2480	Ant1	1.68	10	Pass

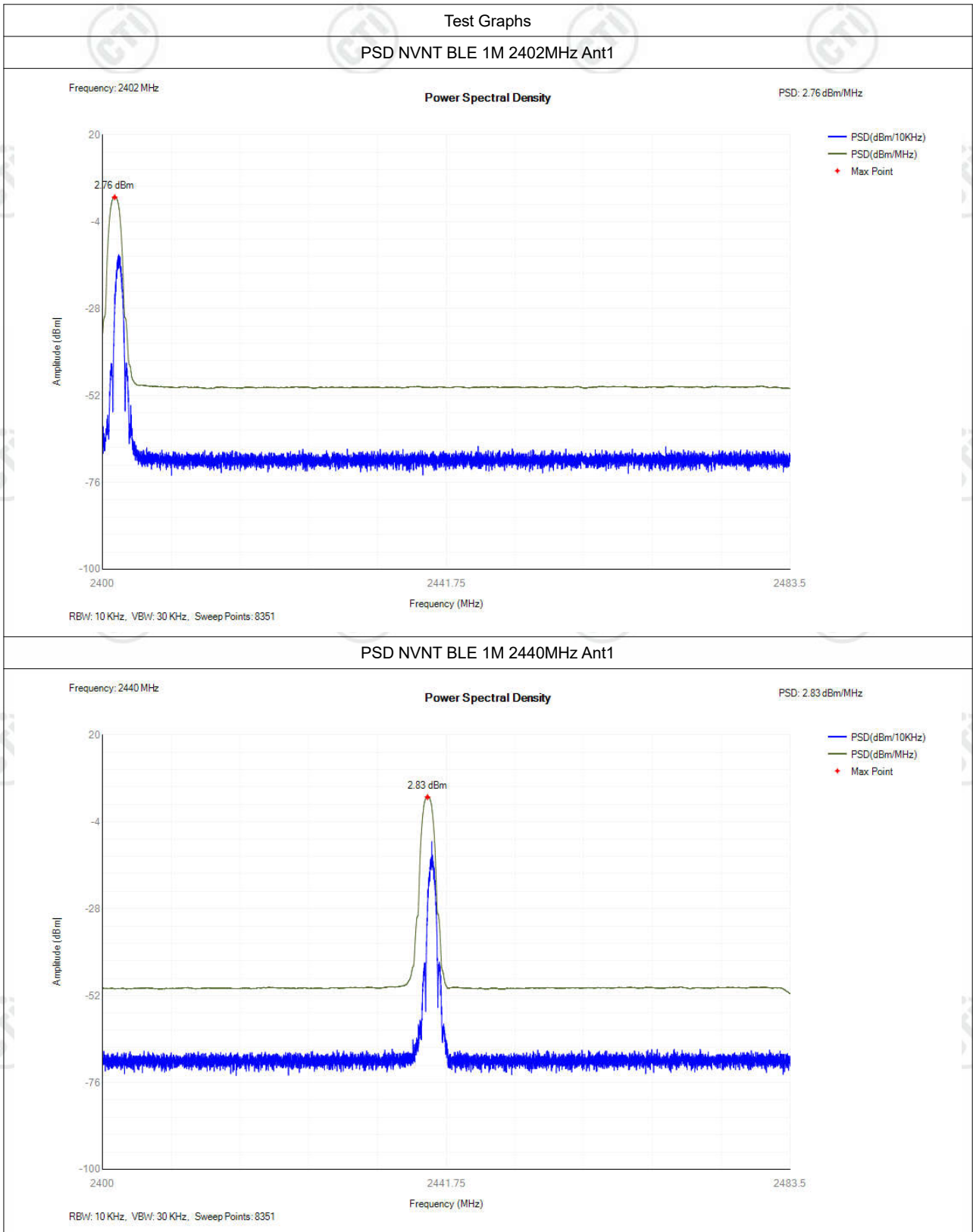

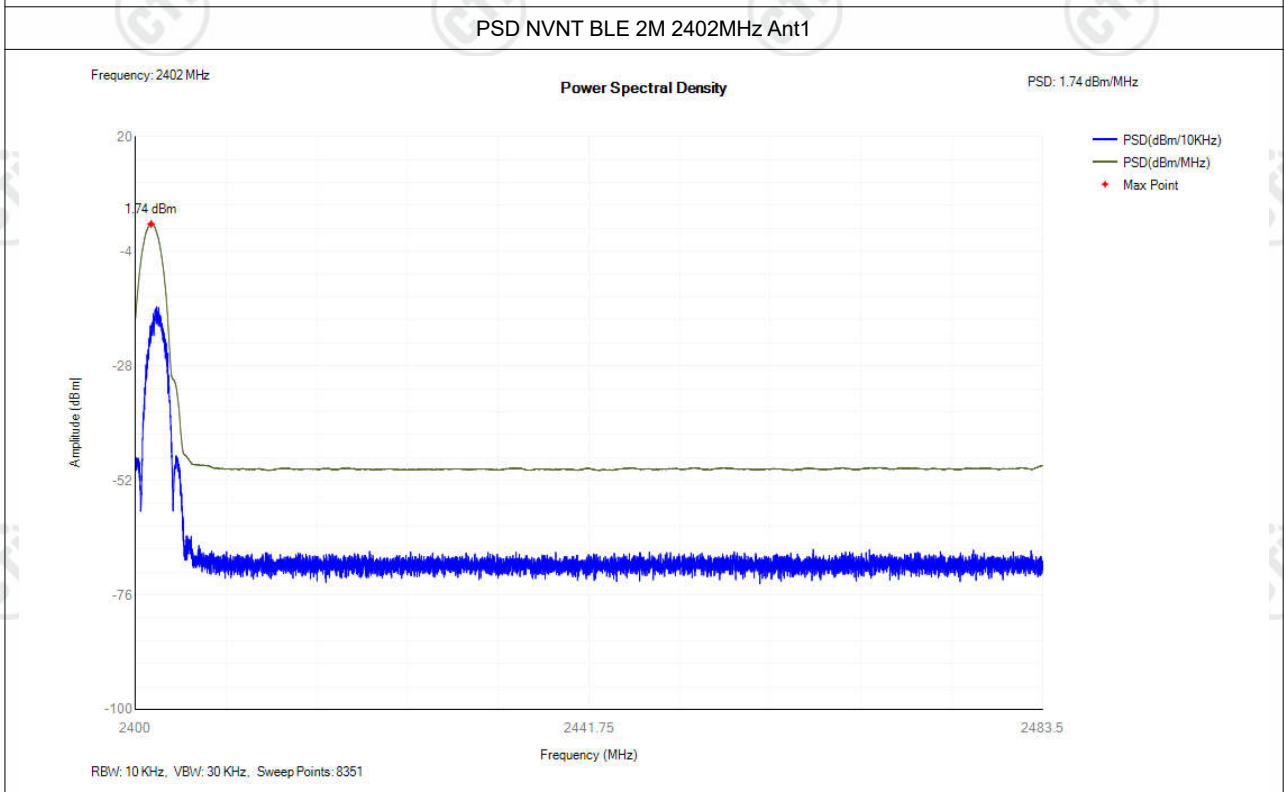
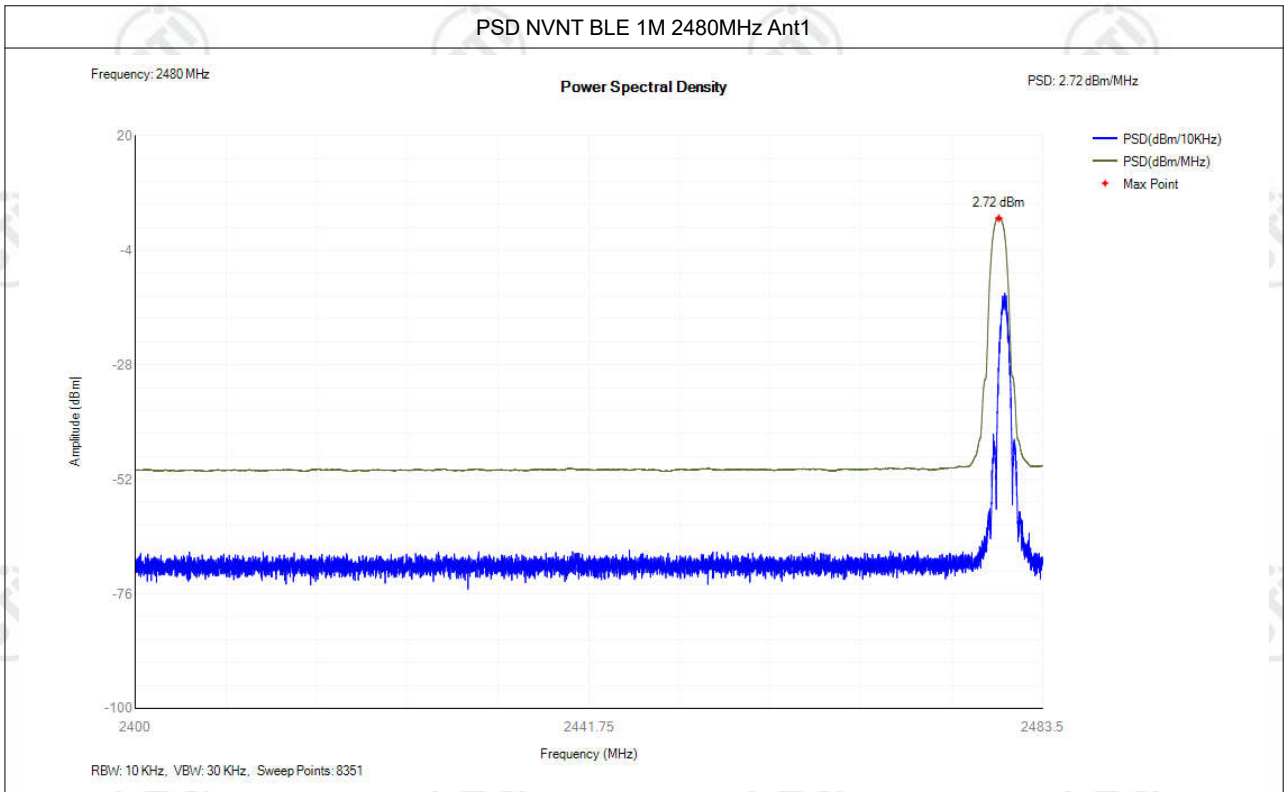

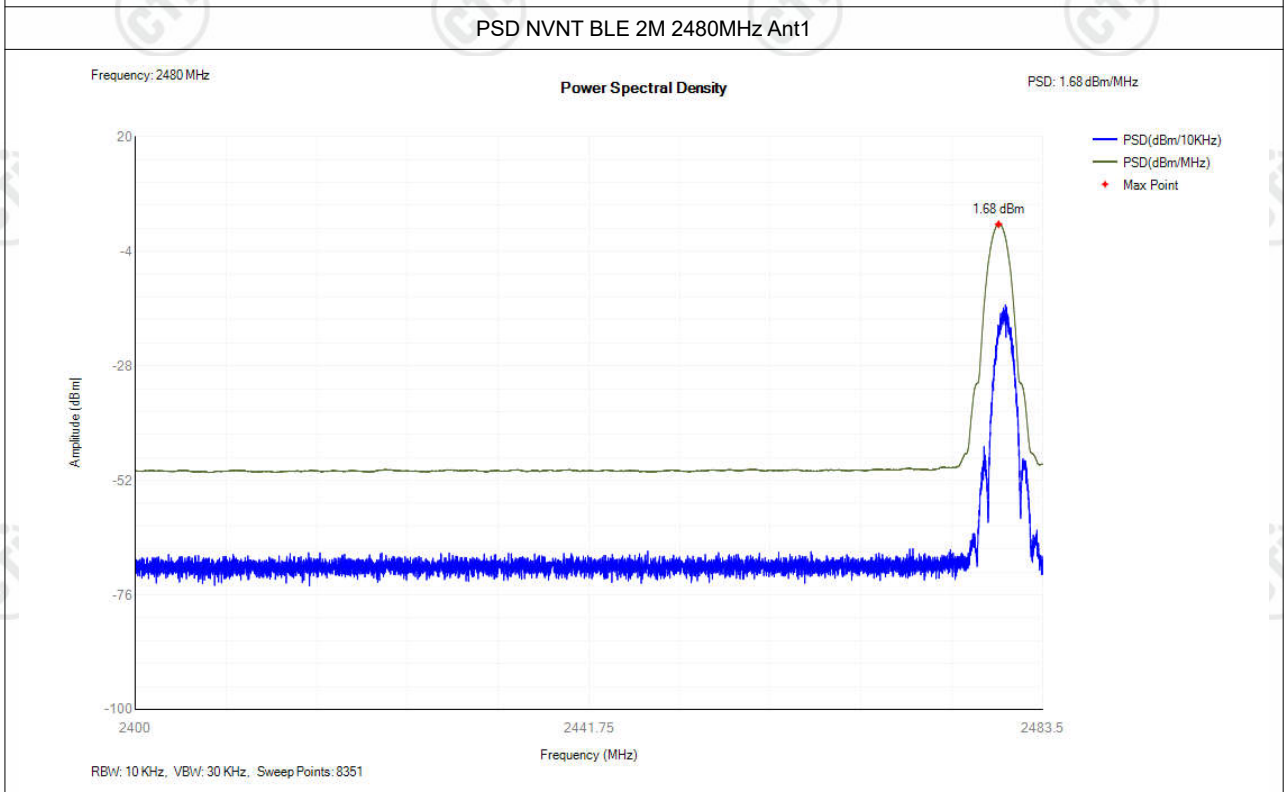
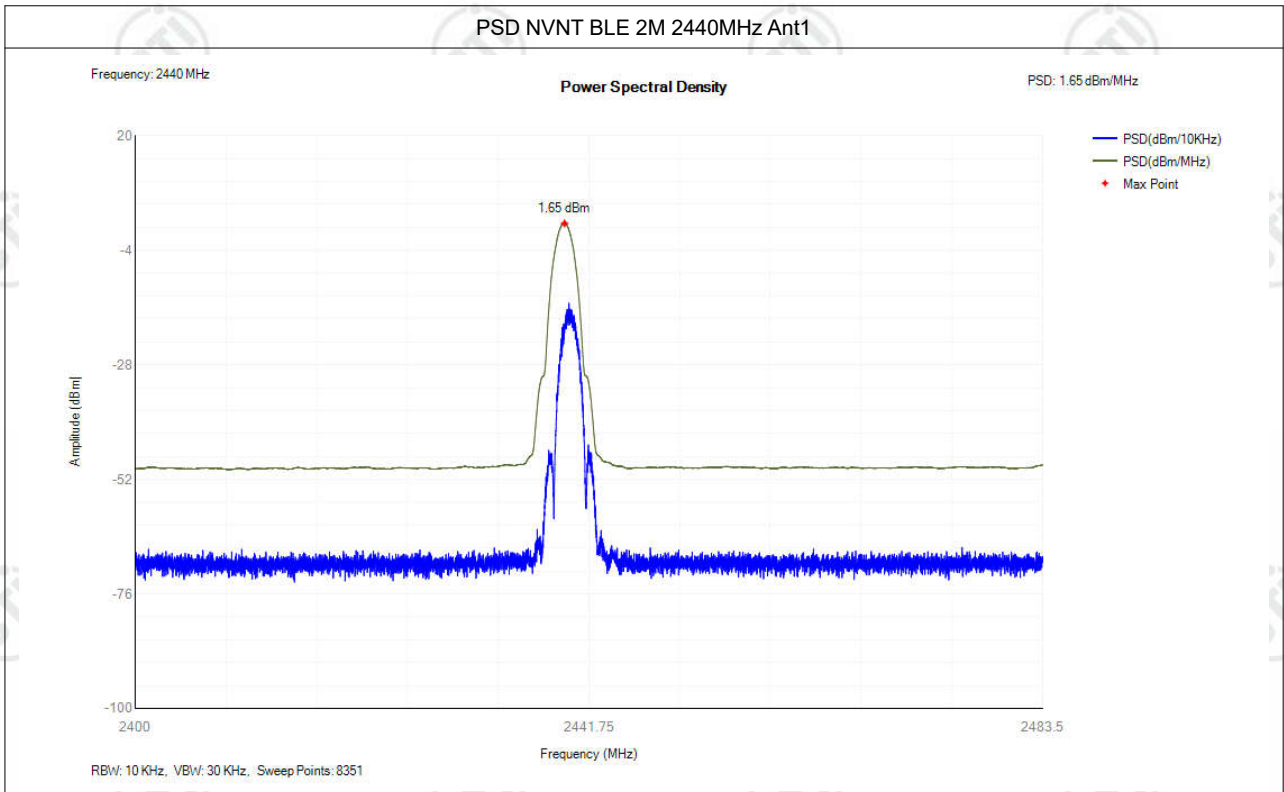

### 3. Occupied Channel Bandwidth

Condition	Mode	Frequency (MHz)	Antenna	Center Frequency (MHz)	OBW (MHz)	Lower Edge (MHz)	Upper Edge (MHz)	Limit OBW (MHz)	Verdict
NVNT	BLE 1M	2402	Ant1	2401.98	1.039	2401.461	2402.5	2400 - 2483.5MHz	Pass
NVNT	BLE 1M	2440	Ant1	2439.981	1.045	2439.459	2440.503	2400 - 2483.5MHz	Pass
NVNT	BLE 1M	2480	Ant1	2479.98	1.035	2479.463	2480.498	2400 - 2483.5MHz	Pass
NVNT	BLE 2M	2402	Ant1	2401.98	2.07	2400.945	2403.015	2400 - 2483.5MHz	Pass
NVNT	BLE 2M	2440	Ant1	2439.98	2.086	2438.937	2441.023	2400 - 2483.5MHz	Pass
NVNT	BLE 2M	2480	Ant1	2479.98	2.054	2478.953	2481.007	2400 - 2483.5MHz	Pass



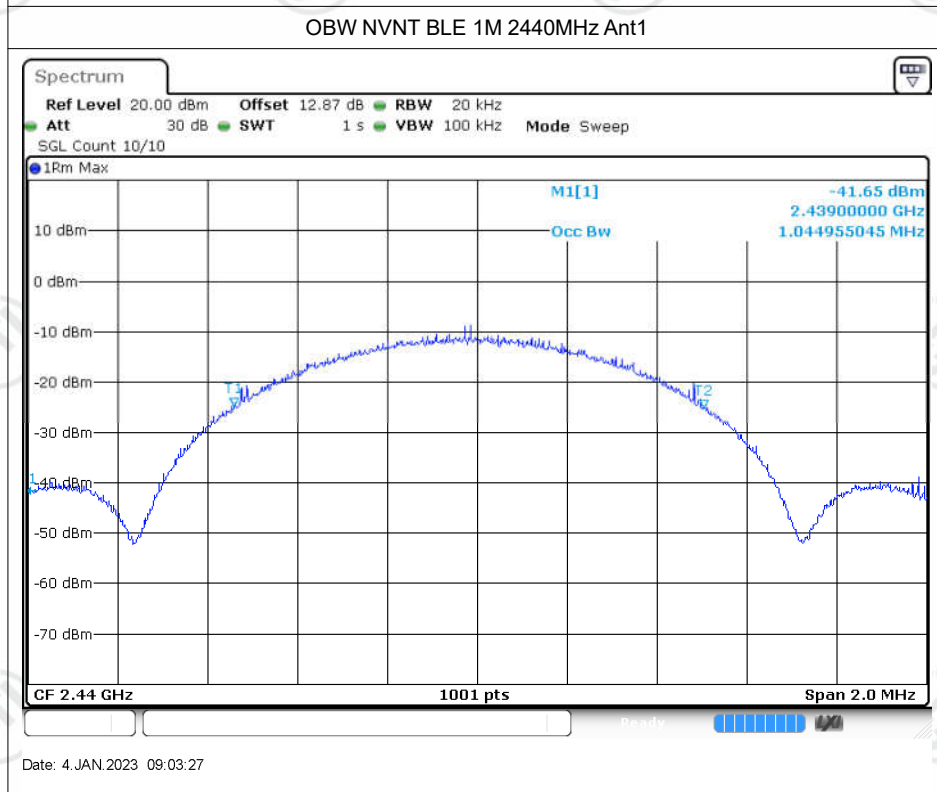
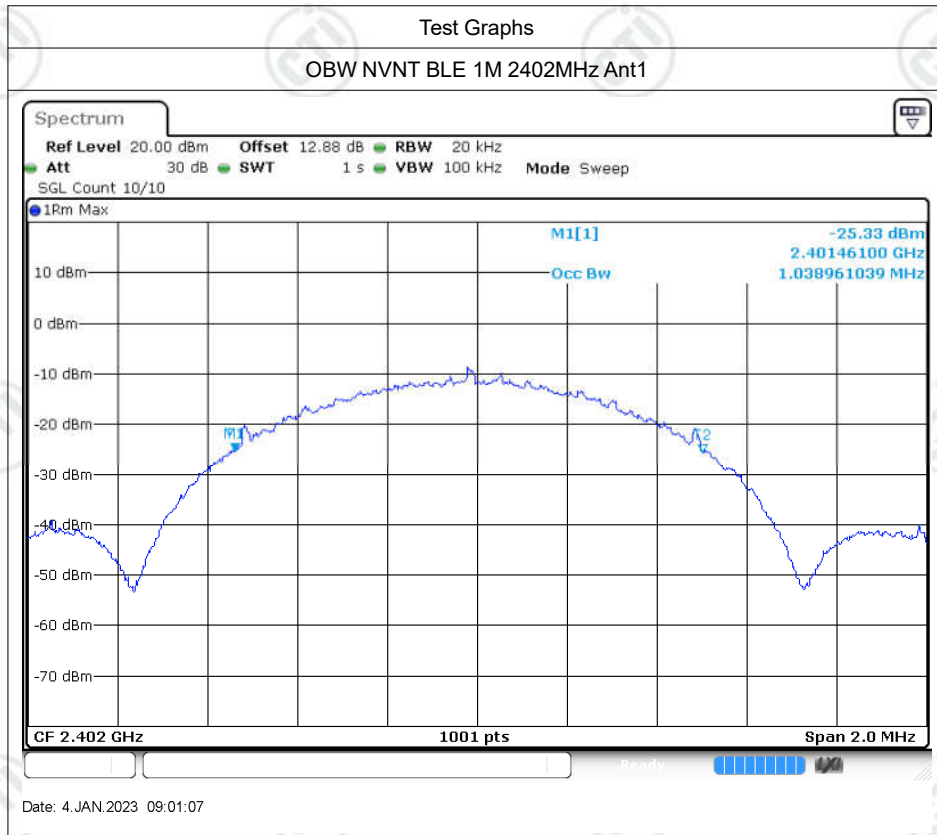

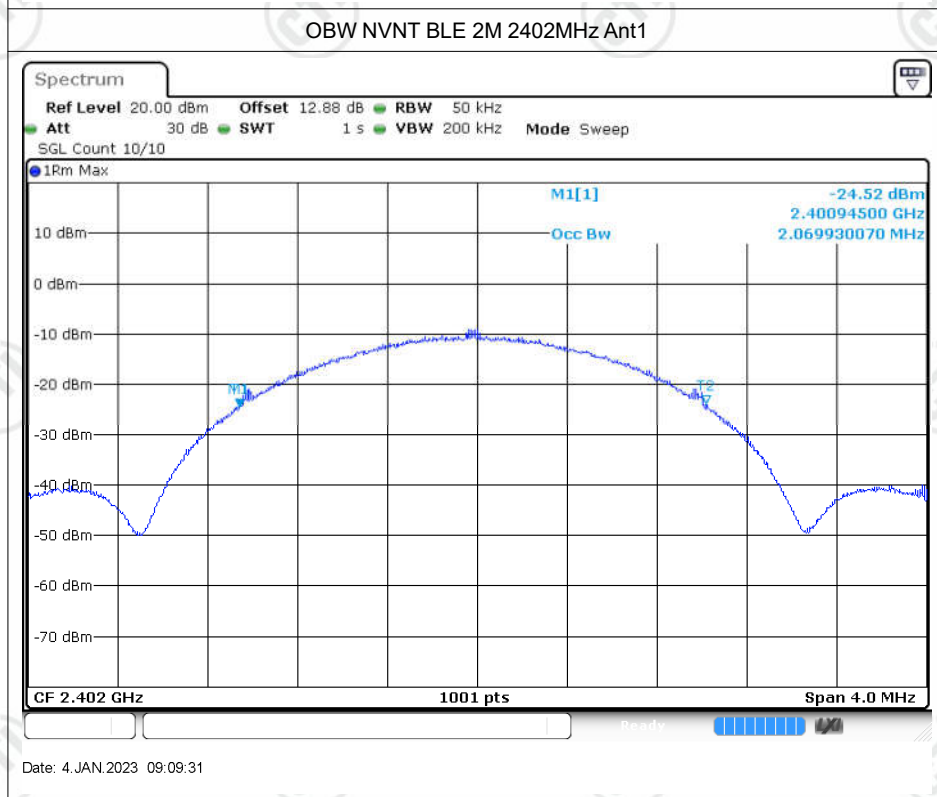
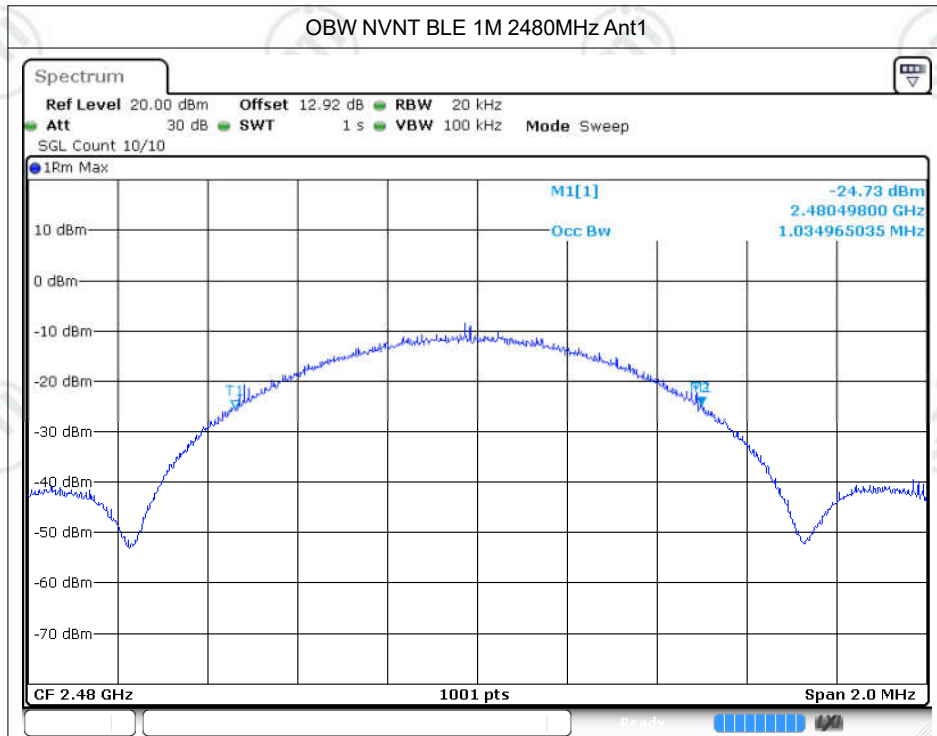

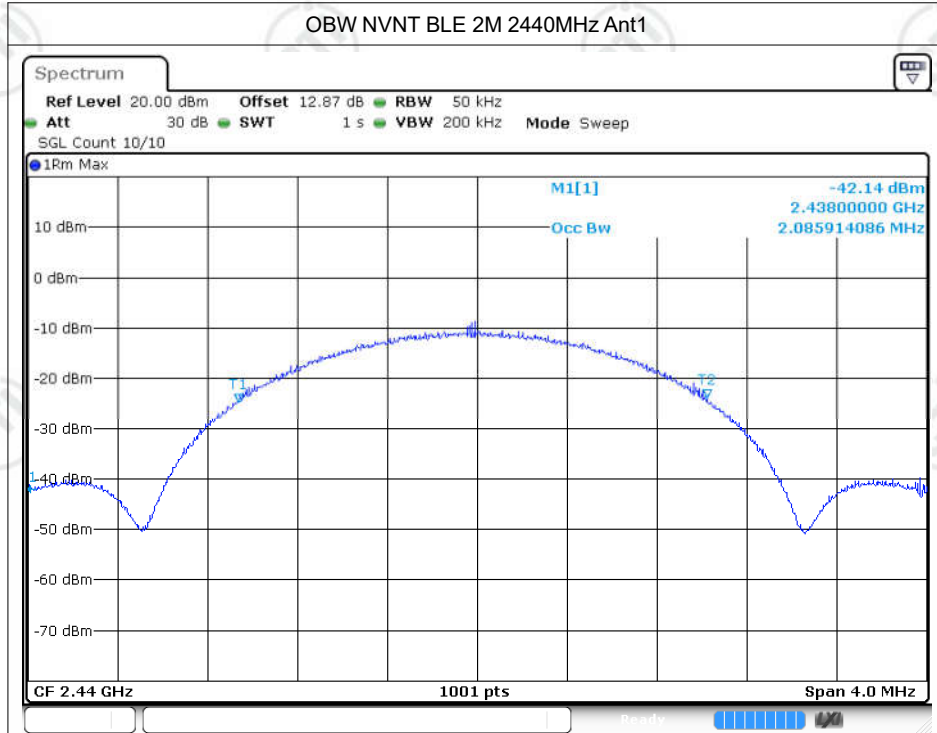

Date: 4. JAN.2023 09:12:56

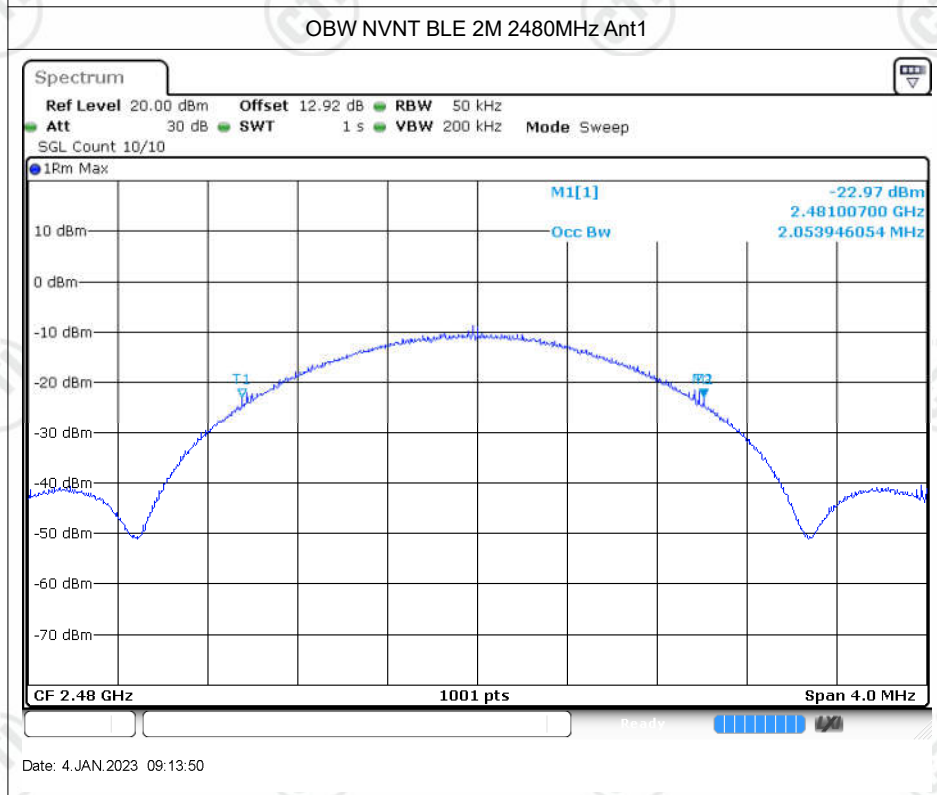

Date: 4. JAN.2023 09:13:50

### 4. Transmitter unwanted emissions in the out-of-band domain

Condition	Mode	Frequency (MHz)	Antenna	OOB Frequency (MHz)	Level (dBm/MHz)	Limit (dBm/MHz)	Verdict
NVNT	BLE 1M	2402	Ant1	2399.5	-44.25	-10	Pass
NVNT	BLE 1M	2402	Ant1	2399.461	-44.64	-10	Pass
NVNT	BLE 1M	2402	Ant1	2398.461	-46.93	-20	Pass
NVNT	BLE 1M	2402	Ant1	2398.422	-46.95	-20	Pass
NVNT	BLE 1M	2480	Ant1	2484	-48.18	-10	Pass
NVNT	BLE 1M	2480	Ant1	2484.035	-47.87	-10	Pass
NVNT	BLE 1M	2480	Ant1	2485.035	-48.18	-20	Pass
NVNT	BLE 1M	2480	Ant1	2485.07	-48.2	-20	Pass
NVNT	BLE 2M	2402	Ant1	2399.5	-30.91	-10	Pass
NVNT	BLE 2M	2402	Ant1	2398.5	-44.03	-10	Pass
NVNT	BLE 2M	2402	Ant1	2398.43	-44.41	-10	Pass
NVNT	BLE 2M	2402	Ant1	2397.43	-46.44	-20	Pass
NVNT	BLE 2M	2402	Ant1	2396.43	-47.87	-20	Pass
NVNT	BLE 2M	2402	Ant1	2396.36	-48.03	-20	Pass
NVNT	BLE 2M	2480	Ant1	2484	-46.48	-10	Pass
NVNT	BLE 2M	2480	Ant1	2485	-46.85	-10	Pass
NVNT	BLE 2M	2480	Ant1	2485.054	-46.84	-10	Pass
NVNT	BLE 2M	2480	Ant1	2486.054	-47.89	-20	Pass
NVNT	BLE 2M	2480	Ant1	2487.054	-48.26	-20	Pass
NVNT	BLE 2M	2480	Ant1	2487.108	-48.28	-20	Pass

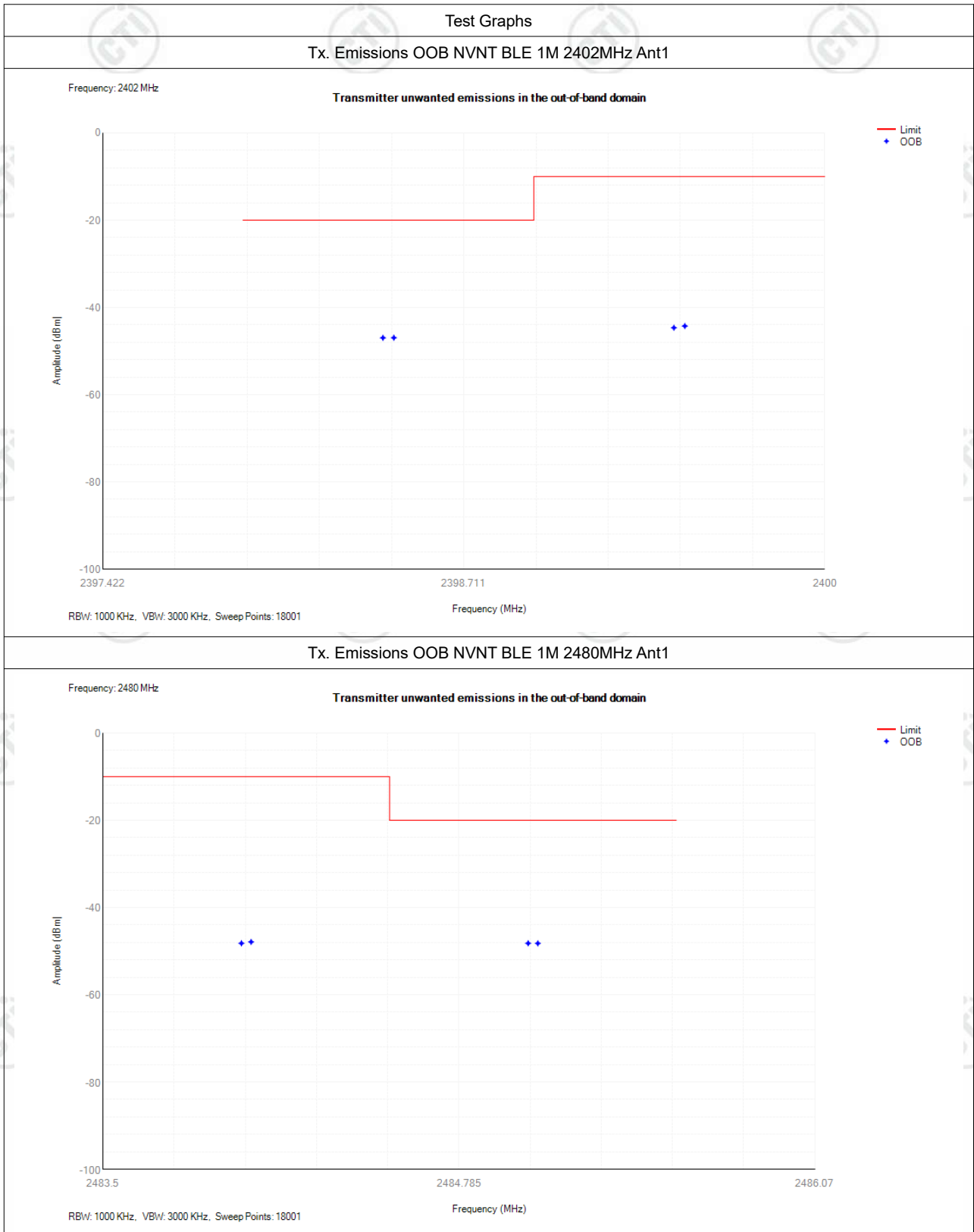



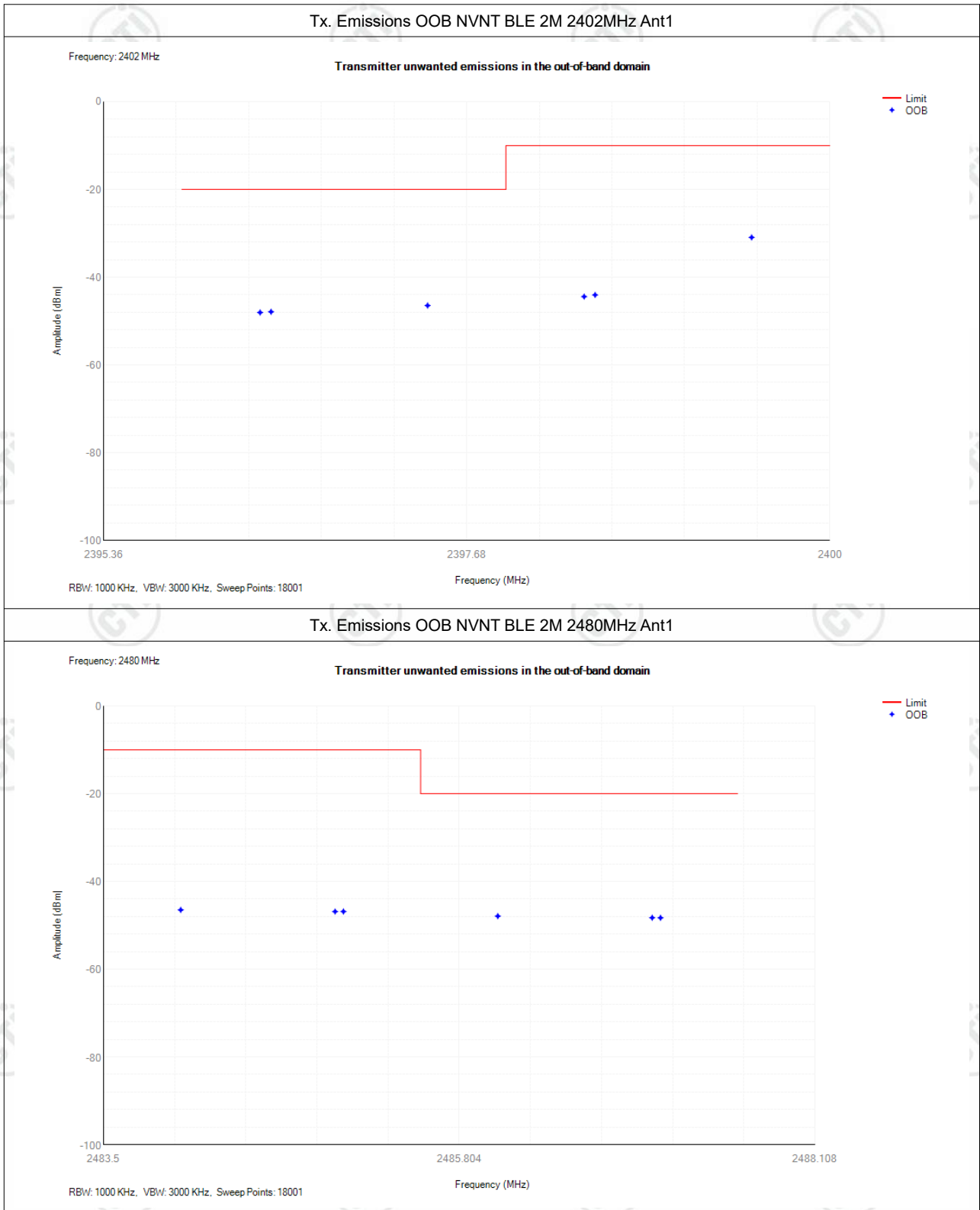

## 5. Receiver Blocking

Condition	Mode	Frequency (MHz)	Antenna	Wanted Power (dBm)	Blocking Frequency (MHz)	Blocking Power (dBm)	PER (%)	Limit (%)	Verdict
NVNT	BLE 1M	2402	Ant1	-67.29	2380	-32.46	2.3	10	Pass
NVNT	BLE 1M	2402	Ant1	-67.29	2300	-32.46	3.1	10	Pass
NVNT	BLE 1M	2480	Ant1	-67.31	2504	-32.46	2.4	10	Pass
NVNT	BLE 1M	2480	Ant1	-67.31	2584	-32.46	2.1	10	Pass
NVNT	BLE 2M	2402	Ant1	-64.3	2380	-32.46	2.5	10	Pass
NVNT	BLE 2M	2402	Ant1	-64.3	2300	-32.46	2.6	10	Pass
NVNT	BLE 2M	2480	Ant1	-64.33	2504	-32.46	3.1	10	Pass
NVNT	BLE 2M	2480	Ant1	-64.33	2584	-32.46	3.2	10	Pass

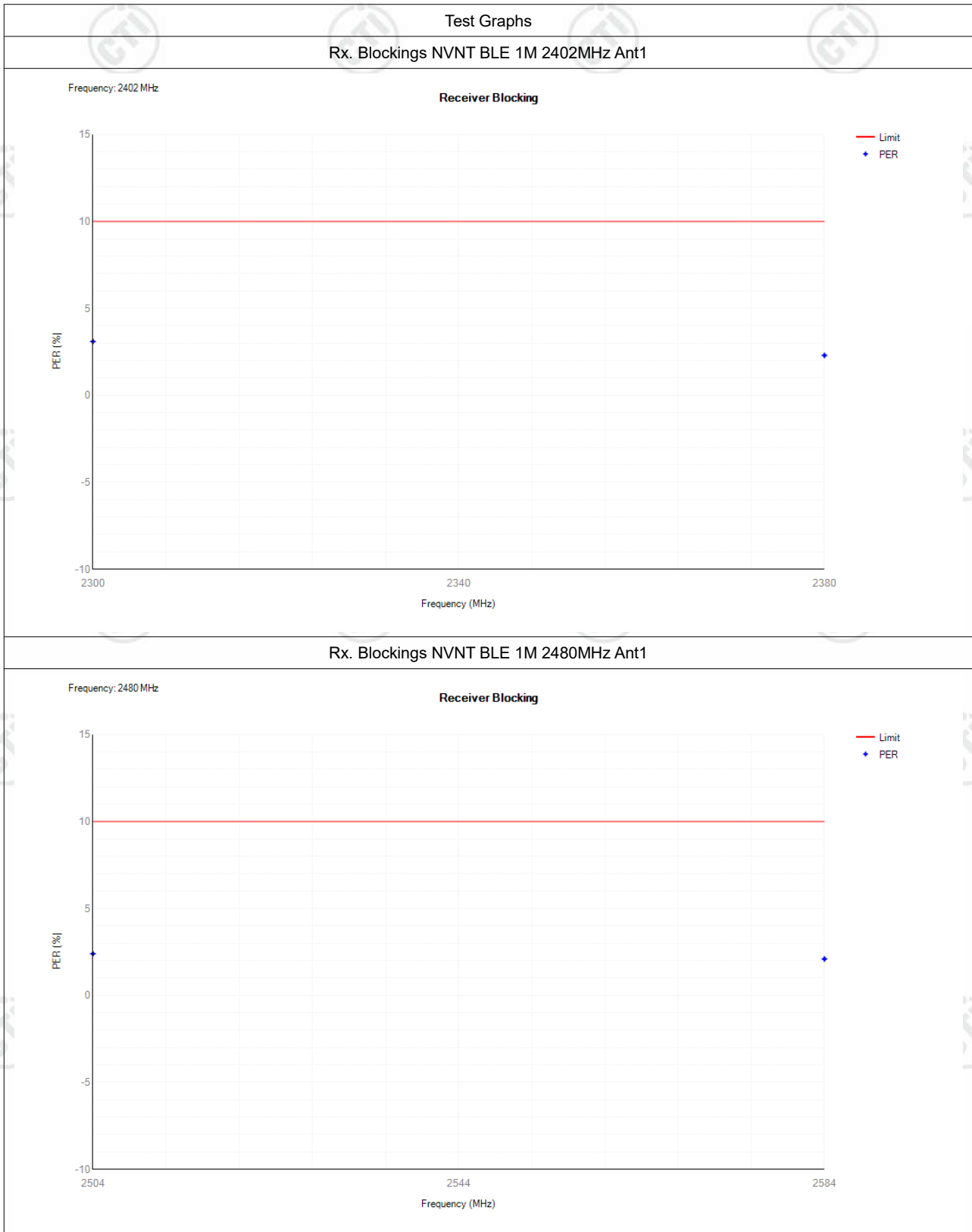

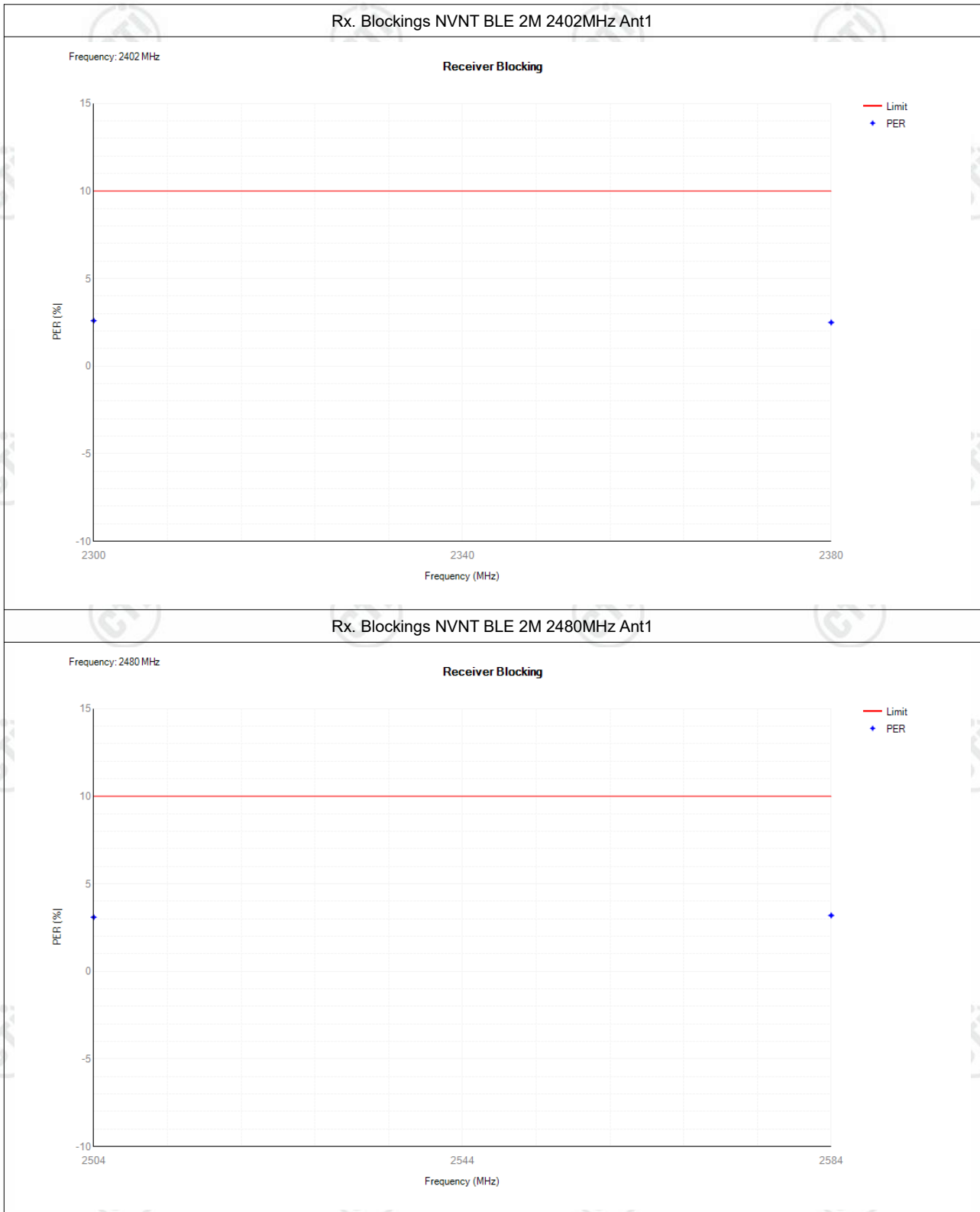

\*\*\* End of Report \*\*\*

## TEST REPORT

**Product** : BeaglePlay  
**Trade mark** : Beagleboard.org  
**Model/Type reference** : BeaglePlay  
**Serial Number** : N/A  
**Report Number** : EED32P80002201  
**Date of Issue** : Feb. 22, 2023  
**Test Standards** : ETSI EN 300 328 V2.2.2(2019-07)  
**Test result** : PASS

Prepared for:

**Seed Technology Co., Ltd**  
**9F, Building G3, TCL International E city, Zhongshanyuan Road,**  
**Nanshan, Shenzhen, China.**

Prepared by:

**Centre Testing International Group Co., Ltd.**  
**Hongwei Industrial Zone, Bao'an 70 District,**  
**Shenzhen, Guangdong, China**  
**TEL: +86-755-3368 3668**  
**FAX: +86-755-3368 3385**

Compiled by: mark.chen.

Reviewed by: Tom Chen

Approved by: Mark Chen  
Aaron Ma

Date: Tom Chen  
Feb. 22, 2023

Aaron Ma

Check No.: 5404030123





## 2 Version

Version No.	Date	Description
00	Feb. 22, 2023	Original

### 3 Test Summary

Test Item	Test Requirement	Test Method	Limit	Result
RF output power	EN 300 328 V2.2.2 (2019-07)Clause 4.3.2.2	EN 300 328 V2.2.2 (2019-07)Clause 5.4.2	Refer clause 4.3.2.2.3	PASS
Power Spectral Density	EN 300 328 V2.2.2 (2019-07)Clause 4.3.2.3	EN 300 328 V2.2.2 (2019-07)Clause 5.4.3	Refer clause 4.3.2.3.3	PASS
Duty Cycle, Tx-sequence, Tx-gap	EN 300 328 V2.2.2 (2019-07)Clause 4.3.2.4	EN 300 328 V2.2.2 (2019-07)Clause 5.4.2	Refer clause 4.3.2.4.3	N/A <sup>1</sup>
Medium Utilization (MU) factor	EN 300 328 V2.2.2 (2019-07)Clause 4.3.2.5	EN 300 328 V2.2.2 (2019-07)Clause 5.4.2	Refer clause 4.3.2.5.3	N/A <sup>2</sup>
Adaptivity	EN 300 328 V2.2.2 (2019-07)Clause 4.3.2.6	EN 300 328 V2.2.2 (2019-07)Clause 5.4.6	Refer clause 4.3.2.6.3.2	N/A <sup>3</sup>
Occupied Channel Bandwidth	EN 300 328 V2.2.2 (2019-07)Clause 4.3.2.7	EN 300 328 V2.2.2 (2019-07)Clause 5.4.7	Refer clause 4.3.2.7.3	PASS
Transmitter unwanted emissions in the out-of- band domain	EN 300 328 V2.2.2 (2019-07)Clause 4.3.2.8	EN 300 328 V2.2.2 (2019-07)Clause 5.4.8	Refer clause 4.3.2.8.3	PASS
Transmitter unwanted emissions in the spurious domain	EN 300 328 V2.2.2 (2019-07)Clause 4.3.2.9	EN 300 328 V2.2.2 (2019-07)Clause 5.4.9	Refer clause 4.3.2.9.3	PASS
Receiver spurious emissions	EN 300 328 V2.2.2 (2019-07)Clause 4.3.2.10	EN 300 328 V2.2.2 (2019-07)Clause 5.4.10	Refer clause 4.3.2.10.3	PASS
Receiver Blocking	EN 300 328 V2.2.2 (2019-07)Clause 4.3.2.11	EN 300 328 V2.2.2 (2019-07)Clause 5.4.11	Refer clause 4.3.2.11.4	PASS
Geo-location capability	EN 300 328 V2.2.2 (2019-07)Clause 4.3.1.13	EN 300 328 V2.2.2 (2019-07)Clause 4.3.1.13	Refer Clause 4.3.1.13.3	N/A <sup>4</sup>

Remark:

N/A<sup>1</sup>: Because these requirements apply to non-adaptive frequency hopping equipment mode and RF output power of greater than or equal to 10 dBm.

N/A<sup>2</sup>: Because these requirements apply to non-adaptive frequency hopping equipment mode and RF output power of greater than or equal to 10 dBm.

N/A<sup>3</sup>: Because these requirements apply to adaptive equipment mode and RF output power of greater than or equal to 10 dBm.

N/A<sup>4</sup>: Because these requirements apply to equipment with geo-location capability

Company Name and Address shown on Report, the sample(s) and sample Information was/ were provided by the applicant who should be responsible for the authenticity which CTI hasn't verified.

Tx: In this whole report Tx (or tx) means Transmitter.

Rx: In this whole report Rx (or rx) means Receiver.

RF: In this whole report RF means Radiated Frequency.

CH: In this whole report CH means channel.

Volt: In this whole report Volt means Voltage.

Temp: In this whole report Temp means Temperature.

Humid: In this whole report Humid means humidity.

Press: In this whole report Press means Pressure.

N/A: In this whole report not application.

## 4 Content

<b>1 COVERPAGE</b> .....	<b>1</b>
<b>2 VERSION</b> .....	<b>2</b>
<b>3 TEST SUMMARY</b> .....	<b>3</b>
<b>4 CONTENT</b> .....	<b>4</b>
<b>5 TEST REQUIREMENT</b> .....	<b>5</b>
5.1 TEST SETUP .....	5
5.1.1 For Conducted test setup .....	5
5.1.2 For Radiated Emissions test setup .....	5
5.2 TEST ENVIRONMENT .....	6
5.3 TEST CONDITION .....	6
<b>6 GENERAL INFORMATION</b> .....	<b>7</b>
6.1 CLIENT INFORMATION .....	7
6.2 GENERAL DESCRIPTION OF EUT .....	7
6.3 OTHER INFORMATION .....	8
6.4 DESCRIPTION OF SUPPORT UNITS .....	9
6.5 TEST LOCATION .....	9
6.6 DEVIATION FROM STANDARDS .....	9
6.7 ABNORMALITIES FROM STANDARD CONDITIONS .....	9
6.8 OTHER INFORMATION REQUESTED BY THE CUSTOMER .....	9
6.9 MEASUREMENT UNCERTAINTY (95% CONFIDENCE LEVELS, K=2) .....	10
<b>7 EQUIPMENT LIST</b> .....	<b>11</b>
<b>8 RADIO TECHNICAL REQUIREMENTS SPECIFICATION</b> .....	<b>13</b>
Appendix A: Spurious emissions .....	14
<b>PHOTOGRAPHS OF TEST SETUP</b> .....	<b>17</b>
<b>PHOTOGRAPHS OF EUT CONSTRUCTIONAL DETAILS</b> .....	<b>18</b>

## 5 Test Requirement

### 5.1 Test setup

#### 5.1.1 For Conducted test setup

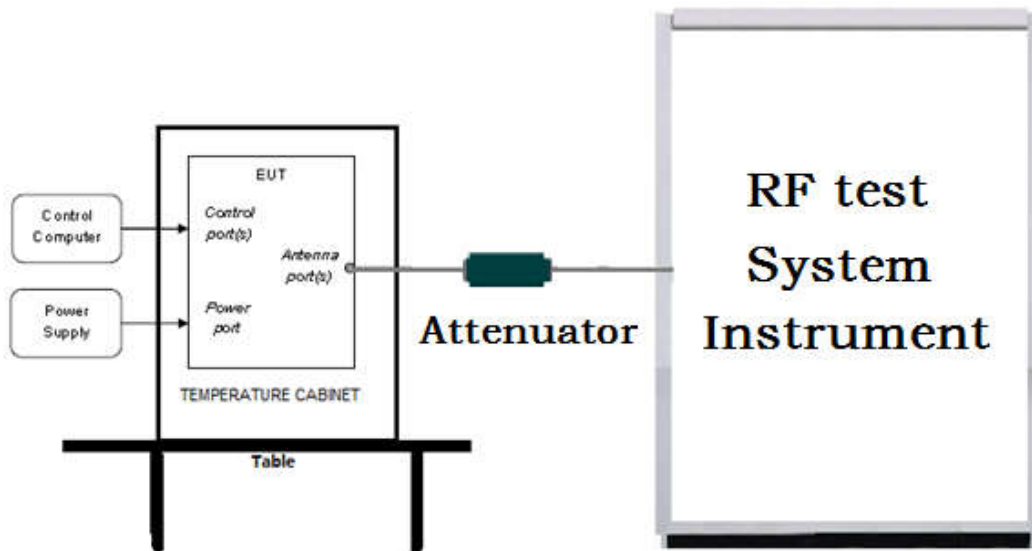

#### 5.1.2 For Radiated Emissions test setup

Radiated Emissions setup:

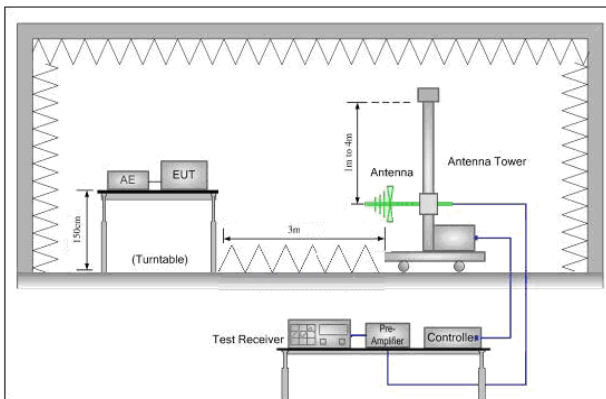

Figure 1. 30MHz to 1GHz

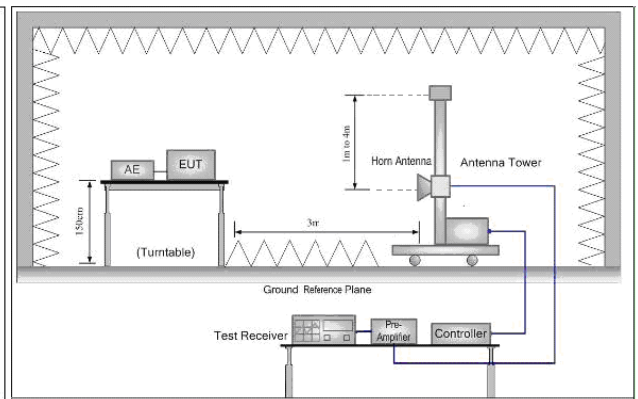

Figure 2. Above 1GHz

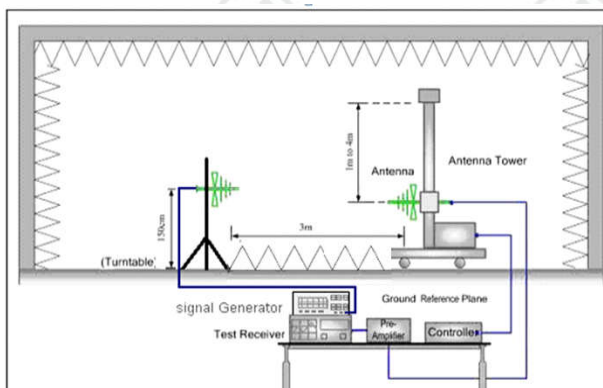

Figure 1. 30MHz to 1GHz

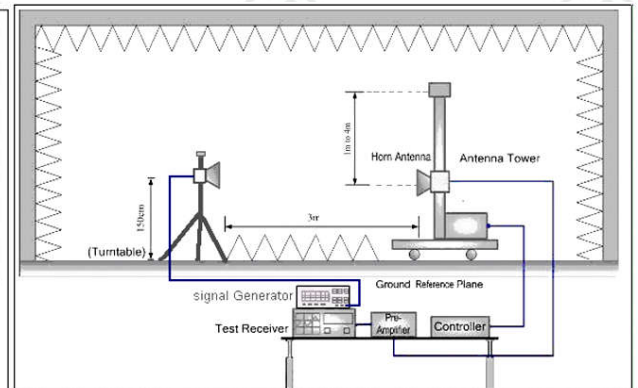

Figure 2. Above 1GHz

## 5.2 Test Environment

Environment Parameter	Selected Values During Tests		
	Ambient		
Test condition	Temperature(°C)	Voltage(V)	Relative Humidity%
NT/NV	23	DC 5V	54
LT/NV	0	DC 5V	54
HT/NV	60	DC 5V	54

Note:

- 1) The EUT just work in such extreme temperature of 0°C~+60°C, so here the EUT is tested in the temperature of 0°C~+60°C
- 2) NV: Normal Voltage NT:Normal Temperature  
LT: Low Extreme Test Temperature HT:High Extreme Test Temperature

### 5.1.2 Normal test conditions

#### 5.1.2.1 Normal temperature and humidity

Unless otherwise declared by the manufacturer, the normal temperature and humidity conditions for tests shall be any convenient combination of temperature and humidity within the following ranges:

- temperature: +15 °C to +35 °C;
- relative humidity: 20 % to 75 %.

The actual values during the tests shall be recorded.

#### 5.1.2.2 Normal power source

The normal test voltage for the equipment shall be the nominal voltage for which the equipment was designed.

### 5.1.3 Extreme test conditions

Some tests in the present document need to be repeated at extreme temperatures. Where that is the case, measurements shall be made over the extremes of the operating temperature range as declared by the manufacturer.

## 5.3 Test Condition

Test channel

Test Mode	Tx/Rx	RF Channel		
		Low(L)	Middle(M)	High(H)
BLE_1M	2402MHz ~2480 MHz	Channel 1	Channel 20	Channel40
BLE_2M		2402MHz	2440MHz	2480MHz
BLE_1M: Bluetooth LE_1Mbps of GFSK, BLE_2M: Bluetooth LE_2Mbps of GFSK.				



## 6 General Information

### 6.1 Client Information

Applicant:	Seeed Technology Co., Ltd
Address of Applicant:	9F, Building G3, TCL International E city, Zhongshanyuan Road, Nanshan, Shenzhen, China.
Manufacturer:	Seeed Technology Co., Ltd
Address of Manufacturer:	9F, Building G3, TCL International E city, Zhongshanyuan Road, Nanshan, Shenzhen, China.
Factory:	Shenzhen Xinxian Technology Co., Limited
Address of Factory:	F5, Building B17, Hengfeng Industrial City, No. 739 Zhoushi Rd, Baoan District, Shenzhen, Guangdong, P.R.C.

### 6.2 General Description of EUT

Product Name:	BeaglePlay
Model No.(EUT):	BeaglePlay
Trade Mark:	Beagleboard.org
Frequency Range:	2402MHz to 2480MHz
Modulation Type:	GFSK
Transmission Rate:	1Mbps, 2Mbps
Number of Channels:	40
Sample Type:	Fixed-Use
Test Power Grade:	Default
Test Software of EUT:	Setup_SmartRF_Studio_7
Antenna Type:	PCB Antenna
Antenna Gain:	1.54dBi
Power Supply:	DC 5V
Test voltage:	DC 5V

### 6.3 Other Information

RED Directive:	2014/53/EU
Sample Received Date:	Jan. 03, 2023
Sample tested Date:	Jan. 03, 2023 to Feb. 16, 2023

Operation Frequency each of channel							
Channel	Frequency	Channel	Frequency	Channel	Frequency	Channel	Frequency
1	2402MHz	11	2422MHz	21	2442MHz	31	2462MHz
2	2404MHz	12	2424MHz	22	2444MHz	32	2464MHz
3	2406MHz	13	2426MHz	23	2446MHz	33	2466MHz
4	2408MHz	14	2428MHz	24	2448MHz	34	2468MHz
5	2410MHz	15	2430MHz	25	2450MHz	35	2470MHz
6	2412MHz	16	2432MHz	26	2452MHz	36	2472MHz
7	2414MHz	17	2434MHz	27	2454MHz	37	2474MHz
8	2416MHz	18	2436MHz	28	2456MHz	38	2476MHz
9	2418MHz	19	2438MHz	29	2458MHz	39	2478MHz
10	2420MHz	20	2440MHz	30	2460MHz	40	2480MHz

## 6.4 Description of Support Units

The EUT has been tested with associated equipment below.

1) support equipment

Description	Manufacturer	Model No.	Certification	Supplied by
Netbook	DELL	Latitude 3490	FCC&CE	CTI

## 6.5 Test Location

All tests were performed at:

Centre Testing International Group Co., Ltd.

Building C, Hongwei Industrial Park Block 70, Bao'an District, Shenzhen, China

Telephone: +86 (0) 755 3368 3668 Fax: +86 (0) 755 3368 3385

No tests were sub-contracted.

## 6.6 Deviation from Standards

None.

## 6.7 Abnormalities from Standard Conditions

None.

## 6.8 Other Information Requested by the Customer

None.

### 6.9 Measurement Uncertainty (95% confidence levels, k=2)

No.	Item	Measurement Uncertainty
1	Occupied Bandwidth	0.52dB
2	RF Power conducted	0.46dB(30MHz-1GHz)
		0.55dB(1GHz-18GHz)
3	Power Spectral Density, conducted	0.57dB
4	Unwanted Emission, conducted	0.46dB(30MHz-1GHz)
		0.55dB(1GHz-18GHz)
5	All Emission, radiated	4.9dB(30MHz-1GHz)
		4.7dB(1GHz-18GHz)
6	Temperature test	0.64°C
7	Humidity test	3.8%
8	DC and low frequency voltages test	0.026%

## 7 Equipment List

RF test system					
Equipment	Manufacturer	Mode No.	Serial Number	Cal. Date (mm-dd-yyyy)	Cal. Due date (mm-dd-yyyy)
Communication test set	R&S	CMW500	107929	07-06-2022	07-05-2023
Signal Generator	R&S	SMBV100A	1407.6004K02- 262149-CV	09-09-2022	09-08-2023
Spectrum Analyzer	R&S	FSV40	101200	08-01-2022	07-31-2023
RF control unit(power unit)	MWRF-test	MW100-RFCB	MW220620CTI-42	07-06-2022	07-05-2023
high-low temperature test chamber	Dong Guang Qin Zhuo	LK-80GA	QZ20150611879	12-19-2022	12-18-2023
Temperature/ Humidity Indicator	biaozhi	HM10	1804186	06-16-2022	06-15-2023
BT&WI-FI Automatic test software	MWRF-test	MTS 8310	2.0.0.0	---	---



3M full-anechoic Chamber					
Equipment	Manufacturer	Model No.	Serial Number	Cal. Date (mm-dd-yyyy)	Cal. Due date (mm-dd-yyyy)
RSE Automatic test software	JS Tonscend	JS36-RSE	10166	---	---
Receiver	Keysight	N9038A	MY57290136	03-01-2022	02-28-2023
Spectrum Analyzer	Keysight	N9020B	MY57111112	03-01-2022	02-28-2023
Spectrum Analyzer	Keysight	N9030B	MY57140871	03-01-2022	02-28-2023
TRILOG Broadband Antenna	Schwarzbeck	VULB 9163	9163-1148	04-28-2021	04-27-2024
Horn Antenna	Schwarzbeck	BBHA 9170	9170-832	04-15-2021	04-14-2024
Horn Antenna	ETS-LINDGREN	3117	57407	07-04-2021	07-03-2024
Preamplifier	EMCI	EMC184055SE	980597	04-20-2022	04-19-2023
Preamplifier	EMCI	EMC001330	980563	04-13-2022	04-12-2023
Preamplifier	JS Tonscend	TAP-011858	AP21B806112	07-29-2022	07-28-2023
Communication test set	R&S	CMW500	102898	12-23-2022	12-22-2023
Temperature/Humidity Indicator	biaozhi	GM1360	EE1186631	02-21-2022	02-20-2023
Fully Anechoic Chamber	TDK	FAC-3	---	01-09-2021	01-08-2024
Cable line	Times	SFT205-NMSM-2.50M	394812-0001	---	---
Cable line	Times	SFT205-NMSM-2.50M	394812-0002	---	---
Cable line	Times	SFT205-NMSM-2.50M	394812-0003	---	---
Cable line	Times	SFT205-NMSM-2.50M	393495-0001	---	---
Cable line	Times	EMC104-NMNM-1000	SN160710	---	---
Cable line	Times	SFT205-NMSM-3.00M	394813-0001	---	---
Cable line	Times	SFT205-NMNM-1.50M	381964-0001	---	---
Cable line	Times	SFT205-NMSM-7.00M	394815-0001	---	---
Cable line	Times	HF160-KMKM-3.00M	393493-0001	---	---

## 8 Radio Technical Requirements Specification

### Reference documents for testing:

No.	Identity	Document Title
1	EN 300 328 V2.2.2 (2019-07)	Wideband transmission systems; Data transmission equipment operating in the 2,4 GHz band; Harmonised Standard for access to radio spectrum

### Test Results List:

EN300 328 V2.2.2		Test Descriptions & Test Conditions	Verdict	Note
Test Requirement	Test Method			
Clause 4.3.2.2	Clause 5.4.2	RF output power,		Note 1
		NT/NV	PASS	
		LT/NV	PASS	
Clause 4.3.2.3	Clause 5.4.3	Power Spectral Density		Note 1
		NT/NV	PASS	
		HT/NV	PASS	
Clause 4.3.2.4	Clause 5.4.2	Duty Cycle, Tx-sequence, Tx-gap		N/A
		NT/NV	N/A	
Clause 4.3.2.5	Clause 5.4.2	Medium Utilisation (MU) factor		N/A
		NT/NV	N/A	
Clause 4.3.2.6	Clause 5.4.6	Adaptivity (adaptive equipment using modulations other than FHSS)		N/A
		NT/NV	N/A	
Clause 4.3.2.7	Clause 5.4.7	Occupied Channel Bandwidth		Note 1
		NT/NV	PASS	
Clause 4.3.2.8	Clause 5.4.8	Transmitter unwanted emissions in the out-of-band domain		Note 1
		NT/NV	PASS	
Clause 4.3.2.11	Clause 5.4.11	Receiver Blocking		Note 1
		NT/NV	PASS	
Clause 4.3.2.9	Clause 5.4.9	Transmitter unwanted emissions in the spurious domain		Appendix A
		NT/NV	PASS	
Clause 4.3.2.10	Clause 5.4.10	Receiver spurious emissions		Appendix A
		NT/NV	PASS	

Note 1: The test data please refer to Appendix: Bluetooth LE of EED32P80002201

## Appendix A: Spurious emissions

### Test Procedure:

1. Scan from 30MHz to 12.75GHz; find the maximum radiation frequency to measure.
2. The technique used to find the Spurious Emissions of the transmitter was the antenna substitution method. Substitution method was performed to determine the actual ERP/EIRP emission levels of the EUT.

Test procedure as below:

- 1) The EUT was powered ON and placed on a 1.5m high table at a 3 meter fully Anechoic Chamber. The antenna of the transmitter was extended to its maximum length. Modulation mode and the measuring receiver shall be tuned to the frequency of the transmitter under test.
- 2) The EUT was set 3 meters (above 18GHz the distance is 1 meter) away from the interference-receiving antenna, which was mounted on the top of a variable-height antenna tower.
- 3) The disturbance of the transmitter was maximized on the test receiver display by raising and lowering from 1m to 4m the receive antenna and by rotating through 360° the turntable. After the fundamental emission was maximized, a field strength measurement was made.
- 4) Steps 1) to 3) were performed with the EUT and the receive antenna in both vertical and horizontal polarization.
- 5) The transmitter was then removed and replaced with another antenna. The center of the antenna was approximately at the same location as the center of the transmitter.
- 6) A signal at the disturbance was fed to the substitution antenna by means of a non-radiating cable. With both the substitution and the receive antennas horizontally polarized, the receive antenna was raised and lowered to obtain a maximum reading at the test receiver. The level of the signal generator was adjusted until the measured field strength level in step 3) is obtained for this set of conditions.
- 7) The output power into the substitution antenna was then measured.
- 8) Steps 6) and 7) were repeated with both antennas polarized.
- 9) Calculate power in dBm by the following formula:  

$$\text{ERP(dBm)} = \text{Pg(dBm)} - \text{cable loss (dB)} + \text{antenna gain (dBd)}$$

$$\text{EIRP(dBm)} = \text{Pg(dBm)} - \text{cable loss (dB)} + \text{antenna gain (dBi)}$$

$$\text{EIRP} = \text{ERP} + 2.15\text{dB}$$

where:

Pg is the generator output power into the substitution antenna.

- 10) Test the EUT in the lowest channel , the Highest channel
- 11) Repeat above procedures until all frequencies measured was complete.

### Transmitter limits for spurious emissions

Frequency range	Maximum power, e.r.p. (≤ 1 GHz) e.i.r.p. (> 1 GHz)	Bandwidth
30 MHz to 47 MHz	-36dBm	100 kHz
47 MHz to 74 MHz	-54 dBm	100 kHz
74 MHz to 87,5 MHz	-36dBm	100 kHz
87,5 MHz to 118 MHz	-54 dBm	100 kHz
118 MHz to 174 MHz	-36dBm	100 kHz
174 MHz to 230 MHz	-54 dBm	100 kHz
230 MHz to 470 MHz	-36dBm	100 kHz
470 MHz to 694 MHz	-54 dBm	100 kHz
694 MHz to 1 GHz	-36dBm	100 kHz
1 GHz to 12.75 GHz	-30dBm	1MHz

### Spurious emission limits for receivers

Frequency range	Maximum power e.r.p. (≤ 1 GHz) e.i.r.p. (> 1 GHz)	bandwidth
30MHz to 1GHz	-57dBm	100kHz
1GHz to 12.75GHz	-47dBm	1MHz

Limit:

## Radiated Spurious Emissions test Data:

### 1) Transmitter unwanted emissions in the spurious domain

Remark: Through Pre-scan, BLE\_1M mode was the worst case, only the worst case was recorded in the report.

Mode:		BLE Transmitting						
Channel:		2402 MHz						
NO.	Freq. [MHz]	Height [cm]	Azimuth [deg]	Level [dBm]	Limit [dBm]	Margin [dB]	Result	Polarity
1	55.3668	150	124	-70.37	-54.00	16.37	Pass	Horizontal
2	121.5241	150	134	-66.95	-36.00	30.95	Pass	Horizontal
3	540.003	150	163	-68.30	-54.00	14.30	Pass	Horizontal
4	1337.2337	150	211	-49.57	-30.00	19.57	Pass	Horizontal
5	4991.4197	150	197	-52.68	-30.00	22.68	Pass	Horizontal
6	9659.5164	150	124	-47.23	-30.00	17.23	Pass	Horizontal
7	36.8873	150	53	-62.84	-36.00	26.84	Pass	Vertical
8	184.3347	150	357	-67.78	-54.00	13.78	Pass	Vertical
9	540.003	150	348	-69.64	-54.00	15.64	Pass	Vertical
10	1309.831	150	169	-48.71	-30.00	18.71	Pass	Vertical
11	3198.1279	150	124	-49.80	-30.00	19.80	Pass	Vertical
12	9665.7566	150	308	-46.65	-30.00	16.65	Pass	Vertical

Mode:		BLE Transmitting						
Channel:		2480 MHz						
NO.	Freq. [MHz]	Height [cm]	Azimuth [deg]	Level [dBm]	Limit [dBm]	Margin [dB]	Result	Polarity
1	55.4638	150	292	-70.49	-54.00	16.49	Pass	Horizontal
2	180.018	150	320	-66.65	-54.00	12.65	Pass	Horizontal
3	540.003	150	163	-68.25	-54.00	14.25	Pass	Horizontal
4	1281.6282	150	153	-49.50	-30.00	19.50	Pass	Horizontal
5	5004.2902	150	87	-53.90	-30.00	23.90	Pass	Horizontal
6	9670.0468	150	354	-46.83	-30.00	16.83	Pass	Horizontal
7	50.6135	150	158	-66.86	-54.00	12.86	Pass	Vertical
8	178.1264	150	357	-68.22	-54.00	14.22	Pass	Vertical
9	540.003	150	348	-69.45	-54.00	15.45	Pass	Vertical
10	1297.0297	150	131	-49.02	-30.00	19.02	Pass	Vertical
11	3198.5179	150	122	-51.54	-30.00	21.54	Pass	Vertical
12	8996.4899	150	279	-46.23	-30.00	16.23	Pass	Vertical



## 2) Receiver spurious emissions test data

Remark: Through Pre-scan, BLE\_1M mode was the worst case, only the worst case was recorded in the report.

Mode:		BLE Receiving						
Channel:		2402 MHz						
NO.	Freq. [MHz]	Height [cm]	Azimuth [deg]	Level [dBm]	Limit [dBm]	Margin [dB]	Result	Polarity
1	37.4209	150	50	-70.38	-57.00	13.38	Pass	Horizontal
2	125.0163	150	209	-61.81	-57.00	4.81	Pass	Horizontal
3	540.003	150	139	-67.52	-57.00	10.52	Pass	Horizontal
4	1593.4047	150	152	-67.02	-47.00	20.02	Pass	Horizontal
5	5005.7753	150	109	-62.91	-47.00	15.91	Pass	Horizontal
6	9665.4708	150	78	-56.50	-47.00	9.50	Pass	Horizontal
7	37.1299	150	272	-63.67	-57.00	6.67	Pass	Vertical
8	184.2862	150	3	-67.16	-57.00	10.16	Pass	Vertical
9	399.7825	150	211	-66.44	-57.00	9.44	Pass	Vertical
10	2394.7947	150	305	-58.17	-47.00	11.17	Pass	Vertical
11	5760.163	150	197	-55.11	-47.00	8.11	Pass	Vertical
12	9606.1303	150	360	-56.56	-47.00	9.56	Pass	Vertical

Mode:		BLE Receiving						
Channel:		2480 MHz						
NO.	Freq. [MHz]	Height [cm]	Azimuth [deg]	Level [dBm]	Limit [dBm]	Margin [dB]	Result	Polarity
1	37.4694	150	211	-69.84	-57.00	12.84	Pass	Horizontal
2	125.0648	150	182	-62.12	-57.00	5.12	Pass	Horizontal
3	540.003	150	141	-66.54	-57.00	9.54	Pass	Horizontal
4	1599.28	150	182	-66.85	-47.00	19.85	Pass	Horizontal
5	2390.0945	150	194	-63.10	-47.00	16.10	Pass	Horizontal
6	9704.8352	150	211	-56.65	-47.00	9.65	Pass	Horizontal
7	37.0814	150	318	-63.91	-57.00	6.91	Pass	Vertical
8	184.2862	150	3	-67.18	-57.00	10.18	Pass	Vertical
9	750.0185	150	3	-67.16	-57.00	10.16	Pass	Vertical
10	1592.8171	150	232	-63.74	-47.00	16.74	Pass	Vertical
11	3188.5469	150	136	-61.60	-47.00	14.60	Pass	Vertical
12	5760.163	150	203	-55.32	-47.00	8.32	Pass	Vertical



**PHOTOGRAPHS OF TEST SETUP**

Test model No.: BeaglePlay



**Radiated spurious emission Test Setup-1(Below 1GHz)**

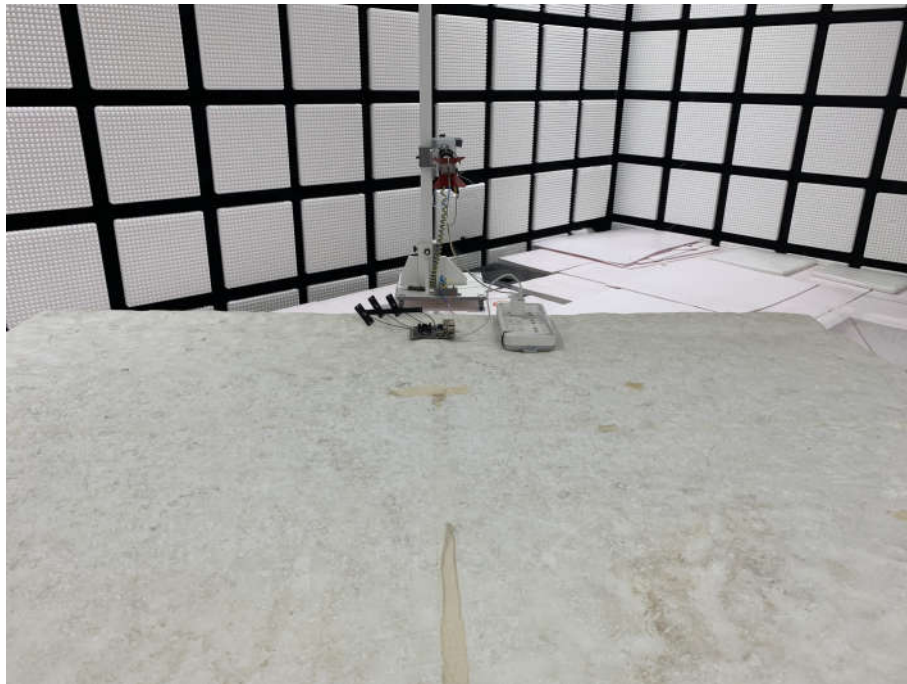

**Radiated spurious emission Test Setup-2(Above 1GHz)**

**PHOTOGRAPHS OF EUT Constructional Details**

Test model No.: BeaglePlay

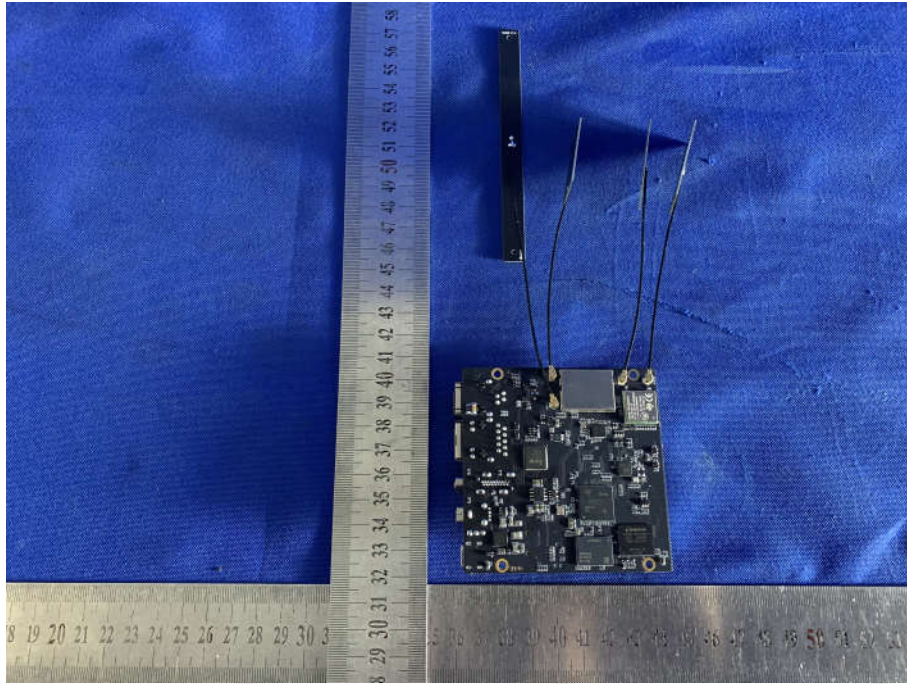

View of Product-1

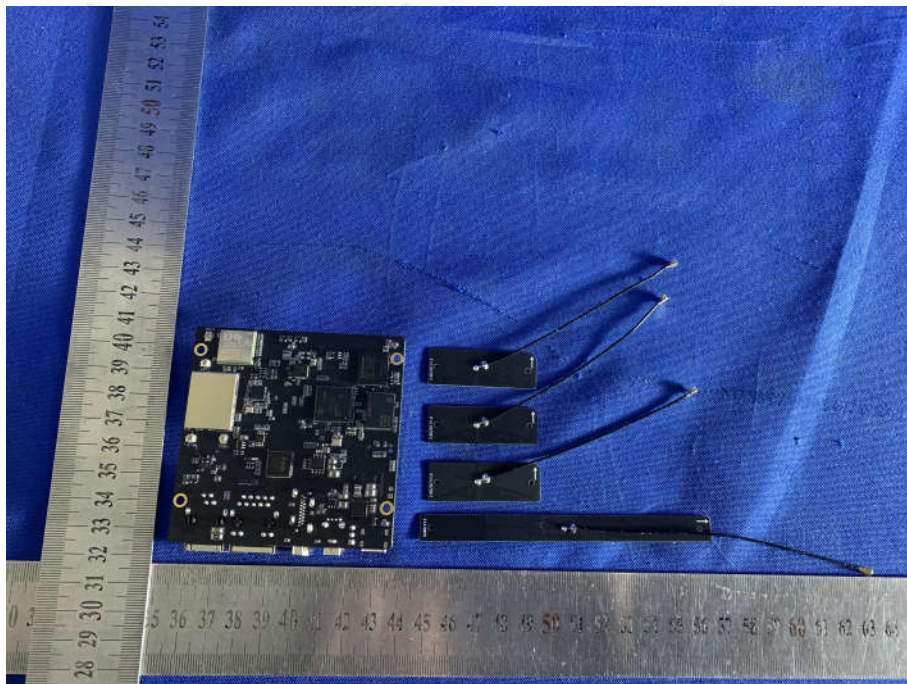

View of Product-2



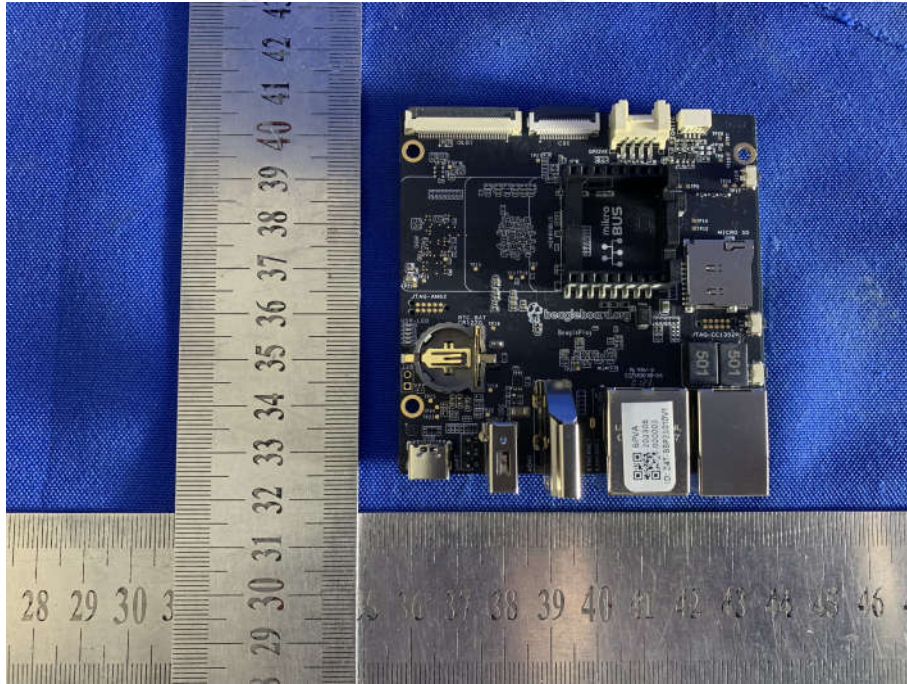

View of Product-3

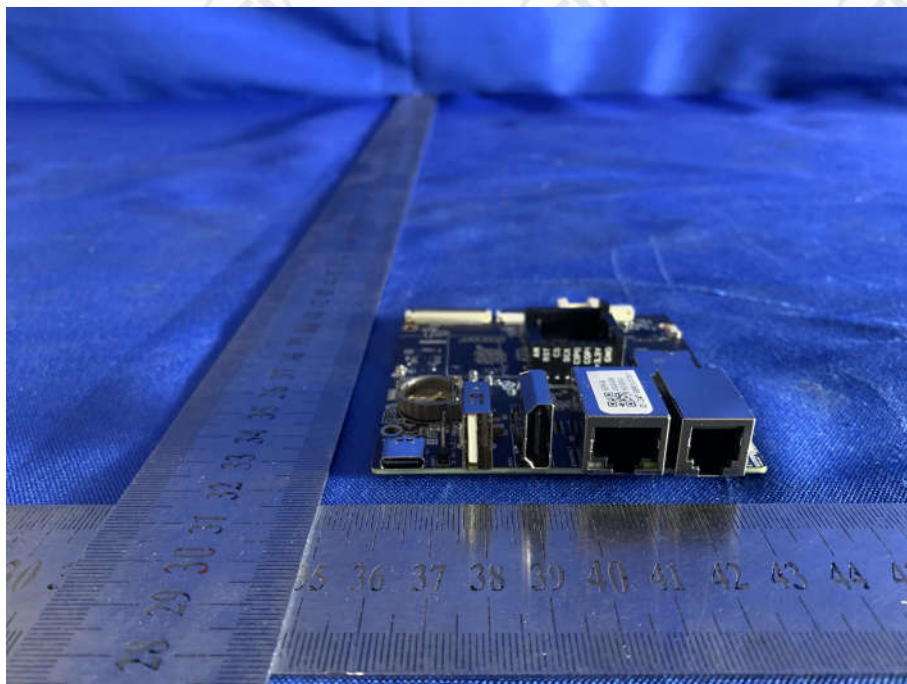

View of Product-4

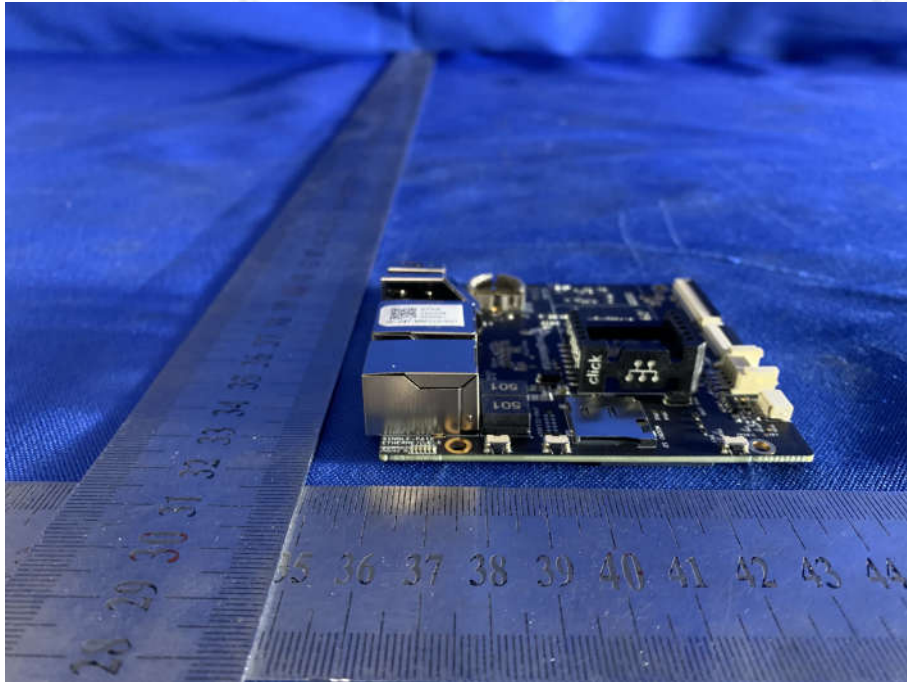

View of Product-5

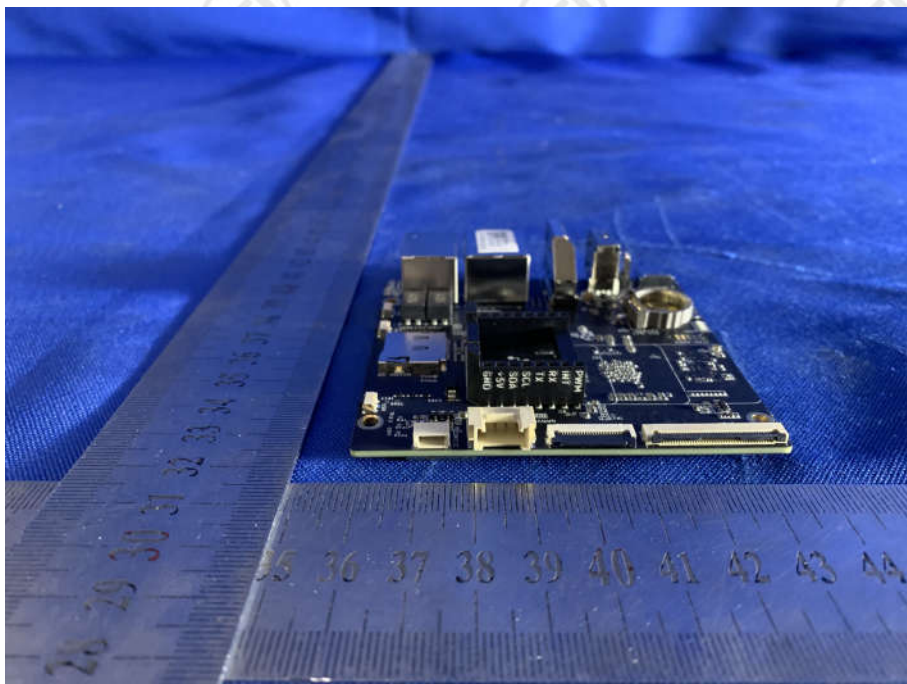

View of Product-6



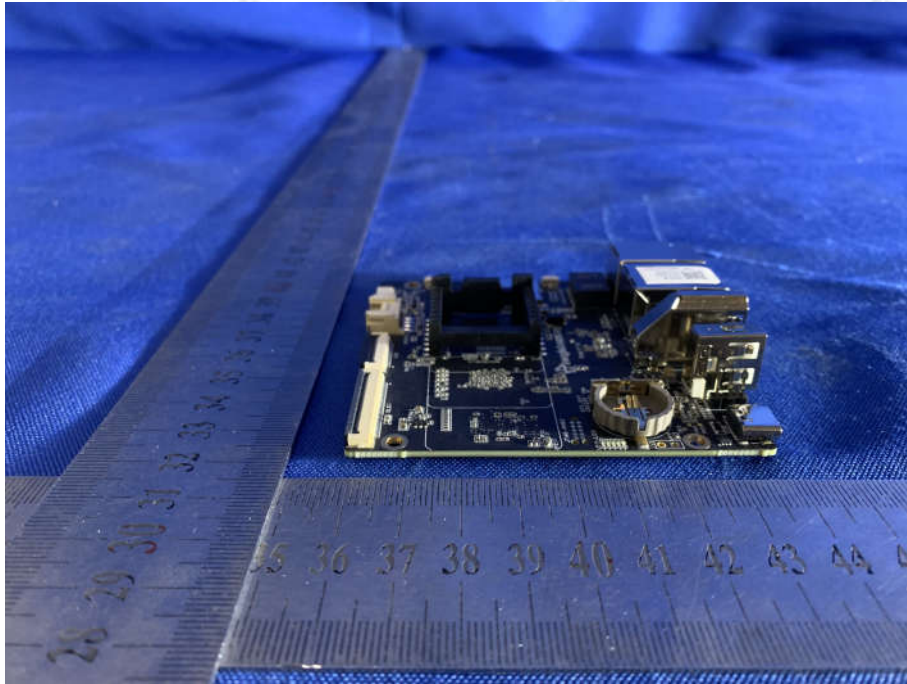

View of Product-7

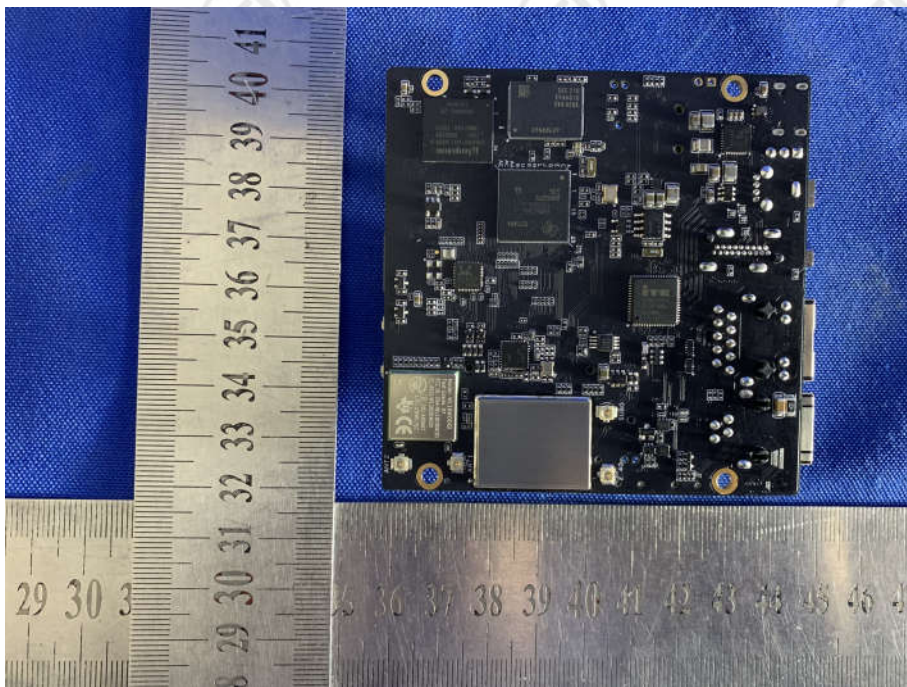

View of Product-8



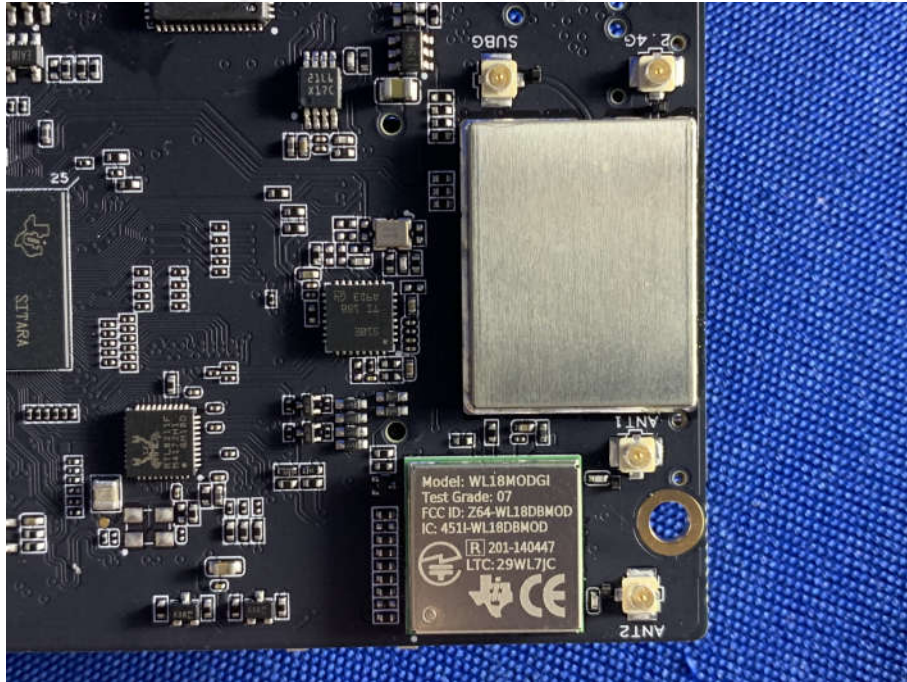

View of Product-9

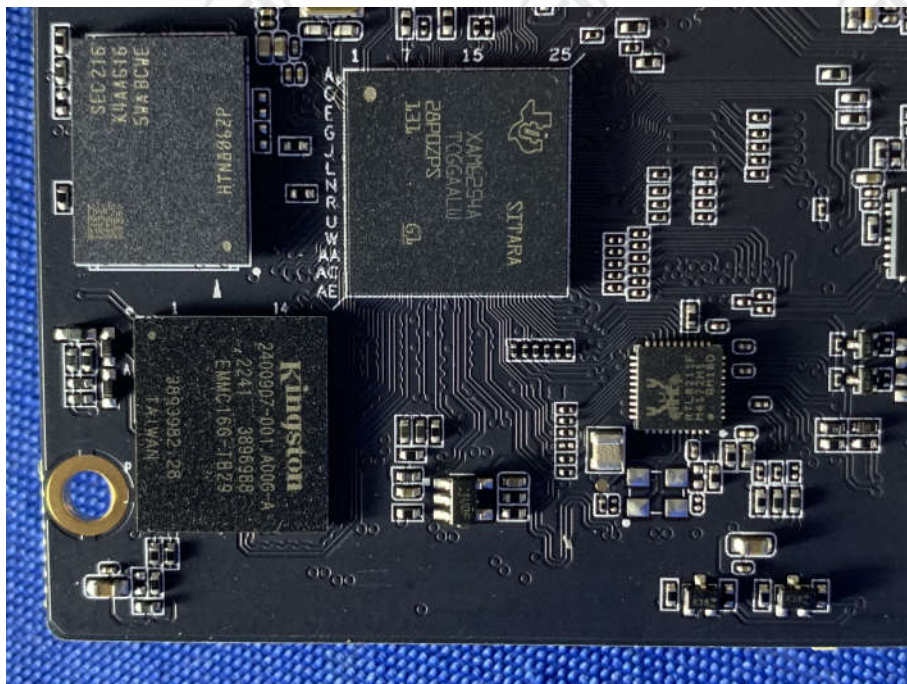

View of Product-10



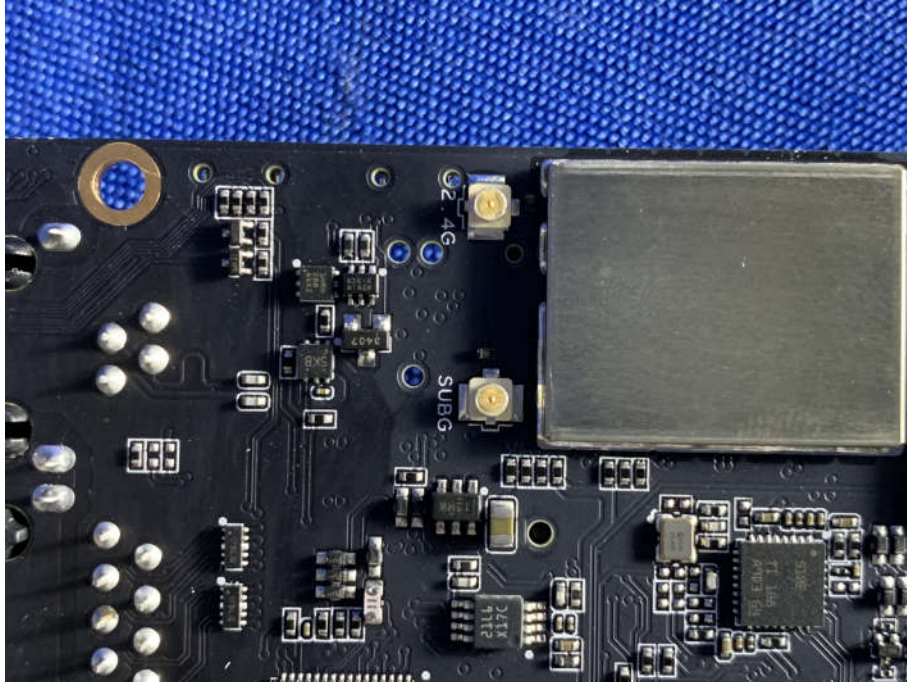

View of Product-11

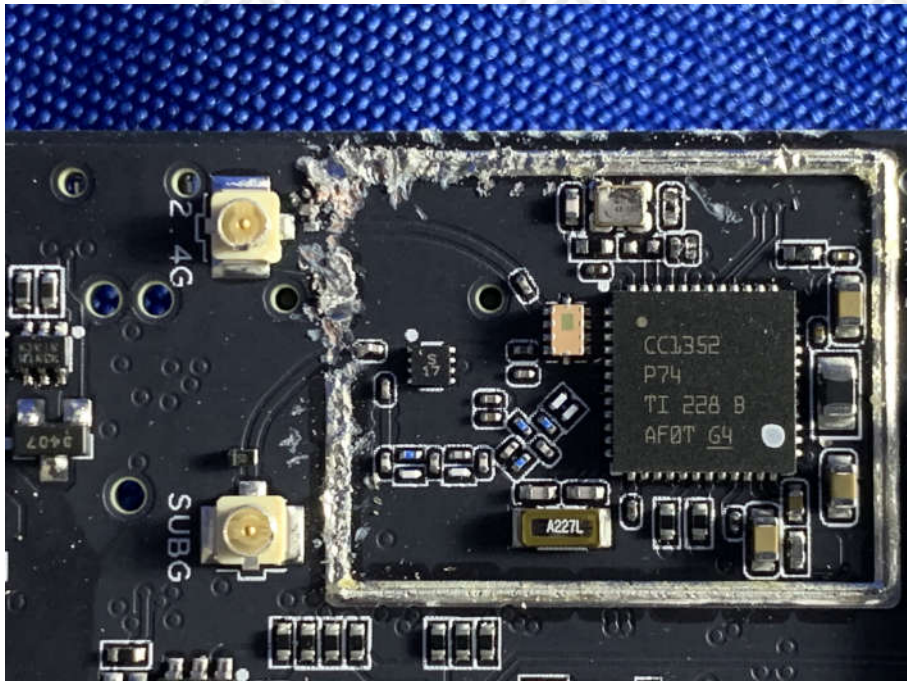

View of Product-12

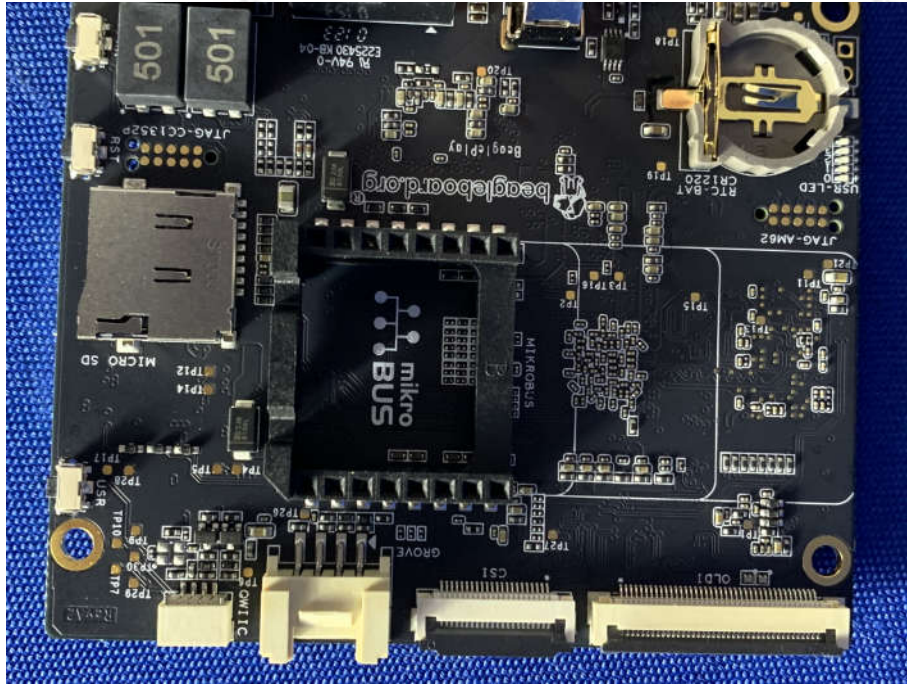

View of Product-13

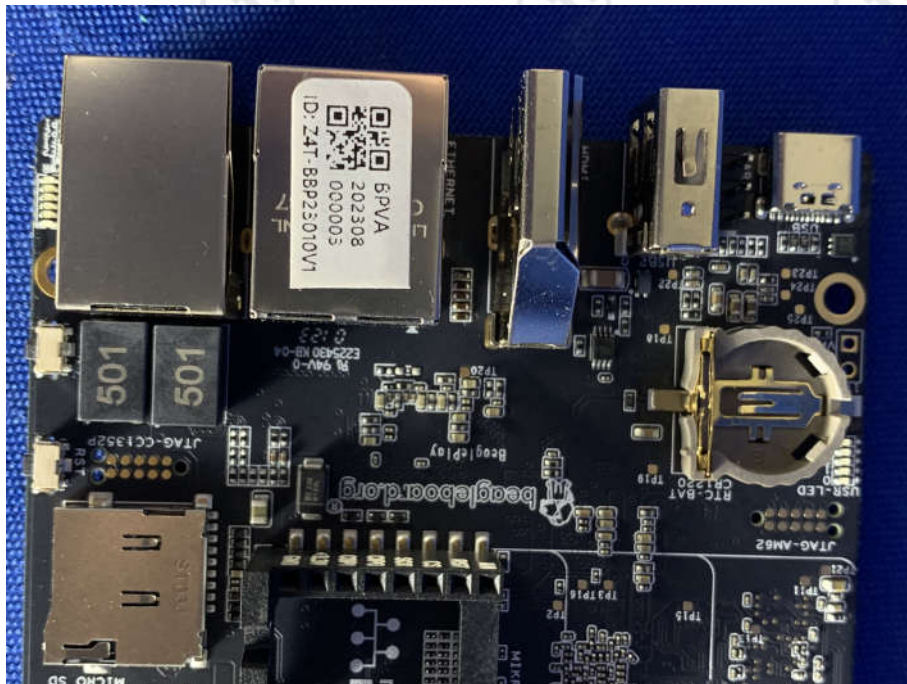

View of Product-14



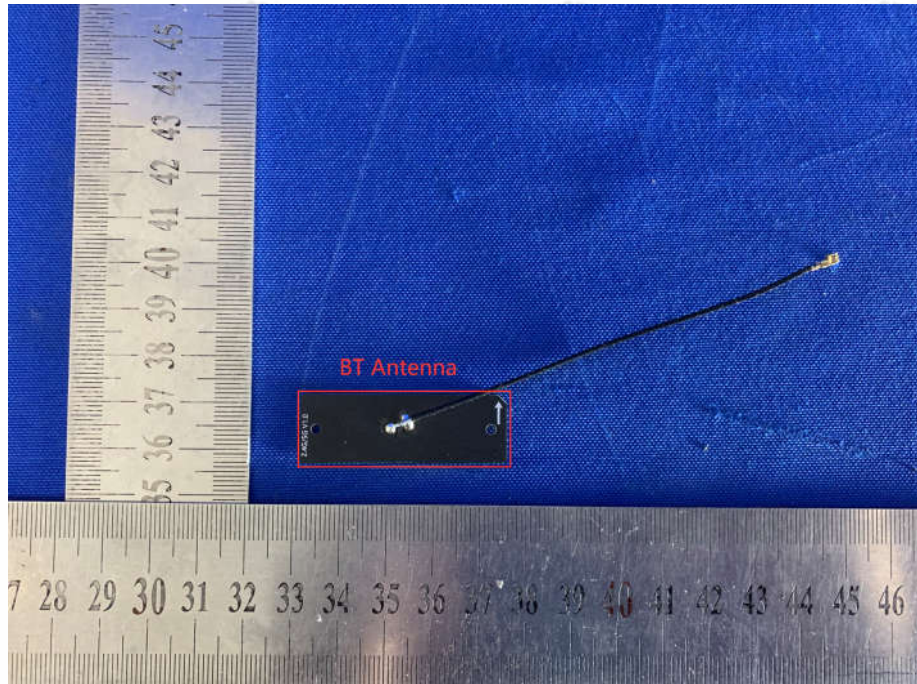

View of Product-15

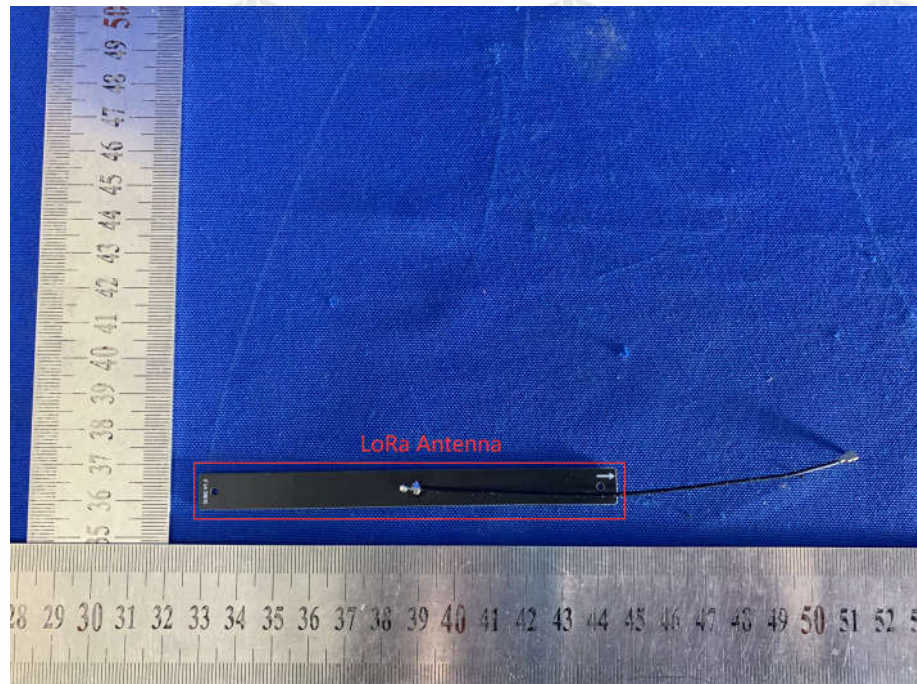

View of Product-16

The test report is effective only with both signature and specialized stamp, the result(s) shown in this report refer only to the sample(s) tested. Without written approval of CTI, this report can't be reproduced except in full.

\*\*\* End of Report \*\*\*

## TEST REPORT

**Product** : BeaglePlay  
**Trade mark** : Beagleboard.org  
**Model/Type reference** : BeaglePlay  
**Serial Number** : N/A  
**Report Number** : EED32P80002202  
**Date of Issue** : Feb. 22, 2023  
**Test Standards** : ETSI EN 300 220-1 V3.1.1 (2017-02)  
: ETSI EN 300 220-2 V3.2.1 (2018-06)  
**Test result** : PASS

Prepared for:

**Seed Technology Co., Ltd**  
9F, Building G3, TCL International E city, Zhongshanyuan Road,  
Nanshan, Shenzhen, China.

Prepared by:

**Centre Testing International Group Co., Ltd.**  
Hongwei Industrial Zone, Bao'an 70 District,  
Shenzhen, Guangdong, China  
**TEL: +86-755-3368 3668**  
**FAX: +86-755-3368 3385**

Compiled by:

*mark.chen.*

Mark Chen

Approved by:

*Aaron Ma*

Aaron Ma

Reviewed by:

*Tom Chen*

Tom Chen

Date:

Feb. 22, 2023

Check No.: 5404030123





## 1 Version

Version No.	Date	Description
00	Feb. 22, 2023	Original

## 2 Test Summary

<b>Radio Spectrum Matter (RSM) Part</b>				
<b>Test item</b>	<b>Test Requirement</b>	<b>Test Method</b>	<b>Limit</b>	<b>Result</b>
<b>Operating frequency</b>	EN 300 220-2 V3.2.1 (2017-02) Clause 4.2.1	EN 300 220-1 V3.1.1 (2017-02) Clause 5.1	Clause 4.2.1.2	PASS
<b>Effective Radiated Power</b>	EN 300 220-2 V3.2.1 (2017-02) Clause 4.3.1	EN 300 220-1 V3.1.1 (2017-02) Clause 5.2	Clause 4.3.1.2	PASS
<b>Maximum e.r.p. spectral density</b>	EN 300 220-2 V3.2.1 (2017-02) Clause 4.3.2	EN 300 220-1 V3.1.1 (2017-02) Clause 5.3	Clause 4.3.2.2	N/A
<b>Duty Cycle</b>	EN 300 220-2 V3.2.1 (2017-02) Clause 4.3.3	EN 300 220-1 V3.1.1 (2017-02) Clause 5.4	Clause 4.3.3.2	PASS
<b>Occupied Bandwidth</b>	EN 300 220-2 V3.2.1 (2017-02) Clause 4.3.4	EN 300 220-1 V3.1.1 (2017-02) Clause 5.6	Clause 4.3.4.2	PASS
<b>Tx Out of Band Emissions</b>	EN 300 220-2 V3.2.1 (2017-02) Clause 4.3.5	EN 300 220-1 V3.1.1 (2017-02) Clause 5.8	Clause 4.3.5.2	PASS
<b>Transient power</b>	EN 300 220-2 V3.2.1 (2017-02) Clause 4.3.6	EN 300 220-1 V3.1.1 (2017-02) Clause 5.10	Clause 4.3.6.2	PASS
<b>Adjacent Channel Power</b>	EN 300 220-2 V3.2.1 (2017-02) Clause 4.3.7	EN 300 220-1 V3.1.1 (2017-02) Clause 5.11	Clause 4.3.7.2	N/A
<b>TX behaviour under Low Voltage Conditions</b>	EN 300 220-2 V3.2.1 (2017-02) Clause 4.3.8	EN 300 220-1 V3.1.1 (2017-02) Clause 5.12	Clause 4.3.8.2	PASS
<b>Adaptive Power Control</b>	EN 300 220-2 V3.2.1 (2017-02) Clause 4.3.9	EN 300 220-1 V3.1.1 (2017-02) Clause 5.13	Clause 4.3.9.2	N/A
<b>Unwanted emissions in the spurious domain</b>	EN 300 220-2 V3.2.1 (2017-02) Clause 4.2.2	EN 300 220-1 V3.1.1 (2017-02) Clause 5.9	Clause 4.2.2.2	PASS
<b>Requirements for FHSS equipment</b>	EN 300 220-2 V3.2.1 (2017-02) Clause 4.3.10	EN 300 220-1 V3.1.1 (2017-02) Clause 4.3.10.3	Clause 4.3.10.2	N/A
<b>Short term behaviour</b>	EN 300 220-2 V3.2.1 (2017-02) Clause 4.3.11	EN 300 220-1 V3.1.1 (2017-02) Clause 5.5	Clause 4.3.11.2	N/A
<b>Clear Channel Assessment threshold</b>	EN 300 220-2 V3.2.1 (2017-02) Clause 4.5.2	EN 300 220-1 V3.1.1 (2017-02) Clause 5.21.2	Clause 4.5.2.2	N/A
<b>Polite spectrum access timing parameters</b>	EN 300 220-2 V3.2.1 (2017-02) Clause 4.5.3	EN 300 220-1 V3.1.1 (2017-02) Clause 5.21.3	Clause 4.5.3.2	N/A
<b>Adaptive Frequency Agility</b>	EN 300 220-2 V3.2.1 (2017-02) Clause 4.5.4	EN 300 220-1 V3.1.1 (2017-02) Clause 5.21.4	Clause 4.5.4.2	N/A
<b>RX sensitivity</b>	EN 300 220-2 V3.2.1 (2017-02) Clause 4.4.1	EN 300 220-1 V3.1.1 (2017-02) Clause 5.14	Clause 4.4.1.2	N/A
<b>Blocking</b>	EN 300 220-2 V3.2.1 (2017-02) Clause 4.4.2	EN 300 220-1 V3.1.1 (2017-02) Clause 5.18	Clause 4.4.2.2	PASS

## 3 Contents

	Page
<b>1 VERSION</b> .....	<b>2</b>
<b>2 TEST SUMMARY</b> .....	<b>3</b>
<b>3 CONTENTS</b> .....	<b>4</b>
<b>4 GENERAL INFORMATION</b> .....	<b>5</b>
4.1 CLIENT INFORMATION.....	5
4.2 GENERAL DESCRIPTION OF EUT.....	5
4.3 PRODUCT SPECIFICATION SUBJECTIVE TO THIS STANDARD.....	5
4.4 OTHER INFORMATION.....	6
4.5 DESCRIPTION OF SUPPORT UNITS.....	7
4.6 TEST LOCATION.....	7
4.7 DEVIATION FROM STANDARDS.....	7
4.8 ABNORMALITIES FROM STANDARD CONDITIONS.....	7
4.9 OTHER INFORMATION REQUESTED BY THE CUSTOMER.....	7
4.10 MEASUREMENT UNCERTAINTY (95% CONFIDENCE LEVELS, K=2).....	7
<b>5 EQUIPMENT LIST</b> .....	<b>8</b>
<b>6 RADIO TECHNICAL REQUIREMENTS SPECIFICATION IN EN 300 220-2</b> .....	<b>10</b>
6.1 TRANSMITTER REQUIREMENTS.....	10
6.1.1 <i>Operating frequency</i> .....	10
6.1.2 <i>Effective Radiated Power</i> .....	11
6.1.3 <i>Maximum e.r.p. spectral density</i> .....	13
6.1.4 <i>Duty Cycle</i> .....	14
6.1.5 <i>Occupied Bandwidth</i> .....	15
6.1.6 <i>Tx Out of Band Emissions</i> .....	17
6.1.7 <i>Transient Power</i> .....	20
6.1.8 <i>Adjacent Channel Power</i> .....	22
6.1.9 <i>TX behaviour under Low Voltage Conditions</i> .....	23
6.1.10 <i>Adaptive Power Control</i> .....	24
6.1.11 <i>FHSS equipment</i> .....	24
6.1.12 <i>Spurious Emissions</i> .....	25
6.1.13 <i>Short term behaviour</i> .....	28
6.2 RECEIVER REQUIREMENTS.....	29
6.2.1 <i>RX sensitivity</i> .....	29
6.2.2 <i>Blocking</i> .....	30
6.3 POLITE SPECTRUM ACCESS CONFORMANCE REQUIREMENT.....	31
6.3.1 <i>Clear Channel Assessment threshold</i> .....	31
6.3.2 <i>Polite spectrum access timing parameters</i> .....	31
6.3.3 <i>Adaptive Frequency Agility</i> .....	31
<b>APPENDIX 1 PHOTOGRAPHS OF TEST SETUP</b> .....	<b>32</b>
<b>APPENDIX 2 PHOTOGRAPHS OF EUT CONSTRUCTIONAL DETAILS</b> .....	<b>33</b>

## 4 General Information

### 4.1 Client Information

Applicant:	Seeed Technology Co., Ltd
Address of Applicant:	9F, Building G3, TCL International E city, Zhongshanyuan Road, Nanshan, Shenzhen, China.
Manufacturer:	Seeed Technology Co., Ltd
Address of Manufacturer:	9F, Building G3, TCL International E city, Zhongshanyuan Road, Nanshan, Shenzhen, China.
Factory:	Shenzhen Xinxian Technology Co., Limited
Address of Factory:	F5, Building B17, Hengfeng Industrial City, No. 739 Zhoushi Rd, Baoan District, Shenzhen, Guangdong, P.R.C.

### 4.2 General Description of EUT

Product Name:	BeaglePlay
Model No.:	BeaglePlay
Trade Mark:	Beagleboard.org
EUT Supports Radios application:	863MHz to 870MHz
Test Software of EUT:	Setup_SmartRF_Studio_7
Test Voltage	DC 5V
Power Supply:	DC 5V

### 4.3 Product Specification subjective to this standard

Nominal Frequency:	863MHz to 870MHz
Modulation Technique:	LORA Chirp Spread Spectrum
Number of Channels:	1
Sample Type:	Fixed-Use
Transmitter Operating channel width(OCW):	100kHz
Antenna Type:	PCB Antenna
Antenna gain:	1.0 dBi
Test Voltage	DC 5V



## 4.4 Other Information

RED Directive:	2014/53/EU
Sample Received Date:	Jan. 03, 2023
Sample tested Date:	Jan. 03, 2023 to Feb. 16, 2023

Operation Frequency each of channel					
Channel	Frequency	Channel	Frequency	Channel	Frequency
1	868.3MHz	/	/	/	/

## 4.5 Description of Support Units

The EUT has been tested with associated equipment below.

Description	Manufacturer	Model No.	Certification	Supplied by
Netbook	DELL	Latitude 3490	FCC & CE	CTI

## 4.6 Test Location

All tests were performed at:

Centre Testing International Group Co., Ltd.

Hongwei Industrial Zone, Bao' an 70 District, Shenzhen, Guangdong, China 518101

Telephone: +86 (0) 755 3368 3668 Fax:+86 (0) 755 3368 3385

No tests were sub-contracted.

## 4.7 Deviation from Standards

None.

## 4.8 Abnormalities from Standard Conditions

None.

## 4.9 Other Information Requested by the Customer

None.

## 4.10 Measurement Uncertainty (95% confidence levels, k=2)

No.	Item	Measurement Uncertainty
1	Radio Frequency	$7.9 \times 10^{-8}$
2	RF power, conducted	0.46dB(30MHz-1GHz)
		0.55dB(1GHz-18GHz)
3	Adjacent channel power	1.52dB
4	Occupied BandWidth	4%
5	Radiated Spurious emission test	4.3dB (30MHz-1GHz)
		4.5dB (1GHz-12.75GHz)
6	Conducted spurious emission	0.46dB(30MHz-1GHz)
		0.55dB(1GHz-18GHz)
7	Temperature test	0.64°C
8	Humidity test	3.8%
9	DC power voltages	0.026%
10	AC and low frequency voltages test(< 10 kHz)	1.2%

## 5 Equipment List

RF test system					
Equipment	Manufacturer	Mode No.	Serial Number	Cal. Date (mm-dd-yyyy)	Cal. Due date (mm-dd-yyyy)
Communication tset set	R&S	CMW500	107929	07-06-2022	07-05-2023
Signal Generator	R&S	SMBV100A	1407.6004K02- 262149-CV	09-09-2022	09-08-2023
Spectrum Analyzer	R&S	FSV40	101200	08-01-2022	07-31-2023
RF control unit(power unit)	MWRF-test	MW100-RFCB	MW220620CTI-42	07-06-2022	07-05-2023
high-low temperature test chamber	Dong Guang Qin Zhuo	LK-80GA	QZ20150611879	12-19-2022	12-18-2023
Temperature/ Humidity Indicator	biaozhi	HM10	1804186	06-16-2022	06-15-2023
BT&WI-FI Automatic test software	MWRF-test	MTS 8310	2.0.0.0	---	---

3M full-anechoic Chamber					
Equipment	Manufacturer	Model No.	Serial Number	Cal. Date (mm-dd-yyyy)	Cal. Due date (mm-dd-yyyy)
RSE Automatic test software	JS Tonscend	JS36-RSE	10166	---	---
Receiver	Keysight	N9038A	MY57290136	03-01-2022	02-28-2023
Spectrum Analyzer	Keysight	N9020B	MY57111112	03-01-2022	02-28-2023
Spectrum Analyzer	Keysight	N9030B	MY57140871	03-01-2022	02-28-2023
TRILOG Broadband Antenna	Schwarzbeck	VULB 9163	9163-1148	04-28-2021	04-27-2024
Horn Antenna	Schwarzbeck	BBHA 9170	9170-832	04-15-2021	04-14-2024
Horn Antenna	ETS-LINDGREN	3117	57407	07-04-2021	07-03-2024
Preamplifier	EMCI	EMC184055SE	980597	04-20-2022	04-19-2023
Preamplifier	EMCI	EMC001330	980563	04-13-2022	04-12-2023
Preamplifier	JS Tonscend	TAP-011858	AP21B806112	07-29-2022	07-28-2023
Communication test set	R&S	CMW500	102898	12-23-2022	12-22-2023
Temperature/Humidity Indicator	biaozhi	GM1360	EE1186631	02-21-2022	02-20-2023
Fully Anechoic Chamber	TDK	FAC-3	---	01-09-2021	01-08-2024
Cable line	Times	SFT205-NMSM-2.50M	394812-0001	---	---
Cable line	Times	SFT205-NMSM-2.50M	394812-0002	---	---
Cable line	Times	SFT205-NMSM-2.50M	394812-0003	---	---
Cable line	Times	SFT205-NMSM-2.50M	393495-0001	---	---
Cable line	Times	EMC104-NMNM-1000	SN160710	---	---
Cable line	Times	SFT205-NMSM-3.00M	394813-0001	---	---
Cable line	Times	SFT205-NMNM-1.50M	381964-0001	---	---
Cable line	Times	SFT205-NMSM-7.00M	394815-0001	---	---
Cable line	Times	HF160-KMKM-3.00M	393493-0001	---	---



## 6 Radio Technical Requirements Specification in EN 300 220-2

### 6.1 Transmitter Requirements

The Tx was a OCW > 25 kHz modulation by internal signal, test device does not belong to the FHSS and Polite spectrum access, no voice application and with integral antenna.

#### 6.1.1 Operating frequency

**Test Method:** EN 300 220-2 Clause 4.2.1

**Test Requirement:** EN 300 220-1 Clause 5.1

**Limit:** The manufacturer may declare either one or more operating frequencies and operating channels.

Operating channel(s) shall be entirely within operational frequency bands allowed.

**Result:** PASS

#### Declaration value:

Item	Declared value by the manufacturer	Result
Operational Frequency band or bands	863MHz to 870MHz	PASS
Operating Channel width(OCW)	100kHz	PASS

## 6.1.2 Effective Radiated Power

**Test Method:** EN 300 220-1 Clause 5.2  
**Test Requirement:** EN 300 220-2 Clause 4.3.1  
**EUT Operation:**  
**Ambient:** Temp.: 23°C Humid.: 54% Press.: 1010 mbar  
**Test Status:** Keep the EUT transmitting continuous modulation signal.

### Test Setup:

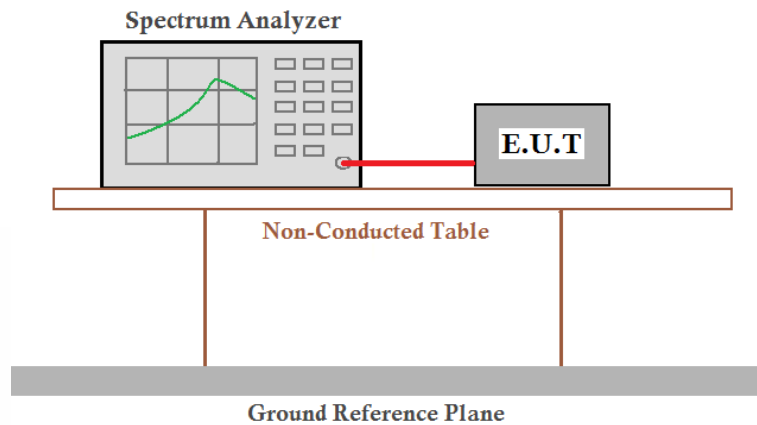

**Equipment Used:** Refer to section 5 for details.  
**Limit:** EN 300 220-2 annexe B or C  
**Test result:** PASS

**Test Data:**

Measurement Conditions ( Normal & Extreme)		Operation Frequency	ERP (dBm)	Limit (dBm)	Result
T <sub>normal</sub> (23°C)	V <sub>norm</sub> : 5.0V dc	868.3MHz	12.92	14	PASS
	V <sub>max</sub> : 5.5V dc		12.87	14	PASS
T <sub>upper</sub> (+60°C)	V <sub>min</sub> : 4.75V dc		12.91	14	PASS
	V <sub>max</sub> : 5.5V dc		12.24	14	PASS
T <sub>lower</sub> (0°C)	V <sub>min</sub> : 4.75V dc		12.56	14	PASS

Remark: ERP= Test power + maximum gain of the antenna

## 6.1.3 Maximum e.r.p. spectral density

**Test Method:** EN 300 220-1 Clause 5.3  
**Test Requirement:** EN 300 220-2 Clause 4.3.2

**Test Results:** Not applicable, since the test applied to EN300220-2 annex B bands I, L, and DSSS or wideband techniques other than FHSS modulation, using EN300220-2 annex C band X.



## 6.1.4 Duty Cycle

**Test Method:** EN 300 220-1 Clause 5.4  
**Test Requirement:** EN 300 220-2 Clause 4.3.3  
**EUT Operation:**  
**Ambient:** Temp.: 23°C Humid.: 54% Press.: 1010 mbar  
**Test Status:** Let EUT normal transmit at 863-870MHz Carrier Frequency.

### Test Setup:

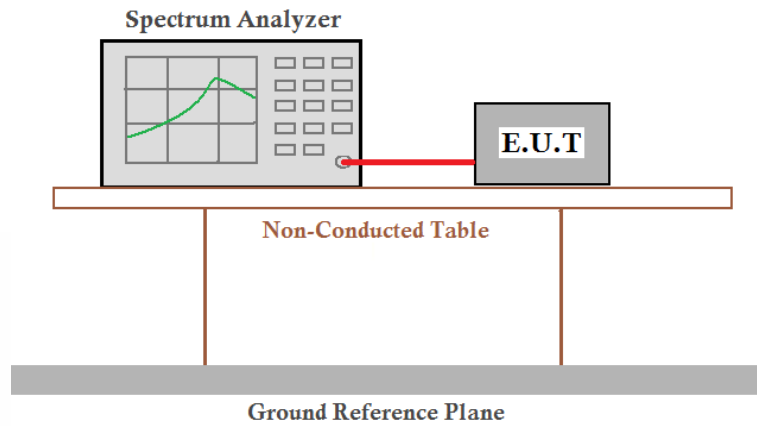

**Equipment Used:** Refer to section 5 for details.  
**Limit:** EN 300 220-2 annexe B or C  
**Test result:** PASS

### Test Data:

Operation Frequency	Duty Cycle	Limit	Result
863MHz to 870MHz	<1 %(provider declaration)	≤ 1 %	PASS

## 6.1.5 Occupied Bandwidth

**Test Method:** EN 300 220-1 Clause 5.6

**Test Requirement:** EN 300 220-2 Clause 4.3.4

**EUT Operation:**

**Ambient:** Temp.: 23°C Humid.: 54% Press.: 1010 mbar

**Test Status:** Keep the EUT transmitting continuous modulation signal.

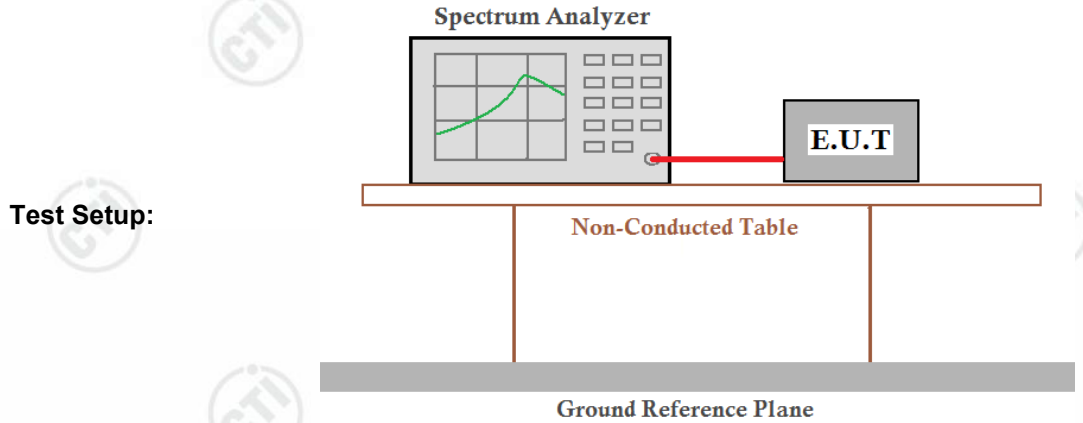

**Equipment Used:** Refer to section 5 for details.

**Limit:** EN 300 220-2 annexe B or C

**Test result:** PASS

**Test Data:**

Measurement Conditions ( Normal & Extreme)		Operation Frequency	Test Value (kHz)	Limit (MHz)	Result
T <sub>normal</sub> (23°C)	V <sub>norm</sub> : 5.0V dc	868.3MHz	91.61	3	PASS
T <sub>upper</sub> (+60°C)	V <sub>max</sub> : 5.5V dc		91.61	3	PASS
	V <sub>min</sub> : 4.75V dc		94.65	3	PASS
T <sub>lower</sub> (0°C)	V <sub>max</sub> : 5.5V dc		93.78	3	PASS
	V <sub>min</sub> : 4.75V dc		92.48	3	PASS

## 6.1.6 Tx Out of Band Emissions

**Test Method:** EN 300 220-1 Clause 5.8

**Test Requirement:** EN 300 220-2 Clause 4.3.5

**EUT Operation:**

**Ambient:** Temp.: 23°C Humid.: 54% Press.: 1010 mbar

**Test Status:** Keep the EUT transmitting continuous modulation signal.

### Test Setup:

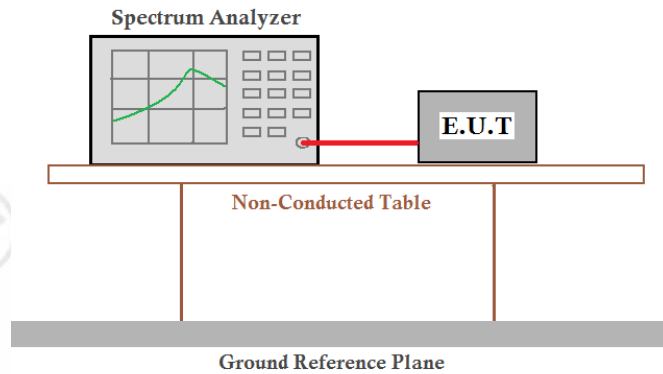

**Equipment Used:** Refer to section 5 for details.

**Limit:**

### Emission limits in the Out Of Band domains

Domain	Frequency Range	Max power limit
OOB limits applicable to Operational Frequency Band (See Figure 6)	$f \leq f_{\text{low\_OFB}} - 400 \text{ kHz}$	-36 dBm
	$F_{\text{low\_OFB}} - 400 \text{ kHz} \leq f \leq f_{\text{low\_OFB}} - 200 \text{ kHz}$	-36 dBm
	$f_{\text{low}} - 200 \text{ kHz} \leq f < f_{\text{low\_OFB}}$	See Figure 6
	$f = f_{\text{low\_OFB}}$	0 dBm
	$f = f_{\text{high\_OFB}}$	0 dBm
	$F_{\text{high\_OFB}} < f \leq f_{\text{high\_OFB}} + 200 \text{ kHz}$	See Figure 6
	$F_{\text{high\_OFB}} + 200 \text{ kHz} \leq f \leq f_{\text{high\_OFB}} + 400 \text{ kHz}$	-36 dBm
	$F_{\text{high\_OFB}} + 400 \text{ kHz} \leq f$	-36 dBm
OOB limits applicable to Operating Channel (See Figure 5)	$f = f_c - 2.5 \times \text{OCW}$	-36 dBm
	$f_c - 2.5 \times \text{OCW} \leq f \leq f_c - 0.5 \times \text{OCW}$	See Figure 5
	$f = f_c - 0.5 \times \text{OCW}$	0 dBm
	$f = f_c + 0.5 \times \text{OCW}$	0 dBm
	$f_c + 0.5 \times \text{OCW} \leq f \leq f_c + 2.5 \times \text{OCW}$	See Figure 5
	$f = f_c + 2.5 \times \text{OCW}$	-36 dBm
<p>NOTE: <math>f</math> is the measurement frequency.  <math>f_c</math> is the Operating Frequency.  <math>F_{\text{low\_OFB}}</math> is the lower edge of the Operational Frequency Band.  <math>F_{\text{high\_OFB}}</math> is the upper edge of the Operational Frequency Band.  OCW is the operating channel bandwidth.</p>		



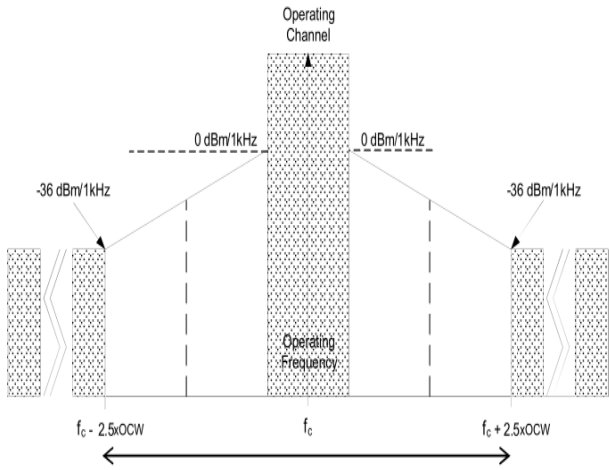

Figure 5: Out Of Band Domain for Operating Channel with reference BW

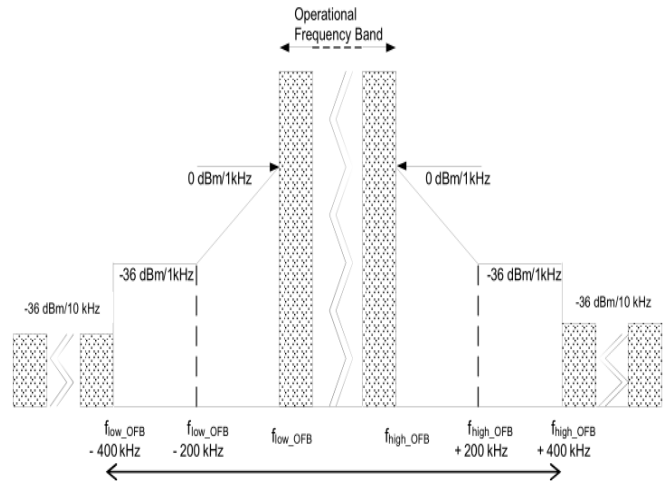

Figure 6: Out Of Band Domain for Operational Frequency Band with reference BW

**Test result:** PASS

**Test Data:**

**Figure 5:**

Measurement Conditions ( Normal & Extreme)		Operation Channel	Frequency	Test Value	Limit	Result
T <sub>normal</sub> (23°C)	V <sub>norm</sub> : 5.0V dc	868.3MHz	868.26740	-2.63	0 dBm	PASS
T <sub>upper</sub> (+60°C)	V <sub>max</sub> : 5.5V dc		868.26740	-2.66	0 dBm	PASS
	V <sub>min</sub> : 4.75V dc		868.26740	-2.69	0 dBm	PASS
T <sub>lower</sub> (0°C)	V <sub>max</sub> : 5.5V dc		868.26740	-2.60	0 dBm	PASS
	V <sub>min</sub> : 4.75V dc		868.31740	-2.77	0 dBm	PASS

**Figure 6:**

Measurement Conditions ( Normal & Extreme)		Operation Channel	Frequency	Test Value	Limit	Result
T <sub>normal</sub> (23°C)	V <sub>norm</sub> : 5.0V dc	868.3MHz	868.26700	-4.02	0 dBm	PASS
T <sub>upper</sub> (+60°C)	V <sub>max</sub> : 5.5V dc		868.31740	-4.06	0 dBm	PASS
	V <sub>min</sub> : 4.75V dc		868.31740	-4.08	0 dBm	PASS
T <sub>lower</sub> (0°C)	V <sub>max</sub> : 5.5V dc		868.31740	-4.11	0 dBm	PASS
	V <sub>min</sub> : 4.75V dc		868.31740	-4.18	0 dBm	PASS

## 6.1.7 Transient Power

**Test Method:** EN 300 220-1 Clause 5.10  
**Test Requirement:** EN 300 220-2 Clause 4.3.6  
**EUT Operation:**  
**Ambient:** Temp.: 23°C Humid.: 54% Press.: 1010 mbar  
**Test Status:** Keep the EUT transmitting continuous modulation signal

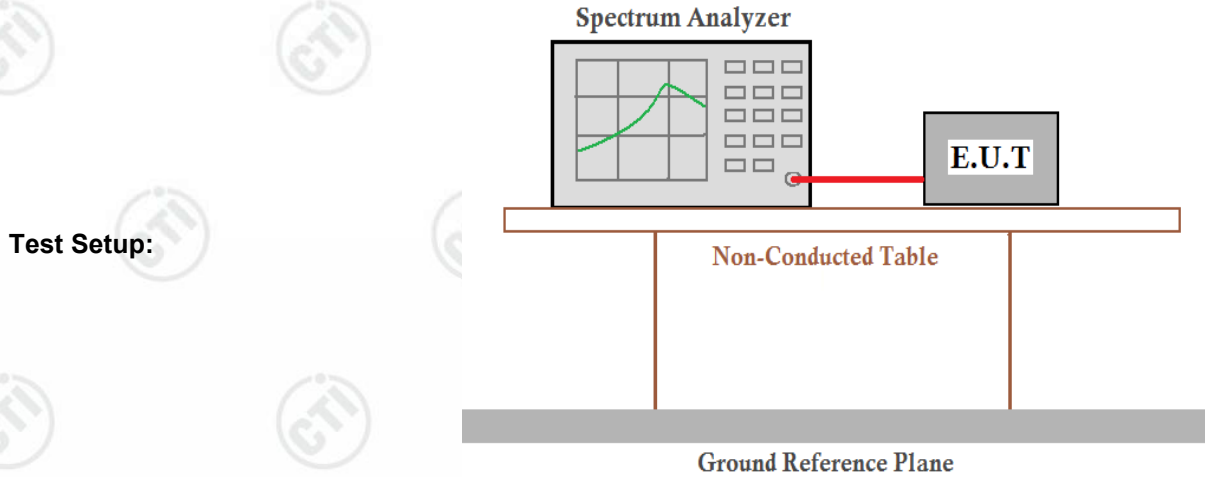

**Equipment Used:** Refer to section 5 for details.

**Limit:**

Absolute offset from centre frequency	RBW <sub>REF</sub>	Peak power limit applicable at measurement points
≤ 400 kHz	1 kHz	0 dBm
> 400 kHz	1 kHz	-27 dBm

**Test result:** PASS

**Test Data:**

868.3MHz							
Measurement frequency(MHz)	Frequency offset (kHz)	RBW (kHz)	RBW <sub>REF</sub> (kHz)	Measured level in RBW (dBm)	Power in RBWREF (dBm)	Limite (dBm)	Result
868.6625	-0.5xOCW-1200	300	1	-50.86	-48.63	0	PASS
867.9375	-0.5xOCW-400	100	1	-48.85	-49.31	0	PASS
868.2375	-OCW	10	1	-5.33	-16.09	0	PASS
868.3625	-0.5xOCW-3	1	1	-15.14	-30.91	0	PASS
868.7625	+0.5xOCW+3	1	1	-28.49	-61.03	-27	PASS
867.835	+OCW	10	1	-32.67	-59.78	-27	PASS
869.5625	+0.5xOCW+400	100	1	-33.06	-68.83	-27	PASS
867.0375	+0.5xOCW+1200	300	1	-37.95	-68.27	-27	PASS



## 6.1.8 Adjacent Channel Power

<b>Test Method:</b>	EN 300 220-1 Clause 5.11
<b>Test Requirement:</b>	EN 300 220-2 Clause 4.3.7
<b>Test Results:</b>	Not applicable, since the test applied to EUT with OCW $\leq$ 25 kHz.

## 6.1.9 TX behaviour under Low Voltage Conditions

**Test Method:** EN 300 220-1 Clause 5.12

**Test Requirement:** EN 300 220-2 Clause 4.3.8

**EUT Operation:**

**Ambient:** Temp.: 23°C Humid.: 54% Press.: 1010 mbar

**Test Status:** Keep the EUT transmitting continuous modulation signal.

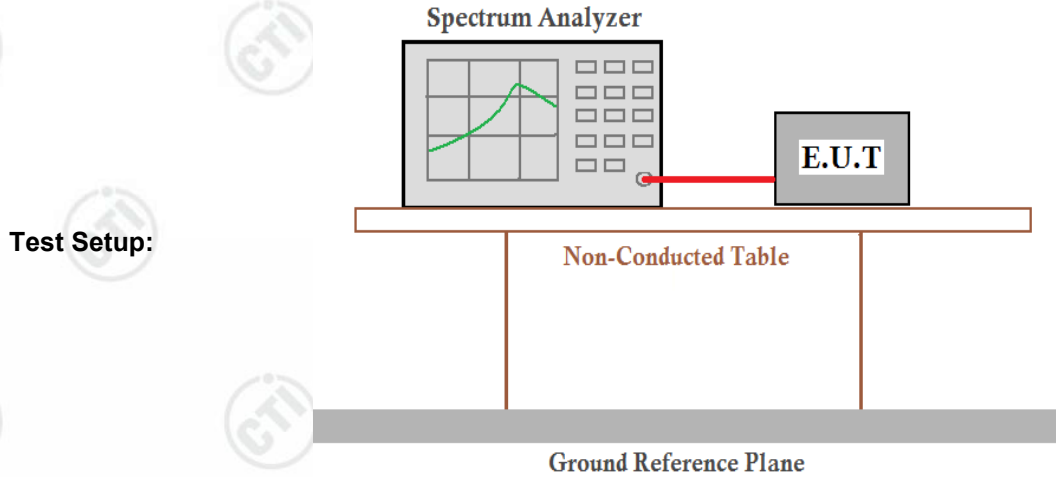

**Equipment Used:** Refer to section 5 for details.

- Limit:**
- remain in the Operating Channel OC without exceeding any applicable limits (e.g. Duty Cycle); or
  - reduce its effective radiated power below the Spurious Emission limits without exceeding any applicable limits(e.g. Duty Cycle); or
  - shut down, (ceasing function);

**Test result:** PASS

**Test Data:**

**Nominal Frequency was: 867.1MHz**

Test Voltage (V)	$V_{norm}$ : 5.0V dc	$V_{max}$ : 5.5V dc	$V_{min}$ : 4.75V dc	Limit	Result
Fundamental Frequency	868.26740MHz	868.26740MHz	868.26740MHz	863MHz to 870MHz or below -36dBm	PASS
Effective Radiated Power	12.92dBm	12.87dBm	12.91dBm	14dBm	PASS
Occupied Bandwidth	91.61kHz	91.61kHz	94.65kHz	3MHz	PASS

**Remark:**

- The EUT would not operate below a voltage of 4.75V dc
- Applied test voltage: reduced from 4.75V to 5.5V DC
- ERP= Test power + maximum gain of the antenna

## 6.1.10 Adaptive Power Control

**Test Method:** EN 300 220-1 Clause 5.13

**Test Requirement:** EN 300 220-2 Clause 4.3.9

**Test Results:** Not applicable, since the test applied to EUT with adaptive power control using EN 300 220-2 annex C band AA.

## 6.1.11 FHSS equipment

**Test Method:** EN 300 220-2 Clause 4.3.10

**Test Requirement:** EN 300 220-2 Clause 4.3.10

**Test Results:** Not applicable, since the test applied to all FHSS equipment

## 6.1.12 Spurious Emissions

### Radiated measurement

**Test Method:** EN 300 220-1 Clause 5.9

**Test Requirement:** EN 300 220-2 Clause 4.2.2

### EUT Operation:

**Ambient:** Temp.: 23°C

Humid.: 54%

Press.: 1010 mbar

**Test Status:** Keep the EUT transmitting continuous modulation signal

### Test Setup:

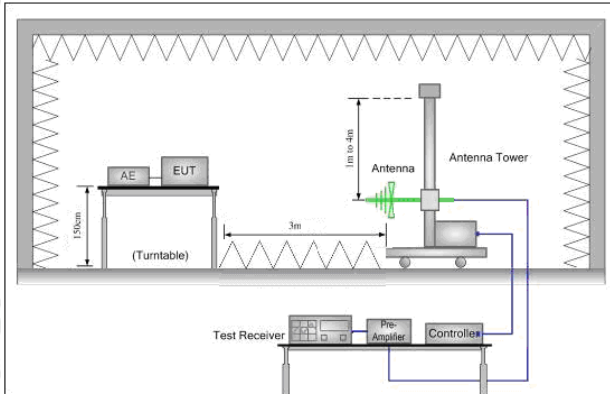

Figure 1. 25MHz to 1GHz

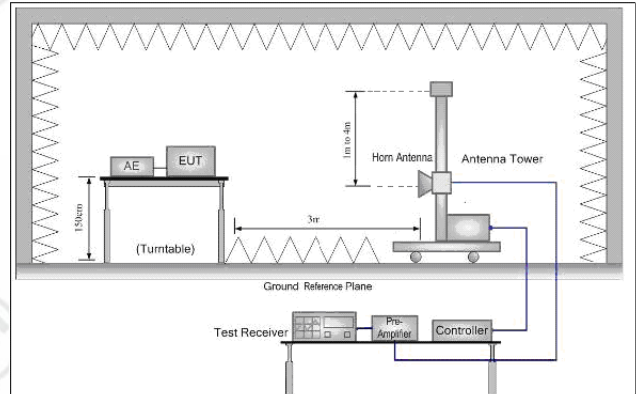

Figure 2. Above 1GHz

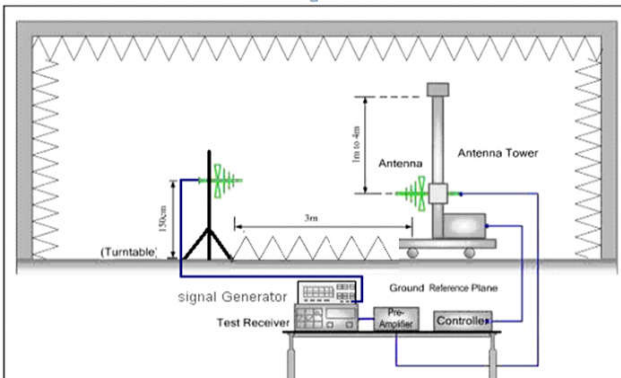

Figure 1. 25MHz to 1GHz

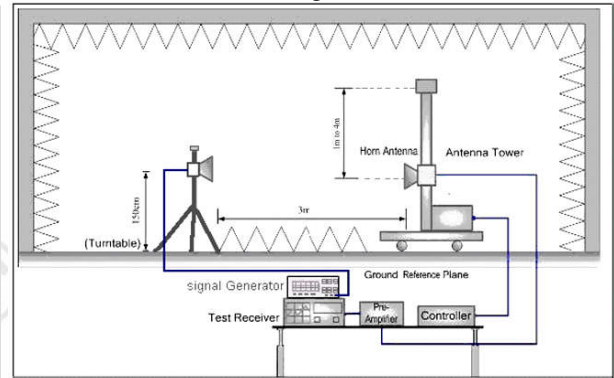

Figure 2. Above 1GHz

### Test Procedure:

1. Scan from 25MHz to 6 GHz; find the maximum radiation frequency to measure.
2. The technique used to find the Spurious Emissions of the transmitter was the antenna substitution method. Substitution method was performed to determine the actual ERP/EIRP emission levels of the EUT.

Test procedure as below:

- 1) The EUT was powered ON and placed on a 1.5m high table at a 3 meter fully Anechoic Chamber. The antenna of the transmitter was extended to its maximum length. Modulation mode and the measuring receiver shall be tuned to the frequency of the transmitter under test.
- 2) The EUT was set 3 meters away from the interference-receiving antenna, which was mounted on the top of a variable-height antenna tower.
- 3) The disturbance of the transmitter was maximized on the test receiver display by raising and lowering from 1m to 4m the receive antenna and by rotating through 360° the turntable. After the fundamental emission was maximized, a field strength measurement was made.
- 4) Steps 1) to 3) were performed with the EUT and the receive antenna in both vertical and horizontal polarization.
- 5) The transmitter was then removed and replaced with another antenna. The center of the antenna was approximately at the same location as the center of the transmitter.
- 6) A signal at the disturbance was fed to the substitution antenna by means of a non-radiating cable. With both the substitution and the receive antennas horizontally



- polarized, the receive antenna was raised and lowered to obtain a maximum reading at the test receiver. The level of the signal generator was adjusted until the measured field strength level in step 3) is obtained for this set of conditions.
- 7) The output power into the substitution antenna was then measured.
  - 8) Steps 6) and 7) were repeated with both antennas polarized.
  - 9) Calculate power in dBm by the following formula:  

$$\text{ERP(dBm)} = \text{Pg(dBm)} - \text{cable loss (dB)} + \text{antenna gain (dBd)}$$

$$\text{EIRP(dBm)} = \text{Pg(dBm)} - \text{cable loss (dB)} + \text{antenna gain (dBi)}$$

$$\text{EIRP} = \text{ERP} + 2.15\text{dB}$$
 Where: Pg is the generator output power into the substitution antenna.
  - 10) Test the EUT in the lowest channel ,middle channel, the Highest channel
  - 11) Repeat above procedures until all frequencies measured was complete..

**Equipment Used:**

Refer to section 5 for details.

**Limit:**

**Spurious domain emission limits**

State \ Frequency	47MHz to 74MHz 87.5MHz to 118MHz 174MHz to 230MHz 470MHz to 790MHz	Other Frequencies Below 1000MHz	Frequencies above 1000MHz
TX mode	-54 dBm	-36 dBm	-30 dBm
RX and all other modes	-57 dBm	-57 dBm	-47 dBm

**Test result:**

PASS

**Test Data:**

**Tx mode:**

Mode:		868.3MHz Tx mode						
NO.	Freq. [MHz]	Height [cm]	Azimuth [deg]	Level [dBm]	Limit [dBm]	Margin [dB]	Result	Polarity
1	39.823	150	6	-71.49	-36.00	35.49	Pass	Horizontal
2	203.0706	150	184	-64.54	-54.00	10.54	Pass	Horizontal
3	549.85	150	230	-67.30	-54.00	13.30	Pass	Horizontal
4	1737.9738	150	108	-41.24	-30.00	11.24	Pass	Horizontal
5	3473.6224	150	108	-49.27	-30.00	19.27	Pass	Horizontal
6	9634.7635	150	230	-44.67	-30.00	14.67	Pass	Horizontal
7	47.8196	150	190	-68.27	-54.00	14.27	Pass	Vertical
8	180.056	150	190	-65.68	-54.00	11.68	Pass	Vertical
9	724.4099	150	165	-62.88	-54.00	8.88	Pass	Vertical
10	1736.7987	150	139	-36.39	-30.00	6.39	Pass	Vertical
11	3473.6224	150	173	-50.09	-30.00	20.09	Pass	Vertical
12	9693.5194	150	21	-45.14	-30.00	15.14	Pass	Vertical

**Rx mode:**

Mode:		868.3MHz Rx mode						
NO.	Freq. [MHz]	Height [cm]	Azimuth [deg]	Level [dBm]	Limit [dBm]	Margin [dB]	Result	Polarity
1	37.5675	150	13	-68.85	-57.00	11.85	Pass	Horizontal
2	137.1094	150	0	-71.26	-57.00	14.26	Pass	Horizontal
3	284.967	150	98	-70.11	-57.00	13.11	Pass	Horizontal
4	1216.2432	150	329	-72.37	-47.00	25.37	Pass	Horizontal
5	5007.5515	150	170	-63.83	-47.00	16.83	Pass	Horizontal
6	9729.6459	150	60	-57.80	-47.00	10.80	Pass	Horizontal
7	36.9854	150	230	-63.73	-57.00	6.73	Pass	Vertical
8	184.2609	150	296	-69.08	-57.00	12.08	Pass	Vertical
9	750.078	150	3	-66.84	-57.00	9.84	Pass	Vertical
10	1373.7247	150	192	-72.47	-47.00	25.47	Pass	Vertical
11	5012.2524	150	60	-64.05	-47.00	17.05	Pass	Vertical
12	9713.1926	150	3	-57.93	-47.00	10.93	Pass	Vertical

## 6.1.13 Short term behaviour

**Test Method:** EN 300 220-1 Clause 5.5

**Test Requirement:** EN 300 220-2 Clause 4.3.11

**Test Results:** Not applicable, since the test applied to EUT using EN 300 220-2 annex C bands Y, Z, AA, AB, AC, AD.

## 6.2 Receiver Requirements

### 6.2.1 RX sensitivity

**Test Method:** EN 300 220-1 Clause 5.14

**Test Requirement:** EN 300 220-2 Clause 4.4.1

**Test Results:** Not applicable, since the test applied to EUT with polite spectrum access.



## 6.2.2 Blocking

**Test Method:** EN 300 220-1 Clause 5.18

**Test Requirement:** EN 300 220-2 Clause 4.4.2

**EUT Operation:**

**Ambient:** Temp.: 23°C

Humid.: 54%

Press.: 1010mbar

**Test Status:** Let EUT normal transmit at 863- 870MHz Carrier Frequency.

**Test Setup:**

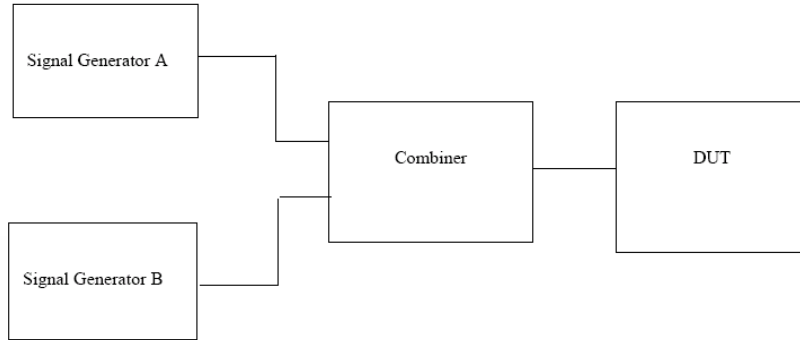

Figure 1

**Equipment Used:** Refer to section 5 for details.

### Limits for receiver blocking

**Limit:**

Requirement	Limits
	Receiver category 3
Blocking at $\pm 2$ MHz from OC edge $f_{high}$ and $f_{low}$	$\geq -80$ dBm
Blocking at $\pm 10$ MHz from OC edge $f_{high}$ and $f_{low}$	$\geq -60$ dBm
Blocking at $\pm 5$ % of Centre Frequency or 15 MHz, whichever is the greater	$\geq -60$ dBm

Requirement	Limits
	Receiver category 2
Blocking at $\pm 2$ MHz from OC edge $f_{high}$ and $f_{low}$	$\geq -69$ dBm
Blocking at $\pm 10$ MHz from OC edge $f_{high}$ and $f_{low}$	$\geq -44$ dBm
Blocking at $\pm 5$ % of Centre Frequency or 15 MHz, whichever is the greater	$\geq -44$ dBm

**Test result:** PASS

**Test Data:**

Receiver Category	Frequency Offset	Test Value	Limit	Result
2	Blocking at $\pm 2$ MHz from OC edge $f_{high}$ and $f_{low}$	-34.11 dBm	$\geq -69$ dBm	PASS
2	Blocking at $\pm 10$ MHz from OC edge $f_{high}$ and $f_{low}$	-23.32 dBm	$\geq -44$ dBm	PASS
2	Blocking at $\pm 5$ % of Centre Frequency or 15 MHz, whichever is the greater	-23.81 dBm	$\geq -44$ dBm	PASS

## 6.3 Polite spectrum access conformance requirement

### 6.3.1 Clear Channel Assessment threshold

Test Method: EN 300 220-1 Clause 5.21.2

Test Requirement: EN 300 220-2 Clause 4.5.2

Test Results: Not applicable, since the test applied to EUT with polite spectrum access.

### 6.3.2 Polite spectrum access timing parameters

Test Method: EN 300 220-1 Clause 5.21.3

Test Requirement: EN 300 220-2 Clause 4.5.3

Test Results: Not applicable, since the test applied to EUT with polite spectrum access.

### 6.3.3 Adaptive Frequency Agility

Test Method: EN 300 220-1 Clause 5.21.4

Test Requirement: EN 300 220-2 Clause 4.5.4

Test Results: Not applicable, since the test applied to EUT with AFA (Adaptive Frequency Agility).

**APPENDIX 1 PHOTOGRAPHS OF TEST SETUP**

Test Model No.: BeaglePlay



**Radiated spurious emission Test Setup-1(Below 1GHz)**

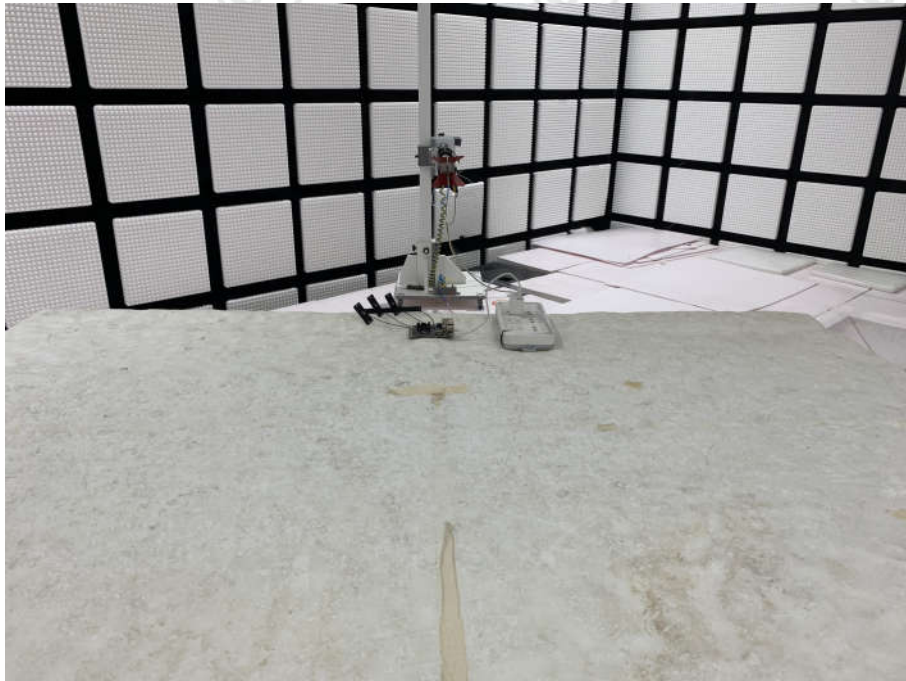

**Radiated spurious emission Test Setup-2(Above 1GHz)**

## APPENDIX 2 PHOTOGRAPHS OF EUT Constructional Details

Refer to Report No. EED32P80002201 for EUT external and internal photos.

The test report is effective only with both signature and specialized stamp, The result(s) shown in this report refer only to the sample(s) tested. Without written approval of CTI, this report can't be reproduced except in full.

\*\*\* End of Report \*\*\*





## TEST REPORT

**Product** : BeaglePlay  
**Trade mark** : Beagleboard.org  
**Model/Type reference** : BeaglePlay  
**Serial Number** : N/A  
**Report Number** : EED32P80002203  
**Date of Issue** : Feb. 22, 2023  
**Test Standards** : ETSI EN 300 328 V2.2.2(2019-07)  
**Test result** : PASS

Prepared for:

**Seed Technology Co., Ltd**  
**9F, Building G3, TCL International E city, Zhongshanyuan Road,**  
**Nanshan, Shenzhen, China.**

Prepared by:

**Centre Testing International Group Co., Ltd.**  
**Hongwei Industrial Zone, Bao'an 70 District,**  
**Shenzhen, Guangdong, China**  
**TEL: +86-755-3368 3668**  
**FAX: +86-755-3368 3385**

Compiled by: mark.chen.

Reviewed by: Tom Chen

Approved by: Aaron Ma  
Aaron Ma

Date: Feb. 22, 2023



Check No.: 5404030123

## 2 Version

Version No.	Date	Description
00	Feb. 22, 2023	Original

## 3 Test Summary

Test Item	Test Requirement	Test Method	Limit	Result
RF output power	EN 300 328 V2.2.2 (2019-07)Clause 4.3.2.2	EN 300 328 V2.2.2 (2019-07)Clause 5.4.2	Refer clause 4.3.2.2.3	PASS*
Power Spectral Density	EN 300 328 V2.2.2 (2019-07)Clause 4.3.2.3	EN 300 328 V2.2.2 (2019-07)Clause 5.4.3	Refer clause 4.3.2.3.3	PASS*
Duty Cycle, Tx-sequence, Tx-gap	EN 300 328 V2.2.2 (2019-07)Clause 4.3.2.4	EN 300 328 V2.2.2 (2019-07)Clause 5.4.2	Refer clause 4.3.2.4.3	N/A <sup>1</sup>
Medium Utilization (MU) factor	EN 300 328 V2.2.2 (2019-07)Clause 4.3.2.5	EN 300 328 V2.2.2 (2019-07)Clause 5.4.2	Refer clause 4.3.2.5.3	N/A <sup>2</sup>
Adaptivity	EN 300 328 V2.2.2 (2019-07)Clause 4.3.2.6	EN 300 328 V2.2.2 (2019-07)Clause 5.4.6	Refer clause 4.3.2.6.3.2	PASS*
Occupied Channel Bandwidth	EN 300 328 V2.2.2 (2019-07)Clause 4.3.2.7	EN 300 328 V2.2.2 (2019-07)Clause 5.4.7	Refer clause 4.3.2.7.3	PASS*
Transmitter unwanted emissions in the out-of- band domain	EN 300 328 V2.2.2 (2019-07)Clause 4.3.2.8	EN 300 328 V2.2.2 (2019-07)Clause 5.4.8	Refer clause 4.3.2.8.3	PASS*
Transmitter unwanted emissions in the spurious domain	EN 300 328 V2.2.2 (2019-07)Clause 4.3.2.9	EN 300 328 V2.2.2 (2019-07)Clause 5.4.9	Refer clause 4.3.2.9.3	PASS
Receiver spurious emissions	EN 300 328 V2.2.2 (2019-07)Clause 4.3.2.10	EN 300 328 V2.2.2 (2019-07)Clause 5.4.10	Refer clause 4.3.2.10.3	PASS
Receiver Blocking	EN 300 328 V2.2.2 (2019-07)Clause 4.3.2.11	EN 300 328 V2.2.2 (2019-07)Clause 5.4.11	Refer clause 4.3.2.11.4	PASS*
Geo-location capability	EN 300 328 V2.2.2 (2019-07)Clause 4.3.2.12	EN 300 328 V2.2.2 (2019-07)Clause 4.3.2.12	Refer Clause 4.3.2.12.3	N/A <sup>3</sup>

Remark:

N/A<sup>1</sup>: Because these requirements apply to non-adaptive frequency hopping equipment mode and RF output power of greater than or equal to 10 dBm.

N/A<sup>2</sup>: Because these requirements apply to non-adaptive frequency hopping equipment mode and RF output power of greater than or equal to 10 dBm.

N/A<sup>3</sup>: Because these requirements apply to equipment with geo-location capability

Company Name and Address shown on Report, the sample(s) and sample Information was/ were provided by the applicant who should be responsible for the authenticity which CTI hasn't verified.

Tx: In this whole report Tx (or tx) means Transmitter.

Rx: In this whole report Rx (or rx) means Receiver.

RF: In this whole report RF means Radiated Frequency.

CH: In this whole report CH means channel.

Volt: In this whole report Volt means Voltage.

Temp: In this whole report Temp means Temperature.

Humid: In this whole report Humid means humidity.

Press: In this whole report Press means Pressure.

N/A: In this whole report not application.

Remark\*: All test data come from the report of No.ER741330-06, use the same RF module.

## 4 Content

<b>1 COVERPAGE</b> .....	<b>1</b>
<b>2 VERSION</b> .....	<b>2</b>
<b>3 TEST SUMMARY</b> .....	<b>3</b>
<b>4 CONTENT</b> .....	<b>4</b>
<b>5 TEST REQUIREMENT</b> .....	<b>5</b>
5.1 TEST SETUP .....	5
5.1.1 For Conducted test setup .....	5
5.1.2 For Radiated Emissions test setup .....	5
5.2 TEST ENVIRONMENT .....	6
5.3 TEST CONDITION .....	6
<b>6 GENERAL INFORMATION</b> .....	<b>7</b>
6.1 CLIENT INFORMATION .....	7
6.2 GENERAL DESCRIPTION OF EUT .....	7
6.3 DESCRIPTION OF SUPPORT UNITS .....	9
6.4 TEST LOCATION .....	9
6.5 DEVIATION FROM STANDARDS .....	9
6.6 ABNORMALITIES FROM STANDARD CONDITIONS .....	9
6.7 OTHER INFORMATION REQUESTED BY THE CUSTOMER .....	9
6.8 MEASUREMENT UNCERTAINTY (95% CONFIDENCE LEVELS, K=2) .....	10
<b>7 EQUIPMENT LIST</b> .....	<b>11</b>
<b>8 RADIO TECHNICAL REQUIREMENTS SPECIFICATION</b> .....	<b>12</b>
Appendix A: Spurious emissions .....	13
<b>PHOTOGRAPHS OF TEST SETUP</b> .....	<b>22</b>
<b>PHOTOGRAPHS OF EUT CONSTRUCTIONAL DETAILS</b> .....	<b>23</b>



## 5 Test Requirement

### 5.1 Test setup

#### 5.1.1 For Conducted test setup

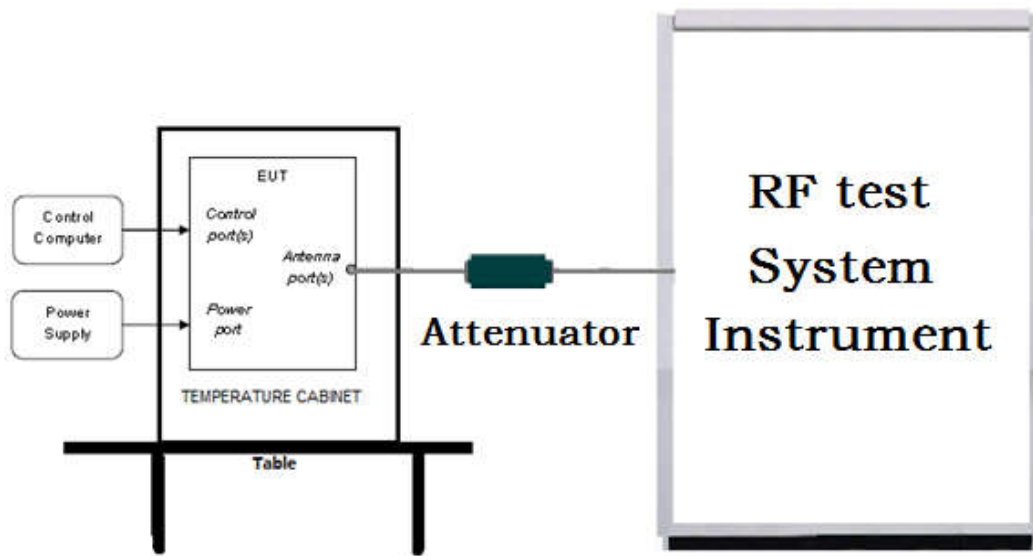

#### 5.1.2 For Radiated Emissions test setup

Radiated Emissions setup:

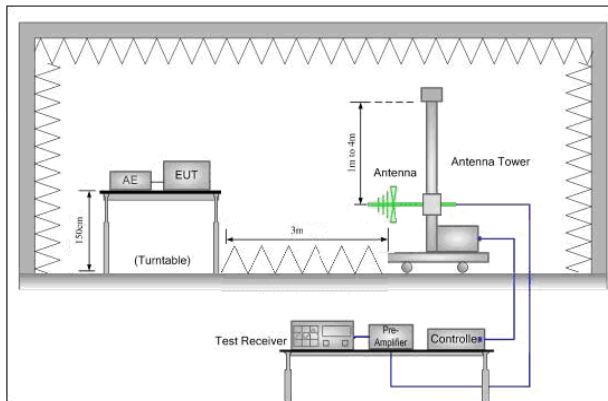

Figure 1. 30MHz to 1GHz

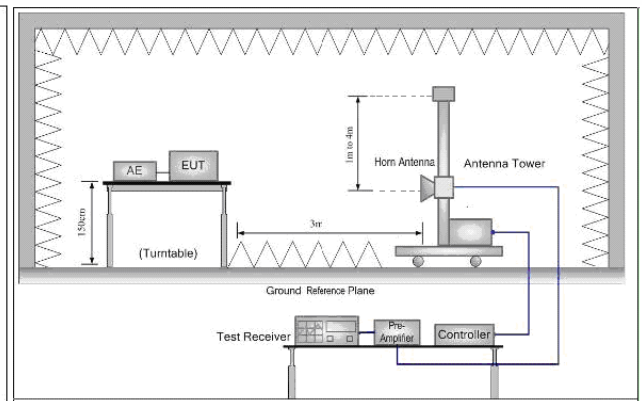

Figure 2. Above 1GHz

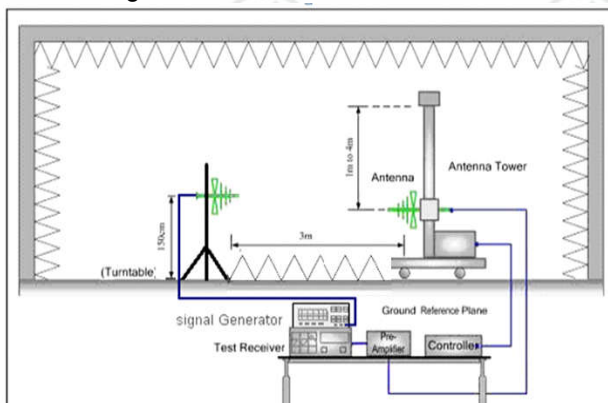

Figure 1. 30MHz to 1GHz

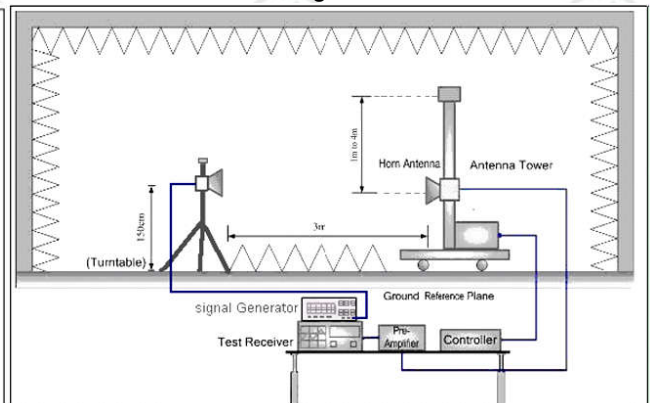

Figure 2. Above 1GHz

## 5.2 Test Environment

Environment Parameter	Selected Values During Tests		
	Ambient		
Test condition	Temperature(°C)	Voltage(V)	Relative Humidity%
NT/NV	23	DC 5V	54
LT/NV	0	DC 5V	54
HT/NV	60	DC 5V	54

Note:

- 1) The EUT just work in such extreme temperature of 0°C~+60°C, so here the EUT is tested in the temperature of 0°C~+60°C
- 2) NV: Normal Voltage NT:Normal Temperature  
LT: Low Extreme Test Temperature HT: High Extreme Test Temperature

### 5.1.2 Normal test conditions

#### 5.1.2.1 Normal temperature and humidity

Unless otherwise declared by the manufacturer, the normal temperature and humidity conditions for tests shall be any convenient combination of temperature and humidity within the following ranges:

- temperature: +15 °C to +35 °C;
- relative humidity: 20 % to 75 %.

The actual values during the tests shall be recorded.

#### 5.1.2.2 Normal power source

The normal test voltage for the equipment shall be the nominal voltage for which the equipment was designed.

### 5.1.3 Extreme test conditions

Some tests in the present document need to be repeated at extreme temperatures. Where that is the case, measurements shall be made over the extremes of the operating temperature range as declared by the manufacturer.

## 5.3 Test Condition

Test channel

Test Mode	Tx/Rx	RF Channel		
		Low(L)	Middle(M)	High(H)
802.11b	2412MHz ~2472 MHz	Channel 1	Channel 7	Channel13
		2412MHz	2442MHz	2472MHz
802.11g	2412MHz ~2472 MHz	Channel 1	Channel 7	Channel13
		2412MHz	2442MHz	2472MHz
802.11n(HT20)	2412MHz ~2472 MHz	Channel 1	Channel 7	Channel13
		2412MHz	2442MHz	2472MHz
802.11n(HT40)	2422MHz ~2462 MHz	Channel 1	Channel 5	Channel 9
		2422MHz	2442MHz	2462MHz

Through Pre-scan all rate, 1Mbps of rate the power is the worst case of 802.11b; 6Mbps of rate the power is the worst case of 802.11g; 6.5Mbps of rate the power is the worst case of 802.11n(HT20); MCS0 of rate the power is the worst case of 802.11n(HT40); only the worse case was recorded in the report.

## 6 General Information

### 6.1 Client Information

Applicant:	Seeed Technology Co., Ltd
Address of Applicant:	9F, Building G3, TCL International E city, Zhongshanyuan Road, Nanshan, Shenzhen, China.
Manufacturer:	Seeed Technology Co., Ltd
Address of Manufacturer:	9F, Building G3, TCL International E city, Zhongshanyuan Road, Nanshan, Shenzhen, China.
Factory:	Shenzhen Xinxian Technology Co., Limited
Address of Factory:	F5, Building B17, Hengfeng Industrial City, No. 739 Zhoushi Rd, Baoan District, Shenzhen, Guangdong, P.R.C.

### 6.2 General Description of EUT

Product Name:	BeaglePlay
Model No.(EUT):	BeaglePlay
Trade mark:	Beagleboard.org
Type of Modulation:	IEEE for 802.11b:DSSS(CCK,DQPSK,DBPSK) IEEE for 802.11g:OFDM(64QAM, 16QAM, QPSK, BPSK) IEEE for 802.11n(HT20 and HT40): OFDM (64QAM, 16QAM,QPSK,BPSK)
Operating Frequency:	IEEE 802.11b/g/n(HT20): 2412MHz to 2472MHz IEEE 802.11n(HT40): 2422MHz to 2462MHz
Channels Step:	Channels with 5MHz step
Transmit Data Rate:	802.11b:1M/2M/5.5M/11M bps 802.11g:6M/9M/12M/18M/24M/36M/48M/54M bps 802.11n(HT20/HT40): MCS0~MCS31 (NSS4)
Number of Channels:	802.11b/g/n(HT20): 13 802.11 n(HT40)
Sample Type:	Fixed-Use
Test Power Grade:	Default
Test Software of EUT:	SecureCRT
Antenna Type:	PCB Antenna
Antenna Gain:	ANT1: 1.54dBi; ANT2: 1.54dBi
Power Supply:	DC 5V
Test voltage:	DC 5V

## Other Information

RED Directive:	2014/53/EU						
Sample Received Date:	Jan. 03, 2023						
Sample tested Date:	Jan. 03, 2023 to Feb. 16, 2023						
SISO:							
Operation Frequency each of channel(802.11b/g/n HT20)							
Channel	Frequency	Channel	Frequency	Channel	Frequency	Channel	Frequency
1	2412MHz	5	2432MHz	9	2452MHz	13	2472MHz
2	2417MHz	6	2437MHz	10	2457MHz		
3	2422MHz	7	2442MHz	11	2462MHz		
4	2427MHz	8	2447MHz	12	2467MHz		
Operation Frequency each of channel(802.11n HT40)							
Channel	Frequency	Channel	Frequency	Channel	Frequency		
1	2422MHz	4	2437MHz	7	2452MHz		
2	2427MHz	5	2442MHz	8	2457MHz		
3	2432MHz	6	2447MHz	9	2462MHz		
MIMO:							
Operation Frequency each of channel(802.11n HT20)							
Channel	Frequency	Channel	Frequency	Channel	Frequency	Channel	Frequency
1	2412MHz	5	2432MHz	9	2452MHz	13	2472MHz
2	2417MHz	6	2437MHz	10	2457MHz		
3	2422MHz	7	2442MHz	11	2462MHz		
4	2427MHz	8	2447MHz	12	2467MHz		



## 6.3 Description of Support Units

The EUT has been tested with associated equipment below.

1) support equipment

Description	Manufacturer	Model No.	Certification	Supplied by
Netbook	DELL	Latitude 3490	FCC&CE	CTI

## 6.4 Test Location

All tests were performed at:

Centre Testing International Group Co., Ltd.

Building C, Hongwei Industrial Park Block 70, Bao'an District, Shenzhen, China

Telephone: +86 (0) 755 3368 3668 Fax:+86 (0) 755 3368 3385

No tests were sub-contracted.

## 6.5 Deviation from Standards

None.

## 6.6 Abnormalities from Standard Conditions

None.

## 6.7 Other Information Requested by the Customer

None.

## 6.8 Measurement Uncertainty (95% confidence levels, k=2)

No.	Item	Measurement Uncertainty
1	Occupied Bandwidth	0.52dB
2	RF Power conducted	0.46dB(30MHz-1GHz)
		0.55dB(1GHz-18GHz)
3	Power Spectral Density, conducted	0.57dB
4	Unwanted Emission, conducted	0.46dB(30MHz-1GHz)
		0.55dB(1GHz-18GHz)
5	All Emission, radiated	4.9dB(30MHz-1GHz)
		4.7dB(1GHz-18GHz)
6	Temperature test	0.64°C
7	Humidity test	3.8%
8	DC and low frequency voltages test	0.026%

## 7 Equipment List

3M full-anechoic Chamber					
Equipment	Manufacturer	Model No.	Serial Number	Cal. Date (mm-dd-yyyy)	Cal. Due date (mm-dd-yyyy)
RSE Automatic test software	JS Tonscend	JS36-RSE	10166	---	---
Receiver	Keysight	N9038A	MY57290136	03-01-2022	02-28-2023
Spectrum Analyzer	Keysight	N9020B	MY57111112	03-01-2022	02-28-2023
Spectrum Analyzer	Keysight	N9030B	MY57140871	03-01-2022	02-28-2023
TRILOG Broadband Antenna	Schwarzbeck	VULB 9163	9163-1148	04-28-2021	04-27-2024
Horn Antenna	Schwarzbeck	BBHA 9170	9170-832	04-15-2021	04-14-2024
Horn Antenna	ETS-LINDGREN	3117	57407	07-04-2021	07-03-2024
Preamplifier	EMCI	EMC184055SE	980597	04-20-2022	04-19-2023
Preamplifier	EMCI	EMC001330	980563	04-13-2022	04-12-2023
Preamplifier	JS Tonscend	TAP-011858	AP21B806112	07-29-2022	07-28-2023
Communication test set	R&S	CMW500	102898	12-23-2022	12-22-2023
Temperature/Humidity Indicator	biaozhi	GM1360	EE1186631	02-21-2022	02-20-2023
Fully Anechoic Chamber	TDK	FAC-3	---	01-09-2021	01-08-2024
Cable line	Times	SFT205-NMSM-2.50M	394812-0001	---	---
Cable line	Times	SFT205-NMSM-2.50M	394812-0002	---	---
Cable line	Times	SFT205-NMSM-2.50M	394812-0003	---	---
Cable line	Times	SFT205-NMSM-2.50M	393495-0001	---	---
Cable line	Times	EMC104-NMNM-1000	SN160710	---	---
Cable line	Times	SFT205-NMSM-3.00M	394813-0001	---	---
Cable line	Times	SFT205-NMNM-1.50M	381964-0001	---	---
Cable line	Times	SFT205-NMSM-7.00M	394815-0001	---	---
Cable line	Times	HF160-KMKM-3.00M	393493-0001	---	---

## 8 Radio Technical Requirements Specification

Reference documents for testing:

No.	Identity	Document Title
1	EN 300 328 V2.2.2 (2019-07)	Wideband transmission systems; Data transmission equipment operating in the 2,4 GHz band; Harmonised Standard for access to radio spectrum

### Test Results List:

EN300 328 V2.2.2		Test Descriptions & Test Conditions	Verdict	Note
Test Requirement	Test Method			
Clause 4.3.2.2	Clause 5.4.2	RF output power,		Note 1
		NT/NV	PASS	
		LT/NV	PASS	
Clause 4.3.2.3	Clause 5.4.3	Power Spectral Density		Note 1
		NT/NV	PASS	
Clause 4.3.2.4	Clause 5.4.2	Duty Cycle, Tx-sequence, Tx-gap		N/A
		NT/NV	N/A	
Clause 4.3.2.5	Clause 5.4.2	Medium Utilisation (MU) factor		N/A
		NT/NV	N/A	
Clause 4.3.2.6	Clause 5.4.6	Adaptivity (adaptive equipment using modulations other than FHSS)		Note 1
		NT/NV	PASS	
Clause 4.3.2.7	Clause 5.4.7	Occupied Channel Bandwidth		Note 1
		NT/NV	PASS	
Clause 4.3.2.8	Clause 5.4.8	Transmitter unwanted emissions in the out-of-band domain		Note 1
		NT/NV	PASS	
Clause 4.3.2.11	Clause 5.4.11	Receiver Blocking		Note 1
		NT/NV	PASS	
Clause 4.3.2.9	Clause 5.4.9	Transmitter unwanted emissions in the spurious domain		Appendix A
		NT/NV	PASS	
Clause 4.3.2.10	Clause 5.4.10	Receiver spurious emissions		Appendix A
		NT/NV	PASS	

Note 1: The test data please refer to report of No.ER741330-06.



## Appendix A: Spurious emissions

<b>Test Procedure:</b>		
<ol style="list-style-type: none"> <li>Scan from 30MHz to 12.75GHz; find the maximum radiation frequency to measure.</li> <li>The technique used to find the Spurious Emissions of the transmitter was the antenna substitution method. Substitution method was performed to determine the actual ERP/EIRP emission levels of the EUT.</li> </ol> <p>Test procedure as below:</p> <ol style="list-style-type: none"> <li>The EUT was powered ON and placed on a 1.5m high table at a 3 meter fully Anechoic Chamber. The antenna of the transmitter was extended to its maximum length. Modulation mode and the measuring receiver shall be tuned to the frequency of the transmitter under test.</li> <li>The EUT was set 3 meters (above 18GHz the distance is 1 meter) away from the interference-receiving antenna, which was mounted on the top of a variable-height antenna tower.</li> <li>The disturbance of the transmitter was maximized on the test receiver display by raising and lowering from 1m to 4m the receive antenna and by rotating through 360° the turntable. After the fundamental emission was maximized, a field strength measurement was made.</li> <li>Steps 1) to 3) were performed with the EUT and the receive antenna in both vertical and horizontal polarization.</li> <li>The transmitter was then removed and replaced with another antenna. The center of the antenna was approximately at the same location as the center of the transmitter.</li> <li>A signal at the disturbance was fed to the substitution antenna by means of a non-radiating cable. With both the substitution and the receive antennas horizontally polarized, the receive antenna was raised and lowered to obtain a maximum reading at the test receiver. The level of the signal generator was adjusted until the measured field strength level in step 3) is obtained for this set of conditions.</li> <li>The output power into the substitution antenna was then measured.</li> <li>Steps 6) and 7) were repeated with both antennas polarized.</li> <li>Calculate power in dBm by the following formula:  <math>ERP(dBm) = Pg(dBm) - \text{cable loss (dB)} + \text{antenna gain (dBd)}</math>  <math>EIRP(dBm) = Pg(dBm) - \text{cable loss (dB)} + \text{antenna gain (dBi)}</math>  <math>EIRP = ERP + 2.15dB</math> <p>where:  Pg is the generator output power into the substitution antenna.</p> </li> <li>Test the EUT in the lowest channel , the Highest channel</li> <li>Repeat above procedures until all frequencies measured was complete..</li> </ol>		
<b>Limit:</b>	<b>Transmitter limits for spurious emissions</b>	
	<b>Frequency range</b>	<b>Maximum power, e.r.p. (≤ 1 GHz) e.i.r.p. (&gt; 1 GHz)</b>
	30 MHz to 47 MHz	-36dBm
	47 MHz to 74 MHz	-54 dBm
	74 MHz to 87,5 MHz	-36dBm
	87,5 MHz to 118 MHz	-54 dBm
	118 MHz to 174 MHz	-36dBm
	174 MHz to 230 MHz	-54 dBm
	230 MHz to 470 MHz	-36dBm
	470 MHz to 694 MHz	-54 dBm
694 MHz to 1 GHz	-36dBm	
1 GHz to 12.75 GHz	-30dBm	
	<b>Spurious emission limits for receivers</b>	
<b>Frequency range</b>	<b>Maximum power e.r.p. (≤ 1 GHz) e.i.r.p. (&gt; 1 GHz)</b>	<b>bandwidth</b>
30MHz to 1GHz	-57dBm	100kHz
1GHz to 12.75GHz	-47dBm	1MHz

## Radiated Spurious Emissions test Data:

### 1) Transmitter unwanted emissions in the spurious domain

Remark: Through Pre-scan, for 20MHz Occupied Bandwidth, 802.11 b mode was the worst case; for 40MHz Occupied Bandwidth, 802.11 n(HT40) mode was the worst case; only the worst case was in the report.

ANT1:

Mode:		802.11 b Transmitting						
Channel:		2412 MHz						
NO.	Freq. [MHz]	Height [cm]	Azimuth [deg]	Level [dBm]	Limit [dBm]	Margin [dB]	Result	Polarity
1	55.4165	150	3	-67.55	-54.00	13.55	Pass	Horizontal
2	112.1672	150	126	-62.24	-54.00	8.24	Pass	Horizontal
3	500.012	150	145	-67.89	-54.00	13.89	Pass	Horizontal
4	1263.4263	150	58	-49.33	-30.00	19.33	Pass	Horizontal
5	4824.0216	150	80	-37.08	-30.00	7.08	Pass	Horizontal
6	9746.1497	150	340	-46.80	-30.00	16.80	Pass	Horizontal
7	51.0511	150	81	-66.16	-54.00	12.16	Pass	Vertical
8	179.977	150	184	-64.40	-54.00	10.40	Pass	Vertical
9	636.0196	150	100	-71.48	-54.00	17.48	Pass	Vertical
10	1399.4399	150	109	-49.25	-30.00	19.25	Pass	Vertical
11	4824.0216	150	142	-40.85	-30.00	10.85	Pass	Vertical
12	9773.4516	150	44	-47.06	-30.00	17.06	Pass	Vertical

Mode:		802.11 b Transmitting						
Channel:		2472 MHz						
NO.	Freq. [MHz]	Height [cm]	Azimuth [deg]	Level [dBm]	Limit [dBm]	Margin [dB]	Result	Polarity
1	59.976	150	355	-63.02	-54.00	9.02	Pass	Horizontal
2	216.0646	150	336	-62.32	-54.00	8.32	Pass	Horizontal
3	600.029	150	178	-61.39	-54.00	7.39	Pass	Horizontal
4	1275.4275	150	178	-49.88	-30.00	19.88	Pass	Horizontal
5	4944.2796	150	87	-37.66	-30.00	7.66	Pass	Horizontal
6	9741.5994	150	208	-48.08	-30.00	18.08	Pass	Horizontal
7	59.976	150	113	-61.82	-54.00	7.82	Pass	Vertical
8	184.2454	150	3	-67.11	-54.00	13.11	Pass	Vertical
9	600.029	150	141	-63.86	-54.00	9.86	Pass	Vertical
10	1399.64	150	347	-49.31	-30.00	19.31	Pass	Vertical
11	4944.2796	150	78	-41.86	-30.00	11.86	Pass	Vertical
12	10281.1354	150	14	-45.72	-30.00	15.72	Pass	Vertical

Mode:		802.11 n(HT40) Transmitting						
Channel:		2422 MHz						
NO.	Freq. [MHz]	Height [cm]	Azimuth [deg]	Level [dBm]	Limit [dBm]	Margin [dB]	Result	Polarity
1	48.0438	150	172	-63.85	-54.00	9.85	Pass	Horizontal
2	180.074	150	3	-62.06	-54.00	8.06	Pass	Horizontal
3	552.1062	150	60	-63.85	-54.00	9.85	Pass	Horizontal
4	1277.6278	150	154	-48.98	-30.00	18.98	Pass	Horizontal
5	4844.1729	150	86	-36.87	-30.00	6.87	Pass	Horizontal
6	9727.2985	150	86	-47.33	-30.00	17.33	Pass	Horizontal
7	48.0438	150	72	-61.58	-54.00	7.58	Pass	Vertical
8	209.856	150	98	-68.98	-54.00	14.98	Pass	Vertical
9	600.029	150	136	-63.44	-54.00	9.44	Pass	Vertical
10	1286.6287	150	53	-50.00	-30.00	20.00	Pass	Vertical
11	4844.1729	150	133	-41.54	-30.00	11.54	Pass	Vertical
12	9657.7439	150	133	-47.28	-30.00	17.28	Pass	Vertical

Mode:		802.11 n(HT40) Transmitting						
Channel:		2462 MHz						
NO.	Freq. [MHz]	Height [cm]	Azimuth [deg]	Level [dBm]	Limit [dBm]	Margin [dB]	Result	Polarity
1	59.976	150	360	-63.76	-54.00	9.76	Pass	Horizontal
2	192.1032	150	326	-61.21	-54.00	7.21	Pass	Horizontal
3	528.0478	150	60	-63.60	-54.00	9.60	Pass	Horizontal
4	1275.0275	150	334	-48.97	-30.00	18.97	Pass	Horizontal
5	4924.1283	150	83	-38.90	-30.00	8.90	Pass	Horizontal
6	9698.0465	150	298	-47.33	-30.00	17.33	Pass	Horizontal
7	48.0438	150	114	-61.33	-54.00	7.33	Pass	Vertical
8	107.9958	150	360	-65.25	-54.00	11.25	Pass	Vertical
9	600.029	150	134	-63.21	-54.00	9.21	Pass	Vertical
10	1405.4405	150	246	-49.60	-30.00	19.60	Pass	Vertical
11	4924.1283	150	29	-42.42	-30.00	12.42	Pass	Vertical
12	9665.5444	150	48	-47.80	-30.00	17.80	Pass	Vertical

ANT2:

Mode:		802.11 b Transmitting						
Channel:		2412 MHz						
NO.	Freq. [MHz]	Height [cm]	Azimuth [deg]	Level [dBm]	Limit [dBm]	Margin [dB]	Result	Polarity
1	59.976	150	3	-63.00	-54.00	9.00	Pass	Horizontal
2	180.074	150	159	-59.73	-54.00	5.73	Pass	Horizontal
3	600.029	150	178	-60.83	-54.00	6.83	Pass	Horizontal
4	1402.8403	150	40	-49.12	-30.00	19.12	Pass	Horizontal
5	4824.0216	150	84	-41.44	-30.00	11.44	Pass	Horizontal
6	9755.9004	150	280	-46.20	-30.00	16.20	Pass	Horizontal
7	48.0438	150	132	-61.55	-54.00	7.55	Pass	Vertical
8	184.3424	150	49	-67.48	-54.00	13.48	Pass	Vertical
9	600.029	150	132	-63.00	-54.00	9.00	Pass	Vertical
10	1400.24	150	59	-49.72	-30.00	19.72	Pass	Vertical
11	4824.0216	150	64	-44.96	-30.00	14.96	Pass	Vertical
12	9735.099	150	160	-47.28	-30.00	17.28	Pass	Vertical

Mode:		802.11 b Transmitting						
Channel:		2472 MHz						
NO.	Freq. [MHz]	Height [cm]	Azimuth [deg]	Level [dBm]	Limit [dBm]	Margin [dB]	Result	Polarity
1	59.976	150	184	-64.24	-54.00	10.24	Pass	Horizontal
2	192.1032	150	330	-61.77	-54.00	7.77	Pass	Horizontal
3	600.029	150	174	-59.96	-54.00	5.96	Pass	Horizontal
4	1311.2311	150	228	-49.47	-30.00	19.47	Pass	Horizontal
5	4944.2796	150	85	-44.01	-30.00	14.01	Pass	Horizontal
6	9724.0483	150	95	-47.56	-30.00	17.56	Pass	Horizontal
7	48.0438	150	88	-60.26	-54.00	6.26	Pass	Vertical
8	184.3424	150	3	-68.08	-54.00	14.08	Pass	Vertical
9	600.029	150	145	-62.92	-54.00	8.92	Pass	Vertical
10	1261.8262	150	162	-49.77	-30.00	19.77	Pass	Vertical
11	4944.2796	150	24	-47.60	-30.00	17.60	Pass	Vertical
12	9160.4607	150	53	-47.30	-30.00	17.30	Pass	Vertical

Mode:		802.11 n(HT40) Transmitting						
Channel:		2422 MHz						
NO.	Freq. [MHz]	Height [cm]	Azimuth [deg]	Level [dBm]	Limit [dBm]	Margin [dB]	Result	Polarity
1	60.073	150	360	-63.95	-54.00	9.95	Pass	Horizontal
2	192.0062	150	344	-61.75	-54.00	7.75	Pass	Horizontal
3	600.029	150	178	-60.05	-54.00	6.05	Pass	Horizontal
4	1311.6312	150	178	-48.81	-30.00	18.81	Pass	Horizontal
5	4844.1729	150	174	-47.82	-30.00	17.82	Pass	Horizontal
6	9172.8115	150	74	-48.46	-30.00	18.46	Pass	Horizontal
7	48.0438	150	86	-60.92	-54.00	6.92	Pass	Vertical
8	107.9958	150	3	-64.23	-54.00	10.23	Pass	Vertical
9	600.029	150	134	-62.75	-54.00	8.75	Pass	Vertical
10	1341.0341	150	21	-49.32	-30.00	19.32	Pass	Vertical
11	4844.1729	150	31	-50.45	-30.00	20.45	Pass	Vertical
12	9759.8007	150	212	-47.51	-30.00	17.51	Pass	Vertical

Mode:		802.11 n(HT40) Transmitting						
Channel:		2462 MHz						
NO.	Freq. [MHz]	Height [cm]	Azimuth [deg]	Level [dBm]	Limit [dBm]	Margin [dB]	Result	Polarity
1	59.976	150	3	-64.26	-54.00	10.26	Pass	Horizontal
2	179.977	150	152	-60.93	-54.00	6.93	Pass	Horizontal
3	600.029	150	43	-60.85	-54.00	6.85	Pass	Horizontal
4	1297.6298	150	152	-49.58	-30.00	19.58	Pass	Horizontal
5	4924.1283	150	80	-46.58	-30.00	16.58	Pass	Horizontal
6	9662.9442	150	299	-47.36	-30.00	17.36	Pass	Horizontal
7	48.0438	150	114	-61.94	-54.00	7.94	Pass	Vertical
8	107.9958	150	360	-64.08	-54.00	10.08	Pass	Vertical
9	600.029	150	145	-63.02	-54.00	9.02	Pass	Vertical
10	1309.2309	150	76	-50.00	-30.00	20.00	Pass	Vertical
11	4924.1283	150	54	-50.65	-30.00	20.65	Pass	Vertical
12	10156.3271	150	1	-46.64	-30.00	16.64	Pass	Vertical



Mode:		802.11 n(HT20) Transmitting						
Channel:		2422 MHz						
NO.	Freq. [MHz]	Height [cm]	Azimuth [deg]	Level [dBm]	Limit [dBm]	Margin [dB]	Result	Polarity
1	59.976	150	191	-64.57	-54.00	10.57	Pass	Horizontal
2	180.074	150	143	-61.28	-54.00	7.28	Pass	Horizontal
3	600.029	150	59	-59.75	-54.00	5.75	Pass	Horizontal
4	1343.4343	150	143	-49.68	-30.00	19.68	Pass	Horizontal
5	4824.0216	150	206	-47.95	-30.00	17.95	Pass	Horizontal
6	9349.6233	150	31	-48.74	-30.00	18.74	Pass	Horizontal
7	48.0438	150	136	-61.59	-54.00	7.59	Pass	Vertical
8	107.9958	150	3	-66.25	-54.00	12.25	Pass	Vertical
9	600.029	150	126	-62.64	-54.00	8.64	Pass	Vertical
10	1271.4271	150	136	-49.96	-30.00	19.96	Pass	Vertical
11	4824.0216	150	302	-49.53	-30.00	19.53	Pass	Vertical
12	9240.416	150	200	-48.32	-30.00	18.32	Pass	Vertical

Mode:		802.11 n(HT20) Transmitting						
Channel:		2462 MHz						
NO.	Freq. [MHz]	Height [cm]	Azimuth [deg]	Level [dBm]	Limit [dBm]	Margin [dB]	Result	Polarity
1	59.976	150	348	-64.02	-54.00	10.02	Pass	Horizontal
2	179.977	150	144	-62.00	-54.00	8.00	Pass	Horizontal
3	600.029	150	55	-59.77	-54.00	5.77	Pass	Horizontal
4	1221.4221	150	80	-49.16	-30.00	19.16	Pass	Horizontal
5	4944.2796	150	79	-46.86	-30.00	16.86	Pass	Horizontal
6	9691.5461	150	306	-47.17	-30.00	17.17	Pass	Horizontal
7	60.073	150	134	-62.95	-54.00	8.95	Pass	Vertical
8	207.4307	150	40	-69.45	-54.00	15.45	Pass	Vertical
9	600.029	150	124	-63.14	-54.00	9.14	Pass	Vertical
10	1334.0334	150	211	-50.09	-30.00	20.09	Pass	Vertical
11	4944.2796	150	69	-51.28	-30.00	21.28	Pass	Vertical
12	9731.8488	150	330	-47.13	-30.00	17.13	Pass	Vertical

## 2) Receiver spurious emissions test data

Remark: Through Pre-scan, for 20MHz Occupied Bandwidth, 802.11 b mode was the worst case; for 40MHz Occupied Bandwidth, 802.11 n(HT40) mode was the worst case; only the worst case was in the report.

ANT1:

Mode:		802.11 b Receiving						
Channel:		2412 MHz						
NO.	Freq. [MHz]	Height [cm]	Azimuth [deg]	Level [dBm]	Limit [dBm]	Margin [dB]	Result	Polarity
1	37.0817	150	27	-70.38	-57.00	13.38	Pass	Horizontal
2	166.6867	150	163	-63.28	-57.00	6.28	Pass	Horizontal
3	380.9811	150	4	-63.77	-57.00	6.77	Pass	Horizontal
4	1440.0595	150	151	-66.77	-47.00	19.77	Pass	Horizontal
5	5015.1758	150	27	-63.38	-47.00	16.38	Pass	Horizontal
6	9686.0343	150	0	-56.91	-47.00	9.91	Pass	Horizontal
7	36.8877	150	308	-63.73	-57.00	6.73	Pass	Vertical
8	178.7159	150	121	-65.03	-57.00	8.03	Pass	Vertical
9	796.5707	150	246	-65.91	-57.00	8.91	Pass	Vertical
10	2055.2028	150	146	-63.22	-47.00	16.22	Pass	Vertical
11	5760.163	150	208	-56.59	-47.00	9.59	Pass	Vertical
12	10371.0936	150	234	-56.72	-47.00	9.72	Pass	Vertical

Mode:		802.11 b Receiving						
Channel:		2472 MHz						
NO.	Freq. [MHz]	Height [cm]	Azimuth [deg]	Level [dBm]	Limit [dBm]	Margin [dB]	Result	Polarity
1	37.3727	150	189	-70.33	-57.00	13.33	Pass	Horizontal
2	214.2214	150	357	-64.67	-57.00	7.67	Pass	Horizontal
3	540.077	150	251	-66.06	-57.00	9.06	Pass	Horizontal
4	1440.0595	150	140	-66.87	-47.00	19.87	Pass	Horizontal
5	5014.5882	150	288	-63.12	-47.00	16.12	Pass	Horizontal
6	10688.9469	150	177	-57.58	-47.00	10.58	Pass	Horizontal
7	36.8877	150	309	-63.51	-57.00	6.51	Pass	Vertical
8	178.5219	150	122	-64.67	-57.00	7.67	Pass	Vertical
9	797.5408	150	3	-67.12	-57.00	10.12	Pass	Vertical
10	1197.9974	150	134	-66.71	-47.00	19.71	Pass	Vertical
11	2398.3199	150	3	-62.03	-47.00	15.03	Pass	Vertical
12	5760.163	150	208	-56.97	-47.00	9.97	Pass	Vertical

Mode:		802.11 n(HT40) Receiving						
Channel:		2422 MHz						
NO.	Freq. [MHz]	Height [cm]	Azimuth [deg]	Level [dBm]	Limit [dBm]	Margin [dB]	Result	Polarity
1	37.4697	150	126	-70.55	-57.00	13.55	Pass	Horizontal
2	214.1244	150	357	-67.27	-57.00	10.27	Pass	Horizontal
3	539.98	150	237	-65.14	-57.00	8.14	Pass	Horizontal
4	1440.0595	150	151	-66.54	-47.00	19.54	Pass	Horizontal
5	5005.7753	150	214	-63.38	-47.00	16.38	Pass	Horizontal
6	9700.7225	150	262	-57.15	-47.00	10.15	Pass	Horizontal
7	36.8877	150	208	-63.83	-57.00	6.83	Pass	Vertical
8	178.4248	150	146	-64.85	-57.00	7.85	Pass	Vertical
9	720.03	150	246	-65.09	-57.00	8.09	Pass	Vertical
10	1994.0997	150	355	-63.16	-47.00	16.16	Pass	Vertical
11	5760.163	150	197	-56.79	-47.00	9.79	Pass	Vertical
12	11210.0855	150	122	-56.19	-47.00	9.19	Pass	Vertical

Mode:		802.11 n(HT40) Receiving						
Channel:		2462 MHz						
NO.	Freq. [MHz]	Height [cm]	Azimuth [deg]	Level [dBm]	Limit [dBm]	Margin [dB]	Result	Polarity
1	37.3727	150	176	-70.51	-57.00	13.51	Pass	Horizontal
2	214.0274	150	357	-66.30	-57.00	9.30	Pass	Horizontal
3	539.98	150	251	-65.88	-57.00	8.88	Pass	Horizontal
4	1440.0595	150	151	-63.99	-47.00	16.99	Pass	Horizontal
5	2398.3199	150	76	-62.37	-47.00	15.37	Pass	Horizontal
6	9711.8856	150	349	-57.28	-47.00	10.28	Pass	Horizontal
7	37.1787	150	209	-63.43	-57.00	6.43	Pass	Vertical
8	178.4248	150	135	-64.75	-57.00	7.75	Pass	Vertical
9	750.006	150	320	-65.95	-57.00	8.95	Pass	Vertical
10	1791.9896	150	3	-63.63	-47.00	16.63	Pass	Vertical
11	5760.163	150	198	-56.88	-47.00	9.88	Pass	Vertical
12	9184.8717	150	160	-56.07	-47.00	9.07	Pass	Vertical

MIMO:

Mode:		802.11 n(HT20) Receiving						
Channel:		2422 MHz						
NO.	Freq. [MHz]	Height [cm]	Azimuth [deg]	Level [dBm]	Limit [dBm]	Margin [dB]	Result	Polarity
1	37.2757	150	175	-69.93	-57.00	12.93	Pass	Horizontal
2	202.8713	150	187	-60.08	-57.00	3.08	Pass	Horizontal
3	540.077	150	150	-65.70	-57.00	8.70	Pass	Horizontal
4	1592.8171	150	161	-67.44	-47.00	20.44	Pass	Horizontal
5	5016.9383	150	349	-63.80	-47.00	16.80	Pass	Horizontal
6	9706.5978	150	338	-57.58	-47.00	10.58	Pass	Horizontal
7	37.3727	150	221	-63.23	-57.00	6.23	Pass	Vertical
8	166.7837	150	48	-66.43	-57.00	9.43	Pass	Vertical
9	398.2488	150	209	-67.58	-57.00	10.58	Pass	Vertical
10	1394.2322	150	108	-62.01	-47.00	15.01	Pass	Vertical
11	5760.163	150	198	-54.54	-47.00	7.54	Pass	Vertical
12	10415.7458	150	286	-57.13	-47.00	10.13	Pass	Vertical

Mode:		802.11 n(HT20) Receiving						
Channel:		2462 MHz						
NO.	Freq. [MHz]	Height [cm]	Azimuth [deg]	Level [dBm]	Limit [dBm]	Margin [dB]	Result	Polarity
1	37.3727	150	139	-70.06	-57.00	13.06	Pass	Horizontal
2	128.0768	150	199	-63.76	-57.00	6.76	Pass	Horizontal
3	539.98	150	150	-65.91	-57.00	8.91	Pass	Horizontal
4	1440.0595	150	139	-68.81	-47.00	21.81	Pass	Horizontal
5	5018.1134	150	213	-63.17	-47.00	16.17	Pass	Horizontal
6	9761.8256	150	114	-57.01	-47.00	10.01	Pass	Horizontal
7	37.2757	150	295	-62.16	-57.00	5.16	Pass	Vertical
8	167.1717	150	48	-65.41	-57.00	8.41	Pass	Vertical
9	830.33	150	59	-64.57	-57.00	7.57	Pass	Vertical
10	1395.4073	150	122	-62.26	-47.00	15.26	Pass	Vertical
11	5760.163	150	208	-55.32	-47.00	8.32	Pass	Vertical
12	10371.0936	150	219	-55.02	-47.00	8.02	Pass	Vertical



**PHOTOGRAPHS OF TEST SETUP**

Test model No.: BeaglePlay



**Radiated spurious emission Test Setup-1(Below 1GHz)**

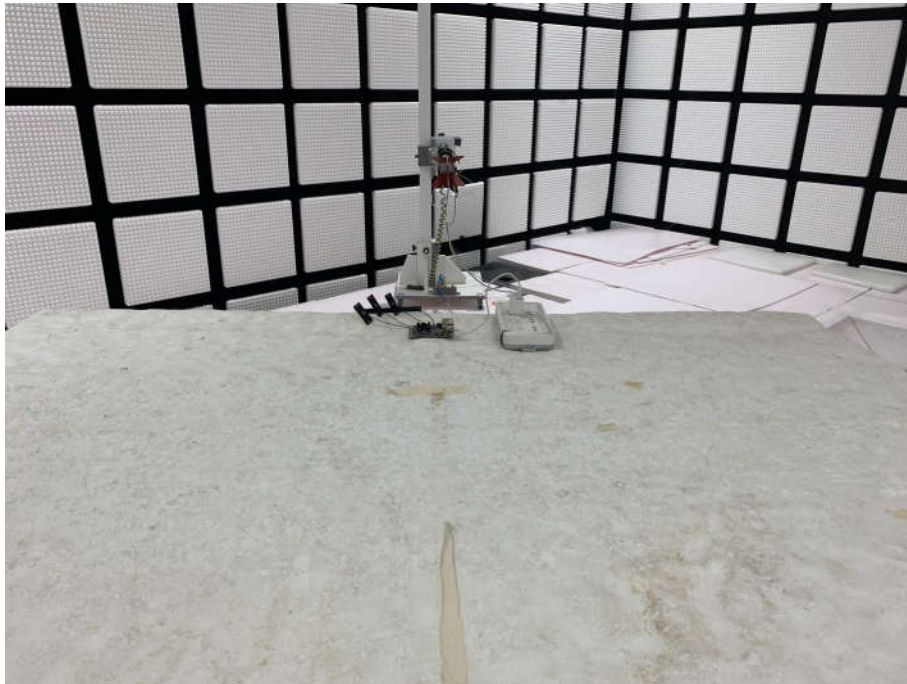

**Radiated spurious emission Test Setup-2(Above 1GHz)**



## PHOTOGRAPHS OF EUT Constructional Details

Refer to Report No. EED32P80002201 for EUT external and internal photos.

The test report is effective only with both signature and specialized stamp, the result(s) shown in this report refer only to the sample(s) tested. Without written approval of CTI, this report can't be reproduced except in full.

\*\*\* End of Report \*\*\*

## IMPORTANT NOTICE AND DISCLAIMER

TI PROVIDES TECHNICAL AND RELIABILITY DATA (INCLUDING DATA SHEETS), DESIGN RESOURCES (INCLUDING REFERENCE DESIGNS), APPLICATION OR OTHER DESIGN ADVICE, WEB TOOLS, SAFETY INFORMATION, AND OTHER RESOURCES "AS IS" AND WITH ALL FAULTS, AND DISCLAIMS ALL WARRANTIES, EXPRESS AND IMPLIED, INCLUDING WITHOUT LIMITATION ANY IMPLIED WARRANTIES OF MERCHANTABILITY, FITNESS FOR A PARTICULAR PURPOSE OR NON-INFRINGEMENT OF THIRD PARTY INTELLECTUAL PROPERTY RIGHTS.

These resources are intended for skilled developers designing with TI products. You are solely responsible for (1) selecting the appropriate TI products for your application, (2) designing, validating and testing your application, and (3) ensuring your application meets applicable standards, and any other safety, security, regulatory or other requirements.

These resources are subject to change without notice. TI grants you permission to use these resources only for development of an application that uses the TI products described in the resource. Other reproduction and display of these resources is prohibited. No license is granted to any other TI intellectual property right or to any third party intellectual property right. TI disclaims responsibility for, and you will fully indemnify TI and its representatives against, any claims, damages, costs, losses, and liabilities arising out of your use of these resources.

TI's products are provided subject to [TI's Terms of Sale](#) or other applicable terms available either on [ti.com](https://www.ti.com) or provided in conjunction with such TI products. TI's provision of these resources does not expand or otherwise alter TI's applicable warranties or warranty disclaimers for TI products.

TI objects to and rejects any additional or different terms you may have proposed.

Mailing Address: Texas Instruments, Post Office Box 655303, Dallas, Texas 75265  
Copyright © 2023, Texas Instruments Incorporated