

Using CC2591 Front End with CC2530/1

By Espen Slette and Michael Paszowski

Keywords

- 2.4 GHz IEEE 802.15.4 systems
- ZigBee® systems
- Range Extender
- External PA
- External LNA
- CC2530
- CC2531
- CC2591

1 Introduction

The CC2530 is TI's second generation ZigBee® / IEEE 802.15.4 RF System-on-Chip (SoC) for the 2.4 GHz unlicensed ISM band. This chip enables industrial grade applications by offering state-of-the-art selectivity/co-existence, excellent link budget, and low voltage operation. The CC2531 is identical to the CC2530 with the addition of an USB interface

CC2591 is a range extender for 2.4-GHz RF transceivers, transmitters and SoC products from Texas Instruments. CC2591 increases the link budget by providing a Power Amplifier (PA) for higher output power and a Low Noise Amplifier (LNA) for improved receiver sensitivity. CC2591 further contains RF switches, RF matching, and a balun for a seamless interface with the CC2530. This allows for simple design of high performance wireless applications.

This application note describes how to implement the CC2530 and the CC2591 in the same design. It further describes the expected performance from this combination as well as important factors to consider with respect to the layout and regulatory requirements. The combined CC2530 and CC2591 solution is suitable for systems targeting compliance with FCC CFR47 Part 15.

The RF front end of CC2530 is the same as the ones being used in CC2531. The presented results in this application note are therefore also valid for CC2531.

Texas Instruments ZigBee SW solution, Z-Stack (www.ti.com/z-stack), includes the necessary SW changes for using the CC2591. For details the reader is referred to the "PA/LNA Service" chapter in the "HAL Driver API.pdf" document included in the Z-Stack documents folder.

Table of Contents

KEYWORDS	1
1 INTRODUCTION	1
2 ABBREVIATIONS	2
3 ABSOLUTE MAXIMUM RATINGS	3
4 ELECTRICAL SPECIFICATIONS	3
4.1 OPERATING CONDITIONS	3
4.2 CURRENT CONSUMPTION	3
4.3 RECEIVE PARAMETERS	4
4.4 RECEIVED SIGNAL STRENGTH INDICATOR (RSSI).....	4
4.5 TRANSMIT PARAMETERS	5
4.6 OUTPUT POWER PROGRAMMING	5
4.7 TYPICAL PERFORMANCE CURVES	6
4.8 IEEE - TRANSMIT POWER SPECTRAL DENSITY (PSD) MASK.....	8
5 APPLICATION CIRCUIT	9
5.1 POWER DECOUPLING AND RF LOADING	9
5.2 INPUT/ OUTPUT MATCHING AND FILTERING.....	9
5.3 BIAS RESISTOR	10
5.4 ANTENNA CONSIDERATIONS	10
6 PCB LAYOUT CONSIDERATIONS	11
6.1 CC2530 – CC2591 STABILITY	11
6.2 THE GAIN OF THE CC2591.....	12
7 REGULATORY REQUIREMENTS	13
7.1 DUTY CYCLING WHEN COMPLYING WITH FCC.....	14
7.2 COMPLIANCE OF FCC PART 15.247 WHEN USING THE CC2530 WITH THE CC2591	14
8 CONTROLLING THE CC2591	17
9 REFERENCES	19
10 GENERAL INFORMATION	19
10.1 DOCUMENT HISTORY.....	19

2 Abbreviations

SoC	System-on-Chip
DSSS	Direct Sequence Spread Spectrum
EIRP	Equivalent Isotropically Radiated Power
EM	Evaluation Module
EVM	Error Vector Magnitude
ISM	Industrial, Scientific, Medical
FCC	Federal Communications Commission
FHSS	Frequency Hopping Spread Spectrum
LNA	Low Noise Amplifier
PA	Power Amplifier
PCB	Printed Circuit Board
PSD	Power Spectral Density
RF	Radio Frequency
RSSI	Receive Signal Strength Indicator
RX	Receive, Receive Mode
TX	Transmit, Transmit Mode
VSWR	Voltage Standing Wave Ratio

3 Absolute Maximum Ratings

The absolute maximum ratings and operating conditions listed in the CC2530 datasheet [1] and the CC2591 datasheet [4] must be followed at all times. Stress exceeding one or more of these limiting values may cause permanent damage to any of the devices.

4 Electrical Specifications

Note that these characteristics are only valid when using the recommended register settings presented in Section 4.6 and in Chapter 8, and the CC2530 - CC2591EM reference design.

4.1 Operating Conditions

Parameter	Min	Max	Unit
Operating Frequency	2405	2483.5	MHz
Operating Supply Voltage	2.0	3.6	V
Operating Temperature	-40	85	°C

Table 4.1 Operating Conditions

4.2 Current Consumption

$T_C = 25^\circ\text{C}$, $V_{DD} = 3.0\text{ V}$, $f = 2440\text{ MHz}$ if nothing else is stated. All parameters are measured on the CC2530 - CC2591EM reference design [11] with a $50\ \Omega$ load.

Parameter	Condition	Typical	Unit
Receive Current	Wait for sync, -90 dBm input level	27	mA
	Wait for sync, -50 dBm input level	24	mA
Transmit Current	TXPOWER = 0xE5	166	mA
	TXPOWER = 0xD5	149	mA
	TXPOWER = 0xC5	138	mA
	TXPOWER = 0xB5	127	mA
	TXPOWER = 0xA5	115	mA
	TXPOWER = 0x95	100	mA
	TXPOWER = 0x85	94	mA
	TXPOWER = 0x75	86	mA
	TXPOWER = 0x65	79	mA
Power Down Current	PM2	1	uA

Table 4.2 Current Consumption

4.3 Receive Parameters

$T_C = 25^\circ\text{C}$, $V_{DD} = 3.0\text{ V}$, $f = 2440\text{ MHz}$ if nothing else is stated. All parameters are measured on the CC2530 - CC2591EM reference design with a $50\ \Omega$ load.

Parameter	Condition	Typical	Unit
Receive Sensitivity HGM	1 % PER, IEEE 802.15.4 [6] requires -85 dBm	-98.8	dBm
Receive Sensitivity LGM	1 % PER, IEEE 802.15.4 [6] requires -85 dBm	-90.4	dBm
Saturation	IEEE 802.15.4 [6] requires -20 dBm	10	dBm
Interferer Rejection	Wanted signal 3 dB above the sensitivity level, IEEE 802.15.4 modulated interferer at IEEE 802.15.4 channels		
	$\pm 5\text{ MHz}$ from wanted signal, IEEE 802.15.4 [6] requires 0 dB	35	dB
	$\pm 10\text{ MHz}$ from wanted signal, IEEE 802.15.4 [6] requires 30 dB	49	dB
	$\pm 20\text{ MHz}$ from wanted signal. Wanted signal at -82dBm	56	dB

Table 4.3 Receive Parameters

4.4 Received Signal Strength Indicator (RSSI)

Due to in the external LNA and the offset in CC2530 the RSSI readouts from CC2530 - CC2591 is different from RSSI offset values for a standalone CC2530 design. The offset values are shown in Table 4.4.

CC2530-CC2591EM LNA mode	RSSI offset ¹
High Gain Mode	79
Low Gain Mode	67

Table 4.4 RSSI Compensation

¹ Real RSSI = Register value – RSSI offset

4.5 Transmit Parameters

$T_C = 25^\circ\text{C}$, $V_{DD} = 3.0\text{ V}$, $f = 2440\text{ MHz}$ if nothing else is stated. All parameters are measured on the CC2530 - CC2591EM reference design with a $50\ \Omega$ load. Radiated measurements are done with the kit antenna.

Parameter	Condition	Typical	Unit
Radiated Emission with TXPOWER = 0xE5 Complies with FCC 15.247. See Chapter 7 for more details about regulatory requirements and compliance	Conducted 2-RF (FCC restricted band)	-46.2	dBm
	Conducted 3-RF (FCC restricted band)	-46.5	dBm
	Radiated 2-RF (FCC restricted band)	-42.2	dBm
Max Error Vector Magnitude (EVM)	IEEE 802.15.4 [6] requires max. 35% Measured as defined by IEEE 802.15.4 [6]		
	TXPOWER = 0xE5, f = IEEE 802.15.4 channels	13	%
	TXPOWER = 0xD5, f = IEEE 802.15.4 channels	6	%
	TXPOWER = 0xC5, f = IEEE 802.15.4 channels	4	%
	TXPOWER = 0xB5, f = IEEE 802.15.4 channels	3	%
	TXPOWER = 0xA5, f = IEEE 802.15.4 channels	3	%
	TXPOWER = 0x95, f = IEEE 802.15.4 channels	3	%
	TXPOWER = 0x85, f = IEEE 802.15.4 channels	3	%
	TXPOWER = 0x75, f = IEEE 802.15.4 channels	3	%
TXPOWER = 0x65, f = IEEE 802.15.4 channels	2	%	

Table 4.5 Transmit Parameters

4.6 Output Power Programming

The RF output power of the CC2530 - CC2591EM is controlled by the 7-bit value in the CC2530 TXPOWER register. Table 4.6 shows the typical output power and current consumption for the recommended power settings. The results are given for $T_C = 25^\circ\text{C}$, $V_{DD} = 3.0\text{ V}$ and $f = 2440\text{ MHz}$, and are measured on the CC2530 - CC2591EM reference design with a $50\ \Omega$ load. For recommendations for the remaining CC2530 registers, see Chapter 8 or use the settings given by SmartRF Studio.

TXPOWER	Power [dBm]	Current [mA]
0xE5	20	166
0xD5	19	149
0xC5	18	138
0xB5	17	127
0xA5	16	115
0x95	14.5	100
0x85	13	94
0x75	11.5	86
0x65	10	79

Table 4.6 Power Table

Note that the recommended power settings given in Table 4.6 are a subset of all the possible TXPOWER register settings. However, using other settings than those recommended might

result in suboptimal performance in areas like current consumption, EVM, and spurious emission.

4.7 Typical Performance Curves

$T_C = 25^\circ\text{C}$, $V_{DD} = 3.0\text{ V}$, $f = 2440\text{ MHz}$ if nothing else is stated. All parameters are measured on the CC2530 - CC2591EM reference design with a $50\ \Omega$ load.

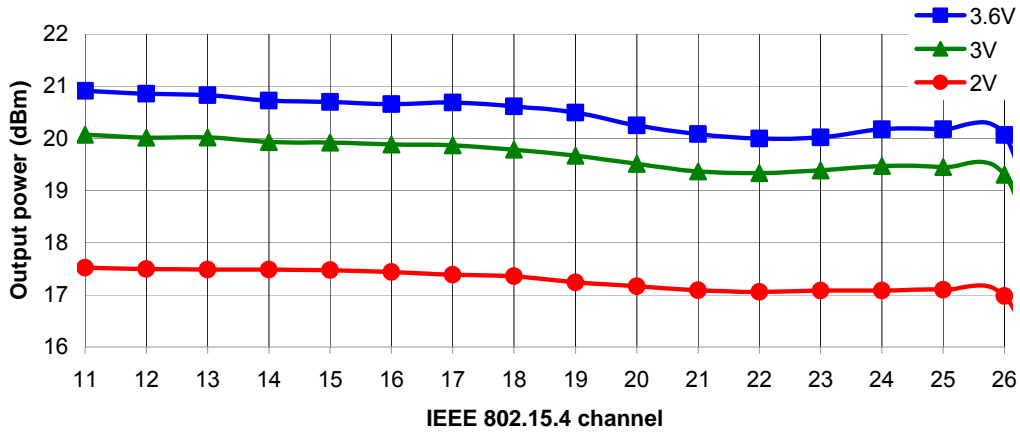

Figure 4.1 Output Power vs. Frequency and Power Supply Voltage, TXPOWER = 0xE5

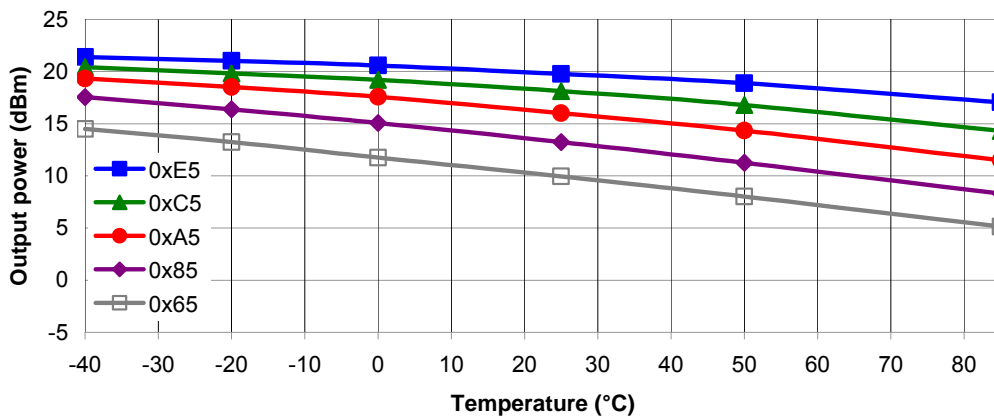

Figure 4.2 Output Power vs. Temperature

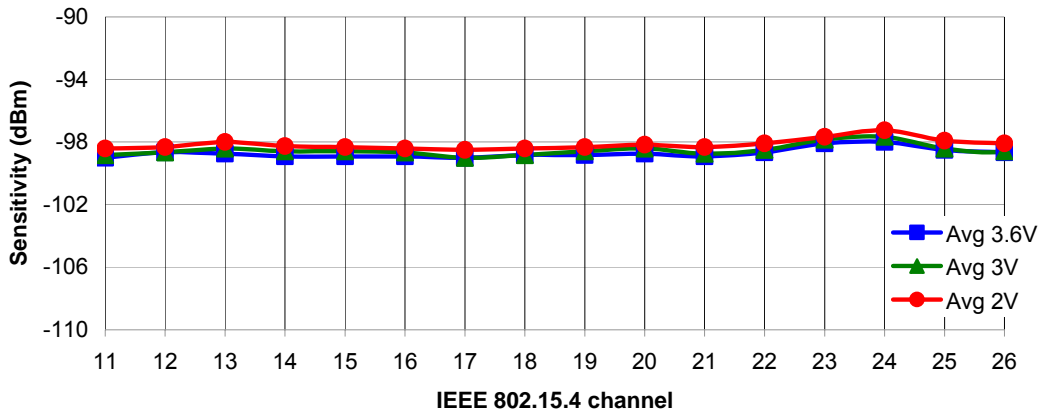

Figure 4.3 Sensitivity vs. Frequency and Power Supply Voltage

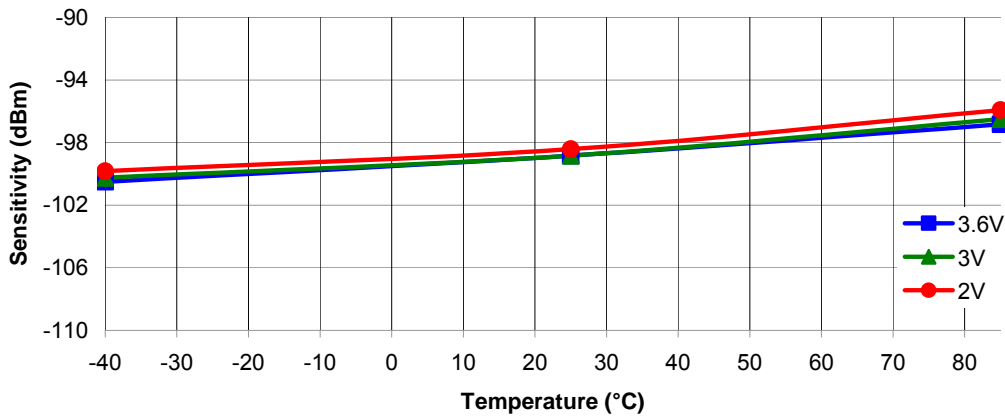

Figure 4.4 Sensitivity vs. Temperature and Power Supply Voltage

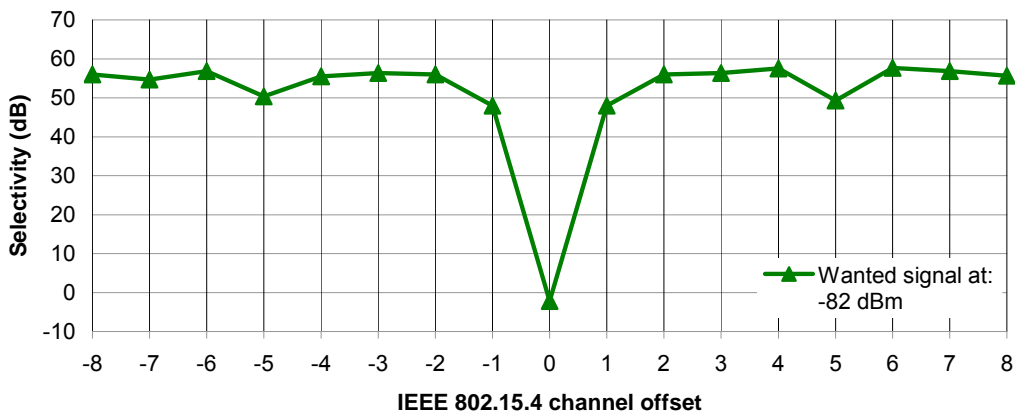

Figure 4.5 Selectivity Operating at Channel 18 (2440 MHz)

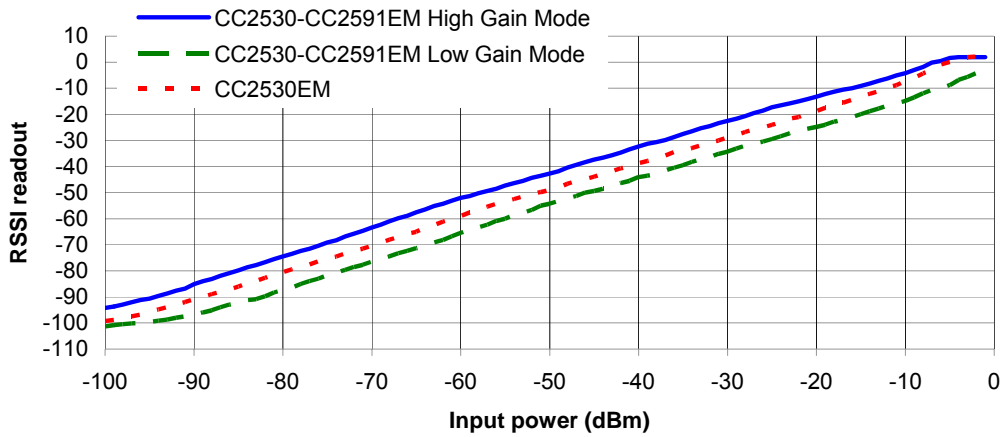

Figure 4.6 RSSI Readout vs. Input Power

4.8 IEEE - Transmit power spectral density (PSD) mask

The IEEE standard 802.15.4 [8] requires the transmitted spectral power to be less than the limits specified in Table 4.7.

Frequency	Relative limit	Absolute limit
$ f - f_c > 3.5 \text{ MHz}$	-20 dB	-30 dBm

Table 4.7 Transmit PSD limits

The results below are given for $T_C = 25^\circ\text{C}$, $V_{DD} = 3.0 \text{ V}$ and $f = 2440 \text{ MHz}$, and are measured on the CC2530 - CC2591EM reference design with a 50Ω load.

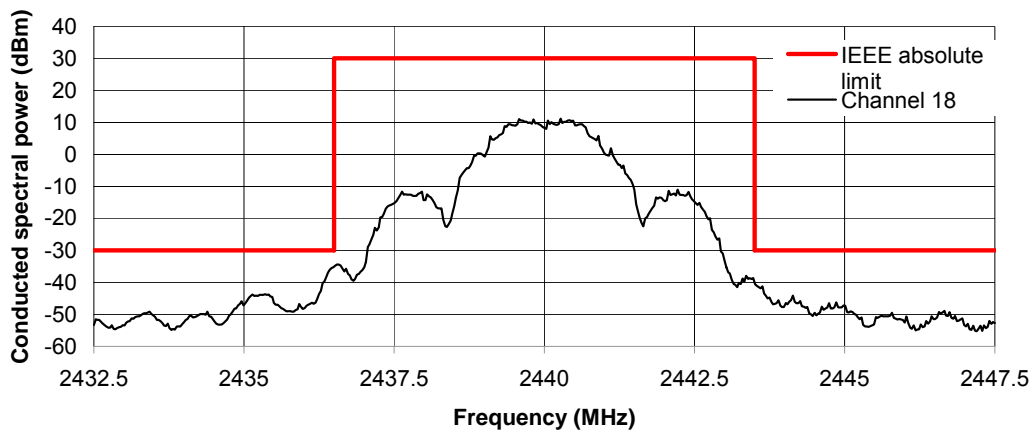

Figure 4.7 Conducted power spectral density, TXPOWER = 0xE5

5 Application Circuit

Only a few external components are required for the CC2530 - CC2591 reference design. A typical application circuit is shown below in Figure 5.1. Note that the application circuit figure does not show how the board layout should be done. The board layout will greatly influence the RF performance of the CC2530 - CC2591EM. TI provides a compact CC2530 - CC2591EM reference design that it is highly recommended to follow. The layout, stack-up and schematic for the CC2591 need to be copied exactly to obtain good performance. Note that the reference design also includes bill of materials with manufacturers and part numbers.

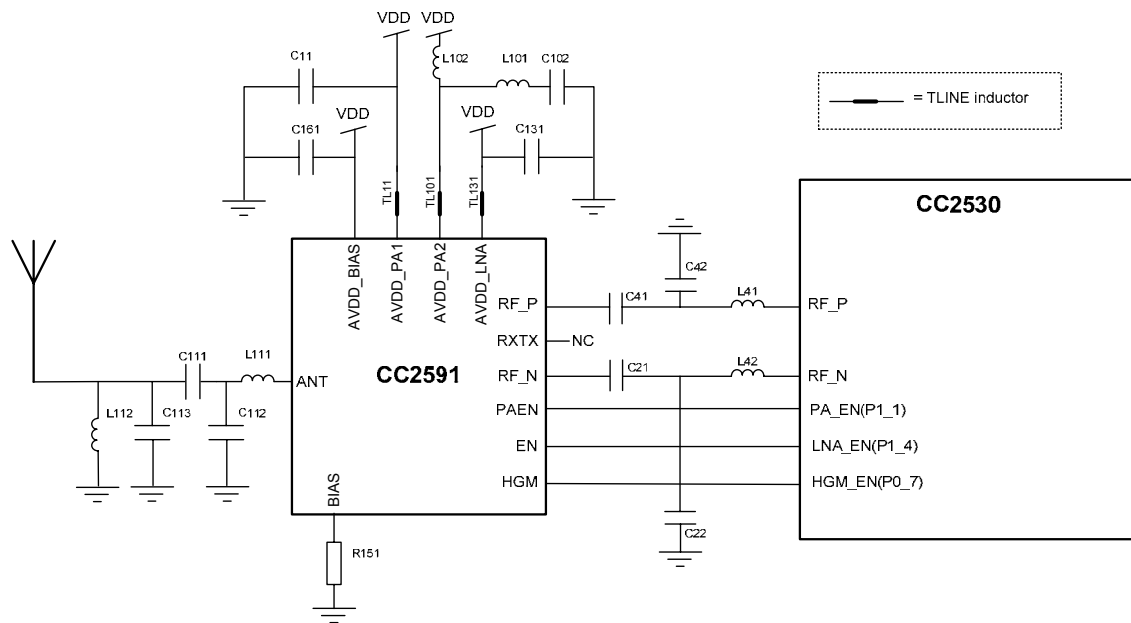

Figure 5.1 Application Circuit for the CC2530 with CC2591

5.1 Power Decoupling and RF Loading

Proper power supply decoupling must be used for optimum performance. In Figure 5.1, only the decoupling components for the CC2591 are shown. This is because, in addition to decoupling, the parallel capacitors C11, C101, and C131 together with, L101, L102, TL11, TL101 and TL131 also work as RF loads. These therefore ensure the optimal performance from the CC2591. C161 decouples the AVDD_BIAS power.

The placement and size of the decoupling components, the power supply filtering and the PCB transmission lines are very important to achieve the best performance. Details about the importance of copying the CC2530 - CC2591EM reference design exactly and potential consequences of changes are explained in chapter 6.

5.2 Input/ Output Matching and Filtering

The RF input/output of CC2530 is high impedance and differential. The CC2591 includes a balun and a matching network in addition to the PA, LNA and RF switches which makes the interface to the CC2530 seamless. Only a few components between the CC2530 and CC2591 necessary for RF matching. For situation with extreme mismatch (VSWR 6:1 till 12:1 out-of-band as shown in Figure 6.2) it is recommended to include all the components as shown in Figure 5.1.

Application Note AN086

Note that the PCB transmission lines that connect the two devices also are part of the RF matching. It is therefore important to copy the distance between the devices, the transmission lines and the stack-up of the PCB according to the reference design to ensure optimum performance.

The network between the CC2591 and the antenna (L111, C112, C111 C113 and L112) matches the CC2591 to a 50 Ω load and provides filtering to pass regulatory demands. C111 also works as a DC-block.

5.3 Bias resistor

R151 is a bias resistor. The bias resistor is used to set an accurate bias current for internal use in the CC2591.

5.4 Antenna Considerations

The TI reference design contains two antenna options. As default, the SMA connector is connected to the output of CC2591 through a 0 Ω resistor. This resistor can be soldered off and rotated 90° clockwise in order to connect to the PCB antenna, which is a planar inverted F antenna (PIFA). Note that all testing and characterization has been done using the SMA connector. The PCB antenna has only been functionally tested by establishing a link between two EMs. Please refer to the antenna selection guide [6] and the Inverted F antenna design note [7] for further details on the antenna solutions.

6 PCB Layout Considerations

The Texas Instruments reference design uses a 1.6 mm (0.062”) 4-layer PCB solution. Note that the different layers have different thickness; it is important to follow the recommendation given in the CC2530 - CC2591EM reference design [11] to ensure optimum performance.

The top layer is used for components and signal routing, and the open areas are filled with metallization connected to ground using several vias. The areas under the two chips are used for grounding and must be well connected to the ground plane with multiple vias. Footprint recommendation for the CC2591 is given in the CC2591 datasheet [4].

Layer two is a complete ground plane and is not used for any routing. This is done to ensure short return current paths. The low impedance of the ground plane prevents any unwanted signal coupling between any of the nodes that are decoupled to it. A dedicated ground plane is also needed to improve stability (see Section 6.1). Layer three is a power plane. The power plane ensures low impedance traces at radio frequencies and prevents unwanted radiation from power traces. Layer four is used for routing, and as for layer one, open areas are filled with metallization connected to ground using several vias.

Important Notice

Changes in the PCB stack-up, component value, vendors, sizes or placements can cause significant effects on the performance of the combined CC2530 and CC2591 solution. Any change can cause higher current consumption, oscillations of the CC2591, unwanted spurious emissions and generally degraded performance. It is strongly advised that the reference design [3] is followed as closely as possible in order to obtain the best performance.

6.1 CC2530 – CC2591 Stability

When a common, center ground-pin/paddle is used, all inductance seen between this ground paddle and the ground plane will give rise to feedback. This feedback might give rise to oscillations. There is no general rule that tells exactly how much inductance that exists between the ground paddle and the ground plane – it depends on the chip design. Still, a general rule of thumb is that chances of oscillations increase when the RF currents increase. The stability issue is the main reason for using a 4-layer PCB with a ground-plane close to the top layer of the CC2530 - CC2591EM reference design [11].

It is generally accepted that an antenna is useful only within the bandwidth at which the VSWR is 2:1 or lower, with 1.5:1 often cited as the maximum acceptable VSWR. The CC2530 - CC2591EM reference design [11] has been tested with two different matching conditions. One with a 50Ω connection and another that have a mismatch of VSWR 2:1 within the operating frequency band and the mismatch out of the operating area is between 6:1 and 12:1, see Figure 6.2. The stable regions of the CC2530-CC2591EM is shown in Figure 6.1 where the register setting in the figure show the maximum acceptable power setting and the mismatch region where the CC2530-CC2591EM is stable.

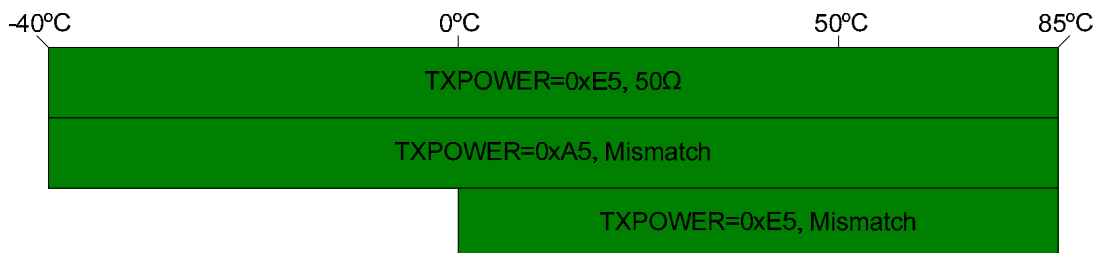

Figure 6.1 Stability vs. temperature

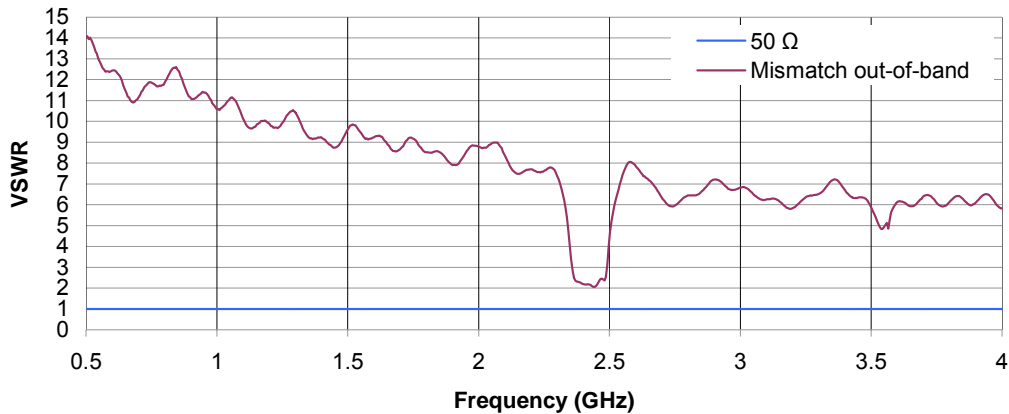

Figure 6.2 VSWR

6.2 The Gain of the CC2591

Changing the layout or the stack-up of the reference design [11] affects the gain of the CC2591. This is because the gain of the CC2591 can be viewed as a function of both the on-chip capacitance and impedance and the external impedance contributions. Internal on-chip routing and capacitance, bond wires (often several in parallel), the PCB transmission lines, the thermal relieves on the decoupling capacitors' ground nodes, capacitance and parasitic of the decoupling capacitors, the inductance of the vias to the ground plane and the soldering of the chip will therefore contribute to the actual performance of the CC2591. A simplified model of all of these contributions is shown in Figure 6.3.

Due to all the contributors to the CC2591 performance, several observations can be made on how changing layout and PCB stack-up affects the amplifier:

- Misplacing the decoupling capacitor or using an arbitrary capacitor will change the inductance, and hence move the resonance frequency of the amplifier, i.e. the frequency with maximum gain.
- Bad soldering of the ground paddle can reduce the gain significantly.
- Too few or too long vias will reduce the gain significantly. This is why a checkered pattern of vias/ solder paste and a 4-layer PCB with the ground plane close to the top layer has been chosen for the CC2530 - CC2591EM reference design.

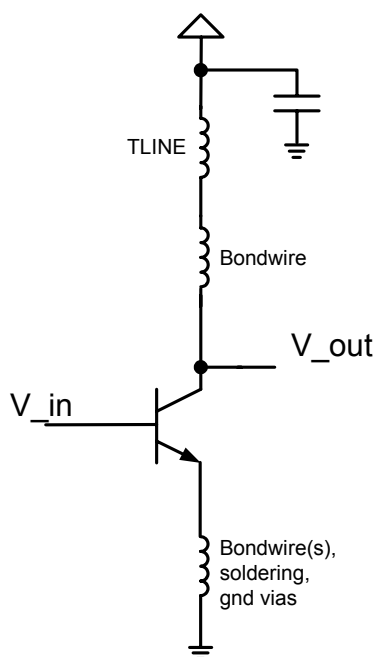

Figure 6.3 Simplified Model of the Impedance Contributors in the CC2591 Design

7 Regulatory Requirements

In the United States, the Federal Communications Commission (FCC) is responsible for the regulation of all RF devices. CFR 47, Part 15, regulates RF products intended for unlicensed operation. A product intended for unlicensed operation has to be subject to compliance testing. If the product is approved, the FCC will issue an identification number.

The specific frequency bands used for unlicensed radio equipment for the 2.4 GHz band are regulated by section 15.247 and 15.249. General rules for certification measurements are found in section 15.35. Restricted bands and general limits for spurious emissions are found in sections 15.205 and 15.209.

The CC2530 - CC2591EM reference design [11] has been tested for compliance with FCC Part 15.247. While it is not a formal certification, it does give a good representation of emissions with respect to compliance requirements. The FCC Part 15.247 compliance is generally a tougher requirement than ETSI compliance (EN 300 328) due to the restricted bands of operation. There are however requirements with regards to ETSI compliance (EN 300 328) that prevents operation at maximum output power. The clause 4.3.2.2 Maximum Power Spectral Density requirement of EN 300 328 requires maximum +10 dBm/ 1 MHz. The output power must therefore be reduced to approximately +12 dBm in order to get CE approval. The final output power level will depend on the antenna used.

The CC2590 is a pin and function compatible device that is optimized for operation in systems designed to be ETSI compliant

FCC Part 15.247 limits the output power to 1 W or +30 dBm when Direct Sequence Spread Spectrum (DSSS) modulation or Frequency Hopping Spread Spectrum (FHSS) with at least 75 hop channels is used. The spectral density of digital modulation systems (not including FHSS) shall not exceed 8 dBm/ 3 kHz. The minimum 6 dB bandwidth of such systems is 500 kHz. Since the CC2530 is an IEEE 802.15.4 compliant transceiver, it uses DSSS modulation. The +30 dBm limit therefore apply for the CC2530 with the CC2591 combination.

When complying with Part 15.247, in any 100 kHz bandwidth outside the operating band, the power level shall be at least 20 dB below the level in the 100 kHz bandwidth with the highest power level in the operating band. Attenuation below limits given in 15.209 is not required. Emission that fall within restricted bands (15.205) must meet general limits given in 15.209. This is summarized in Table 7.1 below. More details about the 2.4 GHz FCC regulations are found in application note AN032 [9].

Standard	Relevant Frequency	Radiated Power (EIRP)	Conducted Power	Comment
FCC 15.247	2400 – 2483.5 MHz		+30 dBm	Maximum 6 dBi antenna gain
	Restricted bands defined by 15.205, including the 2 nd , 3 rd and 5 th harmonics	-41.2 dBm		
	All frequencies not covered in above cells		-20 dBc	

Table 7.1 Summarized FCC 15.247 Regulations for the 2.4 GHz Band

7.1 Duty Cycling when Complying with FCC

For frequencies above 1 GHz, the field strength limits are based on average limits. When using an averaging detector, a minimum bandwidth of 1 MHz shall be employed and the measurement time shall not exceed 100 ms.

Due to the averaging detector, pulsed transmissions are allowed higher peak fundamental, harmonic, and spurious power. This is a benefit for duty-cycled transmissions. The relaxation factor is $20 \log(\text{TX on-time}/100 \text{ ms})$ [dB]. A 50 % duty cycle will therefore allow for 6 dB higher peak emission than without duty cycling. Notice however that, even when an averaging detector is called for, there is still a limit on emissions measured using a peak detector function with a limit 20 dB above the average limit.

7.2 Compliance of FCC Part 15.247 when using the CC2530 with the CC2591

When using CC2530 with the CC2591, duty cycling or back-off is only needed for highest IEEE 802.15.4 channel (channel 26) to comply with FCC at maximum recommended output power (TXPOWER = 0xE5). Table 7.2 below shows the duty cycling or back-off needed to comply with the FCC Part 15.247 limits at typical conditions ($T_C = 25^\circ\text{C}$, VDD = 3.0 V, TXPOWER = 0xE5). ZigBee and IEEE 802.15.4 systems are however typically low duty cycle systems. Note that the numbers in Table 7.2 are based on conducted emission measurements from the CC2530 - CC2591EM reference design [11]. The real required duty cycling or back-off may be different for applications with different antennas, plastic covers, or other factors that amplify/ attenuate the radiated power.

Figure 7.1 below shows the level of the conducted spurious emission and margins to the FCC Part 15.247 limits for the IEEE 802.15.4 channels under typical conditions ($T_C = 25^\circ\text{C}$, VDD = 3.0 V) when transmitting at maximum recommended power (TXPOWER = 0xE5) using the CC2530 - CC2591EM [11]. Figure 7.2 and Figure 7.3 show the margins versus the FCC 15.247 for the lowest frequency channels at the lower band edge and for the upper frequency channels at the upper band edge respectively. At the band edge the FCC allows for a Marker-delta method measurement [10] to determine the amount of back off or duty cycle needed to comply with the FCC Part 15.247. With Marker-delta method the field strength of the in-band fundamental frequency is subtracted from the difference between the highest fundamental emission level measured with a lower reference bandwidth and the emission level at the band edge, as shown in Figure 7.3.

Frequency [MHz]	Back-Off [dB]	Duty Cycle
2405	0	100%
2410	0	100%
2415	0	100%
2420	0	100%
2425	0	100%
2430	0	100%
2435	0	100%
2440	0	100%
2445	0	100%
2450	0	100%
2455	0	100%
2460	0	100%
2465	0	100%
2470	0	100%
2475	0	100%
2480	9.3	34%

Table 7.2 Duty-Cycle or Back-Off Requirement for FCC Part 15.247 Compliance under Typical Conditions

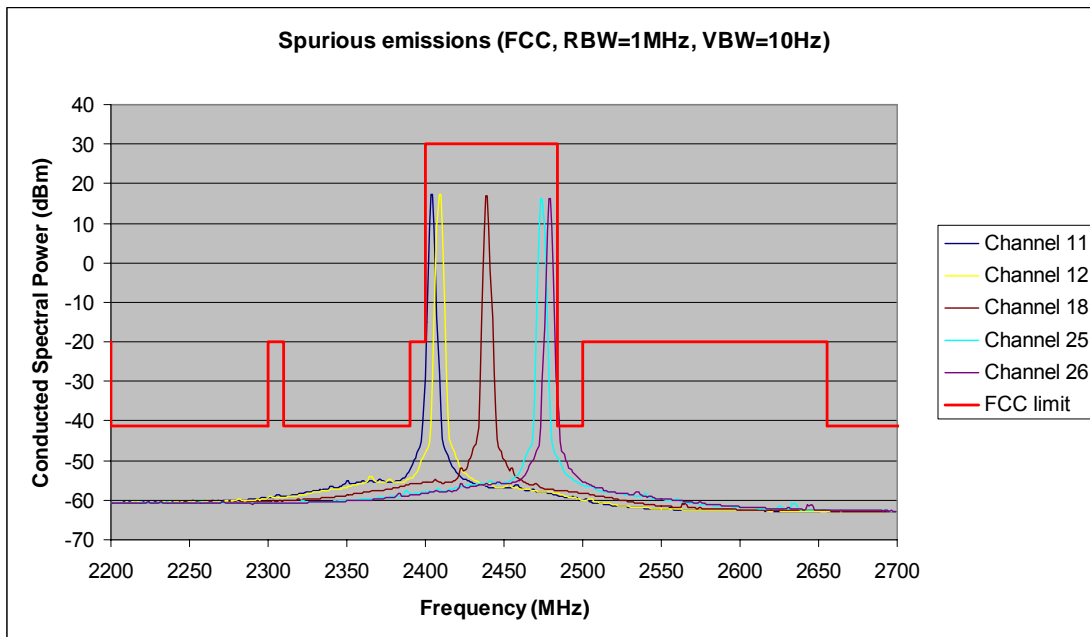

Figure 7.1 Conducted Spurious Emission vs. FCC Part 15.247 Limit (TXPOWER = 0xE5, RBW = 1 MHz, VBW = 10 Hz)

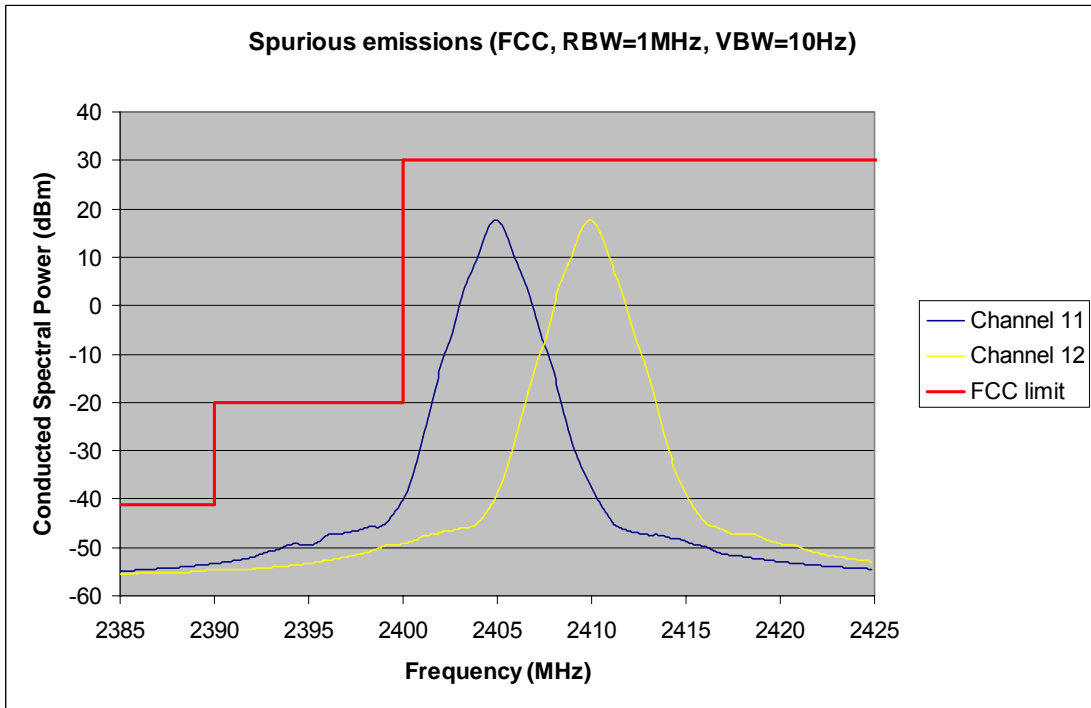

Figure 7.2 Conducted Spurious Emission, Lower Band Edge (TXPOWER = 0xE5, RBW = 1 MHz, VBW = 10 Hz)

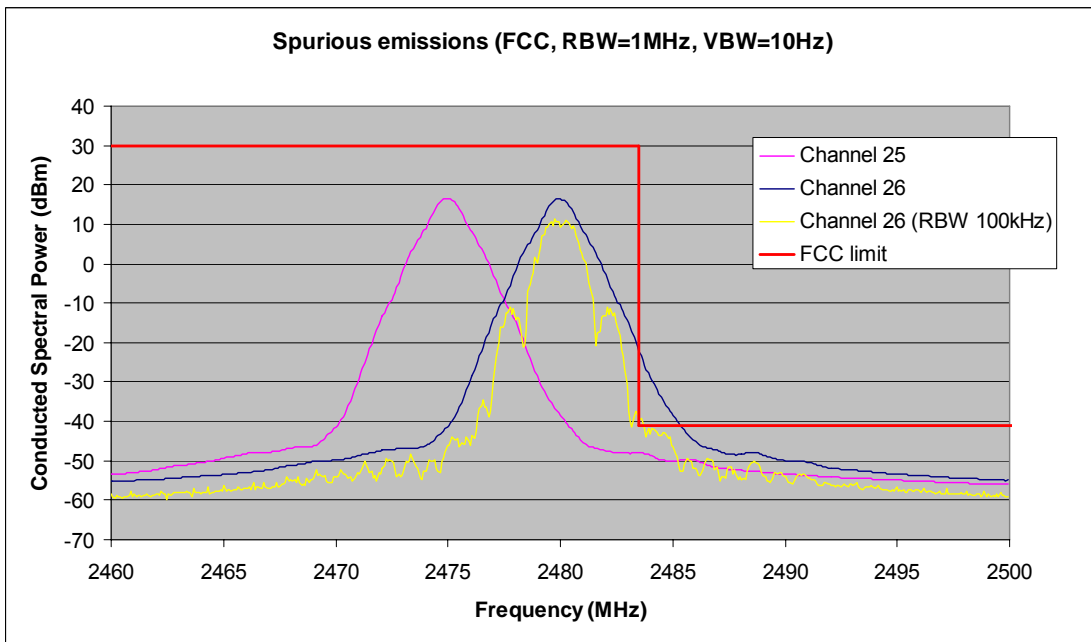

Figure 7.3 Conducted Spurious Emission, Upper Band Edge (TXPOWER = 0xE5, RBW = 1 MHz (100 kHz), VBW = 10 Hz)

8 Controlling the CC2591

There are four digital control pins (PAEN, EN, HGM, and RXTX) on the CC2591 controls the state the chip is in. Table 8.1 below shows the control logic when connecting the CC2591 to a CC2530 device.

PAEN	EN	RXTX	HGM	Mode of Operation
0	0	NC	X	Power Down
0	1	NC	0	RX LGM
0	1	NC	1	RX HGM
1	0	NC	X	TX
1	1	NC	X	Not allowed

Table 8.1 Control Logic for Connecting the CC2591 to a CC2530 Device

The CC2530 – CC2591EM reference design from TI uses three of the CC2530 GPIO pins on the CC2530 to control the CC2591. The I/O pins used is shown in Figure 8.1.

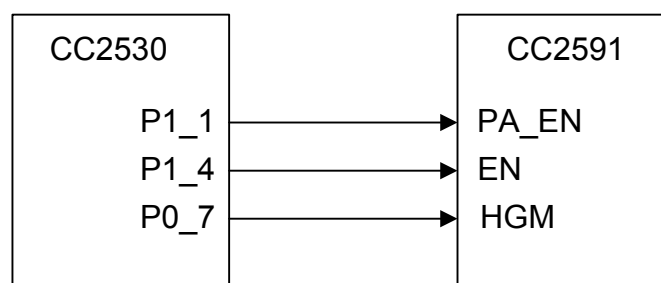

Figure 8.1 CC2530-CC2591 Interconnect

For details how to configure the software to use the control signal and how to change I/O pins to control the CC2591, please see [5].

When using the configuration used in the CC2530 – CC2591EM reference design, the registers listed in Table 8.2 need to be changed from the recommended CC2530 settings to control the CC2591 and give optimum performance. The new recommended values are listed in Table 8.2.

CC2530 REGISTER	ADDRESS	RECOMMENDED VALUE
AGCTRL1	0x61B2	0x15
FSCAL1 ²	0x61AE	0x00
RFC_OBS_CTRL0	0x61EB	0x68
RFC_OBS_CTRL1	0x61EC	0x6A
TXPOWER	0x6190	See Table 4.6
OBSSEL1	0x6244	0xFB
OBSSEL4	0x6247	0xFC
P0DIR	0xFD	0x80

Table 8.2 New Recommended Register Settings for the CC2530 - CC2591 combination

² AGCTRL1 and FSCAL1 do not need to be changed in order to control the CC2591, but are listed for completeness as they need to be updated from their default value. For more information see CC253x User Guide [4].

Application Note AN086

All the recommended register CC2530 settings when including the CC2591 are automatically implemented in SmartRF Studio when checking the Range Extender box. SmartRF Studio is available on the TI website www.ti.com.

9 References

- [1] CC2530 Datasheet ([SWRS081a.pdf](#))
- [2] CC2531 Datasheet (<http://www.ti.com/lit/gpn/cc2531>)
- [3] CC253x User Guide ([SWRU191.pdf](#))
- [4] CC2591 Datasheet ([SWRS070a.pdf](#))
- [5] TIMAC and Z-Stack Modifications for using CC2591 RF Front End with CC2530 ([swra290.pdf](#))
- [6] AN058 Antenna Selection Guide ([SWRA161.pdf](#))
- [7] DN007 2.4 GHz Inverted F Antenna ([SWRU120B.pdf](#))
- [8] IEEE std. 802.15.4 – 2006: Wireless Medium Access Control (MAC) and Physical Layer (PHY) specification for Low Rate Wireless Personal Area Networks (LR-WPANs) (<http://standards.ieee.org/getieee802/download/802.15.4-2006>)
- [9] AN032 SRD Regulations for License-free Transceiver Operation in the 2.4 GHz Band ([SWRA060.pdf](#))
- [10] DA 00-705 (http://www.fcc.gov/Bureaus/Engineering_Technology/Public_Notices/2000/da000705.doc)
- [11] CC2530 – CC2591EM Reference Design ([SWRC171.zip](#))

10 General Information

10.1 Document History

Revision	Date	Description/Changes
SWRA308	2009.12.09	Initial release.
SWRA308a	2009.12.18	Updated reference list with CC2530-CC2591 reference design

IMPORTANT NOTICE

Texas Instruments Incorporated and its subsidiaries (TI) reserve the right to make corrections, modifications, enhancements, improvements, and other changes to its products and services at any time and to discontinue any product or service without notice. Customers should obtain the latest relevant information before placing orders and should verify that such information is current and complete. All products are sold subject to TI's terms and conditions of sale supplied at the time of order acknowledgment.

TI warrants performance of its hardware products to the specifications applicable at the time of sale in accordance with TI's standard warranty. Testing and other quality control techniques are used to the extent TI deems necessary to support this warranty. Except where mandated by government requirements, testing of all parameters of each product is not necessarily performed.

TI assumes no liability for applications assistance or customer product design. Customers are responsible for their products and applications using TI components. To minimize the risks associated with customer products and applications, customers should provide adequate design and operating safeguards.

TI does not warrant or represent that any license, either express or implied, is granted under any TI patent right, copyright, mask work right, or other TI intellectual property right relating to any combination, machine, or process in which TI products or services are used. Information published by TI regarding third-party products or services does not constitute a license from TI to use such products or services or a warranty or endorsement thereof. Use of such information may require a license from a third party under the patents or other intellectual property of the third party, or a license from TI under the patents or other intellectual property of TI.

Reproduction of TI information in TI data books or data sheets is permissible only if reproduction is without alteration and is accompanied by all associated warranties, conditions, limitations, and notices. Reproduction of this information with alteration is an unfair and deceptive business practice. TI is not responsible or liable for such altered documentation. Information of third parties may be subject to additional restrictions.

Resale of TI products or services with statements different from or beyond the parameters stated by TI for that product or service voids all express and any implied warranties for the associated TI product or service and is an unfair and deceptive business practice. TI is not responsible or liable for any such statements.

TI products are not authorized for use in safety-critical applications (such as life support) where a failure of the TI product would reasonably be expected to cause severe personal injury or death, unless officers of the parties have executed an agreement specifically governing such use. Buyers represent that they have all necessary expertise in the safety and regulatory ramifications of their applications, and acknowledge and agree that they are solely responsible for all legal, regulatory and safety-related requirements concerning their products and any use of TI products in such safety-critical applications, notwithstanding any applications-related information or support that may be provided by TI. Further, Buyers must fully indemnify TI and its representatives against any damages arising out of the use of TI products in such safety-critical applications.

TI products are neither designed nor intended for use in military/aerospace applications or environments unless the TI products are specifically designated by TI as military-grade or "enhanced plastic." Only products designated by TI as military-grade meet military specifications. Buyers acknowledge and agree that any such use of TI products which TI has not designated as military-grade is solely at the Buyer's risk, and that they are solely responsible for compliance with all legal and regulatory requirements in connection with such use.

TI products are neither designed nor intended for use in automotive applications or environments unless the specific TI products are designated by TI as compliant with ISO/TS 16949 requirements. Buyers acknowledge and agree that, if they use any non-designated products in automotive applications, TI will not be responsible for any failure to meet such requirements.

Following are URLs where you can obtain information on other Texas Instruments products and application solutions:

Products

Amplifiers	amplifier.ti.com
Data Converters	dataconverter.ti.com
DLP® Products	www.dlp.com
DSP	dsp.ti.com
Clocks and Timers	www.ti.com/clocks
Interface	interface.ti.com
Logic	logic.ti.com
Power Mgmt	power.ti.com
Microcontrollers	microcontroller.ti.com
RFID	www.ti-rfid.com
RF/IF and ZigBee® Solutions	www.ti.com/lprf

Applications

Audio	www.ti.com/audio
Automotive	www.ti.com/automotive
Broadband	www.ti.com/broadband
Digital Control	www.ti.com/digitalcontrol
Medical	www.ti.com/medical
Military	www.ti.com/military
Optical Networking	www.ti.com/opticalnetwork
Security	www.ti.com/security
Telephony	www.ti.com/telephony
Video & Imaging	www.ti.com/video
Wireless	www.ti.com/wireless

Mailing Address: Texas Instruments, Post Office Box 655303, Dallas, Texas 75265
Copyright © 2009, Texas Instruments Incorporated