

Miniature Helical PCB Antenna for 868 MHz or 915/920 MHz

By Richard Wallace

Keywords

- Miniature Helical PCB Antenna
- Optimized for compact designs
- 868 or 915/920 MHz ISM Bands
- CC11xx
- CC12xx

1 Introduction

This document describes a compact PCB helical antenna that has been specifically designed for 868 MHz or 915/920 MHz ISM bands.

The PCB helical antenna requires two matching components for matching to a 50-ohm load.

When a large PCB area (38 mm x 24 mm) is available for the antenna then the recommended antenna is DN024 [1] since the impedance is closer to 50 ohm without any external matching components (868 MHz: $30+j11$; VSWR 1.8) and the bandwidth is around 90 MHz.

The miniature PCB helical antenna is more compact (19 mm x 11 mm) with approximately quarter of the size of the DN024 [1] but requires matching components since the impedance is far from 50 ohms (868 MHz: $10-j88$; VSWR 22).

When the miniature helical antenna is matched then the bandwidth is around 40 MHz and has similar efficiency as DN024 [1] antenna when measured on the TRXEB platform.

All measurement results presented in this document are based on measurements performed on the CC110L EM Rev 1.0 Reference Design [3], shown in Figure 1.

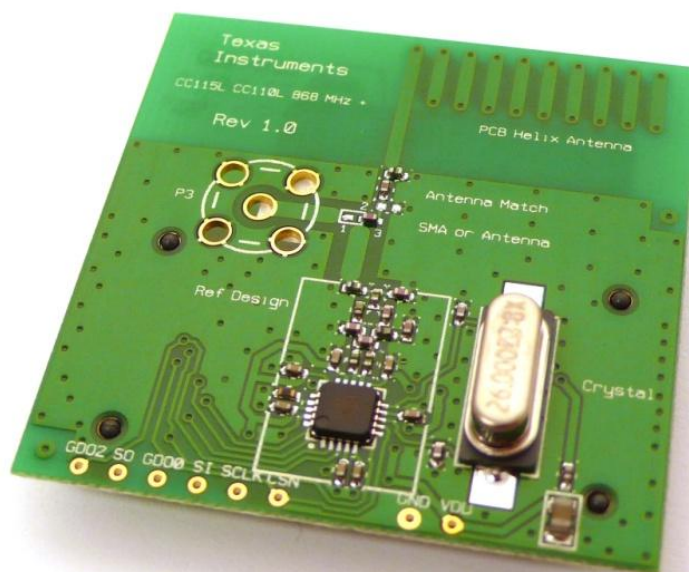

Figure 1. CC110L EM 868 / 915 MHz

Table of Contents

KEYWORDS.....	1
1 INTRODUCTION.....	1
2 ABBREVIATIONS.....	2
3 ANTENNA DESIGN.....	3
3.1 PHYSICAL DIMENSIONS.....	3
3.2 ANTENNA MATCH NETWORK.....	4
3.3 ANTENNA BANDWIDTH MEASUREMENT.....	7
3.4 ANTENNA OTA MEASUREMENT.....	7
3.4.1 868 MHz OTA Measurement Summary.....	7
4 CONCLUSION.....	9
5 REFERENCES.....	10
6 GENERAL INFORMATION.....	10
6.1 DOCUMENT HISTORY.....	10
7 APPENDICES.....	11
7.1 CTIA OTA REPORT – 868 MHz (ANTENNA MATCHED AT 868 MHz).....	11
7.1.1 OTA Evaluation Results.....	11
7.1.2 RP_868.000_tot.....	12
7.1.3 RP_868.000_hor.....	13
7.1.4 RP_868.000_ver.....	14
7.1.5 $\theta = 0, \phi = 0$	15
7.1.6 $\theta = 180, \phi = 0$	15
7.1.7 $\theta = 90, \phi = 0$	16
7.1.8 $\theta = 90, \phi = 180$	16
7.1.9 $\theta = 90, \phi = 270$	17
7.1.10 $\theta = 90, \phi = 90$	17
7.2 CTIA OTA REPORT – 915 MHz (ANTENNA MATCHED AT 868 MHz).....	18
7.2.1 OTA Evaluation Results:.....	18
7.2.2 RP_915.000_tot.....	19
7.2.3 RP_915.000_hor.....	20
7.2.4 RP_915.000_ver.....	21
7.2.5 $\theta = 0, \phi = 0$	22
7.2.6 $\theta = 180, \phi = 0$	22
7.2.7 $\theta = 90, \phi = 0$	23
7.2.8 $\theta = 90, \phi = 180$	23
7.2.9 $\theta = 90, \phi = 270$	24
7.2.10 $\theta = 90, \phi = 90$	24

2 Abbreviations

ANT	Antenna
CTIA	Cellular Telephone Industry Association
DC	Direct Current
EM	Evaluation Module
ETSI	European Telecommunications Standards Institute
FCC	Federal Communications Commission
FR4	Material type used for producing PCB
ISM	Industrial, Scientific, Medical
NM	Not Mounted
OTA	Over The Air
PCB	Printed Circuit Board
SRD	Short Range Devices
TRP	Total Radiated Power
TRXEB	Evaluation Board

3 Antenna Design

3.1 Physical Dimensions

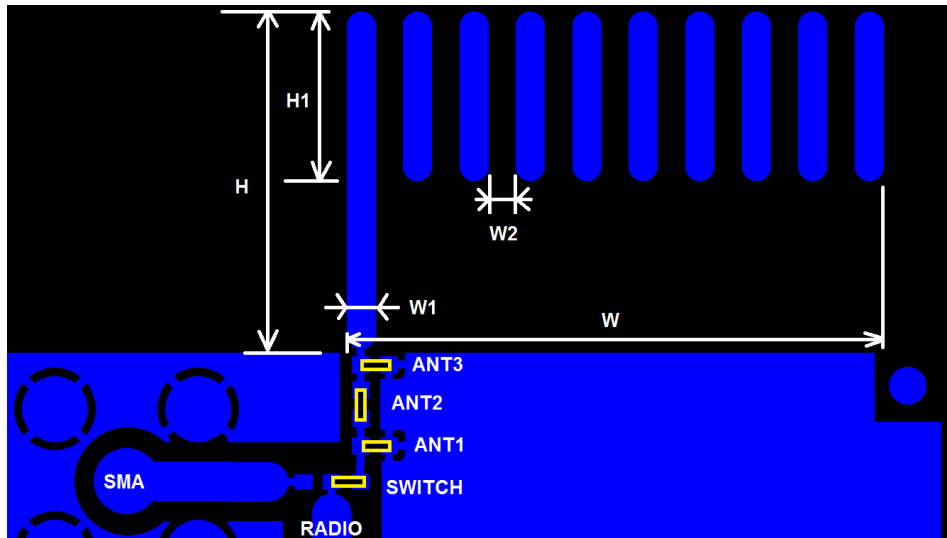

Figure 2. Top Layer Layout

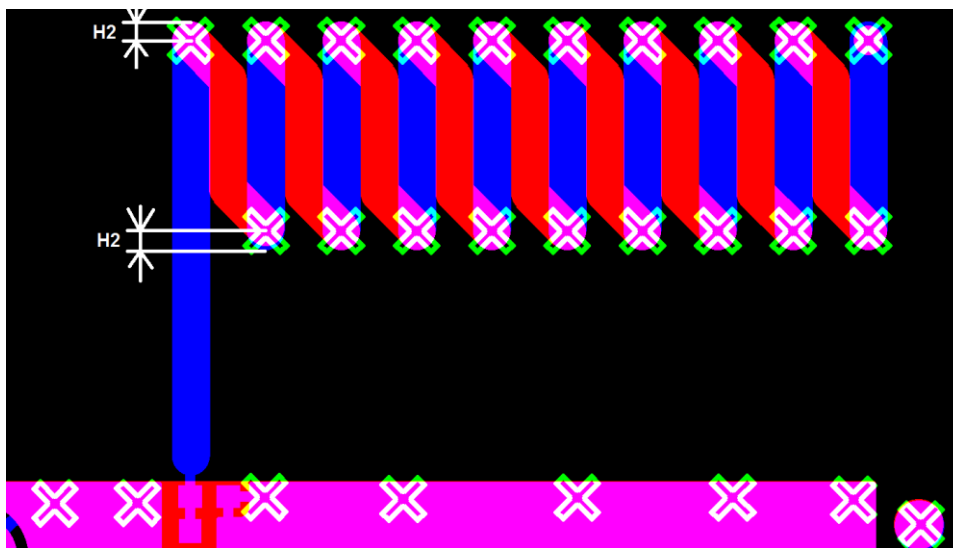

Figure 3. Zoom of Top and Bottom Layer Layout with Via Markings

Dimension	H	H1	H2	W	W1	W2	Via dia
	12 mm	6 mm	0.5 mm	19 mm	1 mm	1 mm	0.38 mm

Table 1. Antenna Dimensions

Top layer is shown in blue and the bottom layer is shown in red for Figure 2 and Figure 3. The “X” markers indicate via positions which route between the top and bottom layers.

PCB board thickness for the CC110L EM 868 / 915 MHz reference design [3] is 0.8 mm. Another PCB thickness can be used but then the antenna match must be re-calculated.

Design Note DN038

Dimensions for the antenna can be found in Table 1 and the gerbers for the antenna design are also available for 868/915 MHz [3]

3.2 Antenna Match Network

There are several ways to tune an antenna to achieve better performance. For resonant antennas the main factor is the length. Ideally the frequency which gives least reflection should be in the middle of the frequency band of interest. Thus if the resonance frequency is too low, the antenna should be made shorter. If the resonance frequency is too high, the antenna length should be increased.

Even if the antenna resonates at the correct frequency it might not be well matched to the correct impedance. Size of ground plane, distance from antenna to ground plane, dimensions of antenna elements, feed point and plastic casing are factors that can affect the impedance.

Since the impedance will change depending on several parameters; with a pi-network as illustrated in Figure 4, the antenna match can always be restored to a 50 ohm match. Only two of the components (ANT2 + (ANT1 or ANT3)) are required to match the impedance to 50 ohm depending on the start impedance. For the PCB helical antenna at 868 / 915 MHz, only ANT2 and ANT3 are required.

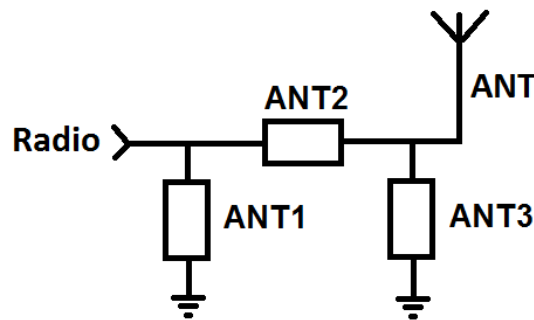

Figure 4. Antenna Match Network

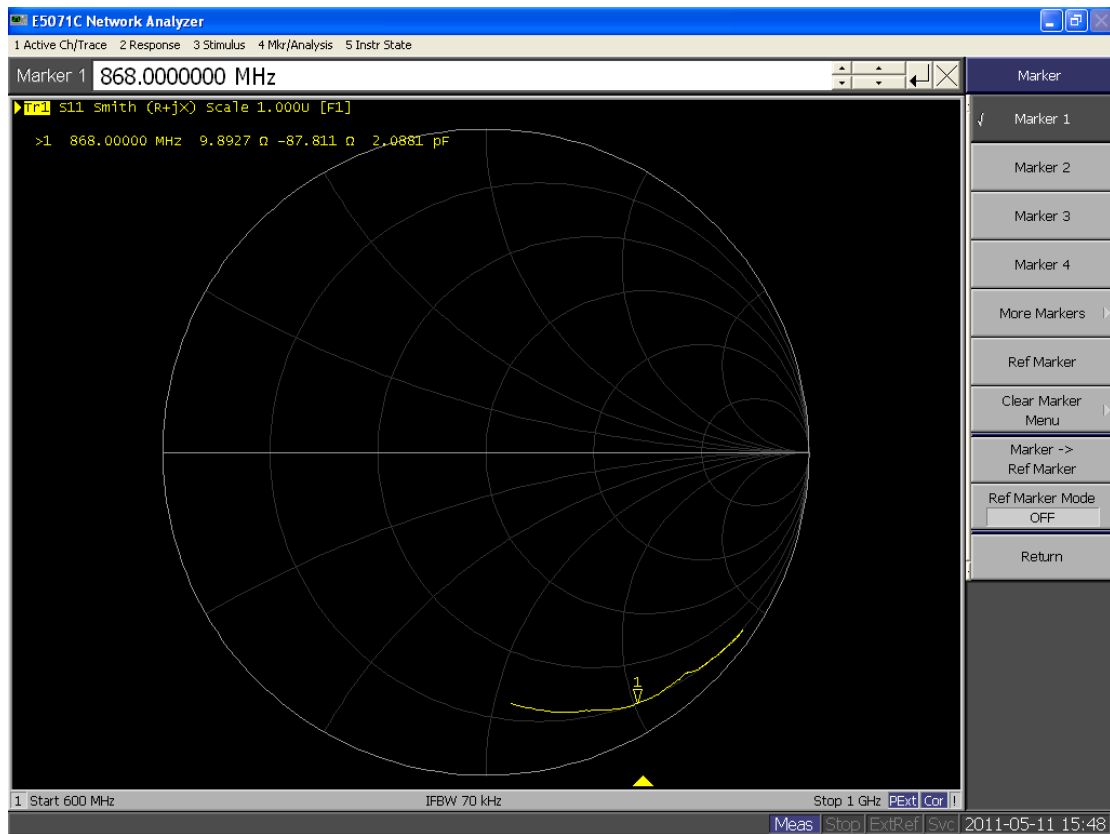

Figure 5. Start Impedance with 0-ohm (ANT2) Resistor in Antenna Match

The impedance of the PCB helical antenna is far from 50 ohm without the antenna matching network so the matching network acts as a load and matching network for the antenna. The impedance of the antenna can be seen in Figure 5 when ANT2 is set to 0 ohm.

Figure 6 shows the theoretical load and match to at 868 MHz. The Smith diagram shows a shunt component of 11.4 nH (ANT3) and a series capacitor of 1.0 pF (ANT2). ANT1 component is not required and can be left open. 11.4 nH value does not exist so a 12 nH is used instead.

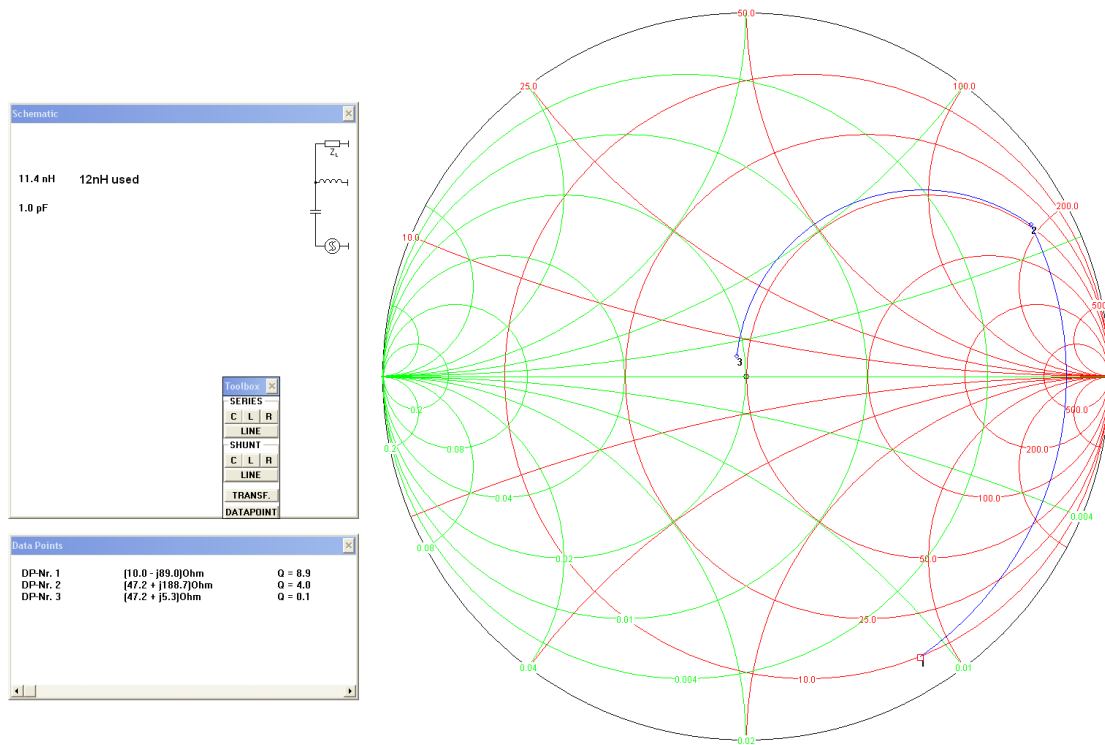

Figure 6. Theoretical Antenna Match

Assembling ANT2 (1.0 pF) and ANT3 (12 nH) based on the theoretical calculated match, then the impedance can be re-measured and a good match is measured and can be seen in Figure 7.

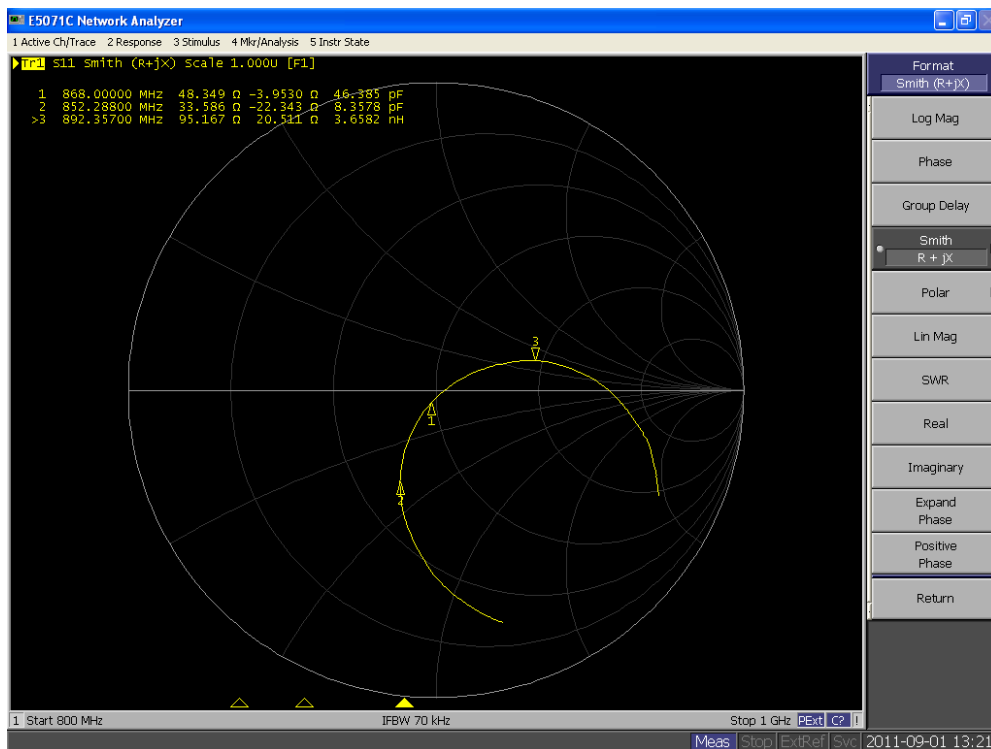

Figure 7. With Antenna Match Components - ANT2: 1.0 pF and ANT3: 12 nH

3.3 Antenna Bandwidth Measurement

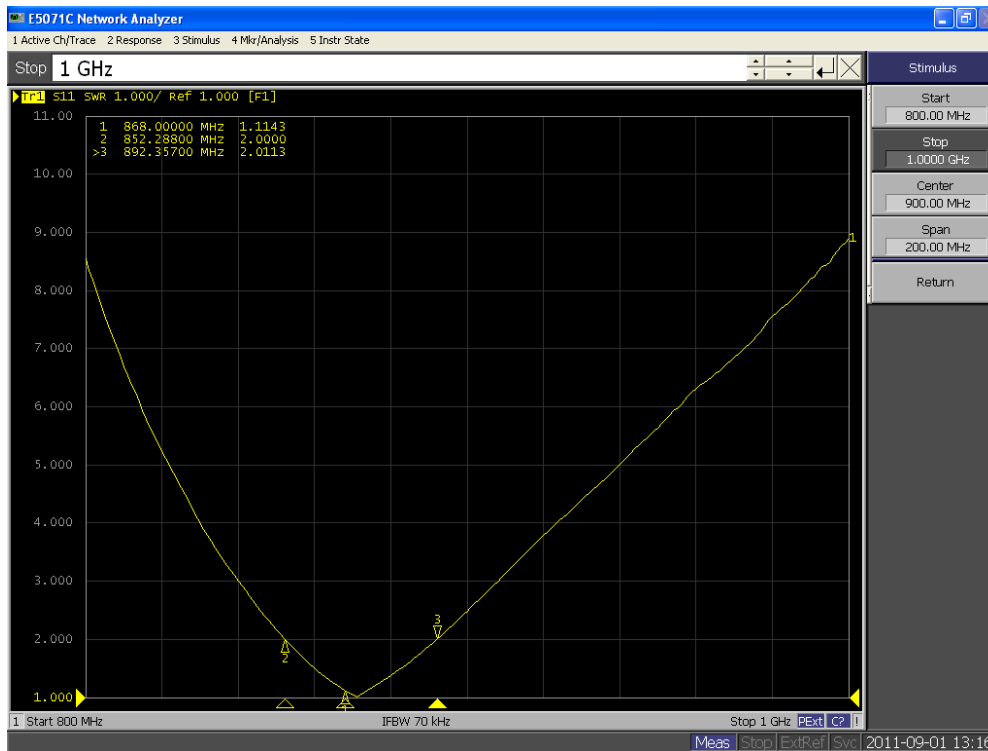

Figure 8. Bandwidth Measurement at VSWR 2

As can be seen from Figure 8, the bandwidth is 40 MHz with a VSWR 2 and 68 MHz with a VSWR 3.

3.4 Antenna OTA Measurement

The conducted output power from the radio is 0 dBm and the results shown in section 3.4.1 show the performance of the antenna of the CC110L EM 868 / 915 MHz on the TRXEB platform.

3.4.1 868 MHz OTA Measurement Summary

Total Radiated Power	-1.83 dBm
Peak EIRP	2.33 dBm
Directivity	4.16 dBi
Efficiency	-1.83 dB
Efficiency	65.55 %
Gain	2.33 dBi
NHPRP 45°	-4.06 dBm
NHPRP 45° / TRP	-2.23 dB
NHPRP 45° / TRP	59.86 %
NHPRP 30°	-5.89 dBm
NHPRP 30° / TRP	-4.05 dB
NHPRP 30° / TRP	39.32 %
NHPRP 22.5°	-7.26 dBm
NHPRP 22.5° / TRP	-5.42 dB
NHPRP 22.5° / TRP	28.69 %
UHRP	-4.91 dBm
UHRP / TRP	-3.07 dB
UHRP / TRP	49.28 %

Design Note DN038

LHRP	-4.78 dBm
LHRP / TRP	-2.95 dB
LHRP / TRP	50.72 %
Front/Back Ratio	2.52
PhiBW	332.2 deg
PhiBW Up	238.7 deg
PhiBW Down	93.4 deg
ThetaBW	82.9 deg
ThetaBW Up	46.3 deg
ThetaBW Down	36.6 deg
Boresight Phi	90 deg
Boresight Theta	15 deg
Maximum Power	2.33 dBm
Minimum Power	-12.00 dBm
Average Power	-0.91 dBm
Max/Min Ratio	14.33 dB
Max/Avg Ratio	3.24 dB
Min/Avg Ratio	-11.10 dB
Best Single Value	1.11 dBm
Best Position	Phi = 45 deg; Theta = 165 deg; Pol = Ver

For the full CTIA report including 3D radiated plots at 868 MHz please refer to section 7.1.

The antenna was also measured at 915 MHz to show the performance degradation whilst keeping the same matching network at 868 MHz; this is shown in section 7.2. For optimum performance at 915 MHz, the antenna needs to be re-matched at this frequency.

For the Over-The-Air (OTA) Measurements performed in the chamber, please refer to Figure 9 for coordinate correlation to the CTIA reports.

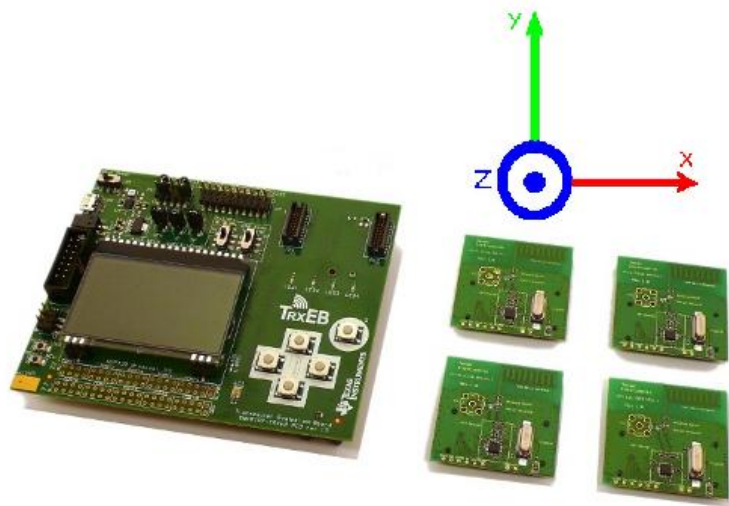

Figure 9. Coordinates Correlation to CTIA OTA Reports

4 Conclusion

When a large PCB area (38 mm x 24 mm) is available for the antenna then the recommended antenna is DN024 [1] since the impedance is closer to 50 ohm without any external matching components (868 MHz: $30+j11$; VSWR 1.8) and the bandwidth is around 90 MHz.

When there is a need for a more compact antenna then the miniature PCB helical antenna is ideal (19 mm x 11 mm) with approximately quarter of the DN024 antenna size [1] but requires matching components since the impedance is far from 50 ohms (868 MHz: $10-j88$; VSWR 22). It is important to match this antenna since the match network is also used for loading the antenna to 868 MHz or 915 / 920 MHz.

When the miniature helical antenna is matched then the bandwidth is around 40 MHz and has similar efficiency as DN024 [1] antenna when measured on the TRXEB platform.

A single match network can be used for 868 MHz and 915 / 920 MHz but due to the reduce bandwidth compared to DN024 antenna [1] then there will be some degradation in performance. For the antenna matching network components it is recommended to use tight tolerance components.

Optimal antenna match for the CC110L EM 868 / 915 MHz reference design [3] is a series 1.0 pF capacitor (ANT2) and a shunt inductor of 12 nH (ANT3) for 868 MHz operation.

The PCB board thickness for the CC110L EM 868 / 915 MHz reference design [3] is 0.8 mm. The same match has been tested at 1.24 mm thick PCB and the performance was still good but generally if the PCB thickness is changed then the antenna match should be re-calculated.

5 References

- [1] DN024 Monopole PCB Antenna ([DN024](#))
- [2] DN035 Antenna Quick Selection Guide ([DN035](#))
- [3] CC11xL EM 868/915 MHz Ref Design ([swrr082](#))
- [4] AN058 Antenna Measurement with Network Analyzer ([AN058](#))

6 General Information

6.1 Document History

Revision	Date	Description/Changes
SWRA416	2012.11.27	Initial release.

7 Appendices

7.1 CTIA OTA Report – 868 MHz (Antenna matched at 868 MHz)

7.1.1 OTA Evaluation Results

Total Radiated Power	-1.83 dBm
Peak EIRP	2.33 dBm
Directivity	4.16 dBi
Efficiency	-1.83 dB
Efficiency	65.55 %
Gain	2.33 dBi
NHPRP 45°	-4.06 dBm
NHPRP 45° / TRP	-2.23 dB
NHPRP 45° / TRP	59.86 %
NHPRP 30°	-5.89 dBm
NHPRP 30° / TRP	-4.05 dB
NHPRP 30° / TRP	39.32 %
NHPRP 22.5°	-7.26 dBm
NHPRP 22.5° / TRP	-5.42 dB
NHPRP 22.5° / TRP	28.69 %
UHRP	-4.91 dBm
UHRP / TRP	-3.07 dB
UHRP / TRP	49.28 %
LHRP	-4.78 dBm
LHRP / TRP	-2.95 dB
LHRP / TRP	50.72 %
Front/Back Ratio	2.52
PhiBW	332.2 deg
PhiBW Up	238.7 deg
PhiBW Down	93.4 deg
ThetaBW	82.9 deg
ThetaBW Up	46.3 deg
ThetaBW Down	36.6 deg
Boresight Phi	90 deg
Boresight Theta	15 deg
Maximum Power	2.33 dBm
Minimum Power	-12.00 dBm
Average Power	-0.91 dBm
Max/Min Ratio	14.33 dB
Max/Avg Ratio	3.24 dB
Min/Avg Ratio	-11.10 dB
Best Single Value	1.11 dBm
Best Position	Phi = 45 deg; Theta = 165 deg; Pol = Ver

Design Note DN038

7.1.2 RP_868.000_tot

Azimuth (deg)	Elevation 0 deg (dB)	Elevation 15 deg (dB)	Elevation 30 deg (dB)	Elevation 45 deg (dB)	Elevation 60 deg (dB)	Elevation 75 deg (dB)	Elevation 90 deg (dB)	Elevation 105 deg (dB)
0.00	0.02	-0.55	-1.69	-3.23	-2.91	-2.06	-1.31	-0.58
15.00	-0.04	-0.48	-0.80	-2.29	-1.12	-0.76	-0.52	-1.20
30.00	0.08	0.04	0.05	-0.56	0.06	0.48	-1.00	-1.71
45.00	0.46	0.80	0.81	0.59	0.92	0.74	-1.25	-1.39
60.00	0.63	1.34	1.42	1.60	1.02	0.60	-2.04	-1.20
75.00	1.19	1.85	1.99	1.78	0.57	-0.25	-2.81	-1.24
90.00	1.12	2.33	2.00	1.95	-0.58	-1.64	-4.64	-2.42
105.00	1.37	2.21	1.97	1.65	-1.54	-3.80	-7.33	-4.84
120.00	1.47	1.92	1.68	0.57	-2.67	-6.03	-11.79	-6.83
135.00	1.20	1.25	1.22	-0.69	-3.29	-6.70	-12.00	-7.10
150.00	1.04	0.65	0.65	-1.58	-3.26	-5.29	-7.51	-5.75
165.00	1.04	0.25	0.64	-2.14	-3.25	-3.79	-4.77	-3.39
180.00	0.96	0.14	0.33	-2.17	-2.97	-2.32	-2.90	-1.64
195.00	0.80	0.15	0.24	-2.14	-2.70	-1.86	-2.48	-0.39
210.00	0.91	0.58	-0.06	-2.21	-3.18	-1.65	-2.80	-0.09
225.00	0.71	0.70	-0.32	-2.75	-3.63	-2.49	-4.01	-0.41
240.00	0.88	0.77	-0.90	-3.48	-4.99	-3.50	-5.53	-1.75
255.00	0.85	0.76	-1.59	-4.90	-6.85	-5.37	-7.83	-3.27
270.00	0.98	0.64	-2.34	-6.81	-7.89	-7.40	-9.26	-5.09
285.00	0.94	0.29	-3.49	-8.36	-7.48	-8.68	-11.38	-7.19
300.00	0.86	0.09	-3.82	-8.52	-6.04	-8.61	-9.86	-6.42
315.00	0.85	-0.23	-3.65	-7.17	-5.33	-7.12	-8.26	-4.34
330.00	0.45	-0.71	-3.37	-5.39	-4.28	-7.11	-5.75	-2.38
345.00	0.33	-1.06	-2.72	-4.77	-3.70	-5.69	-3.32	-1.22
360.00	-0.35	-0.55	-2.02	-3.50	-3.23	-2.91	-1.78	-0.68

Azimuth (deg)	Elevation 120 deg (dB)	Elevation 135 deg (dB)	Elevation 150 deg (dB)	Elevation 165 deg (dB)	Elevation 180 deg (dB)
0.00	-0.76	-2.14	0.37	1.33	0.87
15.00	-1.03	-1.52	1.09	1.31	0.85
30.00	-0.65	-0.91	1.35	1.53	0.76
45.00	0.19	-0.33	1.21	1.31	0.45
60.00	0.15	0.13	0.65	0.89	0.17
75.00	-0.60	-0.27	-0.24	0.79	-0.10
90.00	-1.84	-0.98	-1.34	0.26	-0.26
105.00	-3.63	-1.76	-2.10	0.20	-0.06
120.00	-4.61	-2.51	-2.33	-0.20	0.09
135.00	-3.93	-2.41	-1.83	-0.29	0.70
150.00	-2.76	-2.06	-0.94	-0.06	1.32
165.00	-1.84	-1.90	-0.46	0.21	1.81
180.00	-1.28	-1.51	-0.15	0.31	1.98
195.00	-0.87	-1.60	-0.32	0.54	1.65
210.00	-0.70	-1.57	-0.80	0.21	1.33
225.00	-1.46	-1.79	-1.02	0.08	0.61
240.00	-2.37	-1.91	-0.86	-0.10	-0.01
255.00	-3.54	-1.96	-1.24	-0.10	-0.56
270.00	-4.36	-2.45	-1.54	-0.19	-0.61
285.00	-4.49	-2.45	-1.31	-0.31	-0.74
300.00	-3.36	-2.34	-1.29	-0.15	-0.50
315.00	-1.91	-2.28	-0.73	-0.03	-0.03
330.00	-0.78	-2.28	-0.43	0.37	0.43
345.00	-0.13	-2.07	0.01	0.66	0.69
360.00	-0.81	-2.13	0.39	1.19	0.52

Design Note DN038

7.1.3 RP_868.000_hor

Azimuth (deg)	Elevation 0 deg (dB)	Elevation 15 deg (dB)	Elevation 30 deg (dB)	Elevation 45 deg (dB)	Elevation 60 deg (dB)	Elevation 75 deg (dB)	Elevation 90 deg (dB)	Elevation 105 deg (dB)
0.0	-4.16	-5.12	-6.99	-9.59	-12.40	-18.01	-10.47	-6.31
15.0	-6.76	-7.78	-8.26	-11.23	-15.26	-12.98	-9.90	-8.02
30.0	-10.53	-9.87	-9.14	-13.25	-16.86	-10.46	-11.90	-10.38
45.0	-9.41	-7.61	-9.08	-11.76	-11.68	-9.79	-14.69	-11.82
60.0	-6.02	-5.10	-6.47	-7.35	-9.39	-9.50	-18.97	-11.68
75.0	-3.19	-2.47	-3.22	-4.56	-7.23	-10.27	-19.30	-11.80
90.0	-1.25	-0.48	-1.14	-2.24	-6.06	-10.02	-16.55	-11.80
105.0	0.14	0.57	0.09	-1.25	-4.56	-9.49	-14.42	-10.88
120.0	0.94	1.07	0.66	-1.17	-4.13	-8.71	-15.05	-10.39
135.0	0.90	0.81	0.68	-1.62	-4.06	-8.04	-17.48	-10.19
150.0	0.47	0.01	-0.31	-2.79	-4.71	-8.16	-19.20	-11.48
165.0	-0.60	-1.40	-1.56	-4.71	-6.59	-8.59	-16.45	-14.01
180.0	-2.38	-4.03	-3.98	-7.25	-9.81	-10.30	-14.79	-19.31
195.0	-5.40	-8.08	-7.44	-11.65	-14.07	-11.99	-15.21	-16.76
210.0	-8.54	-13.22	-11.98	-17.44	-18.71	-14.46	-15.42	-14.48
225.0	-10.51	-10.14	-15.98	-21.30	-17.17	-17.02	-17.49	-12.57
240.0	-7.07	-6.29	-11.62	-14.77	-14.74	-20.18	-22.70	-12.50
255.0	-3.64	-3.82	-8.03	-13.01	-13.77	-22.70	-21.66	-10.78
270.0	-1.81	-2.37	-5.92	-12.33	-12.56	-22.70	-18.08	-9.96
285.0	-0.68	-1.63	-5.86	-11.25	-12.19	-22.70	-17.50	-9.78
300.0	-0.07	-1.38	-5.66	-11.20	-11.60	-21.61	-17.27	-8.39
315.0	0.20	-1.52	-5.28	-10.46	-11.06	-18.27	-18.37	-6.73
330.0	-0.69	-2.21	-5.85	-9.82	-9.10	-16.50	-16.84	-5.62
345.0	-1.68	-3.39	-6.33	-9.63	-9.44	-22.62	-13.44	-5.71
360.0	-3.92	-4.37	-6.90	-9.18	-11.27	-22.70	-10.75	-6.34

Azimuth (deg)	Elevation 120 deg (dB)	Elevation 135 deg (dB)	Elevation 150 deg (dB)	Elevation 165 deg (dB)	Elevation 180 deg (dB)
0.0	-5.95	-5.72	-2.33	-2.15	-3.58
15.0	-7.74	-6.58	-3.13	-4.16	-6.26
30.0	-10.02	-8.42	-4.56	-7.56	-9.99
45.0	-12.26	-9.58	-7.20	-12.25	-16.62
60.0	-14.37	-9.62	-9.34	-11.88	-10.12
75.0	-13.44	-8.08	-9.03	-6.38	-5.53
90.0	-10.31	-5.75	-6.02	-3.44	-2.83
105.0	-7.97	-3.99	-3.94	-1.46	-0.98
120.0	-6.03	-3.09	-2.63	-0.64	-0.05
135.0	-4.71	-2.49	-2.09	-0.34	0.57
150.0	-4.53	-2.69	-2.01	-0.66	0.58
165.0	-5.42	-3.82	-2.99	-1.59	0.11
180.0	-7.81	-5.62	-4.68	-3.52	-1.09
195.0	-12.81	-9.68	-7.88	-6.24	-3.56
210.0	-22.70	-19.50	-13.80	-12.67	-7.29
225.0	-13.82	-15.45	-18.70	-17.43	-17.19
240.0	-10.53	-9.04	-9.58	-9.64	-13.11
255.0	-7.85	-5.76	-5.83	-5.25	-6.89
270.0	-6.50	-4.35	-3.44	-2.53	-3.42
285.0	-5.38	-3.44	-2.22	-1.26	-1.56
300.0	-4.58	-3.04	-1.52	-0.40	-0.61
315.0	-3.94	-3.32	-0.94	-0.13	-0.27
330.0	-3.52	-3.77	-0.98	-0.19	-0.57
345.0	-3.98	-4.29	-1.31	-0.86	-1.50
360.0	-5.47	-5.69	-1.82	-1.64	-3.33

Design Note DN038

7.1.4 RP_868.000_ver

Azimuth (deg)	Elevation 0 deg (dB)	Elevation 15 deg (dB)	Elevation 30 deg (dB)	Elevation 45 deg (dB)	Elevation 60 deg (dB)	Elevation 75 deg (dB)	Elevation 90 deg (dB)	Elevation 105 deg (dB)
0.0	-2.07	-2.41	-3.21	-4.37	-3.42	-2.18	-1.87	-1.93
15.0	-1.08	-1.37	-1.66	-2.88	-1.29	-1.03	-1.05	-2.21
30.0	-0.31	-0.42	-0.50	-0.80	-0.03	0.11	-1.36	-2.35
45.0	-0.01	0.13	0.34	0.33	0.67	0.33	-1.45	-1.81
60.0	-0.43	0.23	0.65	1.01	0.60	0.15	-2.13	-1.60
75.0	-0.79	-0.15	0.43	0.64	-0.22	-0.70	-2.91	-1.64
90.0	-2.65	-0.89	-0.88	-0.14	-2.03	-2.32	-4.93	-2.95
105.0	-4.69	-2.82	-2.57	-1.48	-4.53	-5.17	-8.28	-6.08
120.0	-7.89	-5.58	-5.11	-4.24	-8.11	-9.39	-14.56	-9.35
135.0	-10.56	-8.91	-8.10	-7.86	-11.18	-12.47	-13.45	-10.04
150.0	-8.05	-7.96	-6.38	-7.71	-8.71	-8.45	-7.81	-7.10
165.0	-3.97	-4.75	-3.38	-5.63	-5.94	-5.54	-5.08	-3.79
180.0	-1.75	-1.96	-1.68	-3.79	-3.98	-3.07	-3.20	-1.72
195.0	-0.40	-0.56	-0.57	-2.65	-3.02	-2.30	-2.72	-0.49
210.0	0.39	0.40	-0.34	-2.34	-3.31	-1.89	-3.05	-0.25
225.0	0.37	0.33	-0.44	-2.81	-3.82	-2.65	-4.21	-0.68
240.0	0.13	-0.18	-1.28	-3.81	-5.47	-3.59	-5.62	-2.13
255.0	-1.05	-1.10	-2.71	-5.63	-7.83	-5.45	-8.01	-4.12
270.0	-2.25	-2.38	-4.84	-8.24	-9.71	-7.53	-9.87	-6.81
285.0	-4.12	-4.18	-7.26	-11.49	-9.27	-8.86	-12.59	-10.67
300.0	-6.30	-5.33	-8.44	-11.90	-7.46	-8.84	-10.73	-10.81
315.0	-7.73	-6.12	-8.69	-9.93	-6.68	-7.46	-8.70	-8.08
330.0	-5.93	-6.05	-6.98	-7.33	-6.02	-7.64	-6.10	-5.17
345.0	-3.99	-4.87	-5.20	-6.49	-5.05	-5.78	-3.77	-3.13
360.0	-2.86	-2.89	-3.72	-4.86	-3.97	-2.96	-2.36	-2.05

Azimuth (deg)	Elevation 120 deg (dB)	Elevation 135 deg (dB)	Elevation 150 deg (dB)	Elevation 165 deg (dB)	Elevation 180 deg (dB)
0.0	-2.33	-4.65	-2.98	-1.26	-1.05
15.0	-2.08	-3.14	-0.98	-0.14	-0.09
30.0	-1.18	-1.76	0.07	0.96	0.38
45.0	-0.07	-0.88	0.53	1.11	0.36
60.0	0.00	-0.35	0.19	0.65	-0.26
75.0	-0.83	-1.06	-0.86	-0.13	-1.56
90.0	-2.50	-2.75	-3.15	-2.16	-3.75
105.0	-5.62	-5.74	-6.70	-4.78	-7.27
120.0	-10.17	-11.57	-14.09	-10.39	-14.67
135.0	-11.78	-19.62	-14.19	-19.71	-14.33
150.0	-7.52	-10.79	-7.55	-8.95	-6.75
165.0	-4.34	-6.37	-3.99	-4.48	-3.10
180.0	-2.37	-3.64	-2.04	-2.01	-0.97
195.0	-1.16	-2.34	-1.16	-0.48	0.09
210.0	-0.73	-1.64	-1.03	-0.02	0.69
225.0	-1.72	-1.98	-1.10	0.00	0.54
240.0	-3.09	-2.85	-1.48	-0.61	-0.23
255.0	-5.54	-4.30	-3.10	-1.68	-1.72
270.0	-8.48	-6.97	-6.05	-3.99	-3.83
285.0	-11.83	-9.34	-8.55	-7.35	-8.40
300.0	-9.47	-10.64	-14.24	-12.74	-16.57
315.0	-6.20	-9.01	-14.06	-16.80	-12.83
330.0	-4.08	-7.65	-9.69	-8.78	-6.44
345.0	-2.44	-6.05	-5.79	-4.63	-3.33
360.0	-2.63	-4.65	-3.61	-2.01	-1.79

Design Note DN038

7.1.5 $\theta = 0, \phi = 0$

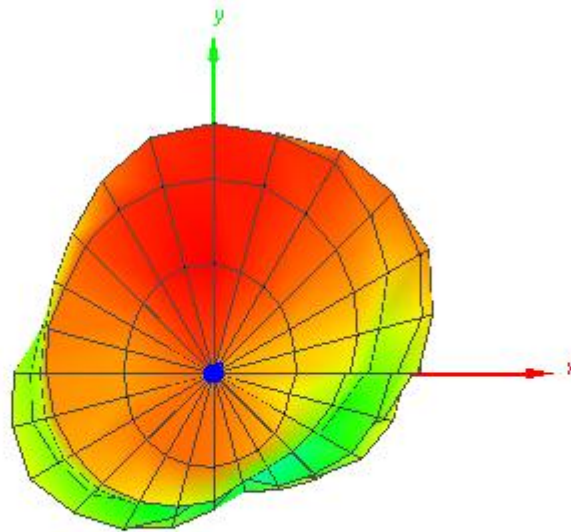

7.1.6 $\theta = 180, \phi = 0$

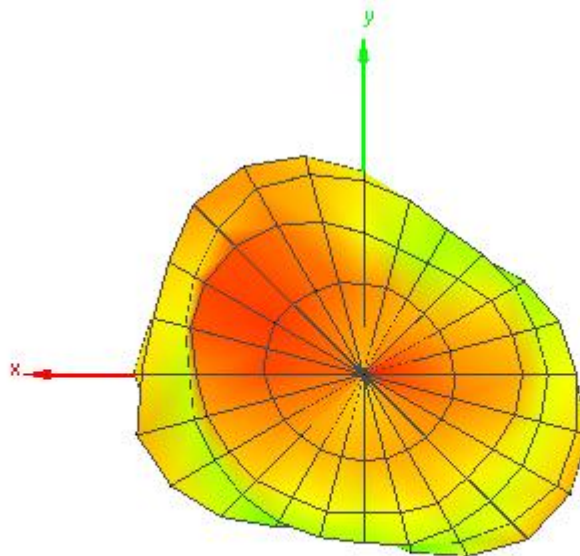

7.1.7 $\Theta = 90, \Phi = 0$

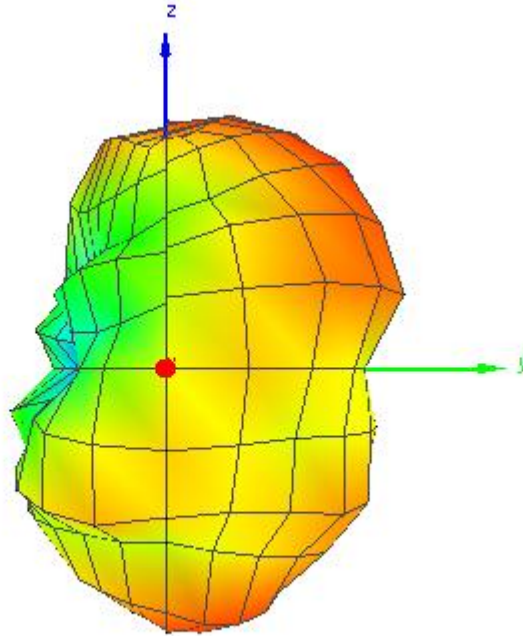

7.1.8 $\Theta = 90, \Phi = 180$

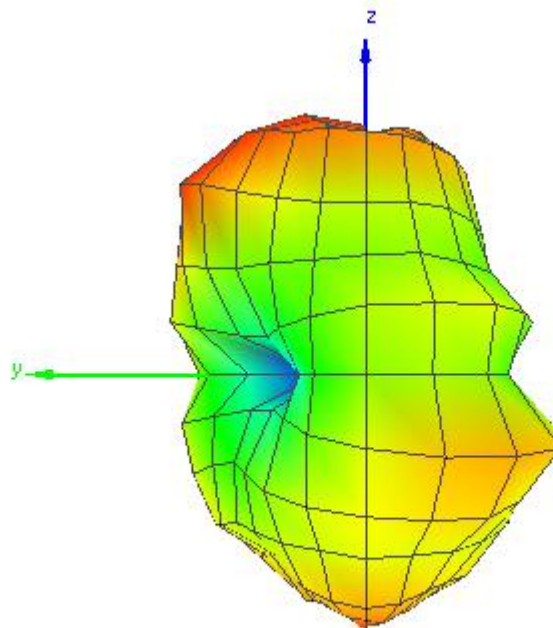

7.1.9 Theta = 90, Phi = 270

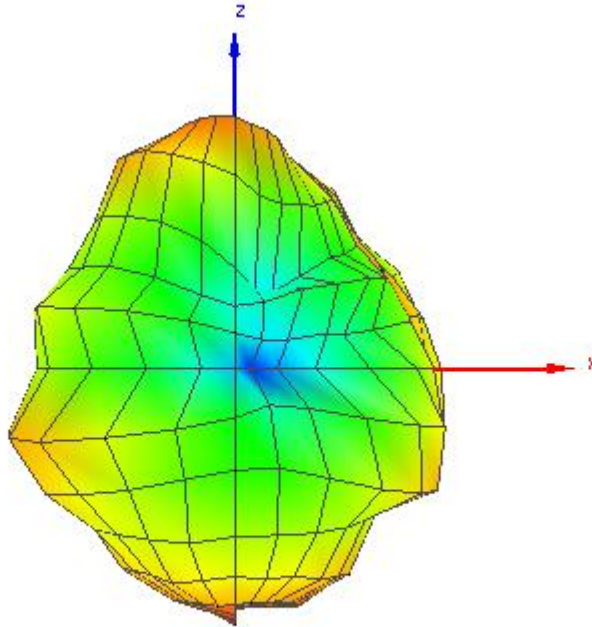

7.1.10 Theta = 90, Phi = 90

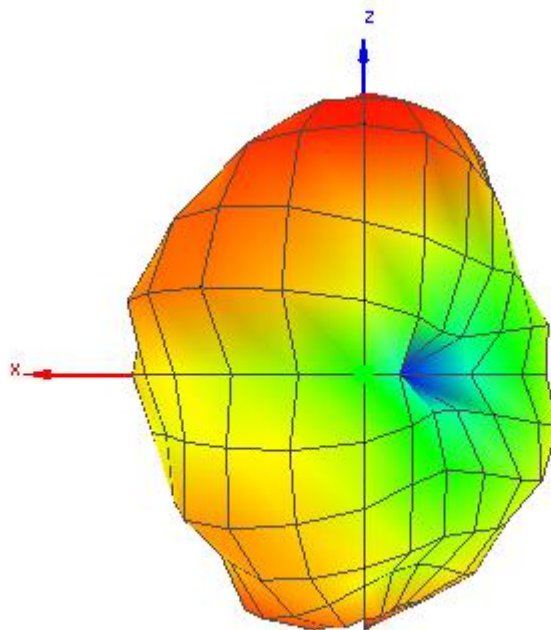

7.2 CTIA OTA Report – 915 MHz (Antenna matched at 868 MHz)

7.2.1 OTA Evaluation Results:

Total Radiated Power	-3.35 dBm
Peak EIRP	0.01 dBm
Directivity	3.37 dBi
Efficiency	-3.35 dB
Efficiency	46.20 %
Gain	0.01 dBi
NHPRP 45°	-5.54 dBm
NHPRP 45° / TRP	-2.19 dB
NHPRP 45° / TRP	60.42 %
NHPRP 30°	-7.39 dBm
NHPRP 30° / TRP	-4.04 dB
NHPRP 30° / TRP	39.49 %
NHPRP 22.5°	-8.72 dBm
NHPRP 22.5° / TRP	-5.37 dB
NHPRP 22.5° / TRP	29.05 %
UHRP	-6.28 dBm
UHRP / TRP	-2.92 dB
UHRP / TRP	51.01 %
LHRP	-6.45 dBm
LHRP / TRP	-3.10 dB
LHRP / TRP	48.99 %
Front/Back Ratio	4.40
PhiBW	85.3 deg
PhiBW Up	40.5 deg
PhiBW Down	44.8 deg
ThetaBW	272.4 deg
ThetaBW Up	118.8 deg
ThetaBW Down	153.5 deg
Boresight Phi	210 deg
Boresight Theta	105 deg
Maximum Power	0.01 dBm
Minimum Power	-15.33 dBm
Average Power	-2.61 dBm
Max/Min Ratio	15.34 dB
Max/Avg Ratio	2.62 dB
Min/Avg Ratio	-12.72 dB
Best Single Value	-0.16 dBm
Best Position	Phi = 210 deg; Theta = 105 deg; Pol = Ver

Design Note DNO38

7.2.2 RP_915.000_tot

Azimuth (deg)	Elevation 0 deg (dB)	Elevation 15 deg (dB)	Elevation 30 deg (dB)	Elevation 45 deg (dB)	Elevation 60 deg (dB)	Elevation 75 deg (dB)	Elevation 90 deg (dB)	Elevation 105 deg (dB)
0.00	-1.09	-2.11	-2.67	-3.21	-6.21	-7.46	-7.02	-6.05
15.00	-1.29	-2.11	-2.21	-3.23	-5.40	-5.93	-5.16	-5.56
30.00	-1.24	-1.80	-1.61	-2.63	-4.14	-4.38	-3.52	-4.43
45.00	-1.31	-1.26	-1.82	-1.96	-2.98	-3.29	-2.76	-3.39
60.00	-1.51	-1.20	-1.54	-1.21	-2.09	-2.39	-2.36	-2.48
75.00	-1.54	-1.00	-1.76	-0.66	-1.73	-2.82	-2.75	-2.86
90.00	-1.87	-0.83	-1.77	-0.65	-2.03	-3.90	-4.55	-4.72
105.00	-2.24	-0.90	-1.61	-0.77	-3.02	-5.23	-7.19	-8.17
120.00	-2.37	-1.11	-1.05	-1.20	-3.40	-6.89	-12.40	-13.73
135.00	-2.45	-1.41	-0.56	-1.38	-3.29	-6.70	-13.49	-10.32
150.00	-2.33	-1.40	-0.26	-1.33	-2.57	-4.63	-8.31	-5.78
165.00	-2.26	-1.45	-0.19	-1.42	-1.81	-2.49	-4.92	-3.01
180.00	-2.32	-1.49	-0.07	-1.35	-1.47	-1.17	-2.67	-1.34
195.00	-2.03	-1.42	-0.32	-1.41	-1.75	-0.68	-1.96	-0.23
210.00	-2.26	-1.42	-0.66	-1.46	-2.13	-1.04	-2.35	0.01
225.00	-2.05	-1.12	-0.87	-1.87	-2.80	-1.70	-3.32	-0.52
240.00	-1.78	-1.42	-1.48	-2.69	-4.50	-3.24	-5.18	-1.64
255.00	-1.57	-1.43	-2.17	-3.49	-6.35	-4.76	-7.75	-3.56
270.00	-1.39	-1.80	-2.71	-4.99	-8.18	-6.66	-11.21	-5.51
285.00	-1.20	-2.25	-3.41	-5.66	-8.97	-8.81	-14.00	-7.68
300.00	-1.31	-2.55	-3.62	-6.05	-8.69	-10.09	-15.33	-8.97
315.00	-1.24	-2.58	-3.72	-5.53	-8.54	-10.57	-14.59	-8.42
330.00	-1.15	-2.71	-3.40	-4.94	-7.90	-10.23	-11.90	-7.50
345.00	-1.10	-2.81	-3.10	-3.94	-7.34	-9.36	-9.25	-6.90
360.00	-1.38	-2.29	-2.77	-3.35	-6.74	-8.00	-7.42	-6.26

Azimuth (deg)	Elevation 120 deg (dB)	Elevation 135 deg (dB)	Elevation 150 deg (dB)	Elevation 165 deg (dB)	Elevation 180 deg (dB)
0.00	-5.15	-5.17	-2.23	-1.10	-0.45
15.00	-4.56	-4.45	-1.75	-1.39	-0.59
30.00	-3.45	-3.11	-1.54	-1.38	-0.69
45.00	-2.44	-2.29	-1.76	-1.13	-0.99
60.00	-2.04	-1.92	-2.02	-0.96	-1.10
75.00	-2.64	-2.14	-2.55	-0.81	-0.81
90.00	-4.14	-2.87	-3.26	-0.70	-1.11
105.00	-6.22	-3.71	-3.98	-0.75	-0.80
120.00	-7.19	-4.78	-3.75	-0.77	-0.72
135.00	-6.89	-4.75	-3.15	-1.25	-0.56
150.00	-4.91	-3.95	-2.43	-1.63	-0.45
165.00	-3.36	-3.28	-1.93	-1.67	-0.69
180.00	-2.42	-2.48	-1.59	-1.61	-0.88
195.00	-1.81	-1.96	-1.28	-1.73	-1.25
210.00	-1.81	-1.70	-1.38	-1.55	-1.69
225.00	-2.13	-1.54	-1.56	-1.31	-1.87
240.00	-2.58	-1.75	-1.79	-1.48	-2.12
255.00	-3.76	-2.01	-1.93	-1.42	-1.93
270.00	-4.80	-2.81	-2.21	-1.57	-2.17
285.00	-5.12	-3.09	-2.20	-1.42	-1.65
300.00	-5.04	-3.96	-2.32	-1.31	-1.05
315.00	-4.92	-5.05	-2.38	-1.27	-0.53
330.00	-5.22	-5.78	-2.28	-1.05	-0.20
345.00	-4.90	-5.78	-2.04	-1.25	-0.09
360.00	-5.13	-5.74	-2.02	-1.06	-0.52

Design Note DNO38

7.2.3 RP_915.000_hor

Azimuth (deg)	Elevation 0 deg (dB)	Elevation 15 deg (dB)	Elevation 30 deg (dB)	Elevation 45 deg (dB)	Elevation 60 deg (dB)	Elevation 75 deg (dB)	Elevation 90 deg (dB)	Elevation 105 deg (dB)
0.0	-5.94	-7.73	-8.14	-7.43	-11.86	-17.06	-13.93	-12.37
15.0	-8.64	-9.66	-9.28	-9.11	-13.79	-17.09	-13.79	-13.93
30.0	-11.34	-11.09	-11.32	-10.70	-16.72	-17.39	-13.19	-16.91
45.0	-11.19	-11.23	-13.18	-10.66	-14.84	-15.17	-13.74	-16.93
60.0	-8.60	-8.44	-10.43	-8.20	-11.28	-12.36	-14.86	-15.84
75.0	-6.50	-5.78	-7.36	-5.27	-8.07	-12.08	-15.99	-14.05
90.0	-4.42	-3.56	-4.41	-3.41	-5.76	-10.82	-17.80	-13.93
105.0	-3.65	-2.28	-2.67	-2.26	-5.02	-9.19	-16.46	-14.61
120.0	-3.18	-1.78	-1.58	-1.94	-4.05	-7.93	-16.27	-14.53
135.0	-3.10	-1.95	-1.46	-2.14	-3.88	-7.37	-15.70	-14.36
150.0	-3.61	-2.64	-2.15	-3.11	-4.43	-7.74	-15.07	-14.98
165.0	-4.67	-4.38	-3.69	-5.38	-5.90	-8.34	-14.86	-17.32
180.0	-6.61	-6.61	-6.08	-8.28	-8.49	-9.48	-13.82	-24.22
195.0	-9.20	-10.13	-8.91	-11.62	-11.75	-11.60	-14.53	-18.21
210.0	-12.09	-12.92	-11.64	-11.30	-14.18	-14.35	-14.23	-14.21
225.0	-10.64	-10.41	-10.31	-10.59	-14.40	-15.25	-16.41	-12.86
240.0	-7.46	-7.71	-8.14	-9.35	-14.35	-18.25	-17.74	-11.80
255.0	-5.09	-5.60	-6.74	-8.56	-14.72	-20.89	-22.62	-11.90
270.0	-3.52	-4.57	-5.73	-8.61	-14.80	-21.74	-24.22	-11.33
285.0	-2.42	-4.04	-5.57	-8.01	-14.86	-20.89	-23.74	-11.91
300.0	-2.25	-3.96	-5.62	-8.46	-14.28	-22.09	-21.88	-11.37
315.0	-2.33	-4.21	-6.13	-8.28	-13.69	-21.93	-21.81	-10.50
330.0	-2.91	-5.02	-6.69	-8.06	-12.50	-21.43	-17.15	-10.06
345.0	-4.08	-6.32	-7.02	-7.48	-11.70	-17.58	-14.45	-10.65
360.0	-5.87	-7.16	-7.91	-6.99	-11.67	-17.16	-13.44	-11.62

Azimuth (deg)	Elevation 120 deg (dB)	Elevation 135 deg (dB)	Elevation 150 deg (dB)	Elevation 165 deg (dB)	Elevation 180 deg (dB)
0.0	-10.25	-10.26	-5.37	-5.43	-5.89
15.0	-12.10	-10.81	-6.04	-8.45	-8.80
30.0	-13.54	-10.83	-8.16	-12.64	-13.95
45.0	-15.14	-11.47	-11.00	-12.96	-12.58
60.0	-15.91	-11.56	-12.65	-8.18	-7.78
75.0	-16.34	-9.84	-10.26	-5.17	-4.36
90.0	-13.65	-7.55	-6.87	-2.91	-2.71
105.0	-10.47	-5.91	-5.28	-1.75	-1.43
120.0	-8.50	-5.14	-3.91	-1.03	-0.85
135.0	-8.49	-5.00	-3.73	-1.42	-0.76
150.0	-8.58	-5.64	-4.63	-2.56	-1.34
165.0	-9.88	-7.56	-6.12	-4.13	-2.50
180.0	-12.47	-10.42	-9.03	-6.54	-4.49
195.0	-18.10	-15.90	-13.95	-10.81	-7.72
210.0	-16.44	-18.39	-15.79	-12.95	-12.09
225.0	-10.94	-11.95	-10.92	-9.39	-13.28
240.0	-8.60	-7.67	-7.32	-6.68	-8.84
255.0	-7.11	-5.73	-4.94	-4.25	-5.23
270.0	-6.38	-4.95	-3.43	-2.85	-3.51
285.0	-5.92	-4.27	-2.61	-1.78	-1.97
300.0	-5.75	-4.75	-2.50	-1.40	-1.17
315.0	-6.00	-6.03	-2.78	-1.58	-1.06
330.0	-6.98	-7.32	-3.13	-2.10	-1.52
345.0	-7.68	-8.73	-3.81	-3.30	-2.78
360.0	-9.74	-10.81	-4.79	-4.58	-4.95

Design Note DN038

7.2.4 RP_915.000_ver

Azimuth (deg)	Elevation 0 deg (dB)	Elevation 15 deg (dB)	Elevation 30 deg (dB)	Elevation 45 deg (dB)	Elevation 60 deg (dB)	Elevation 75 deg (dB)	Elevation 90 deg (dB)	Elevation 105 deg (dB)
0.0	-2.81	-3.50	-4.12	-5.27	-7.59	-7.96	-8.01	-7.20
15.0	-2.17	-2.96	-3.16	-4.53	-6.08	-6.28	-5.80	-6.24
30.0	-1.68	-2.34	-2.10	-3.37	-4.39	-4.61	-4.01	-4.68
45.0	-1.78	-1.72	-2.15	-2.59	-3.27	-3.58	-3.12	-3.58
60.0	-2.45	-2.11	-2.14	-2.17	-2.64	-2.85	-2.62	-2.69
75.0	-3.21	-2.76	-3.16	-2.50	-2.87	-3.37	-2.96	-3.21
90.0	-5.40	-4.13	-5.19	-3.92	-4.42	-4.89	-4.76	-5.28
105.0	-7.81	-6.56	-8.26	-6.14	-7.36	-7.46	-7.74	-9.29
120.0	-10.07	-9.59	-10.38	-9.27	-11.95	-13.64	-14.70	-21.45
135.0	-11.00	-10.72	-7.86	-9.28	-12.26	-15.16	-17.48	-12.49
150.0	-8.28	-7.43	-4.78	-6.06	-7.16	-7.54	-9.33	-6.34
165.0	-5.98	-4.56	-2.76	-3.65	-3.95	-3.80	-5.38	-3.17
180.0	-4.35	-3.09	-1.33	-2.33	-2.43	-1.86	-3.01	-1.36
195.0	-2.95	-2.05	-0.97	-1.84	-2.21	-1.05	-2.20	-0.30
210.0	-2.73	-1.74	-1.02	-1.93	-2.41	-1.24	-2.64	-0.16
225.0	-2.70	-1.67	-1.40	-2.50	-3.11	-1.89	-3.54	-0.79
240.0	-3.15	-2.58	-2.53	-3.74	-4.98	-3.38	-5.43	-2.08
255.0	-4.12	-3.54	-4.04	-5.11	-7.03	-4.86	-7.90	-4.25
270.0	-5.49	-5.07	-5.72	-7.46	-9.25	-6.79	-11.43	-6.83
285.0	-7.31	-6.97	-7.49	-9.45	-10.26	-9.08	-14.49	-9.75
300.0	-8.43	-8.13	-7.93	-9.77	-10.09	-10.37	-16.41	-12.69
315.0	-7.78	-7.63	-7.43	-8.81	-10.12	-10.90	-15.50	-12.62
330.0	-5.94	-6.55	-6.16	-7.85	-9.75	-10.57	-13.44	-11.03
345.0	-4.13	-5.38	-5.36	-6.47	-9.32	-10.06	-10.81	-9.28
360.0	-3.28	-4.00	-4.35	-5.81	-8.43	-8.56	-8.67	-7.76

Azimuth (deg)	Elevation 120 deg (dB)	Elevation 135 deg (dB)	Elevation 150 deg (dB)	Elevation 165 deg (dB)	Elevation 180 deg (dB)
0.0	-6.75	-6.77	-5.12	-3.09	-1.91
15.0	-5.40	-5.59	-3.77	-2.34	-1.30
30.0	-3.90	-3.92	-2.60	-1.72	-0.90
45.0	-2.68	-2.85	-2.31	-1.42	-1.30
60.0	-2.22	-2.42	-2.41	-1.88	-2.15
75.0	-2.83	-2.94	-3.36	-2.79	-3.34
90.0	-4.65	-4.68	-5.75	-4.68	-6.21
105.0	-8.26	-7.73	-9.83	-7.61	-9.45
120.0	-13.01	-15.76	-18.06	-12.98	-16.31
135.0	-11.99	-17.34	-12.18	-15.57	-13.97
150.0	-7.34	-8.86	-6.43	-8.79	-7.76
165.0	-4.46	-5.32	-4.01	-5.31	-5.37
180.0	-2.87	-3.24	-2.45	-3.29	-3.36
195.0	-1.91	-2.14	-1.52	-2.30	-2.36
210.0	-1.97	-1.79	-1.55	-1.88	-2.11
225.0	-2.75	-1.95	-2.10	-2.05	-2.20
240.0	-3.83	-3.04	-3.21	-3.05	-3.16
255.0	-6.45	-4.41	-4.95	-4.62	-4.66
270.0	-9.94	-6.92	-8.35	-7.51	-7.93
285.0	-12.83	-9.34	-12.66	-12.43	-13.22
300.0	-13.25	-11.78	-16.18	-18.26	-16.54
315.0	-11.50	-12.01	-12.94	-12.92	-9.96
330.0	-9.98	-11.03	-9.77	-7.72	-6.00
345.0	-8.15	-8.85	-6.79	-5.49	-3.44
360.0	-6.98	-7.36	-5.28	-3.62	-2.46

7.2.5 $\theta = 0, \phi = 0$

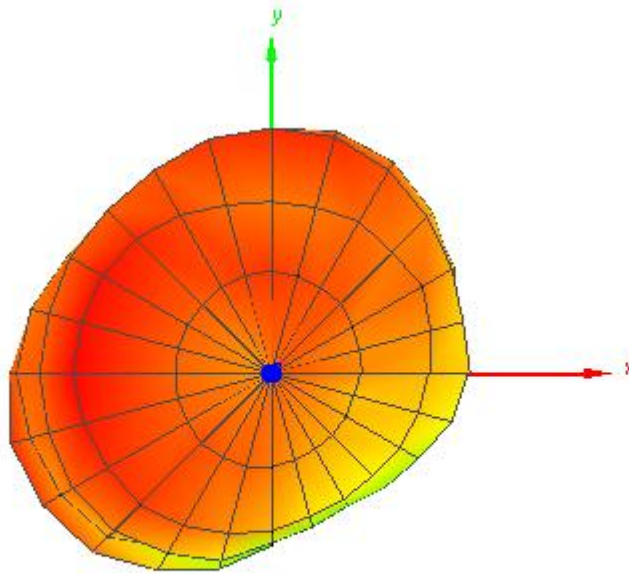

7.2.6 $\theta = 180, \phi = 0$

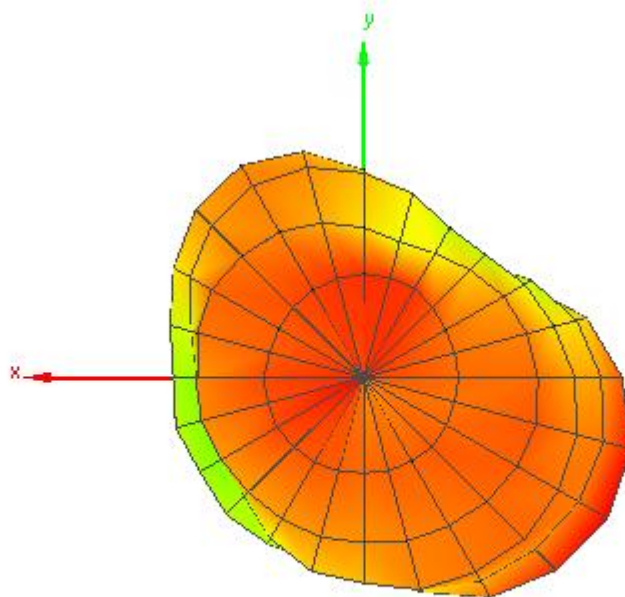

7.2.7 $\theta = 90, \phi = 0$

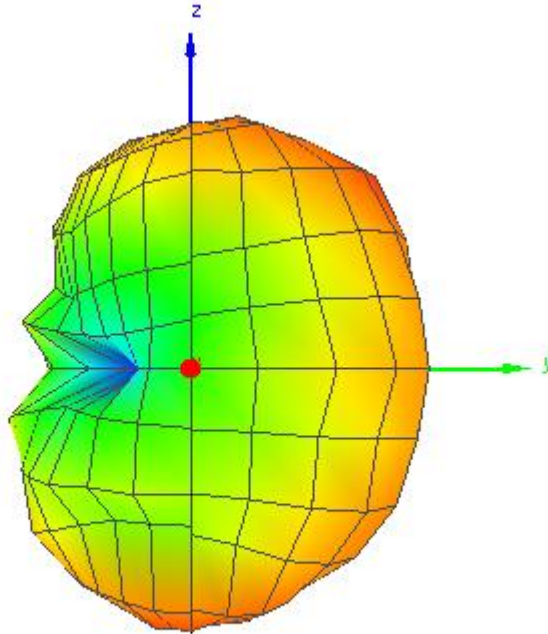

7.2.8 $\theta = 90, \phi = 180$

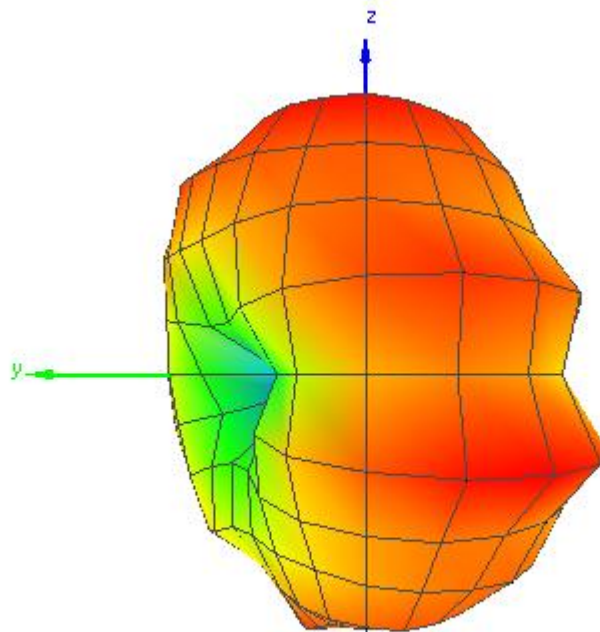

7.2.9 Theta = 90, Phi = 270

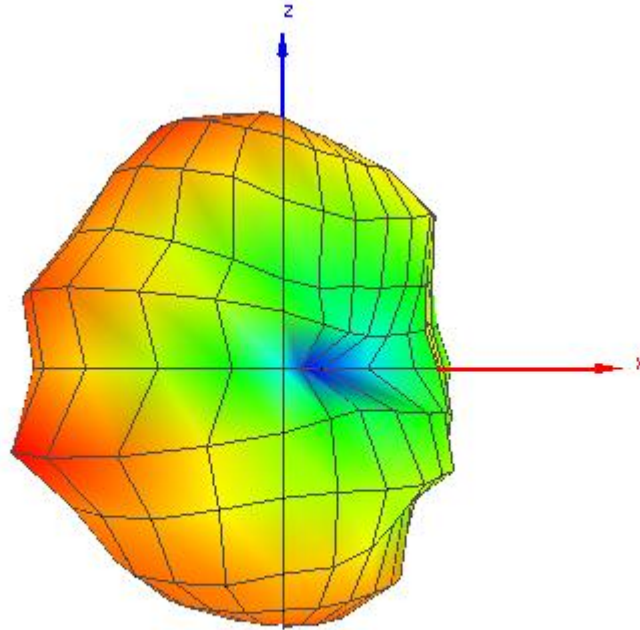

7.2.10 Theta = 90, Phi = 90

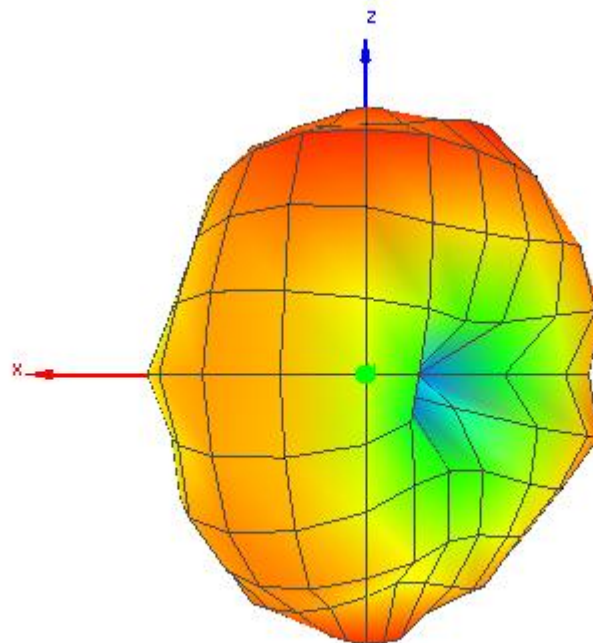

IMPORTANT NOTICE

Texas Instruments Incorporated and its subsidiaries (TI) reserve the right to make corrections, enhancements, improvements and other changes to its semiconductor products and services per JESD46, latest issue, and to discontinue any product or service per JESD48, latest issue. Buyers should obtain the latest relevant information before placing orders and should verify that such information is current and complete. All semiconductor products (also referred to herein as "components") are sold subject to TI's terms and conditions of sale supplied at the time of order acknowledgment.

TI warrants performance of its components to the specifications applicable at the time of sale, in accordance with the warranty in TI's terms and conditions of sale of semiconductor products. Testing and other quality control techniques are used to the extent TI deems necessary to support this warranty. Except where mandated by applicable law, testing of all parameters of each component is not necessarily performed.

TI assumes no liability for applications assistance or the design of Buyers' products. Buyers are responsible for their products and applications using TI components. To minimize the risks associated with Buyers' products and applications, Buyers should provide adequate design and operating safeguards.

TI does not warrant or represent that any license, either express or implied, is granted under any patent right, copyright, mask work right, or other intellectual property right relating to any combination, machine, or process in which TI components or services are used. Information published by TI regarding third-party products or services does not constitute a license to use such products or services or a warranty or endorsement thereof. Use of such information may require a license from a third party under the patents or other intellectual property of the third party, or a license from TI under the patents or other intellectual property of TI.

Reproduction of significant portions of TI information in TI data books or data sheets is permissible only if reproduction is without alteration and is accompanied by all associated warranties, conditions, limitations, and notices. TI is not responsible or liable for such altered documentation. Information of third parties may be subject to additional restrictions.

Resale of TI components or services with statements different from or beyond the parameters stated by TI for that component or service voids all express and any implied warranties for the associated TI component or service and is an unfair and deceptive business practice. TI is not responsible or liable for any such statements.

Buyer acknowledges and agrees that it is solely responsible for compliance with all legal, regulatory and safety-related requirements concerning its products, and any use of TI components in its applications, notwithstanding any applications-related information or support that may be provided by TI. Buyer represents and agrees that it has all the necessary expertise to create and implement safeguards which anticipate dangerous consequences of failures, monitor failures and their consequences, lessen the likelihood of failures that might cause harm and take appropriate remedial actions. Buyer will fully indemnify TI and its representatives against any damages arising out of the use of any TI components in safety-critical applications.

In some cases, TI components may be promoted specifically to facilitate safety-related applications. With such components, TI's goal is to help enable customers to design and create their own end-product solutions that meet applicable functional safety standards and requirements. Nonetheless, such components are subject to these terms.

No TI components are authorized for use in FDA Class III (or similar life-critical medical equipment) unless authorized officers of the parties have executed a special agreement specifically governing such use.

Only those TI components which TI has specifically designated as military grade or "enhanced plastic" are designed and intended for use in military/aerospace applications or environments. Buyer acknowledges and agrees that any military or aerospace use of TI components which have **not** been so designated is solely at the Buyer's risk, and that Buyer is solely responsible for compliance with all legal and regulatory requirements in connection with such use.

TI has specifically designated certain components as meeting ISO/TS16949 requirements, mainly for automotive use. In any case of use of non-designated products, TI will not be responsible for any failure to meet ISO/TS16949.

Products

Audio	www.ti.com/audio
Amplifiers	amplifier.ti.com
Data Converters	dataconverter.ti.com
DLP® Products	www.dlp.com
DSP	dsp.ti.com
Clocks and Timers	www.ti.com/clocks
Interface	interface.ti.com
Logic	logic.ti.com
Power Mgmt	power.ti.com
Microcontrollers	microcontroller.ti.com
RFID	www.ti-rfid.com
OMAP Applications Processors	www.ti.com/omap
Wireless Connectivity	www.ti.com/wirelessconnectivity

Applications

Automotive and Transportation	www.ti.com/automotive
Communications and Telecom	www.ti.com/communications
Computers and Peripherals	www.ti.com/computers
Consumer Electronics	www.ti.com/consumer-apps
Energy and Lighting	www.ti.com/energy
Industrial	www.ti.com/industrial
Medical	www.ti.com/medical
Security	www.ti.com/security
Space, Avionics and Defense	www.ti.com/space-avionics-defense
Video and Imaging	www.ti.com/video

TI E2E Community

e2e.ti.com