

# Low Power 60GHz mm-Wave Sensor Evaluation Module



## Description

The IWR6432AOPEVM is an easy-to-use, low cost FR4-based evaluation board for the IWR6432AOP mmWave sensing device, with standalone operation and direct connectivity to the DCA1000EVM for raw ADC capture and signal processing development. This EVM contains everything required to start developing software for on-chip hardware accelerator and low power ARM® Cortex®-M4F processor.

## Features

- Wide field of view antenna, targeted for wall mount and ceiling sensing applications
- FR4-based PCB substrate
- XDS110 JTAG interface with USB connectivity for code development and debugging
- Power optimized discrete DCDC power management design
- Serial port for onboard QSPI flash programming
- 60-pin, high-density (HD) connectors for raw analog-to-digital converter (ADC) data

- On board CAN-FD transceiver
- On board INA228 for ultra-precise digital power monitoring
- USB powered standalone mode of operation

## Applications

- **Industrial:**
  - Automated door and gate
  - Motion detector
  - Occupancy detection (people tracking, people counting)
  - Video doorbell
  - IP network camera
  - Air conditioner
  - Refrigerators and freezers
  - Lawn mover
  - Portable electronics
  - Televisions
  - Home theater and entertainment

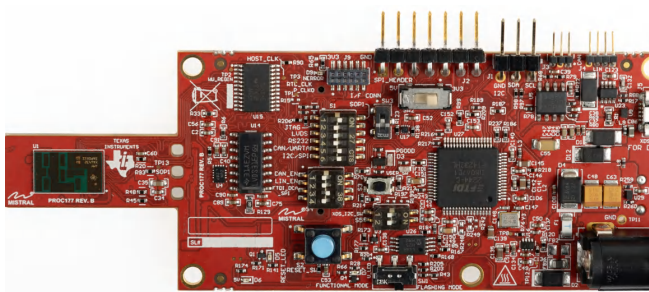

IWR6432AOPEVM (Top View)

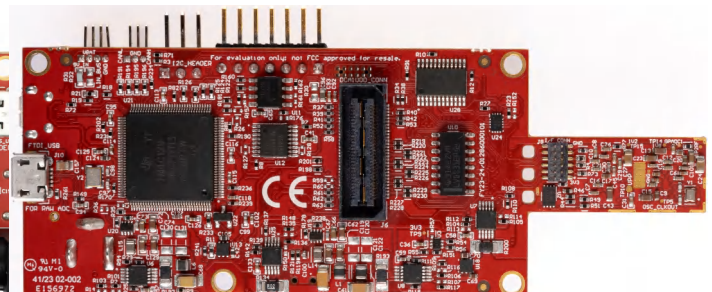

IWR6432AOPEVM (Bottom View)

# 1 Evaluation Module Overview

## 1.1 Introduction

The IWRL6432AOP Evaluation Module (EVM) offered by Texas Instruments presents an easy to use and cost-effective platform for assessing the capabilities of the IWRL6432AOP mmWave sensing device. Designed with an FR4-based PCB substrate, this evaluation board has seamless integration with the DCA1000EVM for direct connectivity, facilitating raw ADC capture and signal processing development. With a focus on user-friendliness and versatility, the EVM can operate in stand alone mode and includes all features that streamline the initiation of software development for on-chip hardware accelerators and low-power ARM® Cortex® M4F processor.

Key attributes of this EVM include a wide-field-of-view AOP (antenna on package), specifically crafted for wall-mount, and ceiling sensing applications. For efficient code development and debugging, the EVM is equipped with a USB-connected XDS110 JTAG interface. The inclusion of a power-efficient discrete DC-DC regulators enhances overall energy efficiency. Additionally, the EVM incorporates a serial port for programming the onboard QSPI flash and features a 60-pin high-density (HD) connector designed for the capture of raw ADC data from the mmWave radar device.

To facilitate code debugging and data capture, the EVM incorporates an FTDI chip configured for SPI-based raw data capture. The EVM has the INA228 high precision current sensors which have remarkable accuracy, measuring current accurately up to micro-amperes. Operating in an independent mode powered via USB, and with an on board 16 MB QSPI flash, this EVM stands as a comprehensive design for developers keen on exploring the potential of the IWRL6432AOP mmWave sensing device.

## 1.2 Kit Contents

IWRL6432AOPEVM kit includes the following:

- IWRL6432AOP Evaluation board
- Micro USB cable
- Quick Start Guide
- Warranty card (disclaimer sheet)
- Head Screws
- Hexagon Spacers
- Plain Washers

## 1.3 Specification

The IWRL6432AOPEVM includes two transmitters and three receivers antenna on package with a wide field of view antennas. The IWRL6432AOP mmWave sensor is an essential part of this evaluation module, operating in a 7GHz bandwidth between 57GHz and 64GHz. The IWRL6432AOP evaluation module is specifically designed for the IWRL6432AOP mmWave sensing device, with standalone functionality and seamless connectivity to the DCA1000EVM for direct raw ADC capture

The IWRL6432AOPEVM has a wide range of industrial applications, including automated door/gate systems, IP network cameras, thermostats, air conditioners, vacuum robots, freezers, refrigerators, people tracking, people counting, video doorbells, PCs/notebooks, portable electronics, televisions, tablets, earphones, smart watches, gaming devices, home theater and entertainment systems.

### 1.3.1 Block Diagram

[Figure 1-1](#) shows the functional block diagram. The mission board (sensor area) side contains the essential components for the TI radar system namely Crystal Oscillator, Serial FLASH and TI mmWave Radar chip. The expandable area contains the Power Distribution Network, on board XDS110 USB to UART converter, FTDI chip, 60-pin connector for interfacing with the DCA1000EVM.

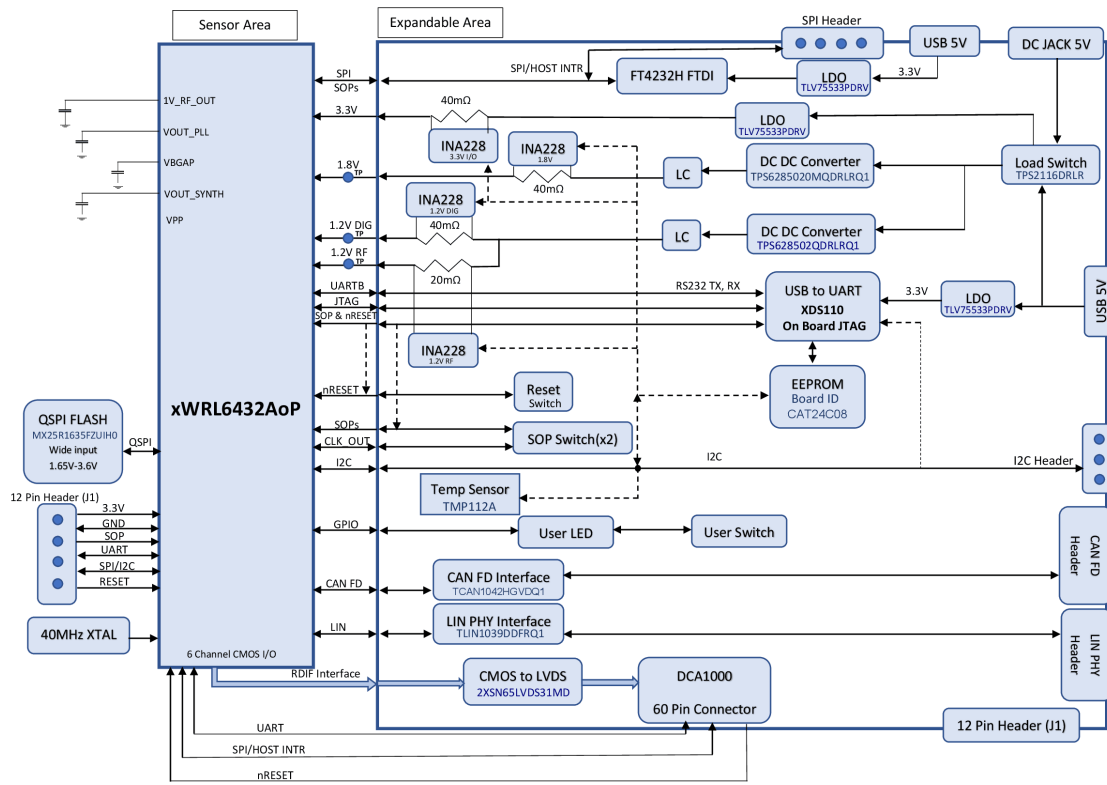

Figure 1-1. Block Diagram of the IWRL6432AOPEVM

### 1.3.2 EVM Mux Block Diagram

Figure 1-2 shows different muxing options for the digital signals. The device is pin limited to support different features simultaneously; hence various internal IPs and signals are pin multiplexed. EVM provides de-muxing options using various analog mux and sliding switch options. Figure 1-2 shows different muxing switch positions to enable different muxing options to connect to different peripherals.

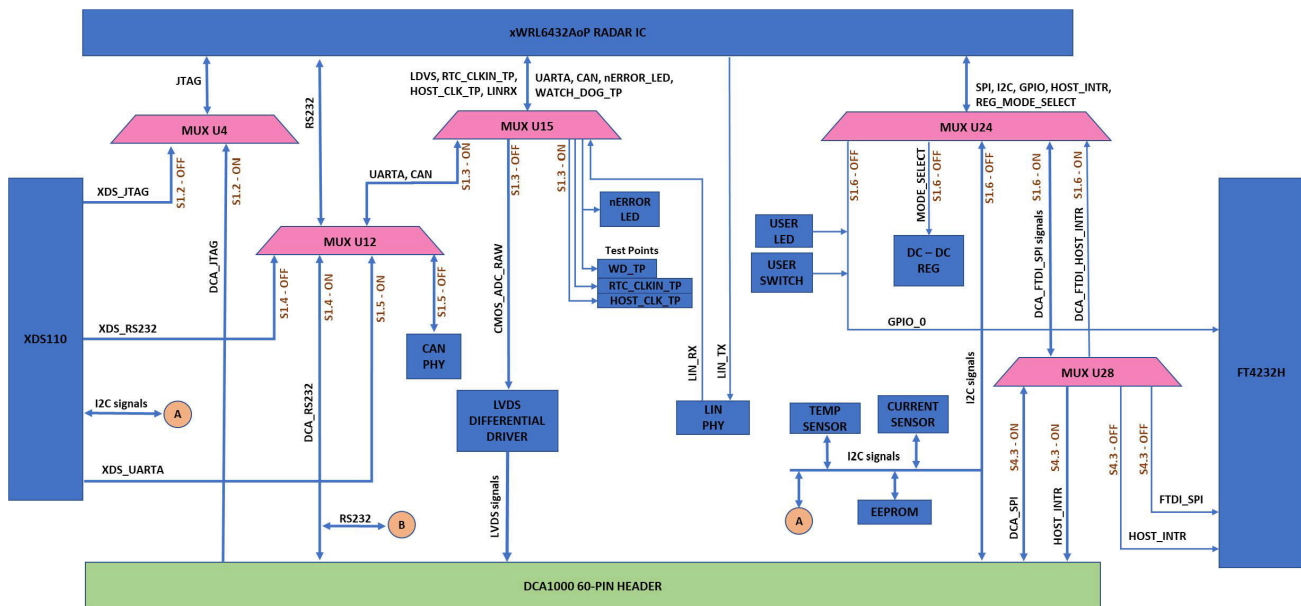

Figure 1-2. Muxing Options for the EVM

## 1.4 Device Information

The IWRL6432AOP mmWave Sensor device is an Antenna-on-Package (AOP) device that is an evolution within integrated single chip mmWave sensor based on FMCW radar technology. The device is capable of operation in the 57GHz to 64GHz band and is partitioned into mainly four power domains:

- **RF/Analog Sub-System:** This block includes all the RF and Analog components required to transmit and receive the RF signals.
- **Front-End Controller sub-System (FECSS):** FECSS contains ARM Cortex M3 processor, responsible for radar front-end configuration, control, and calibration.
- **Application Sub-System (APPSS):** APPSS is where the device implements a user programmable ARM Cortex M4 allowing for custom control and automotive interface applications. Top Sub-System (TOPSS) is part of the APPSS power domain and contains the clocking and power management sub-blocks.
- **Hardware Accelerator (HWA):** HWA block supplements the APPSS by offloading common radar processing such as FFT, Constant False Alarm rate (CFAR), scaling, and compression.

IWRL6432AOP is specifically designed to have separate knobs for each of the above-mentioned power domains to control the states (power ON or OFF) based on use case requirements. The device also features the capability to exercise various low-power states like sleep and deep sleep, where low-power sleep mode is achieved by clock gating and by turning off some of the internal IP blocks of the device. The device also provides the option of keeping some contents of the device, like application image or RF profile retained in such scenarios.

Additionally, the device is built with TI's low power 45-nm RF CMOS process and enables unprecedented levels of integration in an extremely small form factor. IWRL6432AOP is designed for low power, self-monitored, ultra-accurate radar systems in the industrial applications.

## 1.5 IWRL6432AOPEVM Antenna

The IWRL6432AOPEVM includes three receiver and two transmitter short range antennas on the package of the chip. [Figure 1-3](#) shows the antenna on package.

### Note

There should not be any taller components in the Field Of View (FOV) of the antenna to avoid any multipath reflection. We should also have a keep out area of at least one wavelength (5mm) from either edge of the device.

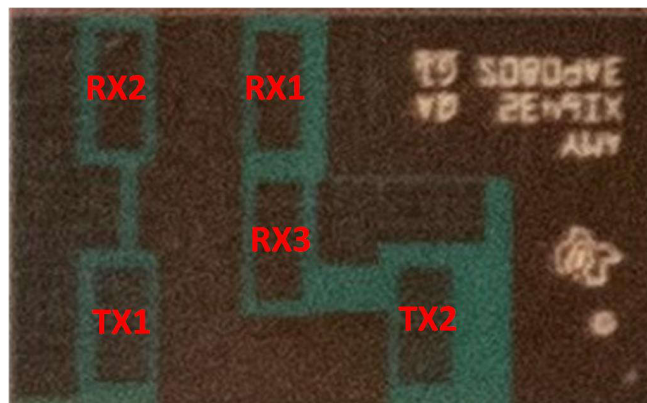

**Figure 1-3. AOP Antennas**

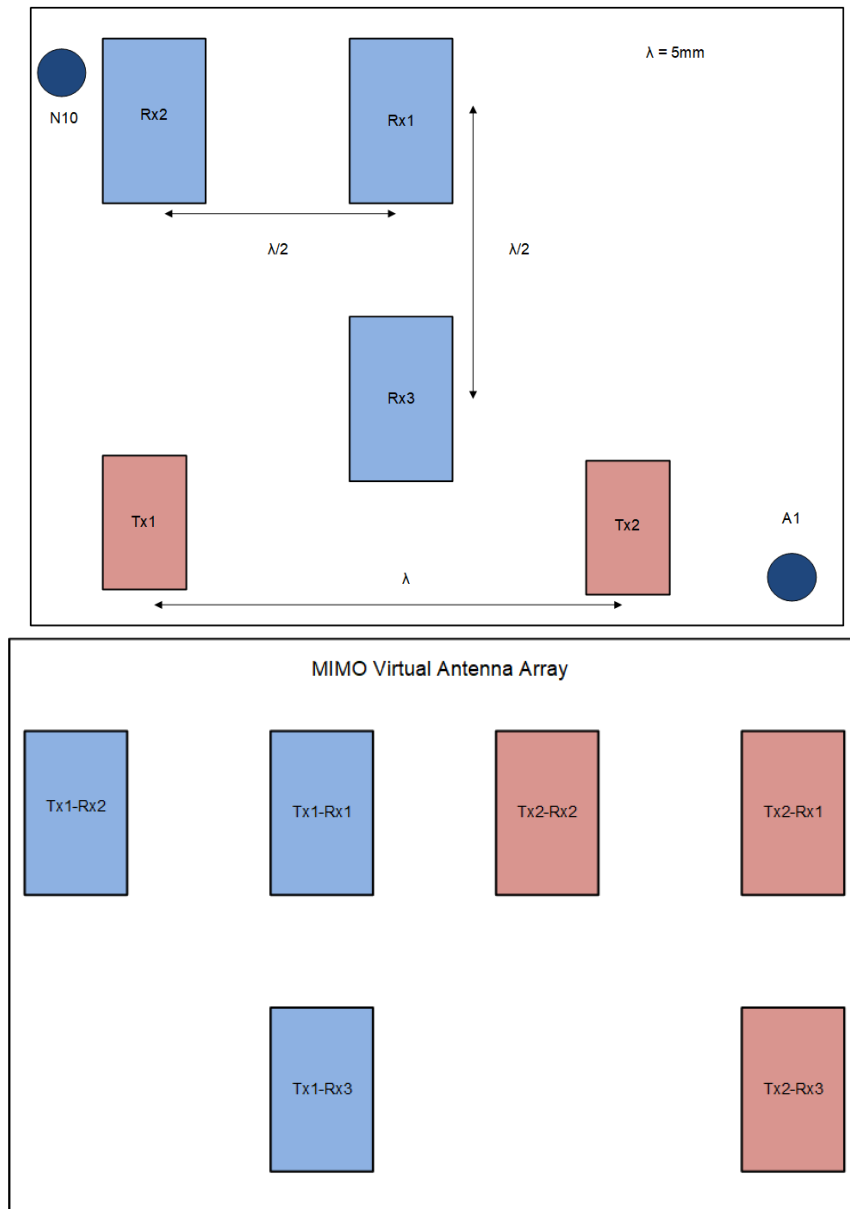

Figure 1-4. IWRL6432AOP Antenna Placement MIMO Array

## 2 Hardware

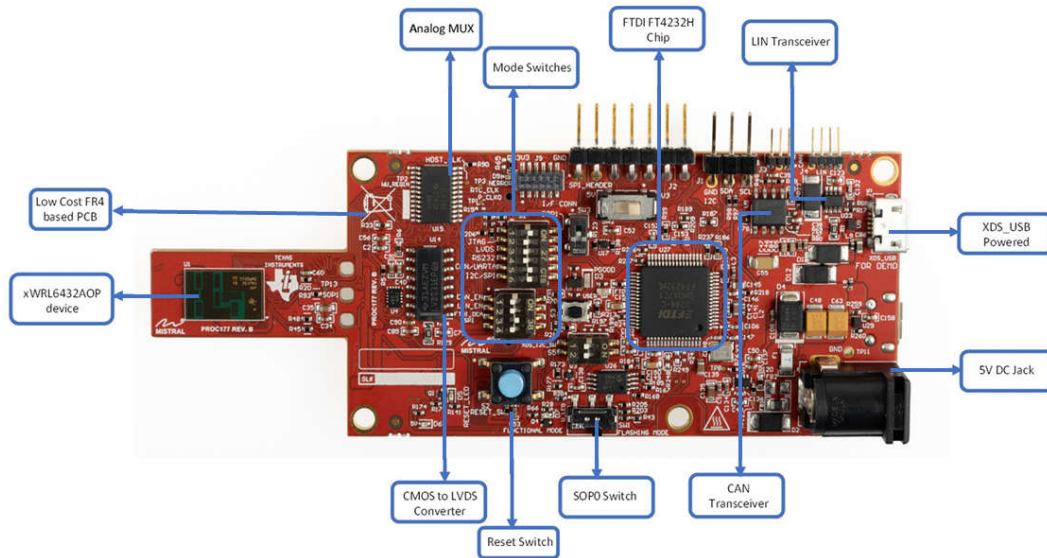

Figure 2-1. Salient Features of EVM (Top side)

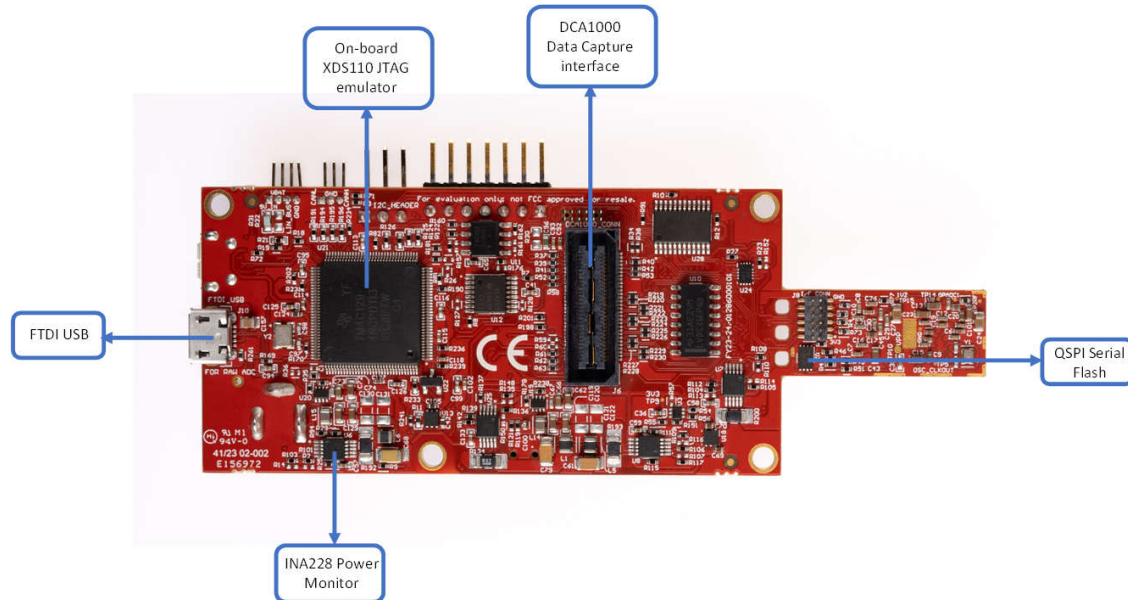
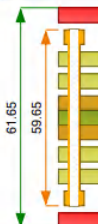

Figure 2-2. Salient Features of EVM (Bottom side)

## 2.1 PCB Material

Material used for this PCB is regular FR4 based Iteq IT180A Prepreg 1080 RC65 for the PCB layers.

Layer	Stack up	Description	Processed Thickness	Isolation Distance (Summed)	Copper Coverage	$\epsilon_r$	Impedance ID	Supplier Description	Tg
1		ELECTRA EMP 110/5410- RED	1.000			4.000		EMP 110/5410	
		Copper Foil 12 microns	1.850		100.000			HI-Q Foil	
2		Iteq IT180A Prepreg 1080 RC65-NEW	2.328	4.656		3.860		IPC-4101E / 99/ 101/ 126	170.000
		Iteq IT180A Prepreg 1080 RC65-NEW	2.328	-		3.860		IPC-4101E / 99/ 101/ 126	170.000
3		Iteq IT180A 47 mil core 2/2	2.638	41.600		3.770		IPC-4101E / 99/ 101/ 126	170.000
			2.638		43.000				
4		Iteq IT180A Prepreg 1080 RC65-NEW	2.209	4.419		3.860		IPC-4101E / 99/ 101/ 126	170.000
		Iteq IT180A Prepreg 1080 RC65-NEW	2.209	-		3.860		IPC-4101E / 99/ 101/ 126	170.000
		Copper Foil 12 microns	1.850		100.000			HI-Q Foil	
		ELECTRA EMP 110/5410- RED	1.000			4.000		EMP 110/5410	

## 2.2 Switches and LEDs

### 2.2.1 SOP Configuration

**Table 2-1. SOP Configuration**

	SOP0(SW1)	SOP1(S1.1)
Flashing	OFF	OFF
Functional	ON	OFF
Debug	ON	ON

#### Note

The *Debug* mode selection is for the IWRL6432AOP device debug bypassing the bootloader and not for code debug. For code debug, functional mode must be used.

### 2.2.2 Switches

Table 2-2 shows the list of push buttons and usage.

**Table 2-2. Switches Information**

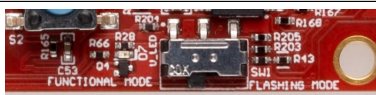
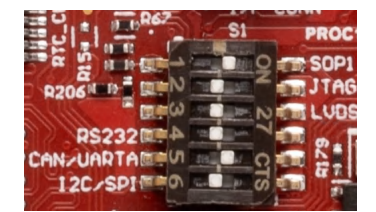
Reference Designator	Usage	Comments	Image
SW1	SOP0	Switch between Functional and Flashing mode	 <b>Figure 2-3. SW1 Switch</b>
S1.1	SOP1	OFF : Flashing / Functional Mode ON : Debug Mode	 <b>Figure 2-4. S1 Switch</b>
S1.2	JTAG	OFF : XDS_JTAG ON : DCA_JTAG	
S1.3	RDIF	OFF : RDIF ON : LIN_RX, XDS_UARTA/CAN, NERROR_LED, WATCH_DOG_TP, HOST_CLK_TP	
S1.4	RS232	OFF : XDS_RS232 ON : DCA_RS232	
S1.5	CAN/UARTA	OFF : CAN ON : XDS_UARTA	
S1.6	I2C/SPI	OFF : I2C, REG_MODE, LED_SW_GPIO ON : SPI	

**Table 2-2. Switches Information (continued)**





Reference Designator	Usage	Comments	Image
S4.1	CAN Enable	OFF : CAN PHY : Stand-by Mode Disable ON : CAN PHY : Stand-by Mode Enable	 <p><b>Figure 2-5. S4 Switch</b></p>
S4.2	LIN Enable	OFF : LIN PHY : Enable ON : LIN PHY : Disable	
S4.3	FTDI/DCA SPI	OFF : FTDI_SPI ON : DCA_SPI	
S5.1	XDS SDA	OFF : XDS_SDA Disable ON : XDS_SDA Enable	 <p><b>Figure 2-6. S5 Switch</b></p>
S5.2	XDS SCL	OFF : XDS_SCL Disable ON : XDS_SCL Enable	
S2	RESET Switch	Bounce Switch	 <p><b>Figure 2-7. S2 Switch</b></p>
S3	USER Switch	Bounce Switch	 <p><b>Figure 2-8. S3 Switch</b></p>
SW2	Reference Design Connectivity Switch	Switch between 5V and 3.3V : To supply 5V to reference design (Only required when reference design is connected on EVM)	 <p><b>Figure 2-9. SW2 Switch</b></p>
SW3	Reference Design Connectivity Switch	OFF : Switch low to put reference design into Flashing Mode (as shown in image) (Only required when reference design is connected on EVM)	 <p><b>Figure 2-10. SW3 Switch</b></p>

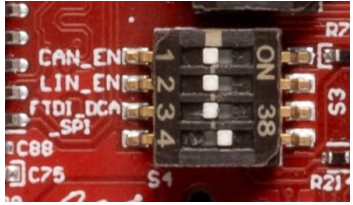

Table 2-3 provides the list of LEDs and usage.

**Table 2-3. LEDs Information**

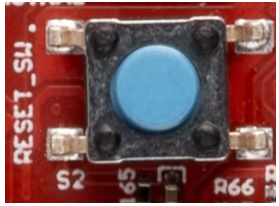
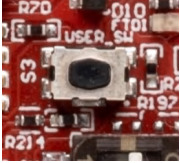
Reference Designator	Color	Usage	Comments	Image
D3	YELLOW	PGOOD	3V3 supply indication	 <p><b>Figure 2-11. D3</b></p>
D5	GREEN	nRESET	This LED is used to indicate the state of nRESET pin. If this LED is glowing, then the device is out of reset. This LED glows only after the 5V supply is provided.	 <p><b>Figure 2-12. D5</b></p>
D6	GREEN	POWER	This LED indicates the presence of the 5V supply.	 <p><b>Figure 2-13. D6</b></p>
D7	GREEN	USER LED	Customer programmable user LED. Note: Switch S3 settings are needed to enable this.	 <p><b>Figure 2-14. D7</b></p>
D9	RED	NERROUT	Glow if there is any HW error in the mmWave sensor device.	 <p><b>Figure 2-15. D9</b></p>
D10	YELLOW	FTDI	Glow if the USB is in suspend mode	 <p><b>Figure 2-16. D10</b></p>

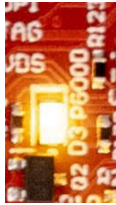
## 2.3 DC Jack

Higher current support: When using the EVM with the external power adapter, the 5V supply is provided by the external power adapter. For most of the use cases, this external power supply option is not used, as power is derived from the USB interface.



---

### Note

After the 5V power supply is provided to the EVM, TI recommends pressing the NRST switch one time to verify a reliable boot-up state.

---

### Note

All digital IO pins of the device (except NRESET) are not fail safe; hence, care needs to be taken that the pins are not driven externally without the VIO supply being present to the device.

---

## 2.4 DCA1000 HD Connector

The 60-pin HD connector shown in [Figure 2-17](#) provides the high-speed data and controls signals (SPI, UART, I2C, NRST, NERROR, and SOPs) to the DCA1000.

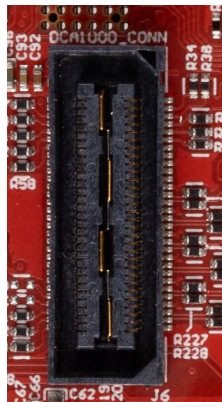

**Figure 2-17. DCA1000 HD Connector**

## 2.5 CANFD Connector

The CAN FD connector provides access to the CAN\_FD interfaces (CAN\_L and CAN\_H signals) from the onboard CAND-FD transceiver. These signals can be directly wired to the CAN bus.

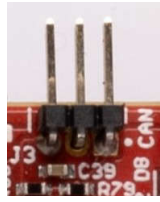

Figure 2-18. CANFD Connector

The J3 connector shown in Figure 2-18 provides the CAN\_L and CAN\_H signals from the onboard CAND-FD transceivers (TCAN1042HGVDQ1). These signals are wired to the CAN bus after muxing with the SPI interface signals; one of the two paths must be selected. CAN signals are selected to PHY by changing the switch S1.5 to off position.

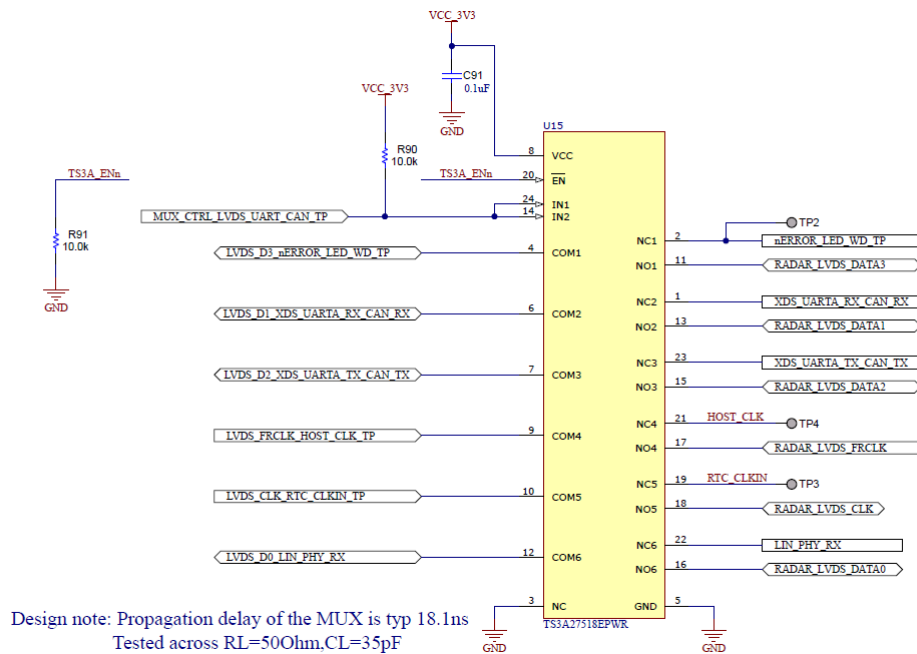

Figure 2-19. Analog Mux for the CAN PHY Switch

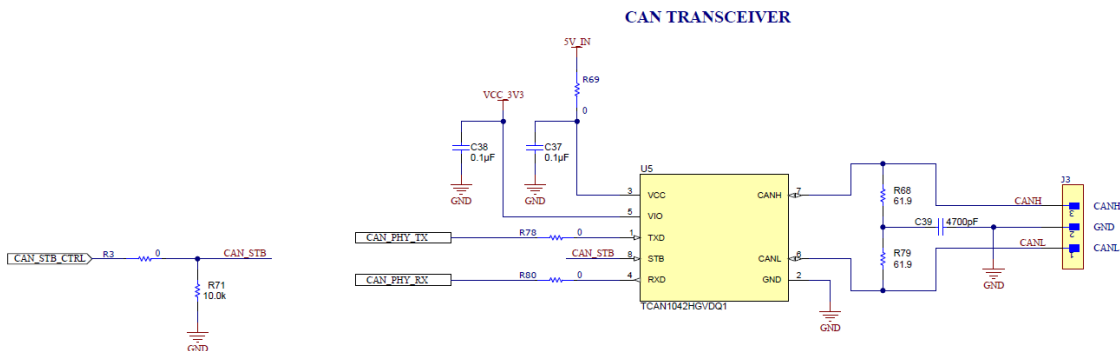

Figure 2-20. CAN FD PHY Used in the EVM

## 2.6 LIN PHY Connection

Figure 2-21 shows the LIN PHY (TLIN1039DDFRQ1) interface to the device. There are no switches for the LIN PHY interface. LIN PHY can operate with different supply voltage than the mmWave sensor, hence external VBAT option is provided for the LIN VDD supply, by default 5V\_IN supply is provided. To enable external VBAT supply, R32 resistor need to be mounted and R31 resistor need to be removed.

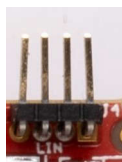

Figure 2-21. LIN Header and PHY Interface

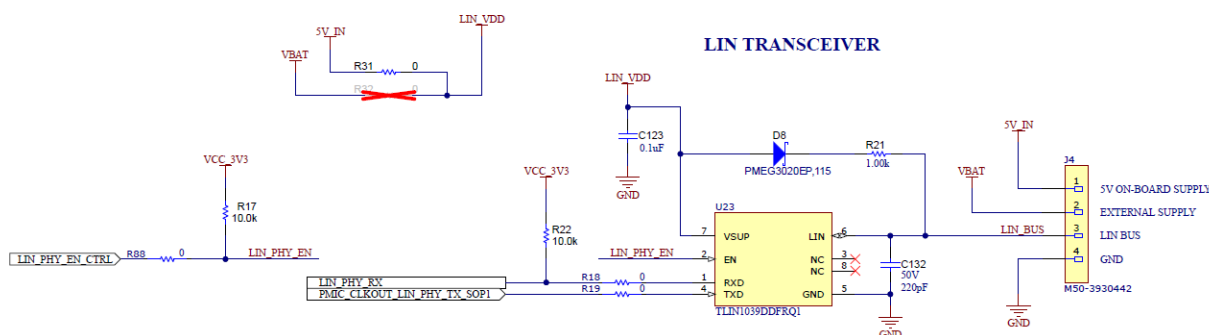

Figure 2-22. LIN PHY Interface

## 2.7 I2C Connections

The board features an EEPROM, current sensors, and temperature sensor for measuring on-board temperature. These are connected to the I2C bus and can be isolated using the zero  $\Omega$  provided on the hardware. External I2C headers also provided for easy interface to I2C bus.

### 2.7.1 EEPROM

The board features an EEPROM for storing the board specific IDs (for the identification of the EVM through the XDS110 interface). Please refer to EVM schematics for the I2C addresses.

### 2.7.2 On-Board Sensors

The IWRL6432AOPEVM provides access to an on-board temperature sensor (TMP112AQDRLRQ1) and four on-board current sensors (INA228AIDGST). These sensors can be controlled by the radar via I2C.

The current sensors are designed to measure the current being supplied to the various power rails of the IWRL6432AOP device. For details on the supply rails that can be measured using the current sensors, refer to Table 2-4.

Table 2-4. Current Sensor Supply Details

Reference Designator	Supply Node	PCB Net Name
U6	1.8V Supply	REG_1V8
U7	3.3V Supply	VCC_3V3
U8	1.2V Supply	REG_1V2
U25	1.2V RF Supply	REG_RF_1V2

## 2.8 XDS110 Interface

J5 provides access to the onboard XDS110 (TM4C1294NCPDT) emulator. This connection provides the following interfaces to the PC:

- JTAG for CCS connectivity
- Application/user UART (Configuration and data communication to PC)

When used in standalone mode of operation as shown in [Figure 2-25](#), the power is supplied through a single USB connector; the same USB connector J5 is also used for configuration and data transfer through the XDS110 USB to UART converter. When enumerated correctly, the 2 UART ports from the XDS110 are displayed on the device manager as a virtual COM Port, similar to that shown in [Figure 2-24](#).

If the PC is unable to recognize the above COM ports, Then install the latest [EMU-pack](#). Similar to that shown in [Figure 2-23](#).

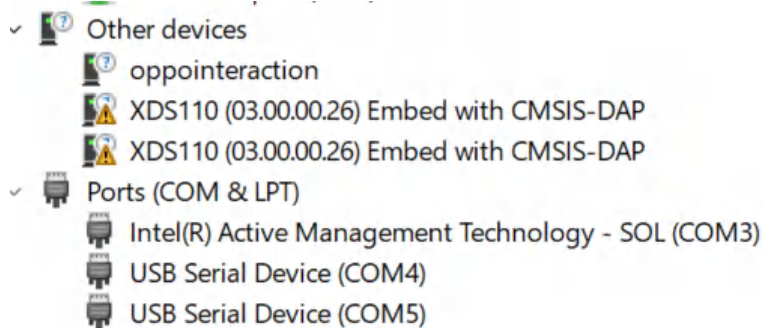

**Figure 2-23. Virtual COM Port Before Installing XDS Drivers**

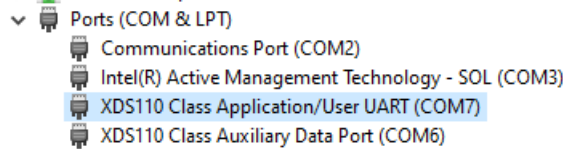

**Figure 2-24. Virtual COM Port After Installing XDS Drivers**

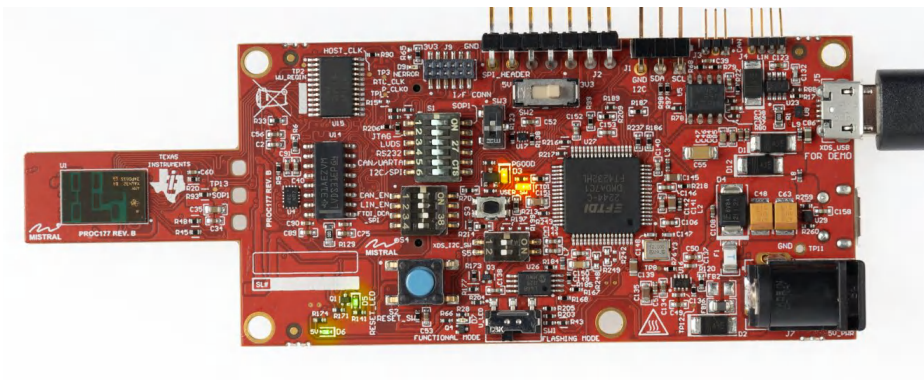

**Figure 2-25. EVM in Functional Mode Using Standalone Operation**

EVM uses single UART port for both device configuration and processed data communication to PC.

## 2.9 FTDI Interface

J10 provides access to the onboard FTDI ports. This provides the following interfaces to the PC:

- FTDI Port A -> SPI interface
- FTDI Port B-> Host INTR signal.
- FTDI Port C -> NRESET control signal.
- FTDI Port D -> SOP0, SOP1 control signals

When the USB is connected for the first time to the PC, a possibility is that Windows® does not recognize the device. This is indicated in the device manager with yellow exclamation marks, as shown in [Figure 2-26](#).

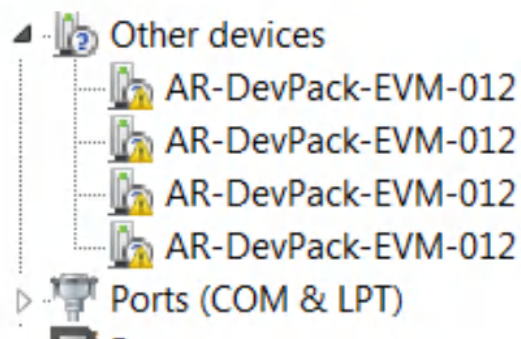

**Figure 2-26. Uninstalled FTDI Drivers**

To install the devices, download the latest FTDI drivers available in [Section 3.3](#). Right click on these devices, and update the drivers by pointing to the location where the FTDI drivers were installed (C:\ti\mmwave\_sdk\_<version\_number>\tools\ftdi). This must be done for all four COM ports. When all four COM ports are installed, the device manager recognizes these devices and indicates the COM port numbers, as shown in [.Figure 2-27](#)

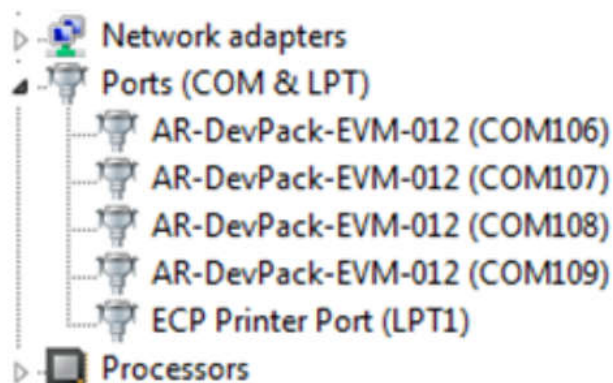

**Figure 2-27. Installed FTDI Drivers**

### 3 Software

#### 3.1 Software Description

To enable quick development of end applications on the ARM Cortex-M4F core in the IWRL6432AOP, TI provides a software development kit (SDK) that includes demo codes, software drivers, emulation packages for debug, and more.

For more information, please refer to mmWave low power SDK user guide: [MMWAVE-L-SDK](#).

#### 3.2 Flashing the Board

1. Make sure the drivers have been successfully installed and COM ports enumerated. Refer to [Section 2.8](#).
2. Configure the SOP to [Section 2.2.1](#).
3. Press the Reset switch ([Section 2.2.2](#)) to make sure that the board boots up in the right mode.
4. Run the mmWave Visualizer inside mmWave-L-SDK tool folder and use the flashing tab and follow the instruction or use Uniflash tool. Similar to that shown in [Figure 3-1](#).
5. Enter the application port number for the flashing interface.
6. Select the image to flash to the EVM in the *Image Flash* menu, or directly upload the image from the mmWave SDK  
 (C:\ti\MMWAVE\_L\_SDK\examples\mmw\_demo\motion\_and\_presence\_detection\prebuilt\_binaries\xwrl64xx). Load appimage to serial flash. Similar to that shown in [Figure 3-2](#). Please refer mmWave SDK for the flash binary for running out of box demos.

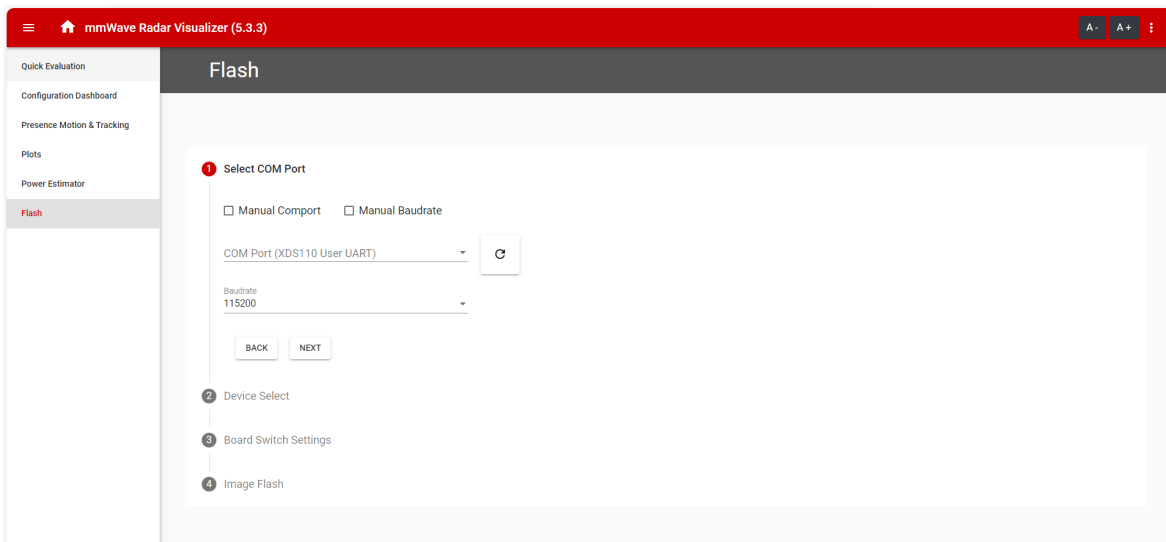

**Figure 3-1. Flash Tab in Visualizer Tool**

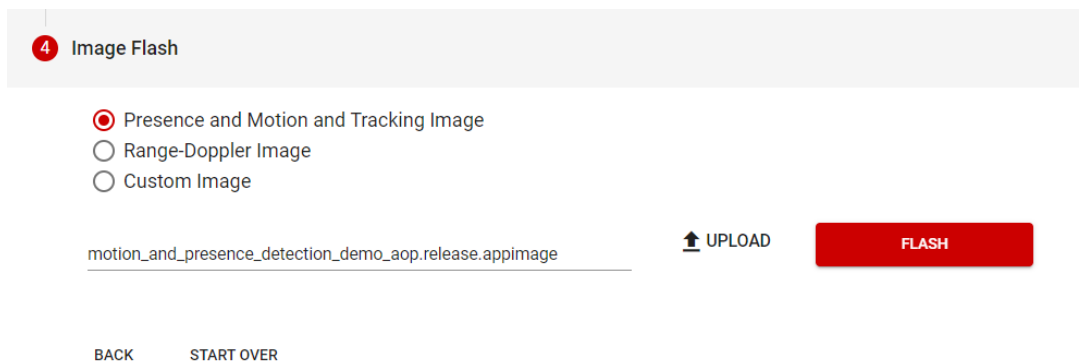

**Figure 3-2. Out of Box Demo Binary App**

### 3.3 mmWave Out of Box Demo

TI provides sample demo code to easily get started with the IWR6432AOP evaluation module (EVM) to experience the functionality of the IWR6432AOP mmWave sensor. For details on getting started with these demos visit [mmWave-L-SDK](#) on ti.com page.

See how to get started with IWR6432AOP mmWave radar sensors with this step-by-step tutorial on running the out-of-box demo and visualizing the output. Please refer to [Out-of-box demo tutorial for IWR6432AOP evaluation modules](#).

#### 3.3.1 IWR6432AOP Demo Visualization Getting Started

Please follow the below step by step procedure for running the OOB demo.

1. Connect the EVM to the PC via USB.
2. Open the mmWave Visualizer inside mmWave-L-SDK tool. Check the SOP settings for [Section 2.2.1](#).
3. Navigate to *Configuration Dashboard* tab of the visualizer and select the device. Wait for AUTO detection of COM ports (else press refresh). Alternatively, manually select device COM port (if not already selected). Select preset configuration under *Configuration Selection* drop-down. Similar to that shown in [Figure 3-3](#).
4. Click on *Send Config to Device*.
5. After configurations are successfully sent, the *Plots* tab displays range plot via radar point cloud information. Similar to that shown in [Figure 3-4](#).

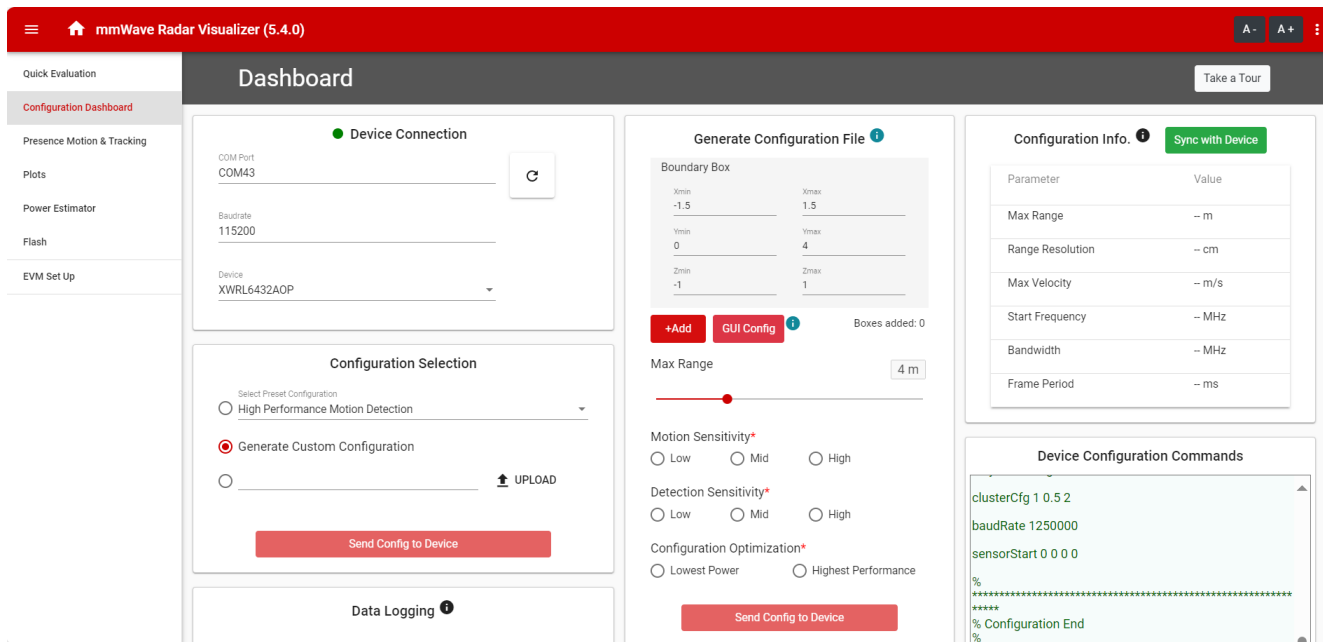

The screenshot displays the mmWave Radar Visualizer (5.4.0) Configuration Dashboard. The interface is organized into several functional areas:

- Device Connection:** Shows a green status indicator for 'Device Connection'. The COM Port is set to 'COM43' and the Device is 'XWRL6432AOP'.
- Configuration Selection:** Offers options to 'Select Preset Configuration' (currently 'High Performance Motion Detection') or 'Generate Custom Configuration' (which is selected). An 'UPLOAD' button is present.
- Generate Configuration File:** Features a 'Boundary Box' configuration table:
 

Parameter	Value
Xmin	-1.5
Xmax	1.5
Ymin	0
Ymax	4
Zmin	-1
Zmax	1

 Below this, there is a 'Max Range' slider set to '4 m' and radio button options for 'Motion Sensitivity\*', 'Detection Sensitivity\*', and 'Configuration Optimization\*'.
- Configuration Info:** A table listing various parameters and their values:
 

Parameter	Value
Max Range	-- m
Range Resolution	-- cm
Max Velocity	-- m/s
Start Frequency	-- MHz
Bandwidth	-- MHz
Frame Period	-- ms
- Device Configuration Commands:** A text area showing the following commands:
 

```
clusterCfg 1 0.5 2
baudRate 1250000
sensorStart 0 0 0 0
*****
% Configuration End
%
```

Figure 3-3. Configuration Dashboard



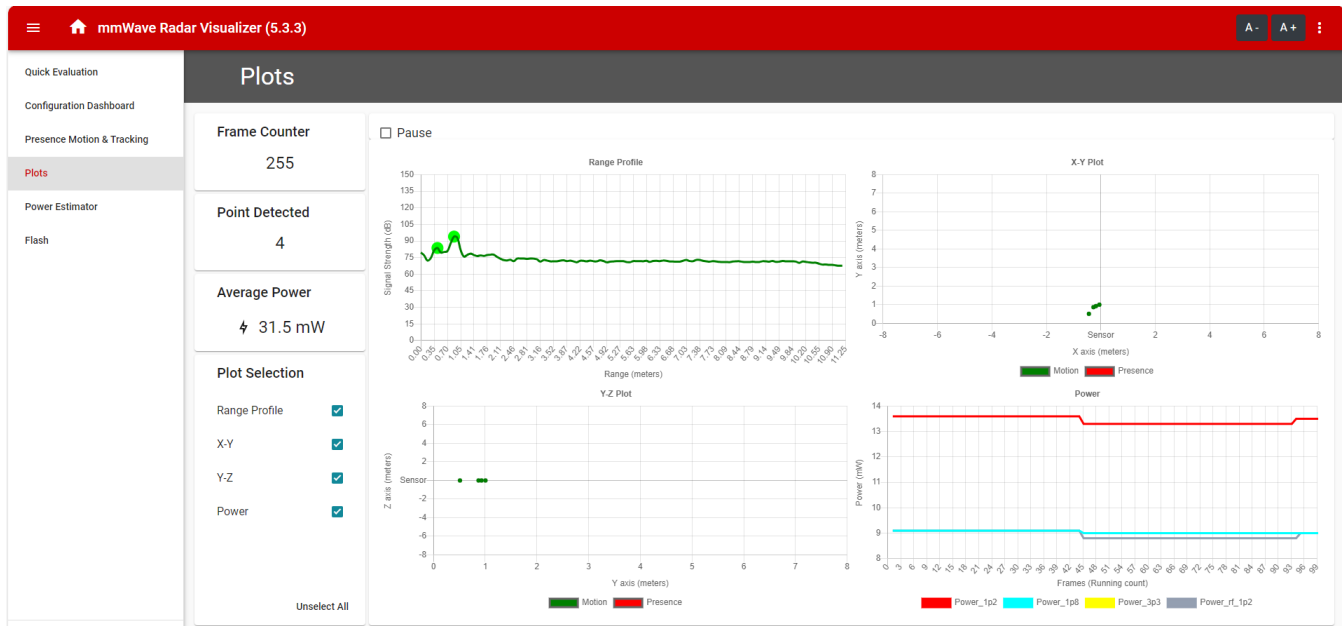

Figure 3-4. Plots Tab in Visualizer Tool

### 3.4 DCA1000EVM Mode

The setup for raw data capture using DCA1000EVM is shown in Figure 3-5.

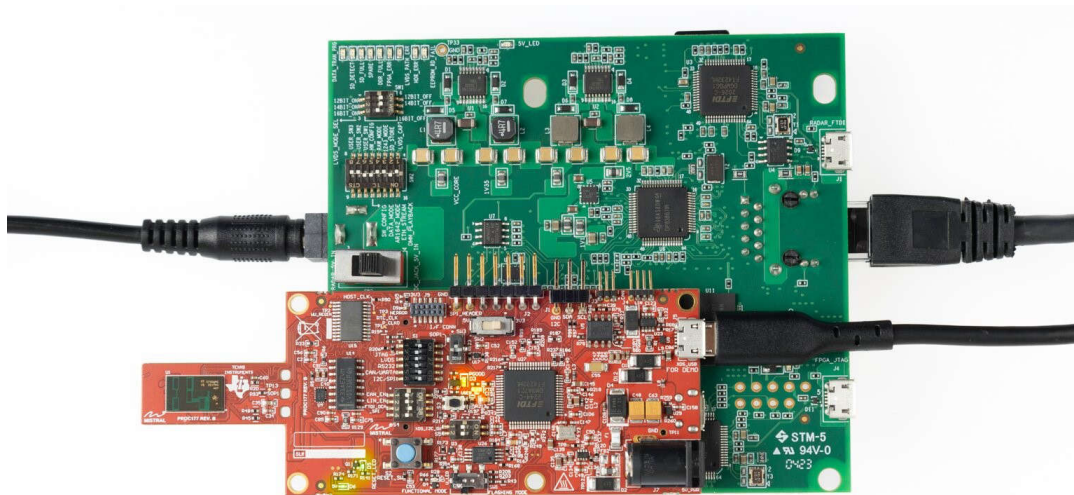
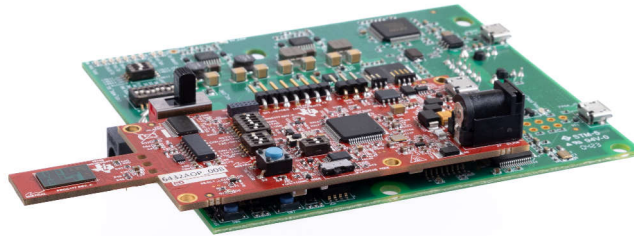

Figure 3-5. DCA1000EVM Mode (Top View)



**Figure 3-6. DCA1000EVM mode (Side View)**

Please refer to [Section 2.2.2](#) for the switch settings for the DCA1000 raw ADC capture card.

## 4 Hardware Design Files

### 4.1 Schematics

To view the schematics, assembly drawings, see [IWRL6432AOPEVM Schematic, Assembly Files, and BOM](#).

### 4.2 PCB Layouts

To view the design database and layout details, see [IWRL6432AOPEVM Database and Layout Files](#).

#### 4.2.1 PCB Storage and Handling Recommendations:

This EVM contains components that can potentially be damaged by electrostatic discharge. Always transport and store the EVM in the supplied ESD bag when not in use. Handle using an antistatic wristband and operate on an antistatic work surface. For more information on proper handling, refer to [SSYA010](#).

##### 4.2.1.1 PCB Storage and Handling Recommendations:

To avoid oxidation, the PCB must be stored in an ESD cover and kept at a controlled room temperature with low humidity conditions. All ESD precautions must be taken while using and handling the EVM.

##### 4.2.1.2 Higher Power Demanding Applications

Most of the EVM can be operated with a single USB cable. For higher power consumption applications where a single USB-port cannot supply power needed, use an external 5V/2A or higher power adapter.

## 4.3 Bill of Materials (BOM)

To view the Bill of Materials (BOM), see [IWRL6432AOPEVM Schematic, Assembly Files, and BOM](#).

## 5 Additional Information

### 5.1 Trademarks

ARM® and Cortex® are registered trademarks of Arm Limited.

Windows® is a registered trademark of Microsoft.

All trademarks are the property of their respective owners.

## 6 Related Documentation

1. [xWRL6432BOOST User's Guide](#)

2. [IWRL6432AOP Data sheet and Errata](#)

## 7 TI E2E Community

Search the forums at [e2e.ti.com](http://e2e.ti.com). If users cannot find the answer, then post the question to the community.

## 8 References

1. [DCA1000EVM Data Capture Card User's Guide](#)
2. [MMWAVE-L-SDK](#)

## 9 Revision History

NOTE: Page numbers for previous revisions may differ from page numbers in the current version.

### Changes from April 1, 2024 to December 31, 2024 (from Revision \* (April 2024) to Revision A (December 2024))

	<b>Page</b>
• Removed in-cabin/automotive applications and references.....	<b>1</b>
• Added note for keep out area.....	<b>4</b>

## IMPORTANT NOTICE AND DISCLAIMER

TI PROVIDES TECHNICAL AND RELIABILITY DATA (INCLUDING DATA SHEETS), DESIGN RESOURCES (INCLUDING REFERENCE DESIGNS), APPLICATION OR OTHER DESIGN ADVICE, WEB TOOLS, SAFETY INFORMATION, AND OTHER RESOURCES "AS IS" AND WITH ALL FAULTS, AND DISCLAIMS ALL WARRANTIES, EXPRESS AND IMPLIED, INCLUDING WITHOUT LIMITATION ANY IMPLIED WARRANTIES OF MERCHANTABILITY, FITNESS FOR A PARTICULAR PURPOSE OR NON-INFRINGEMENT OF THIRD PARTY INTELLECTUAL PROPERTY RIGHTS.

These resources are intended for skilled developers designing with TI products. You are solely responsible for (1) selecting the appropriate TI products for your application, (2) designing, validating and testing your application, and (3) ensuring your application meets applicable standards, and any other safety, security, regulatory or other requirements.

These resources are subject to change without notice. TI grants you permission to use these resources only for development of an application that uses the TI products described in the resource. Other reproduction and display of these resources is prohibited. No license is granted to any other TI intellectual property right or to any third party intellectual property right. TI disclaims responsibility for, and you will fully indemnify TI and its representatives against, any claims, damages, costs, losses, and liabilities arising out of your use of these resources.

TI's products are provided subject to [TI's Terms of Sale](#) or other applicable terms available either on [ti.com](https://www.ti.com) or provided in conjunction with such TI products. TI's provision of these resources does not expand or otherwise alter TI's applicable warranties or warranty disclaimers for TI products.

TI objects to and rejects any additional or different terms you may have proposed.

Mailing Address: Texas Instruments, Post Office Box 655303, Dallas, Texas 75265  
Copyright © 2024, Texas Instruments Incorporated